

天线规格书说明书

Product Specification

客户名称

Customer : 炬力北方

产品名称

Product Description: 5G WIFI 天线

料号

Part NO.: ANT-PCB-071

客户料号

Customer Part NO.: ANT-PCB-MATE

版本

Version: V1.0

日期

Date: 2022.12.20

	供应商确认 Manufacturer Signature	客户确认 Customer Signature
Approved by:	锐博泰科技	张工
Date:	2022.12	2022.12

目录 Contents

Item	Description	Page
1.版本 Revised History.....	3
2.规格表 Antenna Specification.....	4
3.成品图 Antenna Assembly.....	5
4.产品图 Product Photo.....	6
5.测试报告 Test Report.....	7-8

版本 Revised History

Date	Version	Revised Record

规格表 Antenna Specification

电气特性 Electrical Properties

功能	5G WIFI 天线
频率范围 (GHz)	5.1-5.85
电压驻波比 (VSWR)	≤ 2.5
增益(Peak) (dBi)	1.77dBi
输入阻抗(Ω)	50
极化方式	线性 垂直
天线形式	板载 PIFA

物理特性 Physical Properties

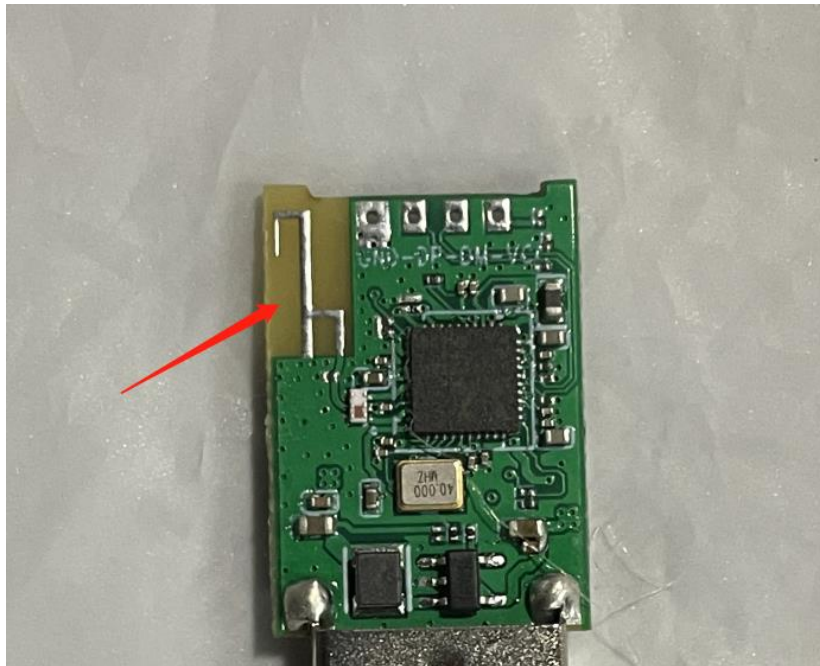
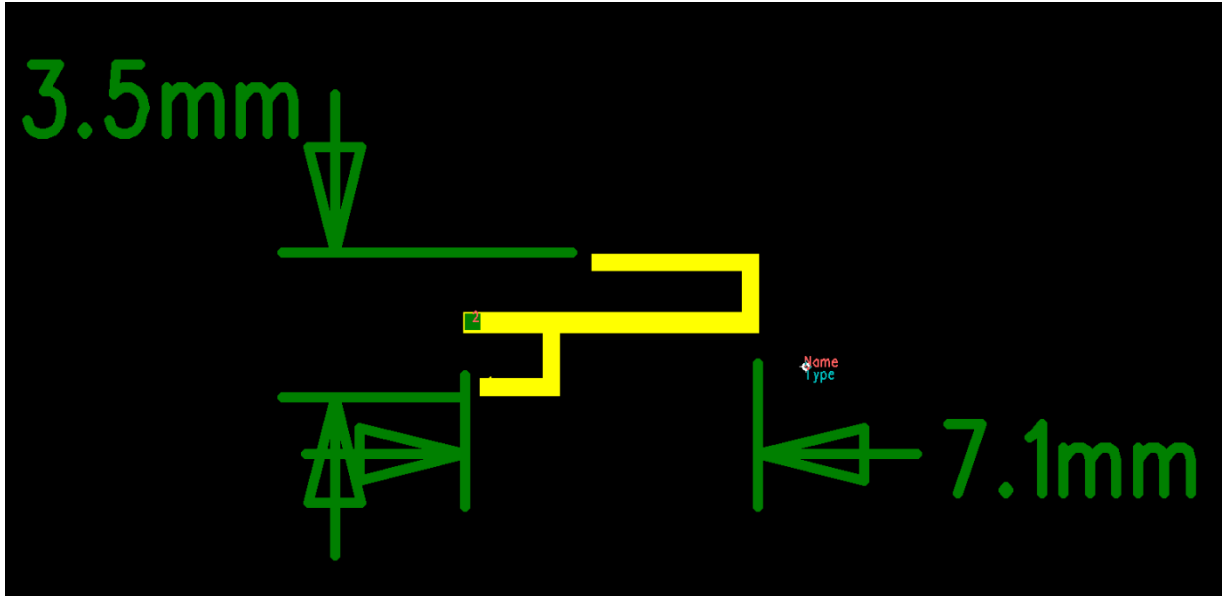

功能	5G WIFI 天线
天线外观尺寸	7.1X3.5mm
天线材质	PCB
天线颜色	
电缆类型	
连接器型号	
工作温度	-20°C-85°C
存储温度	-40°C-95°C

成品图 Antenna Assembly (5G)



测试报告 Test Report

测试设备

序号	设备名称	设备图片	测量指标	操作环境
1	Atenlab 3D 微波暗室		无源性能	周围无较大 金属物常 温常湿
2	Agilent E5071C 网络分 析仪			

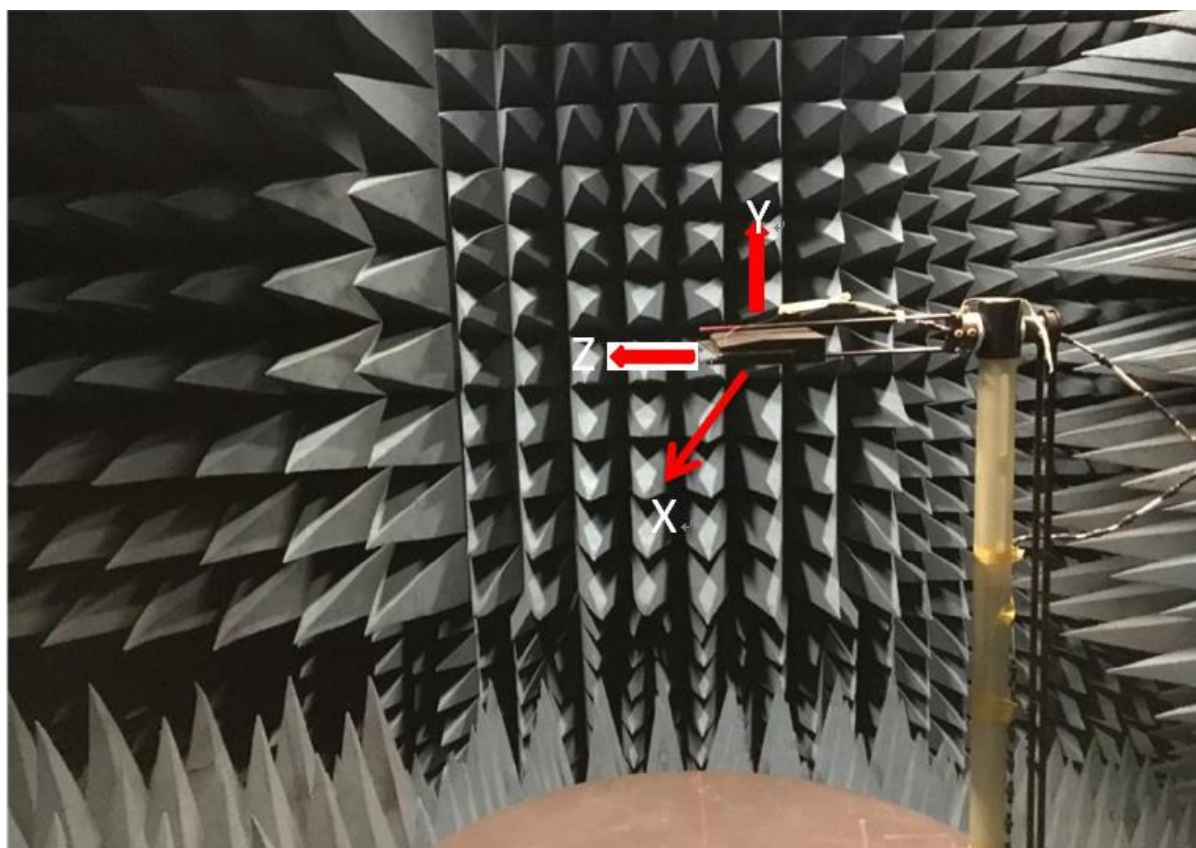

Return Loss/VSWR/Smith chart:

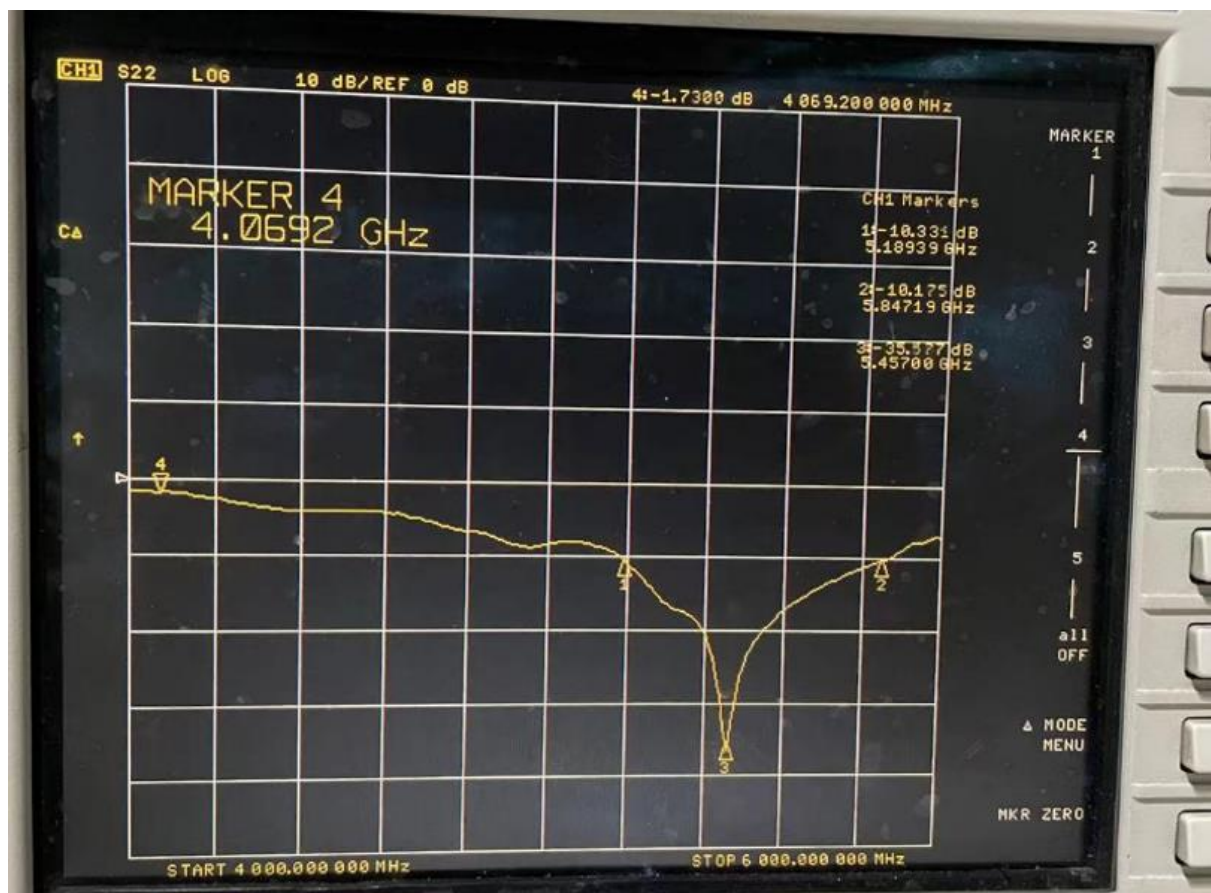

Frequency (GHz)	5.2G	5.85G
Loss	-10	-10
VSWR	1.87	1.87

Antenna gain/Efficiency (5G)

Frequency (GHz)	5.2	5.35	5.5	5.75	5.85
Efficiency (%)	66.2	63.2	64.1	65.9	62.3
Peak Gain (dBi)	1.64	1.72	1.73	1.68	1.77

方向图:

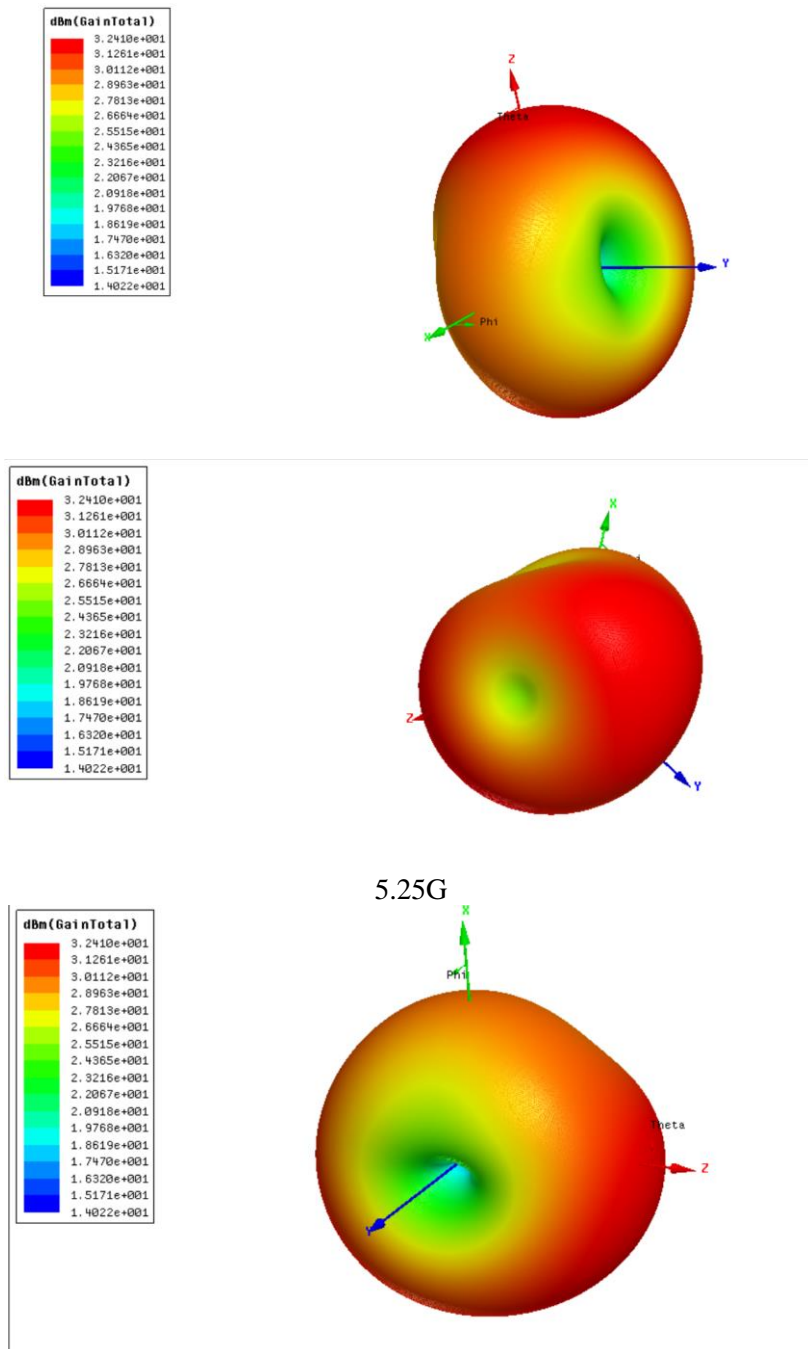

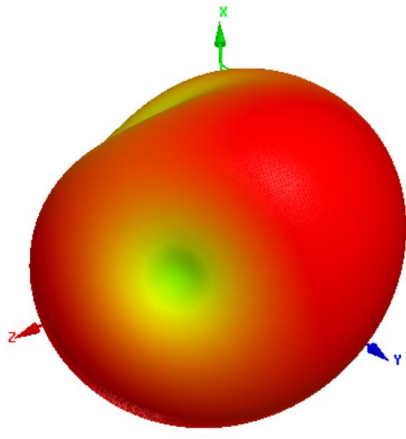
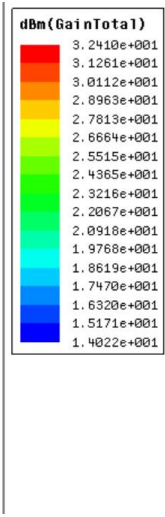

5.8G