

#### 4.5. Peak Power Spectral Density

##### **a. Limit**

1. For direct sequence systems, the peak power spectral density conducted from the intentional radiator to the antenna shall not be greater than 8dBm in any 3kHz band during any time interval of continuous transmission.
2. The direct sequence operating of the hybrid system, with the frequency hopping operation turned off, shall comply with the power density requirements of paragraph (d) of this section.

##### **b. Test Procedure**

1. Place the EUT on the table and set it in transmitting mode. Remove the antenna from the EUT and then connect a low loss RF cable from the antenna port to the spectrum analyzer.
2. Set the spectrum analyzer as RBW = 3kHz, VBW = 10kHz, Span = 1.5 times DTS BW, Sweep=500s
3. Record the max. reading.
4. Repeat the above procedure until the measurements for all frequencies are completed.

##### **c. Test Equipment**

Same as the equipment listed in 4.2.

##### **d. Test Setup**

See 4.1

##### **e. Test Results**

Pass

##### **f. Test Data**

Please refer to the following data.

##### **g. Test Plot** See the following pages

ANT A

Test mode: IEEE 802.11b

Channel	Frequency (MHz)	PPSD (dBm/3KHz)	ΣPPSD (dBm/3KHz)	Limit (dBm)	Result
Low	2412	-19.010	-	8.00	Pass
Mid	2437	-19.046	-		Pass
High	2462	-19.760	-		Pass

Test mode: IEEE 802.11g

Channel	Frequency (MHz)	PPSD (dBm)	ΣPPSD (dBm)	Limit (dBm)	Result
Low	2412	-20.522	-	8.00	Pass
Mid	2437	-21.050	-		Pass
High	2462	-23.410	-		Pass

Test mode: IEEE 802.11n (HT20)

Channel	Frequency (MHz)	PPSD (dBm/3KHz)	ΣPPSD (dBm/3KHz)	Limit (dBm)	Result
Low	2412	-20.402	-	8.00	Pass
Mid	2437	-19.430	-		Pass
High	2462	-22.023	-		Pass

Test mode: IEEE 802.11n (HT40)

Channel	Frequency (MHz)	PPSD (dBm/3KHz)	ΣPPSD (dBm/3KHz)	Limit (dBm)	Result
Low	2422	-22.734	-	8.00	Pass
Mid	2437	-22.988	-		Pass
High	2452	-24.226	-		Pass

ANT B

Test mode: IEEE 802.11b

Channel	Frequency (MHz)	PPSD (dBm/3KHz)	ΣPPSD (dBm/3KHz)	Limit (dBm)	Result
Low	2412	-18.332	-	8.00	Pass
Mid	2437	-18.050	-		Pass
High	2462	-17.747	-		Pass

Test mode: IEEE 802.11g

Channel	Frequency (MHz)	PPSD (dBm)	ΣPPSD (dBm)	Limit (dBm)	Result
Low	2412	-19.816	-	8.00	Pass
Mid	2437	-18.410	-		Pass
High	2462	-20.023	-		Pass

Test mode: IEEE 802.11n (HT20)

Channel	Frequency (MHz)	PPSD (dBm/3KHz)	ΣPPSD (dBm/3KHz)	Limit (dBm)	Result
Low	2412	-19.133	-	8.00	Pass
Mid	2437	-17.727	-		Pass
High	2462	-19.785	-		Pass

Test mode: IEEE 802.11n (HT40)

Channel	Frequency (MHz)	PPSD (dBm/3KHz)	ΣPPSD (dBm/3KHz)	Limit (dBm)	Result
Low	2422	-19.527	-	8.00	Pass
Mid	2437	-21.241	-		Pass
High	2452	-21.380	-		Pass

Channel	Channel Frequency (MHz)	ANT A PSD (dBm)	ANT B PSD (dBm)	Data Rate (Mbps)	MIMO PSD (dBm)	Limit (dBm)
<b>802.11n (20M MIMO) mode</b>						
Low	2412	-20.402	-19.133	MCS0	-16.71	8
Middle	2437	-19.430	-17.727	MCS0	-15.49	8
High	2462	-22.023	-19.785	MCS0	-17.75	8
<b>802.11n (40M MIMO) mode</b>						
Low	2422	-22.734	-19.527	MCS0	-17.83	8
Middle	2437	-22.988	-21.241	MCS0	-19.02	8
High	2452	-24.226	-21.380	MCS0	-19.56	8

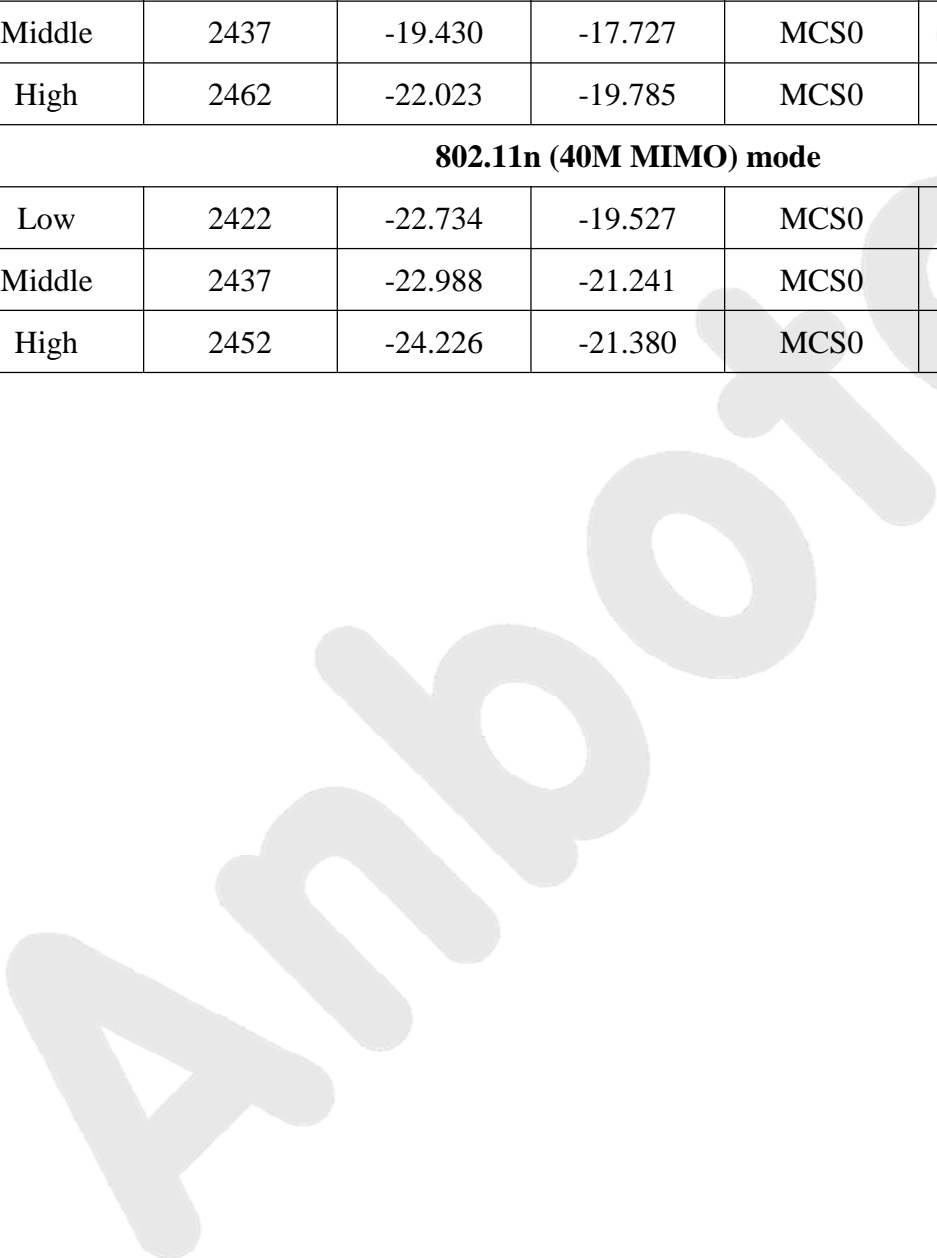

ANT A

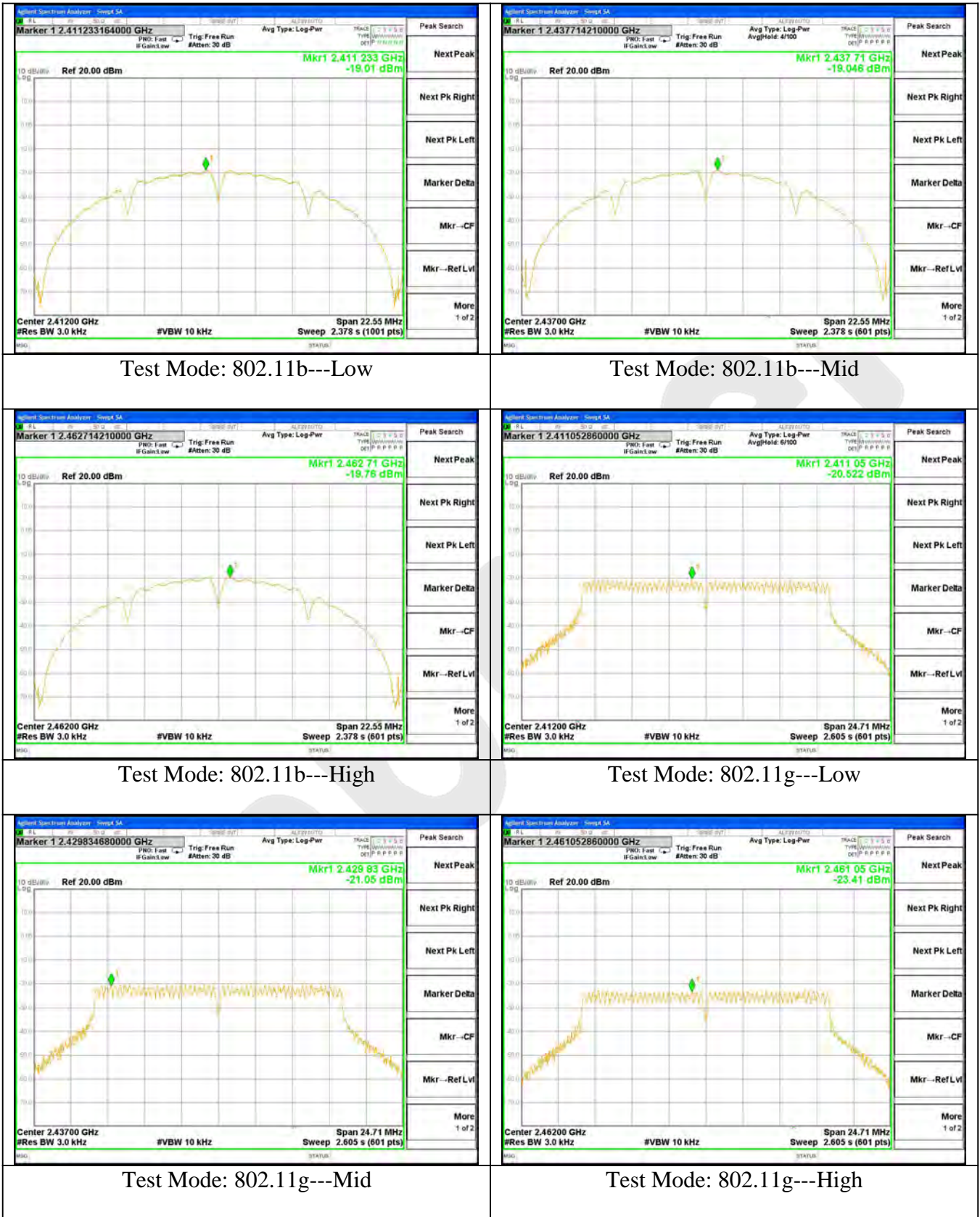

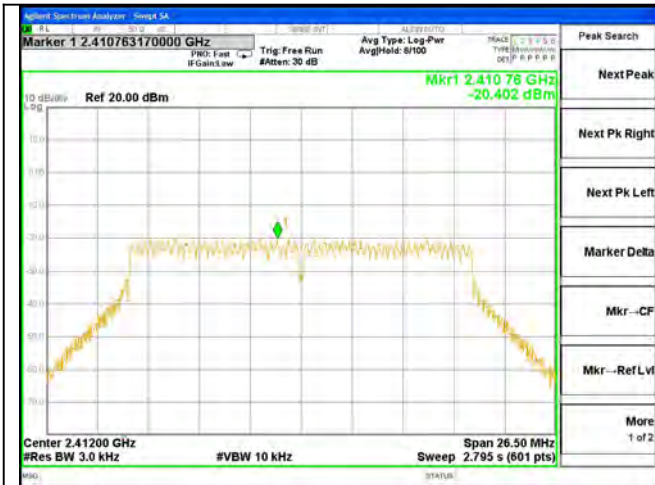

Test Mode: 802.11n20---Low

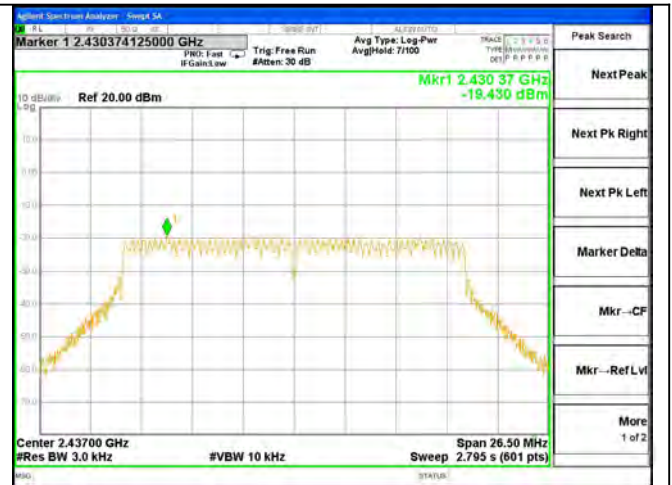

Test Mode: 802.11n20---Mid

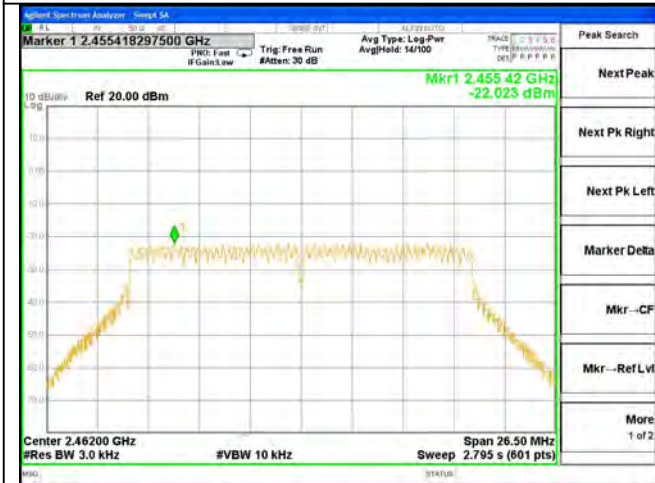

Test Mode: 802.11n20---High

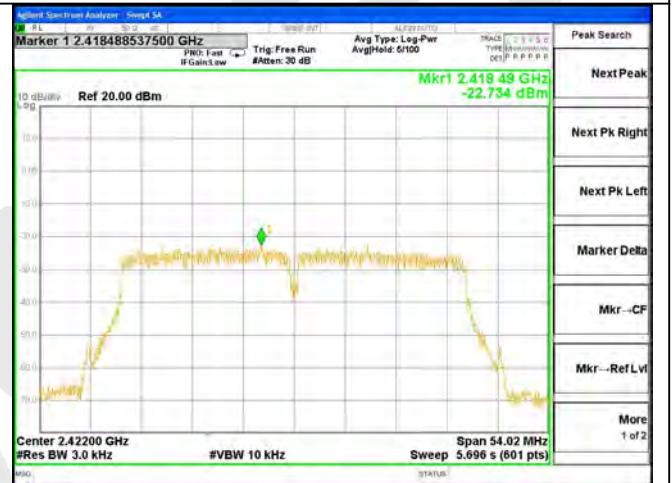

Test Mode: 802.11n40---Low

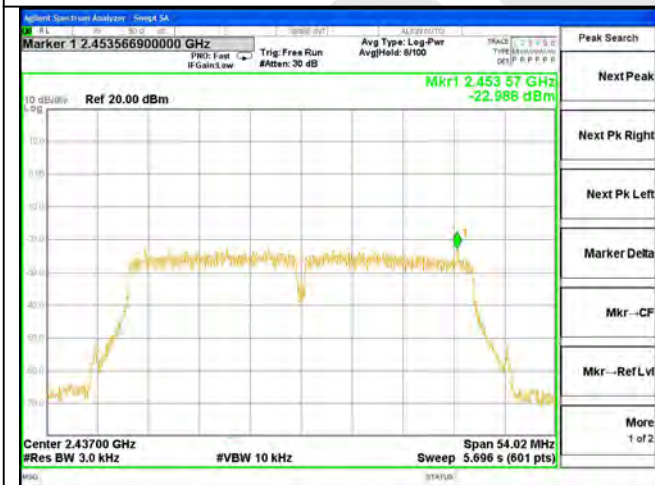

Test Mode: 802.11n40---Mid

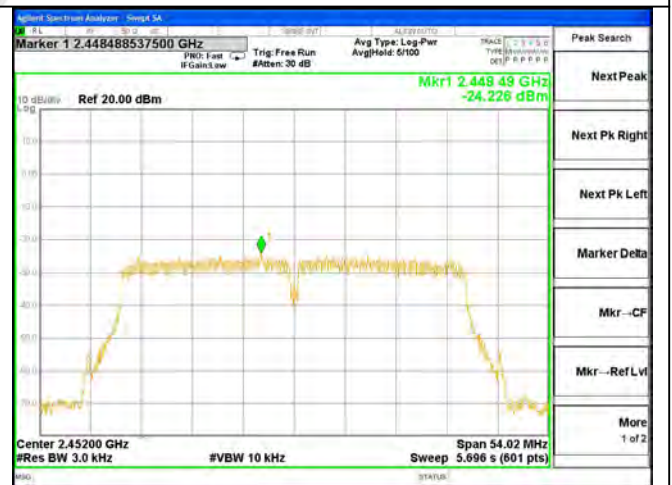

Test Mode: 802.11n40---High

ANT B

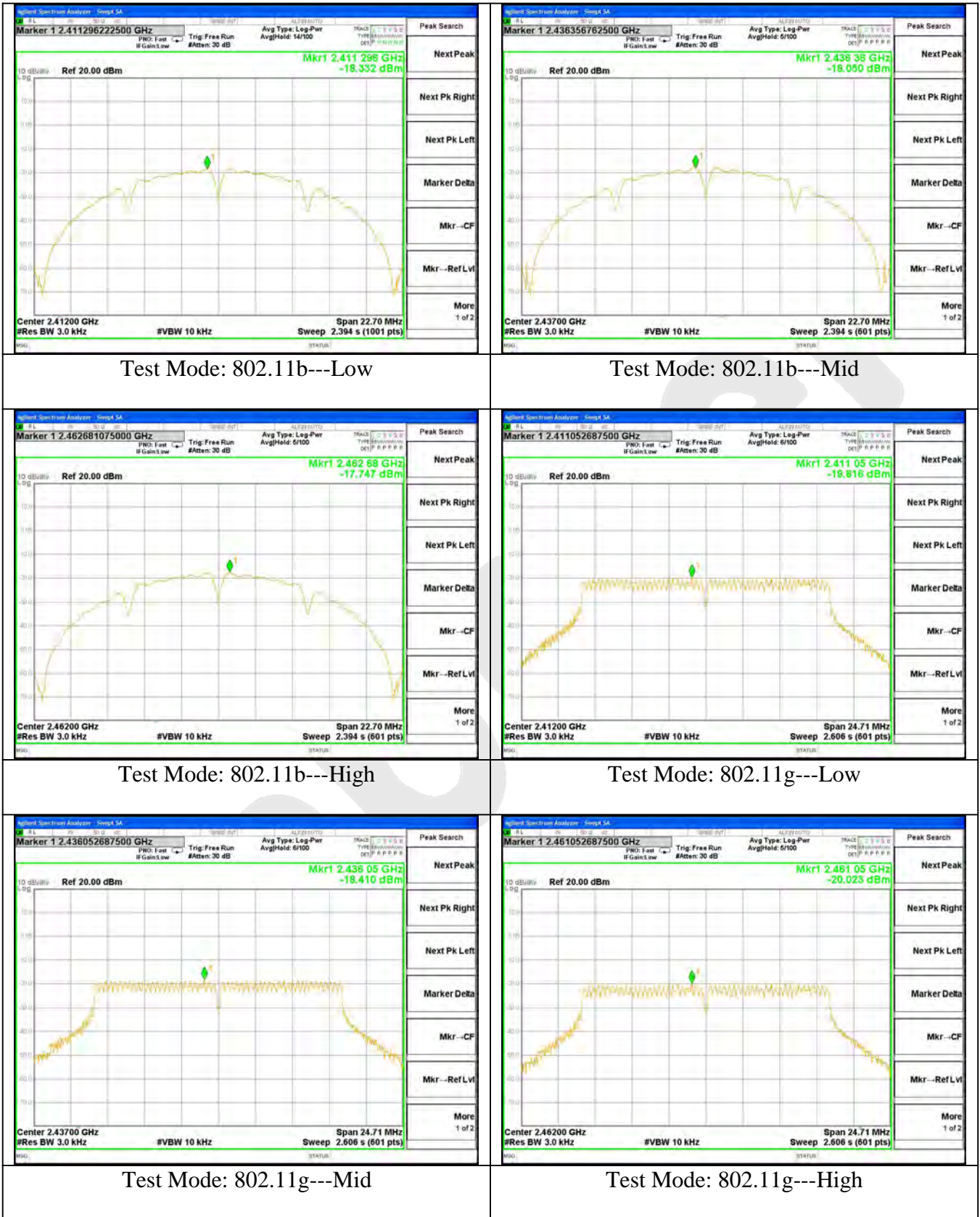



Test Mode: 802.11n20---Low



Test Mode: 802.11n20---Mid



Test Mode: 802.11n20---High

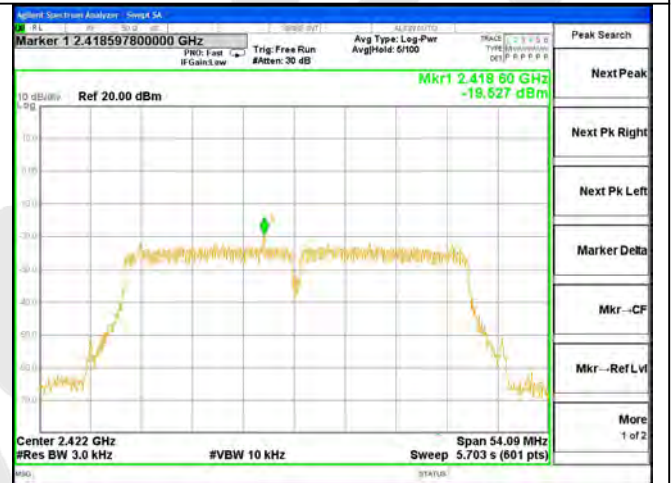

Test Mode: 802.11n40---Low

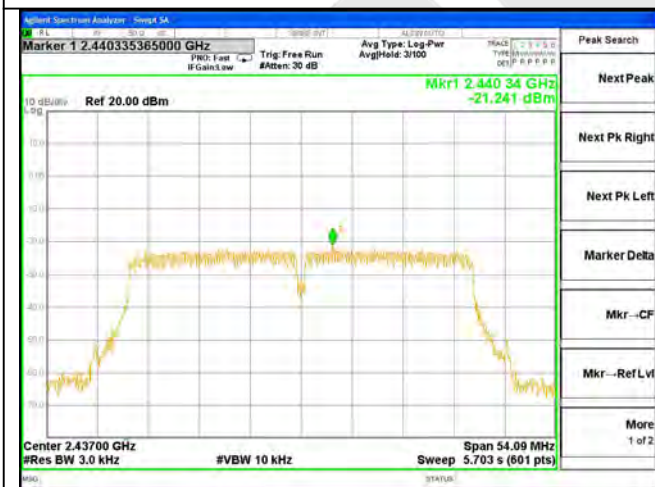

Test Mode: 802.11n40---Mid

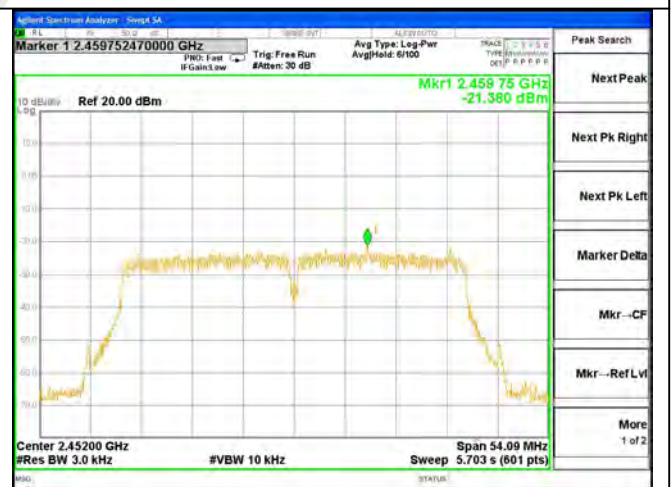

Test Mode: 802.11n40---High



#### 4.6. Radiated Emissions

##### 4.6.1.1. Test Limits (< 30 MHZ)

Frequency (MHz)	Field Strength (microvolts/meter)	Measurement Distance (meter)
0.009-0.490	2400/F(kHz)	300
0.490-1.705	24000/F(kHz)	30
1.705-30.0	30	30

##### 4.6.1.2. Test Limits ( $\geq$ 30 MHZ)

FIELD STRENGTH of Fundamental: @3M	FIELD STRENGTH of Harmonics	S15.209	
902-928 MHZ		30 - 88 MHz	40 dBuV/m
2.4-2.4835 GHz		88 - 216 MHz	43.5
94 dB $\mu$ V/m @3m	54 dB $\mu$ V/m @3m	216 - 960 MHz	46
		ABOVE 960 MHz	54dBuV/m

In any 100 kHz bandwidth outside the frequency band in which the spread spectrum or digitally modulated intentional radiator is operating, the radio frequency power that is produced by the intentional radiator shall be at least 20 dB below that in the 100 kHz bandwidth within the band that contains the highest level of the desired power, based on either an RF conducted or a radiated measurement. Attenuation below the general limits specified in Section 15.209(a) is not required. In addition, radiated emissions which fall in the restricted bands, as defined in Section 15.205(a), must also comply with the radiated emission limits specified in Section 15.209(a) (see Section 15.205(c)).

#### Test Equipment

Item	Equipment	Manufacturer	Model No.	Serial No.	Last Cal.	Cal. Interval
1.	Spectrum Analysis	Agilent	E4407B	US39390582	Apr. 17, 2015	1 Year
2.	Preamplifier	Instruments corporation	EMC011830	980100	Apr. 17, 2015	1 Year
3.	EMI Test Receiver	Rohde & Schwarz	ESPI	101604	Apr. 17, 2015	1 Year
4.	Double Ridged Horn Antenna	Instruments corporation	GTH-0118	351600	Apr. 20, 2015	1 Year
5.	Bilog Broadband Antenna	Schwarzbeck	VULB9163	VULB 9163-289	Apr. 20, 2015	1 Year
6.	Pre-amplifier	SONOMA	310N	186860	Apr. 17, 2015	1 Year
7.	EMI Test Software EZ-EMC	SHURPLE	N/A	N/A	N/A	N/A

4.6.2. Test Configuration:

4.6.2.1. 9k to 30MHz emissions:

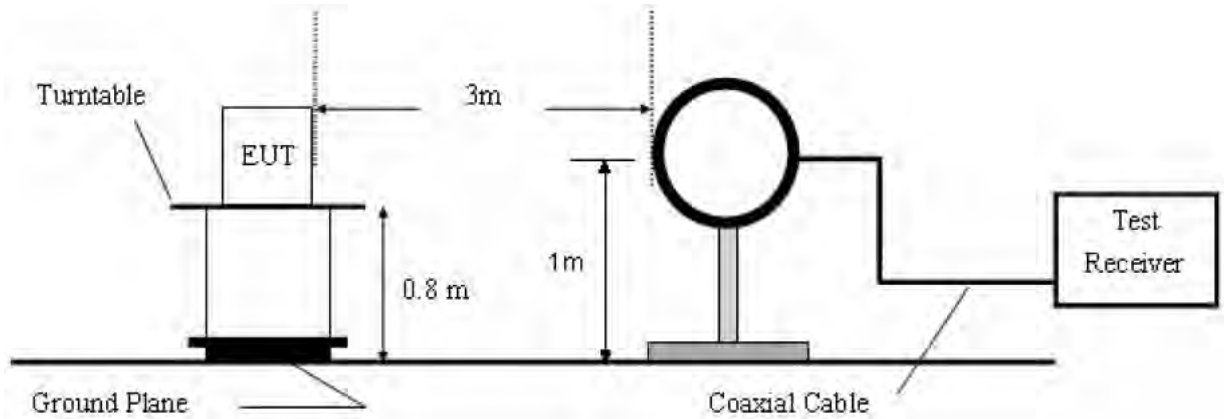

4.6.2.2. 30M to 1G emissions:

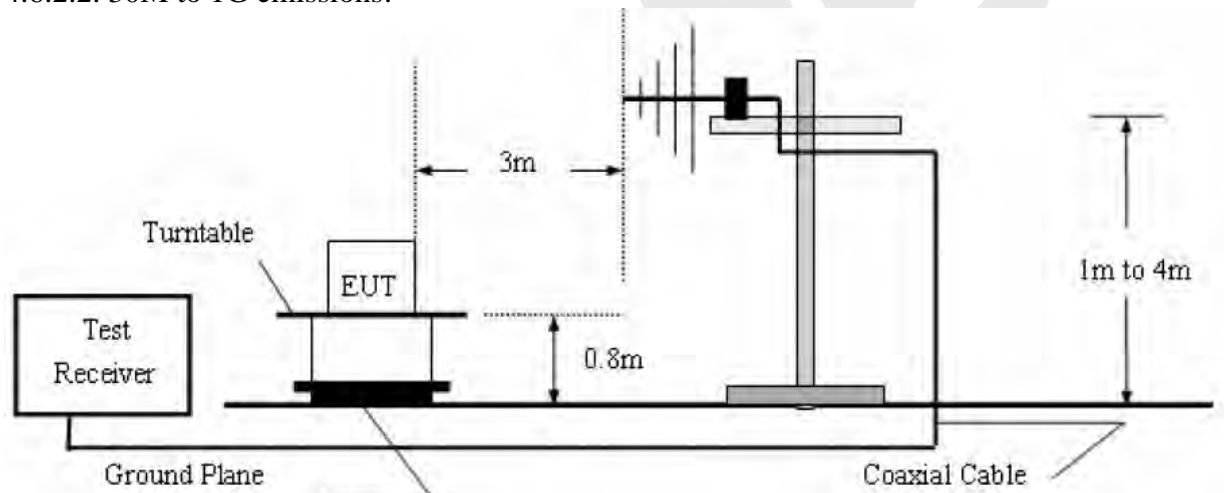

4.6.2.3. 1G to 40G emissions:

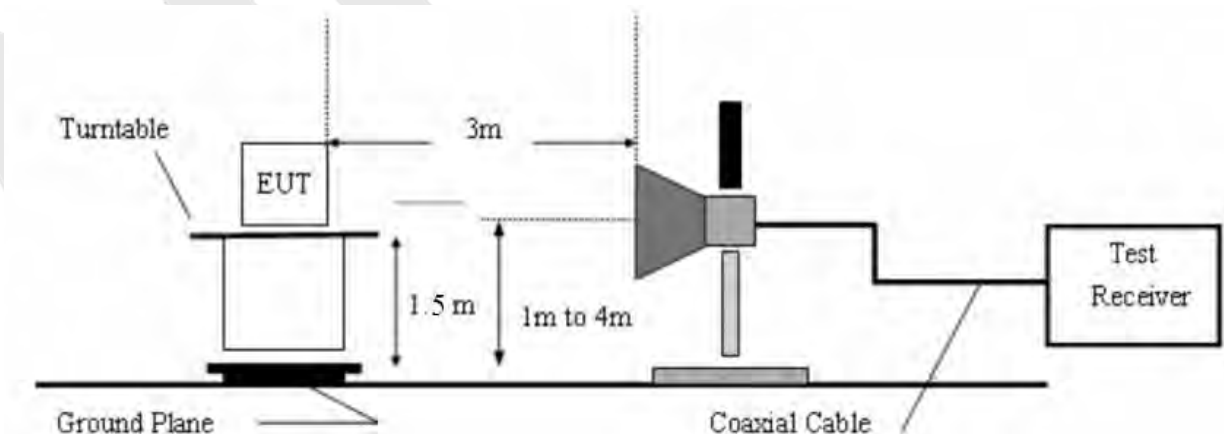

#### 4.6.3. Test Procedure

For below 1GHz: The EUT is placed on a turntable, which is 0.8m above the ground plane.  
For above 1GHz: The EUT is placed on a turntable, which is 1.5m above the ground plane.  
The turn table can rotate 360 degrees to determine the position of the maximum emission level.  
The EUT is set 3 meters away from the receiving antenna which is mounted on a antenna tower.  
The antenna can be moved up and down from 1 to 4 meters to find out the maximum emission level. Both horizontal and vertical polarization of the antenna are set on test.

Measurements are made on 9KHz to 30MHz and 30MHz to 26GHz range with the transmitter set to the lowest, middle, and highest channels.

All readings from 30MHz to 1GHz are quasi-peak values with a resolution bandwidth of 120kHz. All reading are above 1GHz, peak & average values with a resolution bandwidth of 1MHz.

The EUT is tested in 9\*6\*6 Chamber. The device is evaluated in xyz orientation.

The test results are listed in Section 4.6.4.

#### 4.6.4. Test Results

The EUT was tested on (Ethernet Playing, On) modes, only the worst data of (On) is attached in the following pages.

Job No.:	011507060I	Polarization:	Horizontal
Standard:	(RE)FCC PART15 C _3m	Power Source:	AC 120V, 60Hz for adapter
Test item:	Radiation Test	Temp.(C)/Hum.(%RH):	24.3(C)/55%RH
Test Mode:	ON	Distance:	3m

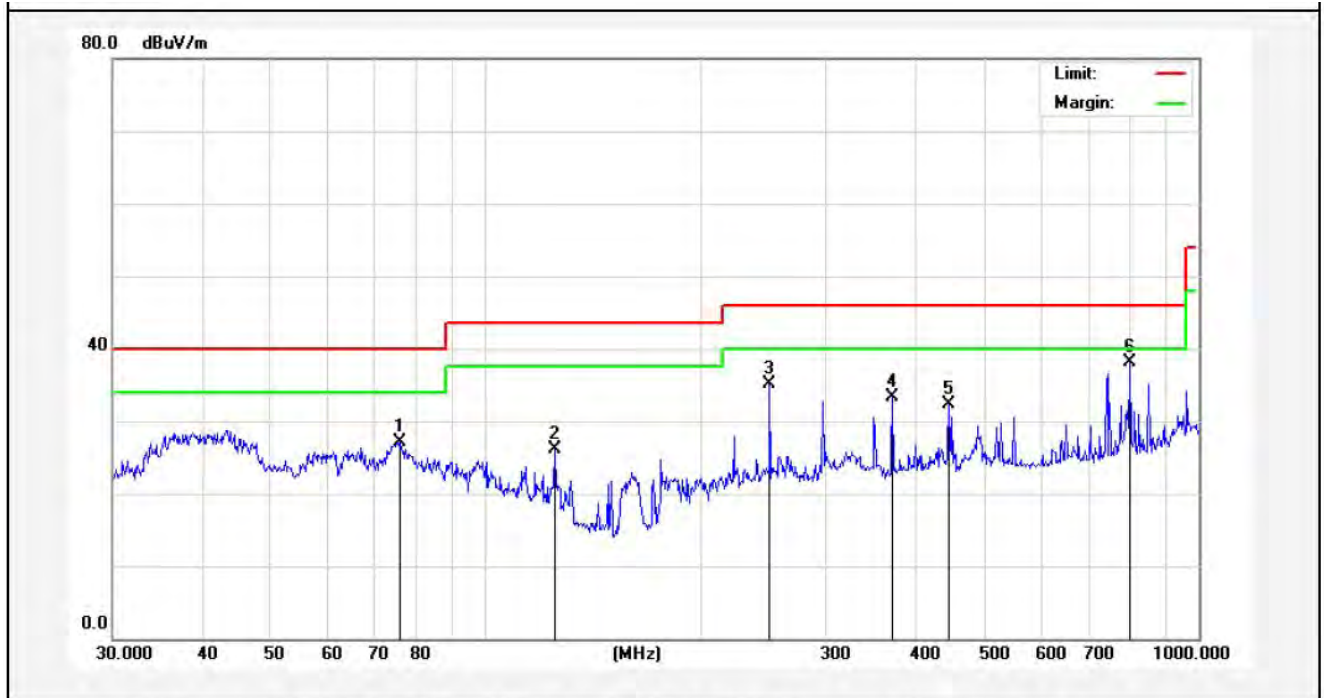

No.	Freq. (MHz)	Reading (dBuV/m)	Factor (dB/m)	Result (dBuV/m)	Limit (dBuV/)	Over Limit (dB)	Detector	Height (cm)	degree (deg)	Remark
1	75.9772	47.94	-20.87	27.07	40.00	-12.93	peak			
2	125.0066	48.21	-22.08	26.13	43.50	-17.37	peak			
3	250.3011	53.57	-18.56	35.01	46.00	-10.99	peak			
4	372.0045	46.76	-13.43	33.33	46.00	-12.67	peak			
5	446.4141	44.57	-12.17	32.40	46.00	-13.60	peak			
6	801.7862	44.72	-6.54	38.18	46.00	-7.82	peak			

Job No.:	011507060I	Polarization:	Vertical
Standard:	(RE)FCC PART15 C_3m	Power Source:	AC 120V, 60Hz for adapter
Test item:	Radiation Test	Temp.(C)/Hum.(%RH):	24.3(C)/55%RH
Test Mode:	ON	Distance:	3m

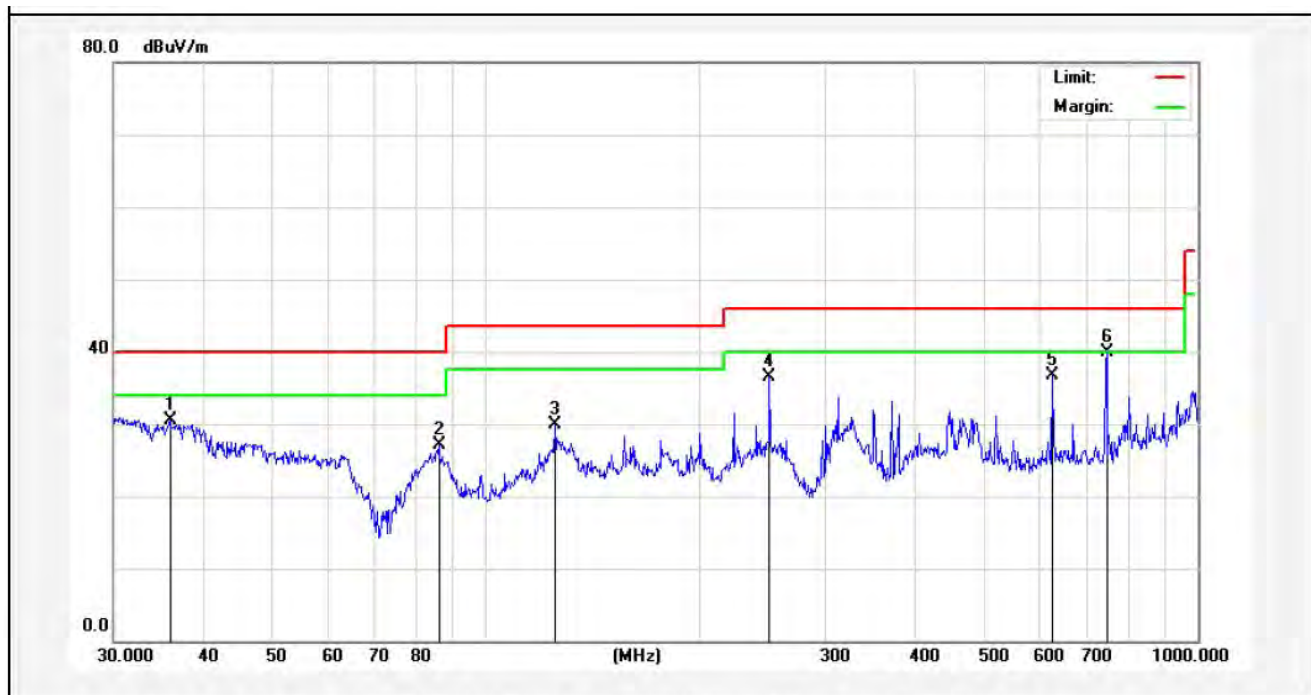

No.	Freq. (MHz)	Reading (dBuV/m)	Factor (dB/m)	Result (dBuV/m)	Limit (dBuV/)	Over Limit (dB)	Detector	Height (cm)	degree (deg)	Remark
1	36.0007	44.01	-13.50	30.51	40.00	-9.49	peak			
2	85.8983	45.28	-18.25	27.03	40.00	-12.97	peak			
3	125.0066	46.99	-17.08	29.91	43.50	-13.59	peak			
4	250.3011	50.49	-14.04	36.45	46.00	-9.55	peak			
5	625.0778	45.82	-9.05	36.77	46.00	-9.23	peak			
6	744.8659	47.09	-7.15	39.94	46.00	-6.06	peak			

Job No.:	011507060I	Polarization:	Horizontal
Standard:	(RE)FCC PART15 C _3m	Power Source:	AC 120V, 60Hz for adapter
Test item:	Radiation Test	Temp.(C)/Hum.(%RH):	24.3(C)/55%RH
Note:	ANT A 802.11b(2412MHz)	Distance:	3m

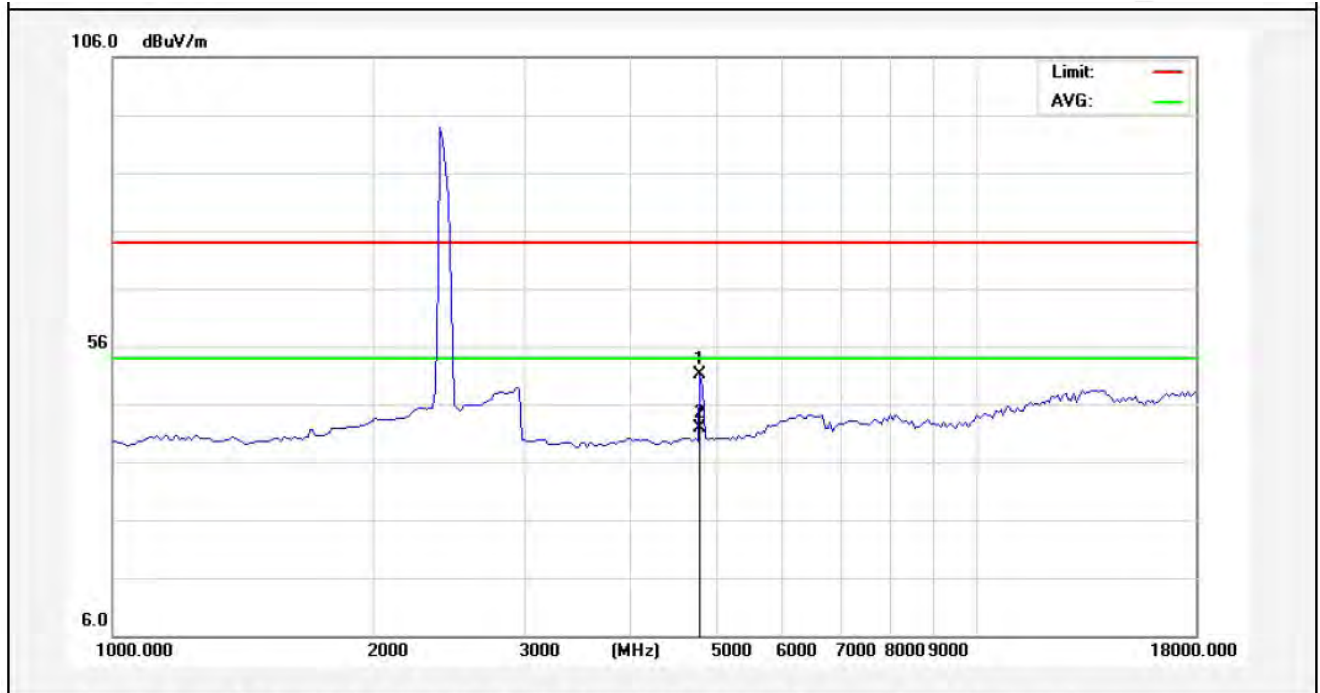

No.	Freq. (MHz)	Reading (dBuV/m)	Factor (dB/m)	Result (dBuV/m)	Limit (dBuV/)	Over Limit (dB)	Detector	Height (cm)	degree (deg)	Remark
1	4825.000	47.67	3.34	51.01	74.00	-22.99	peak			
2	4825.000	38.56	3.34	41.90	54.00	-12.10	AVG			

AM

Job No.:	011507060I	Polarization:	Vertical
Standard:	(RE)FCC PART15 C _3m	Power Source:	AC 120V, 60Hz for adapter
Test item:	Radiation Test	Temp.(C)/Hum.(%RH):	24.3(C)/55%RH
Note:	ANT A 802.11b(2412MHz)	Distance:	3m

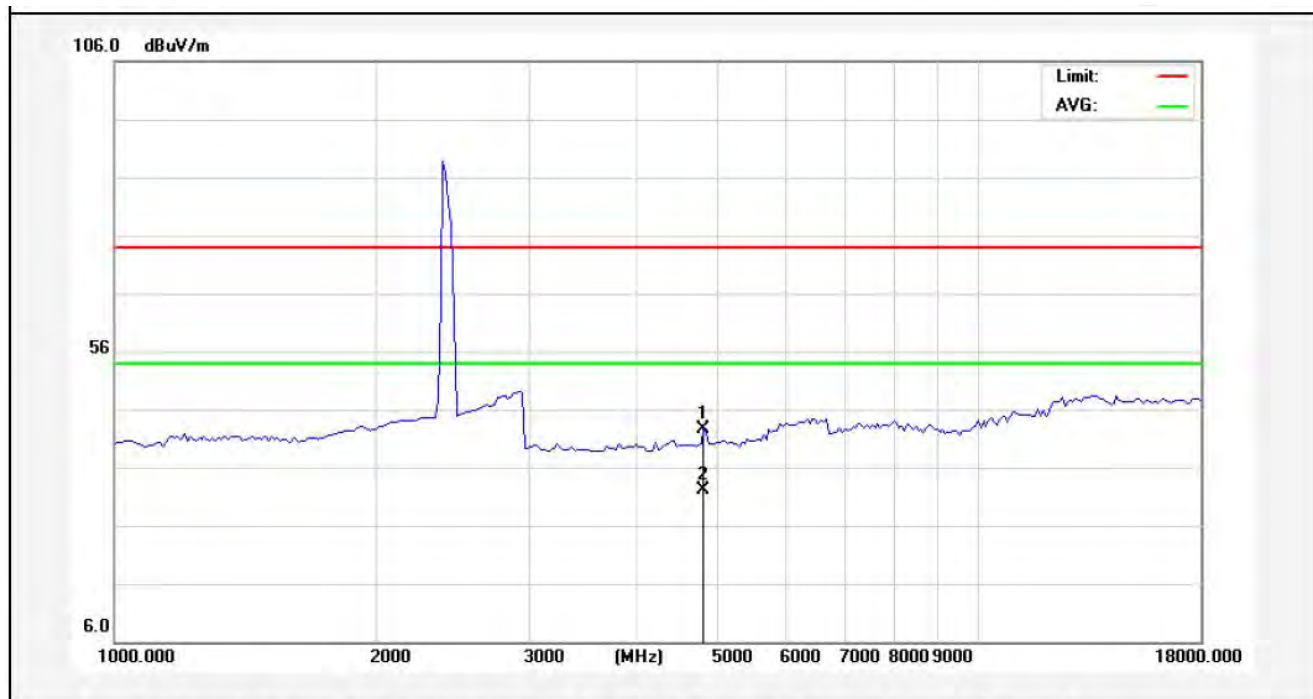

No.	Freq. (MHz)	Reading (dBuV/m)	Factor (dB/m)	Result (dBuV/m)	Limit (dBuV/)	Over Limit (dB)	Detector	Height (cm)	degree (deg)	Remark
1	4825.000	39.33	3.34	42.67	74.00	-31.33	peak			
2	4825.000	28.86	3.34	32.20	54.00	-21.80	AVG			

AM

Job No.:	011507060I	Polarization:	Horizontal
Standard:	(RE)FCC PART15 C _3m	Power Source:	AC 120V, 60Hz for adapter
Test item:	Radiation Test	Temp.(C)/Hum.(%RH):	24.3(C)/55%RH
Note:	ANT A 802.11b(2437MHz)	Distance:	3m

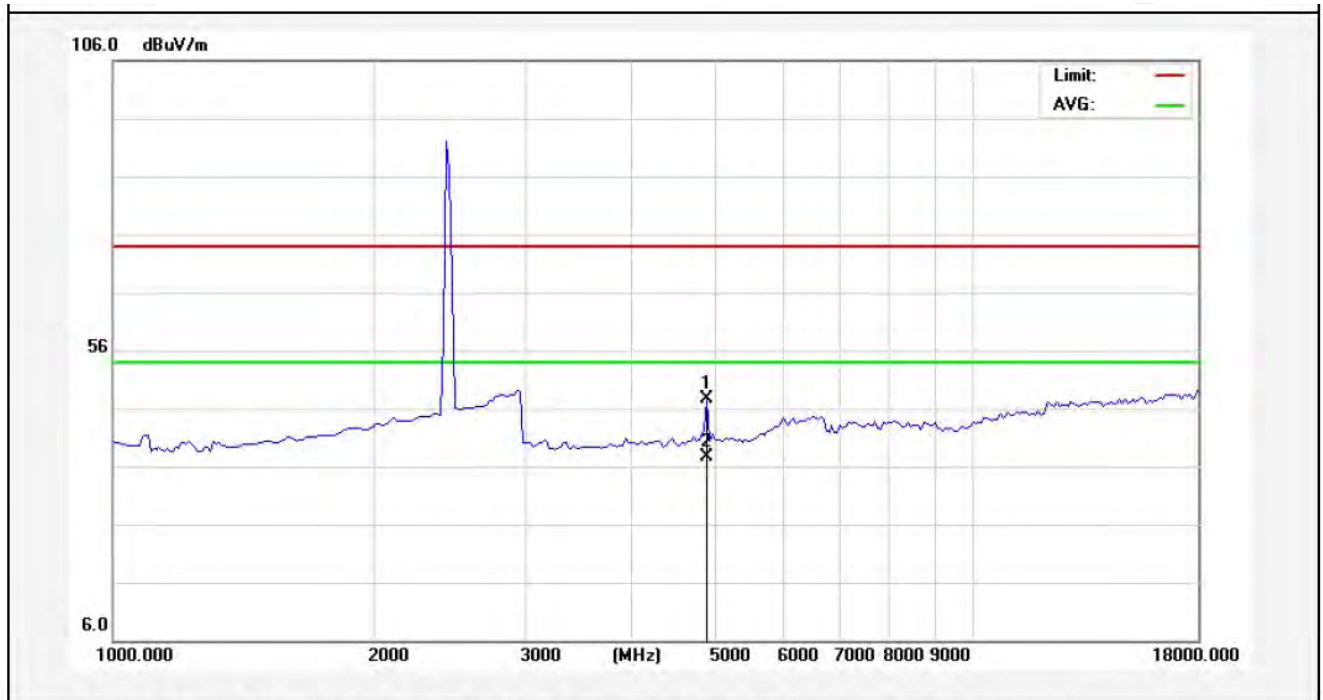

No.	Freq. (MHz)	Reading (dBuV/m)	Factor (dB/m)	Result (dBuV/m)	Limit (dBuV/)	Over Limit (dB)	Detector	Height (cm)	degree (deg)	Remark
1	4867.500	44.20	3.41	47.61	74.00	-26.39	peak			
2	4867.500	34.11	3.41	37.52	54.00	-16.48	AVG			

AM



<b>Job No.:</b>	<b>011507060I</b>	<b>Polarization:</b>	<b>Vertical</b>
<b>Standard:</b>	<b>(RE)FCC PART15 C _3m</b>	<b>Power Source:</b>	<b>AC 120V, 60Hz for adapter</b>
<b>Test item:</b>	<b>Radiation Test</b>	<b>Temp.(C)/Hum.(%RH):</b>	<b>24.3(C)/55%RH</b>
<b>Note:</b>	<b>ANT A 802.11b(2437MHz)</b>	<b>Distance:</b>	<b>3m</b>

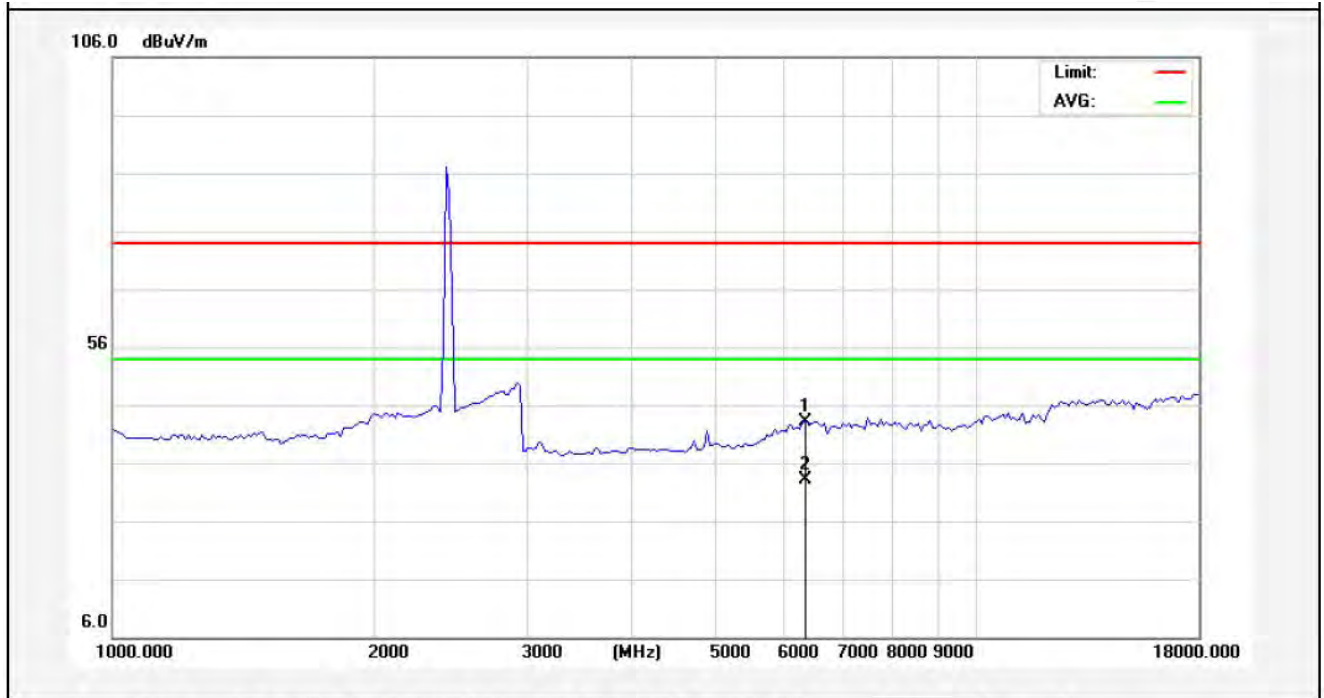

No.	Freq. (MHz)	Reading (dBuV/m)	Factor (dB/m)	Result (dBuV/m)	Limit (dBuV/)	Over Limit (dB)	Detector	Height (cm)	degree (deg)	Remark
1	6355.000	35.71	7.46	43.17	74.00	-30.83	peak			
2	6355.000	25.68	7.46	33.14	54.00	-20.86	AVG			



Job No.:	011507060I	Polarization:	Horizontal
Standard:	(RE)FCC PART15 C_3m	Power Source:	AC 120V, 60Hz for adapter
Test item:	Radiation Test	Temp.(C)/Hum.(%RH):	24.3(C)/55%RH
Note:	ANT A 802.11b(2462MHz)	Distance:	3m

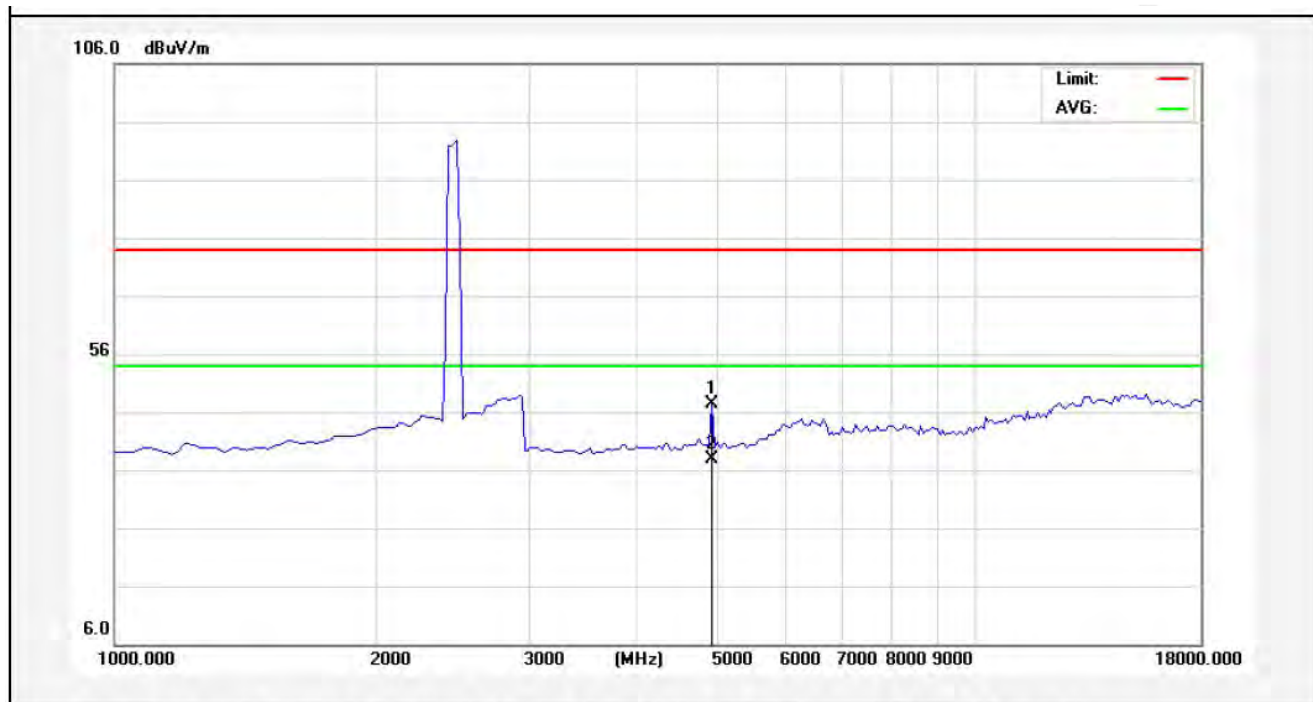

No.	Freq. (MHz)	Reading (dBuV/m)	Factor (dB/m)	Result (dBuV/m)	Limit (dBuV/)	Over Limit (dB)	Detector	Height (cm)	degree (deg)	Remark
1	4910.000	43.78	3.49	47.27	74.00	-26.73	peak			
2	4910.000	34.35	3.49	37.84	54.00	-16.16	AVG			



Job No.:	011507060I	Polarization:	Vertical
Standard:	(RE)FCC PART15 C _3m	Power Source:	AC 120V, 60Hz for adapter
Test item:	Radiation Test	Temp.(C)/Hum.(%RH):	24.3(C)/55%RH
Note:	ANT A 802.11b(2462MHz)	Distance:	3m

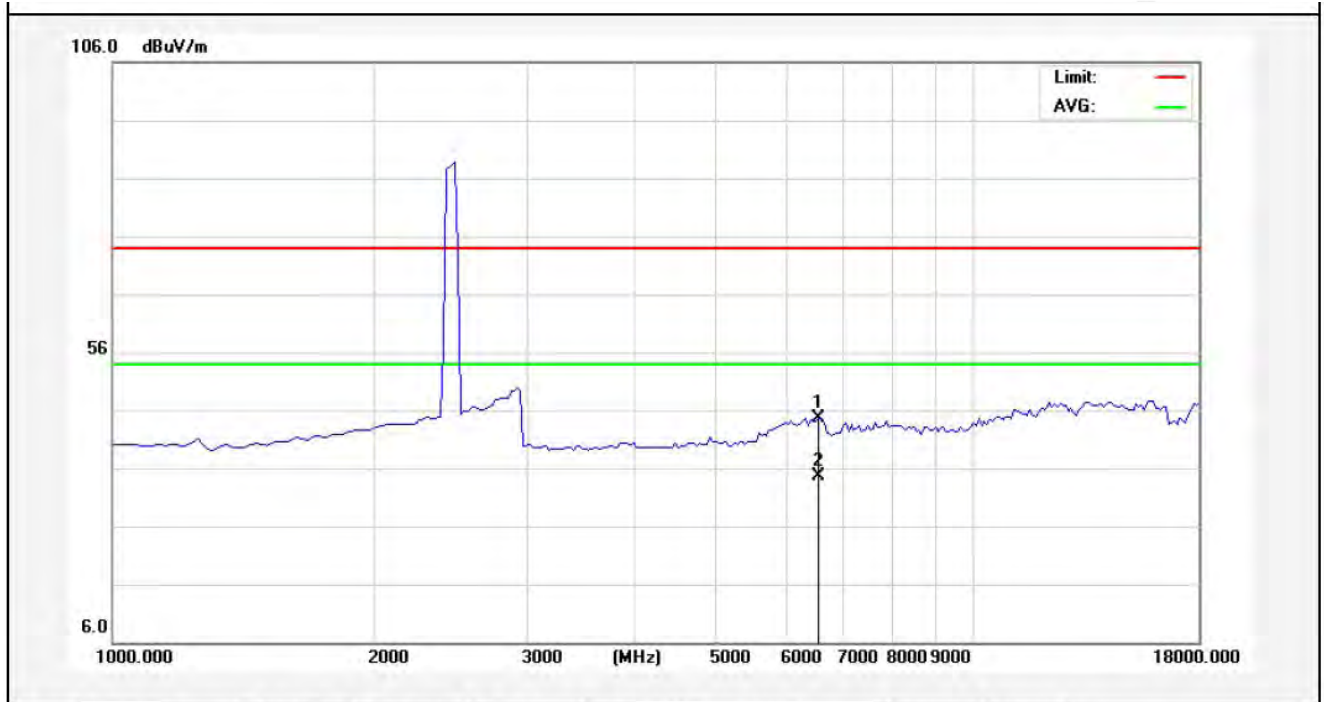

No.	Freq. (MHz)	Reading (dBuV/m)	Factor (dB/m)	Result (dBuV/m)	Limit (dBuV/)	Over Limit (dB)	Detector	Height (cm)	degree (deg)	Remark
1	6567.500	36.99	7.68	44.67	74.00	-29.33	peak			
2	6567.500	27.06	7.68	34.74	54.00	-19.26	AVG			

AM

Job No.:	011507060I	Polarization:	Horizontal
Standard:	(RE)FCC PART15 C _3m	Power Source:	AC 120V, 60Hz for adapter
Test item:	Radiation Test	Temp.(C)/Hum.(%RH):	24.3(C)/55%RH
Note:	ANT B 802.11b(2412MHz)	Distance:	3m

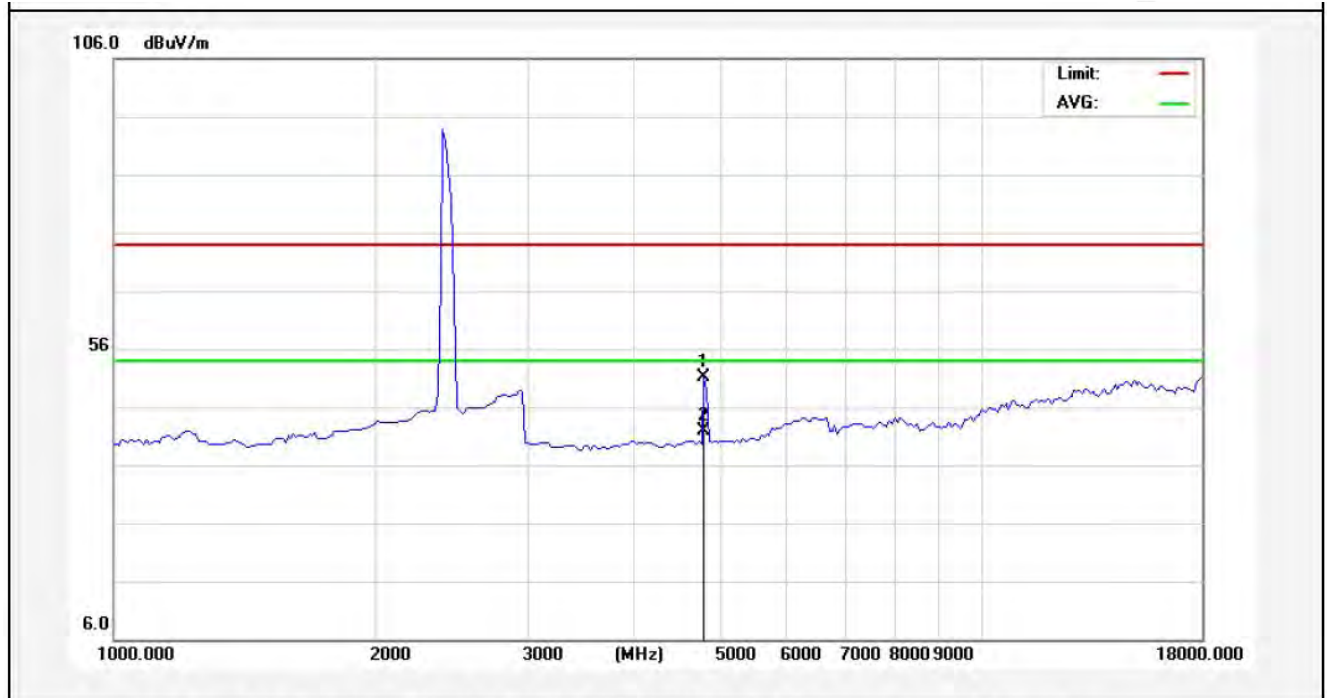

No.	Freq. (MHz)	Reading (dBuV/m)	Factor (dB/m)	Result (dBuV/m)	Limit (dBuV/)	Over Limit (dB)	Detector	Height (cm)	degree (deg)	Remark
1	4825.000	47.67	3.34	51.01	74.00	-22.99	peak			
2	4825.000	38.61	3.34	41.95	54.00	-12.05	AVG			



Job No.:	011507060I	Polarization:	Vertical
Standard:	(RE)FCC PART15 C _3m	Power Source:	AC 120V, 60Hz for adapter
Test item:	Radiation Test	Temp.(C)/Hum.(%RH):	24.3(C)/55%RH
Note:	ANT B 802.11b(2412MHz)	Distance:	3m

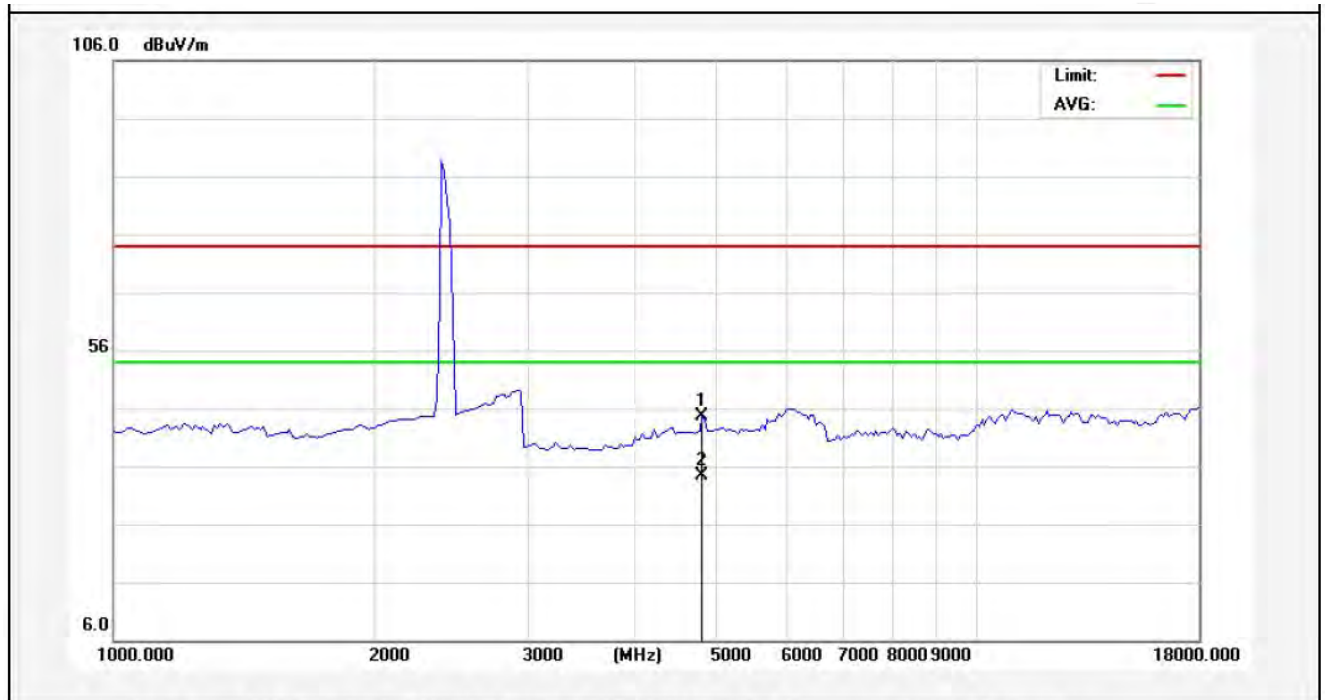

No.	Freq. (MHz)	Reading (dBuV/m)	Factor (dB/m)	Result (dBuV/m)	Limit (dBuV/)	Over Limit (dB)	Detector	Height (cm)	degree (deg)	Remark
1	4825.000	41.33	3.34	44.67	74.00	-29.33	peak			
2	4825.000	30.94	3.34	34.28	54.00	-19.72	AVG			

AM

Job No.:	0115070601	Polarization:	Horizontal
Standard:	(RE)FCC PART15 C _3m	Power Source:	AC 120V, 60Hz for adapter
Test item:	Radiation Test	Temp.(C)/Hum.(%RH):	24.3(C)/55%RH
Note:	ANT B 802.11b(2437MHz)	Distance:	3m

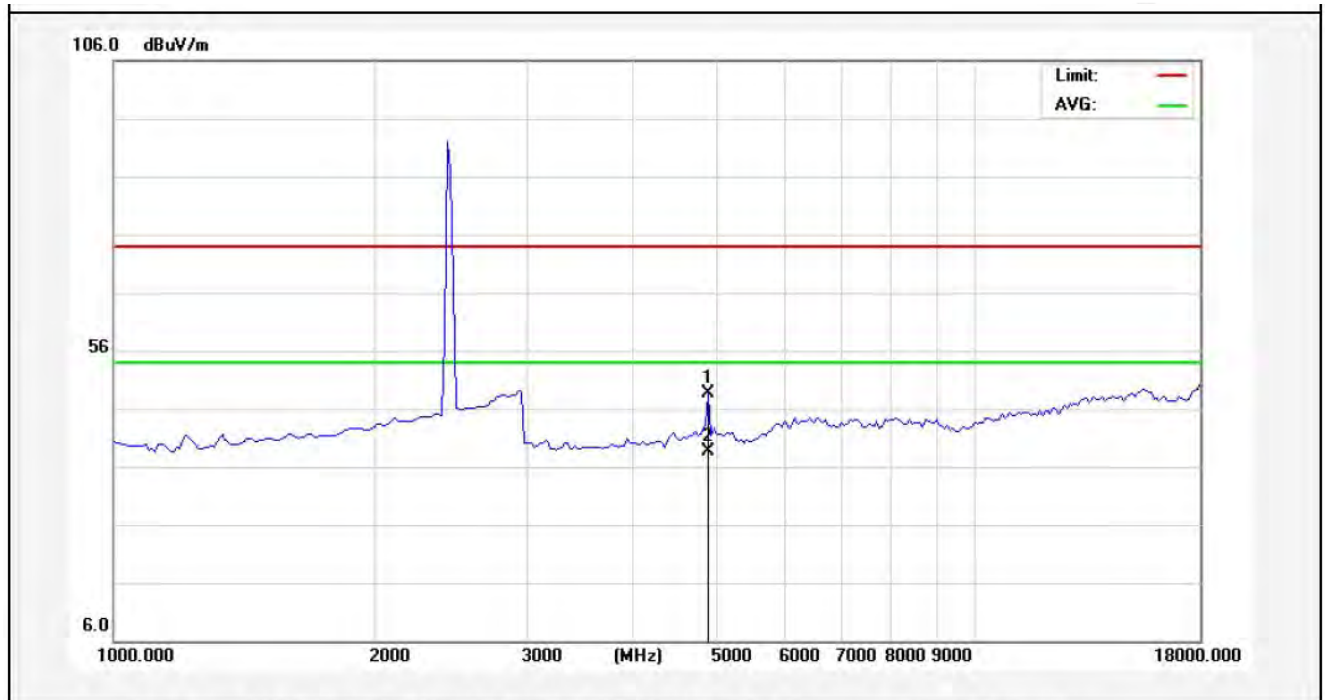

No.	Freq. (MHz)	Reading (dBuV/m)	Factor (dB/m)	Result (dBuV/m)	Limit (dBuV/)	Over Limit (dB)	Detector	Height (cm)	degree (deg)	Remark
1	4867.500	45.20	3.41	48.61	74.00	-25.39	peak			
2	4867.500	35.22	3.41	38.63	54.00	-15.37	AVG			

AM

<b>Job No.:</b>	<b>011507060I</b>	<b>Polarization:</b>	<b>Vertical</b>
<b>Standard:</b>	<b>(RE)FCC PART15 C _3m</b>	<b>Power Source:</b>	<b>AC 120V, 60Hz for adapter</b>
<b>Test item:</b>	<b>Radiation Test</b>	<b>Temp.(C)/Hum.(%RH):</b>	<b>24.3(C)/55%RH</b>
<b>Note:</b>	<b>ANT B</b> <b>802.11b(2437MHz)</b>	<b>Distance:</b>	<b>3m</b>

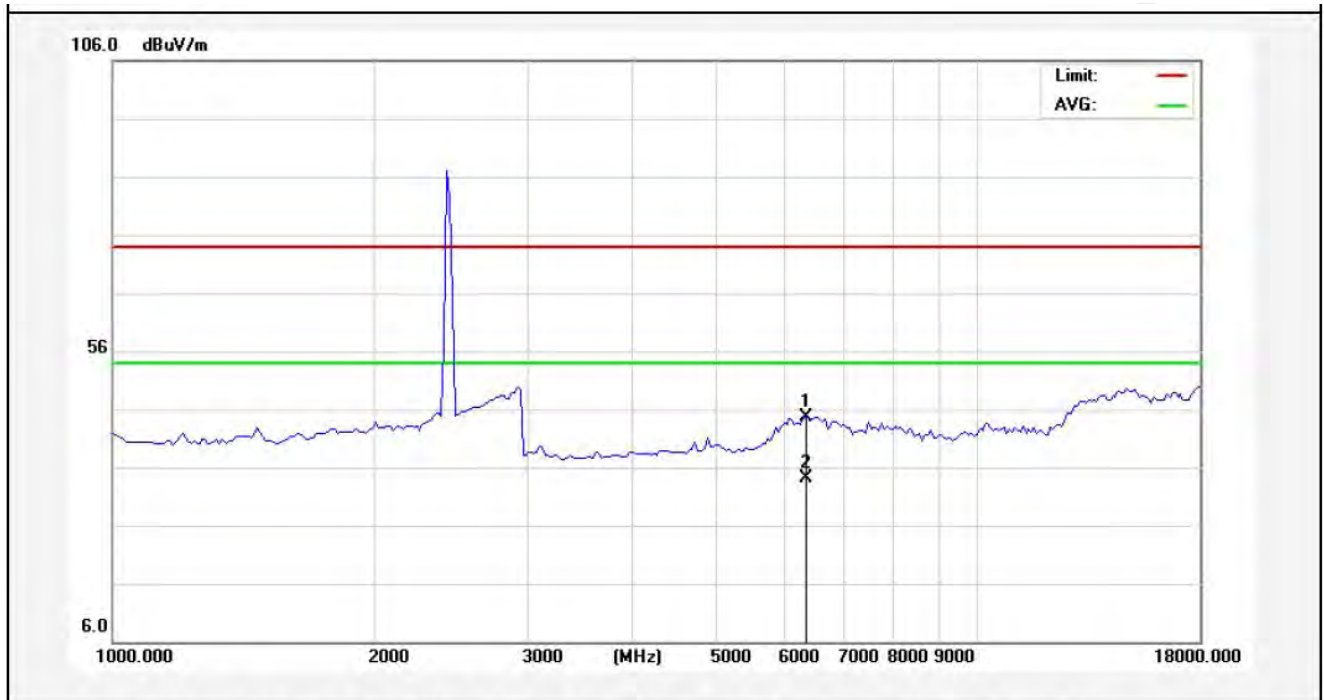

No.	Freq. (MHz)	Reading (dBuV/m)	Factor (dB/m)	Result (dBuV/m)	Limit (dBuV/)	Over Limit (dB)	Detector	Height (cm)	degree (deg)	Remark
1	6355.000	37.21	7.46	44.67	74.00	-29.33	peak			
2	6355.000	26.61	7.46	34.07	54.00	-19.93	AVG			



Job No.:	011507060I	Polarization:	Horizontal
Standard:	(RE)FCC PART15 C_3m	Power Source:	AC 120V, 60Hz for adapter
Test item:	Radiation Test	Temp.(C)/Hum.(%RH):	24.3(C)/55%RH
Note:	ANT B 802.11b(2462MHz)	Distance:	3m

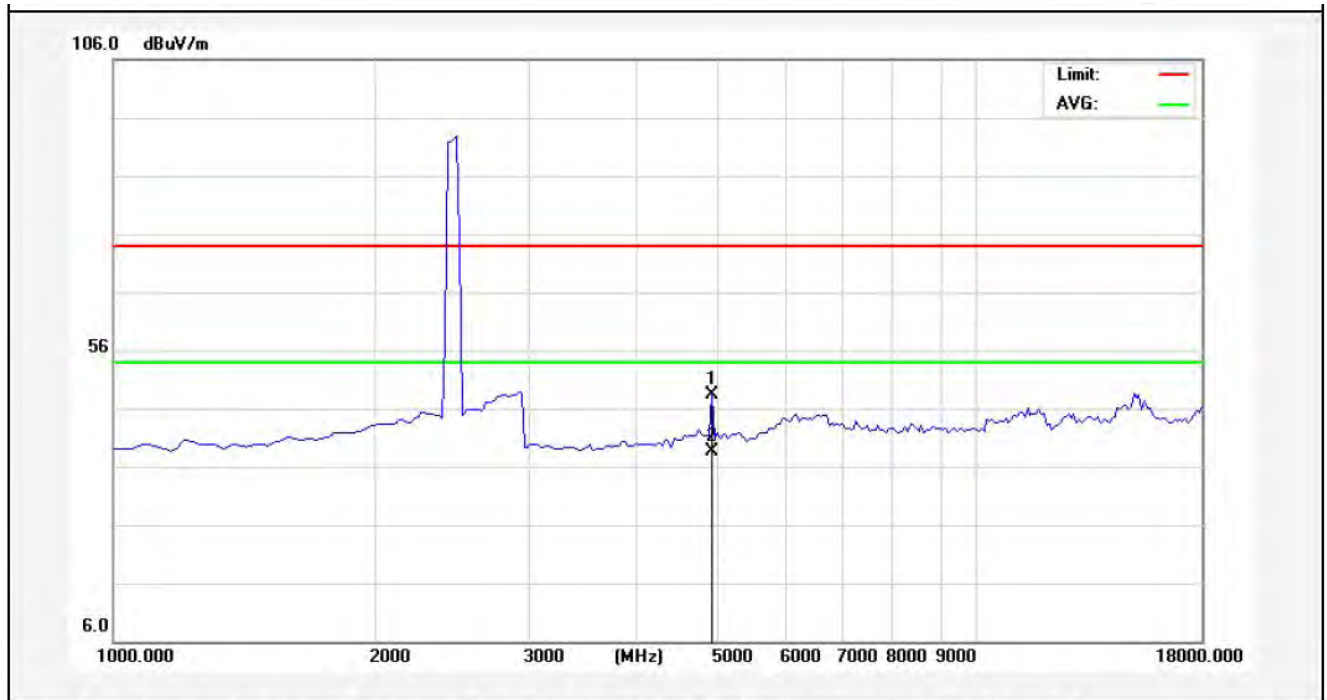

No.	Freq. (MHz)	Reading (dBuV/m)	Factor (dB/m)	Result (dBuV/m)	Limit (dBuV/)	Over Limit (dB)	Detector	Height (cm)	degree (deg)	Remark
1	4910.000	44.78	3.49	48.27	74.00	-25.73	peak			
2	4910.000	35.22	3.49	38.71	54.00	-15.29	AVG			

AM



Job No.:	011507060I	Polarization:	Vertical
Standard:	(RE)FCC PART15 C _3m	Power Source:	AC 120V, 60Hz for adapter
Test item:	Radiation Test	Temp.(C)/Hum.(%RH):	24.3(C)/55%RH
Note:	ANT B 802.11b(2462MHz)	Distance:	3m

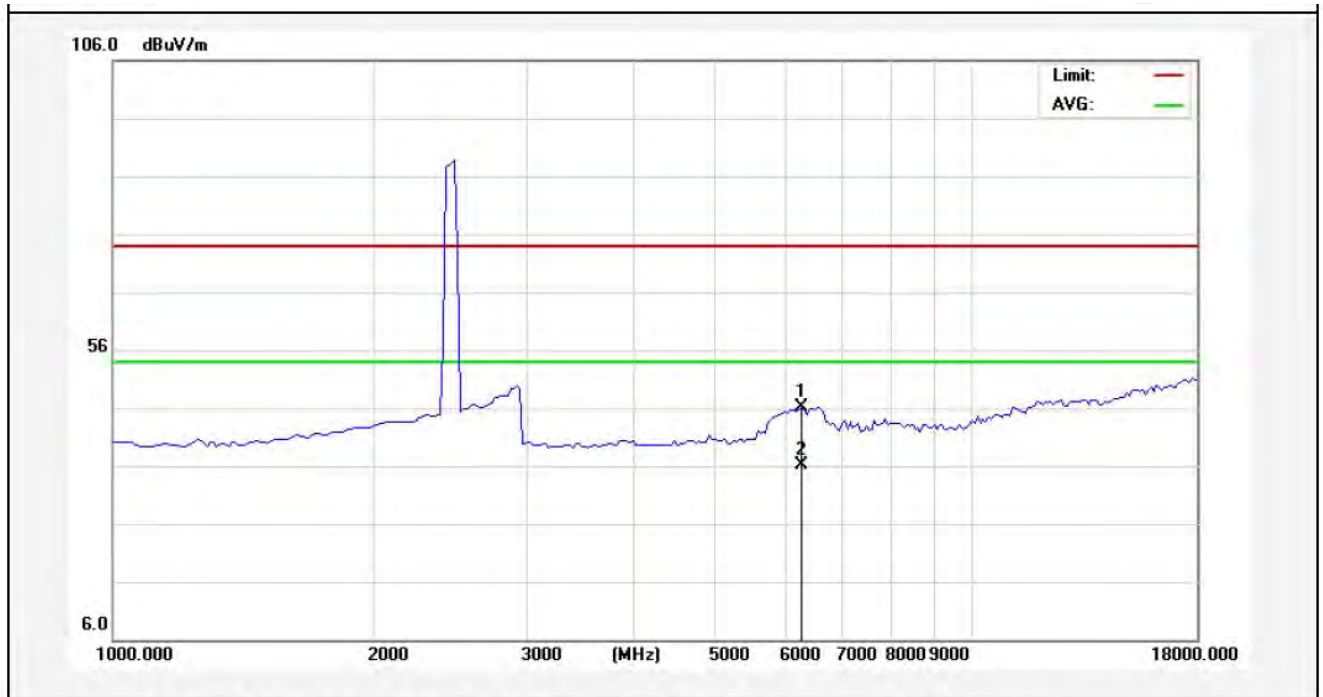

No.	Freq. (MHz)	Reading (dBuV/m)	Factor (dB/m)	Result (dBuV/m)	Limit (dBuV/)	Over Limit (dB)	Detector	Height (cm)	degree (deg)	Remark
1	6312.500	38.79	7.42	46.21	74.00	-27.79	peak			
2	6312.500	28.72	7.42	36.14	54.00	-17.86	AVG			

AM

## 5. ANTENNA APPLICATION

### 5.1. Antenna requirement

The EUT'S antenna is met the requirement of FCC part 15C section 15.203.

An intentional radiator shall be designed to ensure that no antenna other than that furnished by the responsible party shall be used with the device. The use of a permanently attached antenna or of an antenna that uses a unique coupling to the intentional radiator shall be considered sufficient to comply with the provisions of this section. The manufacturer may design the unit so that a broken antenna can be replaced by the user, but the use of a standard antenna jack or electrical connector is prohibited. This requirement does not apply to carrier current devices or to devices operated under the provisions of §15.211, §15.213, §15.217, §15.219, or §15.221. Further, this requirement does not apply to intentional radiators that must be professionally installed, such as perimeter protection systems and some field disturbance sensors, or to other intentional radiators which, in accordance with §15.31(d), must be measured at the installation site. However, the installer shall be responsible for ensuring that the proper antenna is employed so that the limits in this part are not exceeded.

### 5.2. Result

The EUT's antenna used a Integrated antenna which is permanently attached, The antenna's gain is -0.5dBi and meets the requirement.

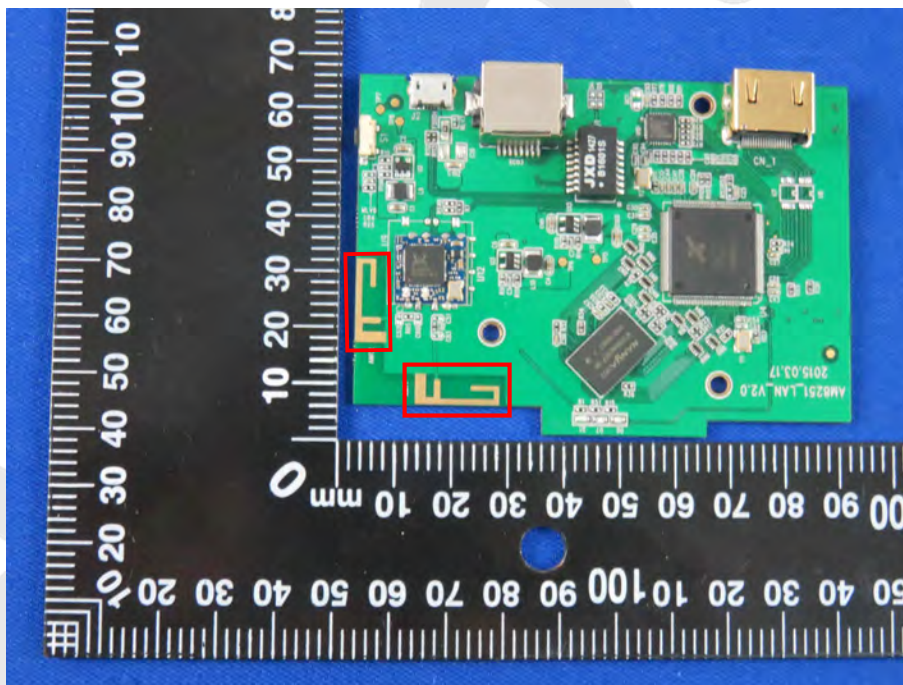

## 6. PHOTOGRAPH

### 6.1. Photo of Conducted Emission Measurement



### 6.2. Photo of Radiation Emission Test



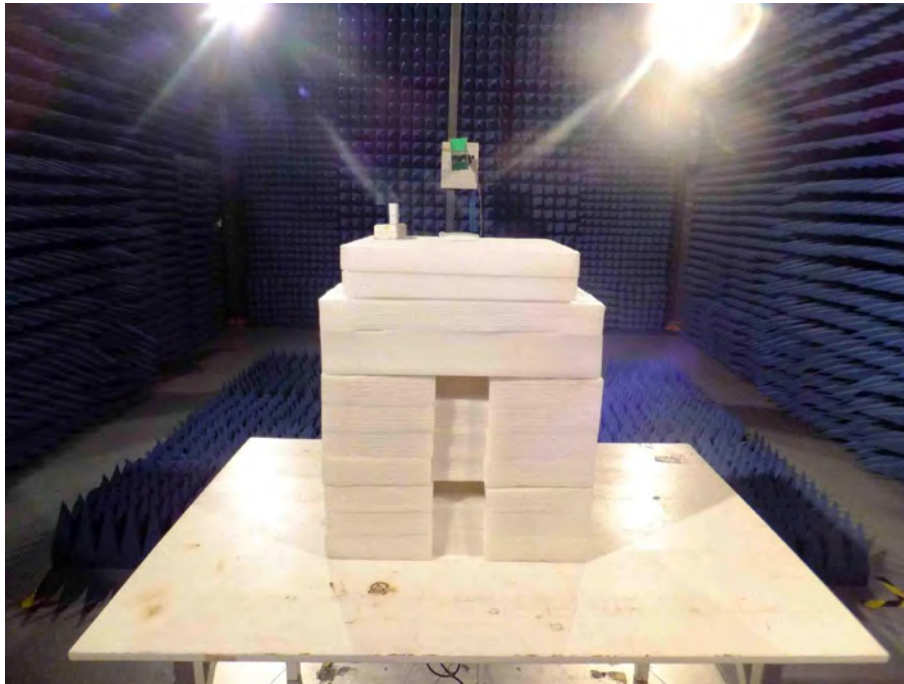

Anbotek

## APPENDIX I (EXTERNAL PHOTOS)

Figure 1  
The EUT-Overall View



Figure 2  
The EUT-Top View

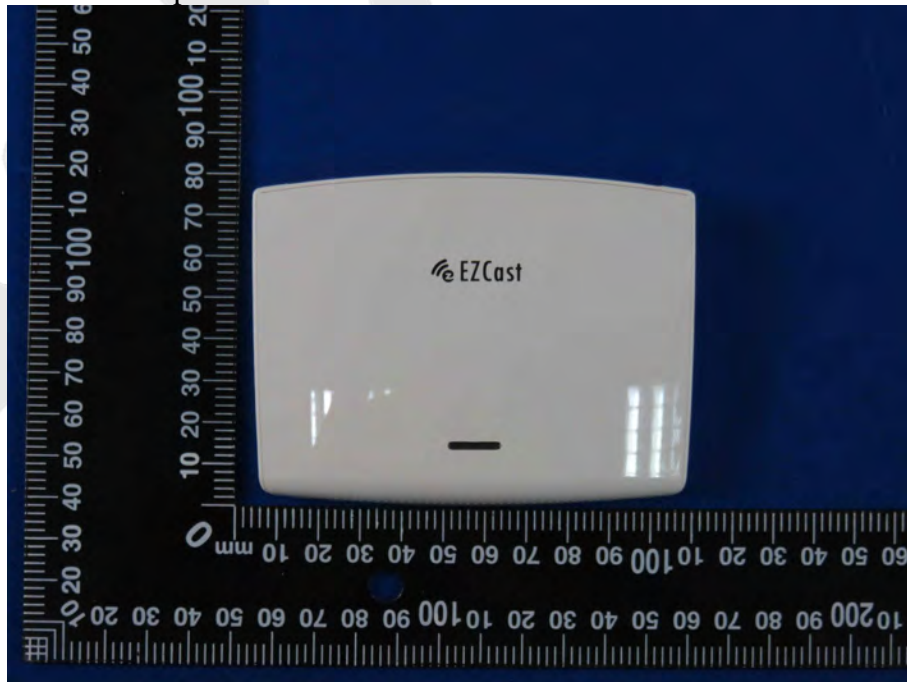

Figure 3  
The EUT-Bottom View



Figure 4  
The EUT-Front View

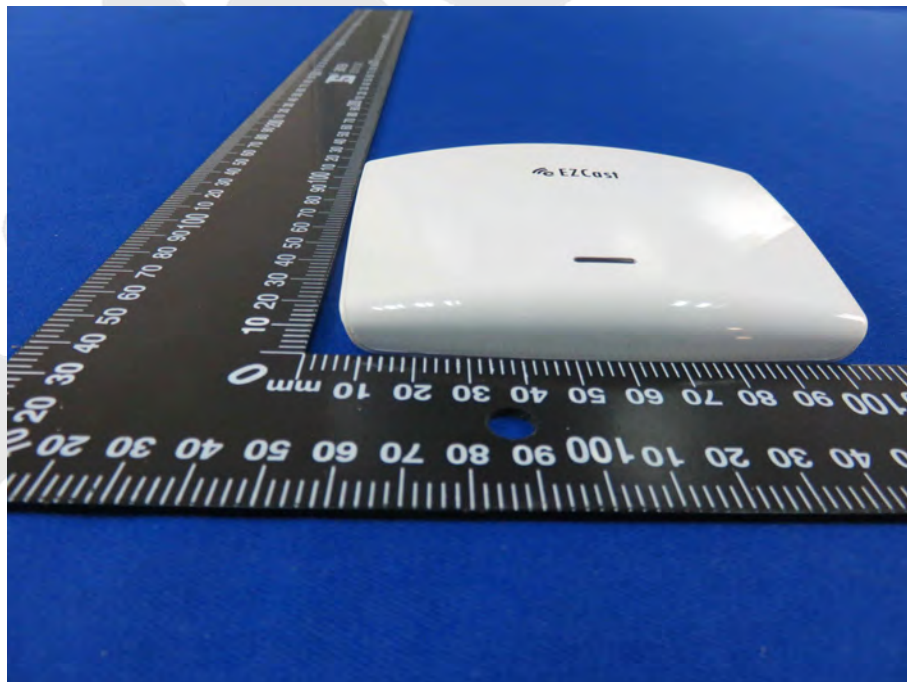

Figure 5  
The EUT-Back View

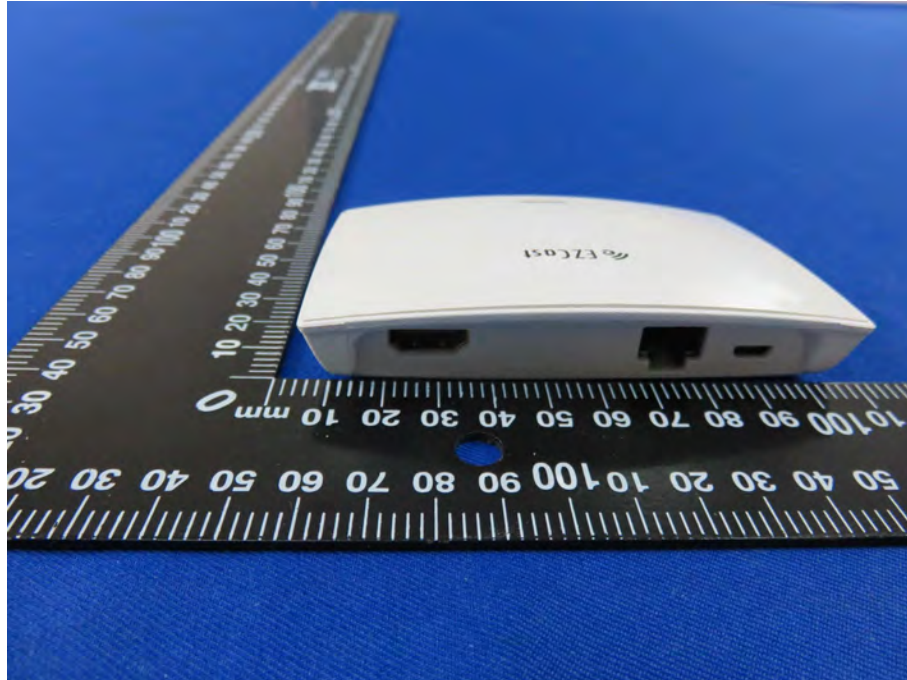

Figure 6  
The EUT-Right Side View

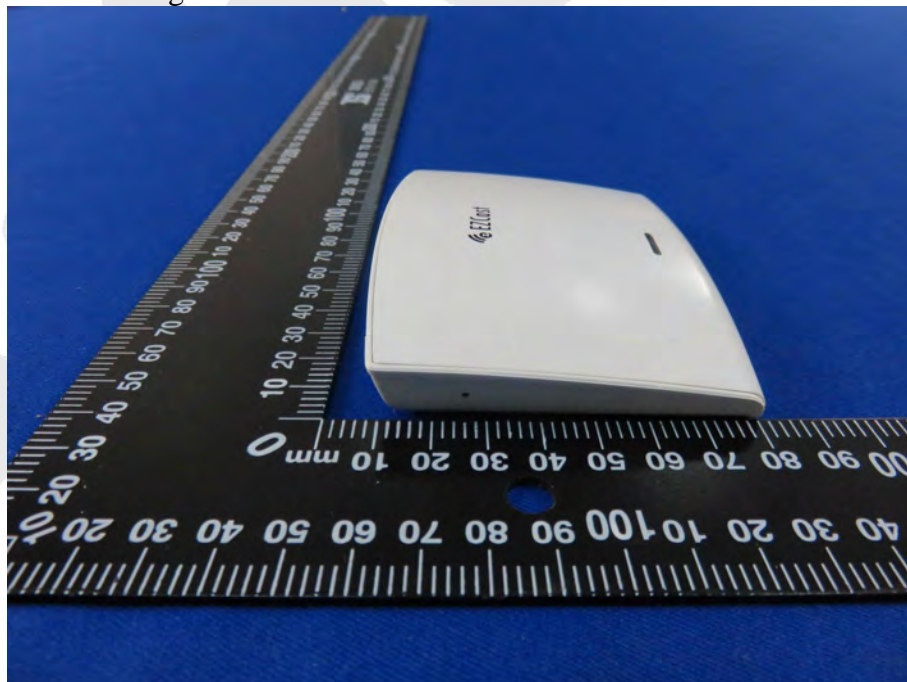
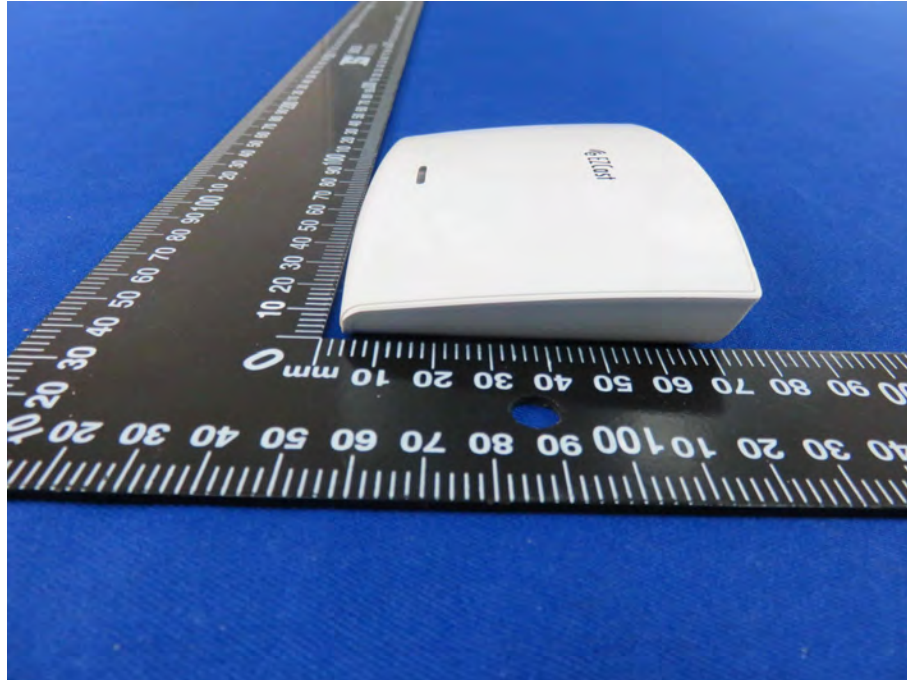

Figure 7  
The EUT-Left Side View



Anbotek



## APPENDIX II (INTERNAL PHOTOS)

Figure 8  
The EUT-Inside View

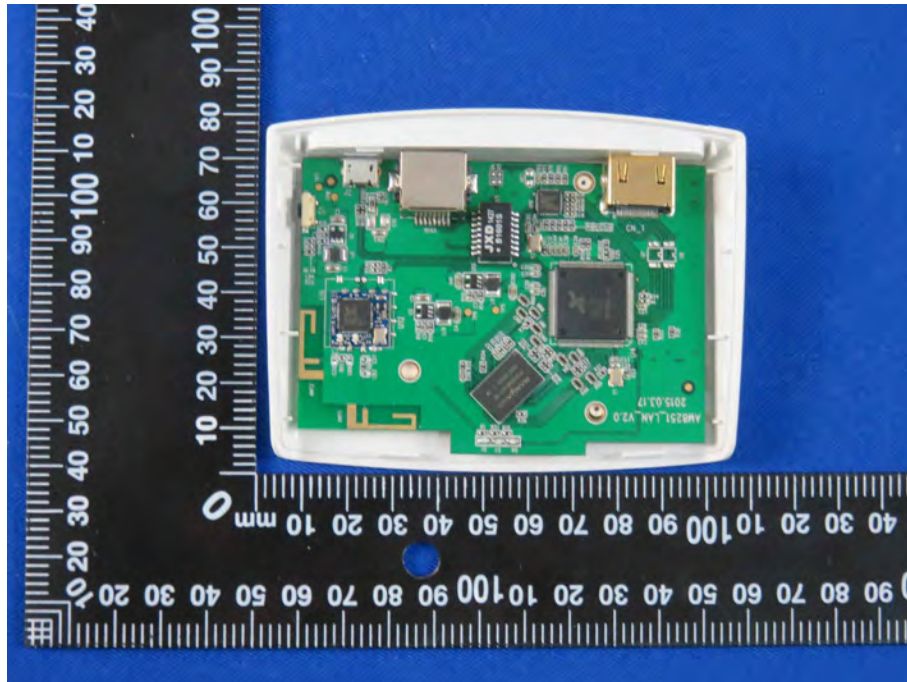

Figure 9  
PCB of the EUT-Front View

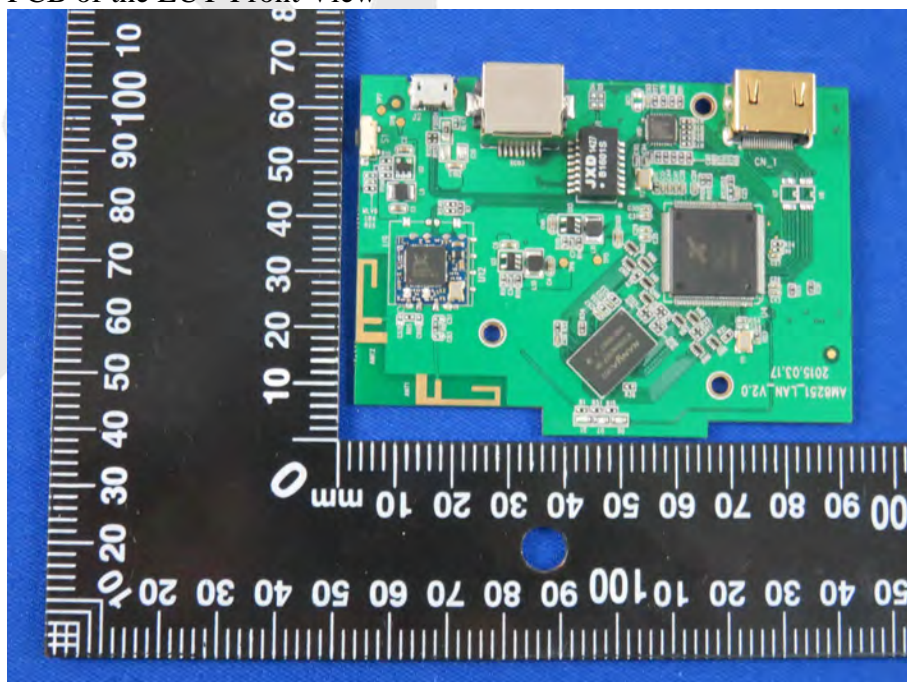

Figure 10  
PCB of the EUT-Back View

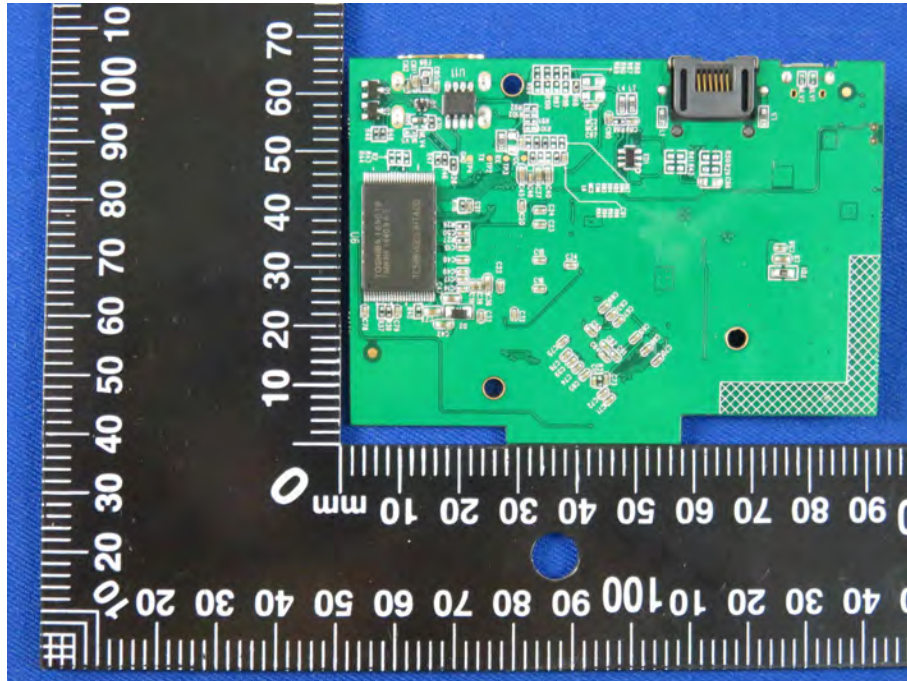

Figure 11  
PCB of the EUT-Front View

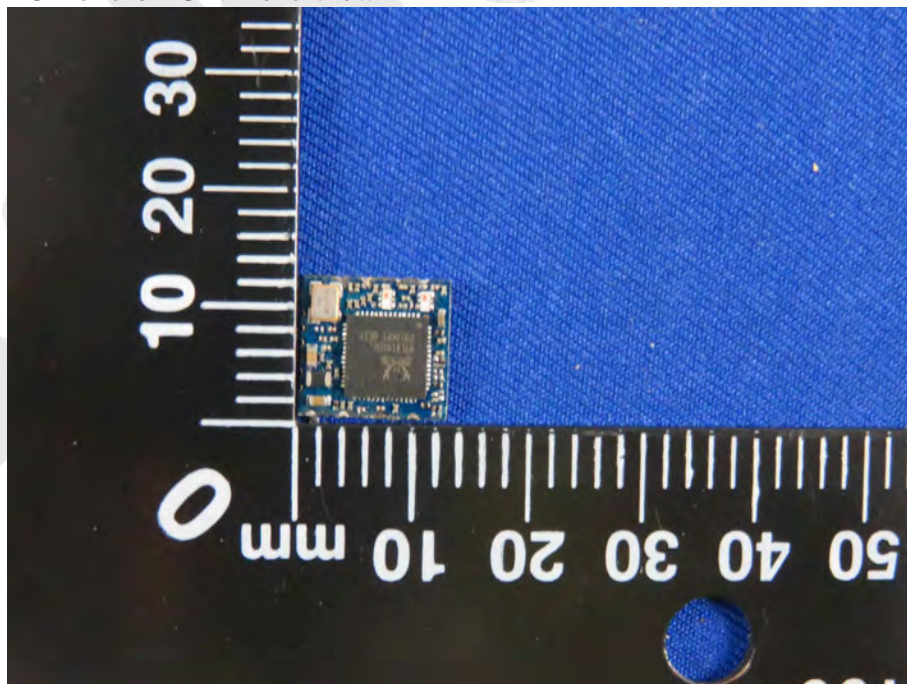

Figure 12  
PCB of the EUT-Back View

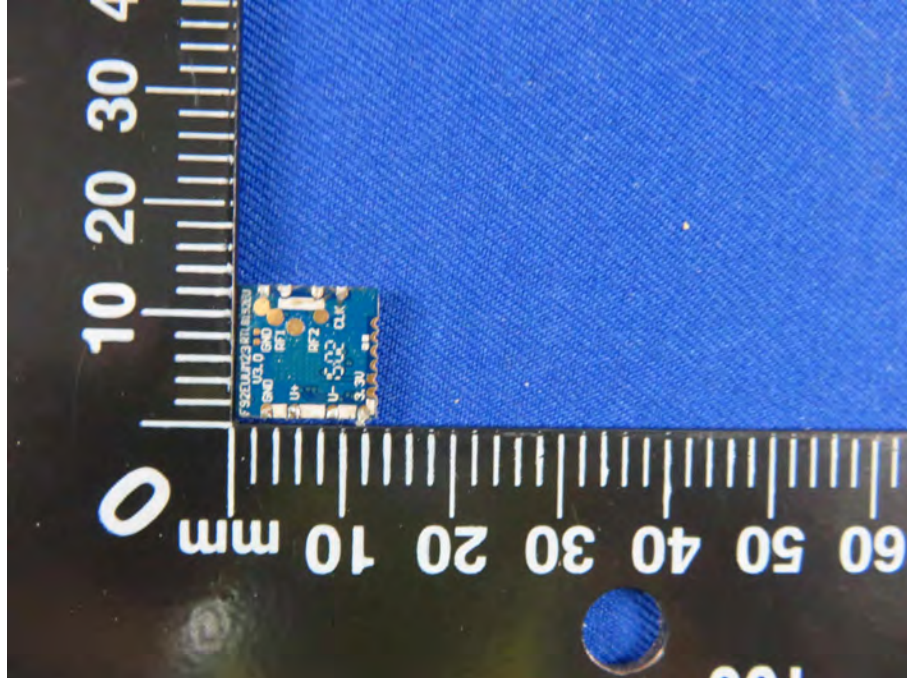

Figure 13  
PCB of the EUT-Front View

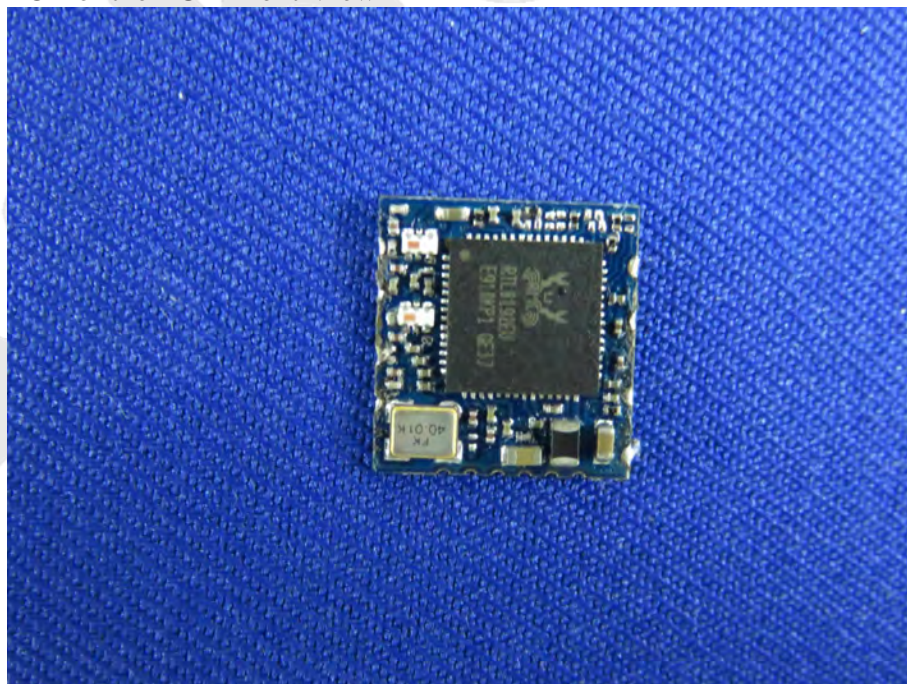
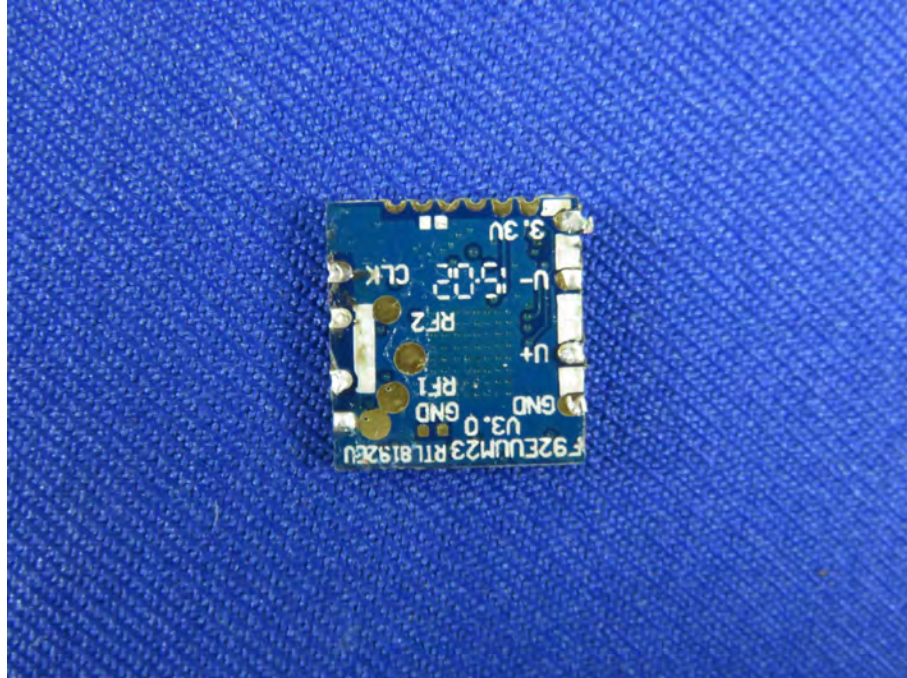

Figure 14  
PCB of the EUT-Back View



Anbotek