



FCC TEST REPORT

Report No: STS1704021F02

Issued for

Winner Wave Limited

4F.-5, No.736, Jhongheng Rd., Jhonghe Dist., New Taipei
City 235, Taiwan (R.O.C.)

Product Name:	EZCast
Brand Name:	EZCast, EZCast PRO, MiraScreen, AnyCast, MiraDisplay
Model Name:	EZCast 4K
Series Model:	MiraScreen 4K, AnyCast 4K, MiraDisplay 4K, EZCast PRO 4K
FCC ID:	2ADFSEZCAST
Test Standard:	FCC Part 15.407

Any reproduction of this document must be done in full. No single part of this document may be reproduced without permission from STS, All Test Data Presented in this report is only applicable to presented Test sample.

Shenzhen STS Test Services Co., Ltd.
1/F., Building B, Zhuoke Science Park, No.190, Chongqing Road,
Fuyong Street, Bao'an District, Shenzhen, Guangdong, China
TEL: +86-755 3688 6288 FAX: +86-755 3688 6277 E-mail: sts@stsapp.com





TEST RESULT CERTIFICATION

Applicant's name : Winner Wave Limited
Address : 4F.-5, No.736, Jhongjheng Rd., Jhonghe Dist., New Taipei City
 235, Taiwan (R.O.C.)
Manufacture's Name : DongGuan HuaBel Electronic Technology Co.,Ltd
Address : No.9 North of Industry-Road, Songshan-Lake, Dongguan,China

Product description

Product name..... : EZCast
Model and/or type reference : EZCast 4K
Series Model : MiraScreen 4K, AnyCast 4K, MiraDisplay 4K, EZCast PRO 4K
Standards..... : FCC Part15.407

Test procedure ANSI C63.10-2013

This device described above has been tested by STS, the test results show that the equipment under test (EUT) is in compliance with the FCC&IC requirements. And it is applicable only to the tested sample identified in the report.

This report shall not be reproduced except in full, without the written approval of STS, this document may be altered or revised by STS, personal only, and shall be noted in the revision of the document.

Date of Test..... :
Date (s) of performance of tests..... : 10 Apr. 2017~27 Apr. 2017
Date of Issue..... : 27 Apr. 2017
Test Result..... : **Pass**

Testing Engineer : 

 (Leo li)

Technical Manager : 

 (Tony liu)

Authorized Signatory : 

 (Vita Li)





Table of Contents	Page
1 . SUMMARY OF TEST RESULTS	5
1.1 TEST FACTORY	6
1.2 MEASUREMENT UNCERTAINTY	6
2 . GENERAL INFORMATION	7
2.1 GENERAL DESCRIPTION OF EUT	7
2.2 DESCRIPTION OF TEST MODES	10
2.3 BLOCK DIGRAM SHOWING THE CONFIGURATION OF SYSTEM TESTED	11
2.4 DESCRIPTION OF SUPPORT UNITS	12
2.5 EQUIPMENTS LIST FOR ALL TEST ITEMS	13
3 . EMC EMISSION TEST	14
3.1 CONDUCTED EMISSION MEASUREMENT	14
3.2 RADIATED EMISSION AND (BANDEGE) MEASUREMENT	18
4. CONDUCTED SPURIOUS EMISSIONS AND BANDEGE	34
4.1 APPLIED PROCEDURES / LIMIT	34
5. POWER SPECTRAL DENSITY TEST	36
5.1 APPLIED PROCEDURES / LIMIT	36
6. BANDWIDTH MEASUREMENT	38
6.1 EMISSION BANDWIDTH (EBW) 26 BANDWID PROCEDURES / LIMIT	38
6.2 OCCUPIED BANDWIDTH (99%) TEST APPLIED PROCEDURES / LIMIT	39
6.3 MINIMUM EMISSION BANDWIDTH(6 DB) PROCEDURES / LIMIT	40
7. MAXIMUM CONDUCTED OUTPUT POWER	41
7.1 APPLIED PROCEDURES / LIMIT	41
8. FREQUENCY STABILITY MEASUREMENT	44
8.1 LIMIT OF FREQUENCY STABILITY	44
9. AUTOMATICALLY DISCONTINUE TRANSMISSION	47
9.1 LIMIT OF AUTOMATICALLY DISCONTINUE TRANSMISSION	47
9.2 TEST RESULT OF AUTOMATICALLY DISCONTINUE TRANSMISSION	47
10. ANTENNA REQUIREMENT	48
10.1 STANDARD REQUIREMENT	48
10.2 EUT ANTENNA	48
APPENDIX - PHOTOS OF TEST SETUP	49



Revision History

Rev.	Issue Date	Report NO.	Effect Page	Contents
00	27 Apr. 2017	STS1704021F02	ALL	Initial Issue





1. SUMMARY OF TEST RESULTS

Test procedures according to the technical standards:

§ 15.407, KDB 789033 D02 General U-NII Test Procedures New Rules v01r03

FCC Part 15.407		
FCC standard	Test Item	Results
15.207	AC Conducted Emission	PASS
§ 15.407 (2) (26 dB) / § 15.407 (e) (6 dB) / § 15.407 (a) (99%)	26dB/6dB & 99% Bandwidth	PASS
15.407(a) (1).(2).(3).(4).(5)	Maximum Conducted Output Power	PASS
15.407(b) & 15.209	Radiated Emission And (bandedge Emissions) Measurement	PASS
15.407(b)7	Conducted Emission And (bandedge Emissions) Measurement	PASS
15.407(a) (1).(2).(3).(4).(5)	Power Spectral Density	PASS
15.407(g)	Frequency Stability	PASS
15.407(c)	Automatically Discontinue Transmission	PASS
15.203/15.204	Antenna Requirement	PASS

NOTE:

(1) "N/A" denotes test is not applicable in this Test Report

(2) all tests are according to ANSI C63.10-2013



1.1 TEST FACTORY

BZT Testing Technology Co., Ltd.

Add. : Buliding 17,Xinghua Road Xingwei industrial Park Fuyong,Baoan District,Shenzhen, Guangdong,China

CNAS Registration No.: 701733

1.2 MEASUREMENT UNCERTAINTY

The reported uncertainty of measurement $y \pm U$, where expanded uncertainty U is based on a standard uncertainty multiplied by a coverage factor of $k=2$, providing a level of confidence of approximately 95 %.

No.	Item	Uncertainty
1	Conducted Emission (9KHz-150KHz)	$\pm 2.88\text{dB}$
2	Conducted Emission (150KHz-30MHz)	$\pm 2.67\text{dB}$
3	RF power,conducted	$\pm 0.70\text{dB}$
4	Spurious emissions,conducted	$\pm 1.19\text{dB}$
5	All emissions,radiated(<1G) 30MHz-200MHz	$\pm 2.83\text{dB}$
6	All emissions,radiated(<1G) 200MHz-1000MHz	$\pm 2.94\text{dB}$
7	All emissions,radiated(>1G)	$\pm 3.03\text{dB}$
8	Temperature	$\pm 0.5^{\circ}\text{C}$
9	Humidity	$\pm 2\%$



2. GENERAL INFORMATION

2.1 GENERAL DESCRIPTION OF EUT

Equipment	EZCast	
Trade Name	EZCast, EZCast PRO, MiraScreen, AnyCast, MiraDisplay	
Model Name	EZCast 4K	
Series Model	MiraScreen 4K, AnyCast 4K, MiraDisplay 4K, EZCast PRO 4K	
Model Difference	Different in model name brand name	
Product Description	The EUT is a EZCast	
	Operation Frequency:	IEEE 802.11a/ n/ac(HT20) 5.180GHz-5.240GHz IEEE 802.11n/ac(HT40) 5.190GHz-5.310GHz IEEE 802.11ac(HT80) 5.210GHz IEEE 802.11a/ n/ac(HT20)5.745GHz-5.825GHz IEEE 802.11n/ac(HT40)5.755GHz-5.795GHz IEEE 802.11ac(HT80) 5.775GHz
	Modulation Type:	IEEE for 802.11a/n/ac: OFDM(BPSK/QPSK/16QAM)
	Antenna Designation:	See Note 3
	Max.Output Power(Conducted):	0dBi
	The duty cycle of WLAN 802.11a/n were 98 %	
	More details of EUT technical specification, please refer to the User's Manual.	
Test Channel	Please refer to the Note 2.	
Power	Input: DC 5V, 1A	
Hardware version number	--	
Software version number	--	
Connecting I/O Port(s)	Please refer to the User's Manual	

Note:For a more detailed features description, please refer to the manufacturer's specifications or the User's Manual.



1. Operation Frequency of channel

5.180GHz-5.240GHz		5.745GHz-5.825GHz	
Channel	Frequency	Channel	Frequency
36	5180	149	5745
38	5190	151	5755
40	5200	153	5765
42	5210	157	5785
44	5220	159	5795
46	5230	161	5805
48	5240	165	5825

Note:

In section 15.31(m), regards to the operating frequency range over 10 MHz, the Lowest frequency, the middle frequency, and the highest frequency of channel were selected to perform the test, and the selected channel see below:

Carrier Frequency Channel

5GHz:

For 802.11a/n/ac (HT20)	
Channel	Freq.(MHz)
36	5180
40	5200
48	5240

For 802.11a/n/ac (HT20)	
Channel	Freq.(MHz)
149	5745
157	5785
165	5825

For 802.11n/ac (HT40)	
Channel	Freq.(MHz)
38	5190
46	5230

For 802.11n/ac (HT40)	
Channel	Freq.(MHz)
151	5755
159	5795



For 802.11ac (HT80)	
Channel	Freq.(MHz)
42	5210

For 802.11ac (HT80)	
Channel	Freq.(MHz)
155	5775

Ant	Brand	Model Name	Ant Type	Connector	Gain (dBi)	NOTE
A	EZCast, EZCast PRO, MiraScreen , AnyCast, MiraDisplay	EZCast 4K	PCB Ant	N/A	(5 150 -5 350)MHz: 0dBi (5 725 -5 850)MHz: 0dBi	WIFI Ant

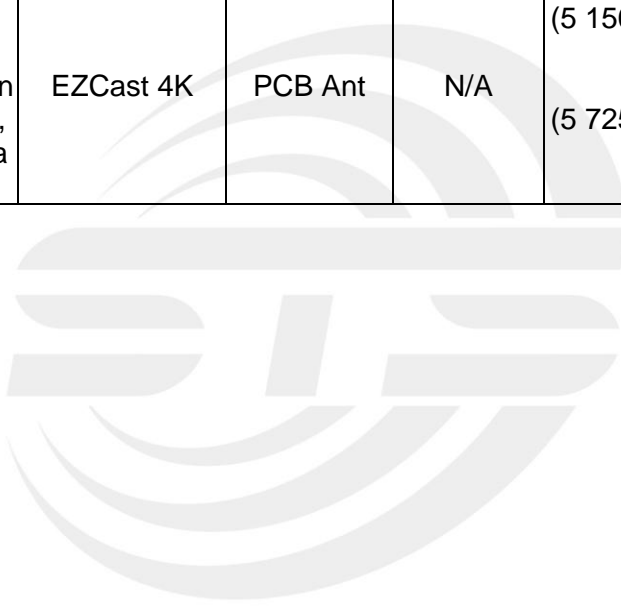



2.2 DESCRIPTION OF TEST MODES

To investigate the maximum EMI emission characteristics generates from EUT, the test system was pre-scanning tested base on the consideration of following EUT operation mode or test configuration mode which possible have effect on EMI emission level. Each of these EUT operation mode(s) or test configuration mode(s) mentioned above was evaluated respectively.

Worst Mode	Description	Data Rate
Mode 1	TX IEEE 802.11a HT20 CH36&CH40&CH48	6 Mbps
Mode 2	TX IEEE 802.11a HT20 CH149&CH157&CH165	6 Mbps
Mode 3	TX IEEE 802.11n HT20 CH36&CH40&CH48	MCS 0
Mode 4	TX IEEE 802.11ac HT20 CH36&CH40&CH48	NSS1 MCS0
Mode 5	TX IEEE 802.11n HT20 CH149&CH157&CH165	MCS 0
Mode 6	TX IEEE 802.11n HT20 CH149&CH157&CH165	NSS1 MCS0
Mode 7	TX IEEE 802.11n HT40 CH38&CH46	MCS 0
Mode 8	TX IEEE 802.11ac HT40 CH38&CH46	NSS1 MCS0
Mode 9	TX IEEE 802.11n HT40 CH151&CH159	MCS 0
Mode 10	TX IEEE 802.11ac HT40 CH151&CH159	NSS1 MCS0
Mode 11	TX IEEE 802.11ac HT80 CH42	NSS1 MCS0
Mode 12	TX IEEE 802.11ac HT80 CH155	NSS1 MCS0

Conducted test model

Worst Mode	Description
Mode 13	TX and connect with computer

- Note: (1) The measurements are performed at the highest, middle, lowest available channels.
 (2) The measurements are performed at all Bit Rate of Transmitter, the worst data was reported

2.3 BLOCK DIAGRAM SHOWING THE CONFIGURATION OF SYSTEM TESTED

Radiated Spurious Emission Test

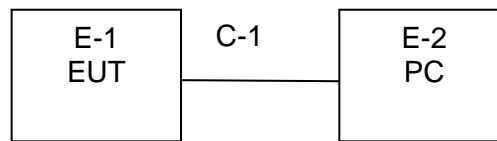



2.4 DESCRIPTION OF SUPPORT UNITS

The EUT has been tested as an independent unit together with other necessary accessories or support units. The following support units or accessories were used to form a representative test configuration during the tests.

Item	Equipment	Mfr/Brand	Model/Type No.	Series No.	Note
E-1	EZCast	EZCast, EZCast PRO, MiraScreen, AnyCast, MiraDisplay	EZCast 4K	N/A	EUT
E-2	PC	acer	500-320cx	4CV428DQVV	N/A

Item	Shielded Type	Ferrite Core	Length	Note
C-1	USB Cable (Charging)	NO	20cm	N/A

Note:

- (1) The support equipment was authorized by Declaration of Confirmation.
- (2) For detachable type I/O cable should be specified the length in cm in 『Length』 column.
- (3) “YES” is means “shielded” “with core”; “NO” is means “unshielded” “without core”.

2.5 EQUIPMENTS LIST FOR ALL TEST ITEMS

Radiation Test equipment

Kind of Equipment	Manufacturer	Type No.	Serial No.	Last calibration	Calibrated until
Spectrum Analyzer	Agilent	E4407B	MY50140340	2016.10.23	2017.10.22
Spectrum Analyzer	Agilent	AV4051F	Y20141343	2016.10.23	2017.10.22
Test Receiver	R&S	ESCI	101427	2016.10.23	2017.10.22
Bilog Antenna	TESEQ	CBL6111D	34678	2014.11.24	2017.11.23
Horn Antenna	Schwarzbeck	BBHA 9120D	9120D-1343	2015.03.05	2018.03.04
Horn Antenna	Schwarzbeck	BBHA 9170	9170-0741	2016.03.06	2019.03.03
50Ω Coaxial Switch	Anritsu	MP59B	6200264416	2016.06.06	2017.06.05
PreAmplifier	Agilent	8449B	60538	2016.10.23	2017.10.22
Loop Antenna	EMCO	6502	9003-2485	2016.03.06	2019.03.03
Low frequency cable	EM	R01	N/A	NCR	NCR
High frequency cable	SCHWARZBECK	AK9515H	SN-96286/96287	NCR	NCR

Conduction Test equipment

Kind of Equipment	Manufacturer	Type No.	Serial No.	Last calibration	Calibrated until
EMI Test Receiver	R&S	ESPI	102086	2016.10.23	2017.10.22
LISN	R&S	ENV216	101242	2016.10.23	2017.10.22
LISN	EMCO	3810/2NM	000-23625	2016.10.23	2017.10.22
Conduction Cable	EM	C01	N/A	NCR	NCR

RF Connected Test

Kind of Equipment	Manufacturer	Type No.	Serial No.	Last calibration	Calibrated until
USB RF power sensor	DARE	RPR3006W	15I00041SNO03	2016.10.23	2017.10.22
Spectrum Analyzer	Agilent	E4407B	MY50140340	2016.10.23	2017.10.22
Signal Analyzer	Agilent	N9020A	MY49100060	2016.10.23	2017.10.22

3. EMC EMISSION TEST

3.1 CONDUCTED EMISSION MEASUREMENT

3.1.1 POWER LINE CONDUCTED EMISSION Limits (Frequency Range 150KHz-30MHz)

FREQUENCY (MHz)	Class B (dBuV)		Standard
	Quasi-peak	Average	
0.15 -0.5	66 - 56 *	56 - 46 *	CISPR
0.50 -5.0	56.00	46.00	CISPR
5.0 -30.0	60.00	50.00	CISPR

0.15 -0.5	66 - 56 *	56 - 46 *	FCC
0.50 -5.0	56.00	46.00	FCC
5.0 -30.0	60.00	50.00	FCC

Note:

- (1) The tighter limit applies at the band edges.
- (2) The limit of " * " marked band means the limitation decreases linearly with the logarithm of the frequency in the range.

The following table is the setting of the receiver

Receiver Parameters	Setting
Attenuation	10 dB
Start Frequency	0.15 MHz
Stop Frequency	30 MHz
IF Bandwidth	9 kHz

3.1.2 TEST PROCEDURE

- a. The EUT was placed 0.8 meters from the horizontal ground plane with EUT being connected to the power mains through a line impedance stabilization network (LISN). All other support equipments powered from additional LISN(s). The LISN provide 50 Ohm/ 50uH of coupling impedance for the measuring instrument.
- b. Interconnecting cables that hang closer than 40 cm to the ground plane shall be folded back and forth in the center forming a bundle 30 to 40 cm long.
- c. I/O cables that are not connected to a peripheral shall be bundled in the center. The end of the cable may be terminated, if required, using the correct terminating impedance. The overall length shall not exceed 1 m.
- d. LISN at least 80 cm from nearest part of EUT chassis.
- e. For the actual test configuration, please refer to the related Item –EUT Test Photos.

3.1.3 DEVIATION FROM TEST STANDARD

No deviation

3.1.4 TEST SETUP

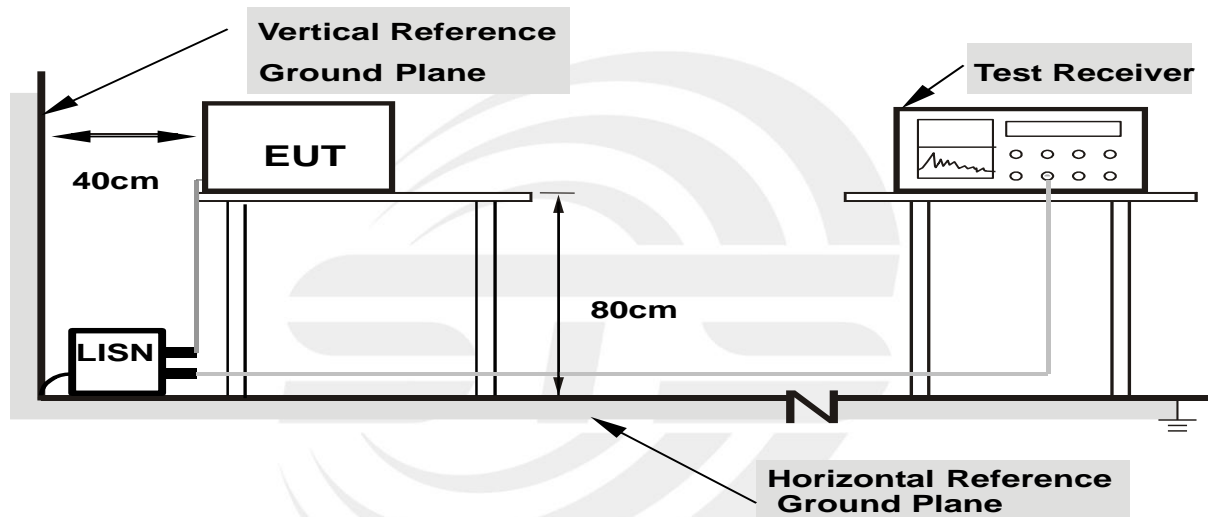

- Note: 1.Support units were connected to second LISN.**
2.Both of LISNs (AMN) are 80 cm from EUT and at least 80 from other units and other metal planes

3.1.5 EUT OPERATING CONDITIONS

The EUT was configured for testing in a typical fashion (as a customer would normally use it). The EUT has been programmed to continuously transmit during test. This operating condition was tested and used to collect the included data.



3.1.6 TEST RESULTS

Temperature:	26°C	Relative Humidity:	60%
Pressure:	1010 hPa	Test Voltage:	AC120V/60Hz
Test Mode:	Mode 13	Polarization:	L

Frequency (MHz)	Reading (dBuV)	Correct Factor (dB)	Result (dBuV)	Limit (dBuV)	Margin (dB)	Remark
0.1580	44.95	9.23	54.18	65.57	-11.39	QP
0.1580	25.01	9.23	34.24	55.57	-21.33	AVG
0.2100	40.14	9.22	49.36	63.21	-13.85	QP
0.2100	21.78	9.22	31.00	53.21	-22.21	AVG
0.4860	25.16	9.18	34.34	56.24	-21.90	QP
0.4860	13.14	9.18	22.32	46.24	-23.92	AVG
1.5820	23.17	9.21	32.38	56.00	-23.62	QP
1.5820	11.28	9.21	20.49	46.00	-25.51	AVG
3.5860	22.57	9.26	31.83	56.00	-24.17	QP
3.5860	8.45	9.26	17.71	46.00	-28.29	AVG
9.6740	27.57	9.48	37.05	60.00	-22.95	QP
9.6740	17.18	9.48	26.66	50.00	-23.34	AVG

Remark:

- Margin = Result (Result = Reading + Factor) - Limit

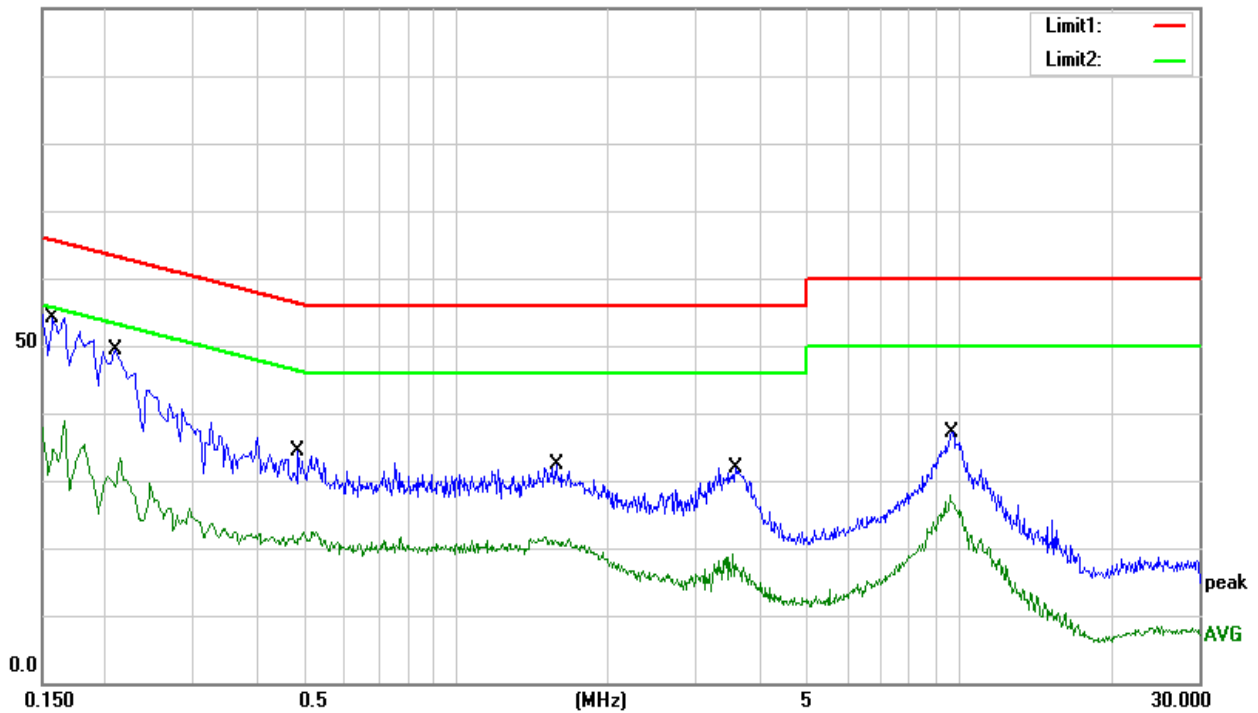



Temperature:	26°C	Relative Humidity:	60%
Pressure:	1010 hPa	Test Voltage:	AC120V/60Hz
Test Mode:	Mode 13	Polarization:	N

Frequency (MHz)	Reading (dBuV)	Correct Factor(dB)	Result (dBuV)	Limit (dBuV)	Margin (dB)	Remark
0.1580	48.19	9.23	57.42	65.57	-8.15	QP
0.1580	25.78	9.23	35.01	55.57	-20.56	AVG
0.1900	40.96	9.23	50.19	64.04	-13.85	QP
0.1900	20.63	9.23	29.86	54.04	-24.18	AVG
0.5020	25.48	9.14	34.62	56.00	-21.38	QP
0.5020	13.14	9.14	22.28	46.00	-23.72	AVG
1.5180	23.01	9.20	32.21	56.00	-23.79	QP
1.5180	11.44	9.20	20.64	46.00	-25.36	AVG
3.3940	23.28	9.26	32.54	56.00	-23.46	QP
3.3940	8.58	9.26	17.84	46.00	-28.16	AVG
9.7700	27.64	9.48	37.12	60.00	-22.88	QP
9.7700	16.85	9.48	26.33	50.00	-23.67	AVG

Remark:

1. Margin = Result (Result = Reading + Factor) - Limit
 100.0 dBuV

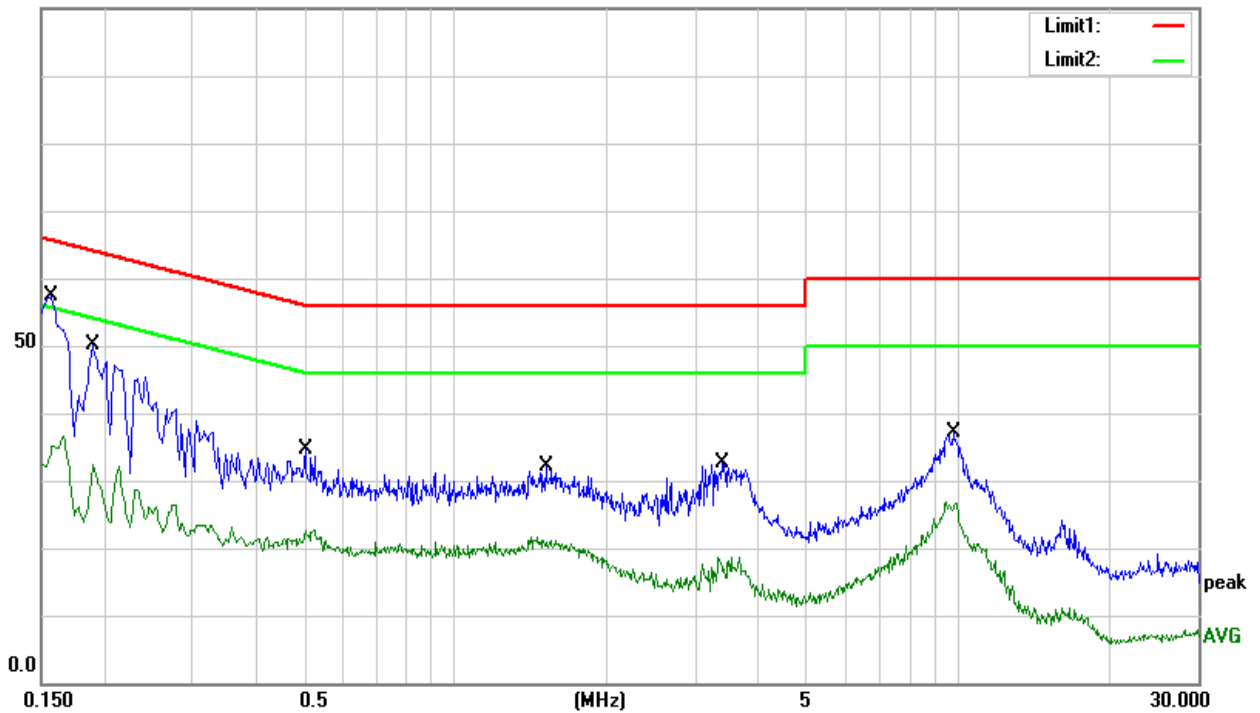

3.2 RADIATED EMISSION AND (BANDEDGE) MEASUREMENT

3.2.1 RADIATED EMISSION LIMITS (Frequency Range 9kHz-1000MHz)

In case the emission fall within the restricted band specified on 15.407(b)7& 15.205/209(a), then the (a); limit in the table below has to be followed.

Frequencies (MHz)	Field Strength (micorvolts/meter)	Measurement Distance (meters)
0.009~0.490	2400/F(KHz)	300
0.490~1.705	24000/F(KHz)	30
1.705~30.0	30	30
30~88	100	3
88~216	150	3
216~960	200	3
Above 960	500	3

LIMITS OF RADIATED EMISSION MEASUREMENT (Above 1000MHz)

FREQUENCY (MHz)	Class B (dBuV/m) (at 3M)	
	PEAK	AVERAGE
Above 1000	74	54

Notes:

- (1) The limit for radiated test was performed according to FCC PART 15E.
- (2) The tighter limit applies at the band edges.
- (3) Emission level (dBuV/m)=20log Emission level (uV/m).

Spectrum Parameter	Setting
Attenuation	Auto
Detector	Peak
Start Frequency	1000 MHz(Peak/AV)
Stop Frequency	10th carrier harmonic(Peak/AV)
RB / VB (emission in restricted band)	1 MHz / 1 MHz, AV=1 MHz /3 MHz

For Band edge

Spectrum Parameter	Setting
Detector	Peak
RB / VB (emission in restricted band)	1 MHz / 1 MHz, AV=1 MHz /3 MHz



Receiver Parameter	Setting
Attenuation	Auto
Start ~ Stop Frequency	9kHz~90kHz / RB 200Hz for PK & AV
Start ~ Stop Frequency	90kHz~110kHz / RB 200Hz for QP
Start ~ Stop Frequency	110kHz~490kHz / RB 200Hz for PK & AV
Start ~ Stop Frequency	490kHz~30MHz / RB 9kHz for QP
Start ~ Stop Frequency	30MHz~1000MHz / RB 120kHz for QP

3.2.2 TEST PROCEDURE

- a. The measuring distance of at 3 m shall be used for measurements at frequency 0.009MHz up to 1GHz. For frequencies above 1GHz, any suitable measuring distance may be used.
- b. The EUT was placed on the top of a rotating table 0.8 meters(above 1GHz is 1.5 m) above the ground at a 3 meter anechoic chamber. The table was rotated 360 degrees to determine the position of the highest radiation.
- c. The height of the equipment shall be 0.8 m(above 1GHz is 1.5 m); the height of the test antenna shall vary between 1 m to 4 m. Horizontal and vertical polarizations of the antenna are set to make the measurement
- d. The initial step in collecting conducted emission data is a spectrum analyzer peak detector mode pre-scanning the measurement frequency range. Significant peaks are then marked and then Quasi Peak detector mode re-measured.
- e. If the Peak Mode measured value compliance with and lower than Quasi Peak Mode Limit, the EUT shall be deemed to meet QP Limits and then no additional QP Mode measurement performed.
- f. For the actual test configuration, please refer to the related Item –EUT Test Photos.

Note:

Both horizontal and vertical antenna polarities were tested and performed test to three orthogonal axis. The worst case emissions were reported

3.2.2 DEVIATION FROM TEST STANDARD

No deviation

3.2.3 TEST SETUP

(A) Radiated Emission Test-Up Frequency Below 30MHz

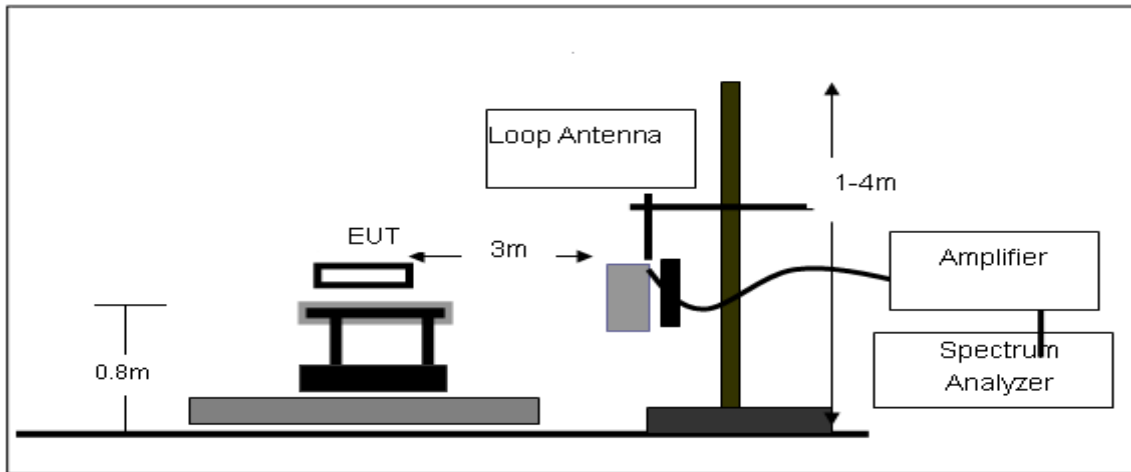

(B) Radiated Emission Test-Up Frequency 30MHz~1GHz

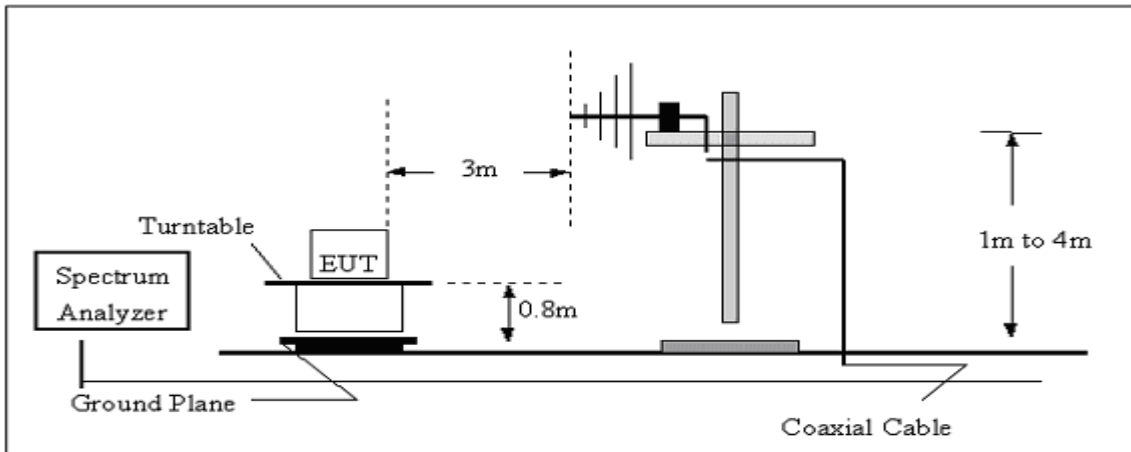

(C) Radiated Emission Test-Up Frequency Above 1GHz

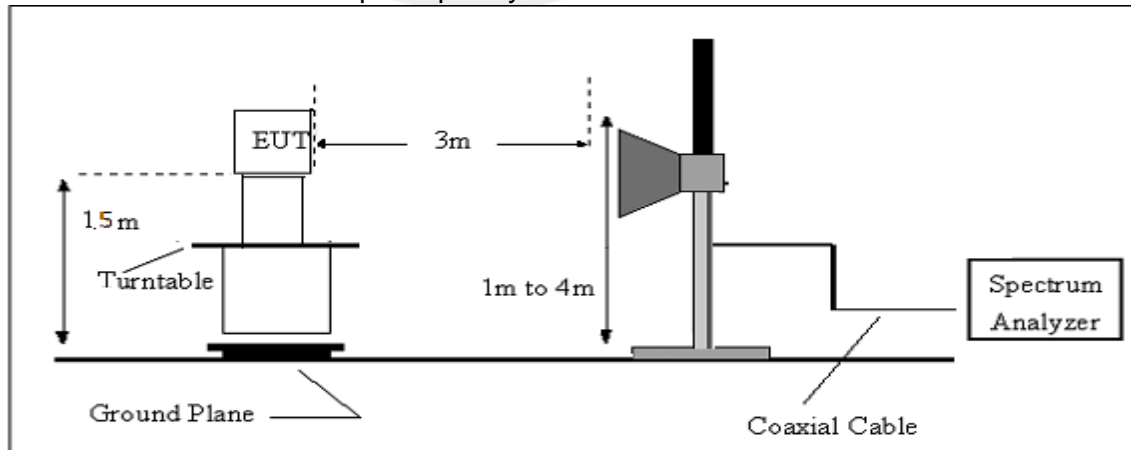

3.2.4 EUT OPERATING CONDITIONS

The EUT tested system was configured as the statements of 2.4 Unless otherwise a special operating condition is specified in the follows during the testing.



3.2.5 TEST RESULTS (BETWEEN 9KHZ – 30 MHZ)

Temperature:	24 °C	Relative Humidity:	57%
Pressure:	1010 hPa	Test Voltage :	DC 5V from PC
Test Mode :	TX Mode	Polarization :	--

Freq. (MHz)	Reading (dBuV/m)	Limit (dBuV/m)	Margin (dB)	State P/F
--	--	--	--	PASS
--	--	--	--	PASS

Note:

The amplitude of spurious emissions which are attenuated by more than 20dB below the permissible value has no need to be reported.

Distance extrapolation factor = $40 \log (\text{specific distance}/\text{test distance})$ (dB);

Limit line = specific limits(dBuv) + distance extrapolation factor.



3.2.6 TEST RESULTS (BETWEEN 30MHZ – 1GHZ)

Temperature	24 °C	Relative Humidity	57%
Pressure	1010 hPa	Test Voltage	DC 5V from PC
Test Mode	Mode 1-12(Mode 1-6M worst mode)	Polarization	Horizontal

Frequency (MHz)	Reading (dBUV)	Correct Factor(dB/m)	Result (dBUV/m)	Limit (dBUV/m)	Margin (dB)	Remark
48.8430	42.90	20.89	22.01	40.00	-17.99	QP
95.7622	41.51	-19.61	21.90	43.50	-21.60	QP
235.8164	45.44	-18.06	27.38	46.00	-18.62	QP
302.4812	37.86	-14.75	23.11	46.00	-22.89	QP
470.5232	38.50	-9.75	28.75	46.00	-17.25	QP
651.9417	40.79	-6.29	34.50	46.00	-11.50	QP

Remark:

1. Margin = Result (Result =Reading + Factor)–Limit

80.0 dBUV/m

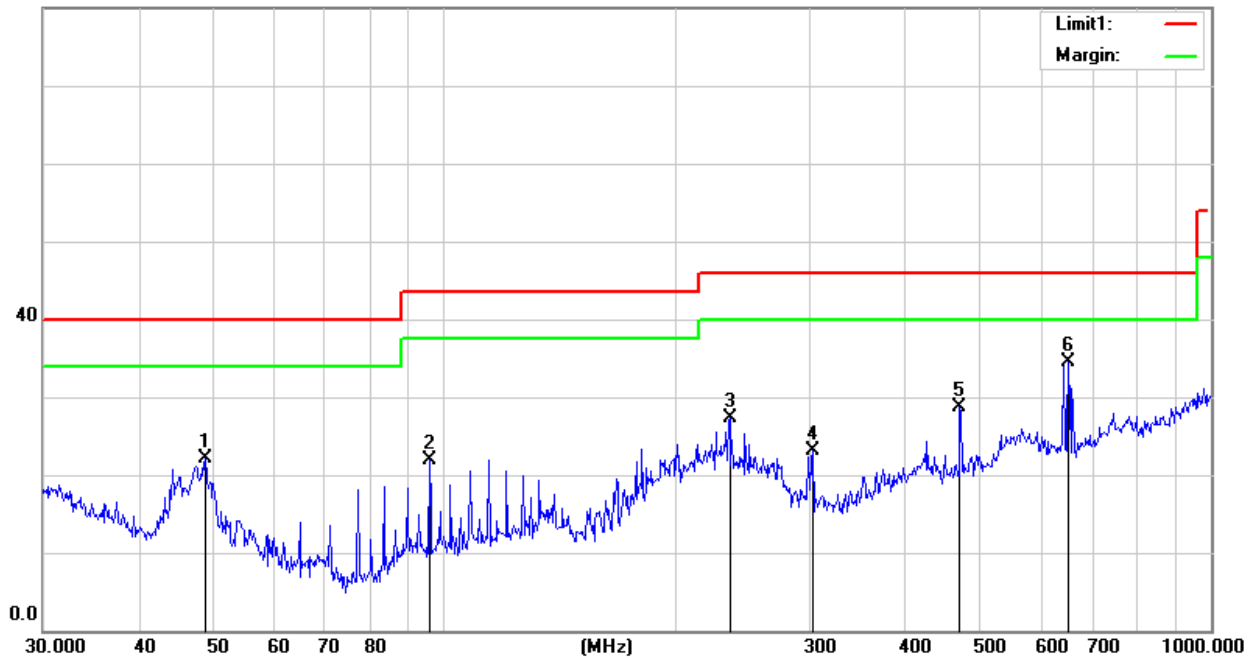



Temperature	25°C	Relative Humidity	58%
Pressure	1010 hPa	Test Voltage	DC 5V from PC
Test Mode	Mode 1-12(Mode 1-6M worst mode)	Polarization	Vertical

Frequency (MHz)	Reading (dBUV)	Correct Factor(dB/m)	Result (dBUV/m)	Limit (dBUV/m)	Margin (dB)	Remark
42.7496	45.24	-17.75	27.49	40.00	-12.51	QP
177.5092	42.93	-19.41	23.52	43.50	-19.98	QP
235.8164	44.86	-18.06	26.80	46.00	-19.20	QP
470.5232	40.65	-9.75	30.90	46.00	-15.10	QP
651.9417	42.42	-6.29	36.13	46.00	-9.87	QP
903.3094	40.19	-2.14	38.05	46.00	-7.95	QP

Remark:

1. Margin = Result (Result =Reading + Factor)–Limit

80.0 dBUV/m

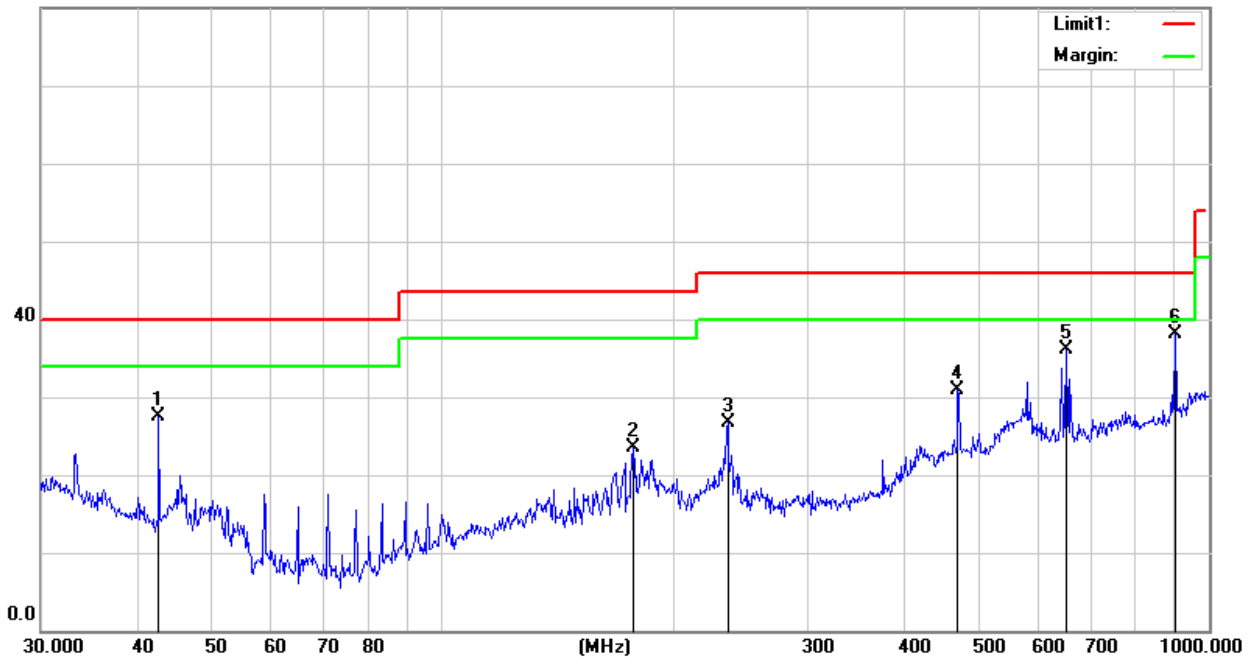



3.2.7 TEST RESULTS (ABOVE 1000 MHZ)

Band I 5150-5250MHz

Band I(5.15-5.25) GHz										
Frequency (MHz)	Reading	Amplifier	Loss	Antenna	Corrected	Emission	Limit (dBuV/m)	Margin	Detector	Comment
	(dBuV)	(dB)	(dB)	(dB/m)	Factor	Level (dBuV/m)		(dB)		
Low Channel (802.11a/ 5180 MHz)										
3253.75	44.62	44.70	6.70	28.20	-9.80	34.82	74.00	-39.18	PK	Vertical
3253.75	41.22	44.70	6.70	28.20	-9.80	31.42	54.00	-22.58	AV	Vertical
3258.29	43.83	44.70	6.70	28.20	-9.80	34.03	74.00	-39.97	PK	Horizontal
3258.29	41.15	44.70	6.70	28.20	-9.80	31.35	54.00	-22.65	AV	Horizontal
3988.45	39.26	44.20	7.90	29.70	-6.60	32.66	74.00	-41.34	PK	Vertical
3988.45	36.17	44.20	7.90	29.70	-6.60	29.57	54.00	-24.43	AV	Vertical
3982.00	39.14	44.20	7.90	29.70	-6.60	32.54	74.00	-41.46	PK	Horizontal
3982.00	35.67	44.20	7.90	29.70	-6.60	29.07	54.00	-24.93	AV	Horizontal
7223.35	36.76	43.50	11.40	35.50	3.40	40.16	74.00	-33.84	PK	Vertical
7223.35	34.70	43.50	11.40	35.50	3.40	38.10	54.00	-15.90	AV	Vertical
7225.71	37.05	43.50	11.40	35.50	3.40	40.45	74.00	-33.55	PK	Horizontal
7225.71	34.18	43.50	11.40	35.50	3.40	37.58	54.00	-16.42	AV	Horizontal
10360.33	39.69	44.50	13.80	38.80	8.10	47.79	74.00	-26.21	PK	Vertical
10360.33	37.08	44.50	13.80	38.80	8.10	45.18	54.00	-8.82	AV	Vertical
10360.29	39.92	44.50	13.80	38.80	8.10	48.02	74.00	-25.98	PK	Horizontal
10360.29	37.15	44.50	13.80	38.80	8.10	45.25	54.00	-8.75	AV	Horizontal
11034.29	33.02	43.60	14.30	39.50	10.20	43.22	74.00	-30.78	PK	Vertical
11034.29	31.00	43.60	14.30	39.50	10.20	41.20	54.00	-12.80	AV	Vertical
11022.60	33.05	43.60	14.30	39.50	10.20	43.25	74.00	-30.75	PK	Horizontal
11022.60	30.76	43.60	14.30	39.50	10.20	40.96	54.00	-13.04	AV	Horizontal
13288.83	32.63	42.60	15.90	38.90	12.20	44.83	74.00	-29.17	PK	Vertical
13288.83	29.58	42.60	15.90	38.90	12.20	41.78	54.00	-12.22	AV	Vertical
13284.02	31.61	42.60	15.90	38.90	12.20	43.81	74.00	-30.19	PK	Horizontal
13284.02	29.83	42.60	15.90	38.90	12.20	42.03	54.00	-11.97	AV	Horizontal
15539.95	31.09	44.10	17.81	39.20	12.91	44.00	74.00	-30.00	PK	Vertical
15539.95	26.92	44.10	17.81	39.20	12.91	39.83	54.00	-14.17	AV	Vertical
15539.99	30.53	44.10	17.81	39.20	12.91	43.44	74.00	-30.56	PK	Horizontal
15539.99	27.93	44.10	17.81	39.20	12.91	40.84	54.00	-13.16	AV	Horizontal



Mid Channel (802.11 a/ 5200 MHz)										
3261.26	44.63	44.70	6.70	28.20	-9.80	34.83	74.00	-39.17	PK	Vertical
3261.26	41.83	44.70	6.70	28.20	-9.80	32.03	54.00	-21.97	AV	Vertical
3251.75	44.24	44.70	6.70	28.20	-9.80	34.44	74.00	-39.56	PK	Horizontal
3251.75	41.93	44.70	6.70	28.20	-9.80	32.13	54.00	-21.87	AV	Horizontal
3999.10	38.70	44.20	7.90	29.70	-6.60	32.10	74.00	-41.90	PK	Vertical
3999.10	36.64	44.20	7.90	29.70	-6.60	30.04	54.00	-23.96	AV	Vertical
3980.81	39.07	44.20	7.90	29.70	-6.60	32.47	74.00	-41.53	PK	Horizontal
3980.81	36.53	44.20	7.90	29.70	-6.60	29.93	54.00	-24.07	AV	Horizontal
7217.98	36.94	43.50	11.40	35.50	3.40	40.34	74.00	-33.66	PK	Vertical
7217.98	34.55	43.50	11.40	35.50	3.40	37.95	54.00	-16.05	AV	Vertical
7223.15	36.53	43.50	11.40	35.50	3.40	39.93	74.00	-34.07	PK	Horizontal
7223.15	33.79	43.50	11.40	35.50	3.40	37.19	54.00	-16.81	AV	Horizontal
10400.01	39.44	44.50	13.80	38.80	8.10	47.54	74.00	-26.46	PK	Vertical
10400.01	36.63	44.50	13.80	38.80	8.10	44.73	54.00	-9.27	AV	Vertical
10400.05	38.81	44.50	13.80	38.80	8.10	46.91	74.00	-27.09	PK	Horizontal
10400.05	37.14	44.50	13.80	38.80	8.10	45.24	54.00	-8.76	AV	Horizontal
11022.51	33.05	43.60	14.30	39.50	10.20	43.25	74.00	-30.75	PK	Vertical
11022.51	30.12	43.60	14.30	39.50	10.20	40.32	54.00	-13.68	AV	Vertical
11020.54	32.70	43.60	14.30	39.50	10.20	42.90	74.00	-31.10	PK	Horizontal
11020.54	29.83	43.60	14.30	39.50	10.20	40.03	54.00	-13.97	AV	Horizontal
13284.86	32.91	42.60	15.90	38.90	12.20	45.11	74.00	-28.89	PK	Vertical
13284.86	29.64	42.60	15.90	38.90	12.20	41.84	54.00	-12.16	AV	Vertical
13291.99	33.00	42.60	15.90	38.90	12.20	45.20	74.00	-28.80	PK	Horizontal
13291.99	28.94	42.60	15.90	38.90	12.20	41.14	54.00	-12.86	AV	Horizontal
15600.23	31.09	42.70	18.00	37.10	12.40	43.49	74.00	-30.51	PK	Vertical
15600.23	26.75	42.70	18.00	37.10	12.40	39.15	54.00	-14.85	AV	Vertical
15600.14	30.11	42.70	18.00	37.10	12.40	42.51	74.00	-31.49	PK	Horizontal
15600.14	26.96	42.70	18.00	37.10	12.40	39.36	54.00	-14.64	AV	Horizontal
17987.32	26.87	42.70	19.40	46.50	23.20	50.07	74.00	-23.93	PK	Vertical
17987.32	24.87	42.70	19.40	46.50	23.20	48.07	54.00	-5.93	AV	Vertical
17998.24	26.85	42.70	19.40	46.50	23.20	50.05	74.00	-23.95	PK	Horizontal
17998.24	20.05	42.70	19.40	46.50	23.20	43.25	54.00	-10.75	AV	Horizontal



High Channel (802.11 a/ 5240 MHz)										
3262.20	45.17	44.70	6.70	28.20	-9.80	35.37	74.00	-38.63	PK	Vertical
3262.20	41.66	44.70	6.70	28.20	-9.80	31.86	54.00	-22.14	AV	Vertical
3250.50	44.91	44.70	6.70	28.20	-9.80	35.11	74.00	-38.89	PK	Horizontal
3250.50	42.08	44.70	6.70	28.20	-9.80	32.28	54.00	-21.72	AV	Horizontal
3996.68	38.93	44.20	7.90	29.70	-6.60	32.33	74.00	-41.67	PK	Vertical
3996.68	36.12	44.20	7.90	29.70	-6.60	29.52	54.00	-24.48	AV	Vertical
3999.74	38.97	44.20	7.90	29.70	-6.60	32.37	74.00	-41.63	PK	Horizontal
3999.74	36.84	44.20	7.90	29.70	-6.60	30.24	54.00	-23.76	AV	Horizontal
7234.89	36.80	43.50	11.40	35.50	3.40	40.20	74.00	-33.80	PK	Vertical
7234.89	34.06	43.50	11.40	35.50	3.40	37.46	54.00	-16.54	AV	Vertical
7223.95	37.58	43.50	11.40	35.50	3.40	40.98	74.00	-33.02	PK	Horizontal
7223.95	33.94	43.50	11.40	35.50	3.40	37.34	54.00	-16.66	AV	Horizontal
10480.03	39.43	44.50	13.80	38.80	8.10	47.53	74.00	-26.47	PK	Vertical
10480.03	37.06	44.50	13.80	38.80	8.10	45.16	54.00	-8.84	AV	Vertical
10480.40	39.88	44.50	13.80	38.80	8.10	47.98	74.00	-26.02	PK	Horizontal
10480.40	36.14	44.50	13.80	38.80	8.10	44.24	54.00	-9.76	AV	Horizontal
11032.67	33.03	43.60	14.30	39.50	10.20	43.23	74.00	-30.77	PK	Vertical
11032.67	30.93	43.60	14.30	39.50	10.20	41.13	54.00	-12.87	AV	Vertical
11033.16	33.75	43.60	14.30	39.50	10.20	43.95	74.00	-30.05	PK	Horizontal
11033.16	31.07	43.60	14.30	39.50	10.20	41.27	54.00	-12.73	AV	Horizontal
13284.22	32.05	42.60	15.90	38.90	12.20	44.25	74.00	-29.75	PK	Vertical
13284.22	29.44	42.60	15.90	38.90	12.20	41.64	54.00	-12.36	AV	Vertical
13295.65	32.27	42.60	15.90	38.90	12.20	44.47	74.00	-29.53	PK	Horizontal
13295.65	29.60	42.60	15.90	38.90	12.20	41.80	54.00	-12.20	AV	Horizontal
15719.87	31.09	42.70	19.40	46.50	23.20	54.29	74.00	-19.71	PK	Vertical
15719.87	27.42	42.70	19.40	46.50	23.20	50.62	54.00	-3.38	AV	Vertical
15720.11	30.84	42.70	19.40	46.50	23.20	54.04	74.00	-19.96	PK	Horizontal
15720.11	26.58	42.70	19.40	46.50	23.20	49.78	54.00	-4.22	AV	Horizontal

Remark:

1. Factor = Antenna Factor + Cable Loss – Pre-amplifier.
2. Scan with 802.11a, 802.11n (HT-20), 802.11n (HT-40), 802.11ac (HT-20), 802.11ac (HT-40), 802.11ac (HT-80) the worst case is 802.11a.
3. The frequency emission of peak points that did not show above the forms are at least 20dB below the limit, the frequency emission is mainly from the environment noise.



Band IV(5.725-5.850) GHz

Band IV(5.725-5.85) GHz										
Frequency (MHz)	Reading	Amplifier	Loss	Antenna	Corrected	Emission	Limit (dBuV/m)	Margin	Detector	Comment
	(dBuV)	(dB)	(dB)	(dB/m)	Factor	Level (dBμV/m)		(dB)		
Low Channel (802.11 a/ 5745 MHz)										
3252.72	43.86	44.70	6.70	28.20	-9.80	34.06	74.00	-39.94	PK	Vertical
3252.72	41.40	44.70	6.70	28.20	-9.80	31.60	54.00	-22.40	AV	Vertical
3256.96	44.34	44.70	6.70	28.20	-9.80	34.54	74.00	-39.46	PK	Horizontal
3256.96	41.73	44.70	6.70	28.20	-9.80	31.93	54.00	-22.07	AV	Horizontal
3982.14	40.05	44.20	7.90	29.70	-6.60	33.45	74.00	-40.55	PK	Vertical
3982.14	36.80	44.20	7.90	29.70	-6.60	30.20	54.00	-23.80	AV	Vertical
3990.90	39.34	44.20	7.90	29.70	-6.60	32.74	74.00	-41.26	PK	Horizontal
3990.90	36.74	44.20	7.90	29.70	-6.60	30.14	54.00	-23.86	AV	Horizontal
7231.34	36.65	43.50	11.40	35.50	3.40	40.05	74.00	-33.95	PK	Vertical
7231.34	34.06	43.50	11.40	35.50	3.40	37.46	54.00	-16.54	AV	Vertical
7219.57	37.01	43.50	11.40	35.50	3.40	40.41	74.00	-33.59	PK	Horizontal
7219.57	33.64	43.50	11.40	35.50	3.40	37.04	54.00	-16.96	AV	Horizontal
10502.37	39.20	44.50	13.90	38.80	8.20	47.40	74.00	-26.60	PK	Vertical
10502.37	36.86	44.50	13.90	38.80	8.20	45.06	54.00	-8.94	AV	Vertical
10502.87	39.01	44.50	13.90	38.80	8.20	47.21	74.00	-26.79	PK	Horizontal
10502.87	36.35	44.50	13.90	38.80	8.20	44.55	54.00	-9.45	AV	Horizontal
11400.41	34.01	43.60	14.30	39.50	10.20	44.21	74.00	-29.79	PK	Vertical
11400.41	30.55	43.60	14.30	39.50	10.20	40.75	54.00	-13.25	AV	Vertical
11400.37	32.93	43.60	14.30	39.50	10.20	43.13	74.00	-30.87	PK	Horizontal
11400.37	30.54	43.60	14.30	39.50	10.20	40.74	54.00	-13.26	AV	Horizontal
13292.07	31.79	42.60	15.90	38.90	12.20	43.99	74.00	-30.01	PK	Vertical
13292.07	29.29	42.60	15.90	38.90	12.20	41.49	54.00	-12.51	AV	Vertical
13299.83	32.35	42.60	15.90	38.90	12.20	44.55	74.00	-29.45	PK	Horizontal
13299.83	28.59	42.60	15.90	38.90	12.20	40.79	54.00	-13.21	AV	Horizontal
15779.97	31.09	42.70	18.00	37.10	12.40	43.49	74.00	-30.51	PK	Vertical
15779.97	27.42	42.70	18.00	37.10	12.40	39.82	54.00	-14.18	AV	Vertical
15780.18	30.13	42.70	18.00	37.10	12.40	42.53	74.00	-31.47	PK	Horizontal
15780.18	27.92	42.70	18.00	37.10	12.40	40.32	54.00	-13.68	AV	Horizontal
17235.33	28.17	42.70	19.40	46.50	23.20	51.37	74.00	-22.63	PK	Vertical
17235.33	24.87	42.70	19.40	46.50	23.20	48.07	54.00	-5.93	AV	Vertical
17235.12	27.44	42.70	19.40	46.50	23.20	50.64	74.00	-23.36	PK	Horizontal
17235.12	19.25	42.70	19.40	46.50	23.20	42.45	54.00	-11.55	AV	Horizontal



Mid Channel (802.11 a/ 5785 MHz)										
3248.25	44.36	44.70	6.70	28.20	-9.80	34.56	74.00	-39.44	PK	Vertical
3248.25	41.55	44.70	6.70	28.20	-9.80	31.75	54.00	-22.25	AV	Vertical
3246.63	44.63	44.70	6.70	28.20	-9.80	34.83	74.00	-39.17	PK	Horizontal
3246.63	42.23	44.70	6.70	28.20	-9.80	32.43	54.00	-21.57	AV	Horizontal
3981.10	38.76	44.20	7.90	29.70	-6.60	32.16	74.00	-41.84	PK	Vertical
3981.10	37.15	44.20	7.90	29.70	-6.60	30.55	54.00	-23.45	AV	Vertical
3980.59	39.40	44.20	7.90	29.70	-6.60	32.80	74.00	-41.20	PK	Horizontal
3980.59	36.30	44.20	7.90	29.70	-6.60	29.70	54.00	-24.30	AV	Horizontal
7226.04	37.54	43.50	11.40	35.50	3.40	40.94	74.00	-33.06	PK	Vertical
7226.04	34.60	43.50	11.40	35.50	3.40	38.00	54.00	-16.00	AV	Vertical
7228.42	37.36	43.50	11.40	35.50	3.40	40.76	74.00	-33.24	PK	Horizontal
7228.42	34.38	43.50	11.40	35.50	3.40	37.78	54.00	-16.22	AV	Horizontal
10596.64	39.06	44.50	13.80	38.80	8.10	47.16	74.00	-26.84	PK	Vertical
10596.64	36.76	44.50	13.80	38.80	8.10	44.86	54.00	-9.14	AV	Vertical
10581.90	40.01	44.50	13.80	38.80	8.10	48.11	74.00	-25.89	PK	Horizontal
10581.90	36.77	44.50	13.80	38.80	8.10	44.87	54.00	-9.13	AV	Horizontal
11569.97	33.21	43.60	14.30	39.50	10.20	43.41	74.00	-30.59	PK	Vertical
11569.97	30.80	43.60	14.30	39.50	10.20	41.00	54.00	-13.00	AV	Vertical
11570.17	33.99	43.60	14.30	39.50	10.20	44.19	74.00	-29.81	PK	Horizontal
11570.17	30.55	43.60	14.30	39.50	10.20	40.75	54.00	-13.25	AV	Horizontal
13283.13	32.13	42.60	15.90	38.90	12.20	44.33	74.00	-29.67	PK	Vertical
13283.13	28.62	42.60	15.90	38.90	12.20	40.82	54.00	-13.18	AV	Vertical
13292.83	32.69	42.60	15.90	38.90	12.20	44.89	74.00	-29.11	PK	Horizontal
13292.83	29.03	42.60	15.90	38.90	12.20	41.23	54.00	-12.77	AV	Horizontal
15893.12	31.09	42.70	18.00	37.10	12.40	43.49	74.00	-30.51	PK	Vertical
15893.12	27.98	42.70	18.00	37.10	12.40	40.38	54.00	-13.62	AV	Vertical
15597.97	29.57	42.70	18.00	37.10	12.40	41.97	74.00	-32.03	PK	Horizontal
15597.97	27.07	42.70	18.00	37.10	12.40	39.47	54.00	-14.53	AV	Horizontal
17355.31	28.14	41.80	19.20	42.80	20.20	48.34	74.00	-25.66	PK	Vertical
17355.31	26.08	41.80	19.20	42.80	20.20	46.28	54.00	-7.72	AV	Vertical
17355.25	26.83	41.80	19.20	42.80	20.20	47.03	74.00	-26.97	PK	Horizontal
17355.25	19.97	41.80	19.20	42.80	20.20	40.17	54.00	-13.83	AV	Horizontal



High Channel (802.11 a/ 5825 MHz)										
3253.90	44.22	44.70	6.70	28.20	-9.80	34.42	74.00	-39.58	PK	Vertical
3253.90	41.22	44.70	6.70	28.20	-9.80	31.42	54.00	-22.58	AV	Vertical
3248.78	44.20	44.70	6.70	28.20	-9.80	34.40	74.00	-39.60	PK	Horizontal
3248.78	41.67	44.70	6.70	28.20	-9.80	31.87	54.00	-22.13	AV	Horizontal
3995.52	39.29	44.20	7.90	29.70	-6.60	32.69	74.00	-41.31	PK	Vertical
3995.52	36.30	44.20	7.90	29.70	-6.60	29.70	54.00	-24.30	AV	Vertical
3997.29	40.10	44.20	7.90	29.70	-6.60	33.50	74.00	-40.50	PK	Horizontal
3997.29	36.35	44.20	7.90	29.70	-6.60	29.75	54.00	-24.25	AV	Horizontal
7223.95	37.45	43.50	11.40	35.50	3.40	40.85	74.00	-33.15	PK	Vertical
7223.95	33.74	43.50	11.40	35.50	3.40	37.14	54.00	-16.86	AV	Vertical
7234.37	37.48	43.50	11.40	35.50	3.40	40.88	74.00	-33.12	PK	Horizontal
7234.37	34.27	43.50	11.40	35.50	3.40	37.67	54.00	-16.33	AV	Horizontal
10639.69	39.20	44.50	13.80	38.80	8.10	47.30	74.00	-26.70	PK	Vertical
10639.69	36.41	44.50	13.80	38.80	8.10	44.51	54.00	-9.49	AV	Vertical
10640.28	39.26	44.50	13.80	38.80	8.10	47.36	74.00	-26.64	PK	Horizontal
10640.28	35.96	44.50	13.80	38.80	8.10	44.06	54.00	-9.94	AV	Horizontal
11650.25	34.08	43.60	14.30	39.50	10.20	44.28	74.00	-29.72	PK	Vertical
11650.25	30.02	43.60	14.30	39.50	10.20	40.22	54.00	-13.78	AV	Vertical
11650.16	34.02	43.60	14.30	39.50	10.20	44.22	74.00	-29.78	PK	Horizontal
11650.16	30.46	43.60	14.30	39.50	10.20	40.66	54.00	-13.34	AV	Horizontal
13296.81	31.87	42.70	18.00	37.10	12.40	44.27	74.00	-29.73	PK	Vertical
13296.81	29.37	42.70	18.00	37.10	12.40	41.77	54.00	-12.23	AV	Vertical
13288.80	31.65	42.70	18.00	37.10	12.40	44.05	74.00	-29.95	PK	Horizontal
13288.80	29.06	42.70	18.00	37.10	12.40	41.46	54.00	-12.54	AV	Horizontal
17474.89	31.09	41.80	19.20	42.80	20.20	51.29	74.00	-22.71	PK	Vertical
17474.89	26.97	41.80	19.20	42.80	20.20	47.17	54.00	-6.83	AV	Vertical
17475.09	30.90	41.80	19.20	42.80	20.20	51.10	74.00	-22.90	PK	Horizontal
17475.09	27.04	41.80	19.20	42.80	20.20	47.24	54.00	-6.76	AV	Horizontal

Remark:

1. Factor = Antenna Factor + Cable Loss – Pre-amplifier.
2. Scan with 802.11a,802.11n (HT-20),802.11n (HT-40), 802.11ac (HT-20),802.11ac (HT-40), 802.11ac (HT-80) the worst case is 802.11a.
3. The frequency emission of peak points that did not show above the forms are at least 20dB below the limit, the frequency emission is mainly from the environment noise.



3.2.8 BAND EDGE

Band I (5.15-5.35)GHz

Band I(5.15-5.35) GHz										
Frequency	Meter Reading	Amplifier	Loss	Antenna Factor	Corrected Factor	Emission Level	Limits	Margin	Detector	Comment
(MHz)	(dBμV)	(dB)	(dB)	(dB/m)	(dB)	(dBμV/m)	(dBμV/m)	(dB)	Type	
802.11a BW20MHz										
5150	39.04	44.20	8.98	31.60	-3.62	35.42	74.00	-38.58	Peak	Vertical
5150	30.11	44.20	8.98	31.60	-3.62	26.49	54.00	-27.51	AVG	Vertical
5150	41.74	44.20	8.98	31.60	-3.62	38.12	74.00	-35.88	Peak	Horizontal
5150	31.81	44.20	8.98	31.60	-3.62	28.19	54.00	-25.81	AVG	Horizontal
5350	43.85	44.20	9.35	31.60	-3.25	40.60	74.00	-33.40	Peak	Vertical
5350	27.64	44.20	9.35	31.60	-3.25	24.39	54.00	-29.61	AVG	Vertical
5350	40.86	44.20	9.35	31.60	-3.25	37.61	74.00	-36.39	Peak	Horizontal
5350	31.52	44.20	9.35	31.60	-3.25	28.27	54.00	-25.73	AVG	Horizontal
802.11n BW20MHz										
5150	38.98	44.20	8.98	31.60	-3.62	35.36	74.00	-38.64	Peak	Vertical
5150	28.96	44.20	8.98	31.60	-3.62	25.34	54.00	-28.66	AVG	Vertical
5150	41.37	44.20	8.98	31.60	-3.62	37.75	74.00	-36.25	Peak	Horizontal
5150	27.96	44.20	8.98	31.60	-3.62	24.34	54.00	-29.66	AVG	Horizontal
5350	44.27	44.20	9.35	31.60	-3.25	41.02	74.00	-32.98	Peak	Vertical
5350	30.22	44.20	9.35	31.60	-3.25	26.97	54.00	-27.03	AVG	Vertical
5350	38.34	44.20	9.35	31.60	-3.25	35.09	74.00	-38.91	Peak	Horizontal
5350	31.95	44.20	9.35	31.60	-3.25	28.70	54.00	-25.30	AVG	Horizontal
802.11n BW40MHz										
5150	40.43	44.20	8.98	31.60	-3.62	36.81	74.00	-37.19	Peak	Vertical
5150	29.56	44.20	8.98	31.60	-3.62	25.94	54.00	-28.06	AVG	Vertical
5150	40.84	44.20	8.98	31.60	-3.62	37.22	74.00	-36.78	Peak	Horizontal
5150	29.34	44.20	8.98	31.60	-3.62	25.72	54.00	-28.28	AVG	Horizontal
5350	44.49	44.20	9.35	31.60	-3.25	41.24	74.00	-32.76	Peak	Vertical
5350	28.50	44.20	9.35	31.60	-3.25	25.25	54.00	-28.75	AVG	Vertical
5350	39.83	44.20	9.35	31.60	-3.25	36.58	74.00	-37.42	Peak	Horizontal
5350	30.03	44.20	9.35	31.60	-3.25	26.78	54.00	-27.22	AVG	Horizontal



802.11ac BW20MHz										
5150	38.96	44.20	8.98	31.60	-3.62	35.34	74.00	-38.66	Peak	Vertical
5150	31.47	44.20	8.98	31.60	-3.62	27.85	54.00	-26.15	AVG	Vertical
5150	38.58	44.20	8.98	31.60	-3.62	34.96	74.00	-39.04	Peak	Horizontal
5150	30.83	44.20	8.98	31.60	-3.62	27.21	54.00	-26.79	AVG	Horizontal
5350	45.15	44.20	9.35	31.60	-3.25	41.90	74.00	-32.10	Peak	Vertical
5350	31.69	44.20	9.35	31.60	-3.25	28.44	54.00	-25.56	AVG	Vertical
5350	39.47	44.20	9.35	31.60	-3.25	36.22	74.00	-37.78	Peak	Horizontal
5350	31.20	44.20	9.35	31.60	-3.25	27.95	54.00	-26.05	AVG	Horizontal
802.11ac BW40MHz										
5150	40.72	44.20	8.98	31.60	-3.62	37.10	74.00	-36.90	Peak	Vertical
5150	29.57	44.20	8.98	31.60	-3.62	25.95	54.00	-28.05	AVG	Vertical
5150	38.04	44.20	8.98	31.60	-3.62	34.42	74.00	-39.58	Peak	Horizontal
5150	28.23	44.20	8.98	31.60	-3.62	24.61	54.00	-29.39	AVG	Horizontal
5350	45.46	44.20	9.35	31.60	-3.25	42.21	74.00	-31.79	Peak	Vertical
5350	28.70	44.20	9.35	31.60	-3.25	25.45	54.00	-28.55	AVG	Vertical
5350	39.28	44.20	9.35	31.60	-3.25	36.03	74.00	-37.97	Peak	Horizontal
5350	28.49	44.20	9.35	31.60	-3.25	25.24	54.00	-28.76	AVG	Horizontal
802.11ac BW80MHz										
5150	39.39	44.20	8.98	31.60	-3.62	35.77	74.00	-38.23	Peak	Vertical
5150	30.07	44.20	8.98	31.60	-3.62	26.45	54.00	-27.55	AVG	Vertical
5150	42.02	44.20	8.98	31.60	-3.62	38.40	74.00	-35.60	Peak	Horizontal
5150	28.50	44.20	8.98	31.60	-3.62	24.88	54.00	-29.12	AVG	Horizontal
5350	46.40	44.20	9.35	31.60	-3.25	43.15	74.00	-30.85	Peak	Vertical
5350	31.21	44.20	9.35	31.60	-3.25	27.96	54.00	-26.04	AVG	Vertical
5350	39.92	44.20	9.35	31.60	-3.25	36.67	74.00	-37.33	Peak	Horizontal
5350	27.69	44.20	9.35	31.60	-3.25	24.44	54.00	-29.56	AVG	Horizontal

**Band IV(5.725-5.85 GHz)**

Band IV(5.725-5.85 GHz)										
Frequency	Meter Reading	Amplifier	Loss	Antenna Factor	Corrected Factor	Emission Level	Limits	Margin	Detector	Comment
(MHz)	(dB μ V)	(dB)	(dB)	(dB/m)	(dB)	(dB μ V/m)	(dB μ V/m)	(dB)	Type	
802.11a BW20MHz										
5725	39.11	44.20	10.00	32.00	-2.20	36.91	74.00	-37.09	Peak	Vertical
5725	30.90	44.20	10.00	32.00	-2.20	28.70	54.00	-25.30	AVG	Vertical
5725	42.24	44.20	10.00	32.00	-2.20	40.04	74.00	-33.96	Peak	Horizontal
5725	29.26	44.20	10.00	32.00	-2.20	27.06	54.00	-26.94	AVG	Horizontal
5850	45.71	44.20	10.20	32.00	-2.00	43.71	74.00	-30.29	Peak	Vertical
5850	29.09	44.20	10.20	32.00	-2.00	27.09	54.00	-26.91	AVG	Vertical
5850	41.18	44.20	10.20	32.00	-2.00	39.18	74.00	-34.82	Peak	Horizontal
5850	29.03	44.20	10.20	32.00	-2.00	27.03	54.00	-26.97	AVG	Horizontal
802.11n BW20MHz										
5725	39.67	44.20	10.00	32.00	-2.20	37.47	74.00	-36.53	Peak	Vertical
5725	30.99	44.20	10.00	32.00	-2.20	28.79	54.00	-25.21	AVG	Vertical
5725	40.26	44.20	10.00	32.00	-2.20	38.06	74.00	-35.94	Peak	Horizontal
5725	29.85	44.20	10.00	32.00	-2.20	27.65	54.00	-26.35	AVG	Horizontal
5850	43.31	44.20	10.20	32.00	-2.00	41.31	74.00	-32.69	Peak	Vertical
5850	28.48	44.20	10.20	32.00	-2.00	26.48	54.00	-27.52	AVG	Vertical
5850	41.57	44.20	10.20	32.00	-2.00	39.57	74.00	-34.43	Peak	Horizontal
5850	29.84	44.20	10.20	32.00	-2.00	27.84	54.00	-26.16	AVG	Horizontal
802.11n BW40MHz										
5725	41.42	44.20	10.00	32.00	-2.20	39.22	74.00	-34.78	Peak	Vertical
5725	30.20	44.20	10.00	32.00	-2.20	28.00	54.00	-26.00	AVG	Vertical
5725	41.23	44.20	10.00	32.00	-2.20	39.03	74.00	-34.97	Peak	Horizontal
5725	31.60	44.20	10.00	32.00	-2.20	29.40	54.00	-24.60	AVG	Horizontal
5850	46.18	44.20	10.20	32.00	-2.00	44.18	74.00	-29.82	Peak	Vertical
5850	28.74	44.20	10.20	32.00	-2.00	26.74	54.00	-27.26	AVG	Vertical
5850	41.73	44.20	10.20	32.00	-2.00	39.73	74.00	-34.27	Peak	Horizontal
5850	30.38	44.20	10.20	32.00	-2.00	28.38	54.00	-25.62	AVG	Horizontal



802.11ac BW20MHz										
5725	40.30	44.20	10.00	32.00	-2.20	38.10	74.00	-35.90	Peak	Vertical
5725	29.86	44.20	10.00	32.00	-2.20	27.66	54.00	-26.34	AVG	Vertical
5725	38.21	44.20	10.00	32.00	-2.20	36.01	74.00	-37.99	Peak	Horizontal
5725	30.65	44.20	10.00	32.00	-2.20	28.45	54.00	-25.55	AVG	Horizontal
5850	46.54	44.20	10.20	32.00	-2.00	44.54	74.00	-29.46	Peak	Vertical
5850	31.01	44.20	10.20	32.00	-2.00	29.01	54.00	-24.99	AVG	Vertical
5850	38.82	44.20	10.20	32.00	-2.00	36.82	74.00	-37.18	Peak	Horizontal
5850	29.18	44.20	10.20	32.00	-2.00	27.18	54.00	-26.82	AVG	Horizontal
802.11ac BW40MHz										
5725	40.17	44.20	10.00	32.00	-2.20	37.97	74.00	-36.03	Peak	Vertical
5725	31.65	44.20	10.00	32.00	-2.20	29.45	54.00	-24.55	AVG	Vertical
5725	39.66	44.20	10.00	32.00	-2.20	37.46	74.00	-36.54	Peak	Horizontal
5725	28.00	44.20	10.00	32.00	-2.20	25.80	54.00	-28.20	AVG	Horizontal
5850	45.56	44.20	10.20	32.00	-2.00	43.56	74.00	-30.44	Peak	Vertical
5850	31.37	44.20	10.20	32.00	-2.00	29.37	54.00	-24.63	AVG	Vertical
5850	38.08	44.20	10.20	32.00	-2.00	36.08	74.00	-37.92	Peak	Horizontal
5850	30.13	44.20	10.20	32.00	-2.00	28.13	54.00	-25.87	AVG	Horizontal
802.11ac BW80MHz										
5725	41.21	44.20	10.00	32.00	-2.20	39.01	74.00	-34.99	Peak	Vertical
5725	28.57	44.20	10.00	32.00	-2.20	26.37	54.00	-27.63	AVG	Vertical
5725	42.23	44.20	10.00	32.00	-2.20	40.03	74.00	-33.97	Peak	Horizontal
5725	28.03	44.20	10.00	32.00	-2.20	25.83	54.00	-28.17	AVG	Horizontal
5850	44.20	44.20	10.20	32.00	-2.00	42.20	74.00	-31.80	Peak	Vertical
5850	31.88	44.20	10.20	32.00	-2.00	29.88	54.00	-24.12	AVG	Vertical
5850	37.66	44.20	10.20	32.00	-2.00	35.66	74.00	-38.34	Peak	Horizontal
5850	32.08	44.20	10.20	32.00	-2.00	30.08	54.00	-23.92	AVG	Horizontal

4. CONDUCTED SPURIOUS EMISSIONS AND BANDEDGE

4.1 APPLIED PROCEDURES / LIMIT

Undesirable emission limits. Except as shown in paragraph (b)(7) of this section, the maximum emissions outside of the frequency bands of operation shall be attenuated in accordance with the following limits:

- (1) For transmitters operating in the 5.15-5.25 GHz band: All emissions outside of the 5.15-5.35 GHz band shall not exceed an e.i.r.p. of -27 dBm/MHz.
- (2) For transmitters operating in the 5.25-5.35 GHz band: All emissions outside of the 5.15-5.35 GHz band shall not exceed an e.i.r.p. of -27 dBm/MHz.
- (3) For transmitters operating in the 5.47-5.725 GHz band: All emissions outside of the 5.47-5.725 GHz band shall not exceed an e.i.r.p. of -27 dBm/MHz.
- (4) For transmitters operating in the 5.725-5.85 GHz band:
 - (i) All emissions shall be limited to a level of -27 dBm/MHz at 75 MHz or more above or below the band edge increasing linearly to 10 dBm/MHz at 25 MHz above or below the band edge, and from 25 MHz above or below the band edge increasing linearly to a level of 15.6 dBm/MHz at 5 MHz above or below the band edge, and from 5 MHz above or below the band edge increasing linearly to a level of 27 dBm/MHz at the band edge.

4.1.1 TEST PROCEDURE

Spectrum Parameter	Setting
Detector	Peak
Start/Stop Frequency	30 MHz to 10th carrier harmonic
RB / VB (emission in restricted band)	1000 KHz/3000 KHz
Trace-Mode:	Max hold

For Band edge

Spectrum Parameter	Setting
Detector	Peak
Start/Stop Frequency	Lower Band Edge: 5700 to 5725 MHz Upper Band Edge: 5850 to 5870 MHz
RB / VB (emission in restricted band)	1000 KHz/3000 KHz
Trace-Mode:	Max hold

4.1.2 DEVIATION FROM STANDARD

No deviation.

4.1.3 TEST SETUP

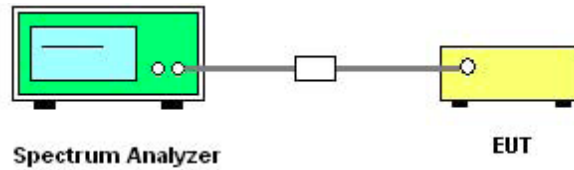

The EUT which is powered by the Battery, is coupled to the Spectrum Analyzer; the RF load attached to the EUT antenna terminal is 50Ohm; the path loss as the factor is calibrated to correct the reading.

Make the measurement with the spectrum analyzer's resolution bandwidth (RBW) = 1000 kHz. In order to make an accurate measurement, set the span greater than RBW.

4.1.4 EUT OPERATION CONDITIONS

The EUT tested system was configured as the statements of 2.3 Unless otherwise a special operating condition is specified in the follows during the testing.

4.1.5 TEST RESULTS

Conducted measurement : N/A

Radiated measurement : Refer to 3.2.8

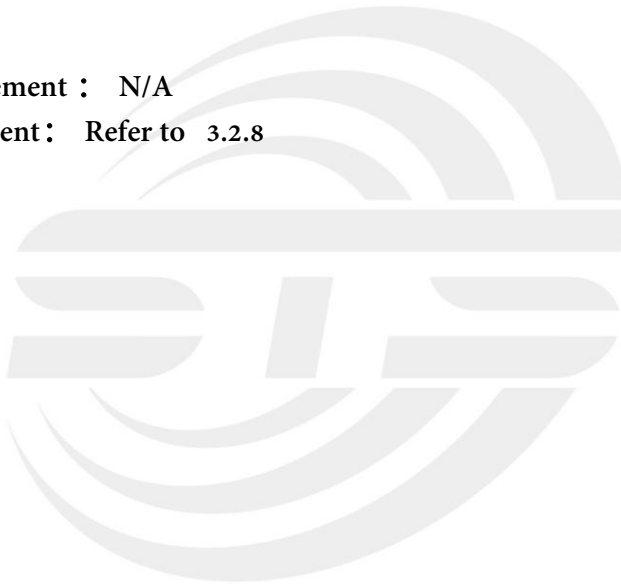



5. POWER SPECTRAL DENSITY TEST

5.1 APPLIED PROCEDURES / LIMIT

1. For mobile and portable client devices in the 5.15-5.25 GHz band, , the maximum power spectral density shall not exceed 11 dBm in any 1 megahertz band. If transmitting antennas of directional gain greater than 6 dBi are used, both the maximum conducted output power and the maximum power spectral density shall be reduced by the amount in dB that the directional gain of the antenna exceeds 6 dBi.
2. For the 5.25-5.35 GHz and 5.47-5.725 GHz bands, the maximum power spectral density shall not exceed 11 dBm in any 1 megahertz band. If transmitting antennas of directional gain greater than 6 dBi are used, both the maximum conducted output power and the maximum power spectral density shall be reduced by the amount in dB that the directional gain of the antenna exceeds 6 dBi.
3. For the band 5.725-5.850 GHz, the peak power spectral density shall not exceed 30 dBm in any 500KHz band. If transmitting antenna directional gain is greater than 6 dBi, both the maximum conducted output power and the peak power spectral density shall be reduced by the amount in dB that the directional gain of the antenna exceeds 6 dBi.

5.1.1 TEST PROCEDURE

1. The setting follows Method SA-1 of FCC KDB D02 General UNII Test Procedures New Rules v01r03.

For devices operating in the band, the rules specify a measurement bandwidth of 500 kHz.

Many spectrum analyzers do not have 500 kHz RBW, thus a narrower RBW may need to be used.

The rules permit the use of a RBWs less than 1 MHz, or 500 kHz, "provided that the measured power is integrated over the full reference bandwidth" to show the total power over the specified measurement bandwidth (*i.e.*, 1 MHz, or 500 kHz). If measurements are performed using a reduced resolution bandwidth (< 1 MHz, or < 500 kHz) and integrated over 1 MHz, or 500 KHz bandwidth, the following adjustments to the procedures apply:

- a) Set $RBW \geq 1/T$, where T is defined in section II.B.I.a).
- b) Set $VBW \geq 3 RBW$.
- c) If measurement bandwidth of Maximum PSD is specified in 500 kHz, add $10 \log (500\text{kHz}/RBW)$ to the measured result, whereas $RBW (< 500 \text{ kHz})$ is the reduced resolution bandwidth of the spectrum analyzer set during measurement.
- d) If measurement bandwidth of Maximum PSD is specified in 1 MHz, add $10 \log (1\text{MHz}/RBW)$ to the measured result, whereas $RBW (< 1 \text{ MHz})$ is the reduced resolution bandwidth of spectrum analyzer set during measurement.
- e) Care must be taken to ensure that the measurements are performed during a period of continuous transmission or are corrected upward for duty cycle.

Note: As a practical matter, it is recommended to use reduced RBW of 100 kHz for the sections 5.c) and 5.d) above, since $RBW=100 \text{ KHZ}$ is available on nearly all spectrum analyzers.

5.1.2 DEVIATION FROM STANDARD

No deviation.

5.1.3 TEST SETUP



5.1.4 EUT OPERATION CONDITIONS

The EUT tested system was configured as the statements of 2.1 Unless otherwise a special operating condition is specified in the follows during the testing.

5.1.5 TEST RESULTS

Data see Appendix B



6. BANDWIDTH MEASUREMENT

6.1 EMISSION BANDWIDTH (EBW) 26 BANDWID PROCEDURES / LIMIT

See list of measuring instruments of this test report.

6.1.1 TEST PROCEDURE

1. The testing follows FCC KDB 789033 D02 General UNII Test Procedures New Rules v01r03
2. Set RBW = approximately 1% of the emission bandwidth.
3. Set the VBW \geq RBW.
4. Detector = Peak.
5. Trace mode = max hold.
6. Measure the maximum width of the emission that is 26 dB down from the peak of the emission. Compare this with the RBW setting of the analyzer. Readjust RBW and repeat measurement as needed until the RBW/EBW ratio is approximately 1%.

6.1.2 DEVIATION FROM STANDARD

No deviation.

6.1.3 TEST SETUP

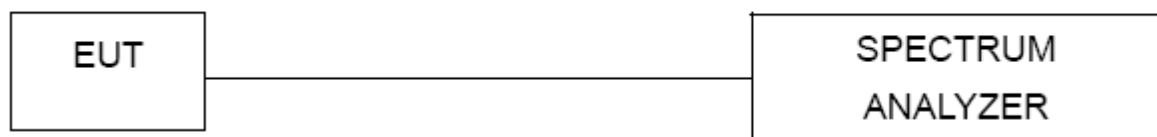

6.1.4 EUT OPERATION CONDITIONS

The EUT tested system was configured as the statements of 2.4 Unless otherwise a special operating condition is specified in the follows during the testing.

6.1.5 TEST RESULTS

Data see Appendix C

6.2 OCCUPIED BANDWIDTH (99%) TEST APPLIED PROCEDURES / LIMIT

The following procedure shall be used for measuring (99 %) power bandwidth:

6.2.1 TEST PROCEDURE

1. The testing follows FCC KDB 789033 D02 General UNII Test Procedures v01r03.

The following procedure shall be used for measuring (99 %) power bandwidth:

1. Set center frequency to the nominal EUT channel center frequency.
2. Set span = 1.5 times to 5.0 times the OBW.
3. Set RBW = 1 % to 5 % of the OBW
4. Set VBW $\geq 3 \cdot$ RBW
5. Video averaging is not permitted. Where practical, a sample detection and single sweep mode shall be used. Otherwise, peak detection and max hold mode (until the trace stabilizes) shall be used.
6. Use the 99 % power bandwidth function of the instrument (if available).
7. If the instrument does not have a 99 % power bandwidth function, the trace data points are recovered and directly summed in power units. The recovered amplitude data points, beginning at the lowest frequency, are placed in a running sum until 0.5 % of the total is reached; that frequency is recorded as the lower frequency. The process is repeated until 99.5 % of the total is reached; that frequency is recorded as the upper frequency. The 99% occupied bandwidth is the difference between these two frequencies.

6.2.2 DEVIATION FROM STANDARD

No deviation.

6.2.3 TEST SETUP

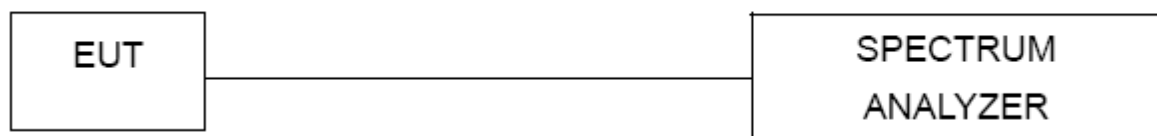

6.2.4 EUT OPERATION CONDITIONS

The EUT tested system was configured as the statements of 2.4 Unless otherwise a special operating condition is specified in the follows during the testing.

6.2.5 TEST RESULTS

Data See Appendix C

6.3 MINIMUM EMISSION BANDWIDTH(6 DB) PROCEDURES / LIMIT

Section 15.407(e) specifies the minimum 6 dB emission bandwidth of at least 500 KHz for the band 5.725-5.85 GHz. The following procedure shall be used for measuring this bandwidth:

6.3.1 TEST PROCEDURE

1. The testing follows FCC KDB 789033 D02 General UNII Test Procedures v01r03.
 - a) Set RBW = 100 kHz.
 - b) Set the video bandwidth (VBW) $\geq 3 \times$ RBW.
 - c) Detector = Peak.
 - d) Trace mode = max hold.
 - e) Sweep = auto couple.
 - f) Allow the trace to stabilize.
 - g) Measure the maximum width of the emission that is constrained by the frequencies associated with the two outermost amplitude points (upper and lower frequencies) that are attenuated by 6 dB relative to the maximum level measured in the fundamental emission.

6.3.2 DEVIATION FROM STANDARD

No deviation.

6.3.3 TEST SETUP



6.3.4 EUT OPERATION CONDITIONS

The EUT tested system was configured as the statements of 2.4 Unless otherwise a special operating condition is specified in the follows during the testing.

6.3.5 TEST RESULTS

Data see Appendix D

7. MAXIMUM CONDUCTED OUTPUT POWER

7.1 APPLIED PROCEDURES / LIMIT

For mobile and portable client devices in the 5.15-5.25 GHz band, the maximum conducted output power over the frequency band of operation shall not exceed 250 mW provided the maximum antenna gain does not exceed 6 dBi. If transmitting antennas of directional gain greater than 6 dBi are used, both the maximum conducted output power and the maximum power spectral density shall be reduced by the amount in dB that the directional gain of the antenna exceeds 6 dBi.

For the 5.25-5.35 GHz and 5.47-5.725 GHz bands, the maximum conducted output power over the frequency bands of operation shall not exceed the lesser of 250 mW or 11 dBm + 10 log B, where B is the 26 dB emission bandwidth in megahertz, If transmitting antennas of directional gain greater than 6 dBi are used.

For the band 5.725-5.85 GHz, the maximum conducted output power over the frequency band of operation shall not exceed 1 W. If transmitting antennas of directional gain greater than 6 dBi are used.

FCC Part15 (15.407) , Subpart E				
Section	Test Item	Limit	Frequency Range (MHz)	Result
15.407(a) (1) (iv)	Peak Output Power	0.25 watt	5150-5250	PASS
		The lesser of 250 mW or 11 dBm + 10 log (26 dB emission bandwidth)	5250-5350 5470-5725	
15.407(a) (3)		1 watt	5725-5825	

7.1.1 TEST PROCEDURE

The EUT was directly connected to the Power Sensor&PC

7.1.2 DEVIATION FROM STANDARD

No deviation.

7.1.3 TEST SETUP



7.1.4 EUT OPERATION CONDITIONS

The EUT tested system was configured as the statements of 5 Unless otherwise a special operating condition is specified in the follows during the testing.



7.1.5 TEST RESULTS

Band I (5.15-5.25GHz)

Band I (5.15-5.25GHz)				
Test Channel	Frequency (MHz)	PK Power (dBm)	AV Power (dBm)	LIMIT (dBm)
802.11a				
36	5180	6.78	4.55	23.98
40	5200	6.72	4.71	23.98
48	5240	6.67	4.66	23.98
802.11n(HT20)				
36	5180	6.75	4.97	23.98
40	5200	6.71	4.42	23.98
48	5240	6.64	5.04	23.98
802.11n(HT40)				
38	5190	4.47	2.96	23.98
46	5230	3.89	1.47	23.98
802.11ac(HT20)				
36	5180	6.57	4.52	23.98
40	5200	6.61	4.61	23.98
48	5240	6.52	4.32	23.98
802.11ac(HT40)				
38	5190	4.38	2.29	23.98
46	5230	3.84	1.61	23.98
802.11ac(HT80)				
42	5210	3.72	1.43	23.98

Note:

1. For mobile and portable client devices in the 5.15-5.25 GHz band, the maximum conducted output power over the frequency band of operation shall not exceed the lesser of 0.25 W.

**Band IV (5.725-5.85GHz)**

Band IV (5.725-5.85GHz)				
Test Channel	Frequency (MHz)	PK Power (dBm)	AV Power (dBm)	LIMIT (dBm)
802.11a				
149	5745	1.68	-0.13	30
157	5785	1.79	-0.28	30
165	5825	1.08	-0.47	30
802.11n(HT20)				
149	5745	1.630	-0.840	30
157	5785	1.470	-0.100	30
165	5825	1.040	-0.350	30
802.11n(HT40)				
151	5755	0.270	-1.250	30
159	5795	0.320	-1.540	30
802.11ac(HT20)				
149	5745	1.570	-0.430	30
157	5785	1.410	-0.920	30
165	5825	0.850	-1.560	30
802.11ac(HT40)				
151	5755	0.240	-1.480	30
159	5795	0.180	-1.400	30
802.11ac(HT80)				
155	5775	-0.550	-2.540	30

Note:

1. For the band 5.745-5.850 GHz, the maximum conducted output power over the frequency band of operation shall not exceed the lesser of 1 W.

8. FREQUENCY STABILITY MEASUREMENT

8.1 LIMIT OF FREQUENCY STABILITY

Manufacturers of U-NII devices are responsible for ensuring frequency stability such that an Emission is maintained within the band of operation under all conditions of normal operation as specified in the user's manual.

8.1.1 MEASURING INSTRUMENTS

See list of measuring instruments of this test report.

8.1.2 TEST PROCEDURES

1. To ensure emission at the band edge is maintained within the authorized band, those values shall be measured by radiation emissions at upper and lower frequency points, and finally compensated by frequency deviation as procedures below.
2. The EUT was operated at the maximum output power, and connected to the spectrum analyzer, which is set to maximum hold function and peak detector. The peak value of the power envelope was measured and noted. The upper and lower frequency points were respectively measured relatively 10dB lower than the measured peak value.
3. The frequency deviation was calculated by adding the upper frequency point and the lower frequency point divided by two. Those detailed values of frequency deviation are provided in table below.

8.1.3 TEST SETUP





8.1.4 TEST RESULTS

NOTE: 1. all bandwidth and mode been test, Only the worst data.

Voltage	Band I (5.15-5.25GHz) Measurement Frequency(MHz)
	5200
MAX(5.5V)	5199.9289
Nom(5.0V)	5199.9257
MIN(4.5V)	5199.9303
Max.Deviation(MHz)	0.0743
Max.Deviation(ppm)	14.29

Temperature Vs. Frequency Stability:

Temperature	Measurement Frequency(MHz)
(°C)	5200
-30	5199.9312
-20	5199.9302
-10	5199.9286
0	5199.9277
10	5199.9274
20	5199.9252
30	5199.9278
40	5199.927
50	5199.9253
Max.Deviation(MHz)	0.0748
Max.Deviation(ppm)	14.38



Voltage	Band IV (5.725-5.85GHz) Measurement Frequency(MHz)
	5785
MAX(5.5V)	5784.9236
Nom(5.0V)	5784.9263
MIN(4.5V)	5784.9259
Max.Deviation(MHz)	0.0764
Max.Deviation(ppm)	14.69

Temperature Vs. Frequency Stability:

Temperature	Measurement Frequency(MHz)
(°C)	5785
-30	5784.9307
-20	5784.9269
-10	5784.9247
0	5784.9223
10	5784.923
20	5784.9268
30	5784.9245
40	5784.9265
50	5784.923
Max.Deviation(MHz)	0.0777
Max.Deviation(ppm)	13.43



9. AUTOMATICALLY DISCONTINUE TRANSMISSION

9.1 LIMIT OF AUTOMATICALLY DISCONTINUE TRANSMISSION

The device shall automatically discontinue transmission in case of either absence of information to transmit or operational failure. These provisions are not intended to preclude the transmission of control or signaling information or the use of repetitive codes used by certain digital technologies to complete frame or burst intervals. Applicants shall include in their application for equipment authorization to describe how this requirement is met.

9.2 TEST RESULT OF AUTOMATICALLY DISCONTINUE TRANSMISSION

During no any information transmission, the EUT can automatically discontinue transmission and become standby mode for power saving. The EUT can detect the controlling signal of ACK message transmitting from remote device and verify whether it shall resend or discontinue transmission





10. ANTENNA REQUIREMENT

10.1 STANDARD REQUIREMENT

15.203 requirement: For intentional device, according to 15.203: an intentional radiator shall be designed to ensure that no antenna other than that furnished by the responsible party shall be used with the device.

10.2 EUT ANTENNA

The EUT antenna is internal PCB Antenna. It comply with the standard requirement.



APPENDIX - PHOTOS OF TEST SETUP

Radiated Measurement Photos

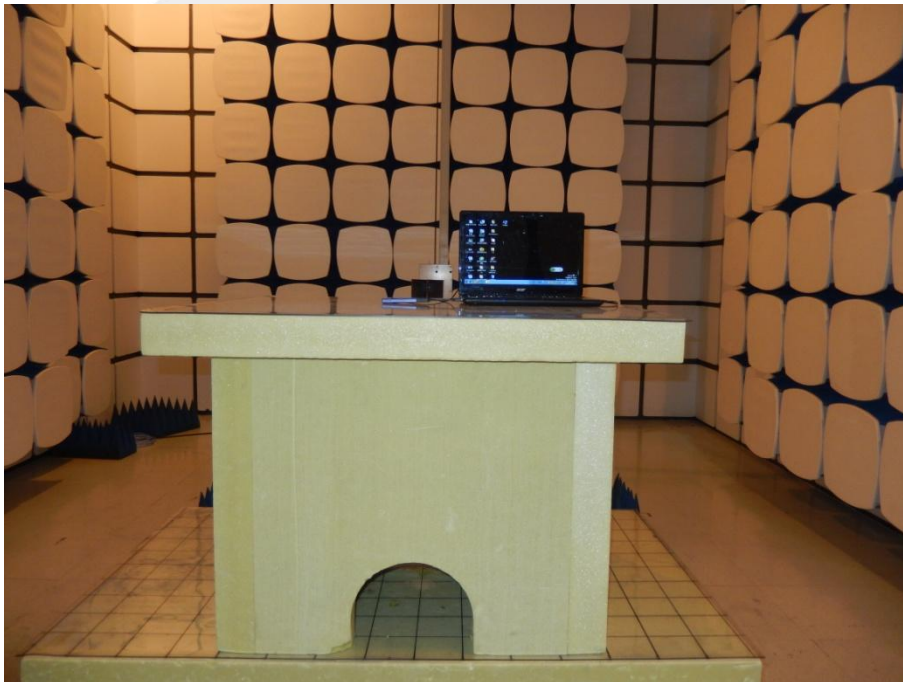
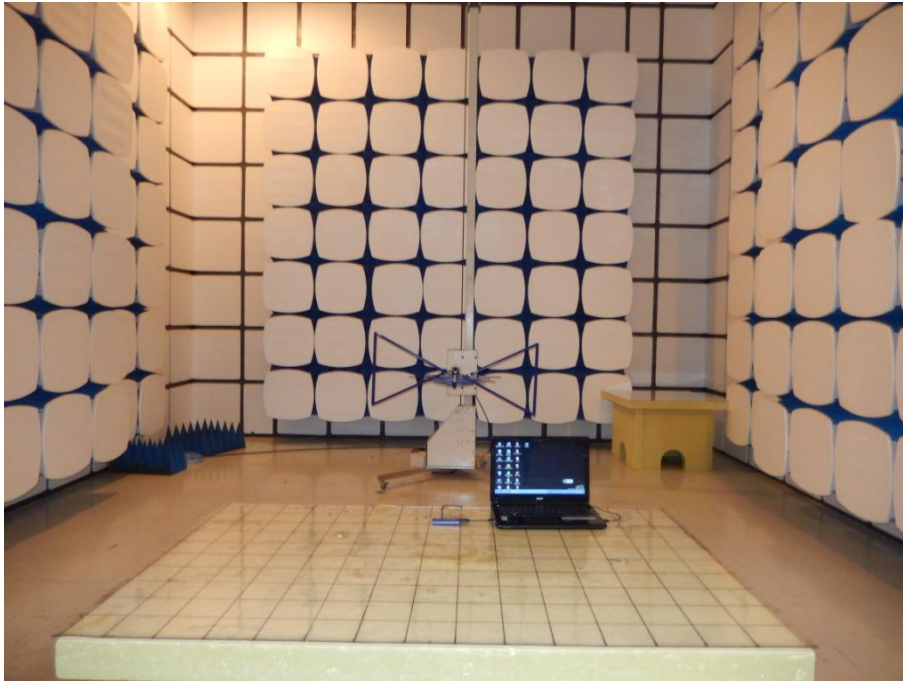

Radiated Measurement Photos



※※※※END OF THE REPORT※※※※

