

# QuantStudio™ 6 Pro and 7 Pro Real-Time PCR Systems

## USER GUIDE

Publication Number MAN0018045

Revision B.0



For Research Use Only. Not for use in diagnostic procedures.



The information in this guide is subject to change without notice.

**DISCLAIMER:** TO THE EXTENT ALLOWED BY LAW, THERMO FISHER SCIENTIFIC INC. AND/OR ITS AFFILIATE(S) WILL NOT BE LIABLE FOR SPECIAL, INCIDENTAL, INDIRECT, PUNITIVE, MULTIPLE, OR CONSEQUENTIAL DAMAGES IN CONNECTION WITH OR ARISING FROM THIS DOCUMENT, INCLUDING YOUR USE OF IT.

**Revision history:** Pub. No. MAN0018045

Revision	Date	Description
B.0		<ul style="list-style-type: none"> <li>• Corrected the text on the buttons for the following items:                             <ul style="list-style-type: none"> <li>- Add facial authentication to an existing instrument profile.</li> <li>- View the license agreement.</li> <li>- Reset the instrument (restore factory default).</li> </ul> </li> <li>• Added the following items:                             <ul style="list-style-type: none"> <li>- TET™ dye as a system dye.</li> <li>- Information about sleep mode.</li> <li>- Information about the automatic sign-out feature.</li> <li>- The option to configure the instrument so that guest access is not permitted.</li> <li>- Instructions to edit the facial authentication of an existing profile.</li> <li>- Information about the speaker volume for each user.</li> <li>- Instructions to back up the instrument and to restore a backup of the instrument.</li> <li>- Information about multiple instruments in the comparison of a local instrument profile and a Connect profile.</li> <li>- Instructions to unlink a Connect profile.</li> <li>- Added radio compliance standards and RF transceiver specifications.</li> </ul> </li> <li>• Corrected the following items:                             <ul style="list-style-type: none"> <li>- Indicators for voice commands.</li> <li>- Instructions to remove VeriFlex™ Zones and the Auto Delta setting.</li> <li>- Excitation and emission wavelengths of the filters in the calibration instructions.</li> <li>- Add a four-digit PIN when signing into the instrument for the first time using a Connect profile.</li> <li>- Add a four-digit PIN when linking a local instrument profile to a Connect profile.</li> <li>- A run cannot be started if a block has never been calibrated on the instrument.</li> </ul> </li> <li>• Updated the following items:                             <ul style="list-style-type: none"> <li>- <b>C<sub>q</sub> Export</b> checkbox is selected as the default.</li> <li>- Instructions to sign in with facial authentication.</li> </ul> </li> </ul>
A.0	18 April 2019	New document.

**Important Licensing Information:** These products may be covered by one or more Limited Use Label Licenses. By use of these products, you accept the terms and conditions of all applicable Limited Use Label Licenses.

**NOTICE TO PURCHASER: DISCLAIMER OF LICENSE:** Purchase of this software product alone does not imply any license under any process, instrument or other apparatus, system, composition, reagent or kit rights under patent claims owned or otherwise controlled by Life Technologies Corporation, either expressly, or by estoppel.

**Trademarks:** All trademarks are the property of Thermo Fisher Scientific and its subsidiaries unless otherwise specified. TaqMan is a registered trademark of Roche Molecular Systems, Inc., used under permission and license. Cy is a registered trademark of GE Healthcare. Amazon, Alexa, and all related logos are trademarks of Amazon.com, Inc. or its affiliates. Windows is a trademark of Microsoft Corporation. Chrome is a trademark of Google LLC. Pentium is a trademark of Intel Corporation or its subsidiaries in the U.S. and/or other countries. Macintosh is a trademark of Apple Inc., registered in the U.S. and other countries.

# Contents

■ <b>CHAPTER 1</b>	<b>Product information</b>	<b>10</b>
	Instrument hardware description	10
	Overview of the instrument	10
	Features of each instrument	11
	Instrument filters and supported dyes	11
	Overview of data collection	13
	VeriFlex™ Zones	13
	AutoDelta settings	14
	Parts of the instrument	15
	Instrument status indicator	17
	Hands-free features	17
	Facial authentication	17
	Voice activation	17
	Indicators for the hands-free features	17
	Software description	19
	Parts of the home screen	19
	Connect and Cloud definitions	21
	Instrument, desktop software, and Connect platform features	21
	Overview of file locations and files	22
	Components of the files	25
	Third-party software	26
	Network connection options	26
	Types of runs	26
	Standard curve run	26
	Relative standard curve run	27
	Comparative $C_t$ ( $\Delta\Delta C_t$ ) run	27
	Genotyping run	28
	Presence/absence run	28
	Melt curve run	28
	System template file names	28
	Workflow	30

■	<b>CHAPTER 2</b>	<b>Get started</b>	<b>31</b>
	Precautions for use		31
	Installation and instrument verification		32
	Overview of guest access		32
	Use the instrument as a guest		32
	Power on the instrument		33
	Sign in		33
	Sign in with a PIN		33
	Sign in with facial authentication		34
	Enable or disable the microphone		34
	Use voice commands		35
	Sign out		36
■	<b>CHAPTER 3</b>	<b>Create and run plates on the instrument</b>	<b>37</b>
	Options to run a plate		37
	Create and run a plate from a system template or a saved plate file		37
	Repeat the last run		38
	<i>(Optional)</i> Scan a barcode using a barcode scanner		40
	Load a plate into the instrument		40
	Unload a plate from the instrument		41
■	<b>CHAPTER 4</b>	<b>Edit a plate before starting a run</b>	<b>42</b>
	Options to edit the properties of a plate file		42
	Import a sample setup		42
	Options to edit the method of a plate file		42
	Method elements		43
	Edit the method		43
	Add or remove steps		44
	Add or remove stages		44
	Add or remove data collection locations		44
	Set up or remove VeriFlex™ Zones		44
	Set up or remove the Auto Delta feature		45
	Configure ramp rates		46
	Add or remove a pause		46
	Options to edit the well details of a plate file		46
	Options to view a plate layout		47
	Assign or edit a well		47
	Add the reagent details		48
	Edit the reagent details		48
	Delete the reagent details		48
	Edit a passive reference dye		49

■	<b>CHAPTER 5</b>	<b>Options for a run</b>	<b>50</b>
	Screens available during a run		50
	Edit a plate file during a run		50
	Pause an instrument run		51
	Stop an instrument run		51
	View the method during a run		52
	View real-time data and plots during a run		52
	Adjust the display of real-time plots during a run		52
	View the time remaining during a run		52
	Lock the touchscreen during a run		53
	Unlock the touchscreen during a run		53
	Instrument Schedule		53
	Overview of the instrument schedule		53
	Schedule a run		53
	Cancel a scheduled run		54
■	<b>CHAPTER 6</b>	<b>View and manage files</b>	<b>55</b>
	Manage plate files		55
	Copy plate files		55
	Delete plate files		56
	Manage data files		56
	View an amplification plot after a run		56
	Transfer a data file immediately after a run		57
	Transfer data files at a later time		57
	View the list of data files on the instrument		58
	Delete data files from the instrument		58
■	<b>CHAPTER 7</b>	<b>Calibrate and verify instrument performance</b>	<b>59</b>
	Instrument and block calibration		59
	Calibration and verification schedule		60
	Calibration descriptions		61
	View the calibration status and set reminders		61
	View the calibration status on the instrument		61
	Set calibration frequency and reminders on the instrument		62
	View calibration status and set reminders on the Connect platform		62
	Export a calibration report		63
	Perform ROI/uniformity, background, and dye calibrations		63
	Calibration workflow		63
	Prepare a calibration plate		63
	Perform calibrations		65
	View the calibration images		66

Transfer calibration results .....	67
Transfer calibration data files .....	67
Troubleshoot calibration failure .....	68
Identify contamination .....	68
Create a background plate ( <i>optional</i> ) .....	69
Perform verification using RNase P plates .....	69
Instrument verification description .....	70
RNase P instrument verification plate .....	70
Performance specifications pass criteria .....	71
Prepare an RNase P plate .....	71
Perform RNase P verification .....	72
Troubleshoot verification failure .....	73
Calibrate custom dyes .....	74
Overview of custom dyes .....	74
Use a dilution series to determine an optimal custom dye concentration .....	74
Calibrate the custom dye .....	77
<b>■ CHAPTER 8 Manage profiles .....</b>	<b>80</b>
Edit guest access .....	80
Recommended order to set up profiles .....	80
Overview of local instrument profiles and Connect profiles .....	81
Connect instrument profile roles and functions .....	81
Link the instrument to your Connect account .....	82
Create a new local instrument profile .....	83
Link a local profile to a Connect profile .....	83
Unlink a Connect account .....	84
If you link when you <i>are</i> signed in to the instrument .....	85
If you link when you <i>are not</i> signed in to the instrument .....	86
Manage individual instrument profiles .....	87
Create an administrator instrument profile during initial start-up .....	87
Set up facial authentication at the initial creation of an instrument profile .....	87
Add facial authentication to an existing instrument profile .....	87
Change the PIN for an instrument profile .....	88
Edit the facial authentication of an existing profile .....	88
Manage all instrument profiles as an administrator .....	88
View all instrument profiles .....	88
Reset the PIN for a profile .....	88
Add a profile .....	89
Enable or disable administrator privileges .....	89
Delete a profile .....	89

■ <b>CHAPTER 9</b>	<b>Maintain the instrument</b>	<b>91</b>
	Install a block	91
	Change the block	92
	Remove the block	93
	Decontaminate the sample block	94
	Materials required	94
	Clean the sample block	94
	Detailed procedures for cleaning the sample block	95
	Replace the instrument fuses	96
	Materials required	96
	Replace the fuses	96
	Power on or off, store, and move	98
	Enable and edit sleep mode	98
	Power on the instrument	98
	Power off the instrument	99
	Prepare the instrument to store, move, or ship	99
	Move the instrument	99
■ <b>CHAPTER 10</b>	<b>Configure the instrument settings</b>	<b>100</b>
	View the instrument details	100
	View the license agreement	101
	Configure the instrument settings	101
	Enable or disable demonstration mode	101
	Edit the instrument name (administrator only)	101
	Set the date and the time	102
	Configure the heated cover settings	102
	Adjust the speaker volume	102
	Configure the network	102
	Select the region for the Connect platform	103
	Select a disk storage management mode	104
	Enable and edit automatic sign-out	104
	Configure maintenance and service settings	105
	Request technical support with Smart Help	105
	Request instrument service with Smart Help	105
	Perform a self-verification test	106
	View the last self-verification test result	106
	View the instrument log	106
	Export the instrument log	107
	View the instrument statistics	107
	Enable or disable remote monitoring	108
	Update the software	108
	Back up the instrument	108
	Restore a backup of the instrument	109

Overview of an instrument reset (restore factory default) .....	109
Reset the instrument (restore factory default) .....	110
Configure the instrument for the hands-free features .....	110
Manage run history (data files) .....	110
Manage the file name convention of the data file .....	110
View the notifications .....	111
Enable and disable home screen notifications .....	112
Clear the notifications .....	112
<b>■ APPENDIX A Instrument specifications and layout .....</b>	<b>113</b>
Instrument dimensions .....	113
Instrument and computer clearances .....	114
Configured system dimensions .....	115
Electrical requirements .....	116
Environmental requirements .....	116
<b>■ APPENDIX B Connect the instrument to a network .....</b>	<b>118</b>
Connect the computer to the instrument directly or to a LAN .....	118
Connect the instrument to a wired network .....	119
Connect the instrument to a wireless network .....	120
Instrument and computer connections .....	121
Download and install the desktop software .....	122
Computer requirements for the desktop software .....	122
Download the desktop software .....	122
Install the desktop software .....	123
Networking .....	123
Supported options for instrument and computer connections .....	123
Control and monitor networked instruments .....	124
Networking guidelines and best practices .....	125
Firewall ports that must be open .....	125
Ethernet port overview .....	125
Third-party software .....	125
<b>■ APPENDIX C Parts and materials .....</b>	<b>126</b>
Kits, consumables, accessories, and reagents .....	126
Consumables (96-well, 0.2-mL format) .....	126
Accessories .....	127



■ <b>APPENDIX D Safety</b> .....	<b>128</b>
Symbols on this instrument .....	128
Standard safety symbols .....	129
Additional safety symbols .....	130
Location of safety labels .....	130
Control and connection symbols .....	134
Conformity symbols .....	134
Safety information for instruments not manufactured by Thermo Fisher Scientific ....	135
Instrument safety .....	135
General .....	135
Physical injury .....	136
Electrical safety .....	137
Laser safety .....	138
Cleaning and decontamination .....	139
Instrument component and accessory disposal .....	139
Safety and electromagnetic compatibility (EMC) standards .....	139
Safety standards .....	140
EMC standards .....	140
Environmental design standards .....	141
Radio compliance standards .....	141
RF transceiver specifications .....	143
Chemical safety .....	144
Biological hazard safety .....	146
<b>Documentation and support</b> .....	<b>147</b>
Related documentation .....	147
Customer and technical support .....	147
Limited product warranty .....	148
<b>Index</b> .....	<b>149</b>



# Product information

- Instrument hardware description ..... 10
- Hands-free features ..... 17
- Software description ..... 19
- Types of runs ..... 26
- System template file names ..... 28
- Workflow ..... 30

## Instrument hardware description

### Overview of the instrument

The Applied Biosystems™ QuantStudio™ 6 Pro and 7 Pro Real-Time PCR Systems use fluorescent-based polymerase chain reaction (PCR) reagents to perform the following functions:

- Quantitative detection of target nucleic acid sequences (targets)
- Qualitative detection of targets (endpoint analysis)
- Qualitative analysis of the PCR product (post-PCR target nucleic acid sequences melt curve analysis)



Each instrument is available with an interchangeable block. A 96-well 0.2-mL block is currently available.

The instrument can be used directly from the touchscreen to create and start runs. To design runs or to analyze data, the instrument can be integrated with the desktop software or the Connect platform.

Each instrument has the following features:

- Sign-in with facial authentication
- An interchangeable block
- Microphone for voice activation
- Speakers for feedback from voice activation and for instructional videos
- Smart Help to request technical support or instrument service directly from the instrument
- Barcode scanner for tracking plates

### Features of each instrument

Feature	QuantStudio™ 6 Pro System	QuantStudio™ 7 Pro System
Filter set <sup>[1]</sup>	Coupled five-color filter set	Decoupled six-by-six color filter set
VeriFlex™ Zones <sup>[2]</sup>	Three VeriFlex™ Zones	Six VeriFlex™ Zones

<sup>[1]</sup> See "System dyes" on page 11.

<sup>[2]</sup> See "VeriFlex™ Zones" on page 13.

### Instrument filters and supported dyes

#### System dyes

The QuantStudio™ 6 Pro Real-Time PCR System has a coupled five-color filter set.

The QuantStudio™ 7 Pro Real-Time PCR System has a decoupled six-by-six color filter set.

For more information about available spectral dye calibration kits, contact Support.

Peak filter	Color	Filter wavelength (nm) <sup>[1]</sup>		System dyes	Example custom dyes
		Excitation	Emission		
x1-m1	Blue	470 ± 15	520 ± 15	FAM™ dye, SYBR™ Green	SYT09
x2-m2	Green	520 ± 10	558 ± 11	VIC™ dye	JOE™ dye, HEX™ dye, TET™ dye <sup>[2]</sup>
x3-m3	Yellow	550 ± 11	586 ± 10	NED™ dye, TAMRA™ dye, ABY™ dye	Cy <sup>®</sup> 3 dye
x4-m4	Orange	580 ± 10	623 ± 14	ROX™ dye, JUN™ dye	Texas Red™ dye

Peak filter	Color	Filter wavelength (nm) <sup>[1]</sup>		System dyes	Example custom dyes
		Excitation	Emission		
x5-m5	Red	640 ± 10	682 ± 14	MUSTANG PURPLE™ dye, Cy <sup>®</sup> 5	LIZ™ dye
x6-m6	Deep-Red	662 ± 10	711 ± 12	None <sup>[3]</sup>	Cy <sup>®</sup> 5.5 dye

<sup>[1]</sup> The central wavelengths are the optimized wavelengths.

<sup>[2]</sup> The HEX™ dye and TET™ dye from Thermo Fisher Scientific fall within the emission wavelength range of the system, therefore they can be added and adapted for use on the instrument.

<sup>[3]</sup> This filter set currently does not support any dyes supplied by Thermo Fisher Scientific.

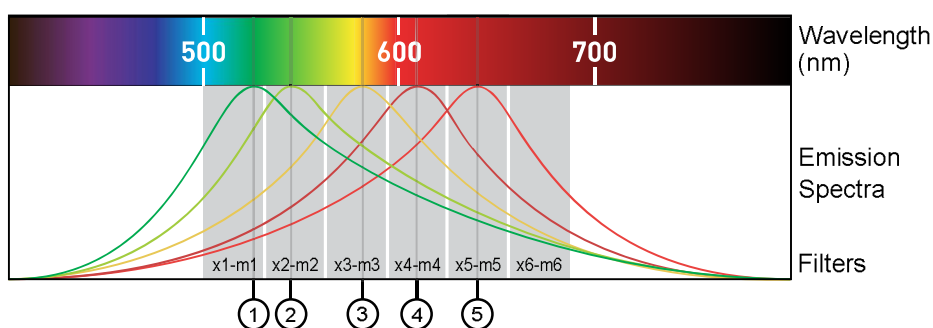

- ① x1-m1—FAM™ dye, SYBR™ Green
- ② x2-m2—VIC™ dye
- ③ x3-m3—ABY™ dye, NED™ dye, Cy<sup>®</sup>3, TAMRA™ dye
- ④ x4-m4—JUN™ dye, ROX™ dye, Texas Red™ dye
- ⑤ x5-m5—Cy<sup>®</sup>5, MUSTANG PURPLE™ dye

### Custom dyes

The instrument can run assays designed with custom dyes. Custom dyes include the following options:

- Dyes that are not supplied by Thermo Fisher Scientific.
- Dyes or formulations of dyes that are not system dyes for the instrument.

To use a custom dye on the instrument, review the following requirements.

- Calibrate the instrument for the custom dye (see “Calibrate custom dyes” on page 74).
- Ensure that the custom dye excites between 455–672 nm and emits between 505–723 nm.
- Select a custom dye that does not overlap with other dyes used in the run (see “System dyes” on page 11).
- The custom dye for use in calibration must be attached to the 5' end of a short DNA oligonucleotide consisting of the first two bases of the probe sequence without a quencher at the 3' end.

## Overview of data collection

The instrument collects raw fluorescence data at different points during the PCR cycle, depending on the type of run performed.

When you create a plate file, you can customize the optical filter channels through which the instrument collects data. You can specify a filter channel set for all PCR thermal protocols and for melt curve stages.

Run type	Run type	Data collection point
Real-time	<ul style="list-style-type: none"> <li>Standard curve</li> <li>Relative standard curve</li> <li>Comparative C<sub>t</sub> (<math>\Delta\Delta C_t</math>)</li> <li>Melt curve</li> </ul>	<p>During the thermal cycling protocol.</p> <p>Typical timing is to collect data at each cycle of a PCR stage or continuously during a melt stage.</p>
Post-PCR (endpoint)	<ul style="list-style-type: none"> <li>Genotyping</li> <li>Presence/absence</li> </ul>	<ul style="list-style-type: none"> <li>After thermal cycling is completed. For Presence/Absence and Genotyping analysis, data collection before the PCR cycle is optional, but recommended.</li> <li><i>Optional</i>/During the thermal cycling protocol. Collecting data during the run can confirm genotyping results by viewing traces in allelic discrimination plots or viewing genotyping calls at earlier cycles.</li> </ul>

## VeriFlex™ Zones

VeriFlex™ Zones provide independent temperature zones that offer enhanced functionality and precise control over your real-time PCR runs.

The independent zones are ideal for real-time PCR optimization. They also provide the ability to perform multiple runs at the same time. Unlike standard gradients which give a sigmoidal temperature curve across the columns, blocks with VeriFlex™ Zones help deliver accurate temperatures across every zone.

The QuantStudio™ 6 Pro System has three VeriFlex™ Zones (Figure 1). The QuantStudio™ 7 Pro System has six VeriFlex™ Zones (Figure 2).

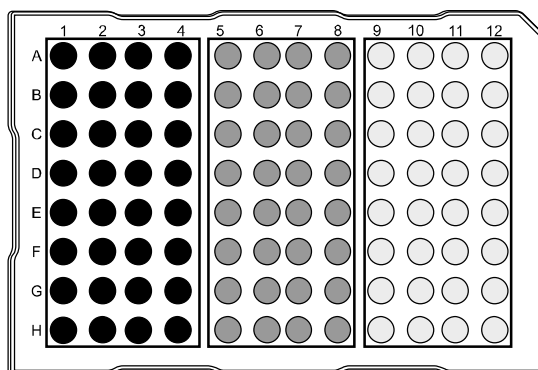

Figure 1 Three VeriFlex™ Zones

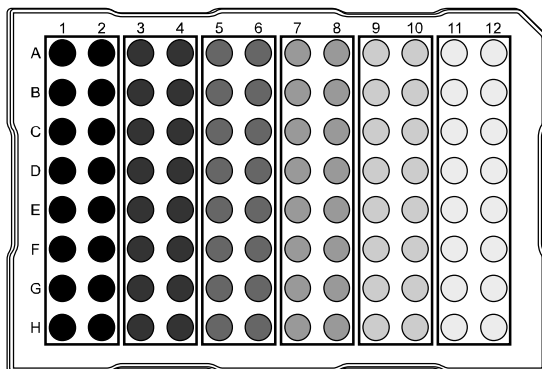

Figure 2 Six VeriFlex™ Zones

**Note:** Plate files are not compatible between the QuantStudio™ 6 Pro System and the QuantStudio™ 7 Pro System. For more information, see “Compatibility of plate files” on page 24.

**AutoDelta settings**

AutoDelta enables an incremental increase or decrease in the temperature or time in a PCR cycle.

To use AutoDelta, specify a difference in the time and the temperature. Specify the PCR cycle for this change to be applied.

Parts of the instrument

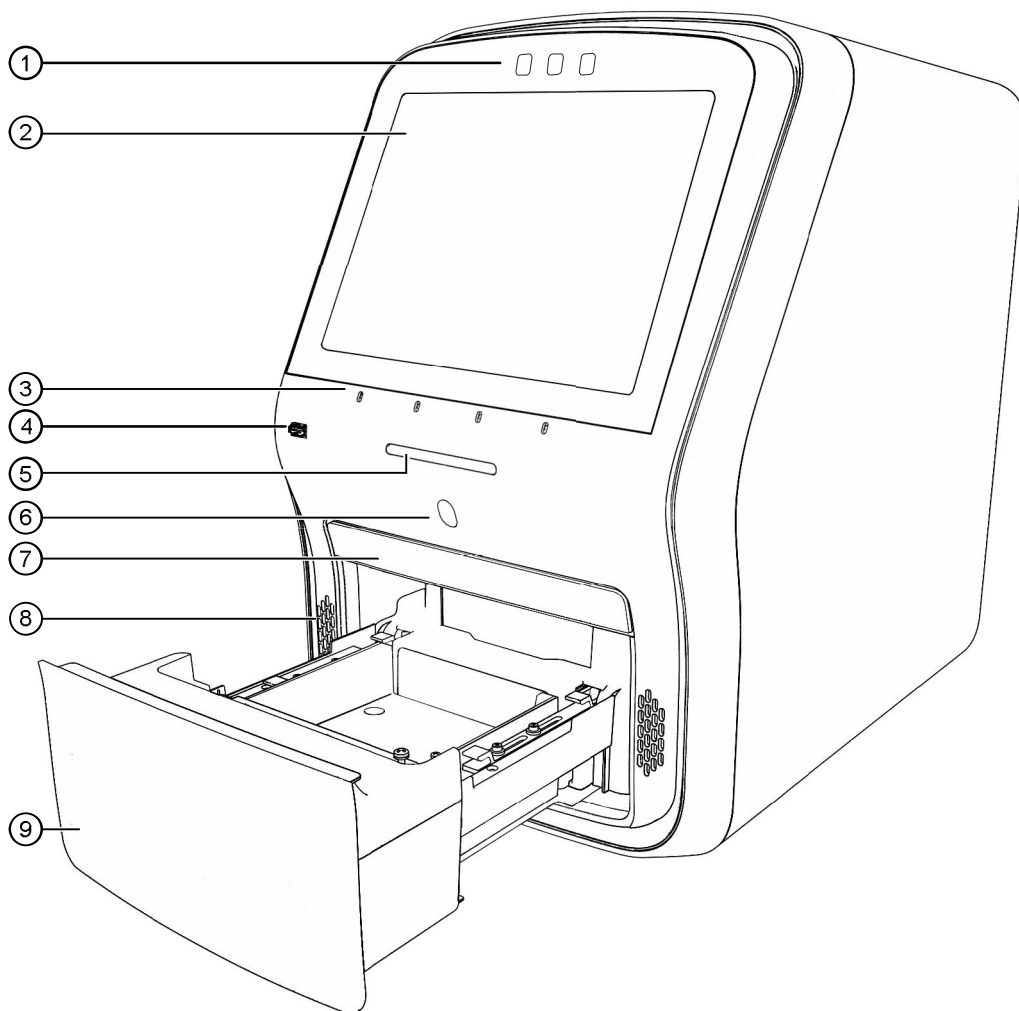
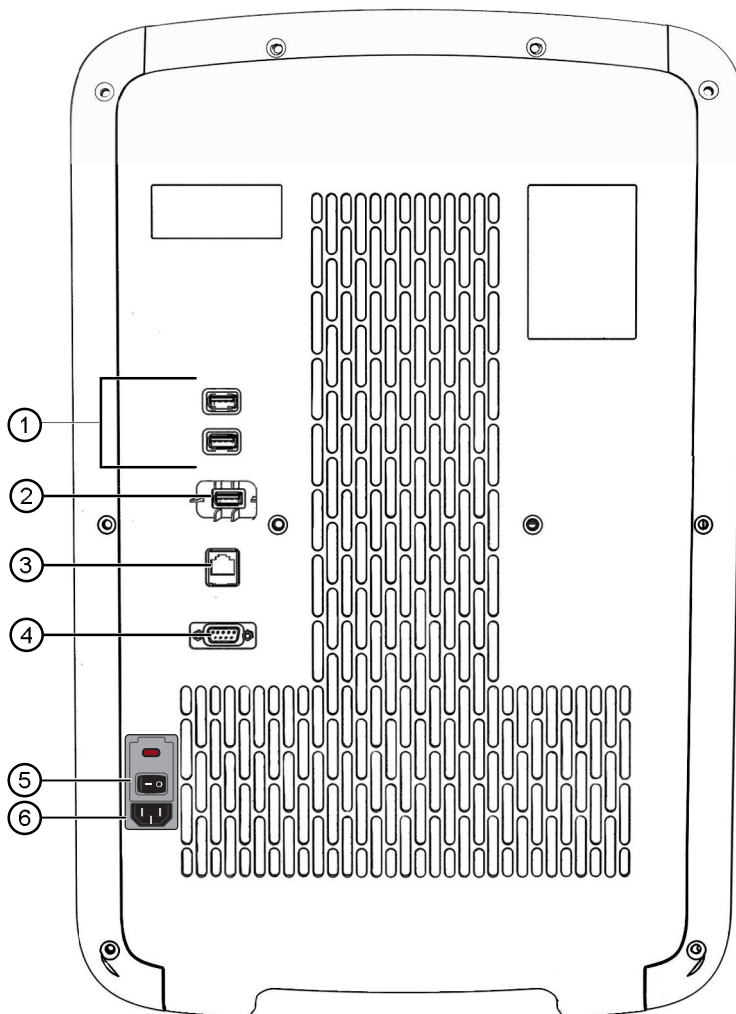

Figure 3 Front of the instrument

- ① **Cameras**
- ② **Touchscreen**
- ③ **Microphones**
- ④ **USB port**
- ⑤ **Indicator light**
- ⑥ **Proximity sensor**
- ⑦ **Access door for block change**
- ⑧ **Speakers**
- ⑨ **Drawer**



**Figure 4** Back of the instrument

- ① USB ports
- ② Wi-Fi dongle port
- ③ Ethernet port
- ④ RS-232 port (service use only)
- ⑤ ON/OFF switch
- ⑥ Power inlet receptacle

**Note:** The instrument recognizes only one external storage device at a time for data transfer.

The USB ports at the rear of the instrument can be used for external devices, for example, a mouse or a keyboard.



**Instrument status indicator**

Indicator	Instrument status
Off	Powered off Sleep mode
Blue light changing brightness slowly	Powering on
Blue light changing brightness	Standby
Blue light moving inwards towards middle of instrument	Drawer opening
Blue light moving outwards towards side of instrument	Drawer closing
Blue light moving back and forth	Block is being changed
Blue light on	Instrument is ready to start a run or is performing a run
Amber blinking	Error

## Hands-free features

**Facial authentication**

The instrument allows hands-free facial authentication to sign in a user. The instrument camera detects a face. The instrument will sign in the user after the face is matched to the photo associated with a profile.

**Voice activation**



The instrument recognizes a set of commands for hands-free operation. For list of supported commands, see "Use voice commands" on page 35.

Voice commands are only available when a user is signed in with a Connect account. Voice commands are not available with a local instrument profile.

Voice commands use Amazon™ Alexa™ for Business.





**Indicators for the hands-free features**

**Indicators for facial authentication**

Display	Status of facial authentication
The <b>Sign In</b> screen displays  .	Facial authentication for the instrument is enabled.
The <b>Sign In</b> screen does not display  .	<ul style="list-style-type: none"> <li>Facial authentication for the instrument is disabled.</li> <li>All users must sign in with a PIN.</li> </ul> <p><b>Note:</b> To enable facial authentication, see "Configure the instrument for the hands-free features" on page 110.</p>

## Indicators for voice commands

For the location of the proximity sensor, see Figure 3 on page 15.

Display	Status of voice commands
 (Gray)	The voice command function is not available because the proximity sensor does not detect a person.
 (Gray)	The voice command function is not available. <ul style="list-style-type: none"> <li>Voice activation for the instrument is disabled by an administrator.</li> <li>The user is signed in with a local profile.</li> </ul>
 (Amber)	The instrument is preparing to accept voice commands. <b>Note:</b> The amber display is an intermediate state and will only appear for several seconds.
 (Blue)	The voice command function is available. <ul style="list-style-type: none"> <li>Voice activation for the instrument is enabled by an administrator.</li> <li>The user is signed in with a Connect instrument profile.</li> <li>The proximity sensor detects a person.</li> </ul>
 (Red)	The voice command function is not available. It has been disabled by the user (see "Enable or disable the microphone" on page 34).

To enable voice commands, see "Configure the instrument for the hands-free features" on page 110.

For more information about linking a local instrument profile to a Connect profile, see "Link the instrument to your Connect account" on page 82 and "If you link when you are signed in to the instrument" on page 85.

## Software description

### Parts of the home screen









Figure 5 Home screen

- ① Instrument name
- ② Instrument calendar
- ③ Microphone
- ④ Help
- ⑤ Eject
- ⑥ Status dial
- ⑦ Block installed
- ⑧ Current user
- ⑨ Connectivity icons
- ⑩ Buttons to access plate files
- ⑪ Instrument settings

Table 1 Parts of the home screen

Element of the home screen	Function
Instrument name	Set by the administrator to identify the instrument.
Calendar	Schedule time for a run or see runs that are scheduled.
Microphone	Shows the status of the microphone (see “Indicators for voice commands” on page 18 and “Enable or disable the microphone” on page 34).
Help	Access the Help.
Eject	Open or close the drawer to insert or remove a plate.

Element of the home screen	Function
Status dial	<ul style="list-style-type: none"> <li>• When the instrument is not in use—Displays <b>Set up run</b>.</li> <li>• When the instrument is in use—Displays the sample block temperature, the elapsed run time, and the run status.</li> <li>• When the instrument is locked while in use—Displays <b>Locked</b> within the status dial.</li> <li>• When a run is complete—Displays <b>Run complete</b>.</li> </ul>
Block type	<p>The block that is installed on the instrument.</p> <p>If applicable, the following items are noted:</p> <ul style="list-style-type: none"> <li>• If there is no block and heated cover set installed.</li> <li>• If the block and heated cover are mismatched.</li> </ul>
Current user	<p>Displays the current signed-in user.</p> <p><b>Guest</b> is displayed if no user is signed in.</p>
Connectivity	<p>Only the icons that apply to the connectivity status of the instrument at the time are displayed.</p> <ul style="list-style-type: none"> <li>•  —The instrument is wirelessly connected.</li> <li>•  —The instrument is connected to a wired network.</li> <li>•  —A USB drive is plugged into the instrument.</li> <li>•  —The instrument is connected to a network drive.</li> <li>•  —The instrument is connected to a Connect account.</li> </ul>
Buttons to access plate files	<p>Access a plate file to edit it or start a run.</p> <ul style="list-style-type: none"> <li>• <b>Set up run</b>—Open a system template or a saved plate file.</li> <li>•  <b>(Load plate file)</b>—Open a system template or a saved plate file.</li> <li>•  <b>(Run last)</b>—Open the last plate file that was used to start a run. The last plate file is specific to the profile.</li> </ul>
Instrument settings	<ul style="list-style-type: none"> <li>• Edit the file name convention.</li> <li>• View the run history, and transfer or delete data files.</li> <li>• Install, change, or remove the block and the heated cover.</li> <li>• Configure the instrument settings.</li> <li>• Configure the maintenance and service settings.</li> <li>• View notifications.</li> <li>• Configure hands-free operation.</li> </ul>

### Connect and Cloud definitions

The terms Connect, Cloud, Thermo Fisher Connect, and Thermo Fisher Cloud are used interchangeably on the instrument touchscreen. The term Connect is used in this document.

The following icons are used interchangeably on the instrument touchscreen:

- 
- 

The  icon is used in this document.

### Instrument, desktop software, and Connect platform features

The instrument and the software include the features described below.

**Note:** System templates cannot be edited. They can be edited, then saved as a separate plate file.

Feature	Instrument	Desktop	Connect
Use as guest (no sign in)	✓	✓	—
Schedule a run	✓	—	—
Open system templates	✓	✓	✓
Open system templates, edit them, and save them as plate files	✓	✓	✓
Open plate files created on the desktop software	✓	✓	✓
Open plate files created on the Connect platform	✓	✓	✓
Open plate file created on the instrument	✓	✓	✓
Send plate files to the instrument run queue	—	✓	—
Access the plate file associated with last run on the instrument	✓	—	—
Load plate in instrument	✓	—	—
Start run	✓	—	—
View real-time data during a run	✓	—	✓
View results after a run is complete	✓ (Limited)	✓	✓
See instrument status (run in progress)	✓	—	✓
Check calibration status	✓	—	—
Analyze results	—	✓	✓

Feature	Instrument	Desktop	Connect
Set calibration reminders	✓	—	✓
Review exported calibration or RNase P verification results	—	✓	✓ <i>(RNase P only)</i>

## Overview of file locations and files

### File locations



File location	Description and function
Run queue	Plate files sent from the desktop software.
Public	<ul style="list-style-type: none"> <li>• Plate files saved by guest users are stored in this folder.</li> <li>• Data files from runs started by guest users are stored in this folder.</li> </ul>
Templates	<ul style="list-style-type: none"> <li>• System templates are stored in this folder.</li> <li>• System templates cannot be edited. They must be saved as a separate plate file and stored in a different folder.</li> <li>• Data files cannot be saved in this folder.</li> </ul>
Connect	<ul style="list-style-type: none"> <li>• Plate files can be retrieved from a Connect profile.</li> <li>• Data files can be saved to a Connect profile.</li> <li>• You must have a Connect profile.</li> </ul>
Network drive	<ul style="list-style-type: none"> <li>• Plate files can be retrieved from a network drive.</li> <li>• Data files can be saved to a network drive.</li> <li>• The instrument must be connected to a network or a computer.</li> </ul>
USB drive	<ul style="list-style-type: none"> <li>• Plate files can be retrieved from a USB drive.</li> <li>• Data files can be saved to a USB drive.</li> <li>• A USB drive must be inserted into the instrument.</li> </ul>
My instrument	<ul style="list-style-type: none"> <li>• This location is only available to a user who is signed in. Guest users cannot access this location to retrieve plate files or save data files.</li> <li>• This location is specific to a user. Files are not accessible to any other users, except for administrators.</li> <li>• Plate files can be retrieved from this location.</li> <li>• Data files are always saved to this location.</li> </ul>
Post-read	<ul style="list-style-type: none"> <li>• In endpoint PCR, the pre-read data is saved in this folder for post-read analysis.</li> </ul>

## Files

**IMPORTANT!** Plate files and data files are not included in a back-up of the instrument and are not restored when a backup of the instrument is restored.

Plate files and data files must be transferred separately. See Chapter 6, “View and manage files”.

System templates are included in the back-up and are restored when a backup of the instrument is restored.

Item	Description and function	Supported in
System template	<ul style="list-style-type: none"> <li>• A non-editable template.</li> <li>• Accessed from  (<b>Load plate file</b>) and the <b>Templates</b> folder (only system templates are stored in this folder).</li> <li>• Accessed from the <b>Set up run</b> button.</li> <li>• Is saved as a separate plate file if it is edited.</li> <li>• Contains the thermal protocol for the real-time PCR.</li> <li>• Does not contain the sample information.</li> <li>• Does not contain the target information.</li> <li>• Sample information and target information must be added (saved as a separate plate file). The sample information and target information can be added on the desktop software or on the Connect platform after the run is complete.</li> </ul>	Instrument Desktop Connect
Plate File From  ( <b>Load plate file</b> )	<ul style="list-style-type: none"> <li>• A file that has been saved from a system template.</li> <li>• Can be edited and saved.</li> <li>• Can be edited and saved as a separate plate file.</li> <li>• Contains the thermal protocol for the real-time PCR.</li> <li>• Can contain the sample information.</li> <li>• Can contain the target information.</li> <li>• Sample information and target information must be added if not present. The sample information and target information can be added on the desktop software or on the Connect platform after the run is complete.</li> </ul>	Instrument Desktop Connect

Item	Description and function	Supported in
Plate File From  <b>(Run last)</b>	<ul style="list-style-type: none"> <li>• The plate file associated with the last run for the profile.</li> <li>• Can be edited and saved.</li> <li>• Can be edited and saved as a separate plate file.</li> <li>• Contains the thermal protocol for the real-time PCR.</li> <li>• Contains the sample information. The sample information can be edited on the desktop software or on the Connect platform after the run is complete.</li> <li>• Contains the target information. The target information can be edited on the desktop software or on the Connect platform after the run is complete.</li> <li>• Sample information and target information can be edited on the instrument.</li> <li>• If the sample information and the target information for the last run were added on the desktop software or on Connect after the run was complete, they will not be included on the plate file that is on the instrument.</li> </ul>	Instrument
Data file	<ul style="list-style-type: none"> <li>• Contains the real-time PCR data.</li> <li>• Can be viewed on the instrument only immediately after the run is complete.</li> <li>• Transfer to Connect or to the desktop software to view and analyze data.</li> </ul>	Instrument (limited) Desktop Connect

### Compatibility of plate files

The plate files are specific to the instrument.

A plate file for a QuantStudio™ 6 Pro System can only be opened on this instrument. It cannot be opened on a QuantStudio™ 7 Pro System.

A plate file for a QuantStudio™ 7 Pro System can only be opened on this instrument. It cannot be opened on a QuantStudio™ 6 Pro System.



## Components of the files

Component	Instrument	Desktop	Connect
Properties	<ul style="list-style-type: none"> <li>Data file name</li> <li>Reagent information               <ul style="list-style-type: none"> <li>Name</li> <li>Type</li> <li>Lot number</li> <li>Barcode</li> <li>Catalog number</li> <li>Expiry date</li> </ul> </li> <li>Plate barcode</li> <li>Location to send data after the run is complete</li> </ul>	<ul style="list-style-type: none"> <li>Experiment file name</li> <li>Plate barcode</li> <li>User name</li> <li>Instrument type</li> <li>Block type</li> <li>Analysis module</li> <li>Chemistry (reagent information)</li> <li>Run mode</li> <li>Comments</li> <li><i>{Connect platform only}</i> Notifications</li> </ul>	
Method	Thermal cycling conditions <ul style="list-style-type: none"> <li>Temperature</li> <li>Time</li> <li>Cover temperature</li> <li>Reaction volume</li> <li>Data collection points</li> <li>Ramp rates</li> <li>VeriFlex™ Zones</li> <li>Auto Delta settings</li> </ul>	Thermal cycling conditions	
Plate	Sample names Targets SNP assays	Define and assign samples, targets or SNP assays, and tasks in the <b>Plate setup</b> screen.	
Run	Monitor a run in progress View time remaining, temperature, method, and amplification plots Pause, resume, or stop a run	Monitor a run in progress View time remaining	Monitor a run in progress (link to Connect <b>Instrument Details</b> ) View time remaining, temperature, method, and amplification plots
Results	Not applicable	Review plots	
Export	Export results Data files are transferred to the desktop software or the Connect platform for analysis	Export results	

**Third-party software**

Before installing third-party software on the computer running the desktop software, confirm that the third-party software will not do the following:

- Restrict Ethernet communication.
- Interfere with instrument or computer operation.

**Network connection options**

You can connect an instrument to a network or computer in the configurations listed below. For more information, see Appendix B, "Connect the instrument to a network".

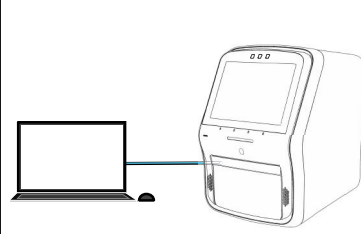
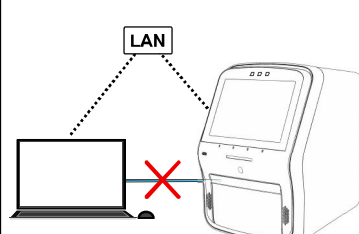
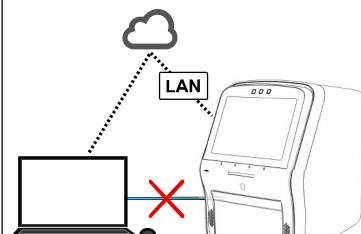
Direct connection	Local area network (LAN) connection	Connect platform connection
wired	wired <i>or</i> wireless	wired <i>or</i> wireless
		

**Types of runs**

**Standard curve run**

A standard curve run determines the absolute target quantity in samples.

1. The software measures amplification of the target in a standard dilution series and in test samples.
2. The software generates a standard curve using data from the standard dilution series.
3. The software uses the standard curve to interpolate the absolute quantity of target in the test samples.

**Relative standard curve run**

A relative standard curve run determines the relative target quantity in samples.

1. The software measures amplification of the target of interest and of an endogenous control target in a standard dilution series, in a reference (calibrator) sample, and in test samples.

The endogenous control is a target that is expressed equally in all samples; examples of endogenous controls are  $\beta$ -actin, GAPDH, and 18S ribosomal RNA. The software can algorithmically incorporate multiple endogenous control targets in relative quantification calculations.

The reference sample is used as the basis for relative quantification results (or 1 $\times$  sample). For example, in a study of drug effects on gene expression, an untreated control is an appropriate reference sample.

2. The software generates standard curves for the target of interest and the endogenous control using data from the corresponding standard dilution series.
3. The software uses the standard curves to interpolate the quantities of the target of interest and the endogenous control in each sample. The target quantity in each sample is then normalized to the sample's endogenous control quantity.
4. To determine the relative quantity of the target in test samples, the software divides the normalized target quantity in the sample by the normalized target quantity in the reference sample.

**Comparative  $C_t$  ( $\Delta\Delta C_t$ ) run**

A comparative  $C_t$  ( $\Delta\Delta C_t$ ) run determines the relative target quantity in samples.

1. The software measures amplification of the target of interest and of an endogenous control target in a reference (calibrator) sample and in test samples.

The endogenous control is a target that is expressed equally in all samples; examples of endogenous controls are  $\beta$ -actin, GAPDH, and 18S ribosomal RNA. The software can algorithmically incorporate multiple endogenous control targets in relative quantification calculations.

The reference sample is used as the basis for relative quantification results (or 1 $\times$  sample). For example, in a study of drug effects on gene expression, an untreated control is an appropriate reference sample.

2. The measurements for the target of interest are normalized to the endogenous control.
3. To determine the relative quantity of the target in test samples, the software compares the normalized  $\Delta C_q$  ( $\Delta C_t$  or  $\Delta C_{rt}$ ) for the sample to the normalized  $\Delta C_q$  ( $\Delta C_t$  or  $\Delta C_{rt}$ ) for the reference sample.



## Genotyping run

A genotyping run detects the single nucleotide polymorphism (SNP) variants of a target nucleic acid sequence.

Genotyping experiments use preformulated TaqMan<sup>®</sup> SNP Genotyping Assays that include the following components:

- Two sequence-specific primers for amplification of sequences containing the SNP of interest
  - Two allele-specific TaqMan<sup>®</sup> probes for Allele 1 and Allele 2
1. The software normalizes the fluorescence of the reporter dyes to the fluorescence of the passive reference dye in each well.
  2. The software plots the normalized reporter dye signal of each sample well on an Allelic Discrimination Plot, which contrasts the reporter dye intensities of the allele-specific probes.
  3. The software algorithmically clusters the sample data, and assigns a genotype call to the samples of each cluster according to its position on the plot.

## Presence/absence run

Presence/absence run determines the presence or absence of a target nucleic acid sequence in a sample.

The software calls the target present or absent based on an algorithmically determined call threshold. (The call threshold is different from the  $C_t$  threshold; the  $C_t$  threshold is not used to make calls.)

## Melt curve run

Melt curve run determines the melting temperature ( $T_m$ ) of the amplification products of a PCR that used intercalating dyes.

In the software, melt curve analysis is included in the default run method for any experiment type that uses intercalating dyes.

1. The software plots a melt curve based on the fluorescence of the dye with respect to change in temperature.
2. Using the melt curve, the software calculates the melting temperature ( $T_m$ ).

## System template file names

The first part of the file name varies, based on the instrument (QuantStudio<sup>™</sup> 6 Pro System or QuantStudio<sup>™</sup> 7 Pro System).

System template name	Run type
QS7Pro-96-Well-0-2ml_GT_Fast.edt	<ul style="list-style-type: none"> <li>• Genotyping run</li> <li>• 96-well, 0.2-mL Standard plate</li> <li>• Fast cycling mode</li> </ul>
QS7Pro-96-Well-0-2ml_GT_Std.edt	<ul style="list-style-type: none"> <li>• Genotyping run</li> <li>• 96-well, 0.2-mL Standard plate</li> <li>• Standard cycling mode</li> </ul>

System template name	Run type
QS7Pro-96-Well-0-2ml_Melt_Fast.edt	<ul style="list-style-type: none"> <li>Melt curve run (no PCR stage)</li> <li>96-well, 0.2-mL Standard plate</li> <li>Fast cycling mode</li> </ul>
QS7Pro-96-Well-0-2ml_Melt_Std.edt	<ul style="list-style-type: none"> <li>Melt curve run (no PCR stage)</li> <li>96-well, 0.2-mL Standard plate</li> <li>Standard cycling mode</li> </ul>
QS7Pro-96-Well-0-2ml_PA_Fast.edt	<ul style="list-style-type: none"> <li>Presence/absence run</li> <li>96-well, 0.2-mL Standard plate</li> <li>Fast cycling mode</li> </ul>
QS7Pro-96-Well-0-2ml_PA_Std.edt	<ul style="list-style-type: none"> <li>Presence/absence run</li> <li>96-well, 0.2-mL Standard plate</li> <li>Standard cycling mode</li> </ul>
QS7Pro-96-Well-0-2ml_PCR_Melt_Fast.edt	<ul style="list-style-type: none"> <li>Melt curve run (with PCR stage)</li> <li>96-well, 0.2-mL Standard plate</li> <li>Fast cycling mode</li> </ul>
QS7Pro-96-Well-0-2ml_PCR_Melt_Std.edt	<ul style="list-style-type: none"> <li>Melt curve run (with PCR stage)</li> <li>96-well, 0.2-mL Standard plate</li> <li>Standard cycling mode</li> </ul>
QS7Pro-96-Well-0-2ml_RQ_Fast.edt	<ul style="list-style-type: none"> <li>Comparative C<sub>t</sub> run</li> <li>96-well, 0.2-mL Standard plate</li> <li>Fast cycling mode</li> </ul>
QS7Pro-96-Well-0-2ml_RQ_Std.edt	<ul style="list-style-type: none"> <li>Comparative C<sub>t</sub> run</li> <li>96-well, 0.2-mL Standard plate</li> <li>Standard cycling mode</li> </ul>
QS7Pro-96-Well-0-2ml_RSC_Fast.edt	<ul style="list-style-type: none"> <li>Relative standard curve run</li> <li>96-well, 0.2-mL Standard plate</li> <li>Fast cycling mode</li> </ul>
QS7Pro-96-Well-0-2ml_RSC_Std.edt	<ul style="list-style-type: none"> <li>Relative standard curve run</li> <li>96-well, 0.2-mL Standard plate</li> <li>Standard cycling mode</li> </ul>
QS7Pro-96-Well-0-2ml_SC_Fast.edt	<ul style="list-style-type: none"> <li>Standard curve run</li> <li>96-well, 0.2-mL Standard plate</li> <li>Fast cycling mode</li> </ul>



System template name	Run type
QS7Pro-96-Well-0-2ml_SC_Std.edt	<ul style="list-style-type: none"> <li>• Standard curve run</li> <li>• 96-well, 0.2-mL Standard plate</li> <li>• Standard cycling mode</li> </ul>

## Workflow

Sign in to your instrument profile or your Connect account

(PIN or facial authentication)



Open a plate file

(System template or saved plate file)



*(Optional)* Edit the plate file



Load the plate into the instrument



Start the run



Unload the plate from the instrument



*(Optional)* Transfer the data file

(A location to transfer the data file might have been selected before the run. The data file only needs to be transferred manually after the run in order to transfer to a new location.)



# Instrument specifications and layout

- Instrument dimensions ..... 113
- Electrical requirements ..... 116
- Environmental requirements ..... 116

## Instrument dimensions

The instrument, including a block, has a total weight of 35.85 kg.

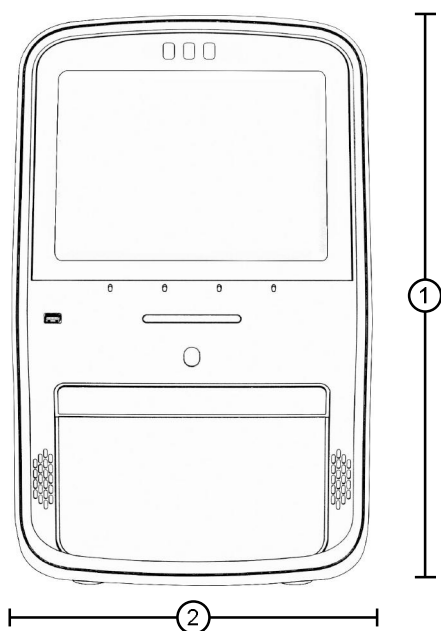

- ① Height: 54.7 cm
- ② Width: 33.7 cm

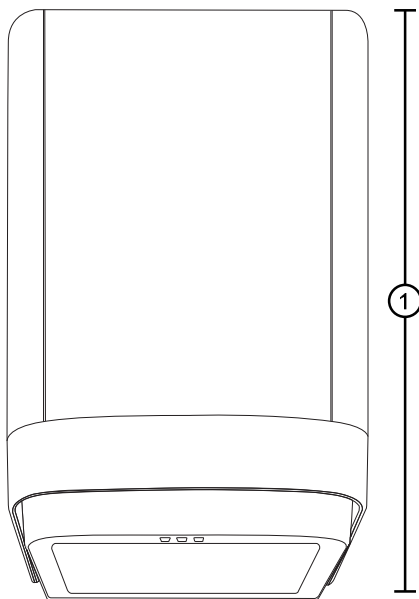

① Depth: 52.5 cm

**Instrument and computer clearances**

During instrument installation and maintenance, it is necessary to access the back of the instrument. If the back of the instrument faces a wall, ensure that there is sufficient clearance on the bench to rotate the instrument for access.

---

**IMPORTANT!** For safety, the power outlet for the instrument must be accessible.

---

Component	Top	Front	Sides	Back
Instrument	30.5 cm (12 in.)	30.5 cm (12 in.)	—	15.25 cm (6 in.)
Computer <sup>[1]</sup>	—	15.25 cm (6 in.)	—	15.25 cm (6 in.)

<sup>[1]</sup> Co-locating the computer with the instrument is optional.



**Configured system dimensions**

Allow space for the configured instrument.

It is not a requirement to locate the computer next to the instrument. The clearances for the instrument shown in the figures also apply to an instrument without a computer.

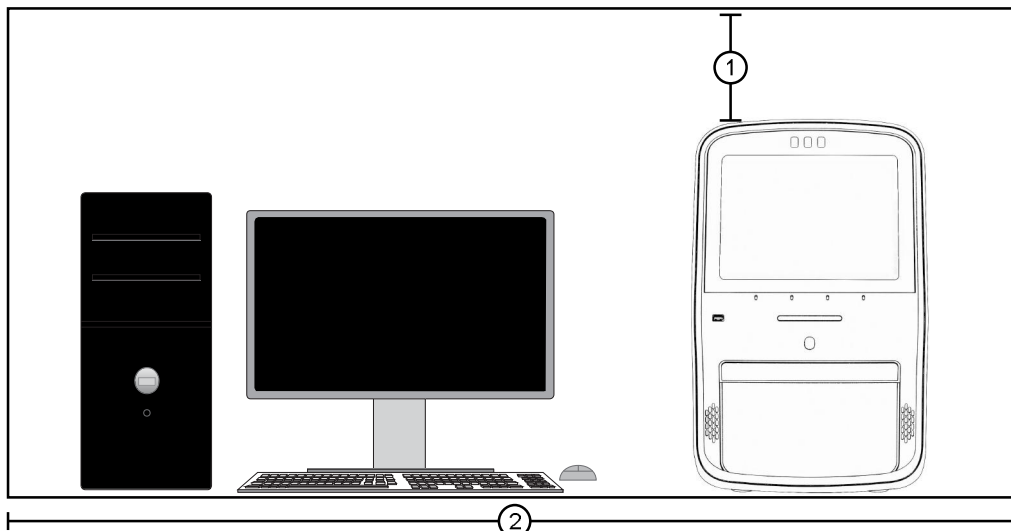

- ① Top clearance for the instrument: 30.5 cm
- ② Width of system: 185 cm

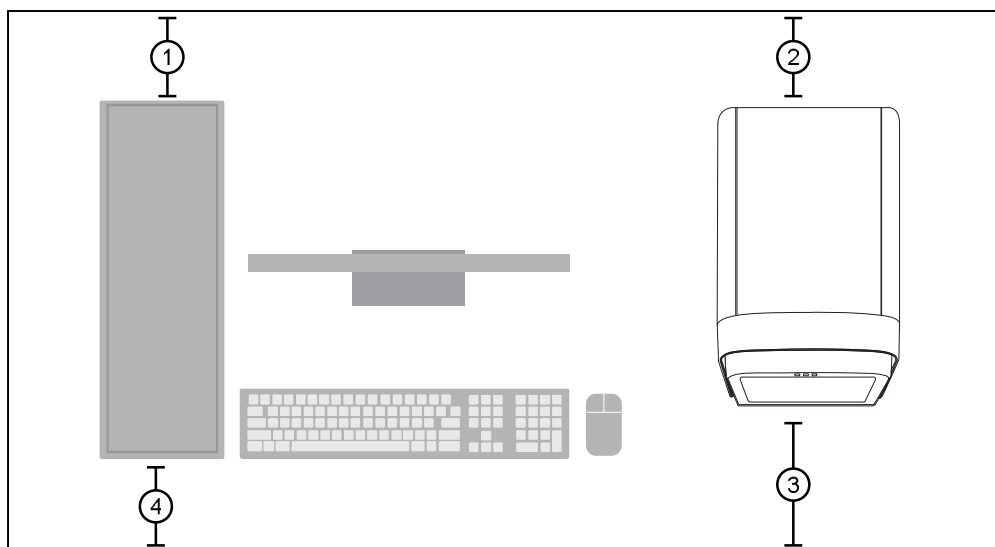

- ① Back clearance for the computer: 15.25 cm
- ② Back clearance for the instrument: 15.25 cm
- ③ Front clearance for the instrument: 30.5 cm
- ④ Front clearance for the computer: 15.25 cm



## Electrical requirements

**CAUTION!** Do not unpack or plug in any components until they are configured for the proper operating voltage by the service representative.

**WARNING!** For safety, the power outlet for the instrument must be accessible at all times. See “Instrument dimensions” on page 113 for information about the space needed between the wall and the instrument. In case of emergency, you must be able to immediately disconnect the main power supply to all the equipment. Allow adequate space between the wall and the equipment so that the power cords can be disconnected in case of emergency.

- Electric receptacle required: Grounding capability required
- Maximum power dissipation: ~417 VA, 371 W (not including computer and monitor)
- Mains AC line voltage tolerances must be up to ±10 percent of nominal voltage

Device	Rated voltage	Circuit required	Rated frequency	Rated power
Instrument	100–240 ±10% VAC <sup>[1]</sup>	10 A	50/60 Hz	960 W
Computer (desktop)	100-240 ± 10% VAC	10 A	50/60 Hz	125 VA
Monitor				65 VA
Computer (laptop)	100-240 ± 10% VAC	10 A	50/60 Hz	90 VA

<sup>[1]</sup> If the supplied power fluctuates beyond the rated voltage, a power line regulator may be required. High or low voltages can adversely affect the electronic components of the instrument.

## Environmental requirements

Condition	Acceptable range
Installation site	Indoor use only
Electromagnetic interference	Do not use this device in close proximity to sources of strong electromagnetic radiation (for example, unshielded intentional RF sources). Strong electromagnetic radiation may interfere with the proper operation of the device.  This equipment has been designed and tested to CISPR 11 Class A. In a domestic environment it may cause radio interference. You may need to take measures to mitigate the interference.
Altitude	Located between sea level and 2000 m (6500 ft.) above sea level
Humidity (instrument and computer)	Operation: 15%–80% (noncondensing) Transport and storage:



Condition	Acceptable range
Temperature (instrument and computer)	15°C to 30°C (60°F to 85°F) <b>Note:</b> The room temperature must not fluctuate more than 2°C over a 2-hour period. Transport and storage:
Transient category	Installation categories II
Overvoltage category	Installation categories II
Vibration	The instrument is not adjacent to strong vibration sources, such as a centrifuge, pump, or compressor. Excessive vibration will affect instrument performance.
Pollution degree	II Install the instrument in an environment that has nonconductive pollutants such as dust particles or wood chips. Typical environments with a Pollution Degree II rating are laboratories and sales and commercial areas.
Liquid waste collection	Dispose of the polymer, buffer, reagents and any liquid waste as hazardous waste in compliance with local and national regulations.
Other conditions	Ensure the room is away from any vents that could expel particulate material on the components. Avoid placing the instrument and computer adjacent to heaters, cooling ducts, or in direct sunlight.



# Connect the instrument to a network

- Connect the computer to the instrument directly or to a LAN ..... 118
- Connect the instrument to a wired network ..... 119
- Connect the instrument to a wireless network ..... 120
- Instrument and computer connections ..... 121
- Download and install the desktop software ..... 122
- Networking ..... 123

## Connect the computer to the instrument directly or to a LAN

This section describes direct wired connection of the computer provided by Thermo Fisher Scientific to the instrument or to a LAN.

Do not connect a customer-provided computer to the instrument.

1. Connect an Ethernet cable from the instrument or a LAN to the computer.
2. Power on the computer, then log in using a Windows™ Administrator account.
3. In the Windows™ desktop, right-click **My Network Places** ▶ **Properties**.
4. Right-click **Local Area Connection**, then select **Properties**.
5. Select **Internet Protocol (TCP/IP)** ▶ **Properties**.



6. Set the Internet Protocol (TCP/IP) Properties for either DHCP or Static IP communication:

Network configuration	Action
DHCP	<ol style="list-style-type: none"> <li>1. Select <b>Obtain an IP address automatically</b>.</li> <li>2. Set the DNS address. If the computer obtains DNS addresses:                             <ul style="list-style-type: none"> <li>• Automatically – Select <b>Obtain DNS server address automatically</b>.</li> <li>• Statically – Select <b>Use the following DNS address</b>, then enter the address of the preferred and alternate DNS servers (if available).</li> </ul> </li> </ol>
Static IP	<ol style="list-style-type: none"> <li>1. Select <b>Use the following IP address</b>.</li> <li>2. In the <b>IP Address</b> field, enter the static IP address.</li> <li>3. If necessary, enter a subnet mask.</li> <li>4. If necessary, enter a static gateway address in the <b>Default Gateway</b> field.</li> </ol>

7. If your network requires advanced TCP/IP setup (such as WINS), define the settings:
  - a. Click **Advanced** in the Internet Protocol (TCP/IP) Properties dialog box.
  - b. Define the IP Settings, DNS, and WINS tabs as instructed by your systems administrator, then click **OK**.
8. Close all dialog boxes by clicking **OK**, then re-start the computer.  
The computer is now visible to other computers on the network.

## Connect the instrument to a wired network

1. In the home screen, tap  (**Settings**) ▶ **Instrument settings** ▶ **Network configuration**.  
The **Network Connections** screen is displayed.
2. Tap **Edit**.
3. Tap one of the active fields found under the **Wired** option.



4. Select a wired network connection:

Wired network connection	Action
DHCP	No further action is required.
Static IP	<ol style="list-style-type: none"> <li>1. In the <b>IP Address</b> field, enter the static IP address.</li> <li>2. If necessary, enter a subnet mask.</li> <li>3. If necessary, enter a static gateway address in the <b>Default Gateway</b> field.</li> </ol>

5. Tap **Done**.  
 The **Network Connections** screen is displayed. The **Status** and **IP Address** fields under the **Wired** option have the information from the selected wired network.
6. Tap **Done**.

This instrument is now connected to the selected wired network.

## Connect the instrument to a wireless network

1. In the home screen, tap (**Settings**) ▶ **Instrument settings** ▶ **Network configuration**.  
 The **Network Connections** screen is displayed.
2. Tap **Edit**.
3. Tap one of the active fields found under the **Wireless** option.
4. Select a wireless network to connect to the instrument.
5. (Optional) Tap **Refresh** to prompt the instrument to search for available wireless networks.
6. Tap **Done**.  
 The **Network Connections** screen is displayed. The **Status**, **Network**, and **IP Address** fields under the **Wireless** option are filled with the information from the selected wireless network.
7. Tap **Done**.

This instrument is now connected to the selected wireless network.

## Instrument and computer connections

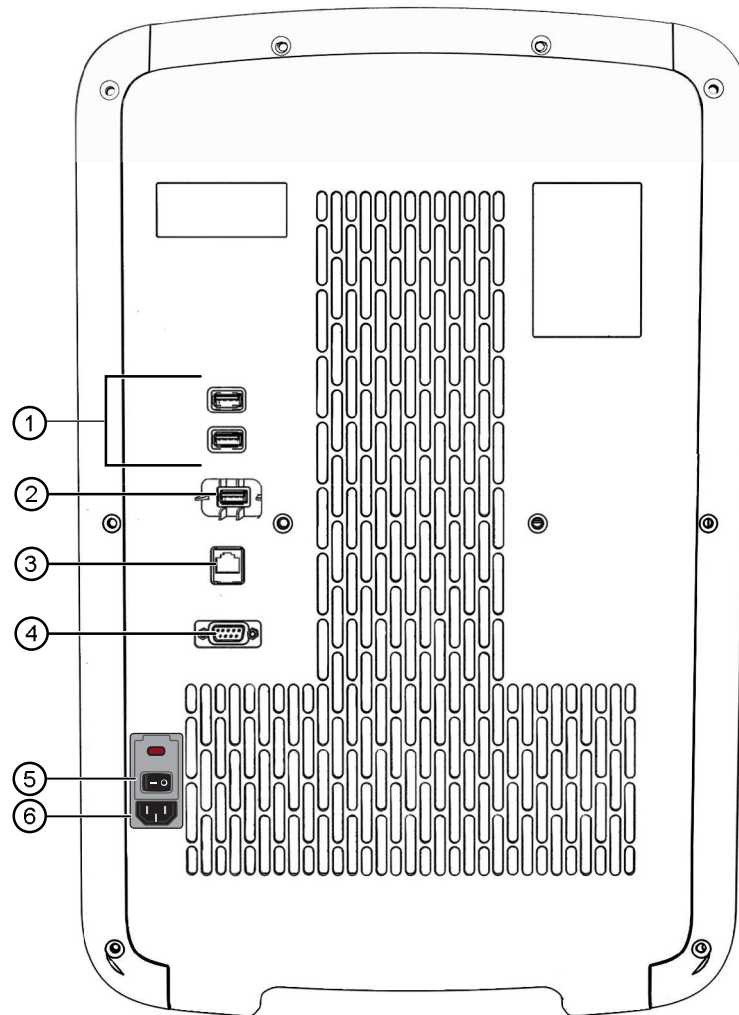

**Figure 10** Instrument back panel

- ① USB ports
- ② Wi-Fi dongle port
- ③ Ethernet port
- ④ RS-232 port (service use only)
- ⑤ ON/OFF switch
- ⑥ Power inlet receptacle

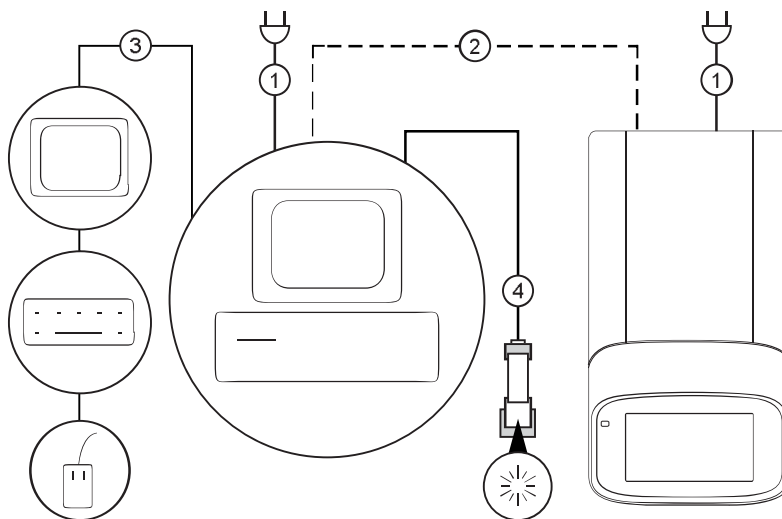

**Figure 11** Instrument-to-computer connections (minitower configuration)

- ① Detachable power supply cord compatible with local power supply receptacle.
- ② Connection between the computer and the instrument.
- ③ Connection between the computer and the monitor, keyboard, and mouse.
- ④ Connection between the computer and the *optional* handheld barcode scanner.

## Download and install the desktop software

### Computer requirements for the desktop software

The desktop software can be installed on a customer-provided computer. The following list contains the minimum software requirements for a customer-provided computer.

- Operating system—Windows™ 10 (64-bit) or Macintosh™ OS 10.01
- Processor—Pentium® 4 processor or comparable
- Memory—4 GB RAM
- Hard drive—10 GB
- Monitor—1280 × 1024 resolution

### Download the desktop software

1. Go to [thermofisher.com/qpcrsoftware](http://thermofisher.com/qpcrsoftware).
2. Select the link for the QuantStudio™ 6 Pro and 7 Pro Real-Time PCR Systems.
3. Download the software and the example files.





## Install the desktop software

If you ordered a computer supplied by Thermo Fisher Scientific, the Field Service Engineer will configure the computer and install the desktop software during system installation.

1. Use an administrator account to log in to the computer on which you are installing the desktop software.
2. Unzip the downloaded software and example files.
3. Double-click **setup.exe**.
4. Follow the **InstallShield Wizard** prompts to install the software.
5. Accept the License Agreement.
6. Select **Typical** as the setup preference, then click **Next**.
7. Click **Finish**.

## Networking

---

**IMPORTANT!** This section provides general networking information. It *does not* provide adequate detail to integrate the instrument into all possible network architectures. Because a network may contain advanced features (such as a firewall or network domains), we recommend that you consult a network administrator before connecting the instrument to your laboratory network.

---

## Supported options for instrument and computer connections

We support the following direct, networked (LAN—local area network), or Connect cloud-based platform configurations. Configurations other than those listed are not recommended. Select a configuration that meets the needs of your laboratory's instrument, software, and workflow requirements.

**Note:** For detailed information about networking your instrument, see the *QuantStudio™ 6 Pro and 7 Pro Real-Time PCR Systems IT Checklist* (Pub. No. MAN0018160).

### Connect cloud-based platform connection

- Internet access and a computer with the Chrome™ web browser to access the Connect platform.



Connect cloud-based platform connection	
<ul style="list-style-type: none"> <li>Computer-to-Connect platform connection <i>(select an option)</i>:                             <ul style="list-style-type: none"> <li>Wired connection to the internet using an Ethernet cable – or –</li> <li>Wireless connection to the internet</li> </ul> </li> </ul>	
<ul style="list-style-type: none"> <li>Instrument-to-Connect platform connection <i>(select an option)</i>:                             <ul style="list-style-type: none"> <li>Wired connection to the network using an Ethernet cable – or –</li> <li>Wireless connection to the network using the instrument Wi-Fi module</li> </ul> </li> </ul>	
Local area network (LAN) connection	
<ul style="list-style-type: none"> <li>A computer provided by Thermo Fisher Scientific with the QuantStudio™ Design and Analysis Desktop Software.</li> <li>The computer and instrument must be on the same subnet mask.</li> </ul>	
<ul style="list-style-type: none"> <li>Computer-to-LAN connection <i>(select an option)</i>:                             <ul style="list-style-type: none"> <li>Wired connection to the network using an Ethernet cable – or –</li> <li>Wireless connection to the network</li> </ul> </li> </ul>	
<ul style="list-style-type: none"> <li>Instrument-to-LAN connection <i>(select an option)</i>:                             <ul style="list-style-type: none"> <li>Wired connection to the network using an Ethernet cable – or –</li> <li>Wireless connection to the network using the instrument Wi-Fi module</li> </ul> </li> </ul>	
Direct connection	
<ul style="list-style-type: none"> <li>A computer provided by Thermo Fisher Scientific with the QuantStudio™ Design and Analysis Desktop Software.</li> </ul>	
<ul style="list-style-type: none"> <li>Computer-to-instrument connection: Direct, wired connection between the computer and the instrument using an Ethernet cable.</li> </ul> <p><b>IMPORTANT!</b> A direct instrument-to-computer connection <i>cannot</i> be combined with the LAN or the Connect cloud-based platform configurations.</p>	

**Control and monitor networked instruments**

The following items apply when the instrument is connected to a network:

- Computers on the network that are running the desktop software can control the instrument. Networked instruments can be controlled by only one computer at a time.
- Instruments linked to the Connect cloud-based platform cannot be controlled remotely. The following functions can be performed:
  - Remotely access the Connect cloud-based platform to create plate files and analyze data files.
  - Send plate files to the instrument run queue, then start a run from the instrument.
  - Monitor a run in real-time from the Connect cloud-based platform.



**Networking guidelines and best practices**

- Consult a network administrator before connecting the instrument to a network.
- To enable the full functionality of the software, the computer requires a network connection.
- Open the firewall port for the instruments to be discovered. See “Firewall ports that must be open” on page 125.
- Observe the restrictions to mDNS and Autodiscovery.  
The instrument supports mDNS but only when the instrument and computer share a direct network connection and are within the same subnet. Network computers that are separated from the instrument by a router, hub, or another network device may not be able to access the instrument by its host name.
- Confirm the uniqueness of the instrument name.
  - The instrument name must be unique within the subnet. The desktop software can automatically discover instruments on the link-local network.
  - The instrument does not test the uniqueness of the instrument name within the subnet when it is set.

**Firewall ports that must be open**

Ports	Condition
80/443	Standard ports for instrument-to-Connect platform and computer-to-Connect platform connections
mDNS, 7000	Instrument-to-computer connection
mDNS, 5353	Instrument discovery

**Ethernet port overview**

The Ethernet port of the instrument supports:

- Static IP network service with subnet mask, primary and secondary data network service (DNS), and default gateway settings, or dynamic host configuration protocol (DHCP) network service.
- mDNS/DNS for local domains.  
**Note:** Because mDNS is limited to direct network connections, an instrument configured for mDNS may not be visible to other nodes that are separated by a router, hub, or another network device.
- IPv4 linklocal (IPV4LL) in the RFC (also known as Automatic Private IP Addressing [APIPA] or Internet Protocol Automatic Configuration [IPAC]).  
**Note:** When an instrument is set for DHCP, APIPA is automatically enabled, and the instrument provides an IP address when no address is supplied by the DHCP server.

**Third-party software**

Before installing third-party software on the computer running the desktop software, confirm that the third-party software will not do the following:

- Restrict Ethernet communication.
- Interfere with instrument or computer operation.



# Parts and materials

## Kits, consumables, accessories, and reagents

Unless otherwise indicated, all materials are available through [thermofisher.com](http://thermofisher.com).

Store all calibration and RNase P plates at  $-20^{\circ}\text{C}$ . All other items can be stored at  $15\text{--}30^{\circ}\text{C}$ . Use all materials by the expiration date on the packaging.

## Consumables (96-well, 0.2-mL format)

Consumable	Amount	Cat. No.
MicroAmp™ Optical 8-Cap Strips	300 strips	4323032
MicroAmp™ Optical 8-Tube Strip, 0.2 mL	125 strips	4316567
MicroAmp™ Optical Tube without Cap, 0.2 mL	2,000 tubes	N8010933
MicroAmp™ Optical 96-Well Reaction Plate with Barcode	20 plates	4306737
	500 plates	4326659
MicroAmp™ EnduraPlate™ Optical 96-Well Clear GPLE Reaction Plates with Barcode	20 plates	4483348
	500 plates	4483351

Instrument verification or calibration plate	Cat. No.
TaqMan® RNase P Instrument Verification Plate, 96-Well 0.2-mL	4432382
Region of Interest (ROI) and Background Plates, 96-Well 0.2-mL (2 plates)	4432364
QuantStudio™ 3/5 10-Dye Spectral Calibration Kit, 96-Well 0.2-mL (contains all 3 spectral calibration plates listed below)	A26343
QuantStudio™ 3/5 Spectral Calibration Plate 1 (FAM™, VIC™, ROX™, and SYBR™ dyes), 96-Well 0.2-mL	A26331
QuantStudio™ 3/5 Spectral Calibration Plate 2, 96-Well 0.2-mL (ABY™, JUN™, and MUSTANG PURPLE™ dyes)	A26332
QuantStudio™ 3/5 Spectral Calibration Plate 3, 96-Well 0.2-mL (TAMRA™, NED™, and Cy®5 dyes)	A26333



## Accessories

Item	Amount	Cat. No.
MicroAmp™ 96-Well Tray/Retainer Set	10 trays	4381850
MicroAmp™ Multi Removal Tool	1 tool	4313950
MicroAmp™ Cap Installing Tool (handle style)	1 tool	4330015
MicroAmp™ Optical Adhesive Film	25 films	4360954
	100 films	4311971
MicroAmp™ Adhesive Film Applicator	5 applicators	4333183
RT-PCR Grade Water	10 × 1.5 mL tubes	AM9935
Handheld Barcode Scanner	1 scanner	4488442



# Safety

■ Symbols on this instrument .....	128
■ Safety information for instruments not manufactured by Thermo Fisher Scientific .....	135
■ Instrument safety .....	135
■ Safety and electromagnetic compatibility (EMC) standards .....	139
■ Chemical safety .....	144
■ Biological hazard safety .....	146

---

 **WARNING! GENERAL SAFETY.** Using this product in a manner not specified in the user documentation may result in personal injury or damage to the instrument or device. Ensure that anyone using this product has received instructions in general safety practices for laboratories and the safety information provided in this document.

- Before using an instrument or device, read and understand the safety information provided in the user documentation provided by the manufacturer of the instrument or device.
  - Before handling chemicals, read and understand all applicable Safety Data Sheets (SDSs) and use appropriate personal protective equipment (gloves, gowns, eye protection, and so on). To obtain SDSs, see the “Documentation and Support” section in this document.
- 

## Symbols on this instrument

Symbols may be found on the instrument to warn against potential hazards or convey important safety information. In this document, the hazard symbol is used along with one of the following user attention words.

- **CAUTION!**—Indicates a potentially hazardous situation that, if not avoided, may result in minor or moderate injury. It may also be used to alert against unsafe practices.
- **WARNING!**—Indicates a potentially hazardous situation that, if not avoided, could result in death or serious injury.
- **DANGER!**—Indicates an imminently hazardous situation that, if not avoided, will result in death or serious injury.





Standard safety symbols

Symbol and description	
	<b>CAUTION!</b> Risk of danger. Consult the manual for further safety information.
	<b>CAUTION!</b> Risk of electrical shock.
	<b>CAUTION!</b> Hot surface.
	<b>CAUTION!</b> Potential biohazard.
	<b>CAUTION!</b> Ultraviolet light.

Symbole et description	
	<b>MISE EN GARDE !</b> Risque de danger. Consulter le manuel pour d'autres renseignements de sécurité.
	<b>MISE EN GARDE !</b> Risque de choc électrique.
	<b>MISE EN GARDE !</b> Surface chaude.
	<b>MISE EN GARDE !</b> Danger biologique potentiel.
	<b>MISE EN GARDE !</b> Rayonnement ultraviolet.

**Additional safety symbols**

Symbol and description	
	<b>CAUTION!</b> Moving parts.

Symbole et description	
	<b>MISE EN GARDE !</b> Parties mobiles.

**Location of safety labels**

The instrument contains warnings at the locations shown in the figures below.

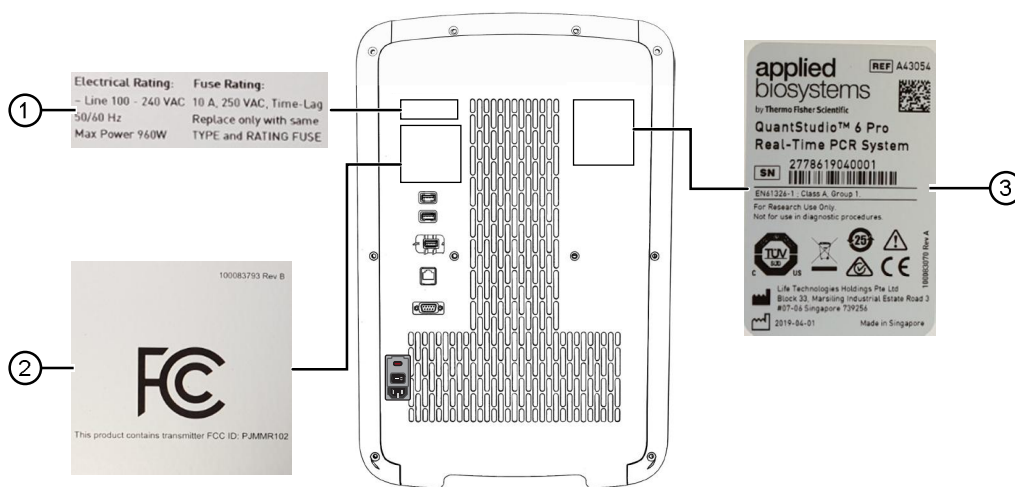

**Figure 12** Labels on the back of the instrument

- ① Electrical rating label
- ② RFID label
- ③ Safety label



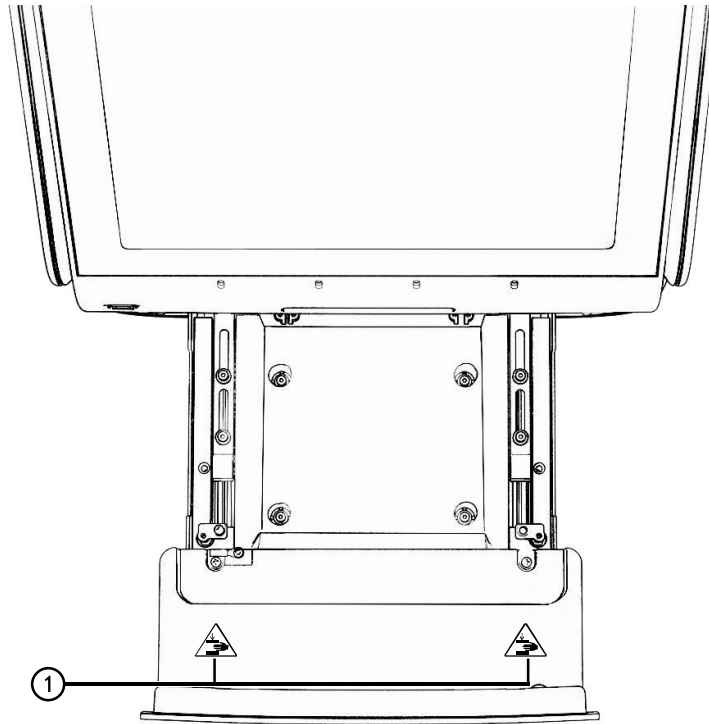

Figure 13 Labels on the drawer

① Moving parts label

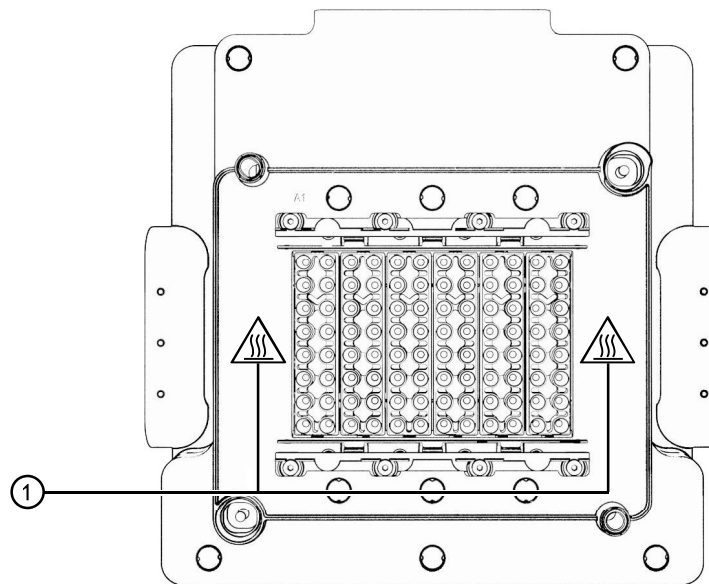

Figure 14 Labels on the top of the block

① Hot surface label

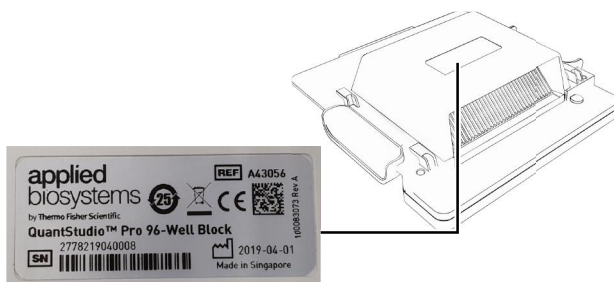

Figure 15 Labels on the bottom of the block

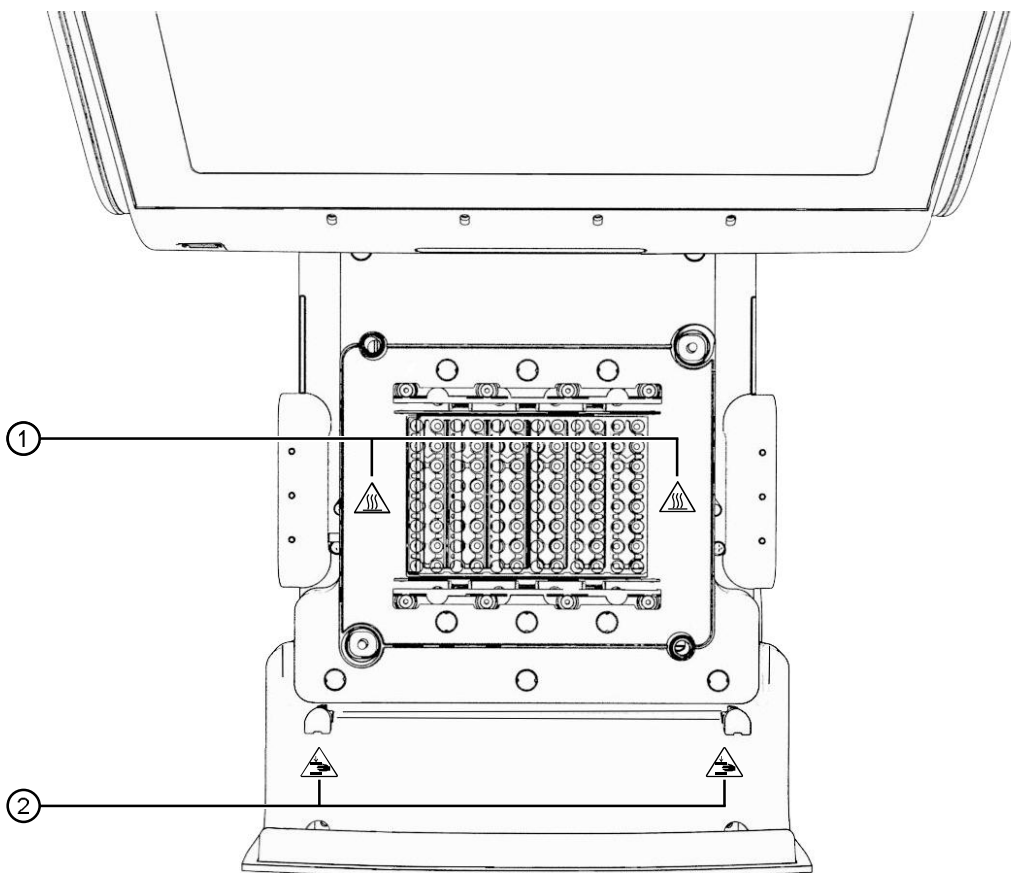

Figure 16 Labels on drawer and the installed block

- ① Hot surface label
- ② Moving parts label

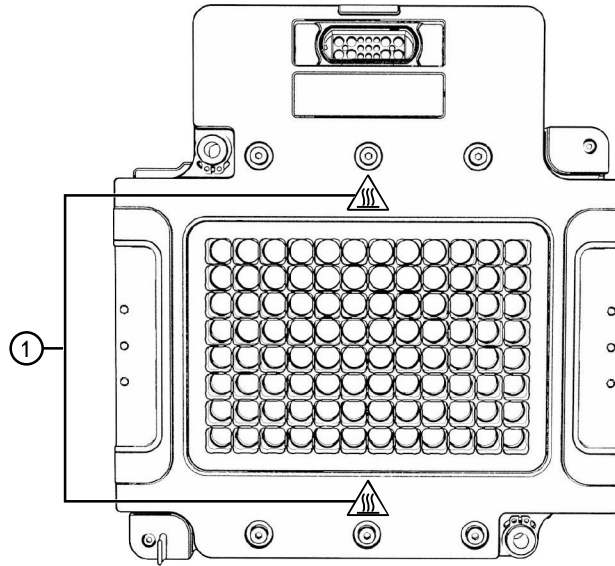

Figure 17 Labels on the top of the heated cover  
① Hot surface label

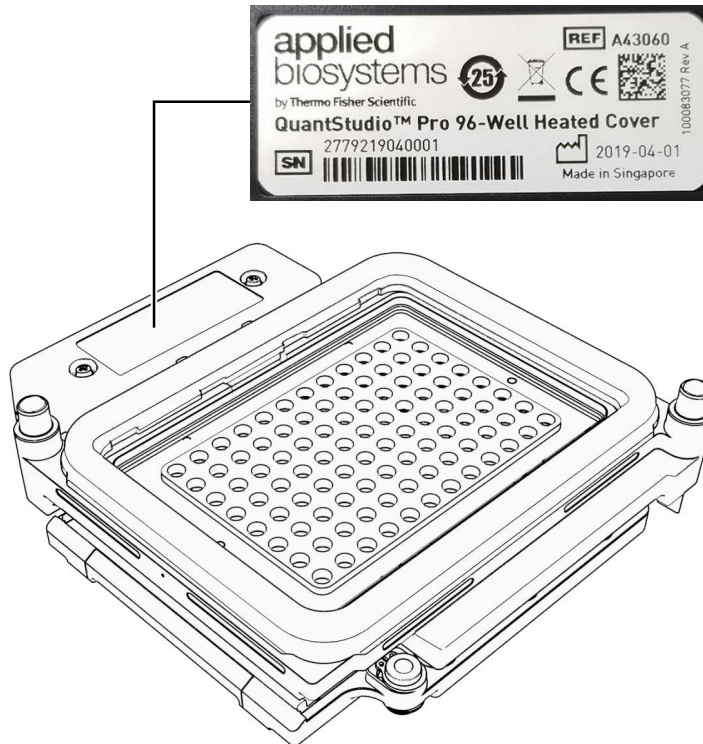









Figure 18 Labels on the bottom of the heated cover

**Control and connection symbols**

Symbols and descriptions	
	On (Power)
○	Off (Power)

**Conformity symbols**

Conformity mark	Description
	Indicates conformity with safety requirements for Canada and U.S.A.
	Indicates conformity with China RoHS requirements.
	Indicates conformity with European Union requirements.
	Indicates conformity with Australia/New Zealand standards for electromagnetic compatibility and radio frequency requirement.
	Indicates conformity with the WEEE Directive 2012/19/EU.   <b>CAUTION!</b> To minimize negative environmental impact from disposal of electronic waste, do not dispose of electronic waste in unsorted municipal waste. Follow local municipal waste ordinances for proper disposal provision and contact customer service for information about responsible disposal options.
	Indicates conformity with Brazil radio frequency standard.
	Indicates conformity with US radio frequency standard.



## Safety information for instruments not manufactured by Thermo Fisher Scientific

Some of the accessories provided as part of the instrument system are not designed or built by Thermo Fisher Scientific. Consult the manufacturer's documentation for the information needed for the safe use of these products.

### Instrument safety

#### General



**CAUTION! Do not remove instrument protective covers.** If you remove the protective instrument panels or disable interlock devices, you may be exposed to serious hazards including, but not limited to, severe electrical shock, laser exposure, crushing, or chemical exposure.

---



**CAUTION! Solvents and Pressurized fluids.** Wear eye protection when working with any pressurized fluids. Use caution when working with any polymeric tubing that is under pressure:

- Extinguish any nearby flames if you use flammable solvents.
  - Do not use polymeric tubing that has been severely stressed or kinked.
  - Do not use polymeric tubing with tetrahydrofuran or nitric and sulfuric acids.
  - Be aware that methylene chloride and dimethyl sulfoxide cause polymeric tubing to swell and greatly reduce the rupture pressure of the tubing.
  - Be aware that high solvent flow rates (~40mL/min) may cause a static charge to build up on the surface of the tubing and electrical sparks may result.
-



## Physical injury



---

**CAUTION! Moving and Lifting Injury.** The instrument is to be moved and positioned only by the personnel or vendor specified in the applicable site preparation guide. Improper lifting can cause painful and permanent back injury.

Things to consider before lifting or moving the instrument or accessories:

- Depending on the weight, moving or lifting may require two or more persons.
- If you decide to lift or move the instrument after it has been installed, do not attempt to do so without the assistance of others, the use of appropriate moving equipment, and proper lifting techniques.
- Ensure you have a secure, comfortable grip on the instrument or accessory.
- Make sure that the path from where the object is to where it is being moved is clear of obstructions.
- Do not lift an object and twist your torso at the same time. Keep your spine in a good neutral position while lifting with your legs.
- Participants should coordinate lift and move intentions with each other before lifting and carrying.
- For smaller packages, rather than lifting the object from the packing box, carefully tilt the box on its side and hold it stationary while someone else slides the contents out of the box.



---

**CAUTION! Moving Parts.** Moving parts can crush, pinch and cut. Keep hands clear of moving parts while operating the instrument. Disconnect power before servicing.

---



## Electrical safety

---

 **WARNING! Fuse Installation.** Before installing the instrument, verify that the fuses are properly installed and the fuse voltage matches the supply voltage. Replace fuses only with the type and rating specified for the unit. Improper fuses can damage the instrument wiring system and cause a fire.

---

 **AVERTISSEMENT ! Installation des fusibles.** Avant d'installer l'instrument, vérifiez que les fusibles sont correctement insérés et que leur tension correspond à celle fournie par le circuit d'alimentation. Ne remplacer les fusibles que par des modèles du type et de la puissance spécifiés pour l'appareil. L'utilisation de fusibles inadaptés peut endommager le circuit électrique de l'instrument et provoquer un incendie.

---

 **WARNING! Ensure appropriate electrical supply.** For safe operation of the instrument:

- Plug the system into a properly grounded receptacle with adequate current capacity.
- Ensure the electrical supply is of suitable voltage.
- Never operate the instrument with the ground disconnected. Grounding continuity is required for safe operation of the instrument.

---

 **AVERTISSEMENT ! Veiller à utiliser une alimentation électrique appropriée.** Pour garantir le fonctionnement de l'instrument en toute sécurité :

- Brancher le système sur une prise électrique correctement mise à la terre et de puissance adéquate.
- S'assurer que la tension électrique est convenable.
- Ne jamais utiliser l'instrument alors que le dispositif de mise à la terre est déconnecté. La continuité de la mise à la terre est impérative pour le fonctionnement de l'instrument en toute sécurité.

---

 **WARNING! Power Supply Line Cords.** Use properly configured and approved line cords for the power supply in your facility.

---

 **AVERTISSEMENT ! Cordons d'alimentation électrique.** Utiliser des cordons d'alimentation adaptés et approuvés pour raccorder l'instrument au circuit électrique du site.

---

 **WARNING! Disconnecting Power.** To fully disconnect power either detach or unplug the power cord, positioning the instrument such that the power cord is accessible.

---

 **AVERTISSEMENT ! Déconnecter l'alimentation.** Pour déconnecter entièrement l'alimentation, détacher ou débrancher le cordon d'alimentation. Placer l'instrument de manière à ce que le cordon d'alimentation soit accessible.

---



## Laser safety



**WARNING! LASER HAZARD.** The QuantStudio™ 6 Pro System and the QuantStudio™ 7 Pro System are compatible with an optional Handheld Barcode Scanner. Lasers can burn the retina, causing permanent blind spots. To ensure safe laser operation:

- Never look directly into the laser beam.
- Do not remove safety labels, instrument protective panels, or defeat safety interlocks.
- The system must be installed and maintained by a Thermo Fisher Scientific Technical Representative.
- Remove jewelry and other items that can reflect a laser beam into your eyes or those of others
- Wear proper eye protection and post a laser warning sign at the entrance to the laboratory if the laser protection is defeated for servicing
- DO NOT operate the laser when it cannot be cooled by its cooling fan; an overheated laser can cause severe burns on contact.

The following table lists laser safety symbols and alerts that may be present on the instrument.

Alert	
	<b>CAUTION! LASER HAZARD, Bar Code Scanner.</b> The bar code scanner included with the instrument is a Class 2 laser. To avoid damage to eyes, do not stare directly into the beam or point into another person's eyes.
Alerte	
	<b>MISE EN GARDE ! RISQUE LIÉ AU RAYONNEMENT LASER, Lecteur de code-barres.</b> Le lecteur de code-barres inclut dans l'instrument est un appareil laser de classe 2. Pour éviter toute lésion oculaire, ne regardez pas directement le faisceau et ne le dirigez pas vers les yeux d'une autre personne.





## Cleaning and decontamination



**CAUTION! Cleaning and Decontamination.** Use only the cleaning and decontamination methods that are specified in the manufacturer user documentation. It is the responsibility of the operator (or other responsible person) to ensure that the following requirements are met:

- No decontamination or cleaning agents are used that can react with parts of the equipment or with material that is contained in the equipment. Use of such agents could cause a HAZARD condition.
- The instrument is properly decontaminated a) if hazardous material is spilled onto or into the equipment, and/or b) before the instrument is serviced at your facility or is sent for repair, maintenance, trade-in, disposal, or termination of a loan. Request decontamination forms from customer service.
- Before using any cleaning or decontamination methods (except methods that are recommended by the manufacturer), confirm with the manufacturer that the proposed method will not damage the equipment.



**MISE EN GARDE ! Nettoyage et décontamination.** Utiliser uniquement les méthodes de nettoyage et de décontamination indiquées dans la documentation du fabricant destinée aux utilisateurs. L'opérateur (ou toute autre personne responsable) est tenu d'assurer le respect des exigences suivantes:

- Ne pas utiliser d'agents de nettoyage ou de décontamination susceptibles de réagir avec certaines parties de l'appareil ou avec les matières qu'il contient et de constituer, de ce fait, un DANGER.
- L'instrument doit être correctement décontaminé a) si des substances dangereuses sont renversées sur ou à l'intérieur de l'équipement, et/ou b) avant de le faire réviser sur site ou de l'envoyer à des fins de réparation, de maintenance, de revente, d'élimination ou à l'expiration d'une période de prêt (des informations sur les formes de décontamination peuvent être demandées auprès du Service clientèle).
- Avant d'utiliser une méthode de nettoyage ou de décontamination (autre que celles recommandées par le fabricant), les utilisateurs doivent vérifier auprès de celui-ci qu'elle ne risque pas d'endommager l'appareil.

## Instrument component and accessory disposal

To minimize negative environmental impact from disposal of electronic waste, do not dispose of electronic waste in unsorted municipal waste. Follow local municipal waste ordinances for proper disposal provision and contact customer service for information about responsible disposal options.

## Safety and electromagnetic compatibility (EMC) standards

The instrument design and manufacture complies with the following standards and requirements for safety and electromagnetic compatibility.



## Safety standards

Reference	Description
EU Directive 2014/35/EU	European Union “Low Voltage Directive”
IEC 61010-1 EN 61010-1 UL 61010-1 CAN/CSA C22.2 No. 61010-1	<i>Safety requirements for electrical equipment for measurement, control, and laboratory use – Part 1: General requirements</i>
IEC 61010-2-010 EN 61010-2-010	<i>Safety requirements for electrical equipment for measurement, control and laboratory use – Part 2-010: Particular requirements for laboratory equipment for the heating of materials</i>
IEC 61010-2-020 EN 61010-2-020	<i>Safety requirements for electrical equipment for measurement, control and laboratory use – Part 2-020: Particular requirements for laboratory centrifuges</i>
IEC 61010-2-081 EN 61010-2-081	<i>Safety requirements for electrical equipment for measurement, control and laboratory use – Part 2-081: Particular requirements for automatic and semi-automatic laboratory equipment for analysis and other purposes</i>

## EMC standards

Reference	Description
EMC Directive 2014/30/EU	European Union “EMC Directive”
IEC 61326-1	<i>Electrical Equipment for Measurement, Control and Laboratory Use – EMC Requirements – Part 1: General Requirements</i>
AS/NZS CISPR 11	<i>Limits and Methods of Measurement of Electromagnetic Disturbance Characteristics of Industrial, Scientific, and Medical (ISM) Radiofrequency Equipment</i>
ICES-003, Issue 6	<i>Industrial, Scientific and Medical (ISM) Radio Frequency Generators</i>
FCC Part 15 Subpart B (47 CFR)	<i>U.S. Standard Radio Frequency Devices</i>



## Environmental design standards

Reference	Description
Directive 2012/19/EU	European Union “WEEE Directive”—Waste electrical and electronic equipment
Directive 2011/65/EU	European Union “RoHS Directive”—Restriction of hazardous substances in electrical and electronic equipment
SJ/T 11364-2014	<p>“China RoHS” Standard—Marking for the Restricted Use of Hazardous Substances in Electronic and Electrical Products</p> <p>For instrument specific certificates, visit our customer resource page at <a href="http://www.thermofisher.com/us/en/home/technical-resources/rohs-certificates.html">www.thermofisher.com/us/en/home/technical-resources/rohs-certificates.html</a>.</p>

## Radio compliance standards

Reference	Description
Directive 2014/53/EU	<p>European Union “RE Directive”—Radio equipment</p> <p>Hereby, Thermo Fisher Scientific declares that the radio equipment type: QuantStudio™ 6 Pro Real-Time PCR System and QuantStudio™ 7 Pro Real-Time PCR System are in compliance with Radio Equipment Directive 2014/53/EU. The full text of the EU declaration of conformity is available at <a href="http://thermofisher.com">thermofisher.com</a>.</p>
FCC Part 15	<p>Contains FCC ID: 2ADEZMRM102A</p> <p>FCC Notice (for U.S. Customers):</p> <p>This device complies with Part 15 of the FCC Rules:</p> <p>Operation is subject to the following conditions:</p> <ol style="list-style-type: none"> <li>1. This device may not cause harmful interference, and</li> <li>2. This device must accept any interference received, including interference that may cause undesired operation.</li> </ol> <p>Changes and modifications not expressly approved by Thermo Fisher Scientific can void your authority to operate this equipment under Federal Communications Commissions rules.</p> <p><b>Note:</b> This equipment has been tested and found to comply with the limits for a Class A digital device, pursuant to part 15 of the FCC Rules. These limits are designed to provide reasonable protection against harmful interference when the equipment is operated in a commercial environment. This equipment generates, uses, and can radiate radio frequency energy and, if not installed and used in accordance with the instruction manual, may cause harmful interference to radio communications. Operation of this equipment in a residential area is likely to cause harmful interference in which case the user will be required to correct the interference at his own expense. This equipment complies with FCC radiation exposure limits set forth for an uncontrolled environment and meets the 47 CFR 2.1091 of the FCC radio frequency (RF) Exposure rules.</p>



Reference	Description
ICES (Innovation, Science and Economic Development Canada)	<p>This device contains licence-exempt transmitter(s)/receiver(s) that comply with Innovation, Science and Economic Development Canada's licence-exempt RSS(s). Operation is subject to the following two conditions:</p> <ol style="list-style-type: none"> <li>1. This device may not cause interference.</li> <li>2. This device must accept any interference, including interference that may cause undesired operation of the device.</li> </ol> <p>L'émetteur/récepteur exempt de licence contenu dans le présent appareil est conforme aux CNR d'Innovation, Sciences et Développement économique Canada applicables aux appareils radio exempts de licence. L'exploitation est autorisée aux deux conditions suivantes:</p> <ol style="list-style-type: none"> <li>1. L'appareil ne doit pas produire de brouillage;</li> <li>2. L'appareil doit accepter tout brouillage radioélectrique subi, même si le brouillage est susceptible d'en compromettre le fonctionnement.</li> </ol> <p>This product complies to ICES-3 (A)/NMB-3(A). This equipment complies with ISED (IC) radiation exposure limits set forth for an uncontrolled environment and meets the ESS-102 of the ISED (IC) radio frequency (RF) Exposure rules.</p>
IFT (Instituto Federal de Telecomunicaciones) (Mexico)	<p>Contiene Módulo: ID ISC.MRM102-A, IFT: XX-XXXX</p> <p>La operación de este equipo está sujeta a las siguientes dos condiciones:</p> <ol style="list-style-type: none"> <li>1. es posible que este equipo o dispositivo no cause interferencia perjudicial y</li> <li>2. este equipo o dispositivo debe aceptar cualquier interferencia, incluyendo la que pueda causar su operación no deseada.</li> </ol>
ANATEL (Agencia Nacional de Telecomunicacoes) (Brazil)	<p>Módulo Modelo: ID ISC.MRM102-A</p>  <p>HHHHH-AA-FFFFF</p> <p>Este equipamento não tem direito à proteção contra interferência prejudicial e não pode causar interferência em sistemas devidamente autorizados.</p>
IMDA (Infocomm Media Development Authority) (Singapore)	<p>Complies with IMDA standards DA107256</p>
KCC (Korea Communications Commission) (Korea)	<p>이 기기는 업무용 환경에서 사용할 목적으로 적합성평가를 받은 기기로서 가정용 환경에서 사용하는 경우 전파간섭의 우려가 있습니다 .</p>
NCC (National Communications Commission) (Taiwan)	<p>低功率電波輻射性電機管理辦法</p> <p>第十二條經型式認證合格之低功率射頻電機，非經許可，公司、商號或使用者均不得擅自變更頻率、加大功率或變更原設計之特性及功能。</p> <p>第十四條低功率射頻電機之使用不得影響飛航安全及干擾合法通信；經發現有干擾現象時，應立即停用，並改善至無干擾時方得繼續使用。</p> <p>前項合法通信，指依電信規定作業之無線電信。低功率射頻電機須忍受合法通信或工業、科學及醫療用電波輻射性電機設備之干擾。</p>



Reference	Description
MIC (Ministry of Internal Affairs and Communications) (Japan)	This product includes approved RFID module with MIC approval number XXXXXX.
PTA (Pakistan Telecommunication Authority) (Pakistan)	Contains PTA approval module: XXXXX/YYYY

## RF transceiver specifications

RFID readers	
Description	ID ISC.MRM102-A RFID module with asynchronous RS232 interface
Frequency	13.56 MHz
Modulation	ISO15693, ISO18000-3 Mode 1 (EM HF ISO Chips, Fujitsu HF ISO Chips, KSW Sensor Chips, IDS Sensor Chips, Infineon my-d, NXP I-Code, STM LRI ISO Chips, TI Tag-it)
	NXP I Code 1
Transmit power	54.5 dBuV/m at 10m
Antenna	3674.000.00 (ID ISC. ANT40/30 HF PCB Antenna) Dimensions: 40 mm x 30 mm (1.57 inches x 1.18 inches) Antenna: 50 Ohm
Supply voltage	12 Vdc



## Chemical safety



**WARNING! GENERAL CHEMICAL HANDLING.** To minimize hazards, ensure laboratory personnel read and practice the general safety guidelines for chemical usage, storage, and waste provided below. Consult the relevant SDS for specific precautions and instructions:

- Read and understand the Safety Data Sheets (SDSs) provided by the chemical manufacturer before you store, handle, or work with any chemicals or hazardous materials. To obtain SDSs, see the "Documentation and Support" section in this document.
- Minimize contact with chemicals. Wear appropriate personal protective equipment when handling chemicals (for example, safety glasses, gloves, or protective clothing).
- Minimize the inhalation of chemicals. Do not leave chemical containers open. Use only with sufficient ventilation (for example, fume hood).
- Check regularly for chemical leaks or spills. If a leak or spill occurs, follow the manufacturer cleanup procedures as recommended in the SDS.
- Handle chemical wastes in a fume hood.
- Ensure use of primary and secondary waste containers. (A primary waste container holds the immediate waste. A secondary container contains spills or leaks from the primary container. Both containers must be compatible with the waste material and meet federal, state, and local requirements for container storage.)
- After emptying a waste container, seal it with the cap provided.
- Characterize (by analysis if needed) the waste generated by the particular applications, reagents, and substrates used in your laboratory.
- Ensure that the waste is stored, transferred, transported, and disposed of according to all local, state/provincial, and/or national regulations.
- **IMPORTANT!** Radioactive or biohazardous materials may require special handling, and disposal limitations may apply.



**AVERTISSEMENT ! PRÉCAUTIONS GÉNÉRALES EN CAS DE MANIPULATION DE PRODUITS CHIMIQUES.** Pour minimiser les risques, veiller à ce que le personnel du laboratoire lise attentivement et mette en œuvre les consignes de sécurité générales relatives à l'utilisation et au stockage des produits chimiques et à la gestion des déchets qui en découlent, décrites ci-dessous. Consulter également la FDS appropriée pour connaître les précautions et instructions particulières à respecter :

- Lire et comprendre les fiches de données de sécurité (FDS) fournies par le fabricant avant de stocker, de manipuler ou d'utiliser les matériaux dangereux ou les produits chimiques. Pour obtenir les FDS, se reporter à la section « Documentation et support » du présent document.
- Limiter les contacts avec les produits chimiques. Porter des équipements de protection appropriés lors de la manipulation des produits chimiques (par exemple : lunettes de sûreté, gants ou vêtements de protection).
- Limiter l'inhalation des produits chimiques. Ne pas laisser les récipients de produits chimiques ouverts. Ils ne doivent être utilisés qu'avec une ventilation adéquate (par exemple, sorbonne).



- Vérifier régulièrement l'absence de fuite ou d'écoulement des produits chimiques. En cas de fuite ou d'écoulement d'un produit, respecter les directives de nettoyage du fabricant recommandées dans la FDS.
  - Manipuler les déchets chimiques dans une sorbonne.
  - Veiller à utiliser des récipients à déchets primaire et secondaire. (Le récipient primaire contient les déchets immédiats, le récipient secondaire contient les fuites et les écoulements du récipient primaire. Les deux récipients doivent être compatibles avec les matériaux mis au rebut et conformes aux exigences locales, nationales et communautaires en matière de confinement des récipients.)
  - Une fois le récipient à déchets vidé, il doit être refermé hermétiquement avec le couvercle fourni.
  - Caractériser (par une analyse si nécessaire) les déchets générés par les applications, les réactifs et les substrats particuliers utilisés dans le laboratoire.
  - Vérifier que les déchets sont convenablement stockés, transférés, transportés et éliminés en respectant toutes les réglementations locales, nationales et/ou communautaires en vigueur.
  - **IMPORTANT !** Les matériaux représentant un danger biologique ou radioactif exigent parfois une manipulation spéciale, et des limitations peuvent s'appliquer à leur élimination.
- 



**WARNING! HAZARDOUS WASTE (from instruments).** Waste produced by the instrument is potentially hazardous. Follow the guidelines noted in the preceding General Chemical Handling warning.

---



**WARNING! 4L Reagent and Waste Bottle Safety.** Four-liter reagent and waste bottles can crack and leak. Each 4-liter bottle should be secured in a low-density polyethylene safety container with the cover fastened and the handles locked in the upright position.

---



## Biological hazard safety



**WARNING! Potential Biohazard.** Depending on the samples used on this instrument, the surface may be considered a biohazard. Use appropriate decontamination methods when working with biohazards.

---



**WARNING! BIOHAZARD.** Biological samples such as tissues, body fluids, infectious agents, and blood of humans and other animals have the potential to transmit infectious diseases. Conduct all work in properly equipped facilities with the appropriate safety equipment (for example, physical containment devices). Safety equipment can also include items for personal protection, such as gloves, coats, gowns, shoe covers, boots, respirators, face shields, safety glasses, or goggles. Individuals should be trained according to applicable regulatory and company/ institution requirements before working with potentially biohazardous materials. Follow all applicable local, state/provincial, and/or national regulations. The following references provide general guidelines when handling biological samples in laboratory environment.

- U.S. Department of Health and Human Services, *Biosafety in Microbiological and Biomedical Laboratories (BMBL)*, 5th Edition, HHS Publication No. (CDC) 21-1112, Revised December 2009; found at:  
<https://www.cdc.gov/labs/pdf/CDC-BiosafetymicrobiologicalBiomedicalLaboratories-2009-P.pdf>
  - World Health Organization, *Laboratory Biosafety Manual*, 3rd Edition, WHO/CDS/CSR/LYO/2004.11; found at:  
[www.who.int/csr/resources/publications/biosafety/Biosafety7.pdf](http://www.who.int/csr/resources/publications/biosafety/Biosafety7.pdf)
-



# Documentation and support

## Related documentation

Document	Publication number
<i>QuantStudio™ 6 Pro and 7 Pro Real-Time PCR Systems Hands-Free Features Quick Reference Guide</i>	MAN0018430
<i>TaqMan® Array Plates with RFID for use with QuantStudio™ 6 Pro and 7 Pro Real-Time PCR Systems Quick Reference Guide</i>	MAN0018436
<i>QuantStudio™ 6 Pro and 7 Pro Real-Time PCR Systems Connectivity Quick Reference</i>	MAN0018431
<i>QuantStudio™ 6 Pro and 7 Pro Real-Time PCR Systems Site Preparation Guide</i>	MAN0017992
<b>Desktop software</b>	
<i>QuantStudio™ Design and Analysis Software v2.0 User Guide</i>	MAN0018200
<b>Connect cloud-based platform</b>	
<i>QuantStudio™ Design and Analysis Module v2.0 User Guide</i>	MAN0018202

## Customer and technical support

Visit [thermofisher.com/support](http://thermofisher.com/support) for the latest service and support information.

- Worldwide contact telephone numbers
- Product support information
  - Product FAQs
  - Software, patches, and updates
  - Training for many applications and instruments
- Order and web support
- Product documentation
  - User guides, manuals, and protocols
  - Certificates of Analysis
  - Safety Data Sheets (SDSs; also known as MSDSs)

**Note:** For SDSs for reagents and chemicals from other manufacturers, contact the manufacturer.

## Limited product warranty

Life Technologies Corporation and/or its affiliate(s) warrant their products as set forth in the Life Technologies' General Terms and Conditions of Sale at [www.thermofisher.com/us/en/home/global/terms-and-conditions.html](http://www.thermofisher.com/us/en/home/global/terms-and-conditions.html). If you have any questions, please contact Life Technologies at [www.thermofisher.com/support](http://www.thermofisher.com/support).

# Index

## A

- accessories 127
- Add assay 47
- Add data collection location 44
- Add facial authentication 87
- Add pause 46
- Add PCR stage 44
- Add PCR step 44
- Add profile 89
- Add reagent details 48
- Add target 47
- Adjust speaker volume 102
- Administrator privilege
  - Disable 89
  - Enable 89
- Administrator profile, Create 87
- Assay
  - Add 47
  - Edit 47
- Auto Delta
  - Remove 45
  - Set up 45
- AutoDelta, Overview 14
- Automatic disk storage management 104
- Automatic sign-out
  - Edit 104
  - Enable 104

## B

- Back up instrument 108
- background calibration
  - create plate 69
  - plate, prepare 64
- Background calibration
  - Description 61
  - Frequency 62
  - Reminders 62
  - Run 65
  - Status 61
  - When to perform 60
- Barcode scan 40
- biohazard safety 146
- Block

- Change 92
- Clean 94
- Remove 93
- Block calibration 59

## C

- calibration, plate, prepare 64
- Calibration
  - Background 65
  - Custom dye
    - Dilution guidelines 74
    - Optimal concentration 76
    - Perform 78
    - Prepare plate 77
    - Run dilution plate 75
    - Workflow 74
  - Custom dye dilution, Prepare dilution plate 75
  - Descriptions 61
  - Dye 65
  - Export report 63
  - Frequency 62
  - Reminders, Connect 62
  - Required materials 63
  - ROI/Uniformity 65
  - Schedule 60
  - Status 61
  - Transfer data files 67
  - Transfer results 67
  - View images 66
  - Workflow 63
- calibration failure, troubleshoot 68
- Calibration plates 63
- Cancel scheduled run 54
- Change block 92
- Change password 88
- Change PIN 88
- Clean block 94
- Clear notifications 112
- Cloud 21
- Comparative Ct run 27
- Comparison 11
- computer
  - connection to instrument or LAN 123
  - connections 121

- requirements for desktop software 122
  - set up 118
  - Configure hands-free features 110
  - Configure network 102
  - Configure ramp rates 46
  - conformity symbols 134
  - Connect
    - Calibration reminders 62
    - Link 86
    - Link to instrument 82
      - Roles
        - Administrator 81
        - Standard 81
      - Unlink from instrument 84
    - Connect a proxy server 103
    - Connect platform, Features 21
    - Connect platform connection 26
    - Connect platform region 103
    - Connect profile, Overview 81
  - Connections
    - Options 26
    - Wired 26
    - Wireless 26
  - consumables, 96-well 0.2-mL 126
  - contamination, identify 68
  - control and connection symbols 134
  - Copy plate file 55
  - Cover temperature 43
  - Create and run a plate 37
  - Custom dye, Add to instrument 77
  - Custom dye calibration
    - Dilution, Guidelines 74
      - Dilution plate
        - Prepare plate 75
        - Run 75
    - Optimal concentration 76
    - Perform 78
    - Prepare plate 77
    - Workflow 74
  - Custom dyes, Overview 74
  - Cycles 43
- D**
- Data
    - View during run 52
    - Zoom 52
  - Data collection 13
  - Data collection location
    - Add 44
    - Remove 44
  - Data file
    - Delete 58
    - Transfer 57
  - Data file name, Manage 110
  - Date
    - Format 102
    - Set 102
  - Delete data file 58
  - Delete plate file 56
  - Delete profile 89
  - Delete reagent details 48
  - desktop software
    - download 122
    - download and install 122
    - install 123
  - Desktop software, Features 21
  - Direct network connection 26
  - Disable administrator privilege 89
  - Disable demonstration mode 101
  - Disable home screen notifications 112
  - Disable remote monitoring 108
  - Disk storage management 104
  - documentation, related 147
  - download desktop software 122
  - Dye
    - Custom, Add 77
    - Edit 49
    - Passive reference 49
  - dye calibration, plate, prepare 64
  - Dye calibration
    - Description 61
    - Frequency 62
    - Reminders 62
    - Run 65
    - Status 61
    - When to perform 60
  - Dyes
    - Custom 12, 74
    - System 11
- E**
- Edit automatic sign-out 104
  - Edit guest access 80
  - Edit method 43–46
  - Edit passive reference dye 49
  - Edit plate file 50
  - Edit plate file during run 50
  - Edit plate layout 47
  - Edit profile 88
  - Edit reagent details 48
  - Edit reagents 48
  - Edit sleep mode 98
  - Enable administrator privilege 89
  - Enable automatic sign-out 104
  - Enable demonstration mode 101
  - Enable home screen notifications 112

- Enable remote monitoring 108
- Enable sleep mode 98
- Ethernet port 125
- EULA, View 101
- Export calibration report 63
- Export instrument log 107

## F

- Facial authentication
  - Edit 87
  - Indicators 17
  - Overview 17
  - Set up 87
  - Sign in 34
- Features 11
- File locations 22
- File name convention, Data file 110
- File names, System templates 28
- Files
  - Description 25
  - Features 23
- firewall ports 125
- fluorescence high
- Fuses
  - Replace, Materials required 96

## G

- Genotyping run 28
- Guest access
  - Edit 80
  - Overview 32

## H

- Hands-free, Configure 110
- Hands-free features
  - Facial authentication 17
  - Indicators 17, 18
  - Voice activation 17
- Home screen, Parts of 19
- Home screen notifications 112

## I

- Import sample setup 42
- Index Term 139
- install, desktop software 123
- Install block 91
- installation, desktop software 122
- instrument, connections 121
- Instrument
  - About 100

- Back up 108
- Edit name 101
- Features 10
- Guest access 32
- Log 106, 107
- Move 99
- Notifications, View 111
- Overview 10
- Parts of 15
- Power off 99
- Power on 33, 98
- Reset, Overview 109
- Restore backup 109
- Restore factory default, Overview 109
- Schedule 53, 54
- Set date and time 102
- Ship 99
- Software features 21
- Statistics 107
- Store 99
- View details 100
- Workflow 30

- Instrument calibration 59
- Instrument comparison 11
- Instrument log
  - Export 107
  - View 106

- Instrument name 101

- Instrument profile

- Create 83
  - Edit 88
  - Facial authentication 87

- Instrument profiles, View all 88

- Instrument service 105

- instrument verification. *See* RNase P verification

- Interchangeable block calibration 59

## L

- limited product warranty 148
- List view 47
- Load plate 40
- Local area network (LAN) connection 26
- Local instrument profile
  - Create 83
  - Overview 81
- Lock touchscreen, During run 53

## M

- maintenance 91
- Manage reagents 48
- Manual disk storage management 104
- Melt curve run 28

## Index

- Method
    - Auto Delta
      - Remove 45
      - Set up 45
    - Data collection location
      - Add 44
      - Remove 44
    - Definitions 43
    - Edit 43
    - Files 25
      - Pause
        - Add 46
        - Remove 46
    - Ramp rates 46
    - Stage
      - Add 44
      - Remove 44
    - Step
      - Add 44
      - Remove 44
    - VeriFlex Zone
      - Remove 44
      - Set up 44
    - View during run 52
  - Method elements 43
  - Method tab
    - Actions, Edit method 43
  - Move instrument 99
  - My instrument 22
- N**
- network
    - configurations supported 123
    - guidelines and best practices 125
  - Network connections 26
  - Network drive 22
  - networking 123
  - No template control (NTC) 47
  - Notifications, Clear 112
- O**
- Order to set up profiles 80
- P**
- Pass criteria, RNase P verification 70, 71
  - Passive reference dye, Edit 49
  - Password, Change 88
  - Pause
    - Add 46
    - Remove 46
  - Pause run 51
  - PCR cycles 43, 44
  - PCR stage
    - Add 44
    - Remove 44
  - PCR stages 44
  - PCR step
    - Add 44
    - Remove 44
  - performance verification. *See* RNase P verification
  - PIN
    - Change 88
    - Sign in 33
  - PIN reset 88
  - Plate
    - Files 25
    - Load 40
    - Unload 41
  - Plate file
    - Copy 55
    - Create and run a plate 37
    - Delete 56
    - Layout 47
    - Method 42
    - Properties 42
    - Repeat last run 38
  - Plate layout, Edit 47
  - Plate tab, Actions 47
  - Plate view 47
  - Plots
    - View during run 52
    - Zoom 52
  - Post-read 22
  - Power off instrument 99
  - Power on 33, 98
  - Power-saving options 102
  - Presence/absence run 28
  - Profile
    - Add 89
    - Administrator, Create 87
      - Connect
        - Link 82
        - Unlink 84
    - Create 83
    - Delete 89
    - Delete PIN 88
    - Edit 88
    - Facial authentication 87
    - Reset PIN 88
    - Sign out 36
  - Profiles
    - Connect
      - Administrator 81
      - Standard 81
    - Order to set up 80

- Sign in 33, 34
- View all 88
- Voice commands 35
- Properties, Files 25
- Properties of a plate file 42
- Properties tab
  - Actions 42
  - Import sample setup 42
- Proxy server 103
- Public 22

## R

- Ramp rates, Configure 46
- Reaction volume 43
- Reagents
  - Add 48
  - Delete 48
  - Edit 48
- Region, Connect platform 103
- related documentation 147
- Relative standard curve run 27
- Remote monitoring 108
- Remove Auto Delta 45
- Remove block 93
- Remove data collection location 44
- Remove pause 46
- Remove PCR stage 44
- Remove PCR step 44
- Remove VeriFlex Zones 44
- Repeat last run 38
- Replace fuses, Materials required 96
- Required materials, Calibration 63
- Reset instrument 109, 110
- Reset PIN 88
- Restore backup 109
- Restore factory default 109, 110
- RNase P plates 69
- RNase P verification
  - Pass criteria 71
  - Plate description 70
  - Run 72
  - When to perform 60
- RNase P verification, plate, prepare 71
- ROI/uniformity calibration
  - Description 61
  - Frequency 62
  - plate, prepare 64
  - Reminders 62
  - Status 61
- ROI/Uniformity calibration
  - Run 65
  - When to perform 60
- Run

- Lock touchscreen 53
- Pause 51
- Post-PCR 13
- Real-time 13
- Stop 51
- Unlock touchscreen 53
- Run data file name 37
- Run queue 22
- Run type
  - Comparative Ct 13
  - Genotyping 13
  - Melt curve 13
  - Presence/absence 13
  - Relative standard curve 13
  - Standard curve 13
- Run types
  - Comparative Ct 27
  - Genotyping 28
  - Melt curve 28
  - Presence/absence 28
  - Relative standard curve 27
  - Standard curve 26

## S

- safety, biohazard 146
- safety symbols 129, 130
- sample block, decontaminate 94
- Sample information 47
- Sample setup, Import 42
- Saved plate file, Create and run a plate 37
- Schedule, Overview 53
- Schedule run 53
- Self-verification test, Results 106
- Service, Request 105
- Set up Auto Delta 45
- Set up VeriFlex Zones 44
- Ship instrument 99
- Sign in 33, 34
- Sign out 36
- Sleep mode
  - Edit 98
  - Enable 98
- Smart Help
  - Instrument service 105
  - Technical support 105
- Software features 21
- Speaker volume, Adjust 102
- Standard 47
- Standard curve run 26
- Standard profile 81
- Statistics, View 107
- Stop run 51
- Storage space 104

## Index

Store instrument 99  
 support, customer and technical 147  
 symbols  
   conformity 134  
   control and connection 134  
   safety 129, 130  
 System dyes 11  
 System template, Create and run a plate 37  
 System templates 28

**T**

Target  
   Add 47  
   Edit 47  
 Target/SNP 47  
 Technical support 105  
 Temperature 43  
 Template 22  
 terms and conditions 148  
 Thermal protocol 43  
 Thermo Fisher Cloud 21  
 Thermo Fisher Connect 21  
 third-party software 26, 125  
 Time  
   Format 102  
   Set 102  
 Time remaining, View during run 52  
 Transfer calibration data files 67  
 Transfer calibration results 67  
 Transfer data file  
   Immediately after run 57  
   Later time 57

**U**

uniformity calibration, plate, prepare 64  
 Uniformity calibration  
   Description 61  
   Frequency 62  
   Reminders 62  
   Status 61  
 Unknown 47  
 Unload plate 41  
 Unlock touchscreen, During run 53  
 USB drive 22

**V**

Verification  
   Description 70  
   Pass criteria 71  
   RNase P 69  
   Schedule 60  
 verification failure, troubleshoot 73  
 VeriFlex Zones  
   Overview 13  
   Remove 44  
   Set up 44  
 View  
   List of data files 58  
   Plate layout 47  
 View all profiles 88  
 View calibration images 66  
 View data during run, Zoom 52  
 View EULA 101  
 View instrument details 100  
 View instrument log 106  
 View license agreement 101  
 View method during run 52  
 View notifications 111  
 View plots during run, Zoom 52  
 View time remaining during run 52  
 Voice commands  
   Indicators 18  
   Overview 17  
   Supported 35

**W**

warranty 148  
 Well  
   Add assay 47  
   Add target 47  
   Assign 47  
   Edit 47  
 Wells, View 47  
 Wired connection 26  
 Wireless connection 26  
 Workflow  
   Calibration 63  
   Custom dye calibration 74





