



TEST REPORT

Report Reference No...... : **TRE1605009505** R/C.....: 59796

FCC ID..... : **2ADE3IDATA50A**

Applicant's name..... : **WUXI IDATA TECHNOLOGY COMPANY LTD.**

Address..... : Floor 11, Building B1, Wuxi Binhu National Sensing Information Center, No.999 Gaolang East Road, Wuxi City, P.R.C.

Manufacturer..... : **WUXI IDATA TECHNOLOGY COMPANY LTD.**

Address..... : Floor 11, Building B1, Wuxi Binhu National Sensing Information Center, No.999 Gaolang East Road, Wuxi City, P.R.C.

Test item description : **NEW MOBILE COMPUTER**

Trade Mark : iData

Model/Type reference..... : iData 50

Listed Model(s)..... : -

Standard : **FCC CFR Title 47 Part 15 Subpart C Section 15.247**

Date of receipt of test sample..... : May.19, 2016

Date of testing..... : May.20, 2016 ~ Aug.13, 2016

Date of issue..... : Aug.14, 2016

Result..... : **PASS**

Compiled by
(position+printedname+signature)... : File administrators Candy Liu

Candy Liu

Supervised by
(position+printed name+signature)... : Project Engineer Lion Cai

Lion Cai

Approved by
(position+printed name+signature)... : RF Manager Hans Hu

Hans Hu

Testing Laboratory Name : **Shenzhen Huatongwei International Inspection Co., Ltd**

Address..... : 1/F, Bldg 3, Hongfa Hi-tech Industrial Park, Genyu Road, Tianliao, Gongming, Shenzhen, China

Shenzhen Huatongwei International Inspection Co., Ltd. All rights reserved.

This publication may be reproduced in whole or in part for non-commercial purposes as long as the Shenzhen Huatongwei International Inspection Co., Ltd is acknowledged as copyright owner and source of the material. Shenzhen Huatongwei International Inspection Co., Ltd takes no responsibility for and will not assume liability for damages resulting from the reader's interpretation of the reproduced material due to its placement and context.

Contents

<u>1.</u>	<u>APPLICABLE STANDARDS AND TEST DESCRIPTION</u>	<u>3</u>
1.1.	Applicable Standards	3
1.2.	Test Description	3
<u>2.</u>	<u>SUMMARY</u>	<u>4</u>
2.1.	Client Information	4
2.2.	Product Description	4
2.3.	Operation state	5
2.4.	EUT configuration	5
2.5.	Modifications	5
<u>3.</u>	<u>TEST ENVIRONMENT</u>	<u>6</u>
3.1.	Address of the test laboratory	6
3.2.	Test Facility	6
3.3.	Equipments Used during the Test	7
3.4.	Environmental conditions	8
3.5.	Statement of the measurement uncertainty	8
<u>4.</u>	<u>TEST CONDITIONS AND RESULTS</u>	<u>9</u>
4.1.	Antenna requirement	9
4.2.	Conducted Emission (AC Main)	10
4.3.	Conducted Peak Output Power	13
4.4.	Power Spectral Density	14
4.5.	6dB bandwidth	16
4.6.	Restricted band	18
4.7.	Band edge and Spurious Emission (conducted)	20
4.8.	Spurious Emission (radiated)	22
<u>5.</u>	<u>TEST SETUP PHOTOS OF THE EUT</u>	<u>27</u>
<u>6.</u>	<u>EXTERNAL AND INTERNAL PHOTOS OF THE EUT</u>	<u>28</u>

1. APPLICABLE STANDARDS AND TEST DESCRIPTION

1.1. Applicable Standards

The tests were performed according to following standards:

[FCC Rules Part 15.247](#): Frequency Hopping, Direct Spread Spectrum and Hybrid Systems that are in operation within the bands of 902-928 MHz, 2400-2483.5 MHz, and 5725-5850 MHz.

[ANSI C63.10-2013](#): American National Standard for Testing Unlicensed Wireless Devices

[KDB558074 D01 V03R03](#): Guidance for Performing Compliance Measurements on Digital Transmission Systems (DTS)

1.2. Test Description

ReportSection	Test Item	FCC Rule	Result
4.1	Antenna requirement	15.203/15.247 (c)	Pass
4.2	Line Conducted Emission (AC Main)	15.207	Pass
4.3	Conducted Peak Output Power	15.247 (b)(3)	Pass
4.4	Power Spectral Density	15.247 (e)	Pass
4.5	6dB Bandwidth	15.247 (a)(2)	Pass
4.6	Restricted band	15.247(d)/15.205	Pass
4.7/4.8	Spurious Emission	15.247(d)/15.209	Pass

Remark: The measurement uncertainty is not included in the test result.

2. SUMMARY

2.1. Client Information

Applicant:	WUXI IDATA TECHNOLOGY COMPANY LTD.
Address:	Floor 11, Building B1, Wuxi Binhu National Sensing Information Center, No.999 Gaolang East Road, Wuxi City, P.R.C.
Manufacturer:	WUXI IDATA TECHNOLOGY COMPANY LTD.
Address:	Floor 11, Building B1, Wuxi Binhu National Sensing Information Center, No.999 Gaolang East Road, Wuxi City, P.R.C.

2.2. Product Description

Name of EUT	NEW MOBILE COMPUTER
Trade Mark:	iData
Model No.:	iData 50
Listed Model(s):	-
IMEI 1:	869881011800052
Power supply:	DC 3.7V From internal battery
Adapter information1:	Model:FJ-SW1260502000UN Input:AC 100-240V 50/60Hz 0.4A Max Output: 5Vd.c., 2000mA
Adapter information2:	Model:FJ-SW1202000N Input:AC 100-240V 50/60Hz 0.6A Max Output: 12Vd.c., 2000mA
Bluetooth	
Version:	Supported BT4.0+BLE
Modulation:	GFSK
Operation frequency:	2402MHz~2480MHz
Channel number:	40
Channel separation:	2MHz
Antenna type:	Internal Antenna
Antenna gain:	1.5dBi

2.3. Operation state

◆ Test frequency list

According to section 15.31(m), regards to the operating frequency range over 10 MHz, must select three channel which were tested. the Lowest frequency, the middle frequency, and the highest frequency of channel were selected to perform the test, please see the above gray bottom.

Channel	Frequency (MHz)
00	2402
02	2404
⋮	⋮
19	2440
⋮	⋮
38	2478
39	2480

◆ Test mode

For RF test items:

the engineering test program was provided and enabled to make EUT continuous transmit/receive.

For AC power line conducted emissions:

The EUT was set to connect with the Bluetooth under large package sizes transmission.

2.4. EUT configuration

The following peripheral devices and interface cables were connected during the measurement:

● - supplied by the manufacturer

○ - supplied by the lab

	Length (m) :	/
	Shield :	/
	Detachable :	/
	Manufacturer :	/
	Model No. :	/

2.5. Modifications

No modifications were implemented to meet testing criteria.

3. TEST ENVIRONMENT

3.1. Address of the test laboratory

Laboratory: Shenzhen Huatongwei International Inspection Co., Ltd.

Address: 1/F, Bldg 3, Hongfa Hi-tech Industrial Park, Genyu Road, Tianliao, Gongming, Shenzhen, China

Phone: 86-755-26748019 Fax: 86-755-26748089

3.2. Test Facility

The test facility is recognized, certified, or accredited by the following organizations:

CNAS-Lab Code: L1225

Shenzhen Huatongwei International Inspection Co., Ltd. has been assessed and proved to be in compliance with CNAS-CL01 Accreditation Criteria for Testing and Calibration Laboratories (identical to ISO/IEC17025: 2005 General Requirements) for the Competence of Testing and Calibration Laboratories, Date of Registration: February 28, 2015. Valid time is until February 27, 2018.

A2LA-Lab Cert. No. 3902.01

Shenzhen Huatongwei International Inspection Co., Ltd. EMC Laboratory has been accredited by A2LA for technical competence in the field of electrical testing, and proved to be in compliance with ISO/IEC 17025: 2005 General Requirements for the Competence of Testing and Calibration Laboratories and any additional program requirements in the identified field of testing. Valid time is until December 31, 2016.

FCC-Registration No.: 317478

Shenzhen Huatongwei International Inspection Co., Ltd. EMC Laboratory has been registered and fully described in a report filed with the FCC (Federal Communications Commission). The acceptance letter from the FCC is maintained in our files. Registration 317478, Renewal date Jul. 18, 2014, valid time is until Jul. 18, 2017.

IC-Registration No.: 5377A&5377B

The 3m Alternate Test Site of Shenzhen Huatongwei International Inspection Co., Ltd. has been registered by Certification and Engineering Bureau of Industry Canada for the performance of radiated measurements with Registration No. 5377A on Dec. 31, 2013, valid time is until Dec. 31, 2016.

Two 3m Alternate Test Site of Shenzhen Huatongwei International Inspection Co., Ltd. has been registered by Certification and Engineering Bureau of Industry Canada for the performance of radiated measurements with Registration No. 5377B on Dec.03, 2014, valid time is until Dec.03, 2017.

ACA

Shenzhen Huatongwei International Inspection Co., Ltd. EMC Laboratory can also perform testing for the Australian C-Tick mark as a result of our A2LA accreditation.

VCCI

The 3m Semi-

anechoic chamber (12.2m×7.95m×6.7m) of Shenzhen Huatongwei International Inspection Co., Ltd.

has been registered in accordance with the Regulations for Voluntary Control Measures with Registration No.: R-2484. Date of Registration: Dec. 20, 2012. Valid time is until Dec. 29, 2015.

Radiated disturbance above 1GHz measurement of Shenzhen Huatongwei International Inspection Co., Ltd. has been registered in accordance with the Regulations for Voluntary Control Measures with Registration No.: G-292. Date of Registration: Dec. 24, 2013. Valid time is until Dec. 23, 2016.

Main Ports Conducted Interference Measurement of Shenzhen Huatongwei International Inspection Co., Ltd. has been registered in accordance with the Regulations for Voluntary Control Measures with Registration No.: C-2726. Date of Registration: Dec. 20, 2012. Valid time is until Dec. 19, 2015.

Telecommunication Ports Conducted Interference Measurement of Shenzhen Huatongwei International Inspection Co., Ltd. has been registered in accordance with the Regulations for Voluntary Control Measures with Registration No.: T-1837. Date of Registration: May 07, 2013. Valid time is until May 06, 2016.

DNV

Shenzhen Huatongwei International Inspection Co., Ltd. has been found to comply with the requirements of DNV towards subcontractor of EMC and safety testing services in conjunction with the EMC and Low voltage Directives and in the voluntary field. The acceptance is based on a formal quality Audit and follow-ups according to relevant parts of ISO/IEC Guide 17025 (2005), in accordance with the requirements of the DNV Laboratory Quality Manual towards subcontractors. Valid time is until Aug. 24, 2016.

3.3. Equipments Used during the Test

Conducted Emission (AC Main)					
Item	Test Equipment	Manufacturer	Model No.	Serial No.	Last Cal
1	Artificial Mains	Rohde&Schwarz	ESH2-Z5	100028	2015/11/02
2	EMI Test Receiver	Rohde&Schwarz	ESCI3	100038	2015/11/02
3	Pulse Limiter	Rohde&Schwarz	ESHSZ2	100044	2015/11/02
4	EMI Test Software	Rohde&Schwarz	ES-K1 V1.71	N/A	N/A

Radiated Emission					
Item	Test Equipment	Manufacturer	Model No.	Serial No.	Last Cal
1	Ultra-Broadband Antenna	ShwarzBeck	VULB9163	538	2015/11/02
2	EMI TEST RECEIVER	Rohde&Schwarz	ESI 26	100009	2015/11/02
3	EMI TEST Software	Audix	E3	N/A	N/A
4	TURNTABLE	ETS	2088	2149	N/A
5	ANTENNA MAST	ETS	2075	2346	N/A
6	EMI TEST Software	Rohde&Schwarz	ESK1	N/A	N/A
7	HORNANTENNA	ShwarzBeck	9120D	1011	2015/11/02
8	Amplifer	Sonoma	310N	E009-13	2015/11/02
9	JS amplifer	Rohde&Schwarz	JS4-00101800-28-5A	F201504	2015/11/02
10	High pass filter	Compliance Direction systems	BSU-6	34202	2015/11/02
11	HORNANTENNA	ShwarzBeck	9120D	1012	2015/11/02
12	Amplifer	Compliance Direction systems	PAP1-4060	120	2015/11/02
13	Loop Antenna	Rohde&Schwarz	HFH2-Z2	100020	2015/11/02
14	TURNTABLE	MATURO	TT2.0	----	N/A
15	ANTENNA MAST	MATURO	TAM-4.0-P	----	N/A
16	Horn Antenna	SCHWARZBECK	BBHA9170	25841	2015/11/02
17	ULTRA-BROADBAND ANTENNA	Rohde&Schwarz	HL562	100015	2015/11/02

Maximum Peak Output Power / Power Spectral Density / 6dB Bandwidth / Band Edge Compliance of RF Emission / Spurious RF Conducted Emission					
Item	Test Equipment	Manufacturer	Model No.	Serial No.	Last Cal
1	Spectrum Analyzer	Rohde&Schwarz	FSP	1164.4391.40	2015/11/02
2	Power Meter	Anritsu	ML2480B	100798	2015/11/02
3	Power Sensor	Anritsu	MA2411B	100258	2015/11/02

The Cal.Interval was one year

3.4. Environmental conditions

During the measurement the environmental conditions were within the listed ranges:

Temperature:	15~35°C
Relative Humidity:	30~60 %
Air Pressure:	950~1050mba

3.5. Statement of the measurement uncertainty

The data and results referenced in this document are true and accurate. The reader is cautioned that there may be errors within the calibration limits of the equipment and facilities. The measurement uncertainty was calculated for all measurements listed in this test report according to TR-100028-01 "Electromagnetic compatibility and Radio spectrum Matters (ERM); Uncertainties in the measurement of mobile radio equipment characteristics; Part 1" and TR-100028-02 "Electromagnetic compatibility and Radio spectrum Matters (ERM); Uncertainties in the measurement of mobile radio equipment characteristics; Part 2" and is documented in the Shenzhen Huatongwei International Inspection Co., Ltd quality system according to DIN EN ISO/IEC 17025. Furthermore, component and process variability of devices similar to that tested may result in additional deviation. The manufacturer has the sole responsibility of continued compliance of the device.

Hereafter the best measurement capability for Shenzhen Huatongwei laboratory is reported:

Test Items	Measurement Uncertainty	Notes
Transmitter power conducted	0.57 dB	(1)
Transmitter power Radiated	2.20 dB	(1)
Conducted spurious emission 9KHz-40 GHz	1.60 dB	(1)
Radiated spurious emission 9KHz-40 GHz	2.20 dB	(1)
Conducted Emission 9KHz-30MHz	3.39 dB	(1)
Radiated Emission 30~1000MHz	4.24 dB	(1)
Radiated Emission 1~18GHz	5.16 dB	(1)
Radiated Emission 18-40GHz	5.54 dB	(1)
Occupied Bandwidth	-----	(1)

(1) This uncertainty represents an expanded uncertainty expressed at approximately the 95% confidence level using a coverage factor of $k=1.96$.

4. TEST CONDITIONS AND RESULTS

4.1. Antenna requirement

Requirement

FCC CFR Title 47 Part 15 Subpart C Section 15.203:

An intentional radiator shall be designed to ensure that no antenna other than that furnished by the responsible party shall be used with the device. The use of a permanently attached antenna or of an antenna that uses a unique coupling to the intentional radiator, the manufacturer may design the unit so that a broken antenna can be replaced by the user, but the use of a standard antenna jack or electrical connector is prohibited.

FCC CFR Title 47 Part 15 Subpart C Section 15.247(c) (1)(i):

(i) Systems operating in the 2400-2483.5 MHz band that is used exclusively for fixed. Point-to-point operations may employ transmitting antennas with directional gain greater than 6dBi provided the maximum conducted output power of the intentional radiator is reduced by 1 dB for every 3 dB that the directional gain of the antenna exceeds 6dBi.

Test Result:

The antenna is integral antenna, the best case gain of the antenna is 1.5dBi

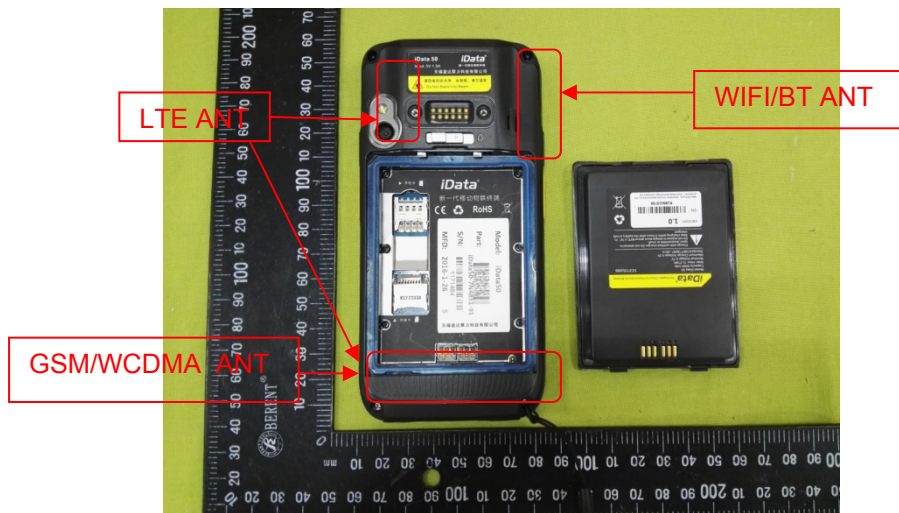

4.2. Conducted Emission (AC Main)

LIMIT

FCC CFR Title 47 Part 15 Subpart C Section 15.207

Frequency range (MHz)	Limit (dBuV)	
	Quasi-peak	Average
0.15-0.5	66 to 56*	56 to 46*
0.5-5	56	46
5-30	60	50

* Decreases with the logarithm of the frequency.

TEST CONFIGURATION

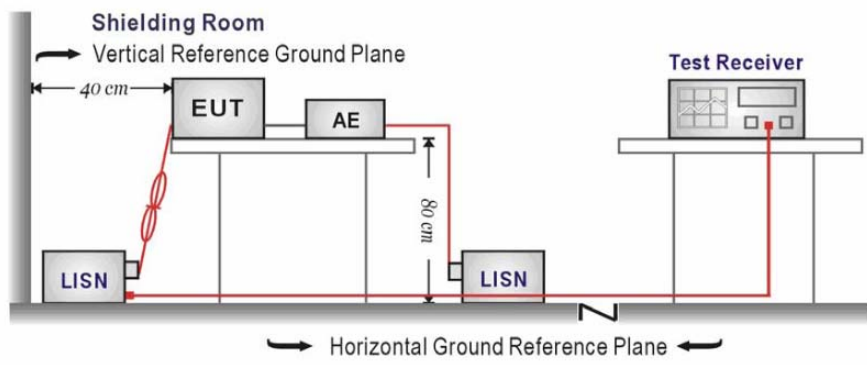

TEST PROCEDURE

1. The EUT was setup and tested according to ANSI C63.10:2013 for compliance to FCC 47CFR 15.247 requirements.
2. The EUT was placed on a platform of nominal size, 1 m by 1.5 m, raised 80 cm above the conducting ground plane. The vertical conducting plane was located 40 cm to the rear of the EUT. All other surfaces of EUT were at least 80 cm from any other grounded conducting surface.
3. The EUT and simulators are connected to the main power through a line impedance stabilization network (LISN). The LISN provides a 50 ohm /50uH coupling impedance for the measuring equipment.
4. The peripheral devices are also connected to the main power through a LISN. (Please refer to the block diagram of the test setup and photographs)
5. Each current-carrying conductor of the EUT power cord, except the ground (safety) conductor, was individually connected through a LISN to the input power source.
6. The excess length of the power cord between the EUT and the LISN receptacle were folded back and forth at the center of the lead to form a bundle not exceeding 40 cm in length.
7. Conducted emissions were investigated over the frequency range from 0.15MHz to 30MHz using a receiver bandwidth of 9 kHz.

TEST RESULTS

Test mode:AC 120V	BT	Polarization	L
-------------------	----	--------------	---

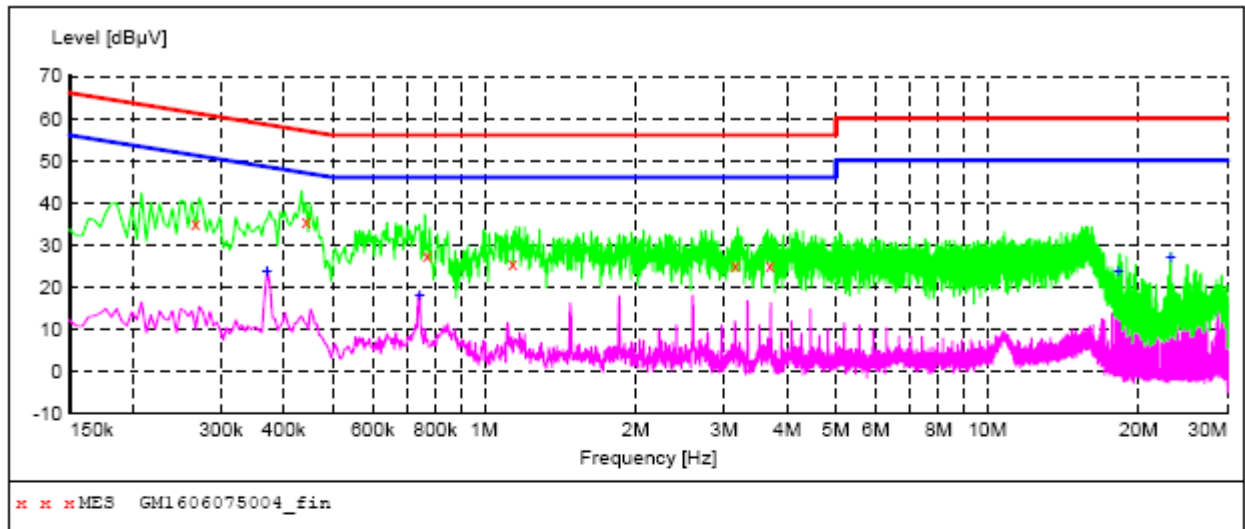

MEASUREMENT RESULT: "GM1606075004_fin"

6/7/2016 1:09PM

Frequency MHz	Level dBµV	Transd dB	Limit dBµV	Margin dB	Detector	Line	PE
0.267000	35.00	10.2	61	26.2	QP	L1	GND
0.442500	35.70	10.2	57	21.3	QP	L1	GND
0.771000	27.70	10.2	56	28.3	QP	L1	GND
1.140000	25.70	10.2	56	30.3	QP	L1	GND
3.156000	25.00	10.3	56	31.0	QP	L1	GND
3.696000	25.10	10.3	56	30.9	QP	L1	GND

MEASUREMENT RESULT: "GM1606075004_fin2"

6/7/2016 1:09PM

Frequency MHz	Level dBµV	Transd dB	Limit dBµV	Margin dB	Detector	Line	PE
0.370500	23.70	10.2	49	24.8	AV	L1	GND
0.744000	18.20	10.2	46	27.8	AV	L1	GND
18.244500	23.80	10.9	50	26.2	AV	L1	GND
23.127000	26.80	11.0	50	23.2	AV	L1	GND

Test mode: AC 120V	BT	Polarization	N
--------------------	----	--------------	---

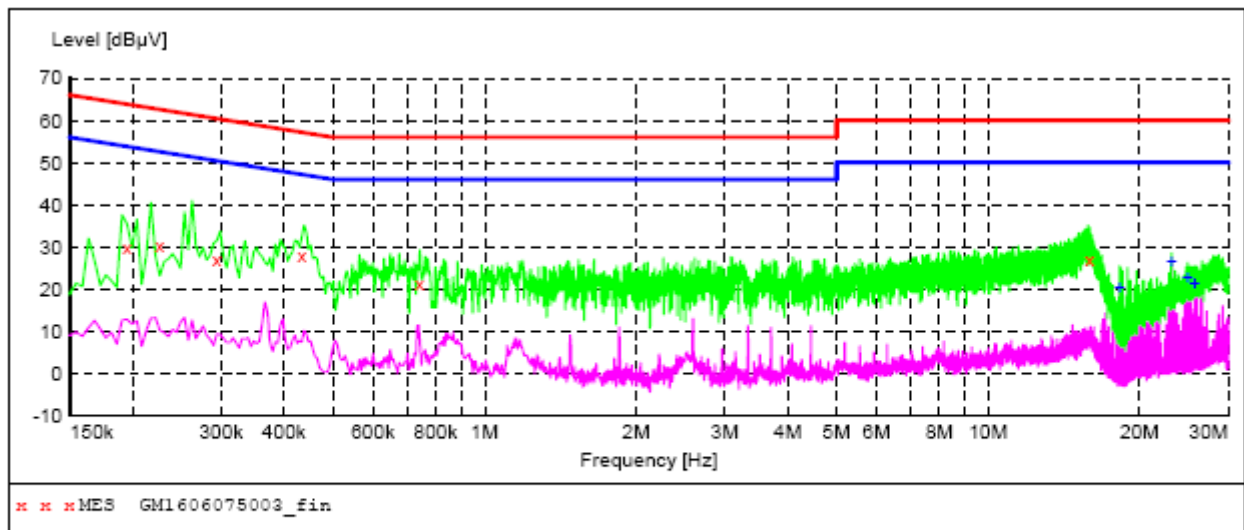

MEASUREMENT RESULT: "GM1606075003_fin"

6/7/2016 1:05PM

Frequency MHz	Level dBµV	Transd dB	Limit dBµV	Margin dB	Detector	Line	PE
0.195000	29.80	10.2	64	34.0	QP	N	GND
0.226500	30.30	10.2	63	32.3	QP	N	GND
0.294000	27.20	10.2	60	33.2	QP	N	GND
0.433500	27.90	10.2	57	29.3	QP	N	GND
0.744000	21.40	10.2	56	34.6	QP	N	GND
15.900000	27.10	10.8	60	32.9	QP	N	GND

MEASUREMENT RESULT: "GM1606075003_fin2"

6/7/2016 1:05PM

Frequency MHz	Level dBµV	Transd dB	Limit dBµV	Margin dB	Detector	Line	PE
18.244500	20.40	10.9	50	29.6	AV	N	GND
23.127000	26.40	11.0	50	23.6	AV	N	GND
24.900000	22.70	11.0	50	27.3	AV	N	GND
25.692000	21.20	11.0	50	28.8	AV	N	GND

Remark: Transd=Cable lose+ PULSE LIMITER factor+ ARTIFICIAL MAINS factor; Margin= Limit -Level

4.3. Conducted Peak Output Power

LIMIT

FCC CFR Title 47 Part 15 Subpart C Section 15.247 (b)(3): **30dBm**

TEST CONFIGURATION

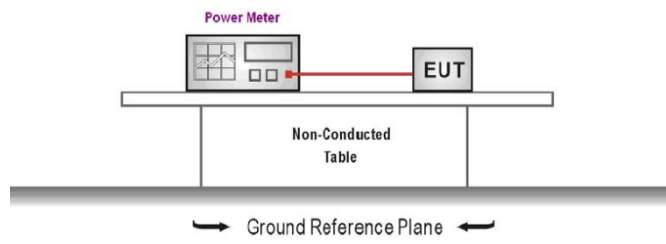

TEST PROCEDURE

1. The EUT was tested according to KDB 558074 D01 V03R03 for compliance to FCC 47CFR 15.247 requirements.
2. The maximum peak conducted output power may be measured using a broadband peak RF power meter.
3. The power meter shall have a video bandwidth that is greater than or equal to the DTS bandwidth and shall utilize a fast-responding diode detector
4. Record the measurement data.

TEST RESULTS

Type	Channel	Output power (dBm)	Limit (dBm)	Result
BT-BLE	00	-2.52	30.00	Pass
	19	-2.74		
	39	-2.35		

4.4. Power Spectral Density

LIMIT

FCC CFR Title 47 Part 15 Subpart C Section 15.247 (e): **8dBm/3KHz**

For digitally modulated systems, the power spectral density conducted from the intentional radiator to the antenna shall not be greater than 8 dBm in any 3 kHz band during any time interval of continuous transmission.

TEST CONFIGURATION

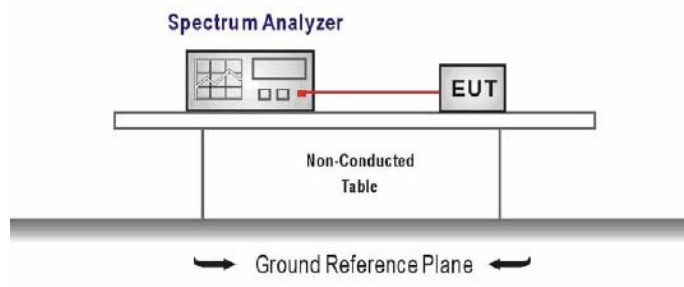

TEST PROCEDURE

1. Connect the antenna port(s) to the spectrum analyzer input,
2. Configure the spectrum analyzer as shown below:
Center frequency=DTS channel center frequency
Span =1.5 times the DTS bandwidth
RBW = 3 kHz ≤ RBW ≤ 100 kHz, VBW ≥ 3 × RBW
Sweep time = auto couple
Detector = peak
Trace mode = max hold
3. Place the radio in continuous transmit mode, allow the trace to stabilize, view the transmitter waveform on the spectrum analyzer.
4. Use the peak marker function to determine the maximum amplitude level within the RBW.
5. If measured value exceeds limit, reduce RBW (no less than 3 kHz) and repeat.

TEST RESULTS

Type	Channel	Power Spectral Density(dBm/3KHz)	Limit (dBm/3KHz)	Result
BT-BLE	00	-23.31	8.00	Pass
	19	-21.56		
	39	-21.54		

Test plot as follows:

BT-BLE

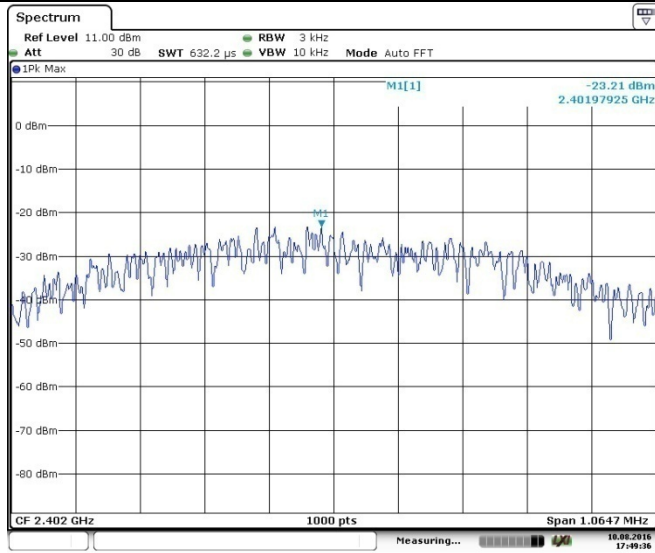

CH00

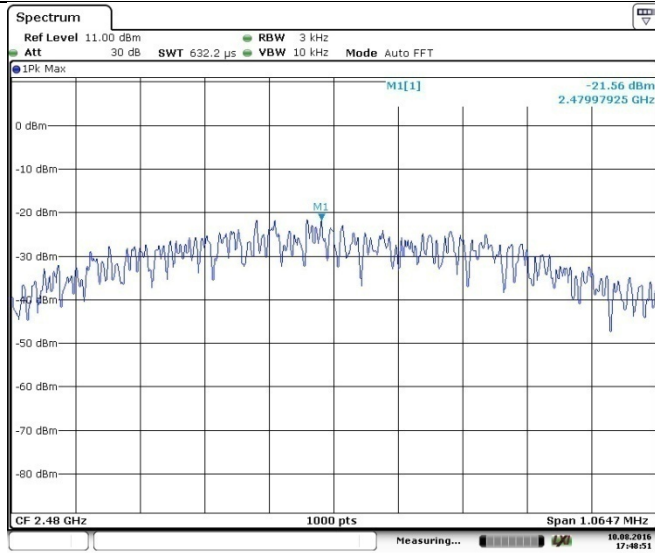

CH19

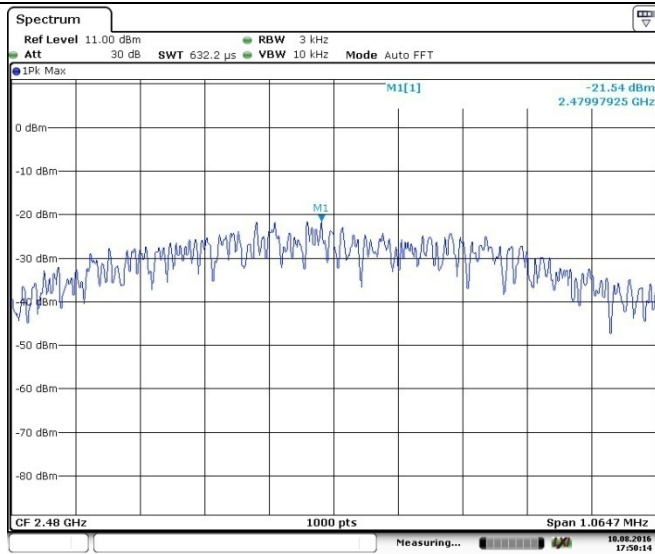

CH39

4.5. 6dB bandwidth

LIMIT

FCC CFR Title 47 Part 15 Subpart C Section 15.247 (a)(2): **at least 500KHz**

For digital modulation systems, the minimum 6 dB bandwidth shall be at least 500 kHz.

TEST CONFIGURATION

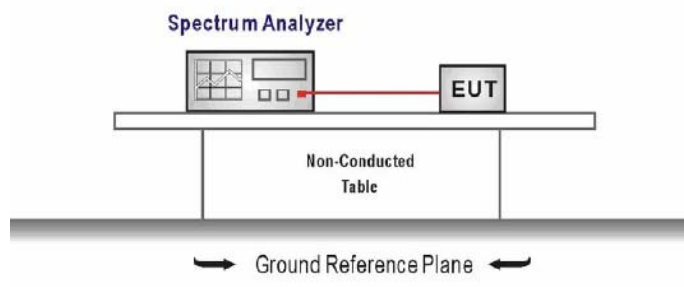

TEST PROCEDURE

1. Connect the antenna port(s) to the spectrum analyzer input.
2. Configure the spectrum analyzer as shown below (enter all losses between the transmitter output and the spectrum analyzer).
Center Frequency = DTS channel center frequency
Span = 2 x DTS bandwidth
RBW = 100 kHz, VBW ≥ 3 x RBW
Sweep time = auto couple
Detector = Peak
Trace mode = max hold
3. Place the radio in continuous transmit mode, allow the trace to stabilize, view the transmitter waveform on the spectrum analyzer.
4. Measure the maximum width of the emission that is constrained by the frequencies associated with the two outermost amplitude points (upper and lower frequencies) that are attenuated by 6 dB relative to the maximum level measured in the fundamental emission, and record the pertinent measurements.

TEST RESULTS

Type	Channel	6dB Bandwidth(3KHz)	Limit (KHz)	Result
BT-BLE	00	709.80	≥500	Pass
	19	712.00		
	39	709.80		

Test plot as follows:

BT-BLE

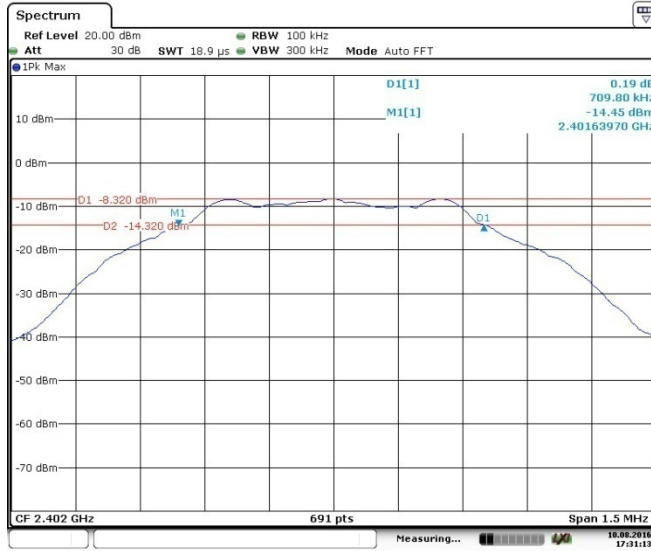

CH00

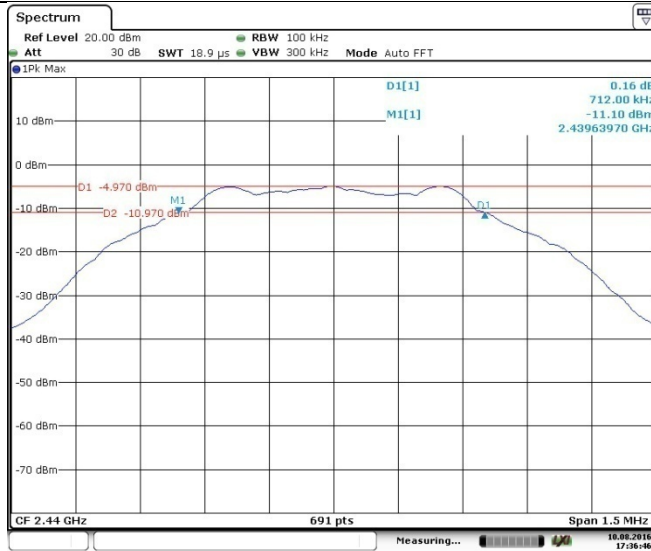

CH19

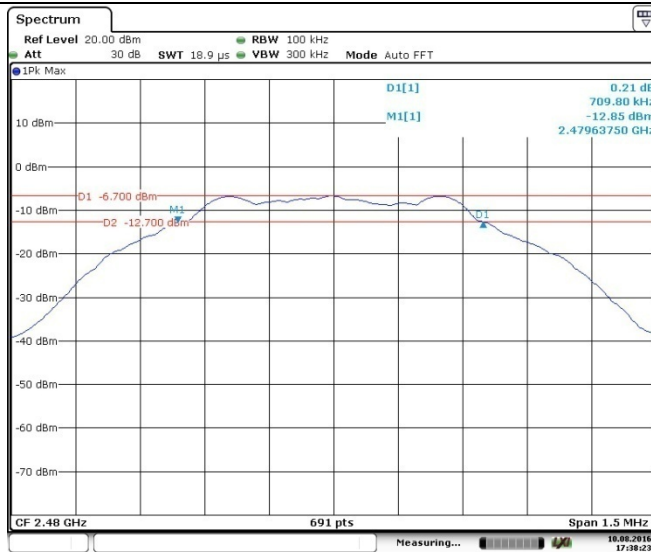

CH39

4.6. Restricted band

LIMIT

FCC CFR Title 47 Part 15 Subpart C Section 15.247 (d):

In any 100 kHz bandwidth outside the frequency band in which the spread spectrum or digitally modulated intentional radiator is operating, radiated emissions which fall in the restricted bands, as defined in §15.205(a), must also comply with the radiated emission limits specified in §15.209(a) (see §15.205(c)).

TEST CONFIGURATION

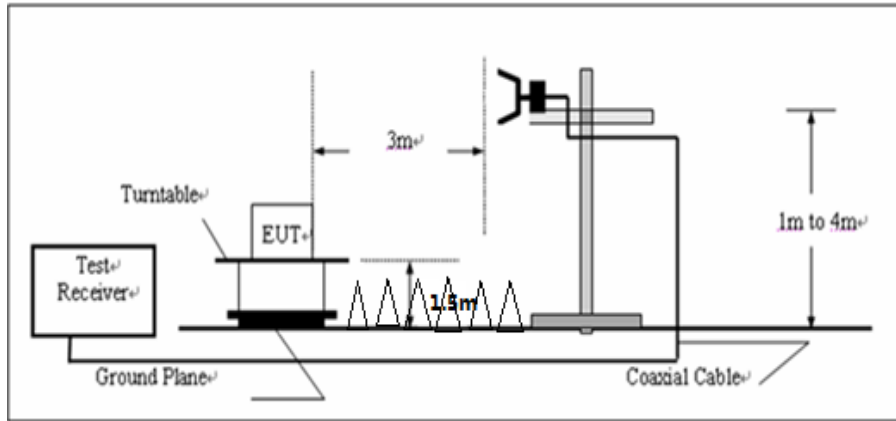

TEST PROCEDURE

1. The EUT was setup and tested according to ANSI C63.10:2013 for compliance to FCC 47CFR 15.247 requirements.
2. The EUT is placed on a turn table which is 1.5 meter above ground. The turn table is rotated 360 degrees to determine the position of the maximum emission level.
3. The EUT was positioned such that the distance from antenna to the EUT was 3 meters.
4. The antenna is scanned from 1 meter to 4 meters to find out the maximum emission level. This is repeated for both horizontal and vertical polarization of the antenna. In order to find the maximum emission, all of the interface cables were manipulated according to ANSI C63.10:2013 on radiated measurement.
5. The receiver set as follow:
RBW=1MHz, VBW=3MHz for Peak value
RBW=1MHz, VBW=10Hz for Average value.
6. Pre-scan 2310-2390MHz, 2483.5-2500MHz, and only mark the worst case data in the test report

TEST RESULTS

CH00									
Frequency (MHz)	Read Level (dBuV)	Antenna Factor (dB/m)	Cable Loss (dB)	Preamp Factor (dB)	Level (dBuV/m)	Limit Line (dBuV/m)	Margin Limit (dB)	Polarization	Test value
2390	44.28	27.53	6.81	37.24	41.38	74	-32.62	Vertical	Peak
2390	44.54	27.53	6.81	37.24	41.64	74	-32.36	Horizontal	
2390	37.26	27.53	6.81	37.24	34.36	54	-19.64	Vertical	Average
2390	37.42	27.53	6.81	37.24	34.52	54	-19.48	Horizontal	

CH39									
Frequency (MHz)	Read Level (dBuV)	Antenna Factor (dB/m)	Cable Loss (dB)	Preamp Factor (dB)	Level (dBuV/m)	Limit Line (dBuV/m)	Margin Limit (dB)	Polarization	Test value
2483.50	49.47	27.85	6.96	37.92	46.36	74	-27.64	Vertical	Peak
2483.50	55.56	27.85	6.96	37.92	52.45	74	-21.55	Horizontal	
2483.50	47.69	27.85	6.96	37.92	44.58	54	-9.42	Vertical	Average
2483.50	53.76	27.85	6.96	37.92	50.65	54	-3.35	Horizontal	

Note:Level= Read+ Antenna Factor+ Cable Loss- Preamp Factor

4.7. Band edge and Spurious Emission (conducted)

LIMIT

FCC CFR Title 47 Part 15 Subpart C Section 15.247 (d):

In any 100 kHz bandwidth outside the frequency band in which the spread spectrum intentional radiator is operating, the radio frequency power that is produced by the intentional radiator shall be at least 20 dB below that in the 100 kHz bandwidth within the band that contains the highest level of the desired power, based on either an RF conducted or a radiated measurement.

TEST CONFIGURATION

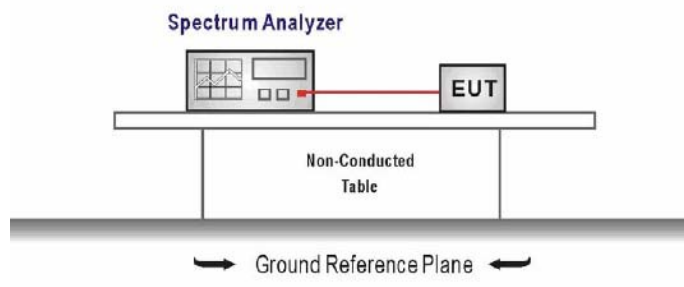

TEST PROCEDURE

1. Connect the antenna port(s) to the spectrum analyzer input.
2. **Establish a reference level by using the following procedure**
Center frequency=DTS channel center frequency
The span = 1.5 times the DTS bandwidth.
RBW = 100 kHz, VBW $\geq 3 \times$ RBW
Detector = peak, Sweep time = auto couple, Trace mode = max hold
Allow trace to fully stabilize
Use the peak marker function to determine the maximum PSD level

Note that the channel found to contain the maximum PSD level can be used to establish the reference level.

3. **Emission level measurement**
Set the center frequency and span to encompass frequency range to be measured
RBW = 100 kHz, VBW $\geq 3 \times$ RBW
Detector = peak, Sweep time = auto couple, Trace mode = max hold
Allow trace to fully stabilize
Use the peak marker function to determine the maximum amplitude level.
4. Place the radio in continuous transmit mode, allow the trace to stabilize, view the transmitter waveform on the spectrum analyzer.
5. Ensure that the amplitude of all unwanted emissions outside of the authorized frequency band excluding restricted frequency bands) are attenuated by at least the minimum requirements specified (at least 20 dB relative to the maximum in-band peak PSD level in 100 kHz). Report the three highest emissions relative to the limit.

TEST RESULTS

Test plot as follows:

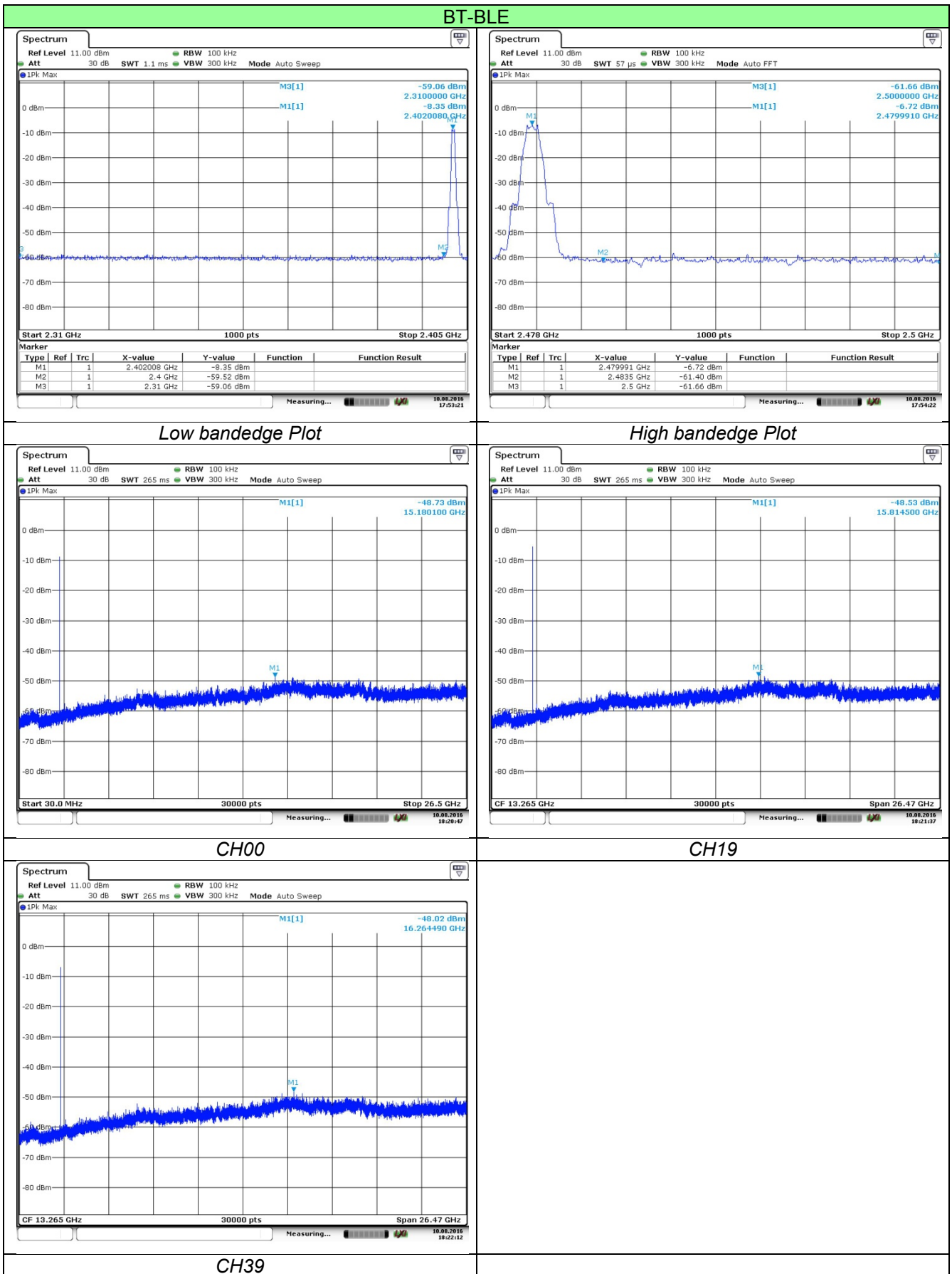

4.8. Spurious Emission (radiated)

LIMIT

FCC CFR Title 47 Part 15 Subpart C Section 15.209

Frequency	Limit (dBuV/m @3m)	Value
30MHz-88MHz	40.00	Quasi-peak
88MHz-216MHz	43.50	Quasi-peak
216MHz-960MHz	46.00	Quasi-peak
960MHz-1GHz	54.00	Quasi-peak
Above 1GHz	54.00	Average
	74.00	Peak

TEST CONFIGURATION

- 9KHz ~30MHz

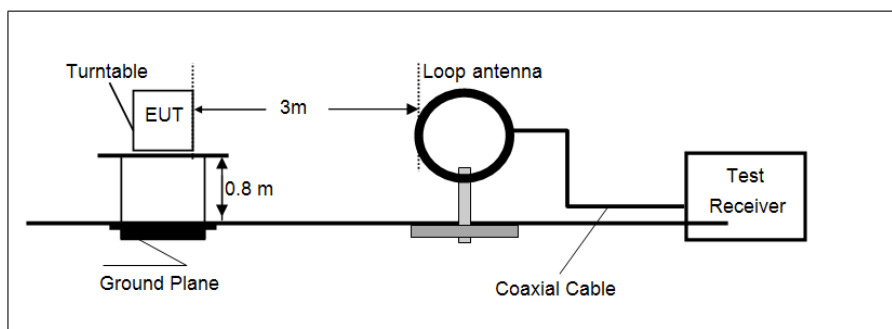

- 30MHz ~ 1GHz

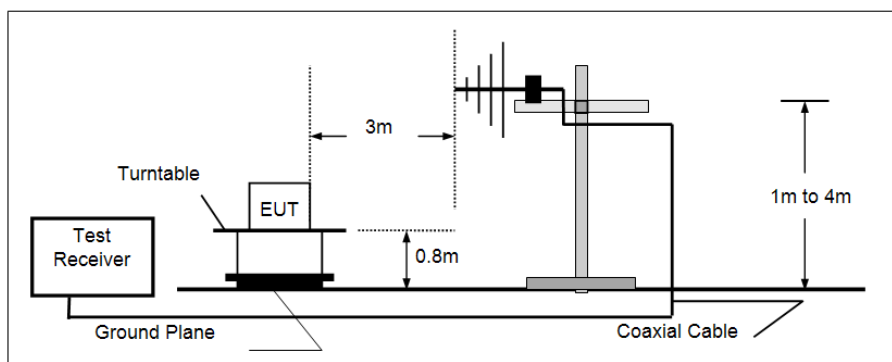

- Above 1GHz

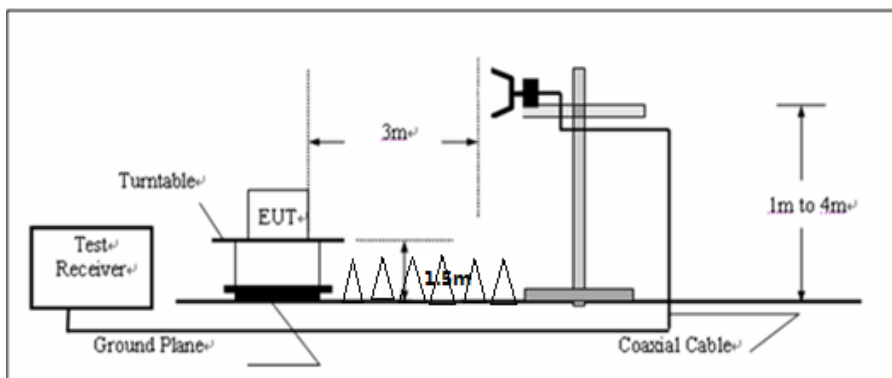

TEST PROCEDURE

1. The EUT was setup and tested according to ANSI C63.10:2013 for compliance to FCC 47CFR 15.247 requirements.
2. The EUT is placed on a turn table which is 0.8 meter above ground for below 1GHz, and 1.5m for above 1GHz. The turn table is rotated 360 degrees to determine the position of the maximum emission level.
3. The EUT was positioned such that the distance from antenna to the EUT was 3 meters.
4. The antenna is scanned from 1 meter to 4 meters to find out the maximum emission level. This is repeated for both horizontal and vertical polarization of the antenna. In order to find the maximum emission, all of the interface cables were manipulated according to ANSI C63.10:2013 on radiated measurement.
5. Use the following spectrum analyzer settings
 - (1) Span shall wide enough to fully capture the emission being measured;
 - (2) Below 1GHz, RBW=120KHz, VBW=300KHz, Sweep=auto, Detector function=peak, Trace=max hold;
If the emission level of the EUT measured by the peak detector is 3 dB lower than the applicable limit, the peak emission level will be reported. Otherwise, the emission measurement will be repeated using the quasi-peak detector and reported.
 - (3) Above 1GHz, RBW=1MHz, VBW=3MHz for Peak value
RBW=1MHz, VBW=10Hz for Average value.

TEST RESULTS**Measurement data:****■ 9kHz ~ 30MHz**

The low frequency, which started from 9 kHz to 30MHz, was pre-scanned and the result which was 20dB lower than the limit line per 15.31(o) was not reported.

■ 30MHz ~ 1GHz

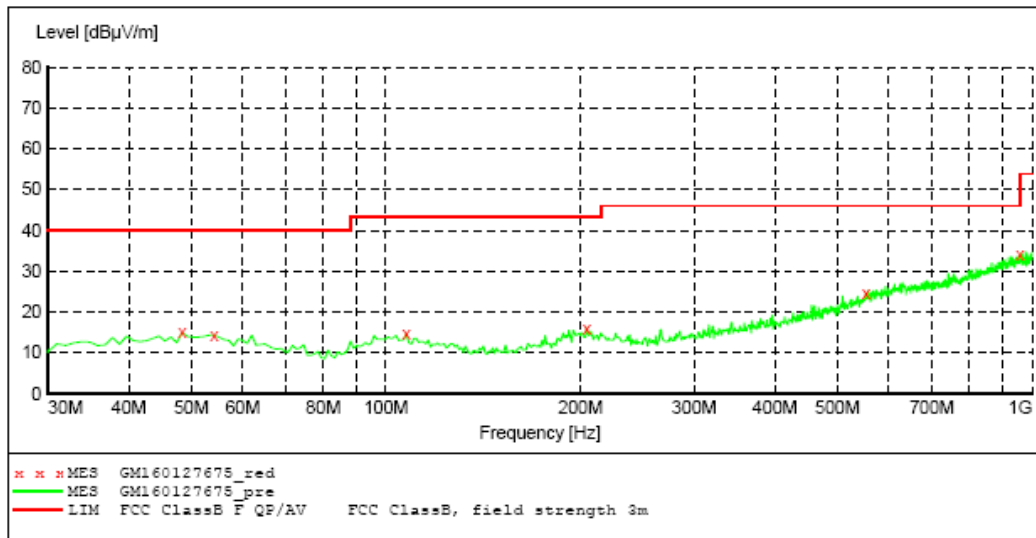

MEASUREMENT RESULT: "GM160127675_red"

7/27/2016 5:28PM

Frequency MHz	Level dBµV/m	Transd dB	Limit dBµV/m	Margin dB	Det.	Height cm	Azimuth deg	Polarization
48.430000	14.90	-14.4	40.0	25.1	QP	300.0	287.00	HORIZONTAL
54.250000	14.30	-14.7	40.0	25.7	QP	300.0	264.00	HORIZONTAL
107.600000	14.70	-14.9	43.5	28.8	QP	100.0	101.00	HORIZONTAL
204.600000	16.10	-13.8	43.5	27.4	QP	300.0	355.00	HORIZONTAL
553.800000	24.40	-4.7	46.0	21.6	QP	100.0	360.00	HORIZONTAL
958.290000	33.90	3.8	46.0	12.1	QP	300.0	264.00	HORIZONTAL

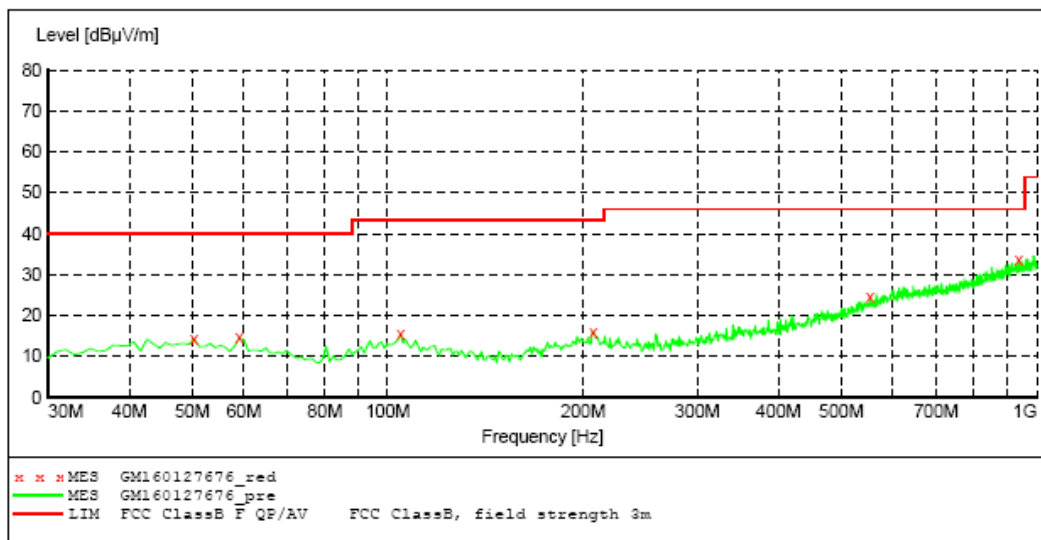

MEASUREMENT RESULT: "GM160127676_red"

7/27/2016 5:31PM

Frequency MHz	Level dBµV/m	Transd dB	Limit dBµV/m	Margin dB	Det.	Height cm	Azimuth deg	Polarization
50.370000	14.30	-14.3	40.0	25.7	QP	100.0	29.00	VERTICAL
59.100000	14.50	-15.0	40.0	25.5	QP	100.0	254.00	VERTICAL
104.690000	15.30	-14.7	43.5	28.2	QP	100.0	254.00	VERTICAL
207.510000	16.10	-13.9	43.5	27.4	QP	100.0	89.00	VERTICAL
553.800000	24.70	-4.7	46.0	21.3	QP	100.0	113.00	VERTICAL
937.920000	33.70	3.4	46.0	12.3	QP	100.0	229.00	VERTICAL

Remark: Transd=Cable lose+ Antenna factor- Pre-amplifier; Margin=Limit -Level

■ Above 1GHz

CH00 for BT-BLE									
Frequency (MHz)	Read Level (dBuV)	Antenna Factor (dB/m)	Cable Loss (dB)	Preamp Factor (dB)	Level (dBuV/m)	Limit Line (dBuV/m)	Margin Limit (dB)	Polarization	Test value
4804	36.8	31.28	5.66	35.29	38.45	74	36.8	Vertical	Peak
7206	36.65	36.22	6.87	35.15	44.59	74	36.65	Vertical	
9608	35.42	37.85	8.8	35.55	46.52	74	35.42	Vertical	
1221.16	*						*	Vertical	
4804	37.08	31.28	5.66	35.29	38.73	74	37.08	Horizontal	
7206	37.75	36.22	6.87	35.15	45.69	74	37.75	Horizontal	
9608	35.75	37.85	8.8	35.55	46.85	74	35.75	Horizontal	
1221.16	*							Horizontal	
4804	30.82	31.28	5.66	35.29	32.47	54	-21.53	Vertical	Average
7206	30.11	36.22	6.87	35.15	38.05	54	-15.95	Vertical	
9608	28.98	37.85	8.8	35.55	40.08	54	-13.92	Vertical	
1221.16	*							Vertical	
4804	30.87	31.28	5.66	35.29	32.52	54	-21.48	Horizontal	
7206	30.38	36.22	6.87	35.15	38.32	54	-15.68	Horizontal	
9608	29.22	37.85	8.8	35.55	40.32	54	-13.68	Horizontal	
1221.16	*							Horizontal	
CH19 for BT-BLE									
Frequency (MHz)	Read Level (dBuV)	Antenna Factor (dB/m)	Cable Loss (dB)	Preamp Factor (dB)	Level (dBuV/m)	Limit Line (dBuV/m)	Margin Limit (dB)	Polarization	Test value
4880	36.88	31.26	5.65	35.27	38.52	74	-35.48	Vertical	Peak
7320	36.76	36.2	6.86	35.13	44.69	74	-29.31	Vertical	
9760	35.43	37.83	8.79	35.53	46.52	74	-27.48	Vertical	
13472.51	*							Vertical	
4880	36.7	31.26	5.65	35.27	38.34	74	-35.66	Horizontal	
7320	37.8	36.2	6.86	35.13	45.73	74	-28.27	Horizontal	
9760	35.38	37.83	8.79	35.53	46.47	74	-27.53	Horizontal	
13472.51	*							Horizontal	
4880	30.94	31.26	5.65	35.27	32.58	54	-21.42	Vertical	Average
7320	30.46	36.2	6.86	35.13	38.39	54	-15.61	Vertical	
9760	29.55	37.83	8.79	35.53	40.64	54	-13.36	Vertical	
13472.51	*							Vertical	
4880	30.94	31.26	5.65	35.27	32.58	54	-21.42	Horizontal	
7320	30.54	36.2	6.86	35.13	38.47	54	-15.53	Horizontal	
9760	28.93	37.83	8.79	35.53	40.02	54	-13.98	Horizontal	
13472.51	*							Horizontal	

Remark:

- Final Level = Receiver Read level + Antenna Factor + Cable Loss – Preamplifier Factor
- "*", means this data is the too weak instrument of signal is unable to test.
- The emission levels of other frequencies are very lower than the limit and not show in test report.

CH39 for BT-BLE									
Frequency (MHz)	Read Level (dBuV)	Antenna Factor (dB/m)	Cable Loss (dB)	Preamp Factor (dB)	Level (dBuV/m)	Limit Line (dBuV/m)	Margin Limit (dB)	Polarization	Test value
4960	36.58	31.44	5.87	35.46	38.43	74	-35.57	Vertical	Peak
7440	35.11	36.38	7.08	35.32	43.25	74	-30.75	Vertical	
9920	35.13	38.01	9.01	35.72	46.43	74	-27.57	Vertical	
12366.25	*							Vertical	
4960	36.8	31.44	5.87	35.46	38.65	74	-35.35	Horizontal	
7440	37.33	36.38	7.08	35.32	45.47	74	-28.53	Horizontal	
9920	35.03	38.01	9.01	35.72	46.33	74	-27.67	Horizontal	
12366.25	*							Horizontal	
4960	30.75	31.42	5.87	35.46	32.58	54	-21.42	Vertical	Average
7440	29.57	36.36	7.08	35.32	37.69	54	-16.31	Vertical	
9920	29.37	37.99	9.01	35.72	40.65	54	-13.35	Vertical	
12366.25	*							Vertical	
4960	30.64	31.42	5.87	35.46	32.47	54	-21.53	Horizontal	
7440	30.35	36.36	7.08	35.32	38.47	54	-15.53	Horizontal	
9920	28.87	37.99	9.01	35.72	40.15	54	-13.85	Horizontal	
12366.25	*							Horizontal	

Remark:

1. Final Level = Receiver Read level + Antenna Factor + Cable Loss – Preamplifier Factor
2. “*”, means this data is the too weak instrument of signal is unable to test.
3. The emission levels of other frequencies are very lower than the limit and not show in test report.

5. Test Setup Photos of the EUT

Radiated Emission



Conducted Emission (AC Mains)



6. External and Internal Photos of the EUT

Reference to Test Report TRE1605009501

.....End of Report.....