

802.11n(H20)

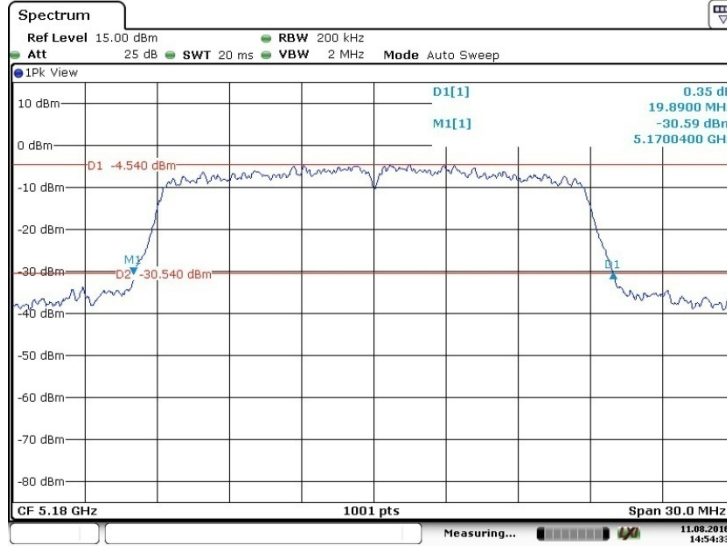

Low

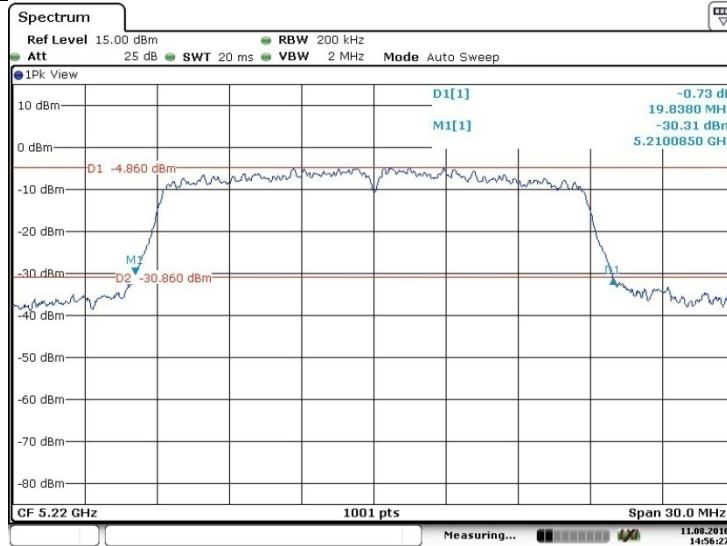

Mid

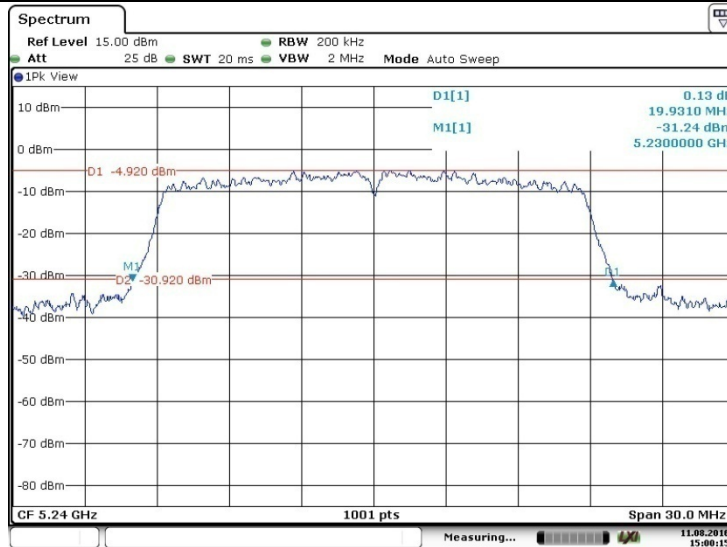

High

802.11n(H40)

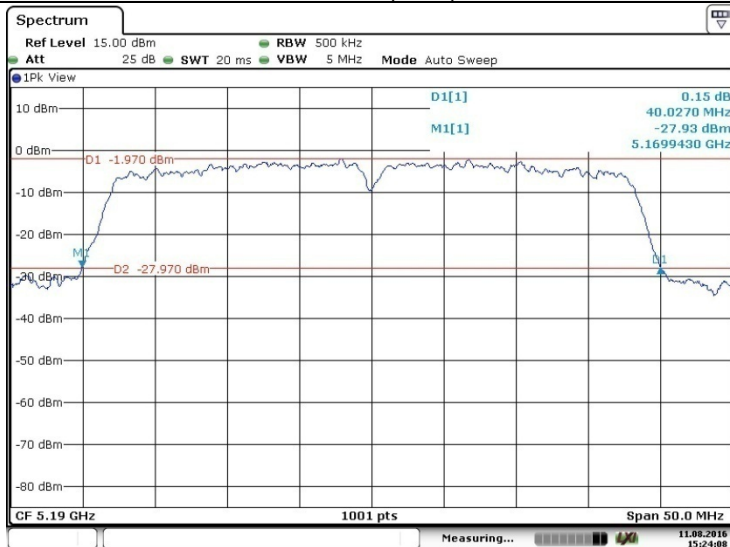

Low

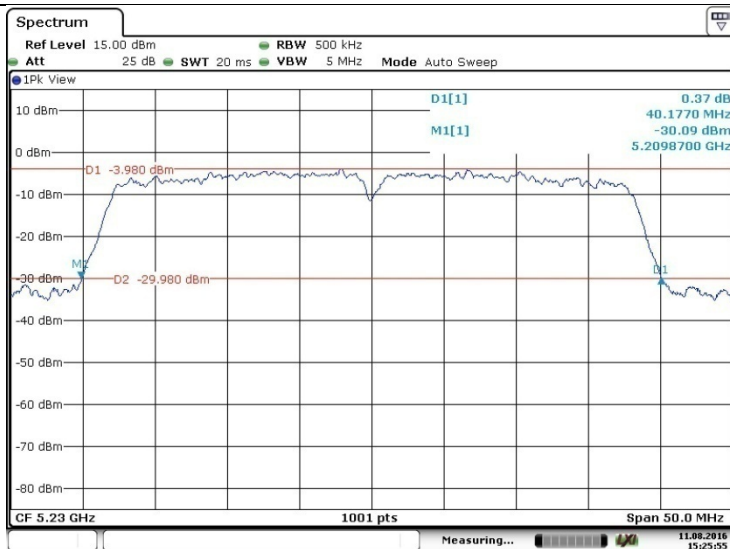

High

Band II 802.11a

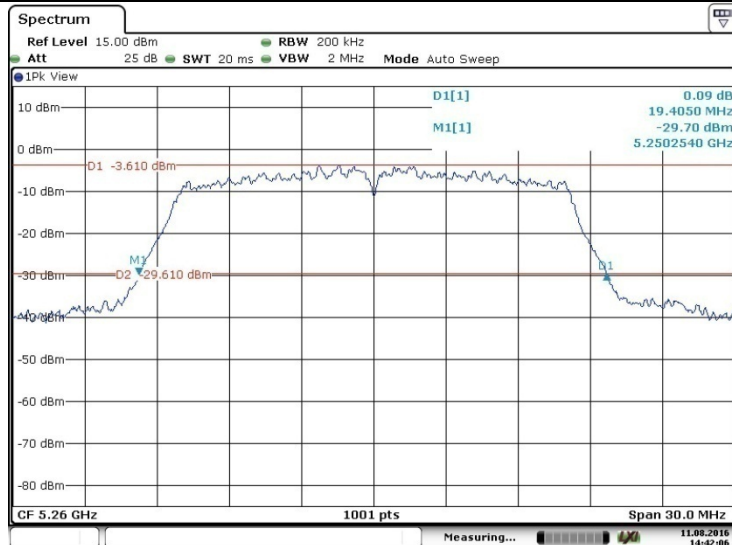

Low

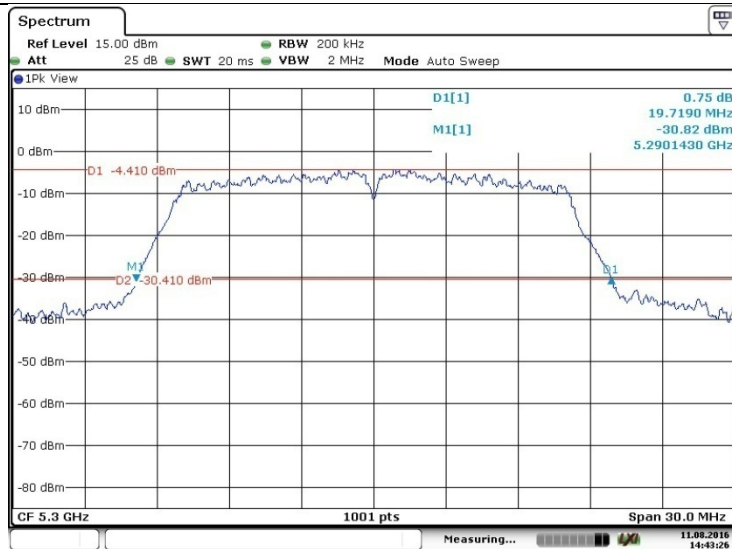

Mid

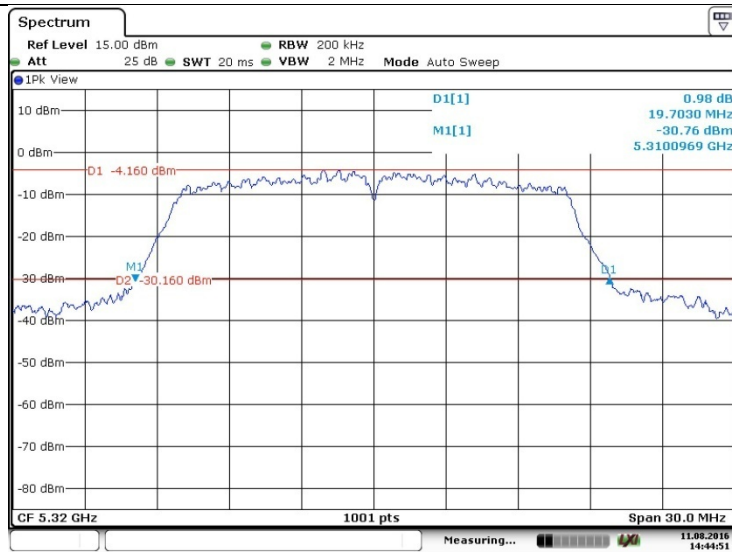

High

802.11ac(H40)

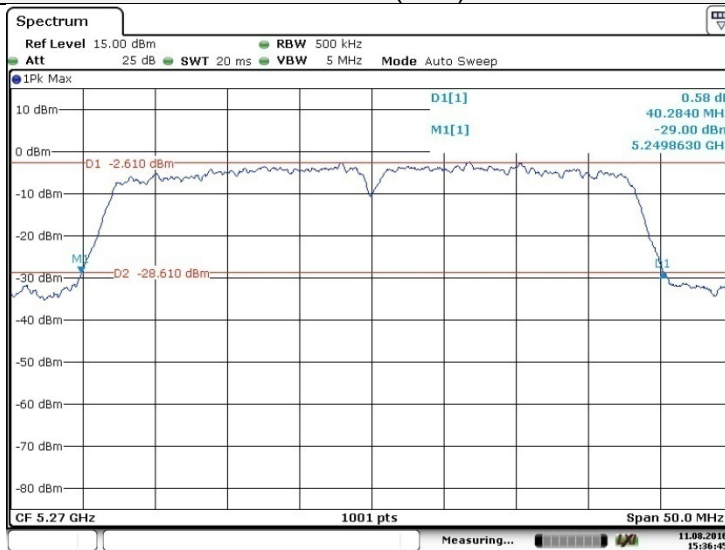

Low

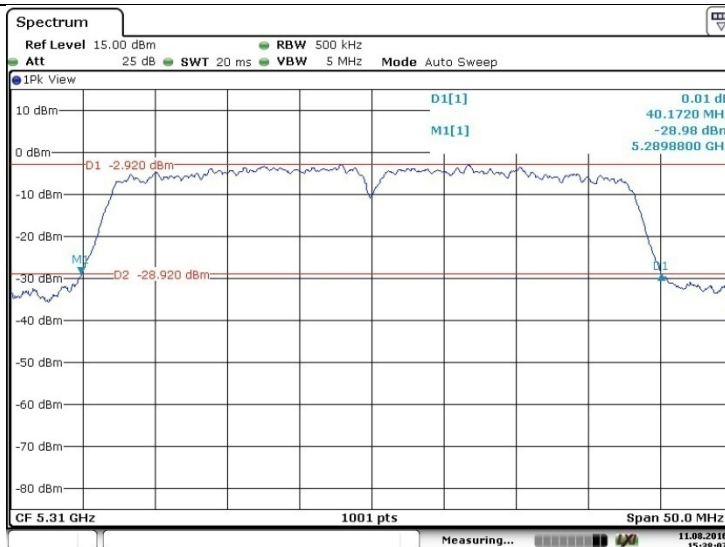

High

802.11n(H20)

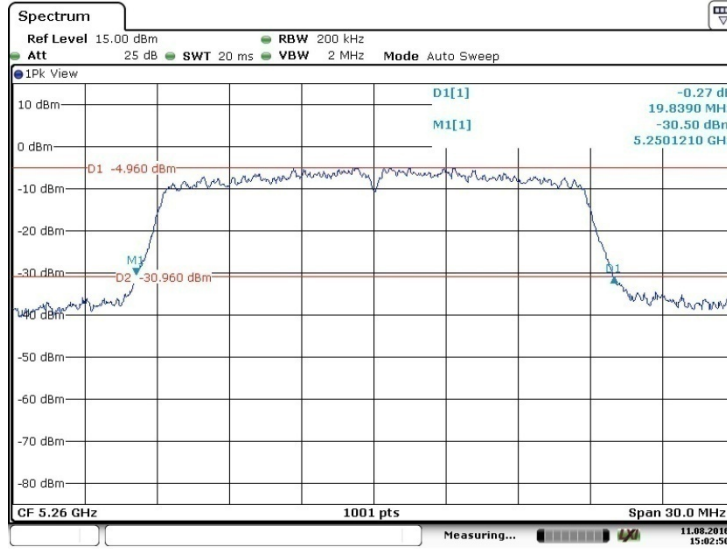

Low

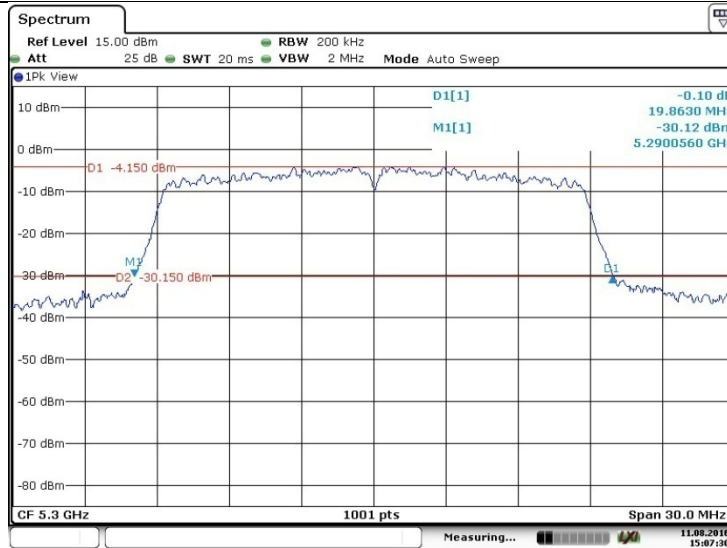

Mid

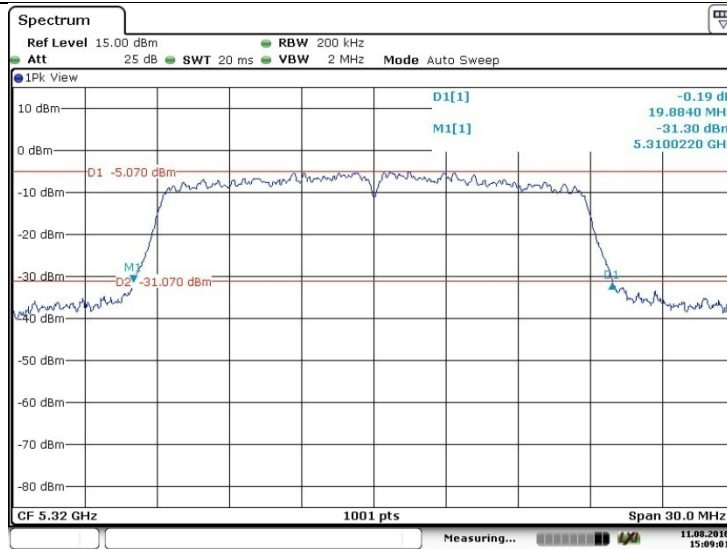

High

802.11n(H40)

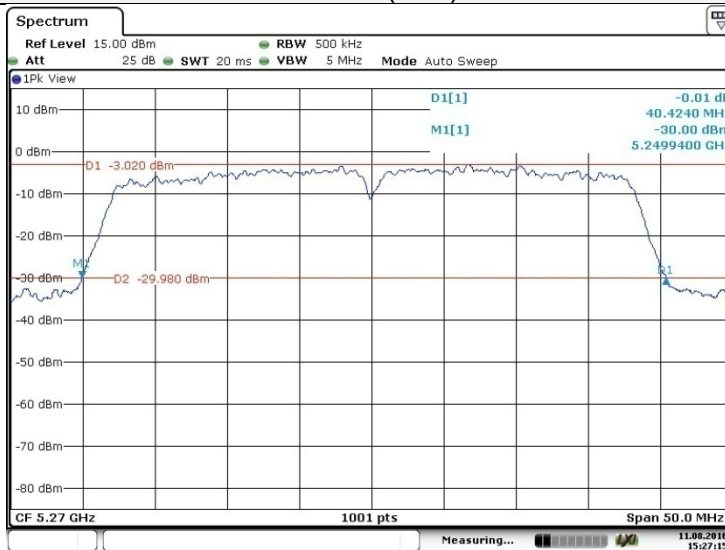

Low

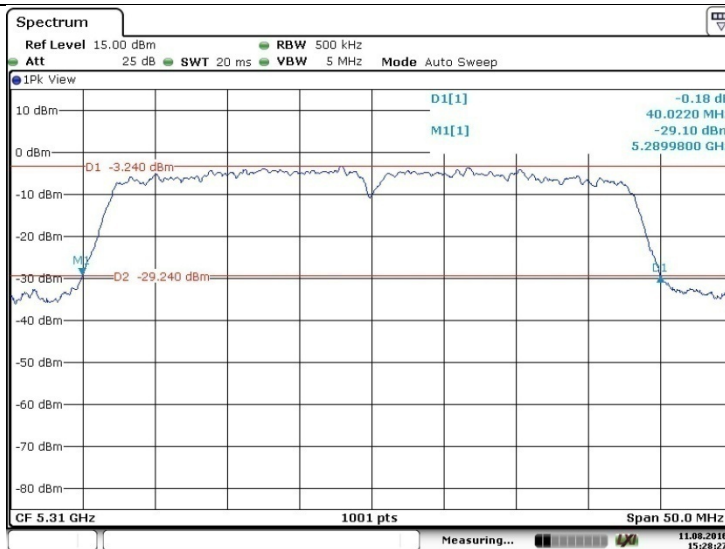

High

Band IV
802.11a

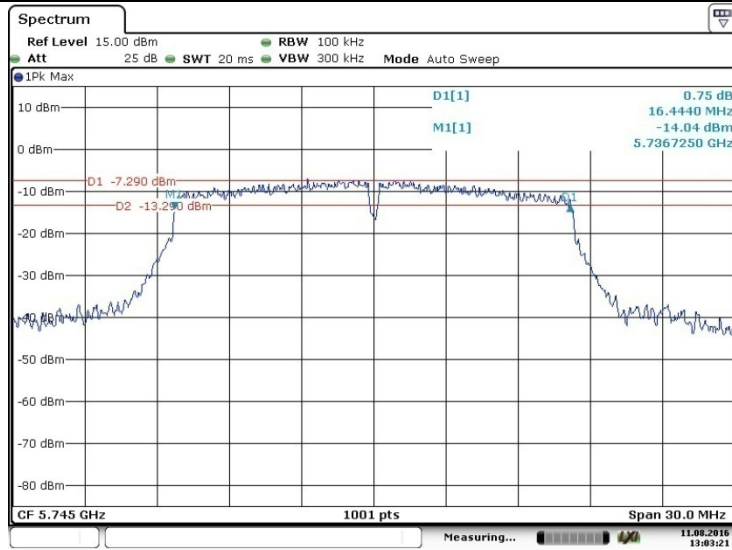

Low

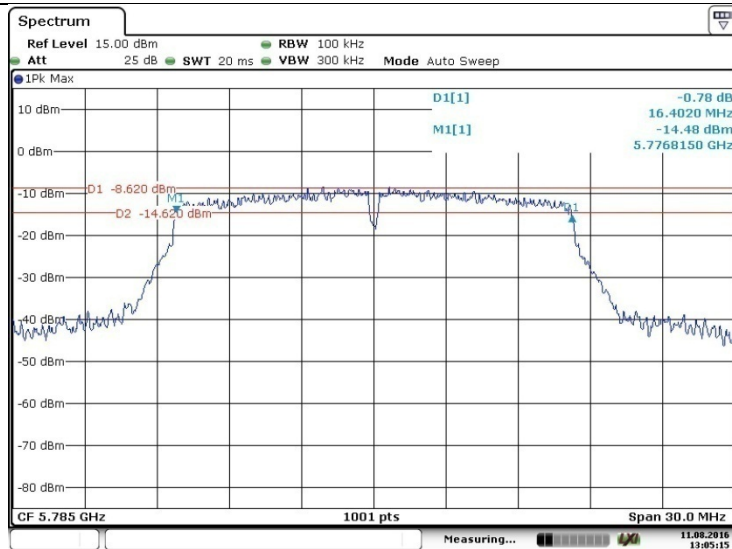

Mid

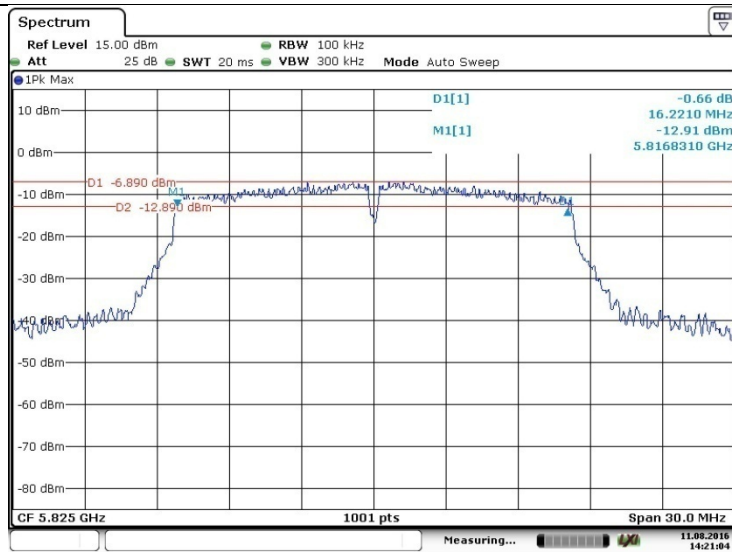

High

802.11ac(H40)

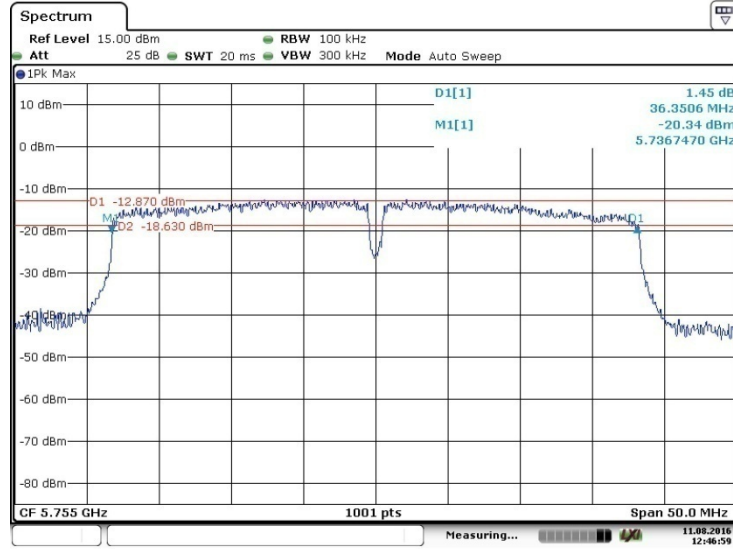

Low

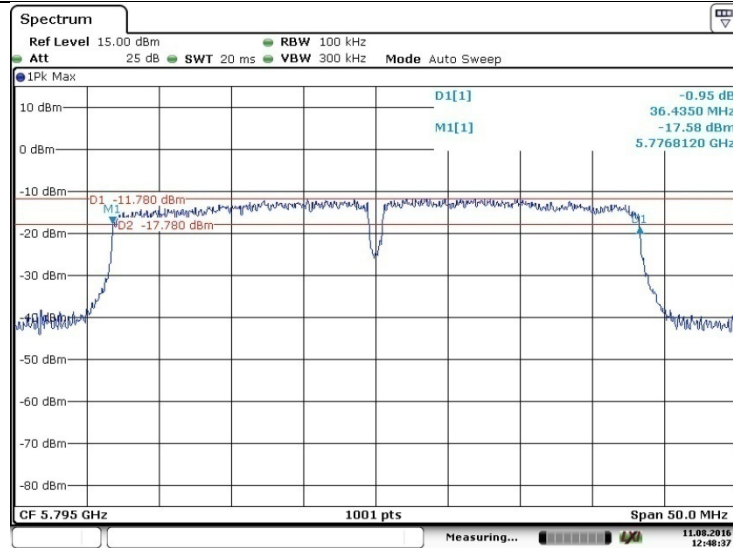

High

802.11n(H20)

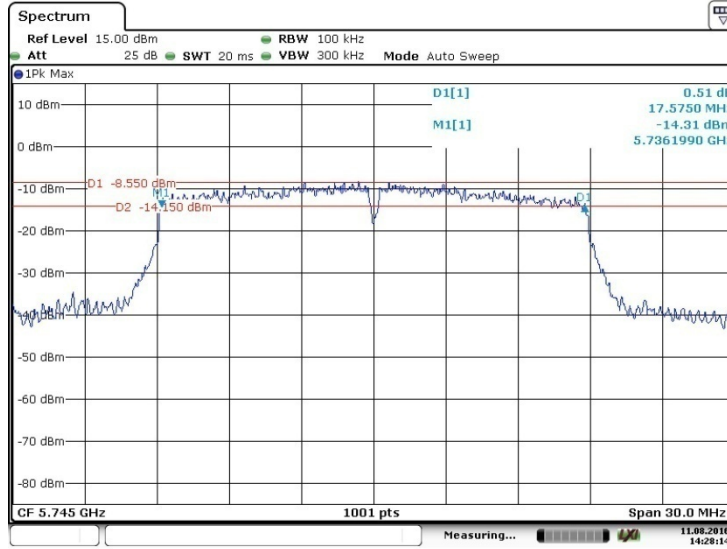

Low

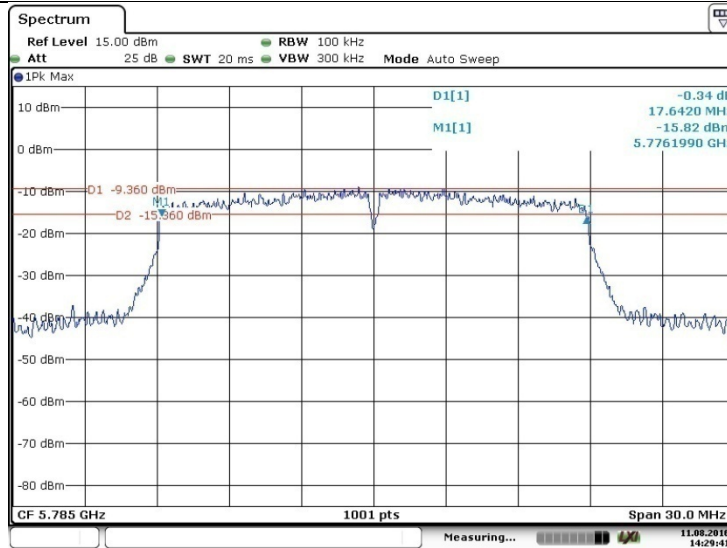

Mid

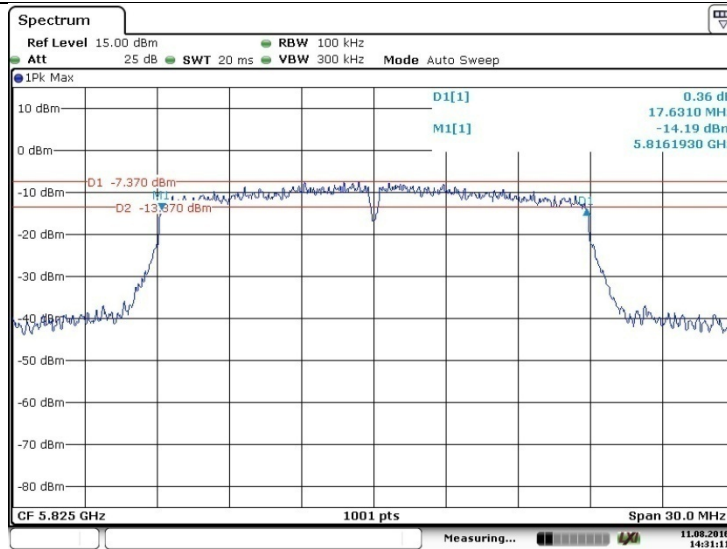

High

802.11n(H40)

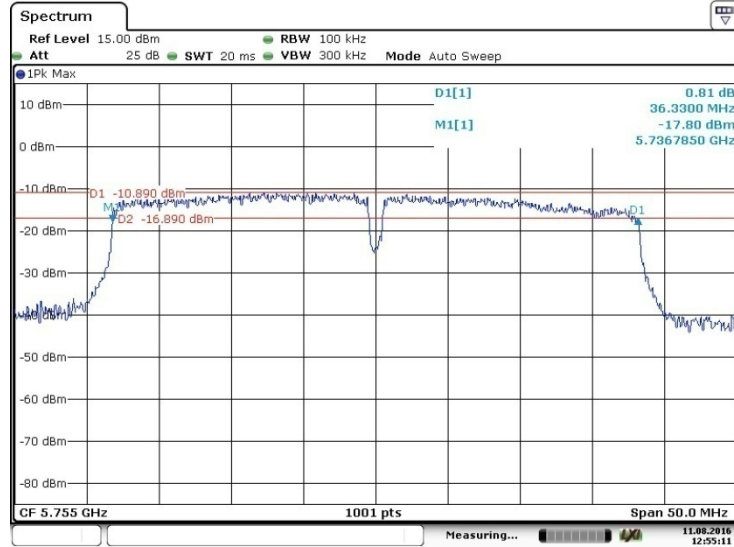

Low

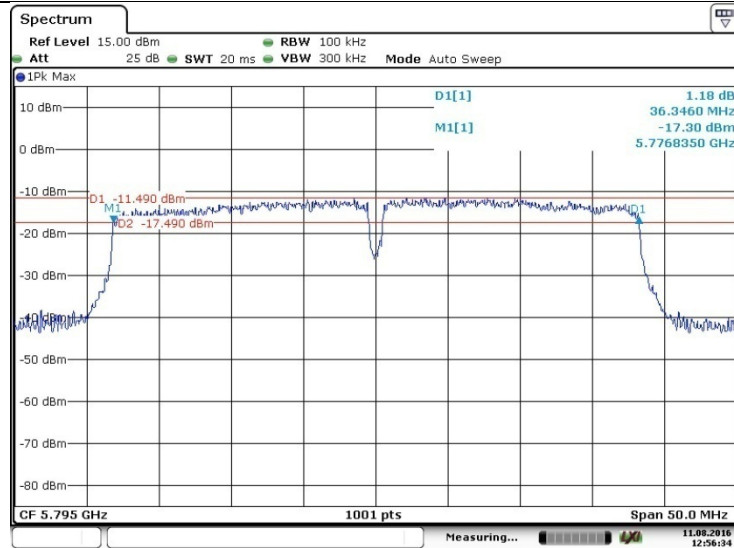

High

4.6. Radiated Emissions & Bandedge

LIMIT

FCC CFR Title 47 Part 15 Subpart C Section 15.209

Frequency	Limit (dBuV/m @3m)	Value
30MHz-88MHz	40.00	Quasi-peak
88MHz-216MHz	43.50	Quasi-peak
216MHz-960MHz	46.00	Quasi-peak
960MHz-1GHz	54.00	Quasi-peak
Above 1GHz	54.00	Average
	74.00	Peak

TEST CONFIGURATION

- 9KHz ~30MHz

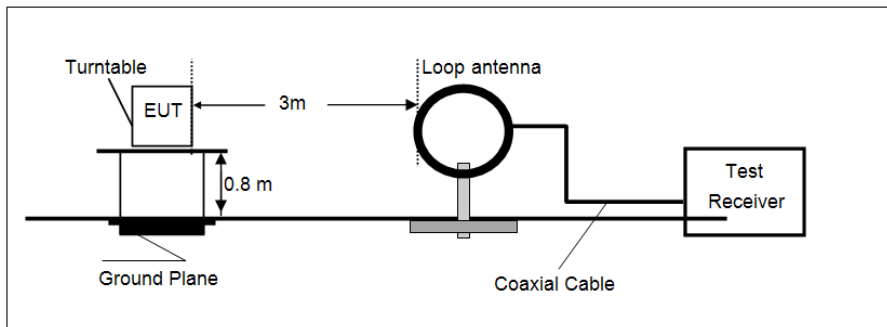

- 30MHz ~ 1GHz

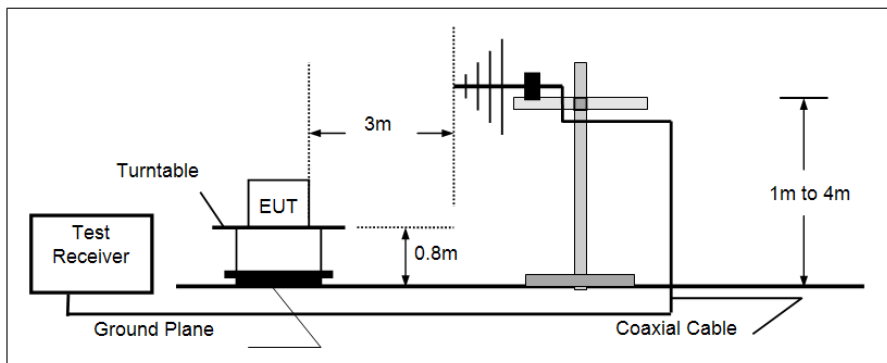

- Above 1GHz

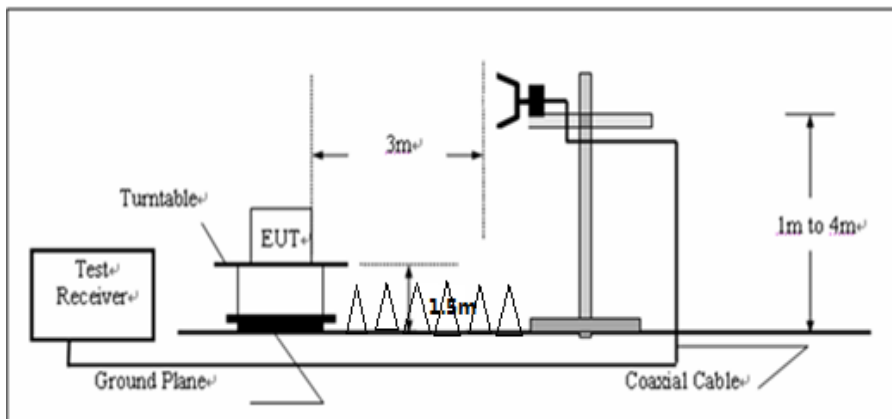

TEST PROCEDURE

1. The EUT was setup and tested according to ANSI C63.10:2013 for compliance to FCC 47CFR 15.407 requirements.
2. The EUT is placed on a turn table which is 0.8 meter above ground for below 1GHz, and 1.5m for above 1GHz. The turn table is rotated 360 degrees to determine the position of the maximum emission level.
3. The EUT was positioned such that the distance from antenna to the EUT was 3 meters.
4. The antenna is scanned from 1 meter to 4 meters to find out the maximum emission level. This is repeated for both horizontal and vertical polarization of the antenna. In order to find the maximum emission, all of the interface cables were manipulated according to ANSI C63.10:2013 on radiated measurement.
5. Use the following spectrum analyzer settings
 - (1) Span shall be wide enough to fully capture the emission being measured;
 - (2) Below 1GHz, RBW=120KHz, VBW=300KHz, Sweep=auto, Detector function=peak, Trace=max hold;
If the emission level of the EUT measured by the peak detector is 3 dB lower than the applicable limit, the peak emission level will be reported. Otherwise, the emission measurement will be repeated using the quasi-peak detector and reported.
 - (3) Above 1GHz, RBW=1MHz, VBW=3MHz for Peak value
RBW=1MHz, VBW=10Hz for Average value.

TEST RESULTS

Measurement data:

■ 9kHz ~ 30MHz

The low frequency, which started from 9 kHz to 30MHz, was pre-scanned and the result which was 20dB lower than the limit line per 15.31(o) was not reported.

■ 30MHz ~ 1GHz

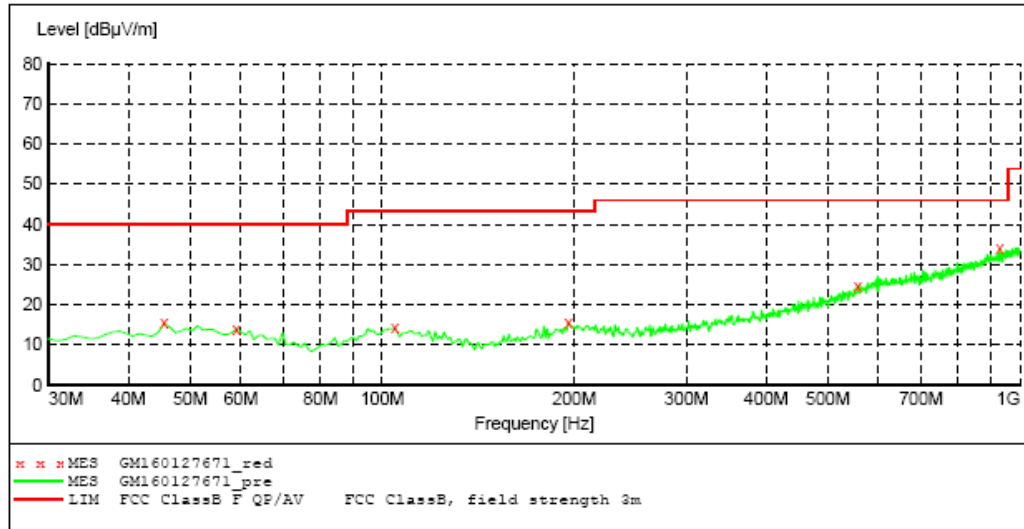

MEASUREMENT RESULT: "GM160127671_red"

7/27/2016 5:13PM

Frequency MHz	Level dBµV/m	Transd dB	Limit dBµV/m	Margin dB	Det.	Height cm	Azimuth deg	Polarization
45.520000	15.40	-14.7	40.0	24.6	QP	300.0	0.00	HORIZONTAL
59.100000	14.00	-15.0	40.0	26.0	QP	100.0	239.00	HORIZONTAL
104.690000	14.20	-14.7	43.5	29.3	QP	100.0	360.00	HORIZONTAL
195.870000	15.60	-14.0	43.5	27.9	QP	100.0	39.00	HORIZONTAL
556.710000	24.40	-4.6	46.0	21.6	QP	300.0	360.00	HORIZONTAL
930.160000	33.90	3.3	46.0	12.1	QP	300.0	360.00	HORIZONTAL

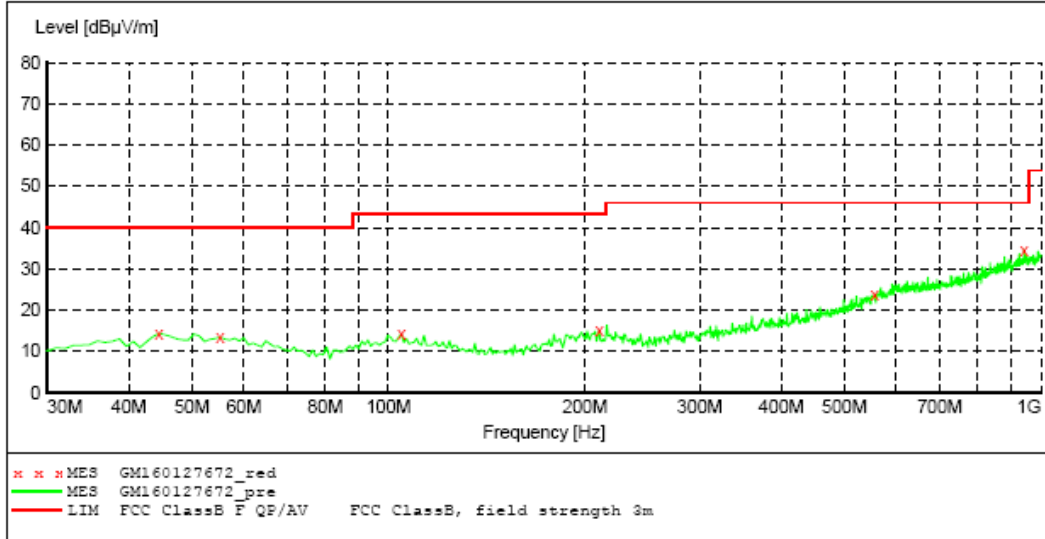

MEASUREMENT RESULT: "GM160127672_red"

7/27/2016 5:17PM

Frequency MHz	Level dBµV/m	Transd dB	Limit dBµV/m	Margin dB	Det.	Height cm	Azimuth deg	Polarization
44.550000	14.30	-14.8	40.0	25.7	QP	100.0	101.00	VERTICAL
55.220000	13.40	-14.7	40.0	26.6	QP	100.0	346.00	VERTICAL
104.690000	14.20	-14.7	43.5	29.3	QP	100.0	212.00	VERTICAL
210.420000	15.00	-14.0	43.5	28.5	QP	100.0	145.00	VERTICAL
555.740000	23.60	-4.6	46.0	22.4	QP	100.0	168.00	VERTICAL
942.770000	34.70	3.5	46.0	11.3	QP	100.0	168.00	VERTICAL

Remark:Transd=Cable lose+ Antenna factor- Pre-amplifier;Margin=Limit -Level

Above 1GHz

Band I for 802.11a Low									
Frequency (MHz)	Read Level (dBuV)	Antenna Factor (dB/m)	Cable Loss (dB)	Preamplifier Factor (dB)	Level (dBuV/m)	Limit Line (dBuV/m)	Margin Limit (dB)	Polarization	Test value
5150.00	16.59	31.56	9.43	0	57.58	74	-16.42	Vertical	Peak
5180.00	58.25	31.64	9.45	0	99.34	-	-	Vertical	
10360.00	44.73	33.08	12.59	38.05	52.35	74	-21.65	Vertical	
15540.00	*					74		Vertical	
5150.00	14.48	31.56	9.43	0	55.47	74	-18.53	Horizontal	
5180.00	57.23	31.64	9.45	0	98.32	-	-	Horizontal	
10360.00	43.74	33.08	12.59	38.05	51.36	74	-22.64	Horizontal	
15540.00	*					74		Horizontal	
5150.00	8.36	31.56	9.43	0	49.35	54	-4.65	Vertical	Average
5180.00	51.34	31.64	9.45	0	92.43	-	-	Vertical	
10360.00	39.9	33.08	12.59	38.05	47.52	54	-6.48	Vertical	
15540.00	*					54		Vertical	
5150.00	6.69	31.56	9.43	0	47.68	54	-6.32	Horizontal	
5180.00	0.27	31.64	9.45	0	41.36	-	-	Horizontal	
10360.00	40.4	33.08	12.59	38.05	48.02	54	-5.98	Horizontal	
15540.00	*					54		Horizontal	
Band I for 802.11a High									
Frequency (MHz)	Read Level (dBuV)	Antenna Factor (dB/m)	Cable Loss (dB)	Preamplifier Factor (dB)	Level (dBuV/m)	Limit Line (dBuV/m)	Margin Limit (dB)	Polarization	Test value
5240.00	57.68	30.91	8.99	0	97.58	-	-	Vertical	Peak
5250.00	15.18	31.78	9.49	0	56.45	74	-17.55	Vertical	
10500.00	42.66	33.01	12.61	38.04	50.24	74	-23.76	Vertical	
15750.00	*					74	-	Vertical	
5240.00	55.08	31.78	9.49	0	96.35	-	-	Horizontal	
5250.00	10.46	35.44	10.53	0	56.43	74	-17.57	Horizontal	
10500.00	38.49	38.2	12.17	38.08	50.78	74	-23.22	Horizontal	
15750.00	*					74	-	Horizontal	
5240.00	49.45	30.91	8.99	0	89.35	-	-	Vertical	Average
5250.00	9.37	31.78	9.49	0	50.64	54	-3.36	Vertical	
10500.00	37.94	33.01	12.61	38.04	45.52	54	-8.48	Vertical	
15750.00	*					54	-	Vertical	
5240.00	46.32	31.78	9.49	0	87.59	-	-	Horizontal	
5250.00	4.15	35.44	10.53	0	50.12	54	-3.88	Horizontal	
10500.00	33.06	38.2	12.17	38.08	45.35	54	-8.65	Horizontal	
15750.00	*					54		Horizontal	

Remark:

1. Final Level = Receiver Read level + Antenna Factor + Cable Loss – Preamplifier Factor
2. “*”, means this data is the too weak instrument of signal is unable to test.
3. The emission levels of other frequencies are very lower than the limit and not show in test report.
4. Measuring frequencies from 1 GHz to 40GHz of highest fundamental frequency.

Band I for 802.11n(H40) Low									
Frequency (MHz)	Read Level (dBuV)	Antenna Factor (dB/m)	Cable Loss (dB)	Preamp Factor (dB)	Level (dBuV/m)	Limit Line (dBuV/m)	Margin Limit (dB)	Polarization	Test value
5150.00	12.26	31.56	9.43	0	53.25	74	-20.75	Vertical	Peak
5190.00	54.71	31.68	9.46	0	95.85	-	-	Vertical	
10380.00	43.01	33.09	12.59	38.06	50.63	74	-23.37	Vertical	
15570.00	*					74	-	Vertical	
5150.00	13.53	31.56	9.43	0	54.52	74	-19.48	Horizontal	
5190.00	55.24	31.68	9.46	0	96.38	-	-	Horizontal	
10380.00	43.81	33.09	12.59	38.06	51.43	74	-22.57	Horizontal	
15570.00	*					74	-	Horizontal	
5150.00	4.86	31.56	9.43	0	45.85	54	-8.15	Vertical	Average
5190.00	46.12	31.68	9.46	0	87.26	-	-	Vertical	
10380.00	36.73	33.09	12.59	38.06	44.35	54	-9.65	Vertical	
15570.00	*					54	-	Vertical	
5150.00	6.53	31.56	9.43	0	47.52	54	-6.48	Horizontal	
5190.00	48.24	31.68	9.46	0	89.38	-	-	Horizontal	
10380.00	37.66	33.09	12.59	38.06	45.28	54	-8.72	Horizontal	
15570.00	*					54	-	Horizontal	

Band I for 802.11n(H40) High									
Frequency (MHz)	Read Level (dBuV)	Antenna Factor (dB/m)	Cable Loss (dB)	Preamp Factor (dB)	Level (dBuV/m)	Limit Line (dBuV/m)	Margin Limit (dB)	Polarization	Test value
5230.00	54.68	30.91	8.99	0	94.58	-	-	Vertical	Peak
5250.00	11.08	31.78	9.49	0	52.35	74	-21.65	Vertical	
10460.00	40.76	33.01	12.61	38.04	48.34	74	-25.66	Vertical	
15690.00	0					74	-	Vertical	
5230.00	55.98	31.78	9.49	0	97.25	-	-	Horizontal	
5250.00	7.66	35.44	10.53	0	53.63	74	-20.37	Horizontal	
10460.00	37.06	38.2	12.17	38.08	49.35	74	-24.65	Horizontal	
15690.00	*					74	-	Horizontal	
5230.00	46.53	30.91	8.99	0	86.43	-	-	Vertical	Average
5250.00	5.25	31.78	9.49	0	46.52	54	-7.48	Vertical	
10460.00	33.77	33.01	12.61	38.04	41.35	54	-12.65	Vertical	
15690.00	*					54	-	Vertical	
5230.00	46.25	31.78	9.49	0	87.52	-	-	Horizontal	
5250.00	0.87	35.44	10.53	0	46.84	54	-7.16	Horizontal	
10460.00	30.06	38.2	12.17	38.08	42.35	54	-11.65	Horizontal	
15690.00	*					54	-	Horizontal	

Remark:

1. Final Level = Receiver Read level + Antenna Factor + Cable Loss – Pre-amplifier Factor
2. “*”, means this data is too weak instrument of signal is unable to test.
3. The emission levels of other frequencies are very lower than the limit and not show in test report.
4. Measuring frequencies from 1 GHz to 40GHz of highest fundamental frequency.

Band II for 802.11a Low									
Frequency (MHz)	Read Level (dBuV)	Antenna Factor (dB/m)	Cable Loss (dB)	Preamplifier Factor (dB)	Level (dBuV/m)	Limit Line (dBuV/m)	Margin Limit (dB)	Polarization	Test value
5250.00	10.21	31.78	9.49	0	51.48	74	-22.52	Vertical	Peak
5260.00	53.04	31.82	9.49	0	94.35	-	-	Vertical	
10520.00	35.21	38.22	12.17	38.08	47.52	74	-26.48	Vertical	
15780.00	*					74	-	Vertical	
5250.00	12.6	31.78	9.49	0	53.87	74	-20.13	Horizontal	
5260.00	55.05	31.82	9.49	0	96.36	-	-	Horizontal	
10520.00	36.13	38.22	12.17	38.08	48.44	74	-25.56	Horizontal	
15780.00	*					74	-	Horizontal	
5250.00	3.25	31.78	9.49	0	44.52	54	-9.48	Vertical	Average
5260.00	45.14	31.82	9.49	0	86.45	-	-	Vertical	
10520.00	28.75	38.22	12.17	38.08	41.06	54	-12.94	Vertical	
15780.00	*					54	-	Vertical	
5250.00	7.18	31.78	9.49	0	48.45	54	-5.55	Horizontal	
5260.00	47.55	31.82	9.49	0	88.86	-	-	Horizontal	
10520.00	29.63	38.22	12.17	38.08	41.94	54	-12.06	Horizontal	
15780.00	*					54	-	Horizontal	

Band II for 802.11a High									
Frequency (MHz)	Read Level (dBuV)	Antenna Factor (dB/m)	Cable Loss (dB)	Preamplifier Factor (dB)	Level (dBuV/m)	Limit Line (dBuV/m)	Margin Limit (dB)	Polarization	Test value
5320.00	53.77	31.96	9.52	0	95.25	-	-	Vertical	Peak
5350.00	8.93	31.98	9.52	0	50.43	74	-23.57	Vertical	
10640.00	36.96	38.06	12.34	38.04	49.32	74	-24.68	Vertical	
15960.00	*					74	-	Vertical	
5320.00	56.59	31.78	9.49	0	97.86	-	-	Horizontal	
5350.00	10.34	31.82	9.49	0	51.65	74	-22.35	Horizontal	
10640.00	38.53	38.22	12.17	38.08	50.84	74	-23.16	Horizontal	
15960.00	*					74	-	Horizontal	
5320.00	45.18	31.96	9.52	0	86.66	54	32.66	Vertical	Average
5350.00	1.75	31.98	9.52	0	43.25	54	-10.75	Vertical	
10640.00	31	38.06	12.34	38.04	43.36	54	-10.64	Vertical	
15960.00	*					54	-	Vertical	
5320.00	50.16	31.78	9.49	0	91.43	54	37.43	Horizontal	
5350.00	2.33	31.82	9.49	0	43.64	54	-10.36	Horizontal	
10640.00	30.13	38.22	12.17	38.08	42.44	54	-11.56	Horizontal	
15960.00	*					54	-	Horizontal	

Remark:

1. Final Level = Receiver Read level + Antenna Factor + Cable Loss – Preamplifier Factor
2. “*”, means this data is the too weak instrument of signal is unable to test.
3. The emission levels of other frequencies are very lower than the limit and not show in test report.
4. Measuring frequencies from 1 GHz to 40GHz of highest fundamental frequency.

Band II for 802.11n(H40) Low									
Frequency (MHz)	Read Level (dBuV)	Antenna Factor (dB/m)	Cable Loss (dB)	Preamp Factor (dB)	Level (dBuV/m)	Limit Line (dBuV/m)	Margin Limit (dB)	Polarization	Test value
5250.00	9.38	31.78	9.49	0	50.65	74	-23.35	Vertical	Peak
5270.00	50.54	31.82	9.49	0	91.85	-	-	Vertical	
10540.00	35.33	38.22	12.17	38.08	47.64	74	-26.36	Vertical	
15810.00	*					74	-	Vertical	
5250.00	10.41	31.78	9.49	0	51.68	74	-22.32	Horizontal	
5270.00	52.55	31.82	9.49	0	93.86	-	-	Horizontal	
10540.00	37.54	38.22	12.17	38.08	49.85	74	-24.15	Horizontal	
15810.00	*					74	-	Horizontal	
5250.00	2.47	31.78	9.49	0	43.74	54	-10.26	Vertical	Average
5270.00	42.05	31.82	9.49	0	83.36	-	-	Vertical	
10540.00	28.75	38.22	12.17	38.08	41.06	54	-12.94	Vertical	
15810.00	*					54	-	Vertical	
5250.00	8.48	31.78	9.49	0	49.75	54	-4.25	Horizontal	
5270.00	44.16	31.82	9.49	0	85.47	-	-	Horizontal	
10540.00	29.38	38.22	12.17	38.08	41.69	54	-12.31	Horizontal	
15810.00	*					54	-	Horizontal	

Band II for 802.11n(H40) High									
Frequency (MHz)	Read Level (dBuV)	Antenna Factor (dB/m)	Cable Loss (dB)	Preamp Factor (dB)	Level (dBuV/m)	Limit Line (dBuV/m)	Margin Limit (dB)	Polarization	Test value
5310.00	50.38	31.96	9.52	0	91.86	-	-	Vertical	Peak
5350.00	7.02	31.98	9.52	0	48.52	74	-25.48	Vertical	
10620.00	36.98	38.06	12.34	38.04	49.34	74	-24.66	Vertical	
15930.00	*					74	-	Vertical	
5310.00	52.6	31.78	9.49	0	93.87	-	-	Horizontal	
5350.00	8.12	31.82	9.49	0	49.43	74	-24.57	Horizontal	
10620.00	37.93	38.22	12.17	38.08	50.24	74	-23.76	Horizontal	
15930.00	*					74	-	Horizontal	
5310.00	42.04	31.96	9.52	0	83.52	54	29.52	Vertical	Average
5350.00	0.13	31.98	9.52	0	41.63	54	-12.37	Vertical	
10620.00	29.7	38.06	12.34	38.04	42.06	54	-11.94	Vertical	
15930.00	*					54	-	Vertical	
5310.00	44.48	31.78	9.49	0	85.75	54	31.75	Horizontal	
5350.00	-0.25	31.82	9.49	0	41.06	54	-12.94	Horizontal	
10620.00	30.06	38.22	12.17	38.08	42.37	54	-11.63	Horizontal	
15930.00	*					54	-	Horizontal	

Remark:

1. Final Level = Receiver Read level + Antenna Factor + Cable Loss – Pre-amplifier Factor
2. “*”, means this data is the too weak instrument of signal is unable to test.
3. The emission levels of other frequencies are very lower than the limit and not show in test report.
4. Measuring frequencies from 1 GHz to 40GHz of highest fundamental frequency.

Band IV for 802.11a Low									
Frequency (MHz)	Read Level (dBuV)	Antenna Factor (dB/m)	Cable Loss (dB)	Preamp Factor (dB)	Level (dBuV/m)	Limit Line (dBuV/m)	Margin Limit (dB)	Polarization	Test value
5725.00	5.96	32.8	9.69	0	48.45	74	-25.55	Vertical	Peak
5745.00	50.25	32.8	9.69	0	92.74	-	-	Vertical	
11490.00	33.75	39.1	13.49	37.88	48.46	74	-25.54	Vertical	
17235.00	*					74	-	Vertical	
5725.00	49.28	30.24	8.81	38.17	50.16	74	-23.84	Horizontal	
5745.00	89.43	35.44	10.53	38.02	97.38	74	23.38	Horizontal	
11490.00	37.06	38.2	12.17	38.08	49.35	74	-24.65	Horizontal	
17235.00	*					74	-	Horizontal	
5725.00	40.76	30.24	8.81	38.17	41.64	54	-12.36	Vertical	Average
5745.00	75.48	35.44	10.53	38.02	83.43	-	-	Vertical	
11490.00	29.35	38.2	12.17	38.08	41.64	54	-12.36	Vertical	
17235.00	*					54	-	Vertical	
5725.00	42.5	30.24	8.81	38.17	43.38	54	-10.62	Horizontal	
5745.00	82.3	35.44	10.53	38.02	90.25	-	-	Horizontal	
11490.00	29.4	38.2	12.17	38.08	41.69	54	-12.31	Horizontal	
17235.00	*					54		Horizontal	

Band IV for 802.11a High									
Frequency (MHz)	Read Level (dBuV)	Antenna Factor (dB/m)	Cable Loss (dB)	Preamp Factor (dB)	Level (dBuV/m)	Limit Line (dBuV/m)	Margin Limit (dB)	Polarization	Test value
5825.00	51.87	32.93	9.72	0	94.52	-	-	Vertical	Peak
5850.00	8.18	32.96	11.24	0	52.38	74	-21.62	Vertical	
11650.00	35.54	38.21	12.32	38.01	48.06	74	-25.94	Vertical	
17475.00	*					74	-	Vertical	
5825.00	54.99	32.93	9.72	0	97.64	-	-	Horizontal	
5850.00	9.42	32.96	11.24	0	53.62	74	-20.38	Horizontal	
11650.00	36.83	38.21	12.32	38.01	49.35	74	-24.65	Horizontal	
17475.00	*					74	-	Horizontal	
5825.00	45.82	32.93	9.72	0	88.47	-	-	Vertical	Average
5850.00	2.15	32.96	11.24	0	46.35	54	-7.65	Vertical	
11650.00	28.94	38.21	12.32	38.01	41.46	54	-12.54	Vertical	
17475.00	*					54	-	Vertical	
5825.00	47.62	32.93	9.72	0	90.27	-	-	Horizontal	
5850.00	2.65	32.96	11.24	0	46.85	54	-7.15	Horizontal	
11650.00	29.14	38.21	12.32	38.01	41.66	54	-12.34	Horizontal	
17475.00	*					54		Horizontal	

Remark:

1. Final Level = Receiver Read level + Antenna Factor + Cable Loss – Preamplifier Factor
2. “*”, means this data is the too weak instrument of signal is unable to test.
3. The emission levels of other frequencies are very lower than the limit and not show in test report.
4. Measuring frequencies from 1 GHz to 40GHz of highest fundamental frequency.

Band IV for 802.11n(H40) Low									
Frequency (MHz)	Read Level (dBuV)	Antenna Factor (dB/m)	Cable Loss (dB)	Preamp Factor (dB)	Level (dBuV/m)	Limit Line (dBuV/m)	Margin Limit (dB)	Polarization	Test value
5725.00	5.09	32.8	9.69	0	47.58	74	-26.42	Vertical	Peak
5755.00	49.96	32.8	9.69	0	92.45	-	-	Vertical	
11510.00	35.15	39.1	13.49	37.88	49.86	74	-24.14	Vertical	
17265.00	*					74	-	Vertical	
5725.00	47.87	30.24	8.81	38.17	48.75	74	-25.25	Horizontal	
5755.00	86.83	35.44	10.53	38.02	94.78	74	20.78	Horizontal	
11510.00	37.39	38.2	12.17	38.08	49.68	74	-24.32	Horizontal	
17265.00	*					74	-	Horizontal	
5725.00	39.64	30.24	8.81	38.17	40.52	54	-13.48	Vertical	Average
5755.00	75.5	35.44	10.53	38.02	83.45	-	-	Vertical	
11510.00	29.45	38.2	12.17	38.08	41.74	54	-12.26	Vertical	
17265.00	*					54	-	Vertical	
5725.00	40.81	30.24	8.81	38.17	41.69	54	-12.31	Horizontal	
5755.00	79.57	35.44	10.53	38.02	87.52	-	-	Horizontal	
11510.00	28.79	38.2	12.17	38.08	41.08	54	-12.92	Horizontal	
17265.00	*					54	-	Horizontal	

Band IV for 802.11n(H40) High									
Frequency (MHz)	Read Level (dBuV)	Antenna Factor (dB/m)	Cable Loss (dB)	Preamp Factor (dB)	Level (dBuV/m)	Limit Line (dBuV/m)	Margin Limit (dB)	Polarization	Test value
5795.00	50.72	32.93	9.72	0	93.37	-	-	Vertical	Peak
5850.00	5.45	32.96	11.24	0	49.65	74	-24.35	Vertical	
11590.00	36.22	38.21	12.32	38.01	48.74	74	-25.26	Vertical	
17385.00	*					74	-	Vertical	
5795.00	53.11	32.93	9.72	0	95.76	-	-	Horizontal	
5850.00	6.48	32.96	11.24	0	50.68	74	-23.32	Horizontal	
11590.00	36.56	38.21	12.32	38.01	49.08	74	-24.92	Horizontal	
17385.00	*					74	-	Horizontal	
5795.00	42.1	32.93	9.72	0	84.75	-	-	Vertical	Average
5850.00	-3.14	32.96	11.24	0	41.06	54	-12.94	Vertical	
11590.00	28.24	38.21	12.32	38.01	40.76	54	-13.24	Vertical	
17385.00	*					54	-	Vertical	
5795.00	44.87	32.93	9.72	0	87.52	-	-	Horizontal	
5850.00	-2.12	32.96	11.24	0	42.08	54	-11.92	Horizontal	
11590.00	28.73	38.21	12.32	38.01	41.25	54	-12.75	Horizontal	
17385.00	*					54	-	Horizontal	

Remark:

1. Final Level = Receiver Read level + Antenna Factor + Cable Loss – Pre-amplifier Factor
2. “*”, means this data is the too weak instrument of signal is unable to test.
3. The emission levels of other frequencies are very lower than the limit and not show in test report.
4. Measuring frequencies from 1 GHz to 40GHz of highest fundamental frequency.

4.7. Frequency stability

LIMIT

Within Operation Band

TEST CONFIGURATION

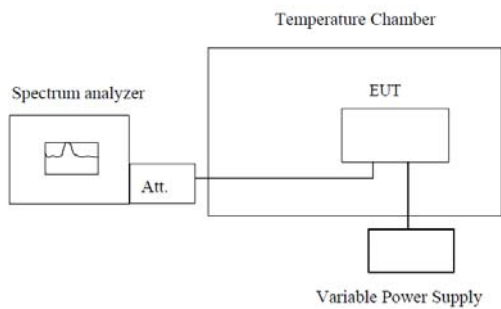

Note : Measurement setup for testing on Antenna connector

TEST PROCEDURE

1. The equipment under test was connected to an external DC power supply and input rated voltage.
2. RF output was connected to a frequency counter or spectrum analyzer via feed through attenuators.
3. The EUT was placed inside the temperature chamber.
4. Set the spectrum analyzer RBW low enough to obtain the desired frequency resolution and measure EUT 25°C operating frequency as reference frequency.
5. Turn EUT off and set the chamber temperature to -20°C. After the temperature stabilized for approximately 30 minutes recorded the frequency.
6. Repeat step measure with 10°C increased per stage until the highest temperature of +50°C reached.

TEST RESULTS

Band I for 802.11a Low				
Voltage(%)	Power(VDC)	TEMP(°C)	Freq.Dev(Hz)	Deviation(ppm)
100%	3.70	-30	28	0.005
100%		-20	43	0.008
100%		-10	37	0.007
100%		0	59	0.011
100%		+10	34	0.007
100%		+20	48	0.009
100%		+30	50	0.010
100%		+40	43	0.008
100%		+50	54	0.010
Low Battery power		3.50	+20	49
High Battery power	4.20	+20	48	0.009

Band II for 802.11a Low				
Voltage(%)	Power(VDC)	TEMP(°C)	Freq.Dev(Hz)	Deviation
100%	3.7	-30	25	0.005
100%		-20	46	0.009
100%		-10	73	0.014
100%		0	38	0.007
100%		+10	45	0.009
100%		+20	52	0.010
100%		+30	38	0.007
100%		+40	72	0.014
100%		+50	54	0.010
Low Battery power		3.50	+20	67
High Battery power	4.20	+20	73	0.014

Band IV for 802.11a Low				
Voltage(%)	Power(VDC)	TEMP(°C)	Freq.Dev(Hz)	Deviation
100%	3.7	-30	62	0.011
100%		-20	73	0.013
100%		-10	36	0.006
100%		0	48	0.008
100%		+10	53	0.009
100%		+20	54	0.009
100%		+30	38	0.007
100%		+40	52	0.009
100%		+50	59	0.010
Low Battery power		3.50	+20	49
High Battery power	4.20	+20	62	0.011

4.8. Dynamic Frequency Selection (DFS).

Requirement

Table 1: Applicability of DFS Requirements Prior to Use of a Channel

Requirement	Operational Mode		
	Master	Client Without Radar Detection	Client With Radar Detection
Non-Occupancy Period	Yes	Not required	Yes
DFS Detection Threshold	Yes	Not required	Yes
Channel Availability Check Time	Yes	Not required	Not required
U-NII Detection Bandwidth	Yes	Not required	Yes

Table 2: Applicability of DFS requirements during normal operation

Requirement	Operational Mode	
	Master Device or Client with Radar Detection	Client Without Radar Detection
DFS Detection Threshold	Yes	Not required
Channel Closing Transmission Time	Yes	Yes
Channel Move Time	Yes	Yes
U-NII Detection Bandwidth	Yes	Not required

Additional requirements for devices with multiple bandwidth modes	Master Device or Client with Radar Detection	Client Without Radar Detection
U-NII Detection Bandwidth and Statistical Performance Check	All BW modes must be tested	Not required
Channel Move Time and Channel Closing Transmission Time	Test using widest BW mode available	Test using the widest BW mode available for the link
All other tests	Any single BW mode	Not required

Note: Frequencies selected for statistical performance check (Section 7.8.4) should include several frequencies within the radar detection bandwidth and frequencies near the edge of the radar detection bandwidth. For 802.11 devices it is suggested to select frequencies in each of the bonded 20 MHz channels and the channel center frequency.

LIMIT

1. DFS Detection Thresholds

Table 3: DFS Detection Thresholds for Master Devices and Client Devices With Radar Detection

Maximum Transmit Power	Value (See Notes 1, 2, and 3)
EIRP ≥ 200 milliwatt	-64 dBm
EIRP < 200 milliwatt and power spectral density < 10 dBm/MHz	-62 dBm
EIRP < 200 milliwatt that do not meet the power spectral density requirement	-64 dBm

Note 1: This is the level at the input of the receiver assuming a 0 dBi receive antenna.

Note 2: Throughout these test procedures an additional 1 dB has been added to the amplitude of the test transmission waveforms to account for variations in measurement equipment. This will ensure that the test signal is at or above the detection threshold level to trigger a DFS response.

Note3: EIRP is based on the highest antenna gain. For MIMO devices refer to KDB Publication 662911 D01.

2. DFS Response Requirements

Table 4: DFS Response Requirement Values

Parameter	Value
Non-occupancy period	Minimum 30 minutes
Channel Availability Check Time	60 seconds
Channel Move Time	10 seconds See Note 1.
Channel Closing Transmission Time	200 milliseconds + an aggregate of 60 milliseconds over remaining 10 second period. See Notes 1 and 2.
U-NII Detection Bandwidth	Minimum 100% of the U-NII 99% transmission power bandwidth. See Note 3.

Note 1: *Channel Move Time* and the *Channel Closing Transmission Time* should be performed with Radar Type 0. The measurement timing begins at the end of the Radar Type 0 burst.

Note 2: The *Channel Closing Transmission Time* is comprised of 200 milliseconds starting at the beginning of the *Channel Move Time* plus any additional intermittent control signals required facilitating a *Channel* move (an aggregate of 60 milliseconds) during the remainder of the 10 second period. The aggregate duration of control signals will not count quiet periods in between transmissions.

Note 3: During the *U-NII Detection Bandwidth* detection test, radar type 0 should be used. For each frequency step the minimum percentage of detection is 90 percent. Measurements are performed with no data traffic.

RADAR TEST WAVEFORMS

This section provides the parameters for required test waveforms, minimum percentage of successful detections, and the minimum number of trials that must be used for determining DFS conformance. Step intervals of 0.1 microsecond for Pulse Width, 1 microsecond for PRI, 1 MHz for chirp width and 1 for the number of pulses will be utilized for the random determination of specific test waveforms.

Table 5 Short Pulse Radar Test Waveforms

Radar Type	Pulse Width (µsec)	PRI (µsec)	Number of Pulses	Minimum Percentage of Successful Detection	Minimum Number of Trials
0	1	1428	18	See Note 1	See Note 1
1	1	Test A: 15 unique PRI values randomly selected from the list of 23 PRI values in Table 5a	$\text{Roundup} \left\{ \left(\frac{1}{360} \right) \cdot \left(\frac{19 \cdot 10^6}{\text{PRI}_{\mu\text{sec}}} \right) \right\}$	60%	30
		Test B: 15 unique PRI values randomly selected within the range of 518-3066 µsec, with a minimum increment of 1 µsec, excluding PRI values selected in Test A			
2	1-5	150-230	23-29	60%	30
3	6-10	200-500	16-18	60%	30
4	11-20	200-500	12-16	60%	30
Aggregate (Radar Types 1-4)				80%	120
Note 1: Short Pulse Radar Type 0 should be used for the detection bandwidth test, channel move time, and channel closing time tests.					

A minimum of 30 unique waveforms are required for each of the Short Pulse Radar Types 2 through 4. If more than 30 waveforms are used for Short Pulse Radar Types 2 through 4, then each additional waveform must also be unique and not repeated from the previous waveforms. If more than 30 waveforms are used for Short Pulse Radar Type 1, then each additional waveform is generated with Test B and must also be unique and not repeated from the previous waveforms in Tests A or B.

For example if in Short Pulse Radar Type 1 Test B a PRI of 3066 μsec is selected, the number of pulses

would be Round up $\left\{ \left(\frac{1}{360} \right) \cdot \left(\frac{19 \cdot 10^6}{3066} \right) \right\} = \text{Round up } \{17.2\} = 18.$

Table 5a - Pulse Repetition Intervals Values for Test A

Pulse Repetition Frequency Number	Pulse Repetition Frequency (Pulses Per Second)	Pulse Repetition Interval (Microseconds)
1	1930.5	518
2	1858.7	538
3	1792.1	558
4	1730.1	578
5	1672.2	598
6	1618.1	618
7	1567.4	638
8	1519.8	658
9	1474.9	678
10	1432.7	698
11	1392.8	718
12	1355	738
13	1319.3	758
14	1285.3	778
15	1253.1	798
16	1222.5	818
17	1193.3	838
18	1165.6	858
19	1139	878
20	1113.6	898
21	1089.3	918
22	1066.1	938
23	326.2	3066

Table 6 – Long Pulse Radar Test Waveform

Radar Type	Pulse Width (μsec)	Chirp Width (MHz)	PRI (μsec)	Number of Pulses per Burst	Number of Bursts	Minimum Percentage of Successful Detection	Minimum Number of Trials
5	50-100	5-20	1000-2000	1-3	8-20	80%	30

The parameters for this waveforms are randomly chosen. Thirty unique waveforms are required for the Long Pulse Radar Type waveforms. If more than 30 waveforms are used for the Long Pulse Radar Type wave forms, then each additional waveform must also be unique and not repeated from the previous waveforms.

Table 7 – Frequency Hopping Radar Test Waveform

Radar Type	Pulse Width (μsec)	PRI (μsec)	Pulses per Hop	Hopping Rate (kHz)	Hopping Sequence Length (msec)	Minimum Percentage of Successful Detection	Minimum Number of Trials
6	1	333	9	0.333	300	70%	30

For the Frequency Hopping Radar Type, the same *Burst* parameters are used for each wave form. The hopping sequence is different for each wave form and a 100-length segment is selected from the hopping sequence defined by the following algorithm:

The first frequency in a hopping sequence is selected randomly from the group of 475 integer frequencies from 5250–5724MHz. Next, the frequency that was just chosen is removed from the group and a frequency is randomly selected from the remaining 474 frequencies in the group. This process continues until all 475 frequencies are chosen for the set. For selection of a random frequency, the frequencies remaining within the group are always treated as equally likely.

Calibration of Radar Waveform

Radar Waveform Calibration Procedure

- 1) A 50 ohm load is connected in place of the spectrum analyzer, and the spectrum analyzer is connected to place of the master
- 2) The interference Radar Detection Threshold Level is $-62\text{dBm} + 0\text{dBi} + 1\text{dB} = -61\text{dBm}$ that had been taken into account the output power range and antenna gain.
- 3) The following equipment setup was used to calibrate the conducted radar waveform. A vector signal generator was utilized to establish the test signal level for radar type 0. During this process there were no transmissions by either the master or client device. The spectrum analyzer was switched to the zero spans (time domain) at the frequency of the radar waveform generator. Peak detection was used. The spectrum analyzer resolution bandwidth (RBW) and video bandwidth (VBW) were set to 3 MHz. The spectrum analyzer had offset -1.0dB to compensate RF cable loss 1.0dB .
- 4) The vector signal generator amplitude was set so that the power level measured at the spectrum analyzer was $-62\text{dBm} + 0\text{dBi} + 1\text{dB} = -61\text{dBm}$. Capture the spectrum analyzer plots on short pulse radar waveform.

Conducted Calibration Setup

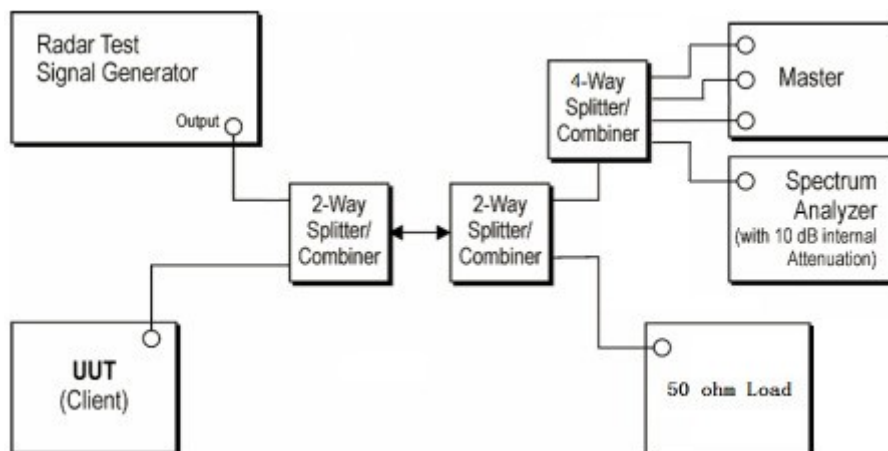

Radar Waveform Calibration Result Radar Type 0 (20MHz / 5260MHz)

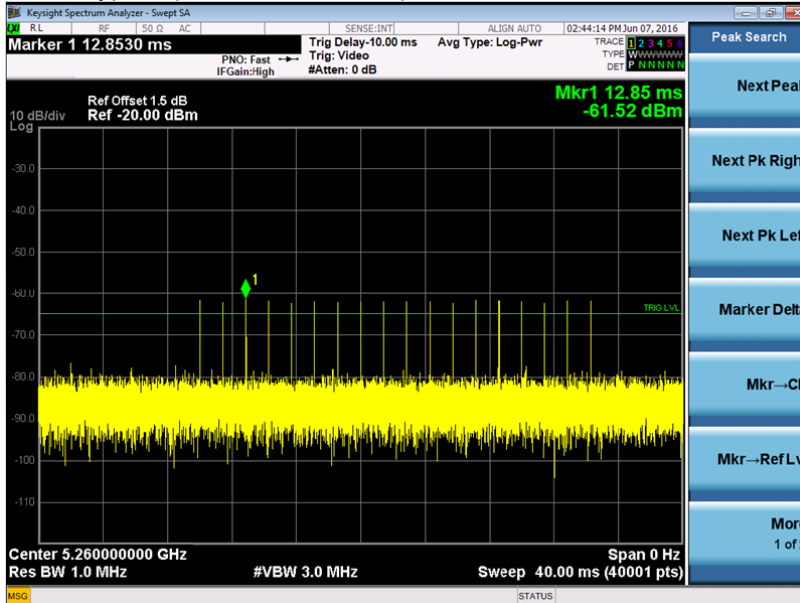

Radar Type 0 (40MHz / 5270MHz)



TEST CONFIGURATION

Setup for Client with injection at the Master

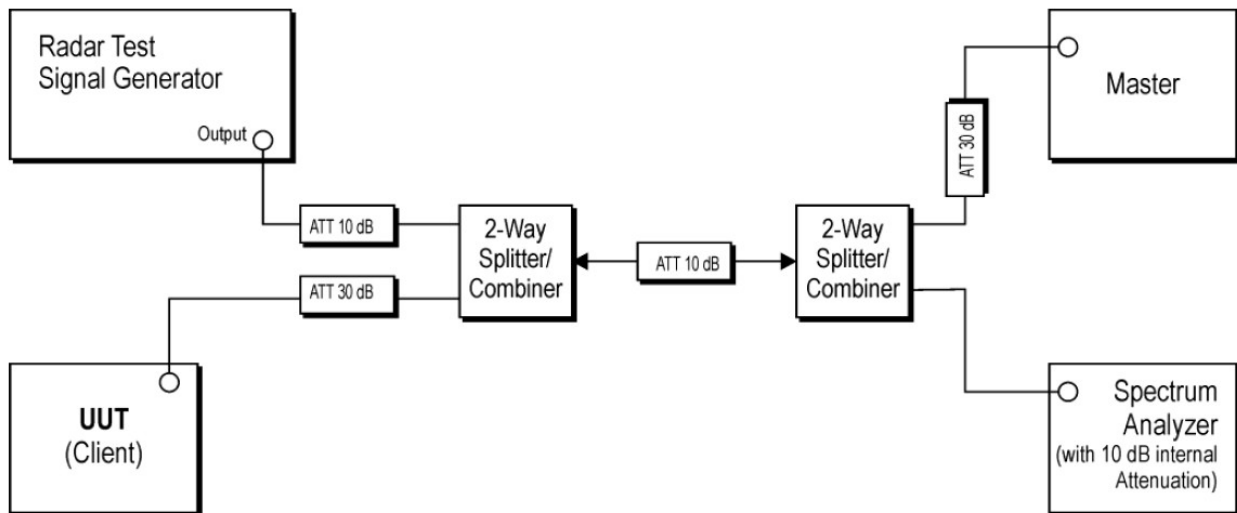

TEST PROCEDURE

1. The radar pulse generator is setup to provide a pulse at frequency that the master and client are operating. A type 0 radar pulse with a 1us pulse width and a 1428us PRI is used for the testing.
2. The vector signal generator is adjusted to provide the radar burst (18 pulses) at the level of approximately -61dBm at the antenna port of the master device
3. A trigger is provided from the pulse generator to the DFS monitoring system in order to capture the traffic and the occurrence of the radar pulse.
4. EUT will associate with the master at channel. The file "iperf.exe" specified by the FCC is streamed from the PC 2 through the master and the client device to the PC 1 and played in full motion video using Media Player Classic Ver. 6.4.8.6 in order to properly load the network for the entire period of the test.
5. When radar burst with a level equal to the DFS Detection Threshold +1dB is generated on the operating channel of the U-NII device. At time T0 the radar waveform generator sends a burst of pulse of the radar waveform at Detection Threshold +1dB.
6. Observe the transmissions of the EUT at the end of the radar Burst on the Operating Channel Measure and record the transmissions from the UUT during the observation time (Channel Move Time). One 15 seconds plot is reported for the Short Pulse Radar Type 0. The plot for the Short Pulse Radar Types start at the end of the radar burst. The Channel Move Time will be calculated based on the zoom in 600ms plot of the Short Pulse Radar Type
7. Measurement of the aggregate duration of the Channel Closed Transmission Time method. With the spectrum analyzer set to zero span tuned to the center frequency of the EUT operating channel at the radar simulated frequency, peak detection, and max hold, the dwell time per bin is given by: $Dwell (0.3ms) = S (12000ms) / B (4000)$; where Dwell is the dwell time per spectrum analyzer sampling bin, S is sweep time and B is the number of spectrum analyzer sampling bins. An upper bound of the aggregate duration of the intermittent control signals of Channel Closing Transmission Time is calculated by: $C (ms) = N \times Dwell (0.3ms)$; where C is the Closing Time, N is the number of spectrum

analyzer sampling bins (intermittent control signals) showing a U-NII transmission and Dwell is the dwell time per bin.

8. Measurement the EUT for more than 30 minutes following the channel move time to verify that no transmission or beacons occur on this channel.

TEST RESULTS

BW/Channel	Test Item	Test Result(s)	Limit	Result
20MHz/5260MHz	Channel Move Time	4.0060	<10s	Pass
	Channel Closing Transmission Time	0.0345	<0.26s	Pass
40MHz/5270MHz	Channel Move Time	3.9392	<10s	Pass
	Channel Closing Transmission Time	0.0311	<0.26s	Pass

Band II Channel Move Time & Channel Closing Transmission Time

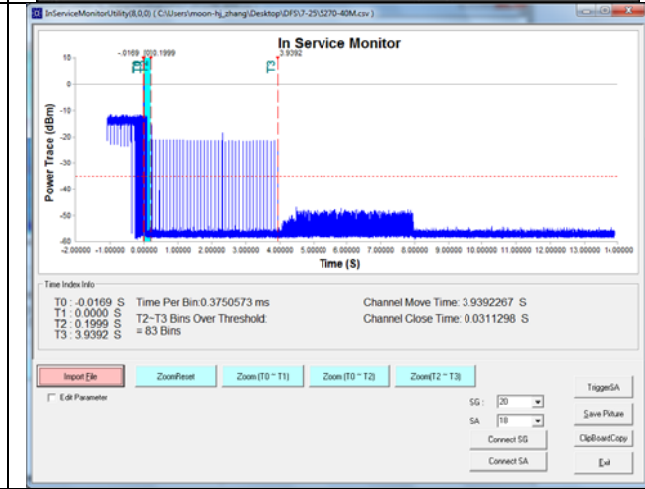
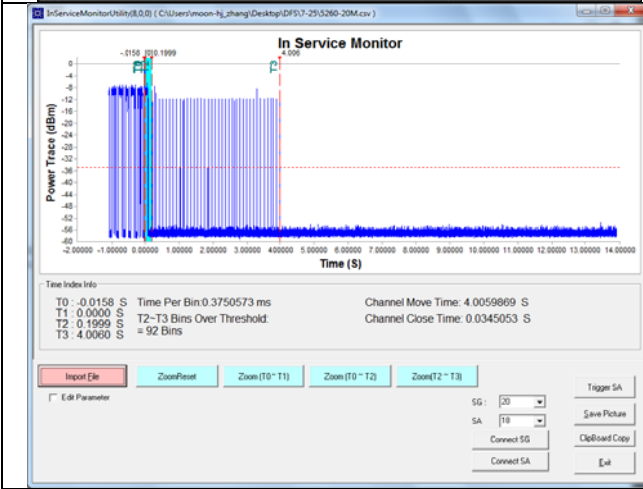
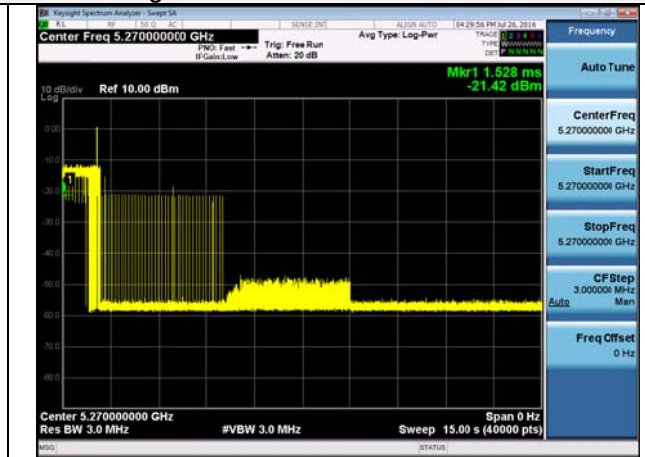
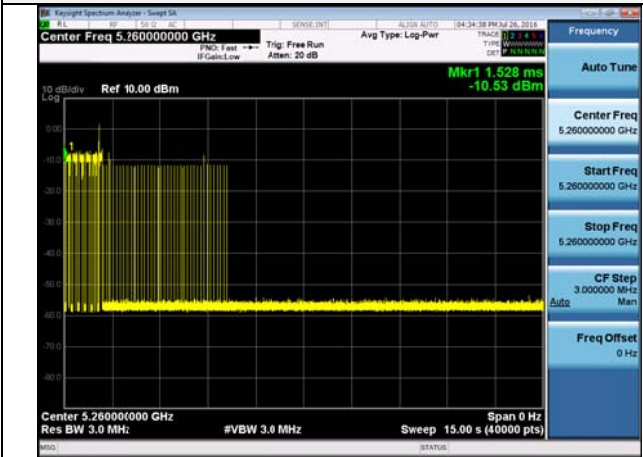

20MHz/5260MHz

40MHz/5270MHz

5. Test Setup Photos of the EUT

Radiated Emission



Conducted Emission (AC Mains)



DFS Test



6. External and Internal Photos of the EUT

Reference to Test Report TRE1605009501

.....End of Report.....