

SOUNDSTREAM

AV Center

Owner's Manual EN

2-Din Head unit

2 DIN 7" Monitor
Touch screen
MP3/MP4/USB/SD
AM/FM Radio
Support Apple Carplay
Support Android Auto
Support Bluetooth



VRCPAA-70M

INTRODUCTION

Safety Warnings and Considerations (for Amplifier / DSP / Active Woofer)

- Clean only with a dry cloth or other similar materials.
- Install your product in a dry, well-ventilated location that does not interfere with your vehicle's safety equipment.
- Do not block any ventilation openings when installing this product.
- Do not mount the product in the engine compartment of your vehicle or in any areas of extreme heat such as mufflers, silencers, exhaust pipes or other heat producing apparatus.
- Securely mount the product so that it does not come loose in the event of a collision or as a result of repeated vibrations that might occur during normal operation.
- Installation of the apparatus must be done with great care to prevent damage to your vehicle's fuel lines, power, and other electrical wiring, hydraulic brake lines, and other systems. If possible always visit your nearest Nakamichi dealer to perform the installation.
- Do not run any wiring outside or underneath the vehicle. Keep all wires inside the vehicle.
- Take the necessary precautions when making connections to the vehicle's battery to avoid any potential shock.
- Protect all system wires from sharp edges by carefully routing them, always use rubber grommets to protect wiring and cables whenever you are installing them through metal openings.
- Secure all wiring using cable ties or wire clamps to protect them from moving parts and sharp edges.
- This apparatus shall not be exposed to dripping or splashing, and no object filled with liquids, shall be placed on the apparatus.
- Refer all servicing to qualified service personnel. Servicing is required when the apparatus has been damaged in any way, such as the power input terminals are damaged, liquid has been spilled or objects have fallen into the apparatus, the apparatus has been exposed to rain or moisture, does not operate normally, or has been dropped.
- Fuses shall be replaced only with the correct type and fuse value, and only when the apparatus is powered off.
- Exposure to high sound pressure levels may lead to permanent hearing loss. Take every precaution to protect your hearing.
- This product is designed specifically for use with 12 volt, negative- ground electrical systems only. Using this product in systems with positive ground and/or voltages other than 12V may result in damage to the product and your system.

CONTENTS

Introduction	02
Touch Button Function Introduction	03
Remote Control Introduction	05
Functions & Applications	07
Basic Operation	
Main Menu	
Radio	
Phone	
External Play Device	
Music	
Settings Operation	
AV-IN	
android auto/ Apple CarPlay	
Wiring Connection	16
Installation & Accessories	17
Parking & Speaker connection	18
Common Trouble-shooting	19
Specification	20

TOUCH BUTTON FUNCTION INTRODUCTION



1. **Microphone:** Built-in Microphone.
2. **Volume+:** long press to increase volume continuously;
short press to increase volume by step.
3. **Volume-:** long press to decrease volume continuously;
short press to decrease volume by step.
4. **Power:** when the screen open, short press into mute mode,
short press once again to unmute; long press to close
the screen; when the screen close and ACC&B+ ON,
short press to open the screen.
5. **Home:** Press to enter main menu.
6. **Voice Recognition:** Press to active Siri/AA voice function.
7. **Micro SD:** Insert Micro SD for playback.
8. **Remote Sensor:** Receive the remote signal.
9. **Reset:** If the unit or the connected unit fails to operat
properly, the returns to factory settings when
this button is pressed.

REMOTE CONTROL INTRODUCTION

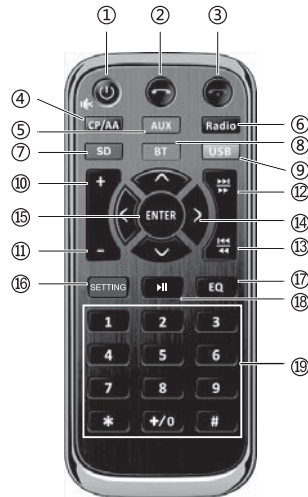

- 1. Power On/Off:** When the unit is power off, short press to Power ON
When the unit is working, long Press to Power Off.

Short Press: When the unit is working, short press to Mute / Unmute.
- 2. Answer button:**[CP/AA/BT Phone] - Call out /Answer a call.
- 3. Reject button:** [CP/AA/BT Phone] - Reject an incoming call /Hang up the calling.
- 4. CP/AA:** Press to enter Apple CarPlay / Android Auto directly (When the iPhone/Android phone is connected).
- 5. AUX button:** Enter the AV-IN interface.
- 6. Radio button:** Enter the Radio interface.
- 7. SD button:** Enter the SD interface.
- 8. BT button:** Enter the BT Phone interface.
- 9. USB button:** Enter the USB interface.
- 10. VOL+:** Increase volume.
- 11. VOL-:** Decrease volume.
- 12. NEXT: Short Press:** [Radio] Switch to the next preset.
[USB/SD] Next track.
[CP/AA/BTphone]Next track.

Long Press: [Radio] - Automatic seek (upward).
[USB/SD] - Fast forward.

REMOTE CONTROL INTRODUCTION

- 13. Previous: Short Press:** [Radio] Switch to the previous preset.
[USB/SD] Select previous track.
[CP/AA/BTphone] Previous track.
- Long Press:** [Radio] - Automatic seek (downward).
[USB/SD] - Fast rewind.
- 14. Short Press:** [CP/AA] - Move the cursor.
[RADIO]- (left / right)Frequency step function.
- 15. Enter button:** [CP/AA] - Select the function.
[RADIO/USB/SD] - Confirm the number entered.
- 16. Setting button:** Enter the setting interface and click again to enter the current mode.
- 17. EQ button:** Enter the EQ interface and click again to enter the current mode.
- 18. Play/Pause:** Press to Play or Pause.
- 19. Number:** [1-6] (AM/FM) , press any one of the number key 1-6 to select a station that had been stored in the preset memory number key 1-6 for broadcasting.
- [0-9] (USB/SD) , press directly to input the number of track for playback.
- [0-9,*,#] (Phone) , press directly to input the number for dial out.

FUNCTIONS APPLICATION

Basic Operations

Main Menu

Please refer to the actual menu display for reference.

During initial power on, the unit will show the languages setting interface, select the required country and language, then press “√” to enter the main menu.



Radio: Shows the Radio interface.

Phone: Shows the Bluetooth connection interface.

Android Auto/Apple CarPlay:

Shows the relevant interface based on your connected device.

USB: Shows the USB playback interface for compatible files.

BT Music: Shows the music playback interface.



F-camera: Turn on the front camera.

Setting: Shows the Settings interface.

AV-In: Shows the AUX interface.

Card: Shows the TF Card interface, enabling playback for compatible files.

Screen off: Turns off the screen, to reactivate the screen simply press any part of the screen.

Radio

Touch “Radio” in the main menu to enter the radio interface.



To return to the main menu.

Switch between FM1/FM2/FM3 /AM1/AM2.

Enter the EQ settings interface.

Switch Local/DX.

Shows the Radio tuning input interface, input the frequency directly or selected preset stations to start playing.

Browsing for available stations, long press to automatically search and save stations with the strongest signals into the presets.

FUNCTIONS APPLICATION

【◀◀】 Short press to search backward for stations automatically, Long press to step back.

【▶▶】 Short press to search forward for stations automatically, Long press to step.



RDS Function

RDS will allow you to display information such as traffic status, radio station name and more.

The unit can automatically switch to the strongest station based on the similar program.

AF: Turn on/off AF mode.

TA: Turn on/off TA mode.

PTY: Shows program types, and allows you to search for stations according to different programs as below:



Phone

This unit allows for hands free calling, using your phone's Bluetooth connection to the unit, you'll be able to dial, answer, access phone book and playback music.

Enter the Bluetooth interface using the Bluetooth button.



☐: Keyboard, enter call mode.

☎: History, show the call record, missed, received and dialed calls

☑: Phone book, show the phone-book connected phone

⚙: Setup

Pair/Connect

Connect your phone to the unit using the below steps.

1. Access the Bluetooth connection interface in your phone.
2. Search for Bluetooth devices from either the unit or phone.
3. The device will pop up the pairing code and click "pairing" to complete the connection.

FUNCTIONS APPLICATION

No Pair:

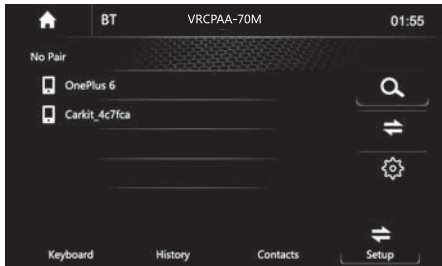

Paired:

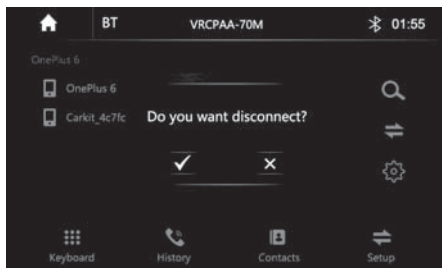

 Search the available devices.

 Manage the connected device.

 Set auto answer and load phone book.

Dial

Once the phone and unit are connected successfully, you'll be able to make calls from the unit.

Touch  to make a call.

Touch  to delete numbers one by one, long press to delete all inputted numbers.

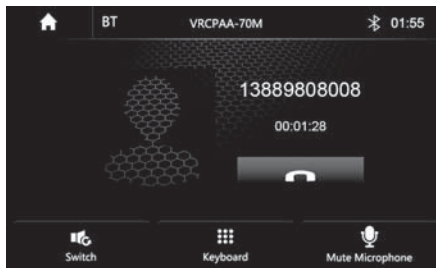

Touch  to show the numbers keyboard, touch again to exit.

Touch  to hang up the call.

Touch  to switch call audio to earphone/AV receiver.

Touch  to mute.

Receive an incoming call

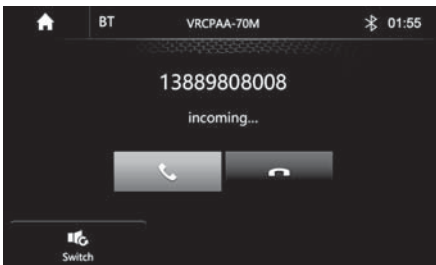

 Answer the incoming call.

 Reject the incoming call.

FUNCTIONS APPLICATION

Note: You can also manage calls through your phone.

Calling Record

Check for dialed/answered/missed calls history. Touch  icon to enter calling record interface:

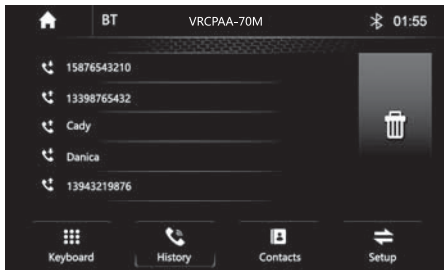

: Delete desired calls.

Phone Book

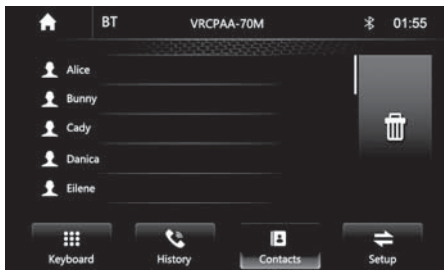

When your phone and unit are paired, the unit can automatically reach contacts from your phone and store them within the unit. (selected phones only)

: Delete Contacts.

BT Setup

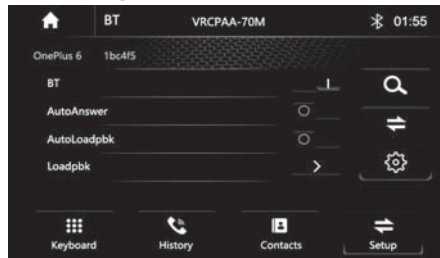

BT Switch the BT function is On or Off .

Auto Answer Incoming call auto answer.

Auto Loadpbk, On /OFF, when connect phone auto load phonebook on or off.

Loadpbk, Manually load phone book.

Bluetooth Audio Playback

Touch  to enter music interface.

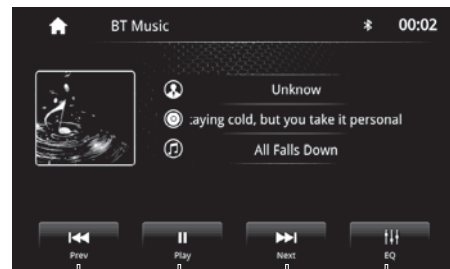

1. Play previous song/media
2. Play/pause current song/media
3. Play next song/media
4. EQ settings

FUNCTIONS APPLICATION

External Play Device

When you connect a compatible data device to your unit, the following interface will appear.

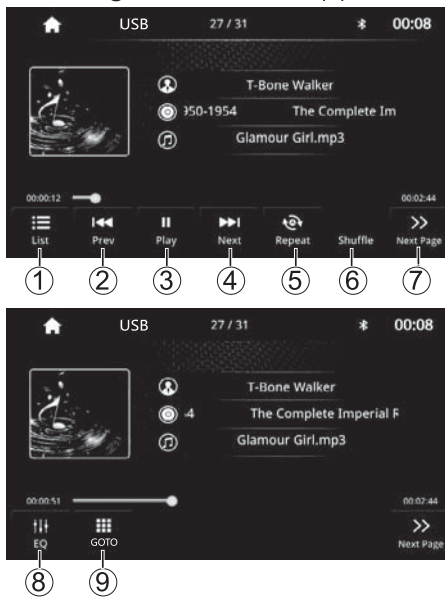



1. USB List Menu
2. Short press: Play previous song/ media.
Long press: Fast reverse.
3. Play/pause current song/media
4. Short press: Play next song/ media.
Long press: Fast forward.
5. Repeat mode
Repeat all - Repeat off - Repeat single
6. Random playback on/off
7. Next page
8. EQ settings
9. Numbers selection playback

File List browsing

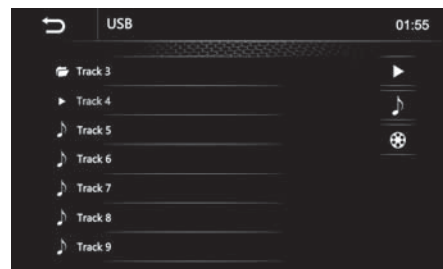
Touch  to browse the folder and file list of the USB device. You can select the multi-media type



-  Return to playing previous file.
-  Select Audio or Music files.
-  Select Movie or Video files.

Video playback



1. Adjust the display brightness.

FUNCTIONS APPLICATION

Settings Operation

Touch “” icon from main menu to enter the settings interface.

Time Setting

Touch “time” to enter time setting. Up/down sliding can set year/month/date/hour/minute/time system.

Time zone: Touch the Time icon to enter the time zone settings. Up/Down sliding to scan different time zones, select the correct one required.

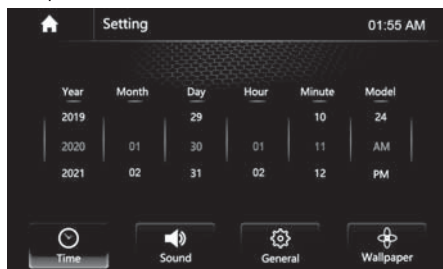

Sound Setting

Touch “Sound Setting” to enter sound setting interface:

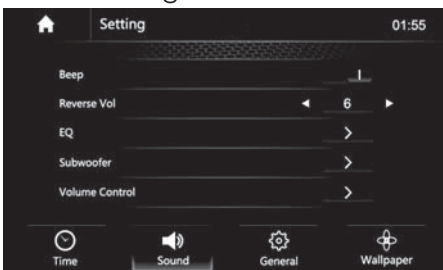

BEEP: Switch the Beep is On /Off.

Reverse Vol: Adjust the Vol 0-20.

Fader / Balance:

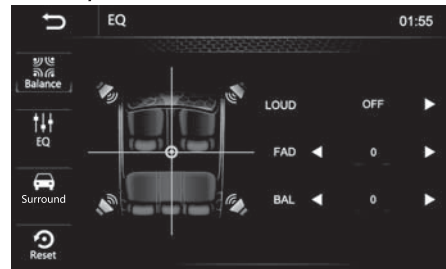



LOUD: Switch the Loud is On /Off.

Fader: Adjust the fader F7-R7.

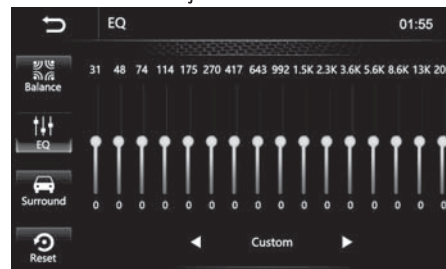
Balance: Adjust the balance L7-R7.



 : Select desired equalizer: Standard>Custom>Classic>Rock>Jazz>Electric>Pop>Soft

In Custom, can adjust the 16-band frequency gain -7 - +7.

Surround:

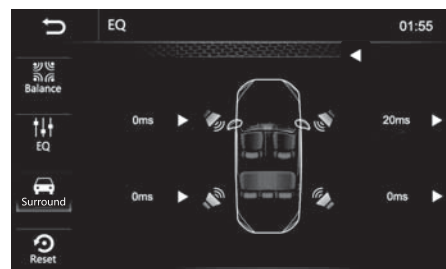

: Reset to default settings.

FUNCTIONS APPLICATION

Subwoofer:

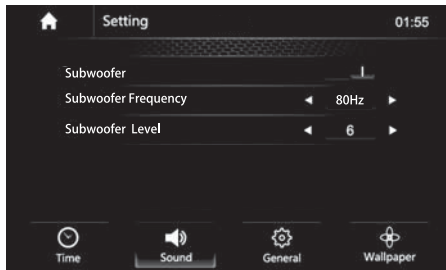

Subwoofer: Switch the Subwoofer is On /Off.

Subwoofer Frequency: Select 50Hz>80Hz>120Hz>160Hz

Subwoofer Level: Adjust the value -12-+12.

Volume Control:

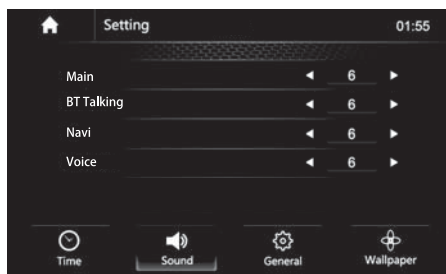

Set the Main / BT Talking /Navi / Voice default volume value.

General Setting

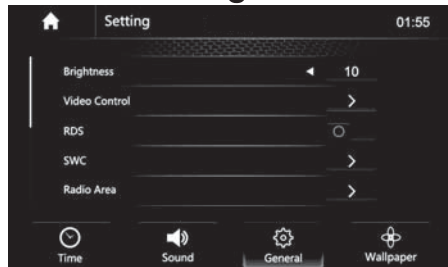

Brightness

◀▶:Adjust the screen's brightness from 1-10.

Video Control:

Touch the icon to set the brightness and contrast of the screen. Touch Reset to default settings.

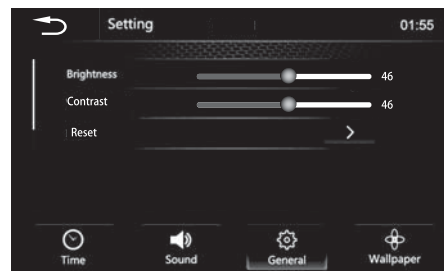

RDS: Switch the RDS is On /Off.

FUNCTIONS APPLICATION

SWC: Touch "SWC" icon to enter the steering wheel control menu, wheel control menu.

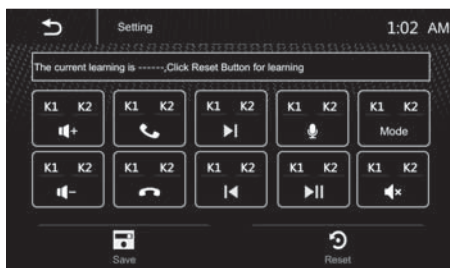

Short time press the key of the car radio SWC screen first and then long time press corresponding button of car steering wheel for learning and setting .

Note: Press the "Reset" before you start the setting.

Radio Area: Choose the required radio region.

America / Europe / Eastern Europe / Janpan / Southeast Asia /Latin America / South America / Asia/ Australia.

Serial/Version: Touch the icon to enter serial number and version number interface,to check the needed information.

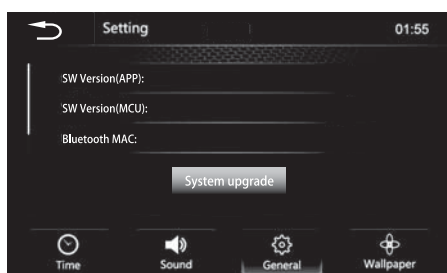

Language: Touch the icon to enter language setting interface, select the required language.

Reset Factory Data

Once selected, the unit will prompt to confirm reset to factory settings. Once confirmed the system will automatically reboot.

MIC Switch: Touch icon to change front or rear external mic.

Note: External Microphone is exclude.

Driver Position:Touch icon to select the driver position is Left or Right.

Note: If you select right driver position, the Apple CarPlay UI will be change to right mode.

Driver Forbidden Watch video: Touch the icon to turn ON/OFF the Driver Forbidden Watch video

Seven Colour Light: Touch the icon to adjust the brightness mode and relevant functions.

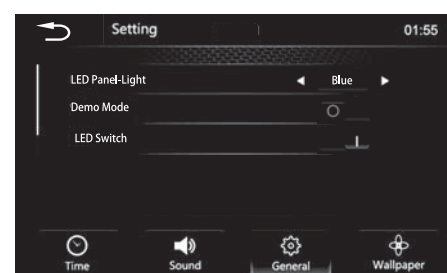

LED Panel-Light: Touch icon to select required LED light color: RED/ YELLOW/GREEN/BLUE/PURPLE /CYAN/WHITE.

FUNCTIONS APPLICATION

Demo Mode: Touch to switch Demo Mode is On or Off. The panel Led will change automatically cycling.

LED Switch: Touch to switch the panel Led is On or Off.

Wallpapers Setting

Choose the required wallpaper, touch "wallpaper setting" icon to enter the setting interface.



AV IN

Insert video input connector to input video's input jack, audio input conencto to input audio's input jack, touch "AV-IN" icon from main menu to enter the AV interface.

Android Auto/Apple CarPlay

Connect Android Phone to the unit to enter the Android Auto interface.

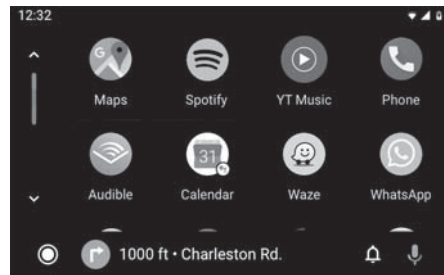

The unit can be used to call, play music, view maps, check traffic information, return to the unit's main interface, listen to Podcasts, read Audiobooks and so on.

Connect iPhone to the unit to enter the Apple CarPlay interface.

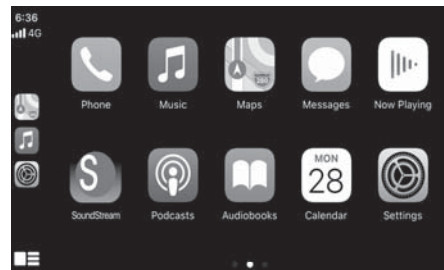

The unit can be used to make calls, play music, view maps, check traffic information, return to the unit's main interface, listen to Podcasts, read Audiobooks and so on.

WIRING CONNECTION

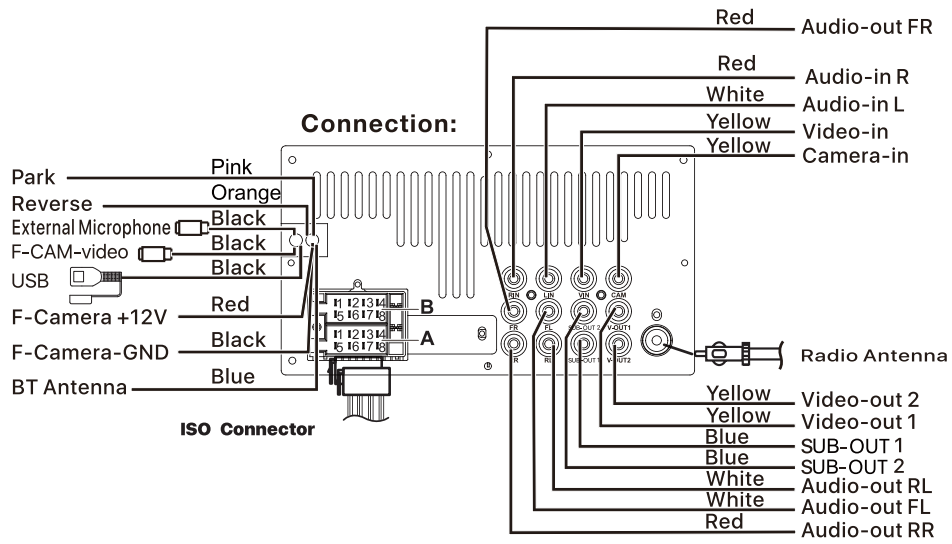

Fuse: Max. 15 Ampere
Voltage: 12V DC; Negative Ground

ISO Connector

A	Color	Fuction
1	Black	SWC-GND
2	Green	SWC-KEY1
3	Blue	Amplifier Control
4	Red	ACC
5	Brown	SWC-KEY2
6	Yellow	BATT
7	Orange	ILL
8	Black	GND

B	Color	Fuction
1	Purple	RR+
2	Gray	FR+
3	White	FL+
4	Green	RL+
5	Purple/Black	RR-
6	Gray/Black	FR-
7	White/Black	FL-
8	Green/Black	RL-

INSTALLATION & ACCESSORIES

1. Put the 2 brackets to the left and right side of the headunit.
2. Use screws to fix the brackets to the unit.

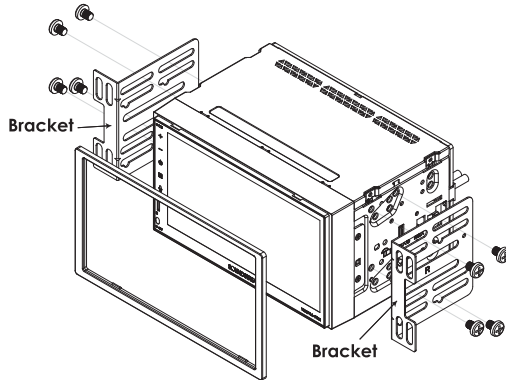







Note:

1. Make sure the ignition is turned off, and disconnect the cable from the vehicle battery's negative (-) terminal. You never want electricity running while you install this 2-DIN car receiver.
2. Before installation, disconnect the wire harness and the antenna.
3. Attach the brackets on the both sides of the car receiver with screws as shown as the figure. Please buy from your dealer according to the drilling of holes size.

4. Consult with your nearest dealer if installation requires the drilling of holes or other modification of the vehicle.
5. Install the car receiver in the dashboard.
6. Connect the wire harness & antenna to the car receiver being carefully not to pinch any wires or cables.
7. Install the plastic outer trim ring onto the car receiver.
8. Reconnect the battery and run through all of the options on this car receiver to ensure that everything is working correctly.
9. Particulars will vary widely depending upon the kind of your car and the car you intend to install it in. Please choose the correct installation method according to the actual situation of your car. Always contact the car dealer or manufacturer if you have any questions.

ACCESSORIES

Package contains the following accessories for installation and operation of the unit.

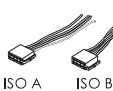
(1) Mounting Brackets	2		(3) Remote	1	
(2) Screws	8		(5) User Manual	1	
(4) Trim Ring	1		(7) Warranty Card	1	
(6) Power Cable	1				

PARKING & SPEAKER CONNECTIONS:

Note: To watch video the parking wire should be connected to brake signal. 2 cables are connected to a Hands-Free device (not included).

Parking wire

Note: The parking wire is connected with brake signal; for safety, the programs can be seen on the monitor after braking the car.

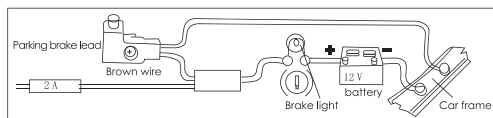

Connecting the reversing line to taillight on the car

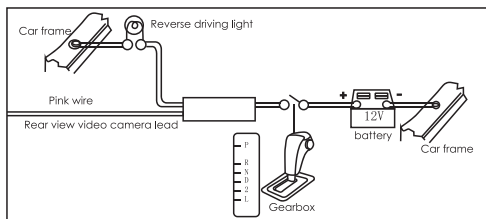

After connecting, when you start up the reverse gear, the unit will receive the picture from car rear view camera.

Speaker Connection

- Only use groundless loudspeakers.
- Use only loudspeakers of minimum 40Watt, using fewer watts may result in damaging your loudspeakers at higher volumes.
- Use 4~8 Ω (Ohm impedance) loudspeakers only; using higher or lesser impedance may damage the unit.
- Loudspeaker cables and/or optional external power amplifiers must always be about 30cm away from the antenna and/or antenna extension parts.
- Do not connect the speaker leads of the power cord to car battery; otherwise, the unit will be seriously damaged.
- Before connecting the speaker leads of the power cord to the speakers, check the speaker wiring in your car.

Connect the speakers according the following diagram, incorrect connections will damage the unit or your loudspeakers

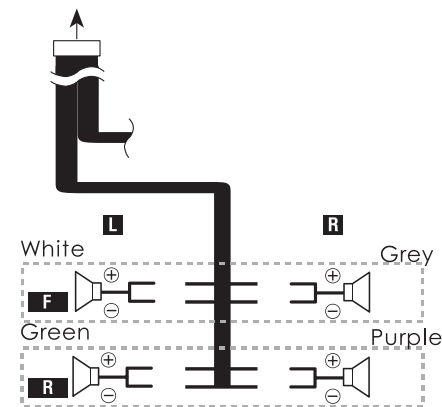

COMMON TROUBLE-SHOOTING

Problem	Cause	Correct action
Cannot power on	Check fuse	Replace fuse
	Other factors causing MPU to malfunction	Press RES button on the panel using a sharp point then power on
After ignition switch off, setting information are lost	Change battery or fuse	Reset information and save
Poor performance of radio station	Weak signal	Move the car to another place, then try again
No image	Other factors causing MPU to malfunction	Press RES button on the panel by penpoint, then, power on
Cannot watch video during driving	Video viewing is not allowed during driving.	Park the car in a safe place, put the car in "P" position, pull up the hand brake, parking brake wire must be grounded.

SPECIFICATION:

General

Power Supply.....	DC10-16V
Grounding System.....	Negative Ground
Current Drain.....	1.5A(Max.)
Speaker Impedance.....	4 ohm per channel
Frequency Response.....	20Hz~20kHz
Operating Temperature.....	-20~+60 °C
Dimensions.....	178mm(W)x129mm(D)x100mm(H)

TFT Display

TFT Screen Size.....	7 inch
Resolution.....	1024x600 Pixels

FM Radio

Frequency Range(USA).....	87.5~107.9MHz
Frequency Range(Europe).....	87.5~108.0MHz
Enable Sensitivity (S/N=30dB).....	≤15dB
SN Ratio.....	≥55dB
Stereo Separation.....	≥30dB

AM Radio

Frequency Range(USA).....	530~1710KHz
Frequency Range(Europe).....	522~1620KHz
Enable Sensitivity (S/N=20dB).....	≤40dB
SN Ratio.....	≥45dB

Line-out / Subwoofer Output

Maximum Output Level (10Kohms load).....	≥4V rms
Subwoofer Output Level.....	≥4V rms

Warning:

This device complies with Part 15 of the FCC Rules. Operation is subject to the following two conditions: (1) this device may not cause harmful interference, and (2) this device must accept any interference received, including interference that may cause undesired operation.

changes or modifications not expressly approved by the party responsible for compliance could void the user's authority to operate the equipment.

NOTE: This equipment has been tested and found to comply with the limits for a Class B digital device, pursuant to Part 15 of the FCC Rules. These limits are designed to provide reasonable protection against harmful interference in a residential installation. This equipment generates, uses and can radiate radio frequency energy and, if not installed and used in accordance with the instructions, may cause harmful interference to radio communications. However, there is no guarantee that interference will not occur in a particular installation.

If this equipment does cause harmful interference to radio or television reception, which can be determined by turning the equipment off and on, the user is encouraged to try to correct the interference by one or more of the following measures:

- Reorient or relocate the receiving antenna.
 - Increase the separation between the equipment and receiver.
 - Connect the equipment into an outlet on a circuit different from that to which the receiver is connected.
 - Consult the dealer or an experienced radio/TV technician for help.
- NOTE: This device and its antenna(s) must not be co-located or operation in conjunction with any other antenna or transmitter

RF Exposure Statement

To maintain compliance with FCC's RF Exposure guidelines, This equipment should be installed and operated with minimum distance of 20cm in the radiator your body. This device and its antenna(s) must not be co-located or operation in conjunction with any other antenna or transmitter