

Shenzhen Topband Co., Ltd

TEST REPORT

SCOPE OF WORK

EMC TESTING–TBAC3111USH-LJK

REPORT NUMBER

231024174GZU-001

ISSUE DATE

11-April-2024

[REVISED DATE]

[-----]

PAGES

30

DOCUMENT CONTROL NUMBER

FCC Part 15.225-f
© 2017 INTERTEK



TEST REPORT

Applicant Name & Address : Shenzhen topband Co.,Ltd
Topband Industrial Park, Liyuan Industrial Zone, Tangtou Country,
Shiyan BAO'An Shenzhen 518108

Manufacturing Site : Huizhou Topband Electrical Technology Co., Ltd.
No. 113 Dongxin Boulevard, Dongxing Area Dongjiang Hi-tech Park,
Zhongkai Hi-tech Zone HUIZHOU, Guangdong 516055

Intertek Report No: 231024174GZU-001
FCC ID: 2ADDW-TBAC3111USH

Test standards

47 CFR PART 15 Subpart C: 2021 section 15.225

Sample Description

Product : AC EV Charger
Model No. : TBAC3111USH-LJK
Electrical Rating : Input: 208-240Vac, 48A, 50/60Hz
Output: 208-240Vac, 48A
Serial No. : Not Labeled
Date Received : 24 October 2023
Date Test Conducted : 20 February 2024-22 February 2024

Prepared and Checked By

Richard Liu

Richard Liu
Engineer

Approved By:

Dean Liu

Dean Liu
Sr. Project Engineer

This report is for the exclusive use of Intertek's Client and is provided pursuant to the agreement between Intertek and its Client. Intertek's responsibility and liability are limited to the terms and conditions of the agreement. Intertek assumes no liability to any party, other than to the Client in accordance with the agreement, for any loss, expense or damage occasioned by the use of this report. Only the Client is authorized to permit copying or distribution of this report and then only in its entirety. Any use of the Intertek name or one of its marks for the sale or advertisement of the tested material, product or service must first be approved in writing by Intertek. The observations and test results in this report are relevant only to the sample tested. This report by itself does not imply that the material, product, or service is or has ever been under an Intertek certification program.

TEST REPORT

CONTENT

TEST REPORT 1

CONTENT 3

1.0 TEST RESULT SUMMARY 4

2.0 GENERAL DESCRIPTION 5

 2.1 PRODUCT DESCRIPTION 5

 2.2 RELATED SUBMITTAL(S) GRANTS 5

 2.3 TEST METHODOLOGY 5

 2.4 TEST FACILITY 5

3.0 SYSTEM TEST CONFIGURATION 6

 3.1 JUSTIFICATION 6

 3.2 EUT EXERCISING SOFTWARE 7

 3.3 SPECIAL ACCESSORIES 7

 3.4 MEASUREMENT UNCERTAINTY 7

 3.5 EQUIPMENT MODIFICATION 8

 3.6 SUPPORT EQUIPMENT LIST AND DESCRIPTION 8

4.0 MEASUREMENT RESULTS 9

 4.1 ANTENNA REQUIREMENT 9

 4.2 OCCUPIED BANDWIDTH 10

 4.3 RADIATED EMISSION 12

 4.4 FREQUENCY STABILITY 22

 4.5 CONDUCTED EMISSION TEST 25

5.0 TEST EQUIPMENT LIST 30

TEST REPORT

1.0 TEST RESULT SUMMARY

| Test Item | Test Requirement | Test Method | Result |
|---|---|----------------------------------|--------|
| Antenna Requirement | FCC PART 15 C Section 15.203 | FCC PART 15 C Section 15.203 | PASS |
| Occupied Bandwidth | FCC PART 15 C section 15.215(c) | ANSI C63.10: Clause 6.9 | PASS |
| Radiated Emission | FCC PART 15 C section 15.225 (a), (b), (c), (d) | ANSI C63.10: Clause 6.4 & 6.5 | PASS |
| Frequency Stability | FCC PART 15 C section 15.225 (e) | ANSI C63.10: Clause 6.8 | PASS |
| Conducted Emissions at Mains Terminals | FCC PART 15 C section 15.207 | ANSI C63.10: Clause 6.2 | PASS |
| <p>Remark: N/A: not applicable. Refer to the relative section for the details. EUT: In this whole report EUT means Equipment Under Test. Tx: In this whole report Tx (or tx) means Transmitter. Rx: In this whole report Rx (or rx) means Receiver. RF: In this whole report RF means Radio Frequency. ANSI C63.10: the detail version is ANSI C63.10:2013 in the whole report</p> | | | |

TEST REPORT

2.0 General Description

2.1 Product Description

| | |
|---------------------|-----------------------|
| Operating Frequency | 13.56 MHz |
| Type of Modulation: | ASK |
| Number of Channels | 1 Channel |
| Channel Separation: | N/A |
| Antenna Type | Integral loop antenna |
| Power Supply: | 240V/60Hz |
| Power cord: | N/A |

2.2 Related Submittal(s) Grants

This is an application for certification of:
DXX(Part 15 Low Power Communication Device Transmitter).

Remaining portions are subject to the following procedures:

1. Receiver portion: exempt from technical requirement of this Part.

2.3 Test Methodology

Both AC mains line-conducted and radiated emission measurements were performed according to the procedures in ANSI C63.10. Radiated emission measurement was performed in semi-anechoic chamber and conducted emission measurement was performed in shield room. For radiated emission measurement, preliminary scans and final tests were performed in the semi-anechoic chamber to determine the worst case modes. All radiated tests were performed at an antenna to EUT distance of 3 meters, unless stated otherwise.

2.4 Test Facility

All tests were performed at:

Intertek Testing Services Shenzhen Ltd. Guangzhou Branch
Room102/104, No 203, KeZhu Road, Science City, GETDD Guangzhou, China

Except Conducted Emissions was performed at:

Room101/301/401/102/202/302/402/502/602/702/802, No. 7-2, Caipin Road, Huangpu District, Guangzhou, Guangdong, China

TEST REPORT

A2LA Certificate Number 0078.10

Intertek Testing Services Shenzhen Ltd. Guangzhou Branch is accredited by A2LA and Listed in FCC website. FCC accredited test labs may perform both Certification testing under Parts 15 and 18 and Declaration of Conformity testing.

3.0 System Test Configuration

3.1 Justification

For emissions testing, the equipment under test (EUT) setup to transmit continuously to simplify the measurement methodology. Care was taken to ensure proper power supply voltages during testing. During testing, AC power line was manipulated to produce worst case emissions. It was powered by AC 240V/60Hz supply.

When below 30MHz, the measurement antenna was positioned with its plane perpendicular to the ground at the specified distance. When perpendicular to the ground plane, the lowest height of the magnetic antenna was 1 m above the ground and was positioned at 3m distance from the EUT. During testing the loop antenna was rotated about its vertical axis for maximum response at each azimuth and also investigated with the loop positioned in the horizontal plane. For each measurement antenna alignment, the EUT shall be rotated through 0° to 360° on a turntable.

When above 30MHz, the antenna height and polarization are varied during the search for maximum signal level. The antenna height is varied from 1 to 4 meters. Radiated emissions are taken at three meters unless the signal level is too low for measurement at that distance. If necessary, a pre-amplifier is used and/or the test is conducted at a closer distance.

All readings are extrapolated back to the equivalent three meter reading using inverse scaling with distance. The spurious emissions more than 20 dB below the permissible value are not reported.

For an intentional radiator, the spectrum shall be investigated from the lowest radio frequency signal generated in the device, without going below 9 kHz, up to at least the frequency shown in the following table:

Frequency range of radiated emission measurements

| Lowest frequency generated in the device | Upper frequency range of measurement |
|--|---|
| 9 kHz to below 10 GHz | 10th harmonic of highest fundamental frequency or to 40 GHz, whichever is lower |
| At or above 10 GHz to below 30 GHz | 5th harmonic of highest fundamental frequency or to 100 GHz, whichever is lower |
| At or above 30 GHz | 5th harmonic of highest fundamental frequency or to 200 GHz, whichever is lower, unless otherwise specified |

TEST REPORT

Number of fundamental frequencies to be tested in EUT transmit band

| Frequency range in which device operates | Number of frequencies | Location in frequency range of operation |
|--|-----------------------|---|
| 1 MHz or less | 1 | Middle |
| 1 MHz to 10 MHz | 2 | 1 near top and 1 near bottom |
| More than 10 MHz | 3 | 1 near top, 1 near middle and 1 near bottom |

3.2 EUT Exercising Software

The NFC starts automatically.

3.3 Special Accessories

No special accessories used.

3.4 Measurement Uncertainty

| No. | Item | Measurement Uncertainty |
|-----|--|-------------------------|
| 1 | 20 dB Bandwidth | 2.3% |
| 2 | Carrier Frequencies Separated | 2.3% |
| 3 | Radiated Emissions | 4.24 dB (9KHz-30MHz) |
| | | 4.7 dB (25 MHz-1 GHz) |
| | | 4.8 dB (1 GHz-18 GHz) |
| | | 5.21dB (18GZH-26GHz) |
| 4 | Conducted Emissions at Mains Terminals | 2.58dB |
| 5 | Temperature | 0.5 °C |
| 6 | Humidity | 0.4 % |
| 7 | Time | 1.2% |

The measurement uncertainty describes the overall uncertainty of the given measured value during the operation of the EUT.

Measurement uncertainty is calculated in accordance with ETSI TR 100 028-2001.

The measurement uncertainty is given with a confidence of 95%, k=2.

When determining of the test conclusion, the Measurement Uncertainty of test has been considered.

TEST REPORT

Uncertainty and Compliance – Unless the standard specifically states that measured values are to be extended by the measurement uncertainty in determining compliance, all compliance determinations are based on the actual measured value

3.5 Equipment Modification

Any modifications installed previous to testing by Shenzhen Topband Co.,Ltd will be incorporated in each production model sold / leased in the United States.

No modifications were installed by Intertek Testing Services Shenzhen Ltd. Guangzhou Branch.

3.6 Support Equipment List and Description

This product was tested with corresponding support equipment as below:

Support Equipment

| Description | Manufacturer | Model No. | SN/Version | Supplied by |
|-----------------|--------------|-----------|-----------------|-------------|
| Airbreak switch | CHNT | DZ158-125 | SN:100025307896 | Intertek |

Cable

| Description | Model No. | Connector type | Cable length/type | Supplied by |
|---------------|-----------|----------------|-------------------|-------------|
| Antenna cable | RF-01 | SMA | 0.2 m(shielded) | Intertek |
| power cord | -- | -- | 1m(unshielded) | Intertek |

Load

| Description | Model No. | Electrical Rating | Quantity | Supplied by |
|-------------|-------------------|-------------------|----------|-------------|
| Load box | VILVA-ACDC-20KW-R | 20KW Max | 1 | Intertek |

TEST REPORT

4.0 Measurement Results

4.1 Antenna Requirement

Standard requirement:

15.203 requirement:

For intentional device. According to 15.203 an intentional radiator shall be designed to Ensure that no antenna other than that furnished by the responsible party shall be used with the device.

EUT Antenna

The antenna is an integral loop antenna and no consideration of replacement.



Antenna dimension design

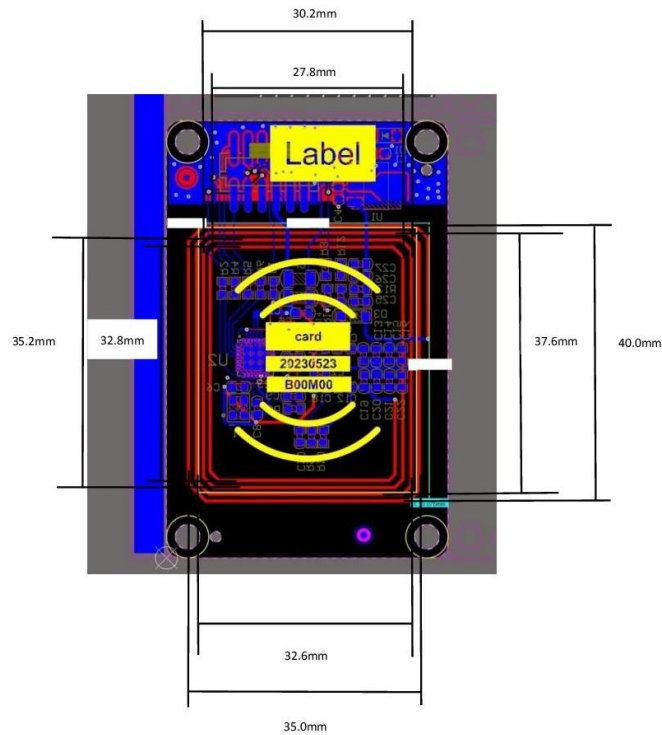

TEST REPORT

4.2 Occupied Bandwidth

- Test Requirement: FCC PART 15 C section 15.215(c)
(c) Intentional radiators operating under the alternative provisions to the general emission limits, as contained in §§ 15.217 through 15.257 and in subpart E of this part, must be designed to ensure that the 20 dB bandwidth of the emission, or whatever bandwidth may otherwise be specified in the specific rule section under which the equipment operates, is contained within the frequency band designated in the rule section under which the equipment is operated
- Test Method: ANSI C63.10: Clause 6.9
- Test Status: Pre-Scan has been conducted to determine the worst-case mode.
- Test Configuration:

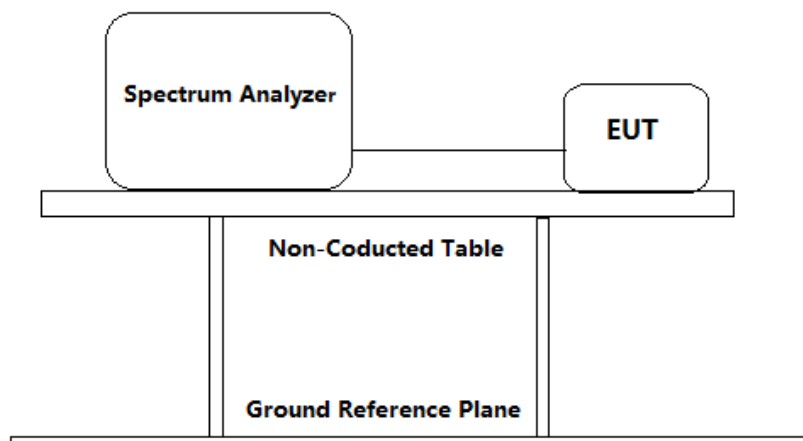

- Test Procedure:
- The transmitter was operated at its maximum carrier power measured under normal test conditions.
- The instrument center frequency was set to the nominal EUT channel center frequency. The frequency span for the spectrum analyzer was between 1.5 times and 5.0 times the OBW(20 dB Bandwidth).
 - The nominal IF filter bandwidth (3 dB RBW) was in the range of 1% to 5% of the OBW, and VBW was approximately three times the RBW.
 - Set the reference level of the instrument as required, keeping the signal from exceeding the maximum input mixer level for linear operation. In general, the peak of the spectral envelope was more than $[10 \log (OBW/RBW)]$ below the reference level.
 - Step a) through step c) might require iteration to adjust within the specified range.
 - The dynamic range of the instrument at the selected RBW was more than 10 dB below the target “-20 dB down” requirement; that is, if the requirement calls for measuring the -20 dB OBW, the instrument noise floor at the selected RBW was at least 30 dB below the reference value.

TEST REPORT

- f) Peak detection and max hold mode (until the trace stabilizes) was used.
- g) Used the 20dB bandwidth function of the instrument and reported the measured bandwidth.
- h) The occupied bandwidth was reported by providing plot(s) of the measuring instrument display; the plot axes and the scale units per division was clearly labeled. Tabular data was reported in addition to the plot(s).

Used Test Equipment List

Spectrum Analyzer. Refer to Clause 5 Test Equipment List for details.

20 dB bandwidth:

| Frequency (MHz) | 20 dB bandwidth (kHz) | lower frequency (MHz) | upper frequency (MHz) | Assigned Band (MHz) | Result |
|-----------------|-----------------------|-----------------------|-----------------------|---------------------|--------|
| 13.56 | 33.1 | 13.5435 | 13.5766 | 13.110-14.010 | Pass |

Result plot as follows:

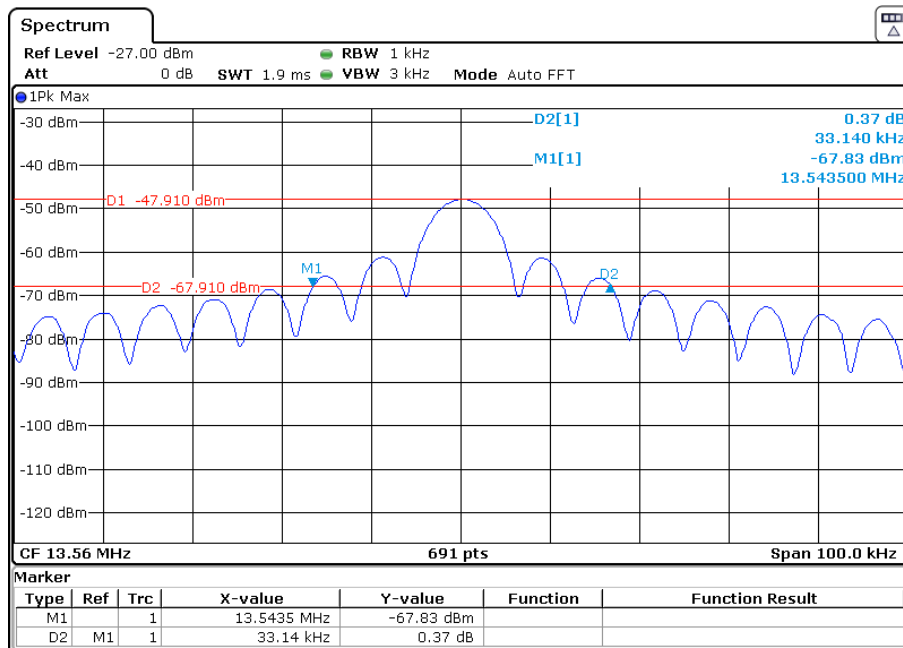

Test result: The unit does meet the FCC requirements.

TEST REPORT

4.3 Radiated Emission

Test Requirement:

FCC PART 15 C section 15.225 (a), (b), (c), (d)

The field strength of emissions from intentional radiators operated under this Section shall not exceed the following:

15.225(a): The field strength of any emissions within the band 13.553-13.567 MHz shall not exceed 15,848 microvolts/meter at 30 meters.i.e. 124.0dBμV/m @ 3 m.

15.225(b): Within the bands 13.410-13.553 MHz and 13.567-13.710 MHz, the field strength of any emissions shall not exceed 334 microvolts/meter at 30 meters. i.e. 90.5dBμV/m @ 3 m.

15.225(c): Within the bands 13.110-13.410 MHz and 13.710-14.010 MHz the field strength of any emissions shall not exceed 106 microvolts/meter at 30 meters. i.e. 80.5dBμV/m @ 3 m.

15.225(d) :The field strength of any emissions appearing outside of the 13.110-14.010 MHz band shall not exceed the general radiated emission limits in § 15.209.

Convert the units of microvolts/meter to dBμV/m:

$$20 * \log \text{Value}(\text{microvolts/meter}) = \text{Value}(\text{dB}\mu\text{V/m})$$

convert the field strength limits at 30m and 300m to 3m:

$$\text{Value}(\text{dB}\mu\text{V/m})@30\text{m}+40 = \text{Value}(\text{dB}\mu\text{V/m})@3\text{m}$$

$$\text{Value}(\text{dB}\mu\text{V/m})@300\text{m}+80 = \text{Value}(\text{dB}\mu\text{V/m})@3\text{m}$$

§ 15.209 Limit:

| Frequency (MHz) | Field Strength (dBμV/m @ 3m) |
|-----------------|------------------------------|
| 1.705-30.0 | 69.5 |
| 30-88 | 40 |
| 88-216 | 43.5 |
| 216-960 | 46 |
| Above 960 | 54 |

Test Method:

ANSI C63.10: Clause 6.4 and 6.5.

Test Status:

Pre-Scan has been conducted to determine the worst-case mode from all possible configuration.

Test site:

Measurement Distance: 3m (Semi-Anechoic Chamber)

Detector:

Quasi-Peak detector:

RBW=200 Hz for 9 kHz to 150 kHz

RBW=9 kHz for 150 kHz to 30 MHz

RBW=120 kHz for 30 MHz to 1GHz

Sweep = auto

Trace = max hold

Field Strength Calculation:

The field strength is calculated by adding the reading on the Spectrum Analyzer to the factors associated with preamplifiers (if

TEST REPORT

any), antennas, cables, pulse desensitization and average factors (when specified limit is in average and measurements are made with peak detectors). A sample calculation is included below:

$$FS = RA + AF + CF - AG + PD + AV$$

$$FS = RA + \text{Correct Factor} + AV$$

FS = Field Strength in dBμV/m

RA = Receiver Amplitude (including preamplifier) in dBμV

AF = Antenna Factor in dB

CF = Cable Attenuation Factor in dB

AG = Amplifier Gain in dB

PD = Pulse Desensitization in dB

AV = Average Factor in -dB

Correct Factor = AF + CF - AG + PD

Where:

In the radiated emission table which follows, the reading shown on the data table may reflect the preamplifier gain. An example of the calculations, where the reading does not reflect the preamplifier gain, follows:

$$FS = RA + AF + CF - AG + PD + AV$$

Assume a receiver reading of 62.0 dBμV is obtained. The antenna factor of 7.4 dB and cable factor of 1.6 dB is added. The amplifier gain of 29 dB is subtracted. The pulse desensitization factor of the spectrum analyzer was 0 dB, and the resultant average factor was -10 dB. The net field strength for comparison to the appropriate emission limit is 32 dBμV/m.

$$RA = 62.0 \text{ dB}\mu\text{V}$$

$$AF = 7.4 \text{ dB}$$

$$CF = 1.6 \text{ dB}$$

$$AG = 29.0 \text{ dB}$$

$$PD = 0 \text{ dB}$$

$$AV = -10 \text{ dB}$$

$$\text{Correct Factor} = 7.4 + 1.6 - 29.0 + 0 = -20 \text{ dB}$$

$$FS = 62 + (-20) + (-10) = 32 \text{ dB}\mu\text{V/m}$$

Section 15.205 Restricted bands of operation.

| MHz | MHz | MHz | GHz |
|-----|-----|-----|-----|
|-----|-----|-----|-----|

TEST REPORT

| | | | |
|---------------------|---------------------|-----------------|---------------|
| 0.090 - 0.110 | 16.42 - 16.423 | 399.9 - 410 | 4.5 - 5.15 |
| 0.495 - 0.505 | 16.69475 - 16.69525 | 608 - 614 | 5.35 - 5.46 |
| 2.1735 - 2.1905 | 16.80425 - 16.80475 | 960 - 1240 | 7.25 - 7.75 |
| 4.125 - 4.128 | 25.5 - 25.67 | 1300 - 1427 | 8.025 - 8.5 |
| 4.17725 - 4.17775 | 37.5 - 38.25 | 1435 - 1626.5 | 9.0 - 9.2 |
| 4.20725 - 4.20775 | 73 - 74.6 | 1645.5 - 1646.5 | 9.3 - 9.5 |
| 6.215 - 6.218 | 74.8 - 75.2 | 1660 - 1710 | 10.6 - 12.7 |
| 6.26775 - 6.26825 | 108 - 121.94 | 1718.8 - 1722.2 | 13.25 - 13.4 |
| 6.31175 - 6.31225 | 123 - 138 | 2200 - 2300 | 14.47 - 14.5 |
| 8.291 - 8.294 | 149.9 - 150.05 | 2310 - 2390 | 15.35 - 16.2 |
| 8.362 - 8.366 | 156.52475 - | 2483.5 - 2500 | 17.7 - 21.4 |
| 8.37625 - 8.38675 | 156.52525 | 2655 - 2900 | 22.01 - 23.12 |
| 8.41425 - 8.41475 | 156.7 - 156.9 | 3260 - 3267 | 23.6 - 24.0 |
| 12.29 - 12.293 | 162.0125 - 167.17 | 3332 - 3339 | 31.2 - 31.8 |
| 12.51975 - 12.52025 | 167.72 - 173.2 | 3345.8 - 3358 | 36.43 - 36.5 |
| 12.57675 - 12.57725 | 240 - 285 | 3600 - 4400 | |
| 13.36 - 13.41 | 322 - 335.4 | | |

The field strength of emissions appearing within these frequency bands shall not exceed the limits shown in 15.209.

Test Configuration:

- 1) 9 kHz to 30 MHz emissions:

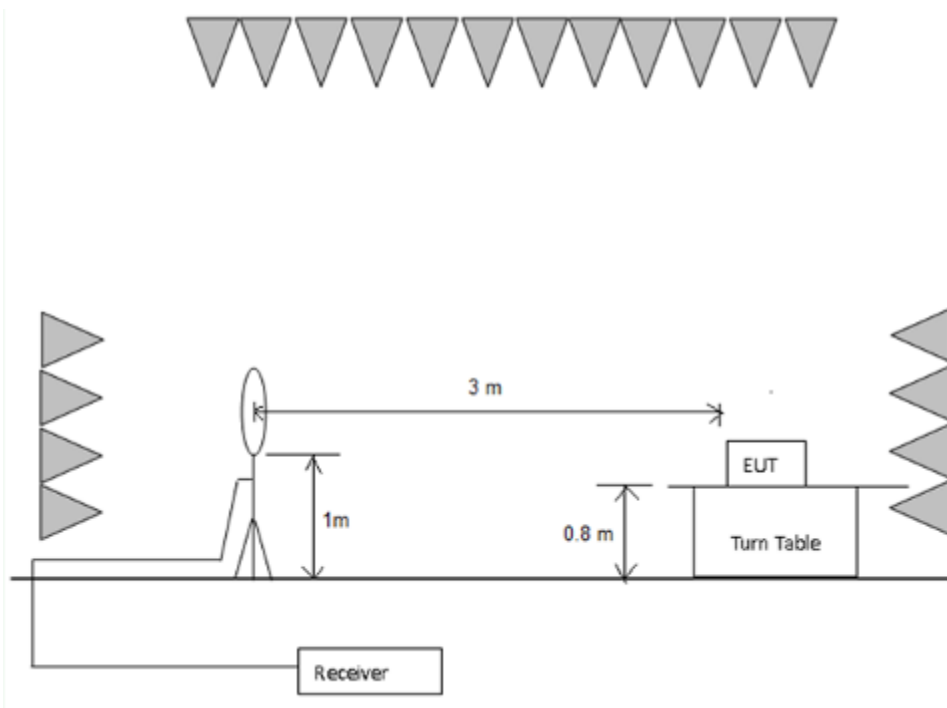

- 2) 30 MHz to 1 GHz emissions:

TEST REPORT

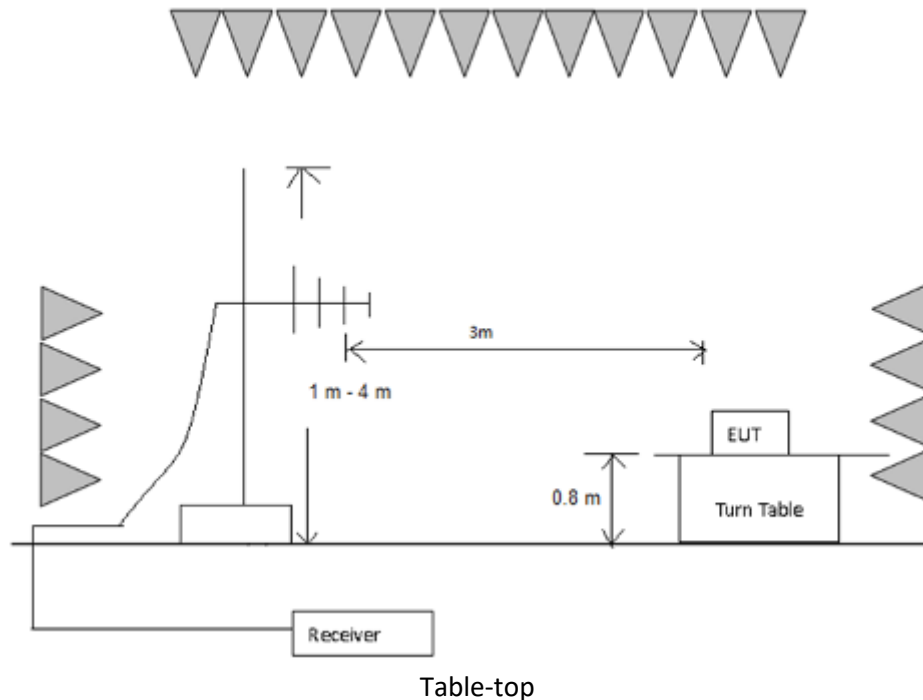

Test Procedure:

1) 9 kHz to 30 MHz emissions:

For testing performed with the loop antenna, the lowest height of the magnetic antenna shall be 1 m above the ground and shall be positioned at the specified distance from the EUT. During testing the loop was rotated about its vertical axis for maximum response at each azimuth and also investigated with the loop positioned in the horizontal plane.

2) 30 MHz to 1 GHz emissions:

For testing performed with the TRILOG Super Broadband test Antenna. The measurement is performed with the EUT rotated 360°, the antenna height scanned between 1m and 4m, and the antenna rotated to repeat the measurement for both the horizontal and vertical antenna polarizations.

- 3) The receiver was scanned from 9 kHz to 200 MHz. When an emission was found, the table was rotated to produce the maximum signal strength. An initial pre-scan was performed for in peak detection mode using the receiver. The EUT was measured for both the Horizontal and Vertical polarities and performed a pre-test three orthogonal planes. For intentional radiators, measurements of the variation of the input power or the radiated signal level of the fundamental frequency component of the emission, as appropriate, shall be performed with the supply voltage varied between 85% and 115% of the nominal rated supply voltage. The worst case emissions were reported.

Used Test Equipment List:

3m Semi-Anechoic Chamber, EMI Test Receiver (9 kHz~7 GHz), Signal and Spectrum Analyzer (10 Hz~40 GHz), Loop antenna (9 kHz-30 MHz). TRILOG Super Broadband test Antenna(30 MHz-3 GHz) (RX), Double-Ridged Waveguide Horn Antenna (800 MHz-18 GHz)(RX) and High Frequency Antenna & preamplifier(18 GHz~26.5 GHz) (RX). Refer to Clause 5 Test Equipment List for details.

TEST REPORT

Radiated Emissions (Below 30 MHz)

Operation Mode: Continuously transmitting

Horizontal

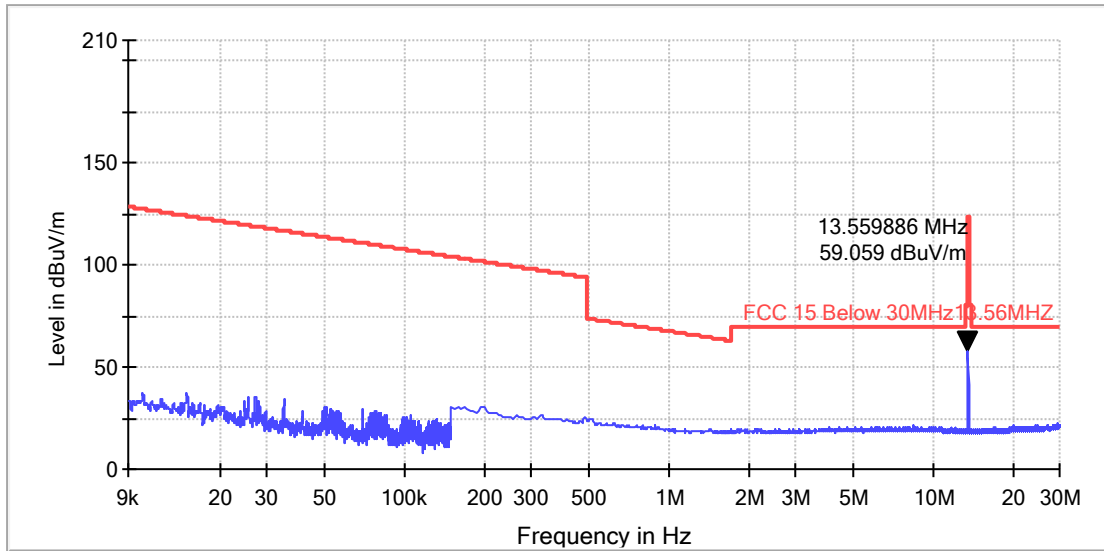

All emission levels are more than 6 dB below the limit.

Vertical

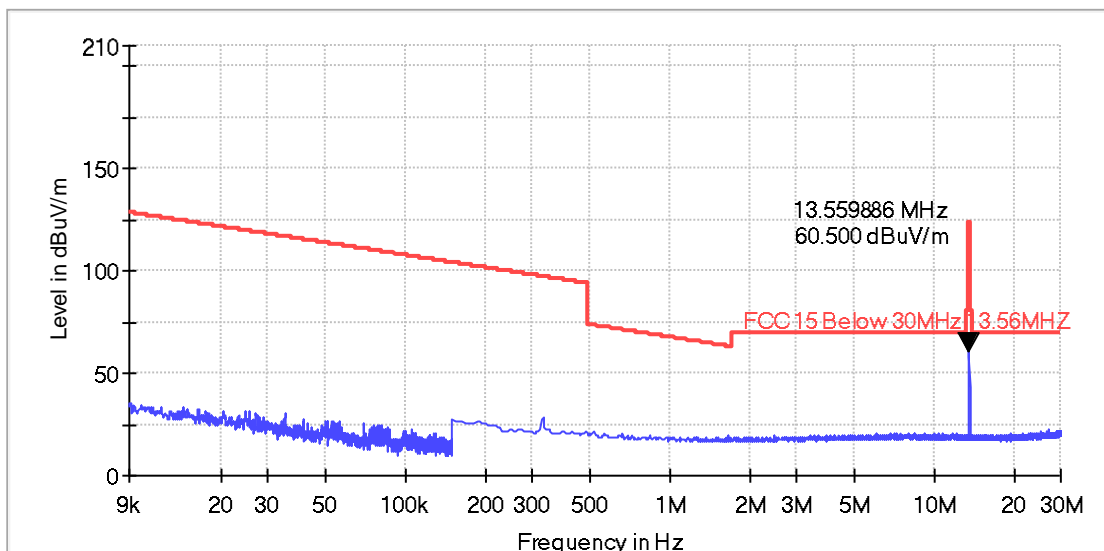

All emission levels are more than 6 dB below the limit.

TEST REPORT

Horizontal

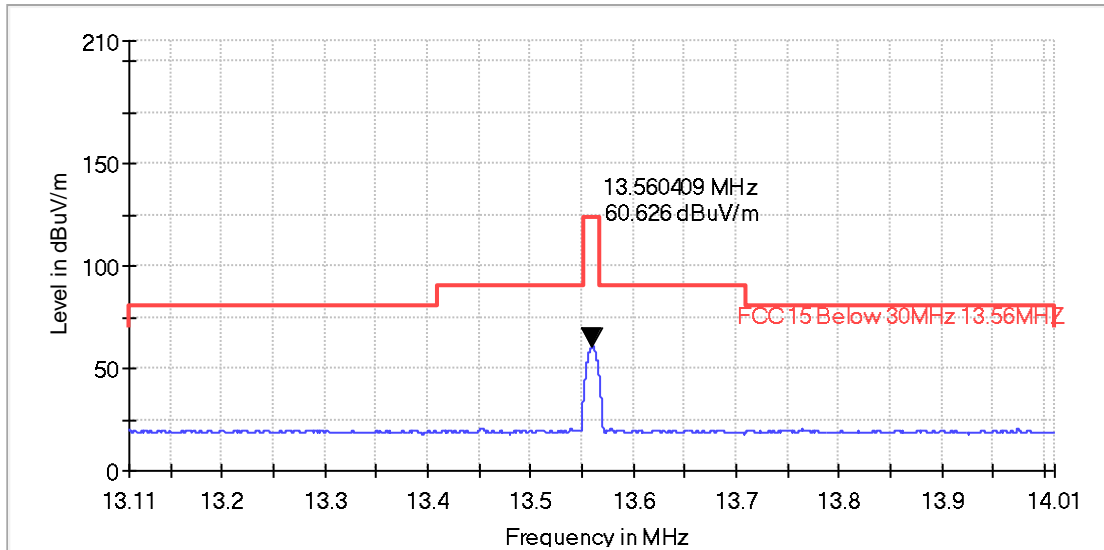

| Frequency (MHz) | Receiver Reading Level (dB μ V) | Correction factors (dB/m) | Emission Level (dB μ V/m) | Limit (dB μ V/m) | Margin (dB) |
|-----------------|-------------------------------------|---------------------------|-------------------------------|----------------------|-------------|
| 13.56 | 39.6 | 21.0 | 60.6 | 124.0 | 63.4 |

Vertical

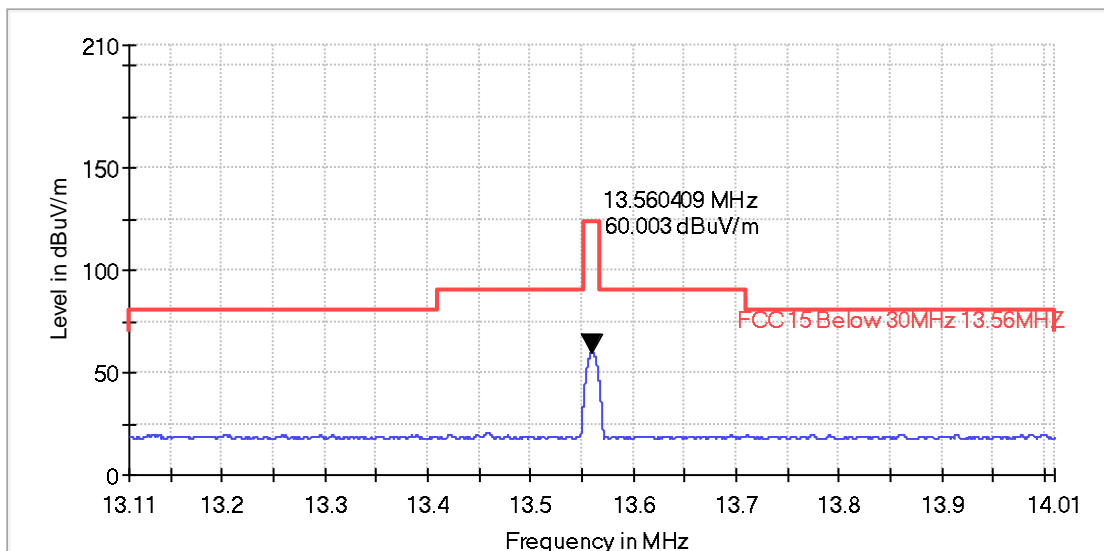

TEST REPORT

| Frequency (MHz) | Receiver Reading Level (dB μ V) | Correction factors (dB/m) | Emission Level (dB μ V/m) | Limit (dB μ V/m) | Margin (dB) |
|-----------------|-------------------------------------|---------------------------|-------------------------------|----------------------|-------------|
| 13.56 | 39 | 21.0 | 60.0 | 124.0 | 64.0 |

The emission limits shown above are based on measurements employing a CISPR quasi-peak detector except for the frequency bands 9-90 kHz, 110-490 kHz and above 1000 MHz. Radiated emission limits in these three bands are based on measurements employing an average detector.

Remark:

1. Corr. (dB) = Antenna Factor (dB) + Cable Loss (dB)
2. Level (dB μ V/m) = Corr. (dB) + Read Level (dB μ V)
3. Margin (dB) = Limit (dB μ V/m) – Level (dB μ V/m)
4. Only record the date closed to limit
5. The emission is worst case on Horizontal
6. When Peak emission level was below AV or QP limit, the AV and QP emission level was not recorded.

Radiated Emissions (Above 30MHz)

Operation Mode: Continuously transmitting

Horizontal

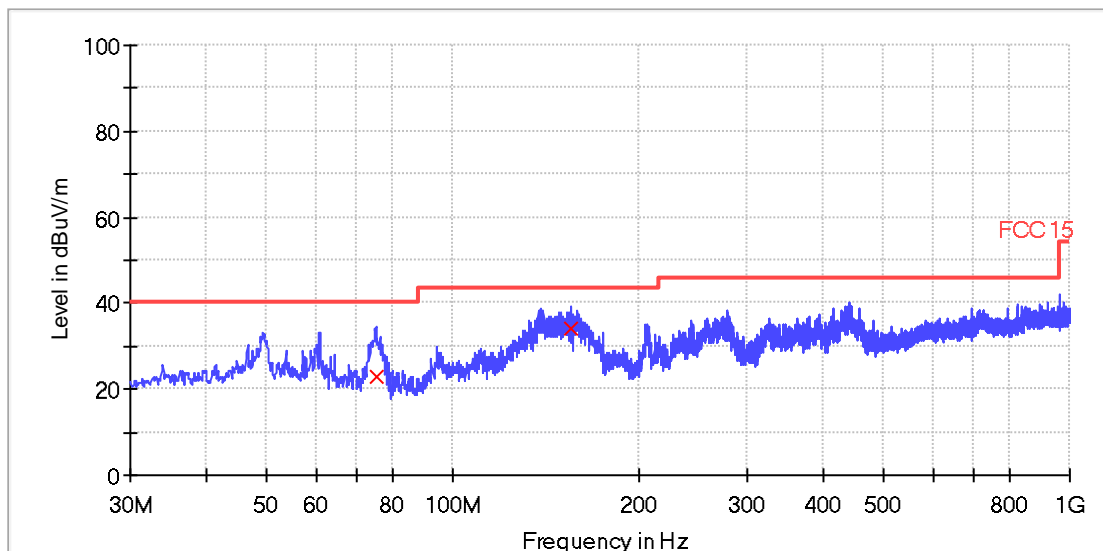

QP

| Frequency (MHz) | Quasi Peak (dBuV/m) | Bandwidth (kHz) | Pol | Corr. (dB) | Margin - QPK (dB) | Limit - QPK (dBuV/m) |
|-----------------|---------------------|-----------------|-----|------------|-------------------|----------------------|
| 75.000000 | 23.1 | 120.000 | H | 15.1 | 17.0 | 40.0 |
| 155.440000 | 34.1 | 120.000 | H | 15.5 | 9.4 | 43.5 |

TEST REPORT

Remark:

1. Corr. (dB) = Antenna Factor (dB) + Cable Loss (dB)
2. Quasi Peak (dB μ V/m) = Corr. (dB) + Read Level (dB μ V)
3. Margin (dB) = Limit QPK (dB μ V/m) – Quasi Peak (dB μ V/m)

Vertical

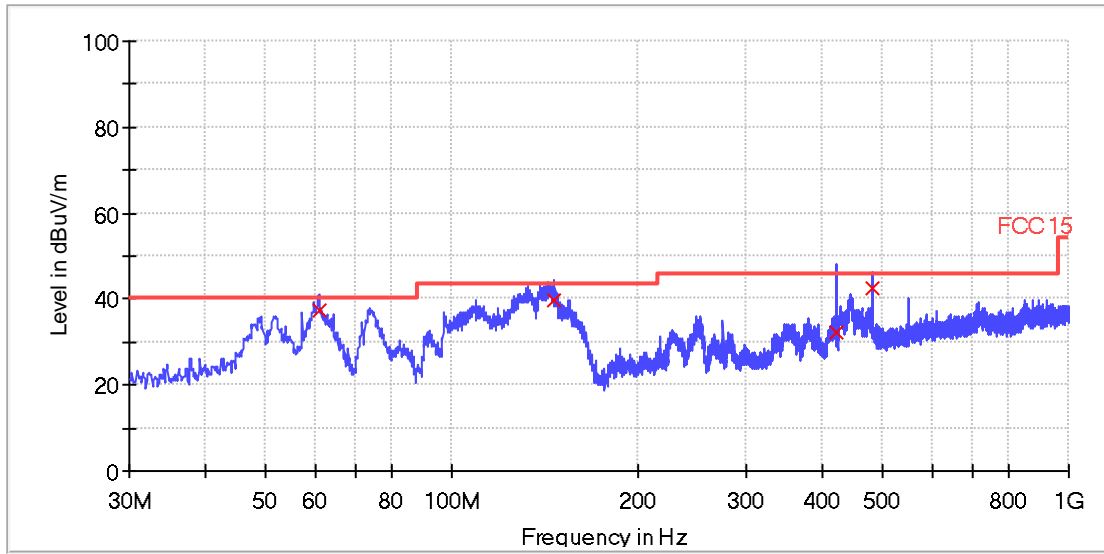

QP

| Frequency (MHz) | Quasi Peak (dBuV/m) | Bandwidth (kHz) | Pol | Corr. (dB) | Margin - QPK (dB) | Limit - QPK (dBuV/m) |
|-----------------|---------------------|-----------------|-----|------------|-------------------|----------------------|
| 60.840000 | 37.4 | 120.000 | V | 19.3 | 2.6 | 40.0 |
| 146.400000 | 39.5 | 120.000 | V | 15.2 | 4.0 | 43.5 |
| 420.320000 | 32.1 | 120.000 | V | 23.9 | 13.9 | 46.0 |
| 481.720000 | 42.3 | 120.000 | V | 25.1 | 3.7 | 46.0 |

Remark:

1. Corr. (dB) = Antenna Factor (dB) + Cable Loss (dB)
2. Quasi Peak (dB μ V/m) = Corr. (dB) + Read Level (dB μ V)
3. Margin (dB) = Limit QPK (dB μ V/m) – Quasi Peak (dB μ V/m)

TEST REPORT

Test in NFC, WIFI, Bluetooth, continuous transmission status

9 kHz~30 MHz Field Strength of Unwanted Emissions. Quasi-Peak Measurement

The measurements with active loop antenna were greater than 20dB below the limit, so the test data were not recorded in the test report.

30 MHz~1 GHz Spurious Emissions. Quasi-Peak Measurement

Horizontal

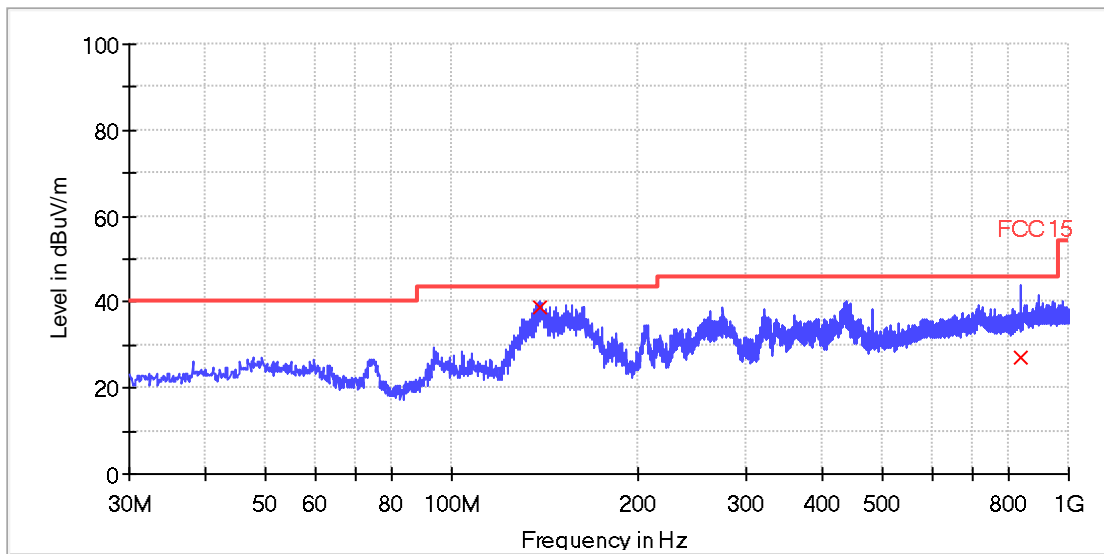

QP

| Frequency (MHz) | Quasi Peak (dBuV/m) | Bandwidth (kHz) | Pol | Corr. (dB) | Margin - QPK (dB) | Limit - QPK (dBuV/m) |
|-----------------|---------------------|-----------------|-----|------------|-------------------|----------------------|
| 138.440000 | 38.7 | 120.000 | H | 15.2 | 4.8 | 43.5 |
| 833.440000 | 27.0 | 120.000 | H | 30.3 | 19.0 | 46.0 |

Remark:

1. Corr. (dB) = Antenna Factor (dB) + Cable Loss (dB)
2. Quasi Peak (dBμV/m) = Corr. (dB) + Read Level (dBμV)
3. Margin (dB) = Limit QPK (dBμV/m) – Quasi Peak (dBμV/m)

TEST REPORT

Vertical

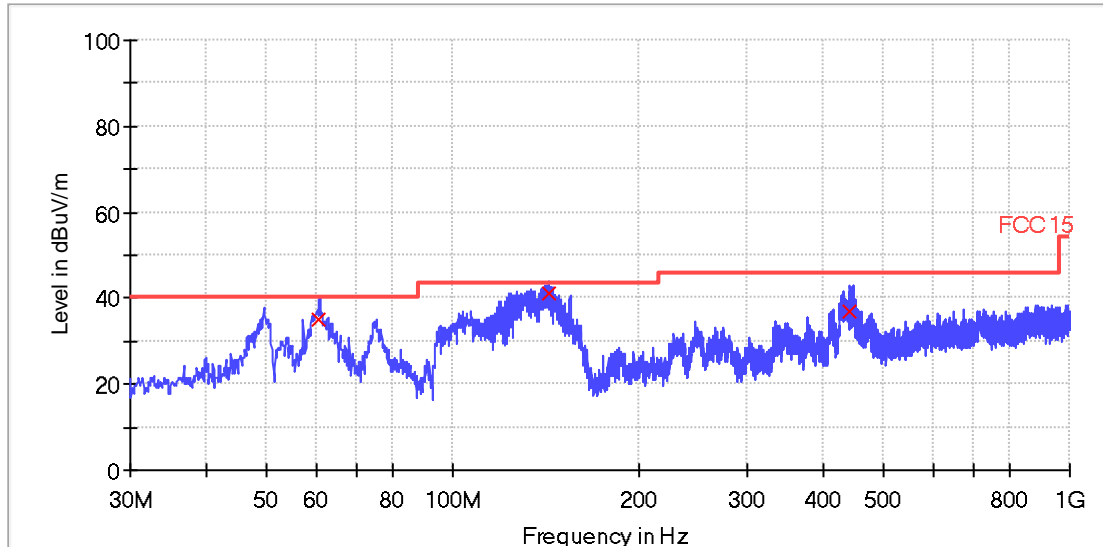

QP

| Frequency (MHz) | Quasi Peak (dBuV/m) | Bandwidth (kHz) | Pol | Corr. (dB) | Margin - QPK (dB) | Limit - QPK (dBuV/m) |
|-----------------|---------------------|-----------------|-----|------------|-------------------|----------------------|
| 60.760000 | 35.2 | 120.000 | V | 19.4 | 4.8 | 40.0 |
| 143.120000 | 41.2 | 120.000 | V | 15.1 | 2.3 | 43.5 |
| 441.000000 | 37.1 | 120.000 | V | 24.2 | 8.9 | 46.0 |

Remark:

1. Corr. (dB) = Antenna Factor (dB) + Cable Loss (dB)
2. Quasi Peak (dB μ V/m) = Corr. (dB) + Read Level (dB μ V)
3. Margin (dB) = Limit QPK (dB μ V/m) – Quasi Peak (dB μ V/m)

1GHz-13GHz Radiated Emissions

PK Measurement:

| Frequency (MHz) | PK Reading Level (dBuV) | Correction factors (dB) | PK Emission Level (dB μ V/m) | PK Limit (dB μ V/m) | Antenna polarization |
|-----------------|-------------------------|-------------------------|----------------------------------|-------------------------|----------------------|
| 3998.5 | 43.2 | -2.8 | 40.4 | 74 | V |
| 7735.0 | 42.9 | 3.3 | 46.2 | 74 | V |
| 2150.5 | 46.7 | -9.0 | 37.7 | 74 | H |
| 8060.5 | 42.3 | 4.0 | 46.3 | 74 | H |

AV Measurement:

| Frequency (MHz) | PK Reading Level (dBuV) | Correction factors (dB) | PK Emission Level (dB μ V/m) | PK Limit (dB μ V/m) | Antenna polarization |
|-----------------|-------------------------|-------------------------|----------------------------------|-------------------------|----------------------|
| 3998.5 | - | -2.8 | - | 54 | V |

TEST REPORT

| | | | | | |
|--------|---|------|---|----|---|
| 7735.0 | - | 3.3 | - | 54 | V |
| 2150.5 | - | -9.0 | - | 54 | H |
| 8060.5 | - | 4.0 | - | 54 | H |

Remark: When Peak emission level was below AV limit, the AV emission level did not be recorded.

4.4 Frequency Stability

Test Requirement: FCC Part 15 C section 15.225 (e)
(e) The frequency tolerance of the carrier signal shall be maintained within $\pm 0.01\%$ of the operating frequency over a temperature variation of -20 degrees to + 50 degrees C at normal supply voltage, and for a variation in the primary supply voltage from 85% to 115% of the rated supply voltage at a temperature of 20 degrees C. For battery operated equipment, the equipment tests shall be performed using a new battery.

Test Method: ANSI C63.10: Clause 6.8

Test Procedure:

- (1) Supply the EUT with a new battery. Turn the EUT OFF and place it inside the environmental temperature chamber.
- (2) Set the temperature control on the chamber to +50 degrees C and allow the oscillator heater and the chamber temperature to stabilize.
- (3) While maintaining a constant temperature inside the environmental chamber, turn the EUT ON and record the operating frequency at startup, and at 2 minutes, 5 minutes, and 10 minutes after the EUT is energized. Four measurements in total are made.
- (4) Switch OFF the EUT. Lower the chamber temperature by not more than 10 °C, and allow the temperature inside the chamber to stabilize. Repeat step 3) through step 4) down to the lowest specified temperature.
- (5) At a temperature of 20°C, record the frequency at 85% and 115% of the nominal supply voltage.

Used Test Equipment List:

Signal and Spectrum Analyzer, Programmable Temperature & Humidity Test Chamber, Regulated DC Power supply. Refer to Clause 5 Test Equipment List for details.

The frequency is 13.56MHz, under unnormal conditions, it should be within $\pm 0.01\%$: 13.558644 - 13.561356MHz

Temperature: 50°C:

| time | Measured Frequency (MHz) | Result |
|-----------|--------------------------|--------|
| 0 minutes | 13.560053 | Pass |

TEST REPORT

| | | |
|------------|-----------|------|
| 2 minutes | 13.560053 | Pass |
| 5 minutes | 13.560053 | Pass |
| 10 minutes | 13.560052 | Pass |

Temperature: 40°C:

| time | Measured Frequency (MHz) | Result |
|------------|--------------------------|--------|
| 0 minutes | 13.560052 | Pass |
| 2 minutes | 13.560051 | Pass |
| 5 minutes | 13.560052 | Pass |
| 10 minutes | 13.560051 | Pass |

Temperature: 30°C:

| time | Measured Frequency (MHz) | Result |
|------------|--------------------------|--------|
| 0 minutes | 13.560052 | Pass |
| 2 minutes | 13.560052 | Pass |
| 5 minutes | 13.560051 | Pass |
| 10 minutes | 13.560051 | Pass |

Temperature: 20°C:

| time | Measured Frequency (MHz) | Result |
|------------|--------------------------|--------|
| 0 minutes | 13.560051 | Pass |
| 2 minutes | 13.560051 | Pass |
| 5 minutes | 13.560051 | Pass |
| 10 minutes | 13.560050 | Pass |

Temperature: 10°C:

| time | Measured Frequency (MHz) | Result |
|------------|--------------------------|--------|
| 0 minutes | 13.560050 | Pass |
| 2 minutes | 13.560051 | Pass |
| 5 minutes | 13.560051 | Pass |
| 10 minutes | 13.560050 | Pass |

Temperature: 0°C:

| time | Measured Frequency (MHz) | Result |
|------------|--------------------------|--------|
| 0 minutes | 13.560050 | Pass |
| 2 minutes | 13.560051 | Pass |
| 5 minutes | 13.560050 | Pass |
| 10 minutes | 13.560050 | Pass |

TEST REPORT

Temperature: -10°C:

| time | Measured Frequency (MHz) | Result |
|------------|--------------------------|--------|
| 0 minutes | 13.560050 | Pass |
| 2 minutes | 13.560050 | Pass |
| 5 minutes | 13.560050 | Pass |
| 10 minutes | 13.560049 | Pass |

Temperature: -20°C:

| time | Measured Frequency (MHz) | Result |
|------------|--------------------------|--------|
| 0 minutes | 13.560049 | Pass |
| 2 minutes | 13.560048 | Pass |
| 5 minutes | 13.560049 | Pass |
| 10 minutes | 13.560049 | Pass |

Temperature: 20°C:

| Power Supply (V AC) | Measured Frequency (MHz) | Result |
|---------------------|--------------------------|--------|
| 85% | 13.560050 | Pass |
| 95% | 13.560049 | Pass |
| 105% | 13.560049 | Pass |
| 115% | 13.560048 | Pass |

TEST REPORT

4.5 Conducted Emission Test

Test Configuration:

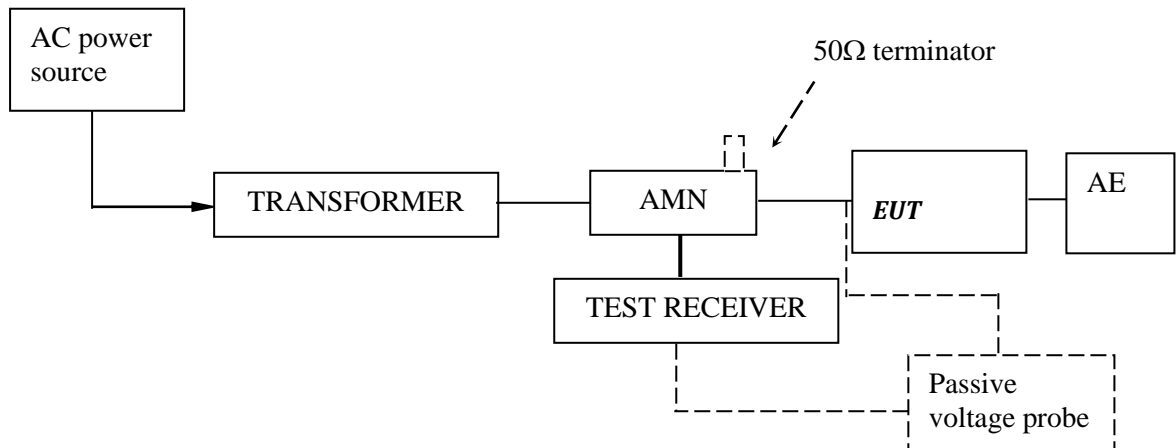

Test Setup and Procedure:

Test was performed according to ANSI C63.10 Clause 6.2. The EUT was set to achieve the maximum emission level. The mains terminal disturbance voltage was measured with the EUT in a shielded room. The EUT was connected to AC power source through an Artificial Mains Network which provides a 50Ω linear impedance. Artificial hand is used if appropriate (for handheld apparatus). The load/control terminal disturbance voltage was measured with passive voltage probe if appropriate.

The table-top EUT was placed on a 0.8m high non-metallic table above earthed ground plane (Ground Reference Plane). And for floor standing EUT, was placed on a 12 mm high non-metallic supported on GRP. The EUT keeps a distance of at least 0.8m from any other of the metallic surface. The Artificial Mains Network is situated at a distance of 0.8m from the EUT.

During the test, mains lead of EUT excess 0.8m was folded back and forth parallel to the lead so as to form a horizontal bundle with a length between 0.3m and 0.4m

The bandwidth of test receiver was set at 9 kHz. The frequency range from 150 kHz to 30MHz was checked.

TEST REPORT

Test Data and Curve

At main terminal: Pass (perform the AC power-line conducted tests with the antenna connected)

Tested Wire: Live

Operation Mode: transmitting mode

Full Spectrum

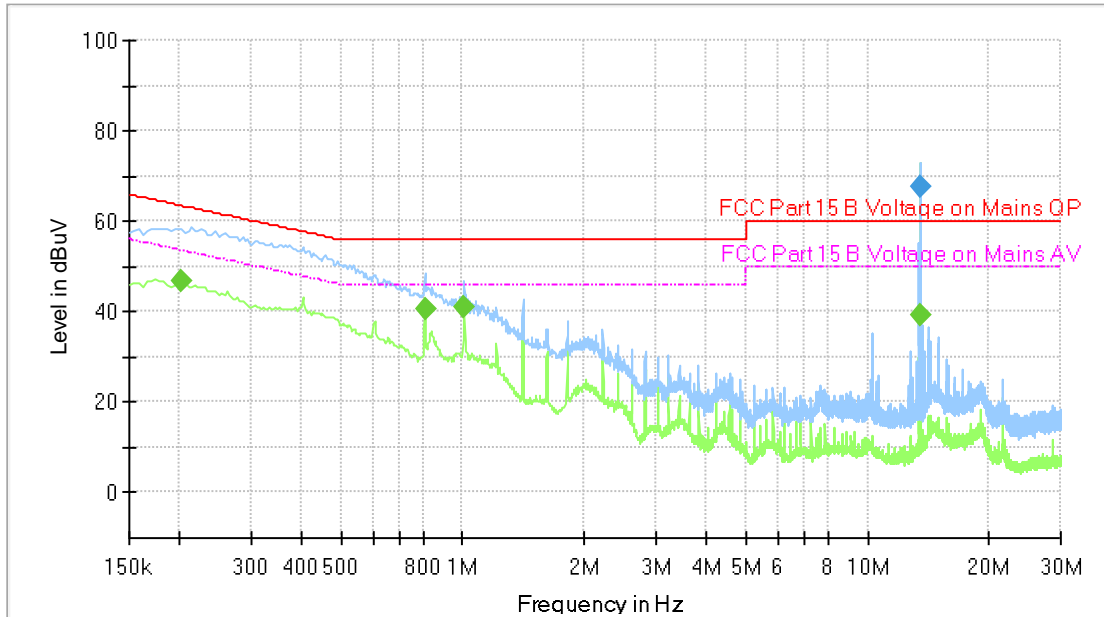

Final Result

| Frequency (MHz) | QuasiPeak (dBuV) | CAverage (dBuV) | Limit (dBuV) | Margin (dB) | Meas. Time (ms) | Bandwidth (kHz) | Line | Filter | Corr. (dB) |
|-----------------|------------------|-----------------|--------------|-------------|-----------------|-----------------|------|--------|------------|
| 0.202000 | --- | 46.93 | 53.53 | 6.60 | 1000.0 | 9.000 | L1 | ON | 9.6 |
| 0.806000 | --- | 40.78 | 46.00 | 5.22 | 1000.0 | 9.000 | L1 | ON | 9.6 |
| 1.006000 | --- | 41.06 | 46.00 | 4.94 | 1000.0 | 9.000 | L1 | ON | 9.6 |
| 13.562000 | --- | 39.09 | 50.00 | 10.91 | 1000.0 | 9.000 | L1 | ON | 9.9 |
| 13.562000 | 67.59 | --- | 60.00 | -7.59 | 1000.0 | 9.000 | L1 | ON | 9.9 |

Remark:

1. Corr. (dB) = LISN Factor (dB) + Cable Loss (dB)
2. Level (dBμV) = Corr. (dB) + Read Level (dBμV)
3. Delta Limit (dB) = Level (dBμV)-Limit (dBμV)

TEST REPORT

Tested Wire: Neutral

Operation Mode: transmitting mode

Full Spectrum

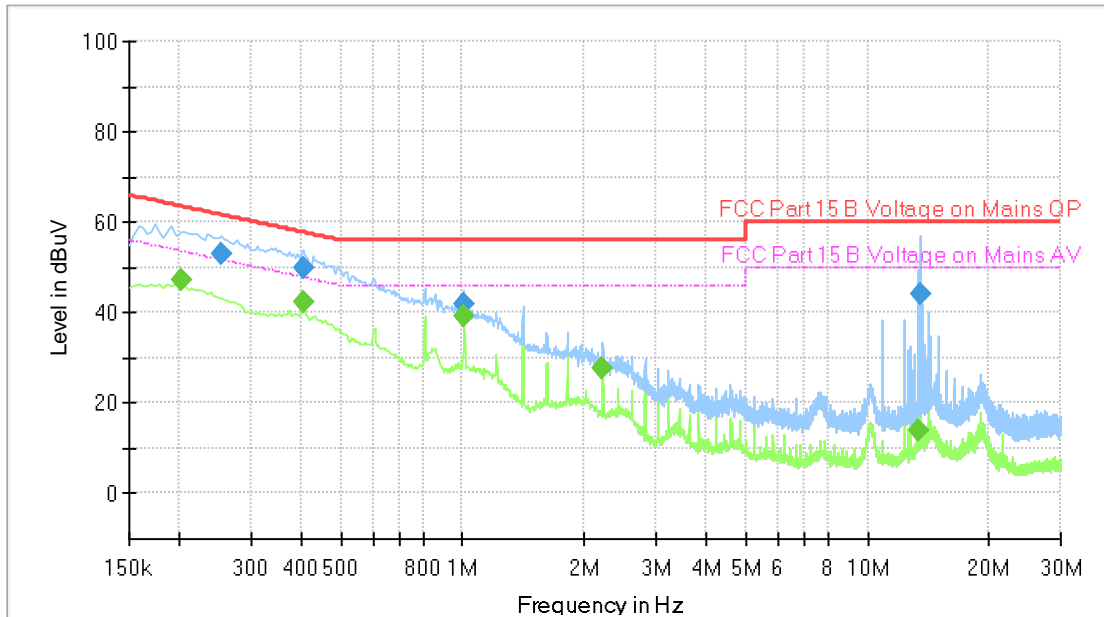

Final Result

| Frequency (MHz) | QuasiPeak (dBuV) | CAverage (dBuV) | Limit (dBuV) | Margin (dB) | Meas. Time (ms) | Bandwidth (kHz) | Line | Filter | Corr. (dB) |
|-----------------|------------------|-----------------|--------------|-------------|-----------------|-----------------|------|--------|------------|
| 0.202000 | --- | 47.26 | 53.53 | 6.27 | 1000.0 | 9.000 | N | ON | 9.5 |
| 0.254000 | 53.18 | --- | 61.63 | 8.45 | 1000.0 | 9.000 | N | ON | 9.5 |
| 0.402000 | 50.05 | --- | 57.81 | 7.76 | 1000.0 | 9.000 | N | ON | 9.5 |
| 0.402000 | --- | 42.32 | 47.81 | 5.50 | 1000.0 | 9.000 | N | ON | 9.5 |
| 1.006000 | --- | 39.04 | 46.00 | 6.96 | 1000.0 | 9.000 | N | ON | 9.5 |
| 1.006000 | 41.90 | --- | 56.00 | 14.10 | 1000.0 | 9.000 | N | ON | 9.5 |
| 2.218000 | --- | 27.80 | 46.00 | 18.20 | 1000.0 | 9.000 | N | ON | 9.5 |
| 13.398000 | --- | 14.03 | 50.00 | 35.97 | 1000.0 | 9.000 | N | ON | 9.8 |
| 13.530000 | 44.15 | --- | 60.00 | 15.85 | 1000.0 | 9.000 | N | ON | 9.8 |

Remark:

1. Corr. (dB) = LISN Factor (dB) + Cable Loss (dB)
2. Level (dBμV) = Corr. (dB) + Read Level (dBμV)
3. Delta Limit (dB) = Level (dBμV)-Limit (dBμV)

TEST REPORT

At main terminal: Pass(retest with a dummy load in lieu of the antenna)

Tested Wire: Live

Operation Mode: transmitting mode

Full Spectrum

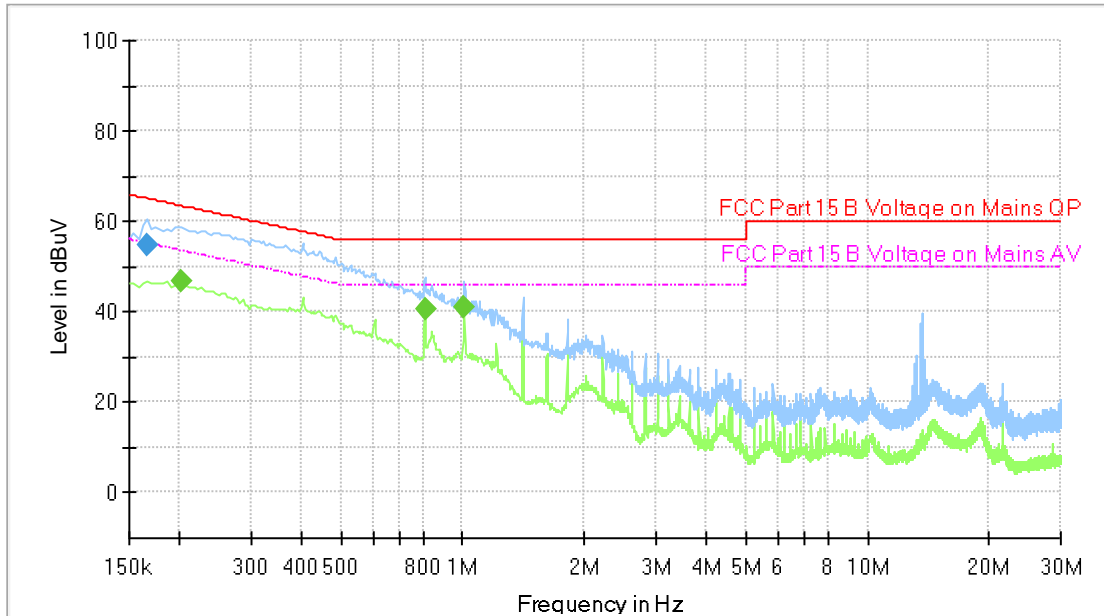

Final_Result

| Frequency (MHz) | QuasiPeak (dBuV) | CAverage (dBuV) | Limit (dBuV) | Margin (dB) | Meas. Time (ms) | Bandwidth (kHz) | Line | Filter | Corr. (dB) |
|-----------------|------------------|-----------------|--------------|-------------|-----------------|-----------------|------|--------|------------|
| 0.166000 | 54.75 | --- | 65.05 | 10.30 | 1000.0 | 9.000 | L1 | ON | 9.6 |
| 0.202000 | --- | 46.88 | 53.53 | 6.65 | 1000.0 | 9.000 | L1 | ON | 9.6 |
| 0.806000 | --- | 40.78 | 46.00 | 5.22 | 1000.0 | 9.000 | L1 | ON | 9.6 |
| 1.006000 | --- | 41.03 | 46.00 | 4.97 | 1000.0 | 9.000 | L1 | ON | 9.6 |

Remark:

1. Corr. (dB) = LISN Factor (dB) + Cable Loss (dB)
2. Level (dBμV) = Corr. (dB) + Read Level (dBμV)
3. Delta Limit (dB) = Level (dBμV)-Limit (dBμV)

TEST REPORT

Tested Wire: Neutral

Operation Mode: transmitting mode

Full Spectrum

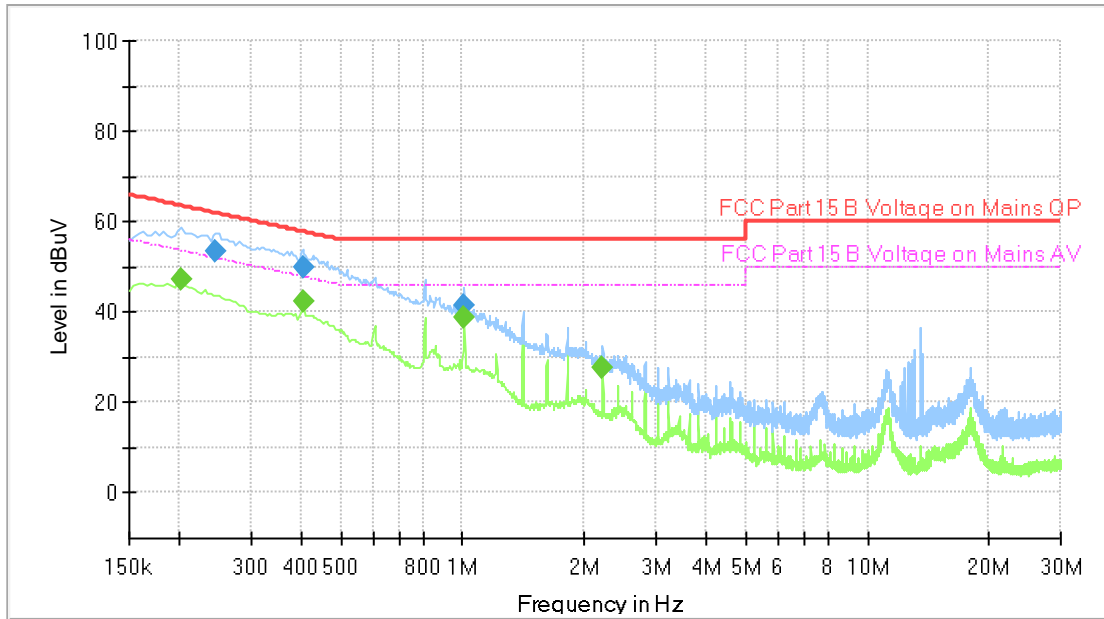

Final Result

| Frequency (MHz) | QuasiPeak (dBuV) | CAverage (dBuV) | Limit (dBuV) | Margin (dB) | Meas. Time (ms) | Bandwidth (kHz) | Line | Filter | Corr. (dB) |
|-----------------|------------------|-----------------|--------------|-------------|-----------------|-----------------|------|--------|------------|
| 0.202000 | --- | 47.22 | 53.53 | 6.31 | 1000.0 | 9.000 | N | ON | 9.5 |
| 0.246000 | 53.26 | --- | 61.89 | 8.63 | 1000.0 | 9.000 | N | ON | 9.5 |
| 0.402000 | --- | 42.29 | 47.81 | 5.52 | 1000.0 | 9.000 | N | ON | 9.5 |
| 0.402000 | 50.03 | --- | 57.81 | 7.79 | 1000.0 | 9.000 | N | ON | 9.5 |
| 1.006000 | --- | 38.93 | 46.00 | 7.07 | 1000.0 | 9.000 | N | ON | 9.5 |
| 1.010000 | 41.51 | --- | 56.00 | 14.49 | 1000.0 | 9.000 | N | ON | 9.5 |
| 2.218000 | --- | 27.56 | 46.00 | 18.44 | 1000.0 | 9.000 | N | ON | 9.5 |

Remark:

1. Corr. (dB) = LISN Factor (dB) + Cable Loss (dB)
2. Level (dBμV) = Corr. (dB) + Read Level (dBμV)
3. Delta Limit (dB) = Level (dBμV)-Limit (dBμV)

TEST REPORT

5.0 Test Equipment List

Radiated Emission/Radio

| Equipment No. | Equipment | Model | Manufacturer | Cal. Due date (YYYY-MM-DD) | Calibration Interval |
|---------------|---|----------------------|------------------|-------------------------------|-------------------------|
| EM030-04 | 3m Semi-Anechoic Chamber | 9×6×6 m ³ | ETS·LINDGRE N | 2024-04-10 | 1Y |
| EM031-02 | EMI Test Receiver (9 kHz~7 GHz) | R&S ESR7 | R&S | 2024-11-15 | 1Y |
| EM031-03 | Signal and Spectrum Analyzer (10 Hz~40 GHz) | R&S FSV40 | R&S | 2024-11-12 | 1Y |
| EM011-04 | Loop antenna (9 kHz-30 MHz) | HFH2-Z2 | R&S | 2024-07-02 | 1Y |
| EM033-01 | TRILOG Super Broadband test Antenna(30 MHz-3 GHz) (RX) | VULB 9163 | SCHWARZBECK | 2024-12-05 | 1Y |
| EM033-02 | Bouble-Ridged Waveguide Horn Antenna (800 MHz-18 GHz)(RX) | R&S HF907 | R&S | 2024-07-02 | 1Y |
| EM033-03 | High Frequency Antenna & preamplifier(18 GHz~26.5 GHz) (RX) | R&S SCU-26 | R&S | 2024-04-22 | 1Y |
| EM033-04 | High Frequency Antenna & preamplifier (26 GHz-40 GHz) | R&S SCU-40 | R&S | 2024-04-22 | 1Y |
| EM031-02-01 | Coaxial cable(9 kHz-1 GHz) | N/A | R&S | 2024-04-10 | 1Y |
| EM033-02-02 | Coaxial cable(1 GHz-18 GHz) | N/A | R&S | 2024-04-10 | 1Y |
| EM033-04-02 | Coaxial cable(18 GHz~40 GHz) | N/A | R&S | 2024-04-22 | 1Y |
| EM031-01 | Signal Generator (9 kHz~6 GHz) | SMB100A | R&S | 2025-03-17 | 1Y |
| EM040-01 | Band Reject/Notch Filter | WRHFV | Wainwright | N/A | 1Y |
| EM040-02 | Band Reject/Notch Filter | WRCGV | Wainwright | N/A | 1Y |
| EM040-03 | Band Reject/Notch Filter | WRCGV | Wainwright | N/A | 1Y |
| EM022-03 | 2.45 GHz Filter | BRM50702 | Micro-Tronics | 2024-05-09 | 1Y |
| SA016-29 | Climatic Test Chamber | MHU-80L | JIANQIAO | 2025-01-03 | 1Y |
| EM046-05 | Power meter | NPR6A | R&S | 2024-04-19 | 1Y |
| EM046-06 | Power meter | NPR6A | R&S | 2024-04-19 | 1Y |
| EM045-01-01 | EMC32 software (RE/RS) | V10.01.00 | R&S | N/A | N/A |

Conducted Disturbance-Mains Terminal (2)

| Equipment No. | Equipment | Model | Manufacturer | Cal. Due date (DD-MM-YYYY) | Calibration Interval |
|---------------|--|-----------|--------------|-------------------------------|-------------------------|
| EM031-04 | EMI receiver | ESR3 | R&S | 04/01/2025 | 1Y |
| EM032-02 | LISN | NSLK8128 | SCHWARZBECK | 13/07/2024 | 1Y |
| SA047-111 | Digital Temperature-Humidity Recorder | RS210 | YIJIE | 22/10/2024 | 1Y |
| EM004-03 | EMC shield Room | 8m×4m×3m | Zhongyu | 03/01/2025 | 1Y |
| EM031-04-01 | EMC32 software (CE) | V10.01.00 | R&S | N/A | 1Y |

*****End of the test report*****