

l o g o

Standing hair dryer

User Manual

Packing List:

Main body (Include telescopic rod)	1 set
Base(Include Power supply cord)	1 set
Remote controller	1 set
User manual	1 set

This user manual is applicable to B1D product model.
Please read this manual carefully and keep it properly before using the product.

CAUTIONS AND NOTE

This device contains licence-exempt transmitter(s)/receiver(s) that comply with Innovation, Science and Economic Development Canada's licence-exempt RSS(s). Operation is subject to the following two conditions:

- (1) This device may not cause interference.
- (2) This device must accept any interference, including interference that may cause undesired operation of the device.

Changes or modifications to this unit not expressly approved by the party responsible for compliance could void the user's authority to operate the equipment.

This equipment has been tested and found to comply with the limits for a Class B digital device, pursuant to Part 15 of the FCC Rules. These limits are designed to provide reasonable protection against harmful interference in a residential installation. This equipment generates uses and can radiate radio frequency energy and, if not installed and used in accordance with the instructions, may cause harmful interference to radio communications.

However, there is no guarantee that interference will not occur in a particular installation. If this equipment does cause harmful interference to radio or television reception, which can be determined by turning the equipment off and on, the user is encouraged to try to correct the interference by one or more of the following measures:

- Reorient or relocate the receiving antenna.
- Increase the separation between the equipment and receiver.
- Connect the equipment into an outlet on a circuit different from that to which the receiver is connected.
- Consult the dealer or an experienced radio/TV technician for help.

This appliance has a polarized plug (one blade is wider than the other).As a safety feature, this plug will fit in a polarized outlet only one way. If the plug does not fit fully in the outlet, reverse the plug.If it still does not fit, contact a qualified electrician. Do not attempt to defeat this safety feature.

This device complies with Part 15 of the FCC Rules. Operation is subject to the following two conditions: (1) this device may not cause harmful interference, and (2) this device must accept any interference received, including interference that may cause undesired operation.

L'émetteur/récepteur exempt de licence contenu dans le présent appareil est conforme aux CNR d'Innovation, Sciences et Développement économique Canada applicables aux appareils radio exempts de licence. L'exploitation est autorisée aux deux conditions suivantes :

1. L'appareil ne doit pas produire de brouillage;
2. L'appareil doit accepter tout brouillage radioélectrique subi, même si le brouillage est susceptible d'en compromettre le fonctionnement.

IMPORTANT SAFETY INSTRUCTIONS

When using electrical appliances, especially when children are present, basic safety precautions should always be followed, including the following: interference, and (2) this device must accept any interference received, including interference that may cause undesired operation.

READ ALL INSTRUCTIONS BEFORE USING

DANGER – To reduce the risk of electrocution:

1. Always unplug this appliance immediately after using.
2. Do not use while bathing.
3. Do not place or store appliance where it can fall or be pulled into a tub or sink.
4. Do not place in or drop into water or other liquid.
5. Do not reach for an appliance that has fallen into water. Unplug immediately

WARNING – To reduce the risk of burns, electrocution, fire, or injury to persons:

1. An appliance should never be left unattended when plugged in.
2. Close supervision is necessary when this appliance is used by, on, or near children or individuals with certain disabilities.
3. Use this appliance only for its intended use as described in this manual.
Do not use attachments not recommended by the manufacturer.
4. Never operate this appliance if it has a damaged cord or plug, if it is not working properly, or if it has been dropped, damaged, or dropped into water. Return the appliance to a service center for examination and repair.
5. Keep the cord away from heated surfaces. Do not wrap the cord around the appliance.
6. Never block the air openings of the appliance or place it on a soft surface, such as a bed or couch, where the air openings may be blocked. Keep the air openings free of lint, hair, and the like.
7. Never use while sleeping.
8. Never drop or insert any object into any opening or hose.
9. Do not use outdoors or operate where aerosol (spray) products are being used or where oxygen is being administered.
10. Do not use an extension cord with this appliance.
11. Household use only.

SAVE THESE INSTRUCTIONS

1. Do not direct hot air toward eyes or other heat sensitive areas.
2. Attachments may be hot during use. Allow them to cool before handling.
3. Do not place appliance on any surface while it is operating.
4. While using the appliance, keep your hair away from the air inlets.
5. Do not operate with a voltage converter.

MAINTENANCE AND SERVICE

Make sure the on-off switch is off and unplug the power plug when cleaning the hair dryer.

Please regularly use towel, cotton swab or toothbrush to remove the attachment of air inlet and outlet regularly.

Do not press or rub the air inlet and outlet with nails or sharp objects to avoid damaging the product.

Do not use alcohol, nail washing water or detergent to clean this product, otherwise it may cause failure, cracking or fading.

PRODUCT SAFETY CAUTIONS

In order to reduce the risk of failure, electric shock, injury, fire, death and damage to equipment or property, be sure to observe the following safety precautions

Mark instructions

⚠ Warning Indicates a potential hazard that could result in serious injury or death.

⚠ Notes indicates a risk of minor injury.

⊘ This mark is used to remind the user of the prohibited action steps.

⌚ This sign is used to remind the user must be followed operation steps in order to keep safety.

⚠ WARNING

Power cord and power plug

- ⊘ Do not use when the power cord or plug is damaged or heated, otherwise it may cause scald, electric shock or fire due to short circuit.
- ⊘ Do not use when the power plug is loose, otherwise it may cause scald, electric shock or fire due to short circuit.
- ⊘ Do not unplug the power plug when your hands are wet, otherwise it may cause electric shock and injury.
- ⊘ Do not use it when the power cord is tied, otherwise it may cause electric shock or fire due to short circuit.
- ⊘ Do not damage, modify, bend, pull, twist the power cord, place heavy objects on the power cord, or squeeze the power cord, otherwise it may cause electric shock or fire due to short circuit.
- ⌚ When unplugging the power plug, do not pull the power cord. Be sure to pull it out by holding the power plug, otherwise the power cord may be disconnected, scald, electric shock or fire due to short circuit.
- ⌚ Fully insert the power plug; Please use 120V voltage; Please use the socket alone and do not use the power terminal block, otherwise it may cause electric shock or fire due to short circuit.
- ⌚ If the power cord is damaged, it must be replaced by professionals of the manufacturer, its maintenance department or similar departments in order to avoid danger.

⚠ WARNING

Use and storage

- ⊘ Do not use the hair dryer in the bathroom, otherwise it may cause electric shock, even after the on-off switch is disconnected.
- ⊘ Do not place the air inlet of the hair dryer downward in the working state, otherwise it may cause the heating wire to turn red and cause a fire.
- ⊘ Do not block or insert foreign matters into the air outlet and air inlet, otherwise it may cause scald, electric shock or fire due to high temperature or short circuit.
- ⊘ Do not cover the air inlet and outlet with towels and clothes, otherwise it may cause scald, electric shock or fire due to high temperature or short circuit.
- ⊘ The hair dryer is only designed for hair blowing function. Do not use the hair dryer for dry clothes and other non designed uses.
- ⊘ Do not immerse the hair dryer in water.
- ⊘ Do not use this hair dryer in a humid environment.
- ⊘ Please keep the hair dryer dry, otherwise it may cause electric shock.
- ⊘ Do not use with wet hands, otherwise electric shock or fire may occur due to short circuit.
- ⊘ Do not use near LPG or other inflammable products (such as volatile agents, paint thinners, sprays, etc.), otherwise it may cause explosion or cause a fire due to short circuit.
- ⊘ Do not leave the product with the power on, otherwise fire may be caused by short circuit.
- ⊘ Do not wrap the power cord around the main body of the product during storage, otherwise the power cord may be disconnected, electric shock or fire due to short circuit.
- ⊘ Do not store it in a highly humid place, otherwise it may cause electric shock or fire due to short circuit.
- ⊘ Do not store it in the contact range of children and infants, otherwise it may cause electric shock and injury.
- ⊘ Do not use this appliance near the bathtub, shower, washbasin or other utensils containing water.
- ⊘ Do not store or use it outdoors or in places prone to rain, otherwise it may cause electric shock or fire due to short circuit.

⚠ WARNING

Use and storage

- ⊘ Do not repair, disassemble or refit this product by yourself, otherwise you may be injured due to fire or abnormal action. If you need to repair, please call the company's service phone.
- ⊘ In order to increase protection, it is recommended to install a residual current device (RCD) with rated residual working current not exceeding 30mA in the power supply electrical circuit of the bathroom. If it needs to be purchased separately, consult the RCD installer.
- ⊘ Do not change the use scene or conditions, expand the transmission frequency range, or increase the transmission power (including adding an additional RF power amplifier).
- ⊘ Do not use the remote control in an area with a radius of 5000 meters centered on the center point of the airport runway.
- ⊘ This product should not be used by persons with physical, sensory or mental disabilities, or those without experience and knowledge (including children). A supervisor must supervise and guide the use of this product, and be responsible for the safety of the user, otherwise it may cause injury or other accidents.

In case of abnormality or failure

⌚ In case of abnormality or failure, such as no air, frequent stop, internal redness and smoke, please stop using immediately, unplug the power plug and call the company's service phone. In this case, the use of this product may cause electric shock, injury or fire due to short circuit.

⚠ NOTE

Operation instructions

- ⊗ In the process of using, the air outlet and nozzle may become hot. Do not touch them with your hands, otherwise they may cause burns.
- ⊗ Please avoid dropping the hair dryer or strong impact on the hair dryer, otherwise it may cause electric shock or fire due to short circuit.
- ⊗ Please do not use it when the air inlet is damaged, otherwise the hair may be drawn into the air inlet, resulting in hair damage.
- ⊗ Please do not use it on infants, otherwise it may cause burns.
- ⊗ Please do not store the power cord when it is twisted, otherwise it may cause the power cord to break, scald, electric shock or fire due to short circuit.
- ⊗ This product is only used to dry hair. Do not use it to dry shoes and clothes, otherwise it may cause scald or fire due to short circuit.

During the usage, do not touch the net on the air outlet of the hair dryer to avoid scalding.

Please ensure that the hair is kept more than 30cm away from the air inlet when using the hair dryer to avoid the hair being drawn into the hair dryer. Please ensure that the hair is kept more than 10cm away from the air outlet to avoid hair burns.

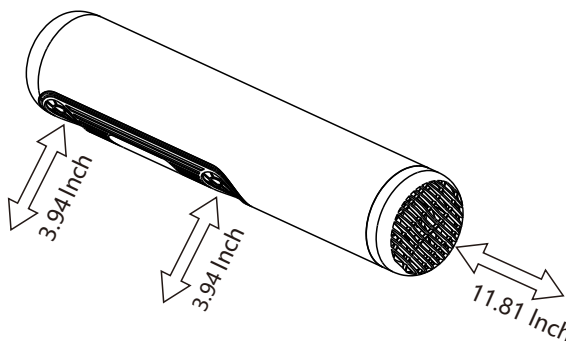
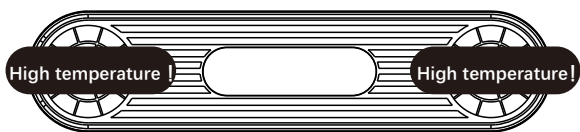

1. The hair dryer is equipped with 30min automatic power-off protection. When the hair dryer works continuously for 30min without operation, it will automatically stop working, so as to avoid forgetting to shut down or mistakenly touching the start, resulting in the long-term operation of the machine without adult monitoring. To continue using, please restart.
2. The blower is equipped with overheating automatic power-off protection. When the blower temperature is too high, it will automatically stop operation. In this case, please turn off the power supply of the hair dryer immediately. And remove the power plug from the power socket, and check whether the air inlet and outlet are blocked by hair or foreign matters. If there is no foreign matter, restart the power switch after the blower is cooled for 2 ~ 3 minutes; if there are foreign matters, please contact the after-sales customer service immediately. Do not operate by yourself.
3. The telescopic rod of the hair dryer is connected and fixed with the base through a coupler. When shaking the hair dryer by hand, it will shake slightly, which is a normal phenomenon. Please set your mind at rest to use.
4. The illustrations of products and accessories in the manual are schematic diagrams for reference only. Due to the update and upgrade of the product, the physical product may be slightly different from the schematic diagram. Please take the physical product as the standard.

SPECIFICATION

Product name	Standing hair dryer
Product model	B1D
Rated voltage	120V
Rated frequency	60Hz
Rated power	1400W
Date of manufacture	See commodity for details

INSTALLATION GUIDE

1、 installation.

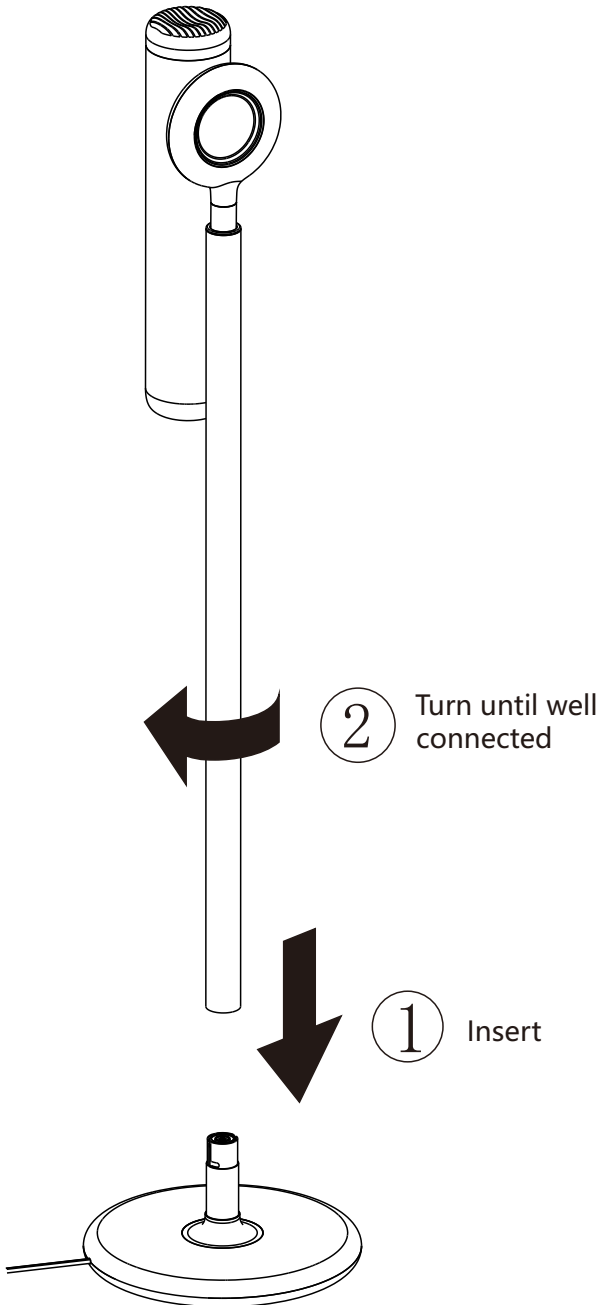

2、 Insert the power plug into the socket.

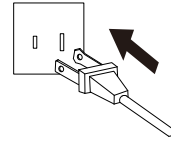

3、 Adjust the angle of the hair dryer head according to the rotation direction shown in the figure.

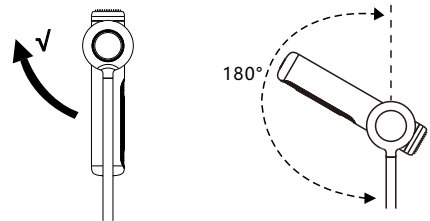

4、 Adjust the height of supporting rod.

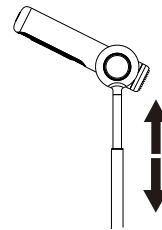

5、 Press the power button ①, you will hear a beep. Quickly double click on-off button ②, the hair dryer is on.

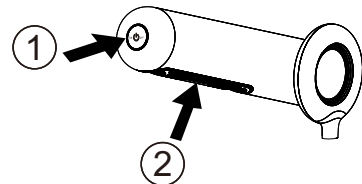

6、 Use the four buttons on the outer ring of remote control to adjust the hair dryer.

Please be careful not to press the OFF button.

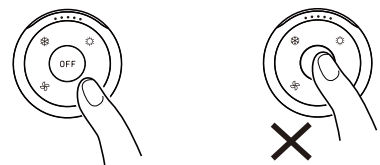

NOTE: If the hair dryer is not powered on ,please check whether the rod and the base are well connected.

PRODUCT INTRODUCTION

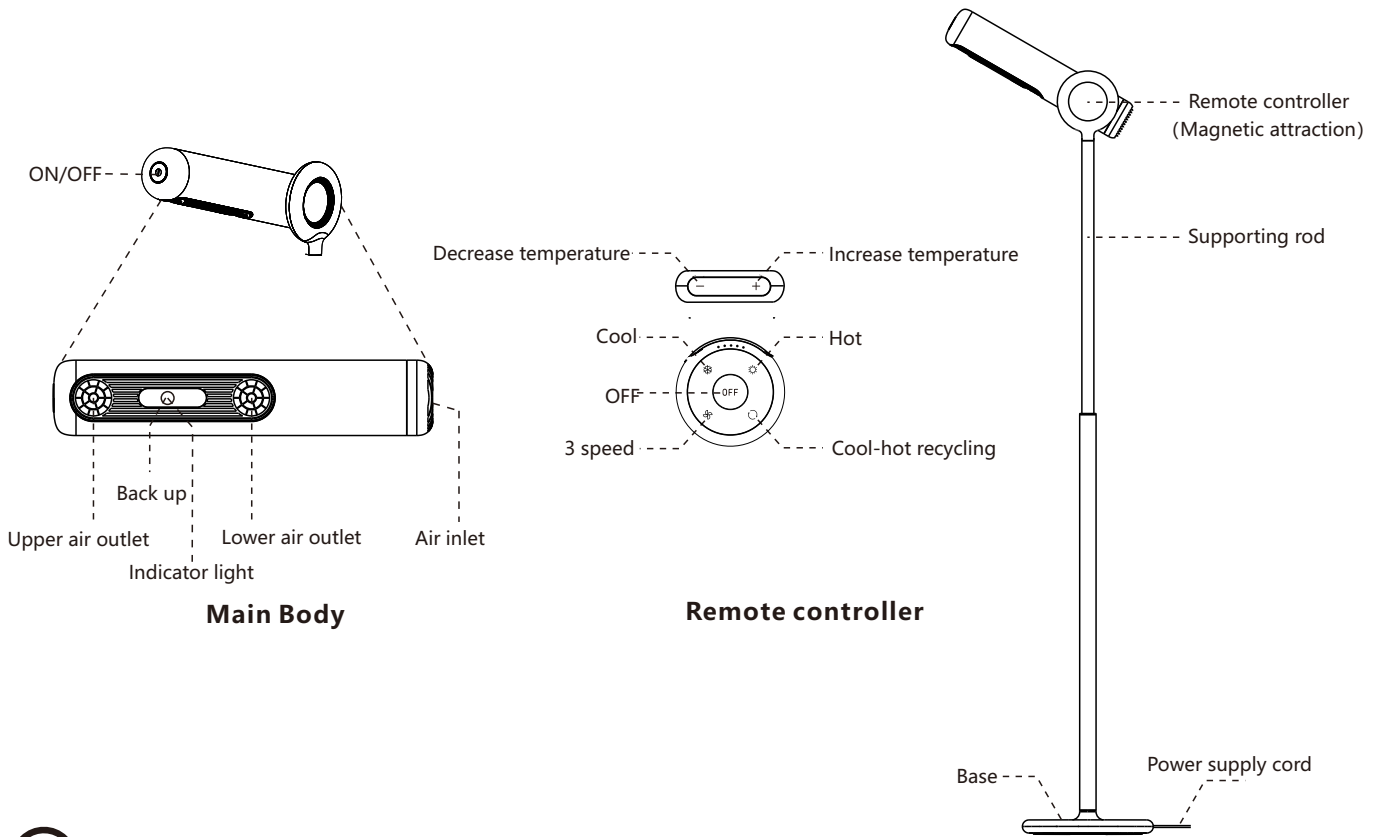

 This symbol represents "Do not use this device in a bathtub, shower, or water-filled reservoir".

DETAILED INSTRUCTIONS FOR REMOTE CONTROL

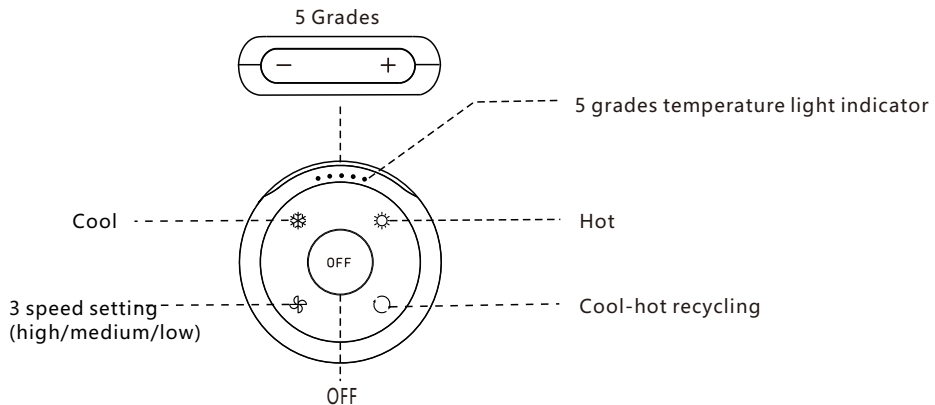

PRODUCT FEATUREA

1. The standing hair dryer can be directly used for 120V, 60Hz power supply and has five grades to adjust temperature and other different heat modes, to meet various needs.
2. The hair dryer has negative ion hair care technology, which is conducive to reduce static electricity, tighten hair scales, reduce hair irritability and make hair more healthy and more bright.
3. The negative ions is effective in all modes.
4. Various height factors are considered, so you can enjoy the good experience of sitting down and blowing your hair at home.
5. The telescopic rod is convenient to adjust the height. The main body is convenient to adjust angle.
6. The remote controller of the hair dryer is easy to use, so that you can have a better experience in the process of use.
7. The appearance of this hair dryer with excellent decorative characteristics is a beautiful decoration in your home.

ABNORMAL STATUS OPERATION GUIDE

INSTRUCTION FOR BACK UP BUTTON

If the remote controller does not work, the back up button can be used to start the hair dryer in emergency.

Double click back up button to start, it goes directly into Hot Mode, then click, it goes into Cool Mode, next click, it will be off.

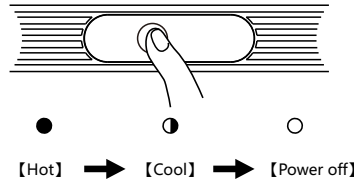

REMOTE CONTROLLER RE-CONNECT

Please re-connect the remote controller if the product is under following situation:

1. Back up button is on a red light and the remote controller has electricity, but can not control the hair dryer.

- Prepare: make sure that the hair dryer is powered on.
- Press and hold the back up button 3 seconds, then you will hear a beep, now you can release your hand, the blue light is flashing.
- Now press the OFF button.
- When the indicator light changes from flashing blue to stable blue or off, it is complete.

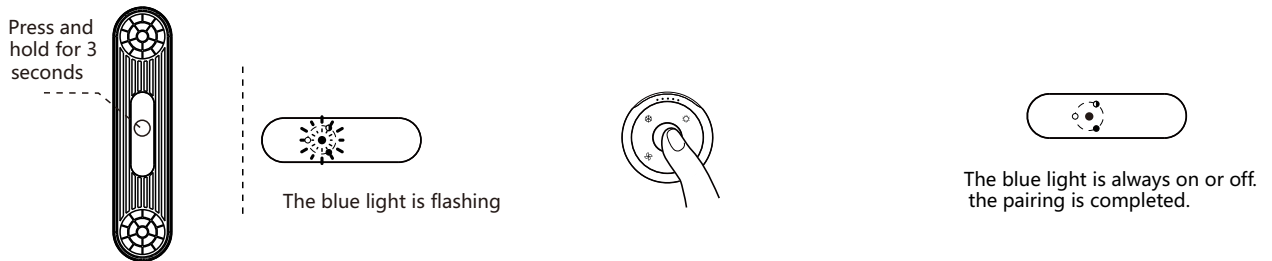

THE INSTRUCTIONS OF REMOTE CONTROLLER BATTERY REPLACEMENT

Please replace the battery in the following ways:

- Use a screwdriver to turn counterclockwise to open the rear cover.
- Remove the remote control battery and replace a new one. When installing the battery, please note "+" is upward.
- Screw in the rear cover clockwise.

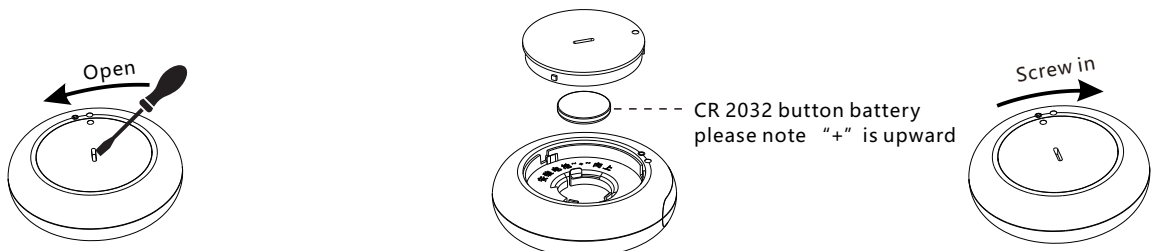

Note: When the battery is replaced, if the remote controller can not control the hair dryer, please re-connect with the main body.