



Certification Test Report

FCC ID: 2ADDKFLY4KW11
IC: 12404A-FLY4KW01

FCC Rule Part: 15.247
ISED Canada's Radio Standards Specification: RSS-247

Report Number: BO72136175.101

Applicant: 360fly, Inc.

Model(s): FLY4KW01 and FLY4KW11

Test Begin Date: **September 28, 2017**
Test End Date: **October 19, 2017**

Report Issue Date: March 29, 2018



FOR THE SCOPE OF ACCREDITATION UNDER CERTIFICATE NUMBER 2955.15

This report must not be used by the client to claim product certification, approval, or endorsement by A2LA, ANSI, or any agency of the Federal Government.

Prepared by:

Thierry Jean-Charles
Team Lead
TÜV SÜD America, Inc.

Reviewed by:

Ryan McGann
Senior Engineer
TÜV SÜD America, Inc.

This test report shall not be reproduced except in full. This report may be reproduced in part with prior written consent of TÜV SÜD America, Inc. The results contained in this report are representative of the sample(s) submitted for evaluation.

This report contains 30 pages

TABLE OF CONTENTS

1	GENERAL	3
1.1	Purpose	3
1.2	Applicant Information	3
1.3	Product Description	3
1.4	Test Methodology and Considerations	3
2	TEST FACILITIES	5
2.1	Location	5
2.2	Laboratory Accreditations/Recognitions/Certifications.....	5
2.3	Radiated & Conducted Emissions Test Site Description	6
2.3.1	Semi-Anechoic Chamber Test Site	6
2.3.2	Conducted Emissions Test Site Description.....	7
3	APPLICABLE STANDARD REFERENCES	8
4	LIST OF TEST EQUIPMENT	9
5	SUPPORT EQUIPMENT	10
6	EQUIPMENT UNDER TEST SETUP BLOCK DIAGRAM.....	11
7	SUMMARY OF TESTS.....	12
7.1	Antenna Requirement – FCC: Section 15.203.....	12
7.2	6 dB Bandwidth - FCC: Section 15.247(a)(2); ISED Canada: RSS-247 5.2(a); 99% Bandwidth ISED Canada: RSS-GEN 6.6.....	12
7.2.1	Measurement Procedure	12
7.2.2	Measurement Results	12
7.3	Peak Output Power – FCC: Section 15.247(b)(3); ISED Canada: RSS-247 5.4(d)	16
7.3.1	Measurement Procedure (Conducted Method)	16
7.3.2	Measurement Results	16
7.4	Band-Edge and Spurious Emissions	18
7.4.1	Band-Edge Compliance of RF Conducted Emissions – FCC: Section 15.247(d); ISED Canada: RSS-247 5.5.....	18
7.4.2	RF Conducted Spurious Emissions – FCC: Section 15.247(d); ISED Canada: RSS-247 5.5.....	20
7.4.3	Radiated Spurious Emissions into Restricted Frequency Bands – FCC: Sections 15.205, 15.209; ISED Canada: RSS-Gen 8.9, 8.10	22
7.4.4	Sample Calculation:	23
7.5	Power Spectral Density – FCC: Section 15.247(e); ISED Canada: RSS-247 5.2(b)	24
7.5.1	PSD Measurement Procedure (Conducted Method).....	24
7.5.2	Measurement Results	24
7.6	Power Line Conducted Emissions – FCC: Section 15.207; ISED Canada: RSS-Gen 8.8	26
7.6.1	Measurement Procedure.....	26
7.6.2	Measurement Results	26
8	MEASUREMENT UNCERTAINTIES	29
9	CONCLUSION.....	30

1 GENERAL

1.1 Purpose

The purpose of this report is to demonstrate compliance with Part 15 Subpart C of the FCC's Code of Federal Regulations Section 15.247 and Innovation Science and Economic Development Canada's Radio Standards Specification RSS-247 for the tests documented herein.

1.2 Applicant Information

360fly, Inc.
1975 East Sunrise Blvd., Suite 400
Fort Lauderdale, FL 33304

1.3 Product Description

The 360fly, Inc. model FLY4KW01 and FLY4KW11 are 360-degree cameras which can be body-worn or installed in vehicles. The two models are identical and differ only by the top housing design. The cameras provide Bluetooth and 2.4/5 GHz Wi-Fi connectivity. This test report documents the compliance of the Bluetooth Low Energy (BLE) Transmitter.

Technical Details

Mode of Operation: Bluetooth Low Energy
Frequency Range: 2402 MHz - 2480 MHz
Number of Channels: 40
Channel Separation: 2 MHz
Modulations: GFSK
Antenna Type/Gain: Loop with parasitic antenna, -0.15 dBi
Input Power: 5 VDC USB, 4 VDC Dock.

Model Number: FLY4KW01 and FLY4KW11

Test Sample Serial Number(s): 1708174355 (RF Conducted Measurements), 1709174742 (Radiated and Power Line Conducted Emissions).

Test Sample Condition: The samples were in good operating condition with no physical damages.

1.4 Test Methodology and Considerations

The EUT was evaluated for RF Conducted, Radiated and Power Line Conducted emissions. The test power level was not configurable from the test commands provided to support the testing. The EUT was set to operate at the maximum RF Output Power per the equipment manufacturer. All the measurements were performed on the FLY4KW01 model and the results are deemed representative of both model variants.

Preliminary radiated emission measurements were performed for the EUT standalone, the EUT powered via USB and the EUT set within the dock. Additionally, the EUT worst case orientation with respect to the ground plane was investigated as well. The configuration with the dock lead to the highest emissions. The EUT set sideways on the table top was determined as the worst case orientation for the band-edge measurements while the EUT flat on the table top led to the highest spurious emissions. The results reported correspond to these two configurations .

The RF conducted measurements were performed on a sample modified with a temporary RF connector to allow direct coupling to the spectrum analyzer.

The power line conducted emission measurements were performed on the EUT powered via USB using an off-the-shelf power supply.

The EUT was also investigated for compliance to the unintentional emission requirements. The results are documented in a verification test report.

2 TEST FACILITIES

2.1 Location

The radiated and conducted emissions test sites are located at the following address:

TÜV SÜD America, Inc.
3998 FAU Blvd, Suite 310
Boca Raton, Florida 33431
Phone: (561) 961-5585
Fax: (561) 961-5587
<http://www.tuv-sud-america.com>

2.2 Laboratory Accreditations/Recognitions/Certifications

TÜV SÜD America, Inc. is accredited to ISO/IEC 17025 by American Association for Laboratory Accreditation (A2LA) and has been issued certificate number 2955.15 in recognition of this accreditation. Unless otherwise specified, all test methods described within this report are covered under the ISO/IEC 17025 scope of accreditation.

FCC Test Firm Registration #: 475089
Innovation, Science and Economic Development Canada Lab Code: 4175C

2.3 Radiated & Conducted Emissions Test Site Description

2.3.1 Semi-Anechoic Chamber Test Site

The EMC radiated test facility consists of an RF-shielded enclosure. The interior dimensions of the indoor semi-anechoic chamber are approximately 48 feet (14.6 m) long by 36 feet (10.8 m) wide by 24 feet (7.3 m) high and consist of rigid, 1/8 inch (0.32 cm) steel-clad, wood core modular panels with steel framing. In the shielded enclosure, the faces of the panels are galvanized and the chamber is self-supporting. 8-foot RF absorbing cones are installed on 4 walls and the ceiling. The steel-clad ground plane is covered with vinyl flooring.

The turntable is driven by pneumatic motor, which can support a 2000 lb. load. The turntable is flush with the chamber floor which it is connected to, around its circumference, with a continuous metallic loaded spring. An EMCO Model 1060 Multi-device controller controls the turntable position.

A pneumatic motor is used to control antenna polarizations and height relative to the ground. The height information is displayed on the control unit EMCO Model 1050.

The control room is an RF shielded enclosure attached to the semi-anechoic chamber with two bulkhead panels for connecting RF, and control cables. The dimension of the room is 7.3 m x 4.9 m x 3 m high and the entrance doors of both control and conducted rooms are 3 feet (0.91 m) by 7 feet (2.13 m).

A diagram of the Semi-Anechoic Chamber Test Site is shown in Figure 2.3.1-1 below:

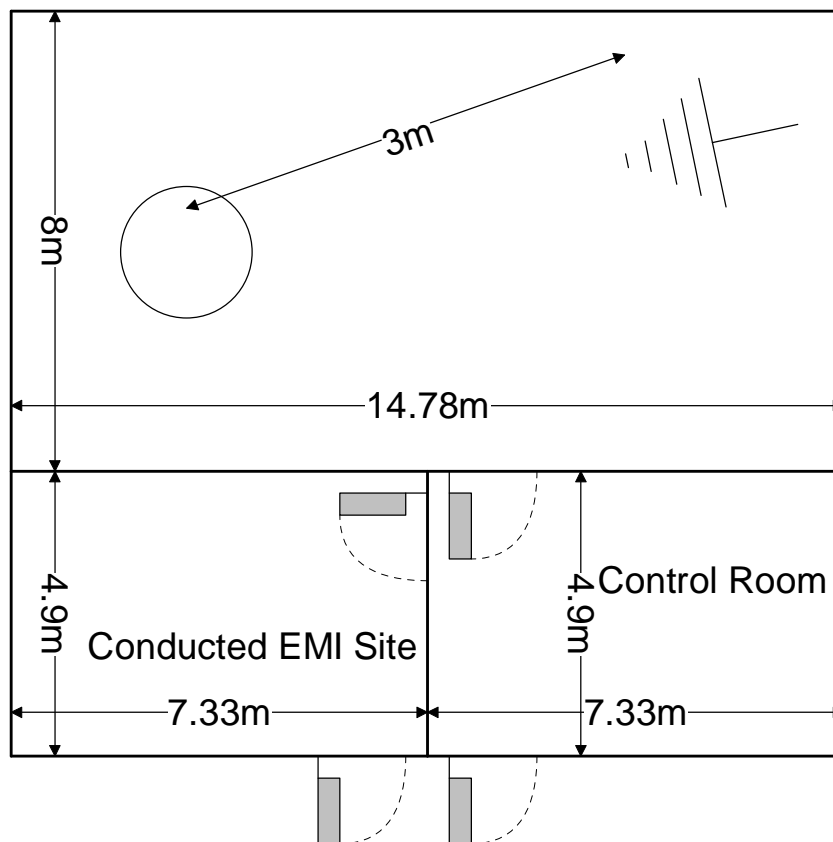

Figure 2.3.1-1: Semi-Anechoic Chamber Test Site

2.3.2 Conducted Emissions Test Site Description

The dimensions of the shielded conducted room are 7.3 x 4.9 x 3 m³. The power line conducted emission site includes two LISNs: a Solar Model 8028-50 50 Ω/50 μH and an EMCO Model 3825/2R, which are installed as shown in the figure below. For evaluations requiring 230 V, 50 Hz AC input, a Polarad LISN (S/N 879341/048) is used in conjunction with a California Instruments signal generator Model 2001RP-OP1.

A diagram of the room is shown below in figure 2.3.2-1:

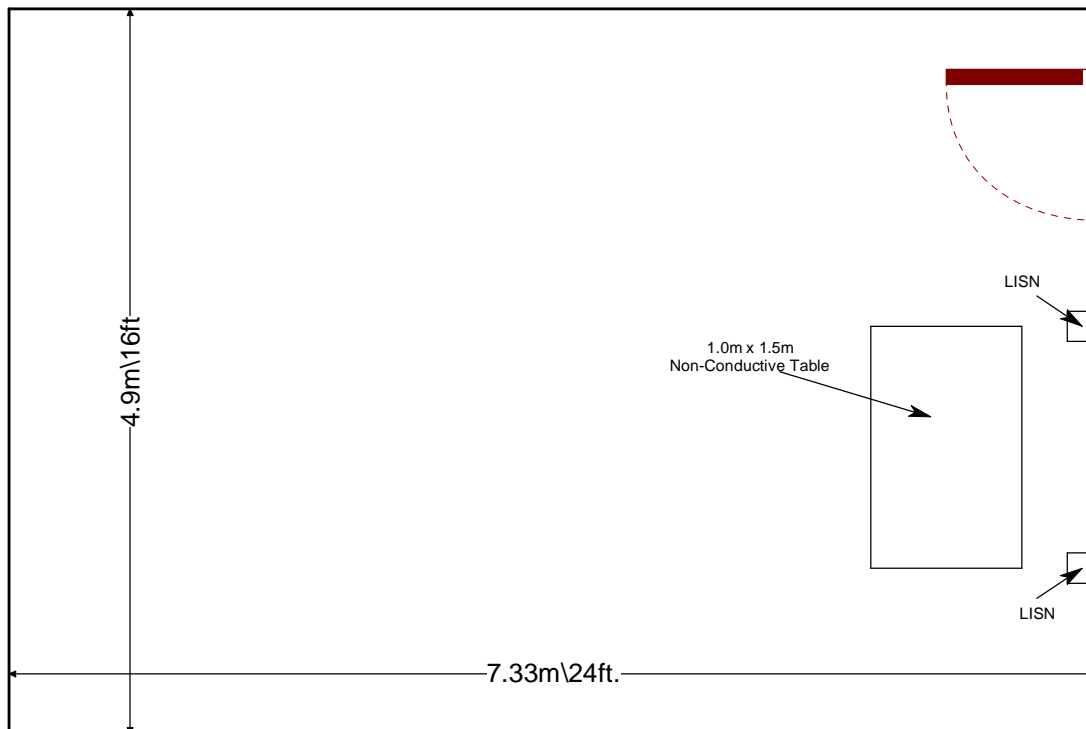

Figure 2.3.2-1: AC Mains Conducted EMI Site

3 APPLICABLE STANDARD REFERENCES

The following standards were used:

- ❖ ANSI C63.10-2013: American National Standard of Procedures for Compliance Testing of Unlicensed Wireless Devices
- ❖ US Code of Federal Regulations (CFR): Title 47, Part 2, Subpart J: Equipment Authorization Procedures, 2018.
- ❖ US Code of Federal Regulations (CFR): Title 47, Part 15, Subpart C: Radio Frequency Devices, Intentional Radiators, 2018.
- ❖ FCC KDB 558074 D01 DTS Meas Guidance v04 - Guidance for Performing Compliance Measurements on Digital Transmission Systems (DTS) Operating Under 15.247, April 5, 2017.
- ❖ Innovation, Science and Economic Development Canada Radio Standards Specification: RSS-247 — Digital Transmission Systems (DTSs), Frequency Hopping Systems (FHSs) and Licence-Exempt Local Area Network (LE-LAN) Devices, Issue 2, February 2017.
- ❖ Innovation, Science and Economic Development Canada Radio Standards Specification: RSS-GEN – General Requirements for Compliance of Radio Apparatus, Issue 4, Amendment 1, March 2018.

4 LIST OF TEST EQUIPMENT

The calibration interval of test equipment is annually or the manufacturer's recommendations. Where the calibration interval deviates from the annual cycle based on the instrument manufacturer's recommendations, it shall be stated below.

Table 4-1: Test Equipment List

AssetID	Manufacturer	Model #	Equipment Type	Serial #	Last Calibration Date	Calibration Due Date
282	Microwave Circuits	H2G020G4	Filters	74541	5/23/2017	5/23/2018
479	Electro-Metrics	ALP-70	Antennas	158	12/3/2015	12/3/2017
523	Agilent	E7405	Spectrum Analyzers	MY45103293	12/9/2016	12/9/2018
653	Suhner	SF-102A	Cables	0944/2A	9/5/2017	9/5/2018
2002	EMCO	3108	Antennas	2147	11/19/2015	11/19/2017
2004	EMCO	3146	Antennas	1385	11/19/2015	11/19/2017
2006	EMCO	3115	Antennas	2573	4/7/2017	4/7/2019
2008	COM-Power	AH-826	Antennas	81009	NCR	NCR
2045	ACS Boca	Conducted Cable Set	Cable Set	2045	10/31/2016	10/31/2017
2082	Teledyne Storm Products	90-010-048	Cables	2082	4/7/2017	4/7/2018
2086	Merrimac	FAN-6-10K	Attenuators	23148-83-1	11/2/2016	11/2/2017
2089	Agilent Technologies, Inc.	83017A	Amplifiers	3123A00214	12/2/2016	12/2/2017
2095	ETS Lindgren	TILE4! - Version 4.2.A	Software	85242	NCR	NCR
2111	Aeroflex Inmet	40AH2W-20	Attenuator	2111	7/20/2017	7/20/2018
2112	Teledyne Storm Products	921-0101-036	Cables	12-06-698	11/2/2016	11/2/2017
2121	ACS Boca	Radiated Cable Set	Cable Set	2121	7/31/2017	7/31/2018
3004	Teseq	CFL 9206A	Attenuators	34720	8/29/2017	8/29/2018
NBLE03366	Agilent	E4440A	Spectrum Analyzer	MY42510427	10/18/2016	10/18/2017
TEMC00153	Rohde and Schwarz	ESH3-Z5	LISN	894785/012	9/27/2017	9/27/2018

Notes:

- **NCR=No Calibration Required**
- **The assets were only used during the active period of the calibration cycle.**

5 SUPPORT EQUIPMENT

Table 5-1: EUT and Support Equipment Description – Radiated Emissions

Item #	Type Device	Manufacturer	Model/Part #	Serial #
1	EUT	360fly, Inc.	FLY4KW01	1709174742
2	Car Cradle	360fly, Inc.	FLYCRD01	N/A
3	Cigarette Lighter Adapter (CLA)	N/A	N/A	N/A
4	Power Supply	MPJA	HY5003	3700278

Table 5-2: Cable Description – Radiated Emissions

Cable #	Cable Type	Length	Shield	Termination
A	DC Cable	2.05 m	No	CLA to EUT
B	DC Leads	2.9 m	No	CLA to Power Supply
C	Power Cord	2.3 m	No	Power Supply to AC Mains

Table 5-3: EUT and Support Equipment Description – Power Line Conducted Emissions

Item #	Type Device	Manufacturer	Model/Part #	Serial #
1	EUT	360fly, Inc.	FLY4KW01	1709174742
2	5 VDC Power Supply	VSN Mobil	C-P06	141119001574

Table 5-4: Cable Description – Power Line Conducted Emissions

Cable #	Cable Type	Length	Shield	Termination
A	USB Cable	0.98 m	No	EUT to Power Supply
B	Extension Cord	1.85 m	No	Power Supply to AC Mains

6 EQUIPMENT UNDER TEST SETUP BLOCK DIAGRAM

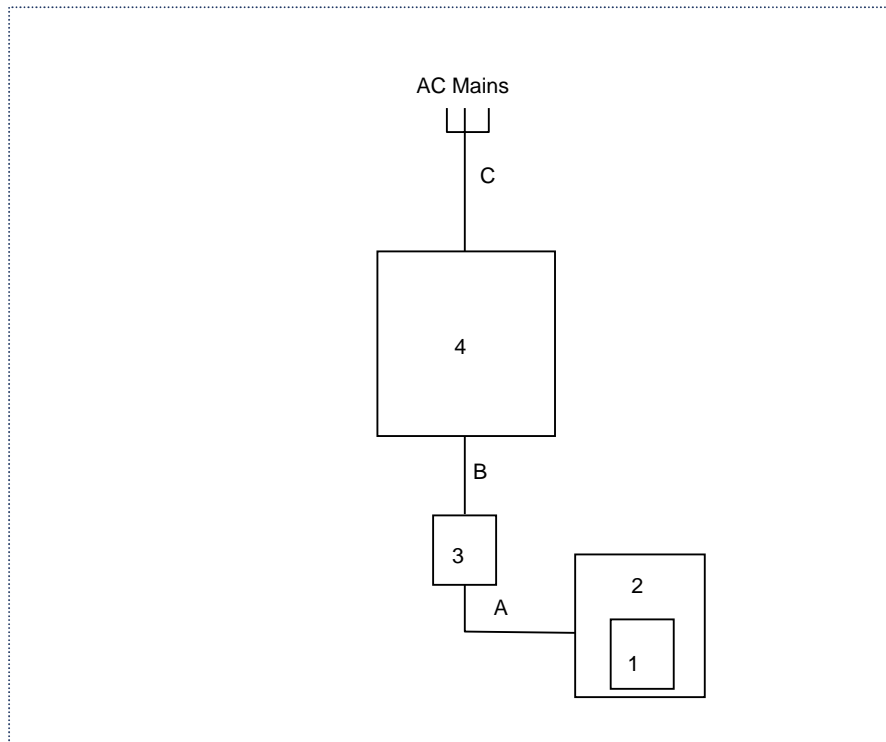

Figure 6-1: EUT and Support Equipment Block Diagram – Radiated Emissions

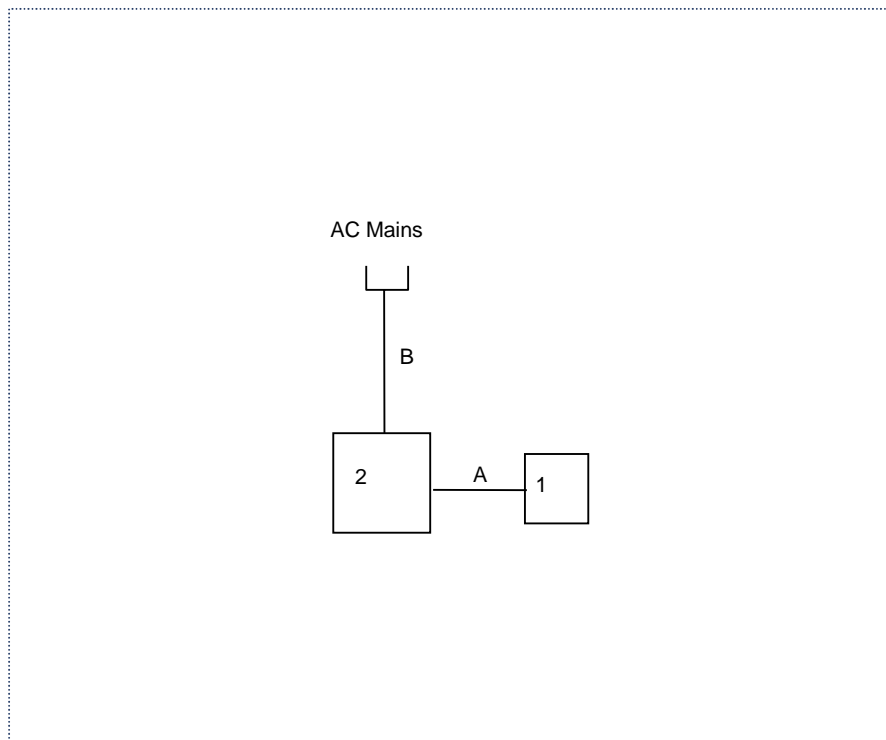

Figure 6-2: EUT and Support Equipment Block Diagram – Power Line Conducted Emissions

7 SUMMARY OF TESTS

Along with the tabular data shown below, plots were taken of all signals deemed important enough to document.

7.1 Antenna Requirement – FCC: Section 15.203

The EUT uses an internal -0.15 dBi loop with parasitic antenna that is connected to the main PCB via contact springs. The antenna is not replacable without damaging the equipment and therefore meets the requirements of FCC Section 15.203.

7.2 6 dB Bandwidth - FCC: Section 15.247(a)(2); ISED Canada: RSS-247 5.2(a); 99% Bandwidth ISED Canada: RSS-GEN 6.6

7.2.1 Measurement Procedure

The 6dB bandwidth was measured in accordance with the FCC KDB 558074 D01 DTS Meas Guidance v04 Section 8.1 Option 1. The RBW of the spectrum analyzer was set to 100 kHz and VBW 300 kHz. Span was set large enough to capture the emissions and >> RBW. A peak detector was used for the measurements.

The 99% occupied bandwidth was measured with the spectrum analyzer span set to fully display the emission. The RBW was set to 1% to 5% of the approximated bandwidth. The occupied 99% bandwidth was measured by using 99% bandwidth equipment function of the spectrum analyzer using a peak detector.

7.2.2 Measurement Results

Performed by: Thierry Jean-Charles

Table 7.2.2-1: 6dB / 99% Bandwidth

Frequency (MHz)	6dB Bandwidth (kHz)	99% Bandwidth (kHz)
2402	685.0	1064.1
2442	680.0	1064.3
2480	680.0	1063.9

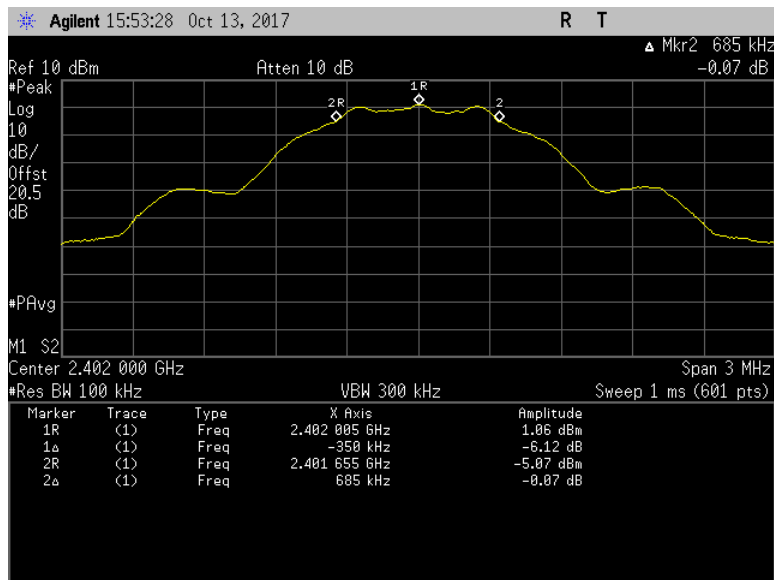

Figure 7.2.2-1: 6dB BW - Low Channel

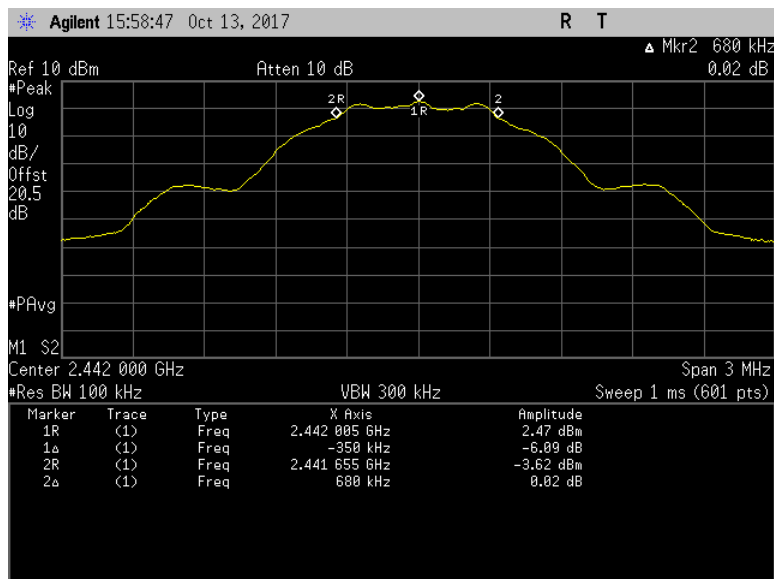

Figure 7.2.2-2: 6dB BW - Middle Channel

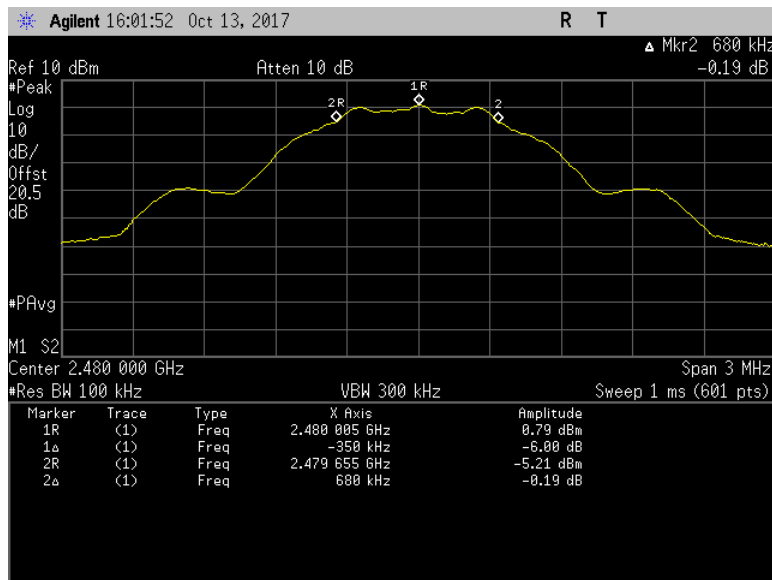

Figure 7.2.2-3: 6dB BW - High Channel

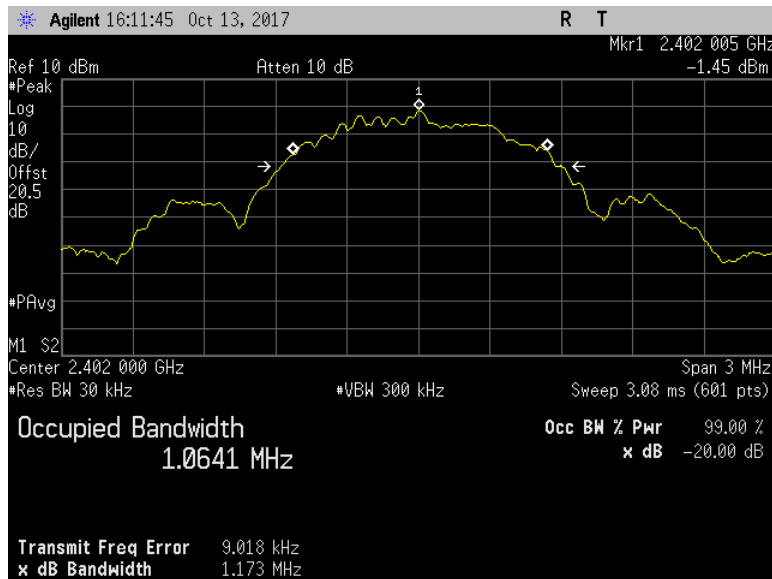

Figure 7.2.2-4: 99% OBW - Low Channel

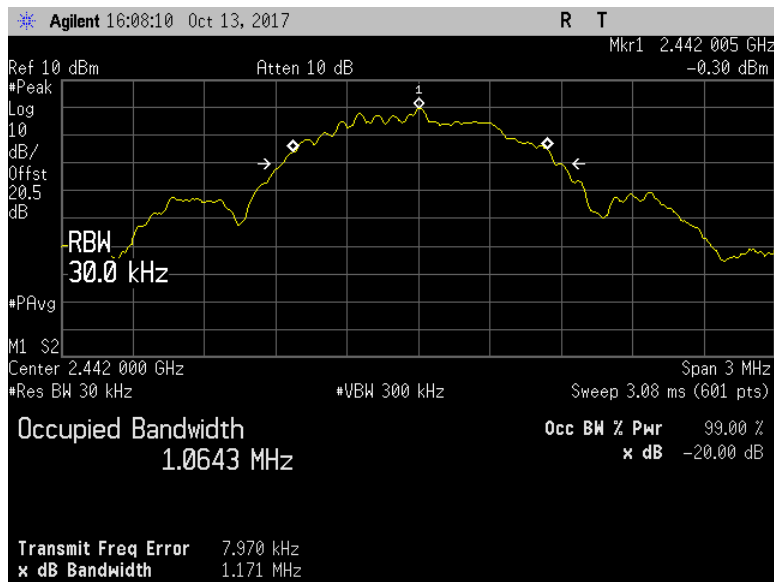

Figure 7.2.2-5: 99% OBW - Middle Channel

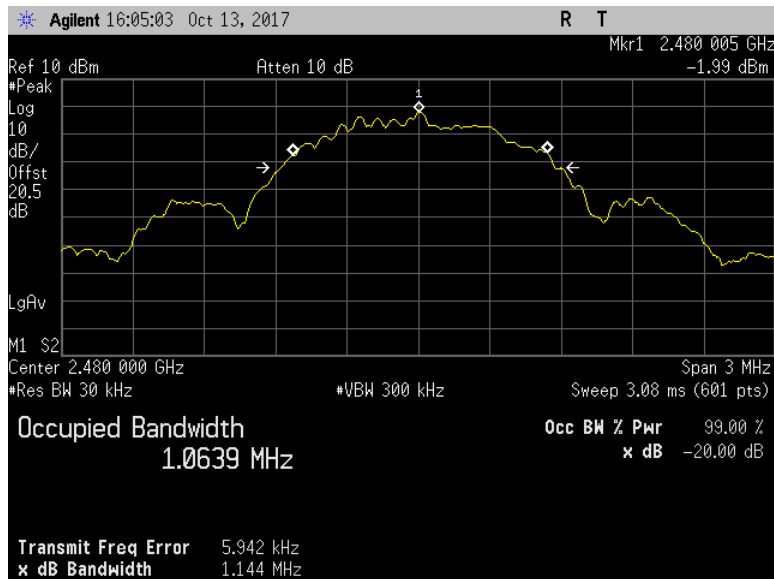

Figure 7.2.2-6: 99% OBW - High Channel

7.3 Peak Output Power – FCC: Section 15.247(b)(3); ISED Canada: RSS-247 5.4(d)

7.3.1 Measurement Procedure (Conducted Method)

The fundamental emission output power was measured in accordance with the FCC KDB 558074 D01 DTS Meas Guidance v04 Section 9.1.1 RBW ≥ DTS bandwidth. The RF output of the equipment under test was directly connected to the input of the spectrum analyzer through suitable attenuation.

7.3.2 Measurement Results

Performed by: Thierry Jean-Charles

Table 7.3.2-1: RF Output Power

Frequency (MHz)	Level (dBm)
2402	1.84
2442	2.95
2480	1.30

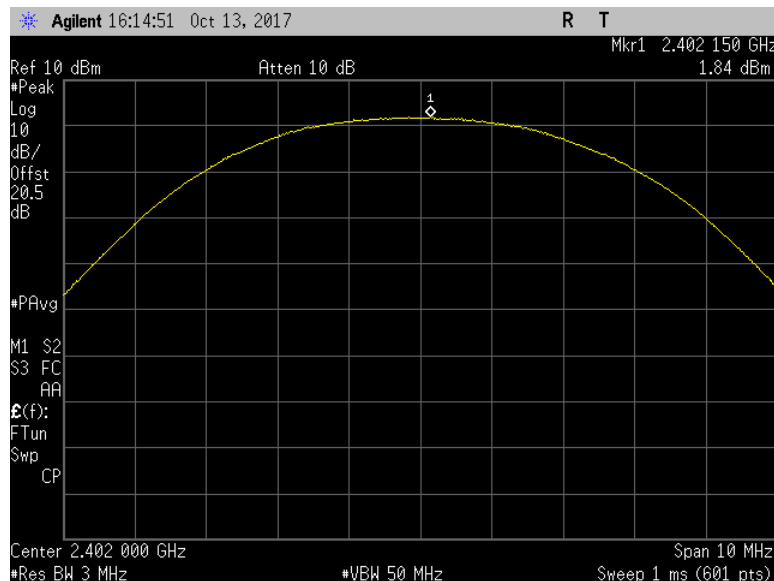

Figure 7.3.2-1: RF Output Power - Low Channel

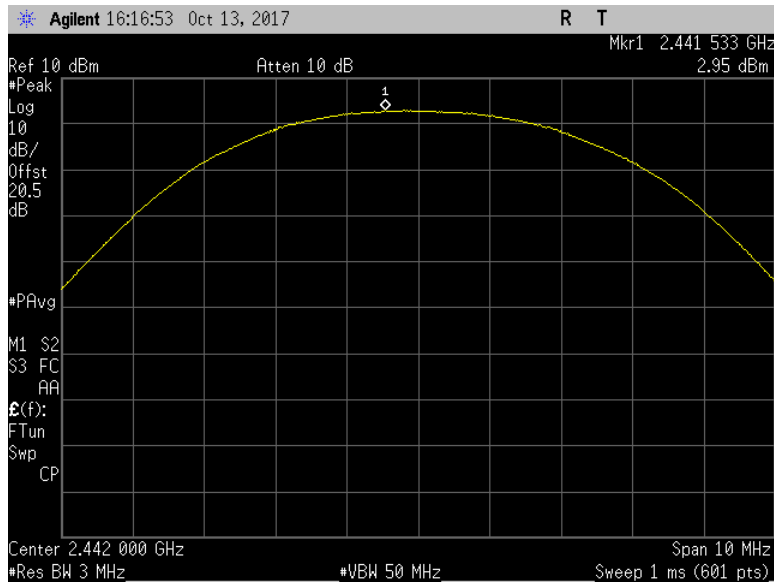

Figure 7.3.2-2: RF Output Power - Middle Channel

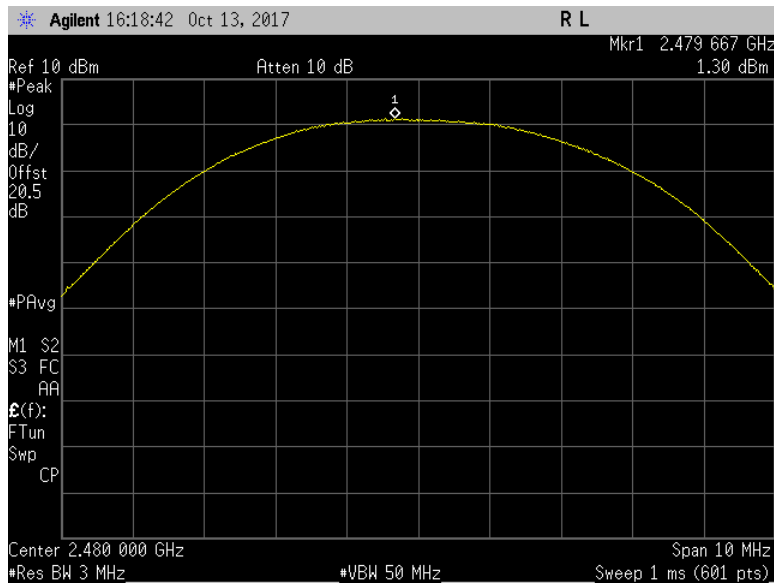

Figure 7.3.2-3: RF Output Power - High Channel

7.4 Band-Edge and Spurious Emissions

7.4.1 Band-Edge Compliance of RF Conducted Emissions – FCC: Section 15.247(d); ISED Canada: RSS-247 5.5

7.4.1.1 Measurement Procedure

The RF output port of the EUT was directly connected to the input of the spectrum analyzer via suitable attenuation. The EUT was investigated at the lowest and highest channel available to determine band-edge compliance. For each measurement, the spectrum analyzer’s RBW was set to 100 kHz, and the VBW was set to 50 MHz.

7.4.1.2 Measurement Results

Performed by: Thierry Jean-Charles

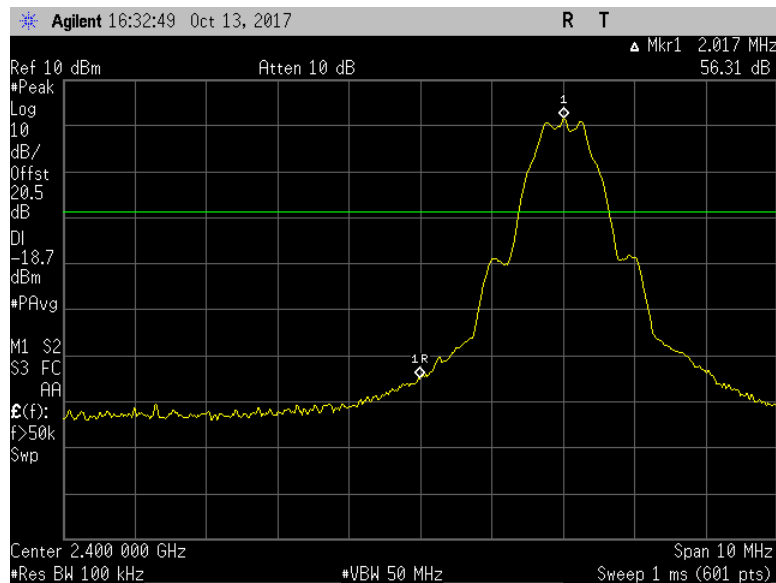

Figure 7.4.1.2-1: Lower Band-edge

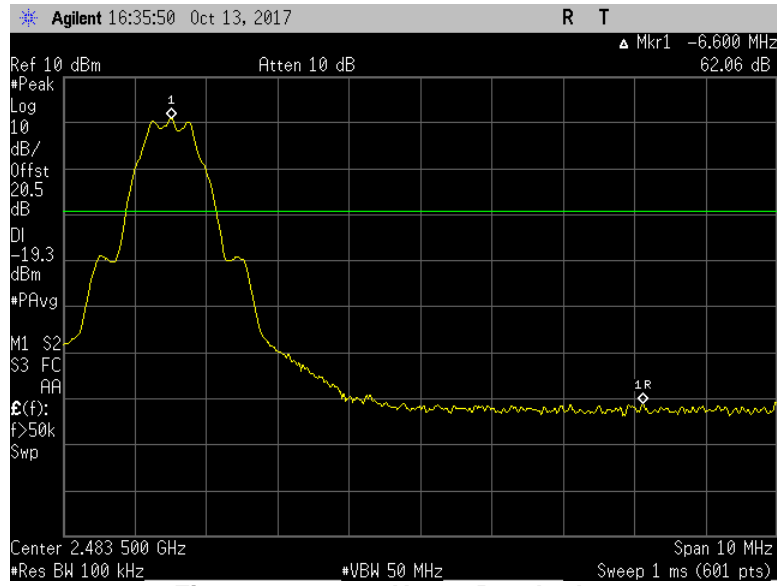

Figure 7.4.1.2-2: Upper Band-edge

7.4.2 RF Conducted Spurious Emissions – FCC: Section 15.247(d); ISED Canada: RSS-247 5.5

7.4.2.1 Measurement Procedure

The RF Conducted Spurious Emissions were measured in accordance with the FCC KDB 558074 D01 DTS Meas Guidance v04 Section 11.3 Emission level measurement. The RF output port of the equipment under test was directly connected to the input of the spectrum analyzer. The EUT was investigated for conducted spurious emissions from 30 MHz to 26 GHz, 10 times the highest fundamental frequency. Measurements were made at the low, center and high channels of the EUT. For each measurement, the spectrum analyzer’s RBW was set to 100 kHz and the VBW was set to 50 MHz. The peak Max Hold function of the analyzer was utilized. The reference level was determined by measuring the Peak PSD level in any 100-kHz bandwidth within the DTS channel bandwidth.

7.4.2.2 Measurement Results

Performed by: Thierry Jean-Charles

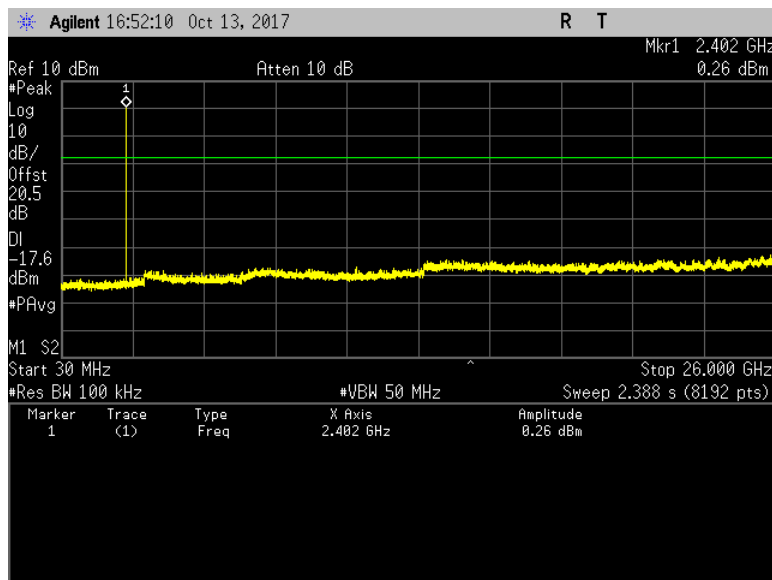

Figure 7.4.2.2-1: 30 MHz – 26 GHz – Low Channel

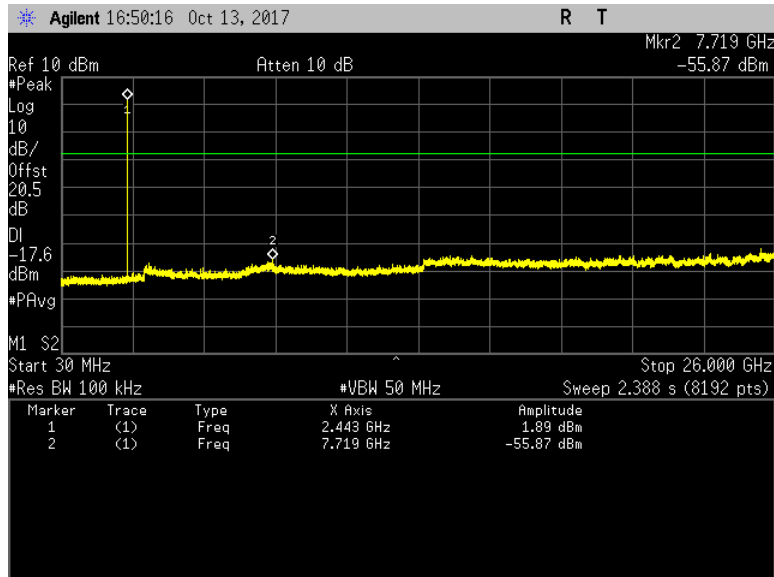

Figure 7.4.2.2-2: 30 MHz – 26 GHz – Middle Channel

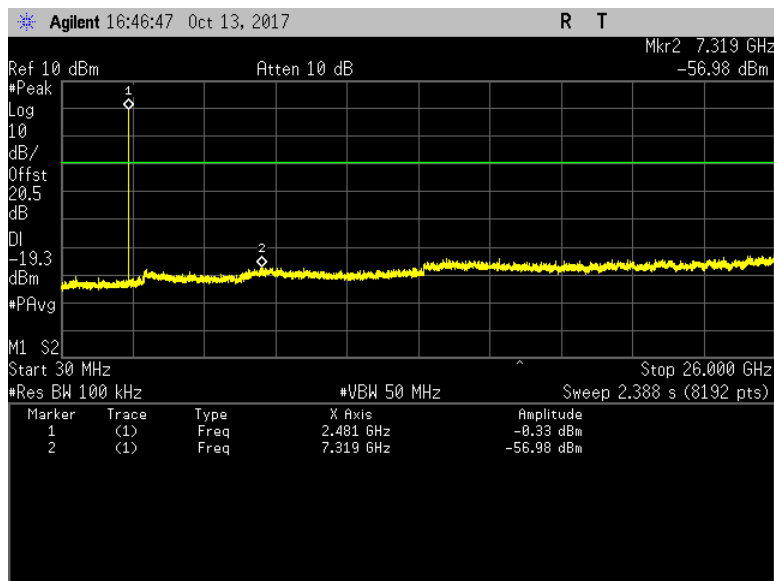

Figure 7.4.2.2-3: 30 MHz – 26 GHz – High Channel

7.4.3 Radiated Spurious Emissions into Restricted Frequency Bands – FCC: Sections 15.205, 15.209; ISED Canada: RSS-Gen 8.9, 8.10

7.4.3.1 Measurement Procedure

Radiated emissions tests were made over the frequency range of 9 kHz to 26 GHz, 10 times the highest fundamental frequency. Each emission found to be in a restricted band as defined by section 15.205, including any emission at the operational band-edge, was compared to the radiated emission limits as defined in Section 15.209.

For measurements below 30 MHz, the receive antenna height was set to 1m and the EUT was rotated through 360 degrees. The resolution bandwidth was set to 200 Hz below 150 kHz and to 9 kHz above 150 kHz.

The EUT was rotated through 360° and the receive antenna height was varied from 1m to 4m so that the maximum radiated emissions level would be detected. For frequencies below 1000 MHz, quasi-peak measurements were made using a resolution bandwidth RBW of 120 kHz and a video bandwidth VBW of 300 kHz. For frequencies above 1000 MHz, peak measurements are made with RBW of 1 MHz and VBW of 3 MHz. Average measurements are performed in the linear scale using VBW of 30 Hz.

7.4.3.2 Measurement Results

Performed by: Jean Rene

Radiated band-edge and spurious emissions found in the restricted frequency bands of 9 kHz to 26 GHz are reported in the tables below.

Table 7.4.3.2-1: Radiated Spurious Emissions Tabulated Data

Frequency (MHz)	Level (dBuV)		Antenna Polarity (H/V)	Correction Factors (dB)	Corrected Level (dBuV/m)		Limit (dBuV/m)		Margin (dB)	
	pk	Qpk/Avg			pk	Qpk/Avg	pk	Qpk/Avg	pk	Qpk/Avg
Low Channel										
4804	51.23	45.42	H	4.02	55.25	49.44	74.0	54.0	18.7	4.6
4804	50.92	44.39	V	4.02	54.94	48.41	74.0	54.0	19.1	5.6
Middle Channel										
4884	48.50	40.70	H	4.36	52.86	45.06	74.0	54.0	21.1	8.9
4884	49.56	42.14	V	4.36	53.92	46.50	74.0	54.0	20.1	7.5
High Channel										
2483.5	57.50	48.08	H	-4.51	52.99	43.57	74.0	54.0	21.0	10.4
2483.5	57.63	50.02	V	-4.51	53.12	45.51	74.0	54.0	20.9	8.5
4960	49.12	42.65	H	4.69	53.81	47.34	74.0	54.0	20.2	6.7
4960	48.40	41.91	V	4.69	53.09	46.60	74.0	54.0	20.9	7.4
7440	43.68	32.03	H	9.72	53.40	41.75	74.0	54.0	20.6	12.3
7440	43.79	32.29	V	9.72	53.51	42.01	74.0	54.0	20.5	12.0

Notes:

All emissions above 7.44 GHz were attenuated below the limits and the noise floor of the measurement equipment.

7.4.4 Sample Calculation:

$$R_C = R_U + CF_T$$

Where:

 $CF_T =$ Total Correction Factor (AF+CA+AG)-DC (Average Measurements Only) $R_U =$ Uncorrected Reading $R_C =$ Corrected Level $AF =$ Antenna Factor $CA =$ Cable Attenuation $AG =$ Amplifier Gain $DC =$ Duty Cycle Correction Factor**Example Calculation: Peak**Corrected Level: $51.23 + 4.02 = 55.25$ dB μ V/mMargin: 74 dB μ V/m $- 55.25$ dB μ V/m = 18.7 dB**Example Calculation: Average**Corrected Level: $45.42 + 4.02 = 49.44$ dB μ V/mMargin: 54 dB μ V/m $- 49.44$ dB μ V/m = 4.6 dB

7.5 Power Spectral Density – FCC: Section 15.247(e); ISED Canada: RSS-247 5.2(b)

7.5.1 PSD Measurement Procedure (Conducted Method)

The power spectral density was measured in accordance with the FCC KDB 558074 D01 DTS Meas Guidance v04 Section 10.2 Method PKPSD (peak PSD). The RF output port of the EUT was directly connected to the input of the spectrum analyzer. Offset values were input for cable and external attenuation. The spectrum analyzer RBW was set to 3 kHz and VBW 10 kHz. Span was adjusted to 1.5 times the DTS bandwidth and the sweep time was set to auto.

7.5.2 Measurement Results

Performed by: Thierry Jean-Charles

Results are shown below.

Table 7.5.2-1: Power Spectral Density

Frequency (MHz)	PSD (dBm)	Limit (dBm)	Margin (dB)
2402	-13.63	8	21.63
2442	-12.46	8	20.46
2480	-14.15	8	22.15

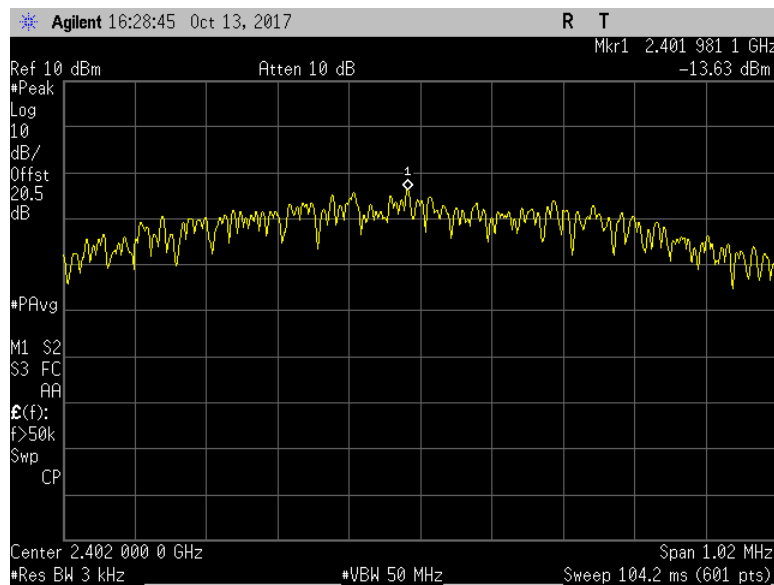

Figure 7.5.2-1: Power Spectral Density - Low Channel

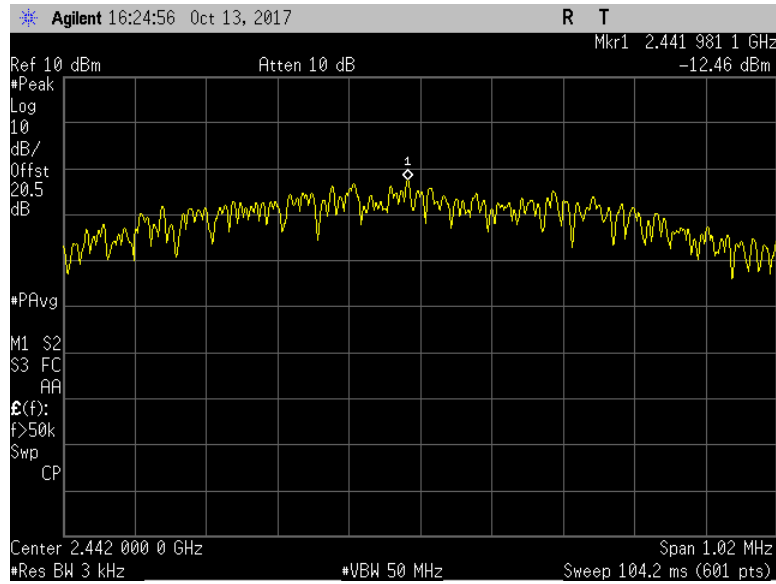

Figure 7.5.2-2: Power Spectral Density - Middle Channel

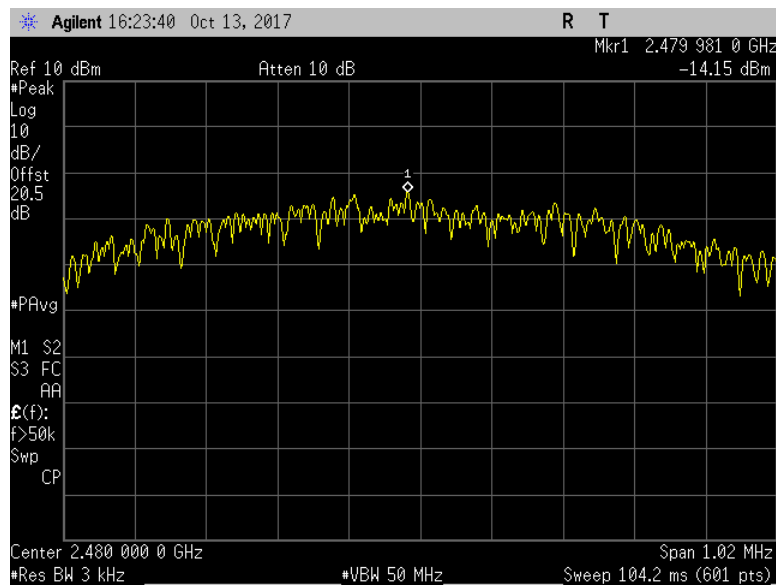

Figure 7.5.2-3: Power Spectral Density – High Channel

7.6 Power Line Conducted Emissions – FCC: Section 15.207; ISED Canada: RSS-Gen 8.8

7.6.1 Measurement Procedure

ANSI C63.10 section 6.2 was the guiding document for this evaluation. Conducted emissions were performed from 150 kHz to 30 MHz with the spectrum analyzer’s resolution bandwidth set to 9 kHz and the video bandwidth set to 30 kHz. The calculation for the conducted emissions is as follows:

$$\text{Corrected Reading} = \text{Analyzer Reading} + \text{LISN Loss} + \text{Cable Loss}$$

$$\text{Margin} = \text{Applicable Limit} - \text{Corrected Reading}$$

7.6.2 Measurement Results

Performed by: Thierry Jean-Charles

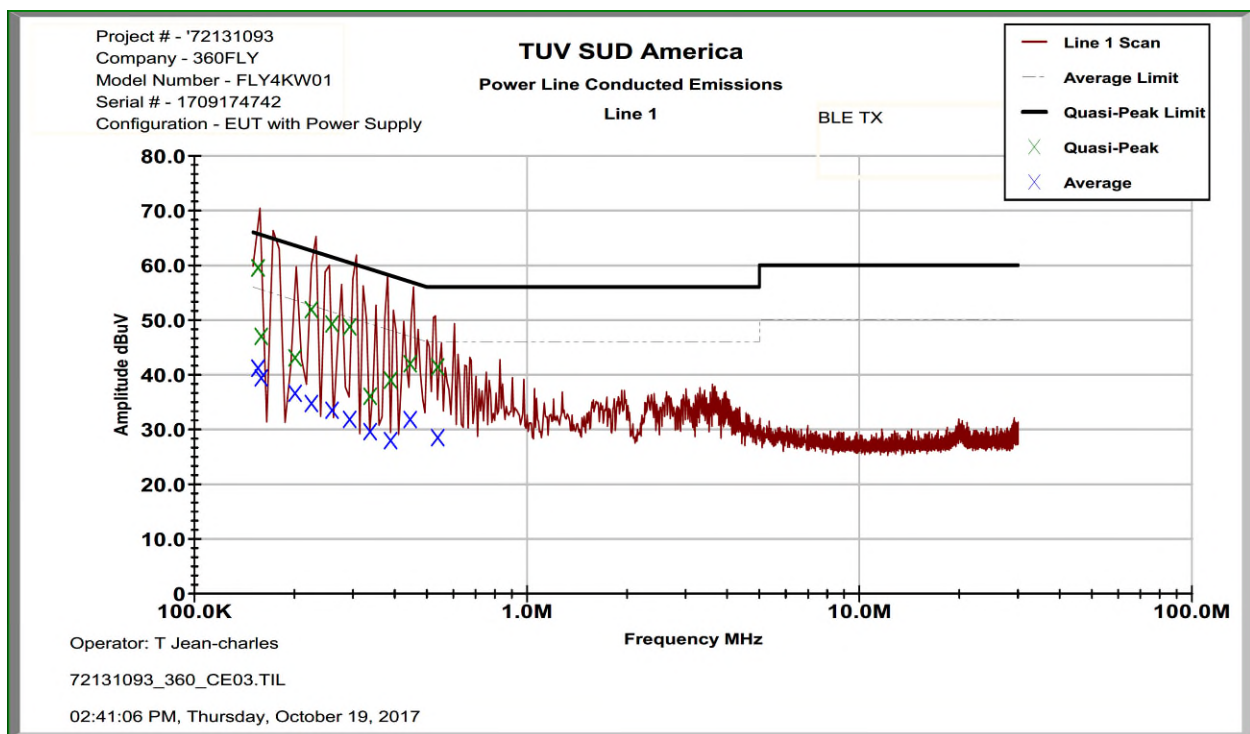

Figure 7.6.2-1: Conducted Emissions Results – Line 1

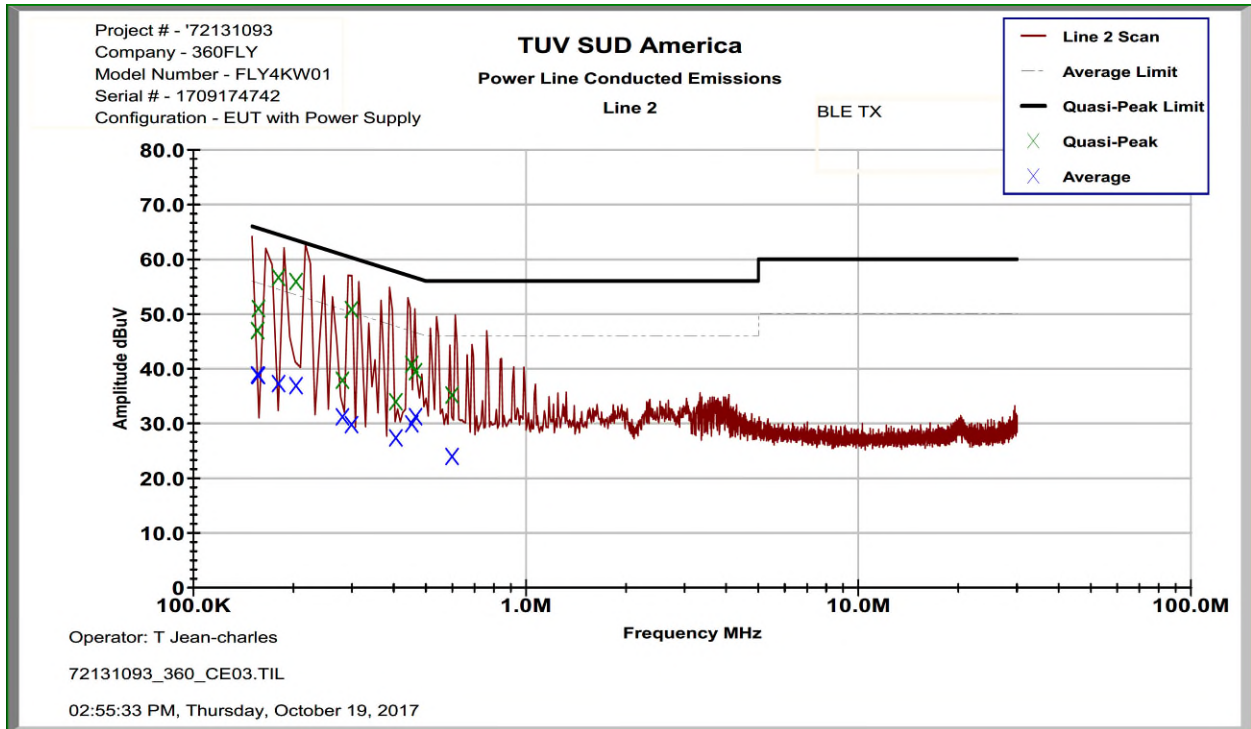

Figure 7.6.2-2: Conducted Emissions Results – Line 2

Table 7.6.2-1: Conducted EMI Results

Line 1 Line 2 Line 3
 Line 4
 To Ground Floating
 Telecom Port _____
 dBµV dBµA

Plot Number:
 72131093 360 CE03
Power Supply Description: 5
 VDC Power Supply

Frequency (MHz)	Uncorrected Reading		Total Correction Factor (dB)	Corrected Level		Limit		Margin (dB)	
	Quasi-Peak	Average		Quasi-Peak	Average	Quasi-Peak	Average	Quasi-Peak	Average
Line 1									
0.155275	49.177	30.864	10.17	59.35	41.04	65.71	55.71	6.4	14.7
0.158837	36.683	29.082	10.17	46.86	39.26	65.52	55.52	18.7	16.3
0.200487	32.772	26.268	10.18	42.95	36.45	63.59	53.59	20.6	17.1
0.224637	41.561	24.415	10.18	51.75	34.60	62.65	52.65	10.9	18.0
0.259325	38.934	23.157	10.18	49.12	33.34	61.45	51.45	12.3	18.1
0.293063	38.399	21.512	10.19	48.59	31.70	60.44	50.44	11.9	18.7
0.337638	25.717	19.246	10.21	35.93	29.45	59.26	49.26	23.3	19.8
0.388738	28.657	17.603	10.21	38.87	27.81	58.09	48.09	19.2	20.3
0.444812	31.617	21.44	10.23	41.85	31.67	56.97	46.97	15.1	15.3
0.538588	31.055	18.112	10.21	41.27	28.32	56.00	46.00	14.7	17.7
Line 2									
0.155934	36.683	28.57	10.22	46.91	38.79	65.68	55.68	18.8	16.9
0.156697	40.684	28.436	10.22	50.91	38.66	65.64	55.64	14.7	17.0
0.180262	46.372	26.953	10.22	56.60	37.18	64.47	54.47	7.9	17.3
0.203312	45.594	26.585	10.23	55.83	36.82	63.47	53.47	7.6	16.7
0.280638	27.567	20.874	10.23	37.80	31.11	60.80	50.80	23.0	19.7
0.298574	40.497	19.469	10.24	50.73	29.71	60.28	50.28	9.5	20.6
0.4061	23.621	17.015	10.27	33.89	27.28	57.73	47.73	23.8	20.4
0.453488	30.444	19.586	10.27	40.71	29.86	56.81	46.81	16.1	17.0
0.465225	29.105	20.903	10.27	39.38	31.17	56.60	46.60	17.2	15.4
0.598975	24.809	13.619	10.27	35.08	23.89	56.00	46.00	20.9	22.1

8 MEASUREMENT UNCERTAINTIES

The expanded laboratory measurement uncertainty figures (U_{Lab}) provided below correspond to an expansion factor (coverage factor) $k = 1.96$ which provide confidence levels of 95%.

Table 8-1: Measurement Uncertainties

Parameter	U_{lab}
Occupied Channel Bandwidth	$\pm 0.009 \%$
RF Conducted Output Power	$\pm 1.15 \text{ dB}$
Power Spectral Density	$\pm 1.15 \text{ dB}$
Antenna Port Conducted Emissions	$\pm 1.15 \text{ dB}$
Radiated Emissions $\leq 1\text{GHz}$	$\pm 5.86 \text{ dB}$
Radiated Emissions $> 1\text{GHz}$	$\pm 4.65 \text{ dB}$
Temperature	$\pm 0.860 \text{ }^\circ\text{C}$
Radio Frequency	$\pm 2.832 \times 10^{-8}$
AC Power Line Conducted Emissions	$\pm 3.72 \text{ dB}$

9 CONCLUSION

In the opinion of TÜV SÜD America, Inc. the models FLY4KW01 and FLY4KW11, manufactured by 360fly, Inc., meets the requirements of FCC Part 15.247 and Industry Canada's Radio Standards Specification RSS-247 for the tests documented herein.

END REPORT