



Certification Test Report

**FCC ID: 2ADDKFLY4KW01
IC: 12404A-FLY4KW01**

**FCC Rule Part: 15.247
ISED Canada's Radio Standards Specification: RSS-247**

Report Number: BO72131093.301

Applicant: 360fly, Inc.

Model(s): FLY4KW01

Test Begin Date: **September 28, 2017**
Test End Date: **October 24, 2017**

Report Issue Date: November 6, 2017



FOR THE SCOPE OF ACCREDITATION UNDER CERTIFICATE NUMBER AT-1533

This report must not be used by the client to claim product certification, approval, or endorsement by ANAB, ANSI, or any agency of the Federal Government.

Prepared by:

A handwritten signature in black ink, appearing to read 'Thierry Jean-Charles'.

**Thierry Jean-Charles
Team Lead
TÜV SÜD America, Inc.**

Reviewed by:

A handwritten signature in black ink, appearing to read 'Ryan McGann'.

**Ryan McGann
Senior Engineer
TÜV SÜD America, Inc.**

This test report shall not be reproduced except in full. This report may be reproduced in part with prior written consent of TÜV SÜD America, Inc. The results contained in this report are representative of the sample(s) submitted for evaluation.

This report contains 70 pages

TABLE OF CONTENTS

1	GENERAL	3
1.1	Purpose	3
1.2	Applicant Information	3
1.3	Product Description	3
1.4	Test Methodology and Considerations	3
2	TEST FACILITIES	5
2.1	Location	5
2.2	Laboratory Accreditations/Recognitions/Certifications.....	5
2.3	Radiated & Conducted Emissions Test Site Description	6
2.3.1	Semi-Anechoic Chamber Test Site	6
2.3.2	Conducted Emissions Test Site Description.....	7
3	APPLICABLE STANDARD REFERENCES	8
4	LIST OF TEST EQUIPMENT	9
5	SUPPORT EQUIPMENT	10
6	EQUIPMENT UNDER TEST SETUP BLOCK DIAGRAM.....	11
7	SUMMARY OF TESTS.....	12
7.1	Antenna Requirement – FCC: Section 15.203.....	12
7.2	6 dB Bandwidth - FCC: Section 15.247(a)(2); ISED Canada: RSS-247 5.2(a); 99% Bandwidth ISED Canada: RSS-GEN 6.6.....	12
7.2.1	Measurement Procedure	12
7.2.2	Measurement Results	12
7.3	Peak Output Power – FCC: Section 15.247(b)(3); ISED Canada: RSS-247 5.4(d)	25
7.3.1	Measurement Procedure (Conducted Method)	25
7.3.2	Measurement Results	25
7.4	Band-Edge and Spurious Emissions	33
7.4.1	Band-Edge Compliance of RF Conducted Emissions – FCC: Section 15.247(d); ISED Canada: RSS-247 5.5.....	33
7.4.2	RF Conducted Spurious Emissions – FCC: Section 15.247(d); ISED Canada: RSS-247 5.5.....	38
7.4.3	Radiated Spurious Emissions into Restricted Frequency Bands – FCC: Sections 15.205, 15.209; ISED Canada: RSS-Gen 8.9, 8.10	51
7.4.4	Sample Calculation	54
7.5	Power Spectral Density – FCC: Section 15.247(e); ISED Canada: RSS-247 5.2(b)	55
7.5.1	PSD Measurement Procedure (Conducted Method).....	55
7.5.2	Measurement Results	55
7.6	Power Line Conducted Emissions – FCC: Section 15.207; ISED Canada: RSS-Gen 8.8.....	63
7.6.1	Measurement Procedure.....	63
7.6.2	Measurement Results	63
7.7	Duty Cycle	66
7.7.1	Measurement Procedure.....	66
7.7.2	Measurement Results	66
8	MEASUREMENT UNCERTAINTIES	69
9	CONCLUSION.....	70

1 GENERAL

1.1 Purpose

The purpose of this report is to demonstrate compliance with Part 15 Subpart C of the FCC's Code of Federal Regulations Section 15.247 and Innovation Science and Economic Development Canada's Radio Standards Specification RSS-247 for the tests documented herein.

1.2 Applicant Information

360fly, Inc.
1975 East Sunrise Blvd., Suite 400
Fort Lauderdale, FL 33304

1.3 Product Description

The 360fly, Inc. model FLY4KW01 is an in-vehicle video solution with complete 360-degree coverage. The device provides Bluetooth and 2.4/5 GHz Wi-Fi connectivity. This test report documents the compliance of the 2.4 GHz Wi-Fi Transmitter.

Technical Details

Mode of Operation:	IEEE 802.11b/g/n
Frequency Range:	802.11b/g/n 20 MHz: 2412 MHz - 2462 MHz 802.11n 40 MHz: 2422 MHz -2452 MHz
Number of Channels:	802.11b/g/n 20 MHz: 11 802.11n 40 MHz: 9
Channel Separation:	5 MHz
Modulations:	802.11b: CCK, DSSS 802.11g/n: OFDM
Antenna Type/Gain:	Loop with parasitic antenna, -0.15 dBi
Input Power:	5 VDC USB, 4 VDC Dock.

Model Number: FLY4KW01

Test Sample Serial Number(s): 1708174355 (RF Conducted Measurements), 1709174742 (Radiated and Power Line Conducted Emissions).

Test Sample Condition: The samples were in good operating condition with no physical damages.

1.4 Test Methodology and Considerations

The EUT was evaluated for RF Conducted, Radiated and Power Line Conducted emissions. All the available data rates were investigated. Where applicable, the data rate leading to the highest emissions with respect to the limits are reported.

Preliminary radiated emission measurements were performed for the EUT standalone, the EUT powered via USB and the EUT set within the dock. Additionally, the EUT worst position with respect to the ground plane was investigated as well. The configuration with the dock led to the highest emissions. The EUT set sideways on the table top was determined as the worst case orientation for the band-edge measurements while the EUT flat on the table top led to the highest spurious emissions. The results reported correspond to these two configurations.

The RF conducted measurements were performed on a sample modified with a temporary RF connector to allow direct coupling to the spectrum analyzer.

The power line conducted emission measurements were performed on the EUT powered via USB using an off-the-shelf power supply.

The EUT was also investigated for compliance to the unintentional emission requirements. The results are documented in a verification test report.

Table 1.4-1: IEEE 802.11b/g/n Radio Test Configuration

Mode of Operation	Frequency (MHz)	Channel	Test Software Power Setting	Data Rate Configuration (Mbps)
802.11b	2412	1	14	1
	2437	6		
	2462	11		
802.11g	2412	1	14	6
	2437	6		
	2462	11		
802.11n 20 MHz	2412	1	14	6.5 / 52
	2437	6		
	2462	11		
802.11n 40 MHz	2422	3	12	27
	2437	6		
	2452	9		

Note: For the 802.11n 20 MHz mode, the highest RF output power was obtained with 52 Mbps. That data rate was used for all the RF conducted measurements. The worst case radiated emissions measurements were obtained using the 6.5 Mbps and the results are reported accordingly.

2 TEST FACILITIES

2.1 Location

The radiated and conducted emissions test sites are located at the following address:

TÜV SÜD America, Inc.
3998 FAU Blvd, Suite 310
Boca Raton, Florida 33431
Phone: (561) 961-5585
Fax: (561) 961-5587
<http://www.tuv-sud-america.com>

2.2 Laboratory Accreditations/Recognitions/Certifications

TÜV SÜD America, Inc. is accredited to ISO/IEC 17025 by ANSI-ASQ National Accreditation Board under their ANAB program and has been issued certificate number AT-1533 in recognition of this accreditation. Unless otherwise specified, all test methods described within this report are covered under the ISO/IEC 17025 scope of accreditation.

FCC Test Firm Registration #: 475089
Innovation, Science and Economic Development Canada Lab Code: 4175C

2.3 Radiated & Conducted Emissions Test Site Description

2.3.1 Semi-Anechoic Chamber Test Site

The EMC radiated test facility consists of an RF-shielded enclosure. The interior dimensions of the indoor semi-anechoic chamber are approximately 48 feet (14.6 m) long by 36 feet (10.8 m) wide by 24 feet (7.3 m) high and consist of rigid, 1/8 inch (0.32 cm) steel-clad, wood core modular panels with steel framing. In the shielded enclosure, the faces of the panels are galvanized and the chamber is self-supporting. 8-foot RF absorbing cones are installed on 4 walls and the ceiling. The steel-clad ground plane is covered with vinyl flooring.

The turntable is driven by pneumatic motor, which can support a 2000 lb. load. The turntable is flush with the chamber floor which it is connected to, around its circumference, with a continuous metallic loaded spring. An EMCO Model 1060 Multi-device controller controls the turntable position.

A pneumatic motor is used to control antenna polarizations and height relative to the ground. The height information is displayed on the control unit EMCO Model 1050.

The control room is an RF shielded enclosure attached to the semi-anechoic chamber with two bulkhead panels for connecting RF, and control cables. The dimension of the room is 7.3 m x 4.9 m x 3 m high and the entrance doors of both control and conducted rooms are 3 feet (0.91 m) by 7 feet (2.13 m).

A diagram of the Semi-Anechoic Chamber Test Site is shown in Figure 2.3.1-1 below:

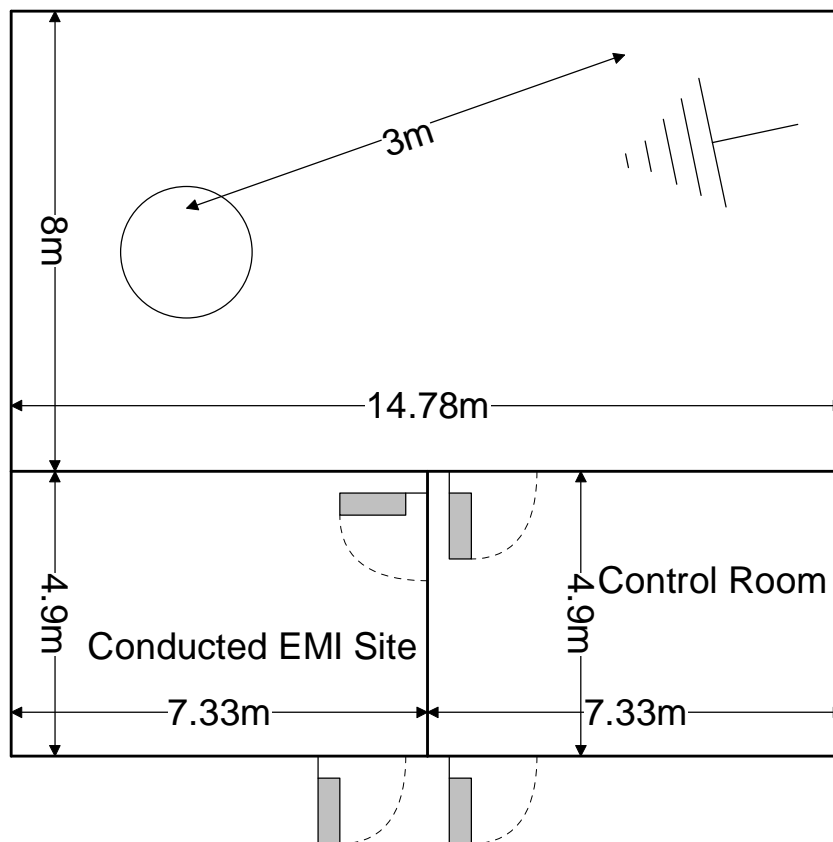

Figure 2.3.1-1: Semi-Anechoic Chamber Test Site

2.3.2 Conducted Emissions Test Site Description

The dimensions of the shielded conducted room are 7.3 x 4.9 x 3 m³. The power line conducted emission site includes two LISNs: a Solar Model 8028-50 50 Ω/50 μH and an EMCO Model 3825/2R, which are installed as shown in the figure below. For evaluations requiring 230 V, 50 Hz AC input, a Polarad LISN (S/N 879341/048) is used in conjunction with a California Instruments signal generator Model 2001RP-OP1.

A diagram of the room is shown below in figure 2.3.2-1:

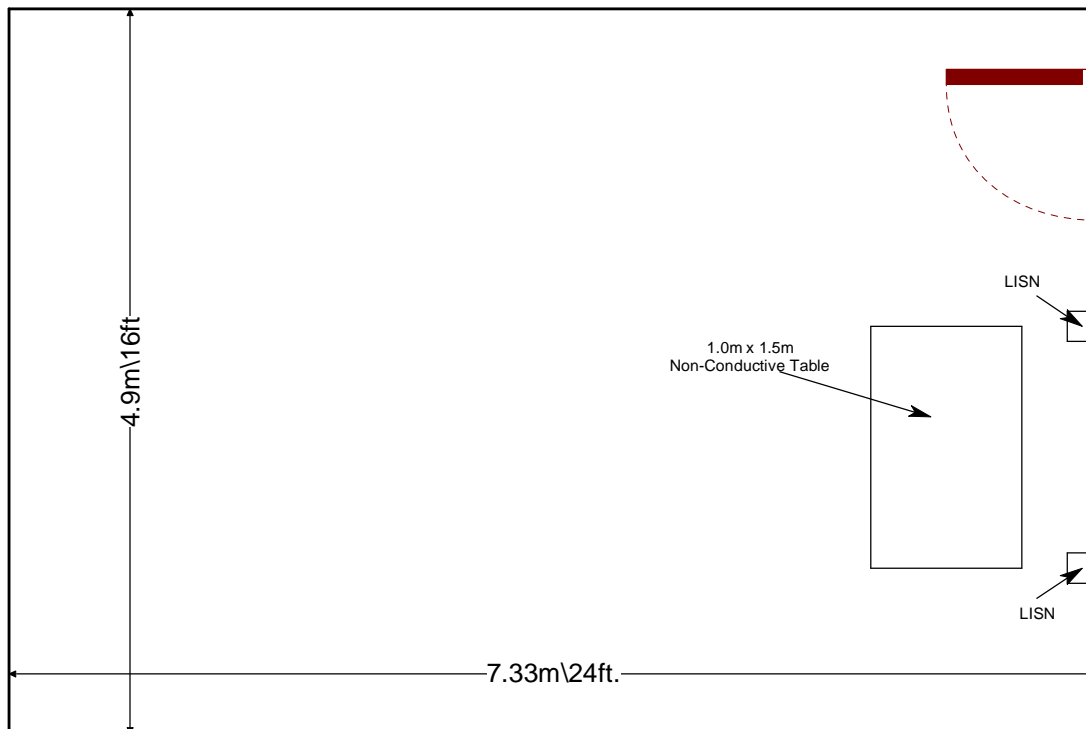

Figure 2.3.2-1: AC Mains Conducted EMI Site

3 APPLICABLE STANDARD REFERENCES

The following standards were used:

- ❖ ANSI C63.10-2013: American National Standard of Procedures for Compliance Testing of Unlicensed Wireless Devices
- ❖ US Code of Federal Regulations (CFR): Title 47, Part 2, Subpart J: Equipment Authorization Procedures, 2017.
- ❖ US Code of Federal Regulations (CFR): Title 47, Part 15, Subpart C: Radio Frequency Devices, Intentional Radiators, 2017
- ❖ FCC KDB 558074 D01 DTS Meas Guidance v04 - Guidance for Performing Compliance Measurements on Digital Transmission Systems (DTS) Operating Under 15.247, April 5, 2017.
- ❖ Innovation, Science and Economic Development Canada Radio Standards Specification: RSS-247 — Digital Transmission Systems (DTSs), Frequency Hopping Systems (FHSs) and Licence-Exempt Local Area Network (LE-LAN) Devices, Issue 2, February 2017.
- ❖ Innovation, Science and Economic Development Canada Radio Standards Specification: RSS-GEN – General Requirements for Compliance of Radio Apparatus, Issue 4, November 2014.

4 LIST OF TEST EQUIPMENT

The calibration interval of test equipment is annually or the manufacturer's recommendations. Where the calibration interval deviates from the annual cycle based on the instrument manufacturer's recommendations, it shall be stated below.

Table 4-1: Test Equipment List

AssetID	Manufacturer	Model #	Equipment Type	Serial #	Last Calibration Date	Calibration Due Date
282	Microwave Circuits	H2G020G4	Filters	74541	5/23/2017	5/23/2018
283	Rohde & Schwarz	FSP40	Spectrum Analyzers	1000033	7/21/2016	7/21/2018
479	Electro-Metrics	ALP-70	Antennas	158	12/3/2015	12/3/2017
523	Agilent	E7405	Spectrum Analyzers	MY45103293	12/9/2016	12/9/2018
653	Suhner	SF-102A	Cables	0944/2A	9/5/2017	9/5/2018
2002	EMCO	3108	Antennas	2147	11/19/2015	11/19/2017
2004	EMCO	3146	Antennas	1385	11/19/2015	11/19/2017
2006	EMCO	3115	Antennas	2573	4/7/2017	4/7/2019
2008	COM-Power	AH-826	Antennas	81009	NCR	NCR
2045	ACS Boca	Conducted Cable Set	Cable Set	2045	10/31/2016	10/31/2017
2082	Teledyne Storm Products	90-010-048	Cables	2082	4/7/2017	4/7/2018
2086	Merrimac	FAN-6-10K	Attenuators	23148-83-1	11/2/2016	11/2/2017
2089	Agilent Technologies, Inc.	83017A	Amplifiers	3123A00214	12/2/2016	12/2/2017
2095	ETS Lindgren	TILE4! - Version 4.2.A	Software	85242	NCR	NCR
2111	Aeroflex Inmet	40AH2W-20	Attenuator	2111	7/20/2017	7/20/2018
2112	Teledyne Storm Products	921-0101-036	Cables	12-06-698	11/2/2016	11/2/2017
2121	ACS Boca	Radiated Cable Set	Cable Set	2121	7/31/2017	7/31/2018
3004	Teseq	CFL 9206A	Attenuators	34720	8/29/2017	8/29/2018
TEMC00153	Rohde and Schwarz	ESH3-Z5	LISN	894785/012	9/27/2017	9/27/2018

Notes:

- **NCR=No Calibration Required**
- **The assets were only used during the active period of the calibration cycle.**

5 SUPPORT EQUIPMENT

Table 5-1: EUT and Support Equipment Description – Radiated Emissions

Item #	Type Device	Manufacturer	Model/Part #	Serial #
1	EUT	360fly, Inc.	FLY4KW01	1709174742
2	Car Cradle	360fly, Inc.	FLYCRD01	N/A
3	Cigarette Lighter Adapter (CLA)	N/A	N/A	N/A
4	Power Supply	MPJA	HY5003	3700278

Table 5-2: Cable Description – Radiated Emissions

Cable #	Cable Type	Length	Shield	Termination
A	DC Cable	2.05 m	No	CLA to EUT
B	DC Leads	2.9 m	No	CLA to Power Supply
C	Power Cord	2.3 m	No	Power Supply to AC Mains

Table 5-3: EUT and Support Equipment Description – Power Line Conducted Emissions

Item #	Type Device	Manufacturer	Model/Part #	Serial #
1	EUT	360fly, Inc.	FLY4KW01	1709174742
2	5 VDC Power Supply	VSN Mobil	C-P06	141119001574

Table 5-4: Cable Description – Power Line Conducted Emissions

Cable #	Cable Type	Length	Shield	Termination
A	USB Cable	0.98 m	No	EUT to Power Supply
B	Extension Cord	1.85 m	No	Power Supply to AC Mains

6 EQUIPMENT UNDER TEST SETUP BLOCK DIAGRAM

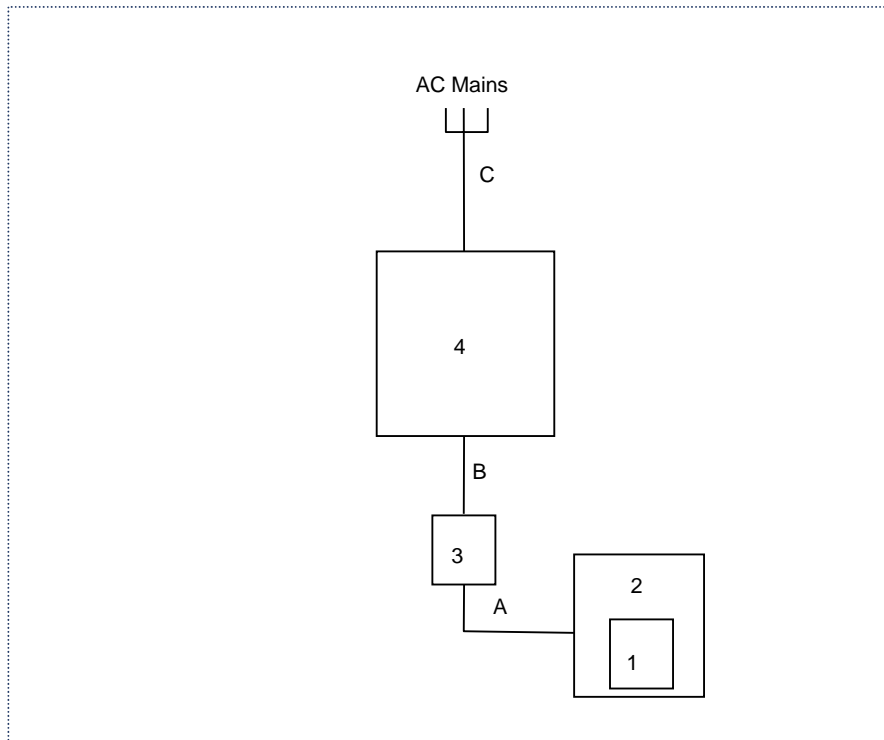

Figure 6-1: EUT and Support Equipment Block Diagram – Radiated Emissions

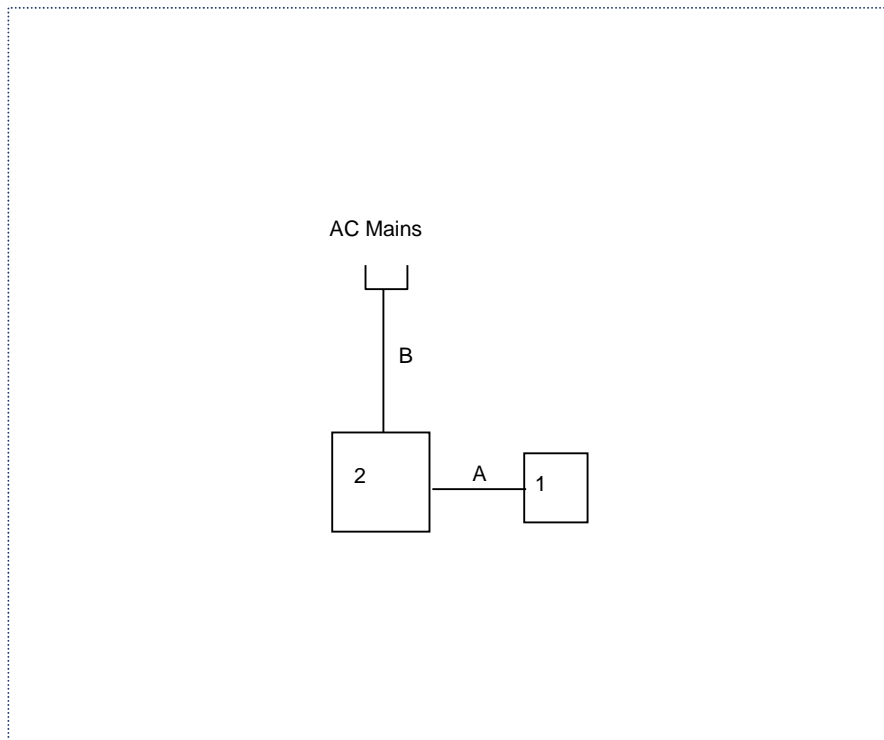

Figure 6-2: EUT and Support Equipment Block Diagram – Power Line Conducted Emissions

7 SUMMARY OF TESTS

Along with the tabular data shown below, plots were taken of all signals deemed important enough to document.

7.1 Antenna Requirement – FCC: Section 15.203

The EUT uses an internal -0.15 dBi loop with parasitic antenna that is connected to the main PCB via contact springs. The antenna is not replacable without damaging the equipment and therefore meets the requirements of FCC Section 15.203.

7.2 6 dB Bandwidth - FCC: Section 15.247(a)(2); ISED Canada: RSS-247 5.2(a); 99% Bandwidth ISED Canada: RSS-GEN 6.6

7.2.1 Measurement Procedure

The 6dB bandwidth was measured in accordance with the FCC KDB 558074 D01 DTS Meas Guidance v04 Section 8.1 Option 1. The RBW of the spectrum analyzer was set to 100 kHz and VBW 300 kHz. Span was set large enough to capture the emissions and >> RBW. A peak detector was used for the measurements.

The 99% occupied bandwidth was measured with the spectrum analyzer span set to fully display the emission. The RBW was set to 1% to 5% of the approximated bandwidth. The occupied 99% bandwidth was measured by using 99% bandwidth equipment function of the spectrum analyzer using a peak detector.

7.2.2 Measurement Results

Performed by: Thierry Jean-Charles

Table 7.2.2-1: 6dB / 99% Bandwidth – 802.11b

Frequency (MHz)	6dB Bandwidth (MHz)	99% Bandwidth (MHz)
2412	9.0250	13.5
2437	9.0175	13.3
2462	9.0300	13.4

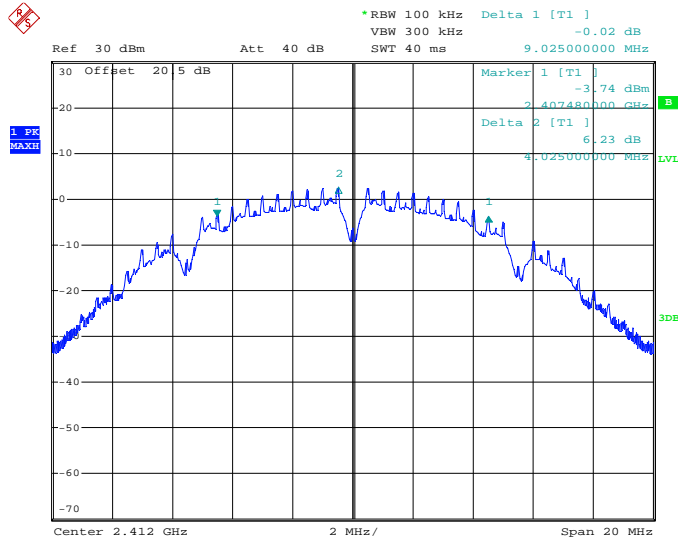

Date: 6.OCT.2017 17:06:32

Figure 7.2.2-1: 6dB BW - Low Channel - 802.11b

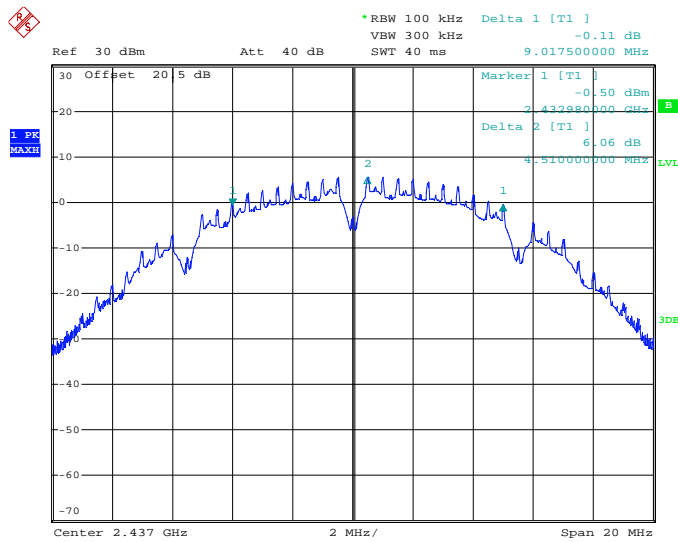

Date: 6.OCT.2017 16:53:53

Figure 7.2.2-2: 6dB BW - Middle Channel - 802.11b

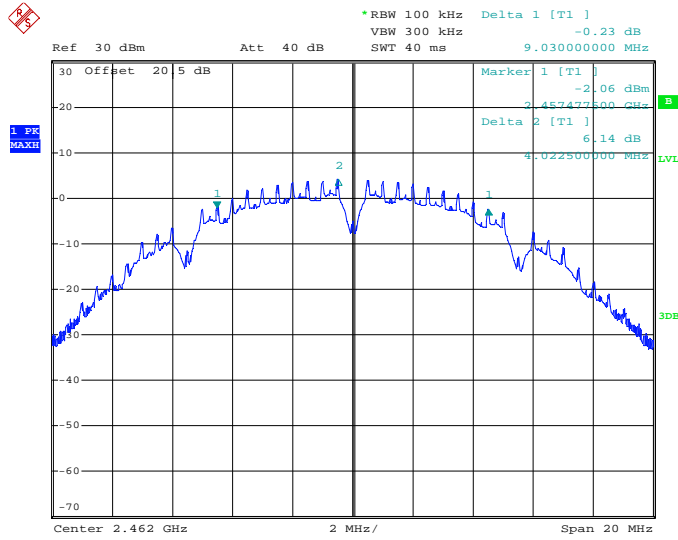

Date: 6.OCT.2017 17:22:10

Figure 7.2.2-3: 6dB BW - High Channel – 802.11b

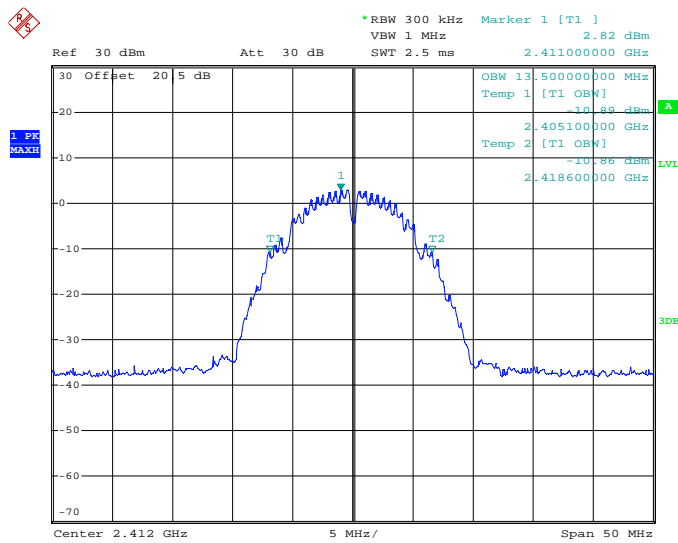

Date: 5.OCT.2017 21:12:08

Figure 7.2.2-4: 99% OBW - Low Channel - 802.11b

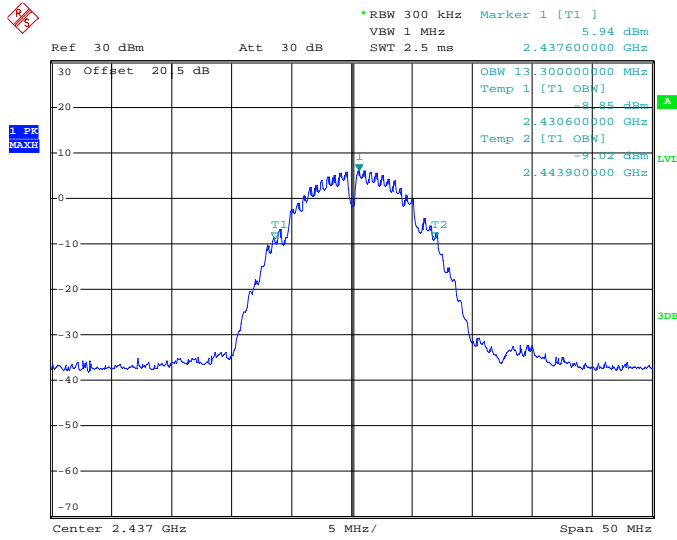

Date: 29.SEP.2017 13:53:48

Figure 7.2.2-5: 99% OBW - Middle Channel – 802.11b

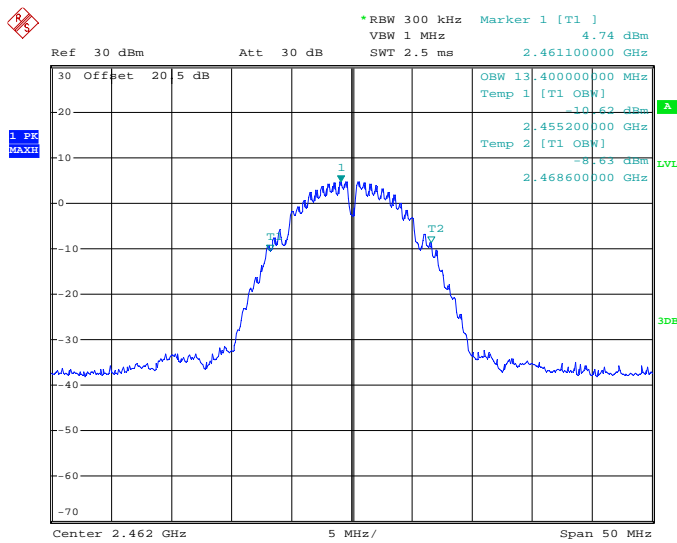

Date: 5.OCT.2017 21:20:42

Figure 7.2.2-6: 99% OBW - High Channel – 802.11b

Table 7.2.2-2: 6dB / 99% Bandwidth – 802.11g

Frequency (MHz)	6dB Bandwidth (MHz)	99% Bandwidth (MHz)
2412	16.3675	17.6
2437	16.1200	17.5
2462	16.3525	17.7

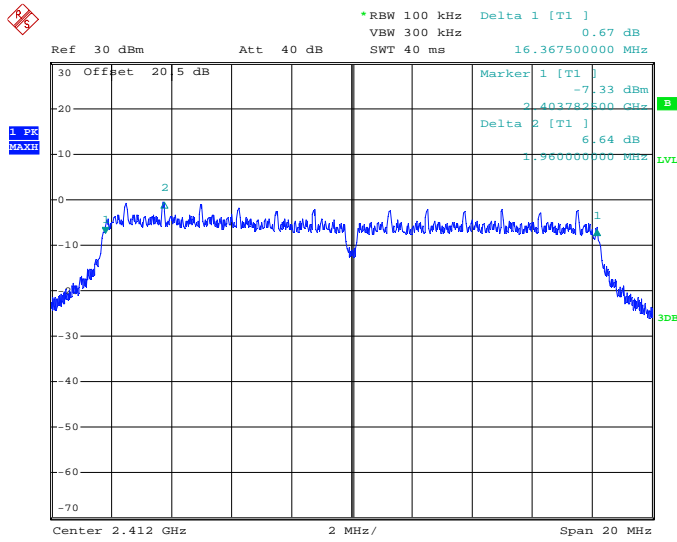

Date: 6.OCT.2017 15:19:45

Figure 7.2.2-7: 6dB BW - Low Channel - 802.11g

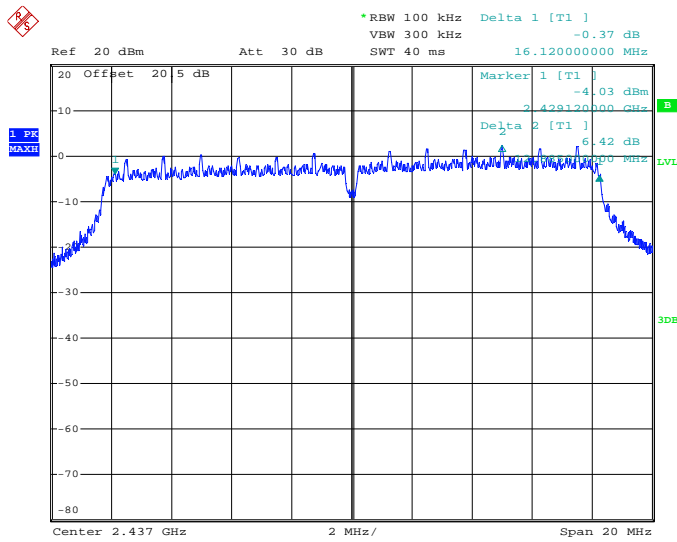

Date: 6.OCT.2017 14:53:11

Figure 7.2.2-8: 6dB BW - Middle Channel – 802.11g

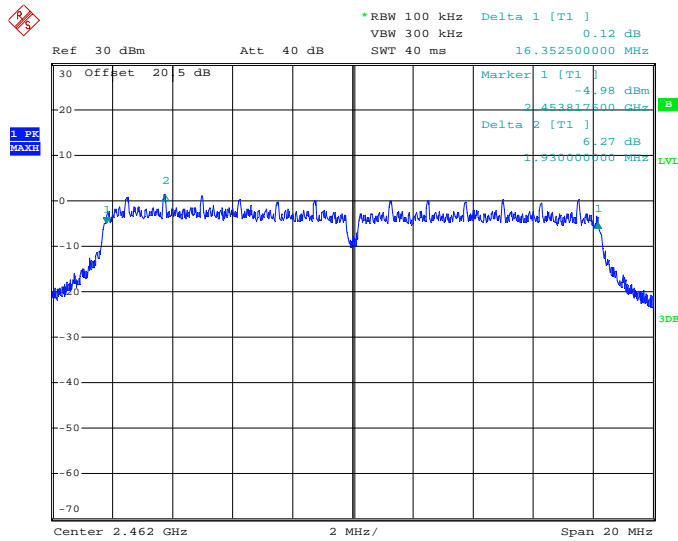

Date: 6.OCT.2017 16:32:31

Figure 7.2.2-9: 6dB BW - High Channel – 802.11g

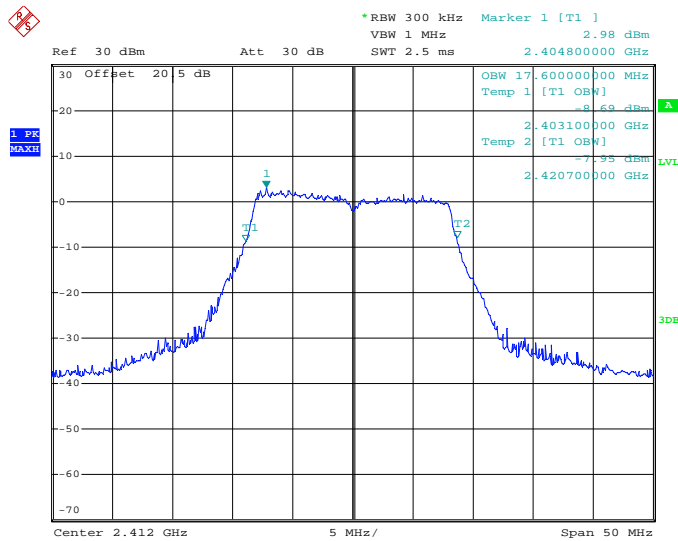

Date: 5.OCT.2017 21:38:16

Figure 7.2.2-10: 99% OBW - Low Channel - 802.11g

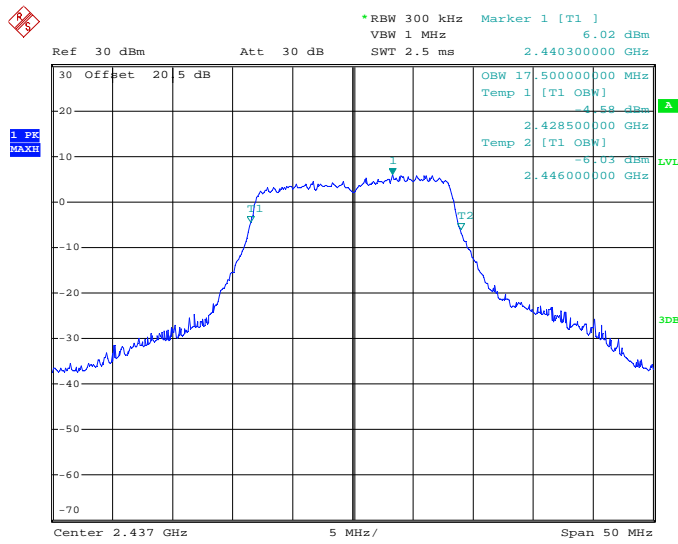

Date: 29.SEP.2017 16:01:07

Figure 7.2.2-11: 99% OBW - Middle Channel – 802.11g

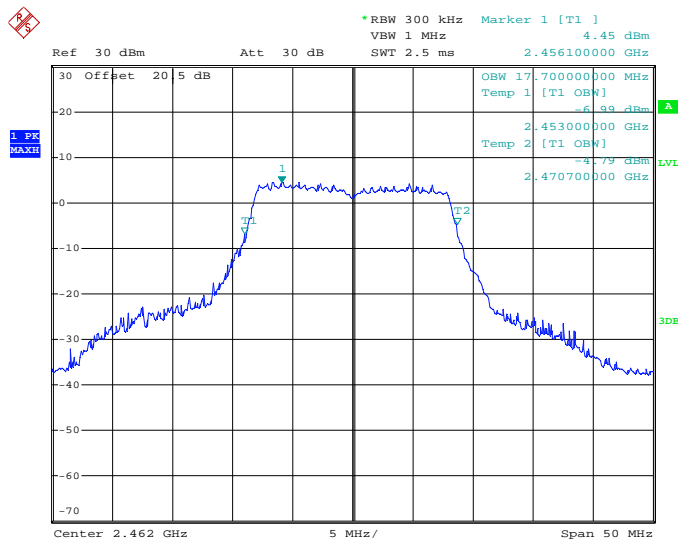

Date: 5.OCT.2017 21:41:23

Figure 7.2.2-12: 99% OBW - High Channel – 802.11g

Table 7.2.2-3: 6dB / 99% Bandwidth – 802.11n 20 MHz

Frequency (MHz)	6dB Bandwidth (MHz)	99% Bandwidth (MHz)
2412	17.7200	18.2
2437	17.6600	18.1
2462	17.7575	18.3

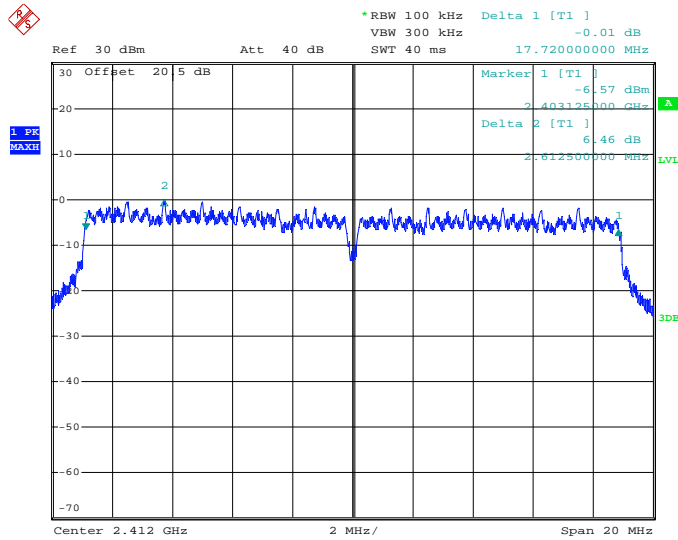

Date: 5.OCT.2017 23:06:25

Figure 7.2.2-13: 6dB BW - Low Channel - 802.11n 20 MHz

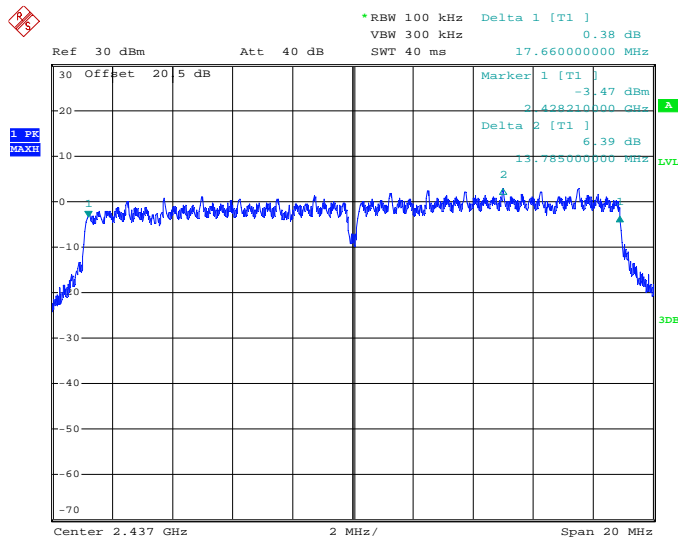

Date: 5.OCT.2017 22:58:14

Figure 7.2.2-14: 6dB BW - Middle Channel – 802.11n 20 MHz

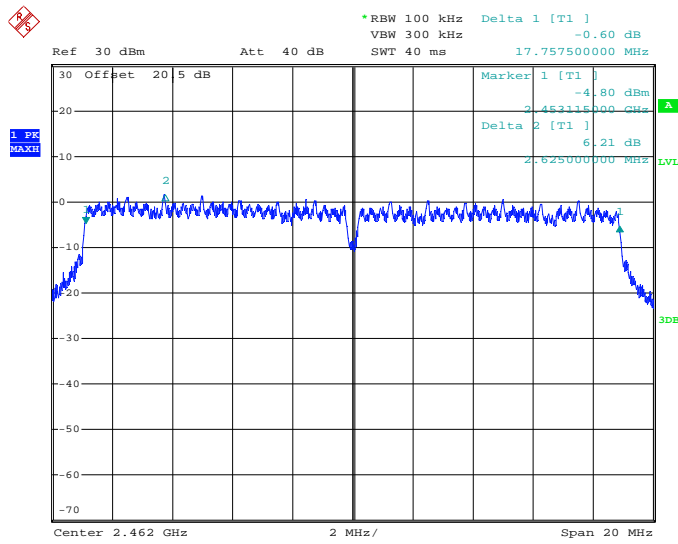

Date: 5.OCT.2017 23:17:05

Figure 7.2.2-15: 6dB BW - High Channel – 802.11n 20 MHz

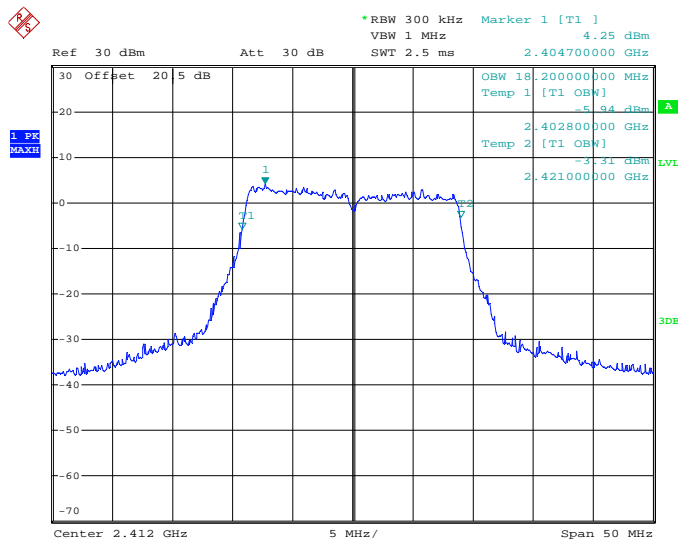

Date: 5.OCT.2017 21:55:33

Figure 7.2.2-16: 99% OBW - Low Channel - 802.11n 20 MHz

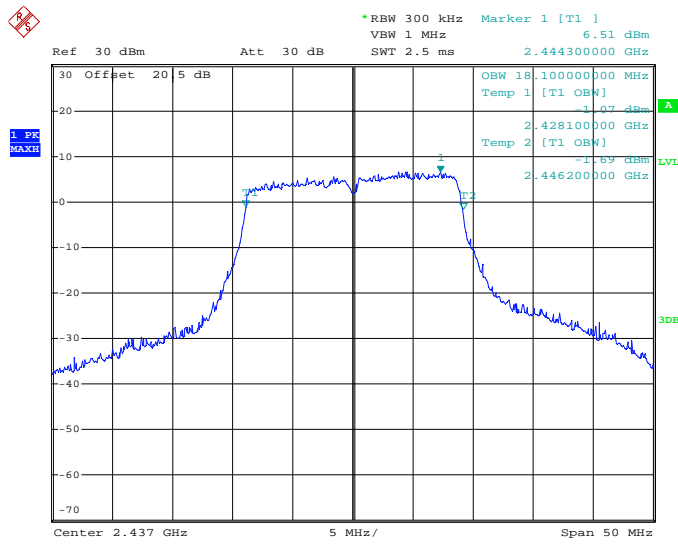

Date: 5.OCT.2017 21:48:38

Figure 7.2.2-17: 99% OBW - Middle Channel – 802.11n 20 MHz

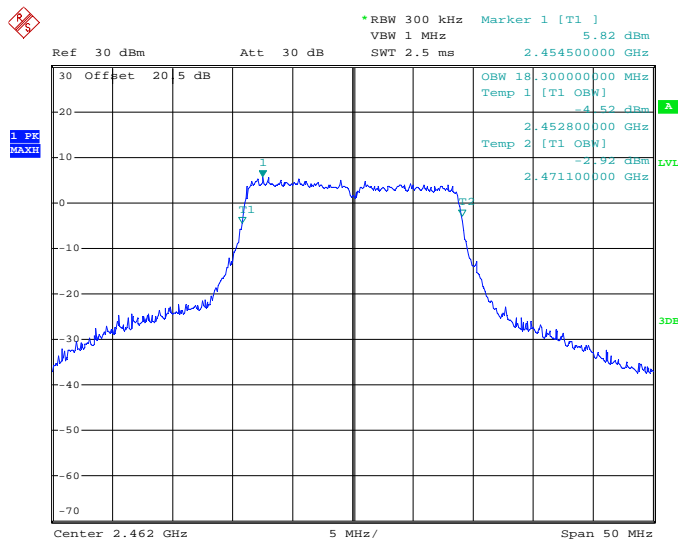

Date: 5.OCT.2017 21:58:44

Figure 7.2.2-18: 99% OBW - High Channel – 802.11n 20 MHz

Table 7.2.2-4: 6dB / 99% Bandwidth – 802.11n 40 MHz

Frequency (MHz)	6dB Bandwidth (MHz)	99% Bandwidth (MHz)
2422	36.005	37.800
2437	35.080	36.800
2452	35.107	36.800

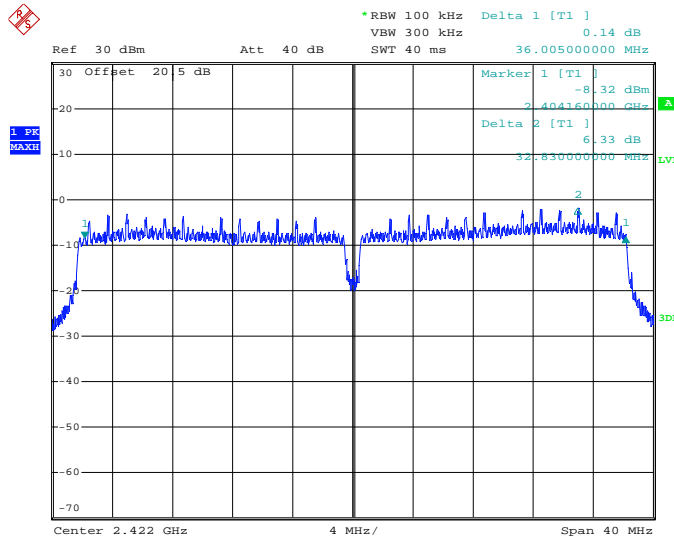

Date: 18.OCT.2017 20:16:06

Figure 7.2.2-19: 6dB BW - Low Channel - 802.11n 40 MHz

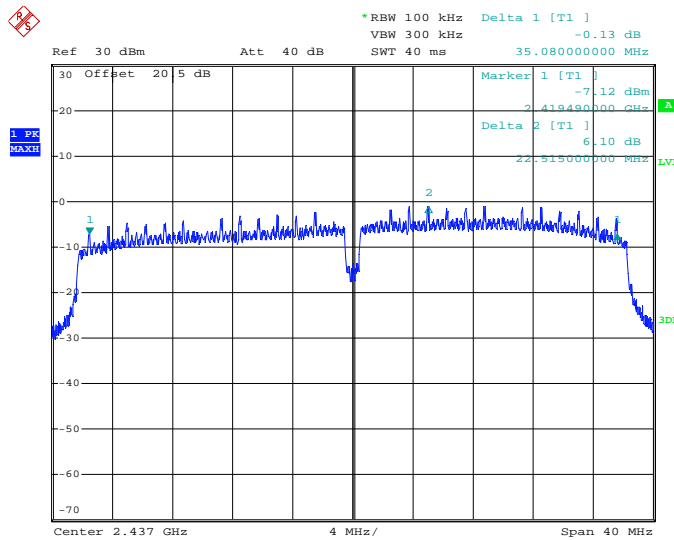

Date: 18.OCT.2017 20:08:15

Figure 7.2.2-20: 6dB BW - Middle Channel – 802.11n 40 MHz

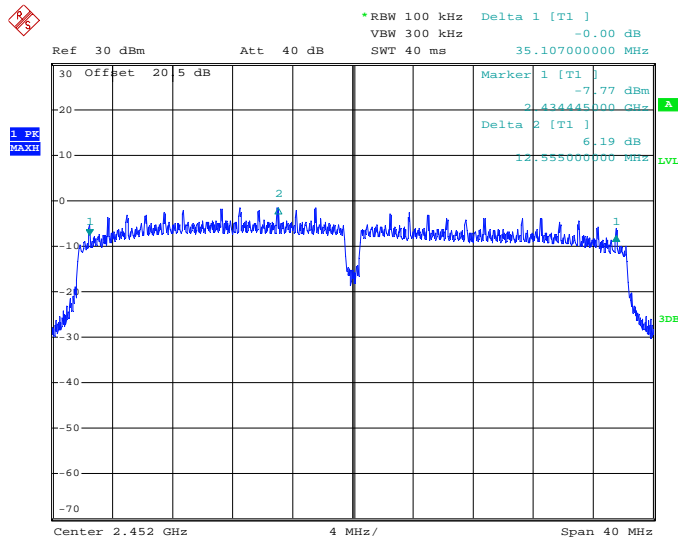

Date: 18.OCT.2017 20:25:43

Figure 7.2.2-21: 6dB BW - High Channel – 802.11n 40 MHz

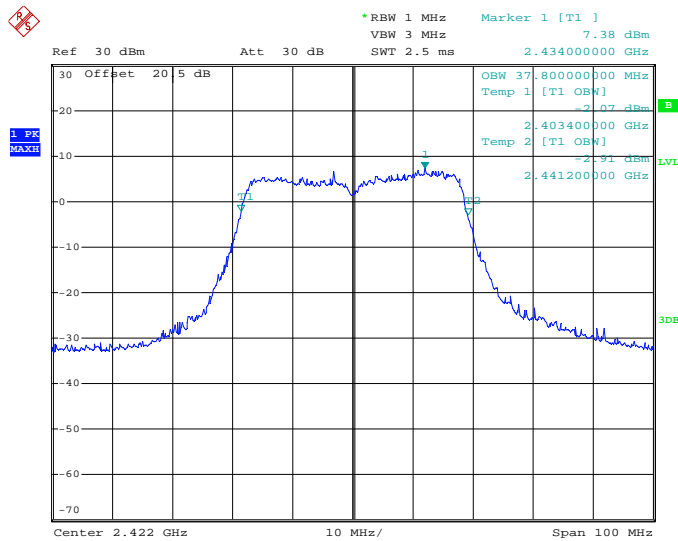

Date: 18.OCT.2017 19:21:33

Figure 7.2.2-22: 99% OBW - Low Channel - 802.11n 40 MHz

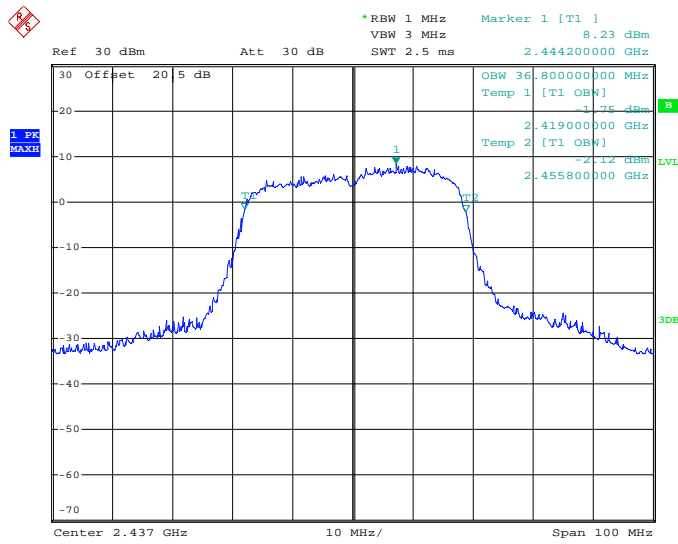

Date: 18.OCT.2017 19:30:38

Figure 7.2.2-23: 99% OBW - Middle Channel – 802.11n 40 MHz

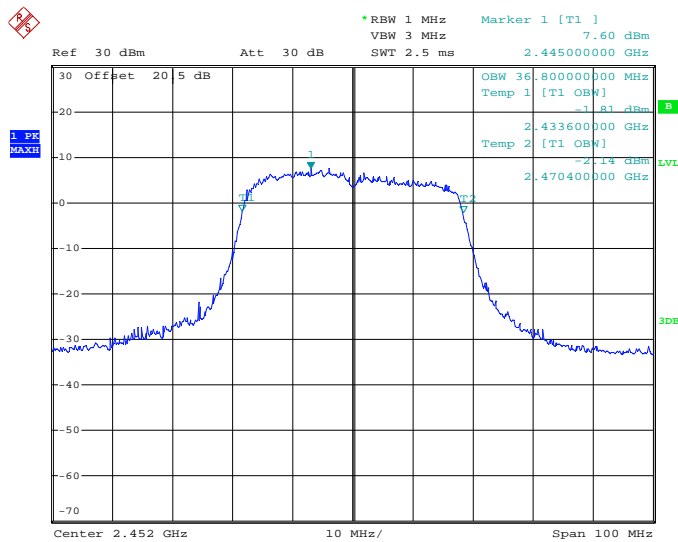

Date: 18.OCT.2017 19:35:11

Figure 7.2.2-24: 99% OBW - High Channel – 802.11n 40 MHz

7.3 Peak Output Power – FCC: Section 15.247(b)(3); ISED Canada: RSS-247 5.4(d)

7.3.1 Measurement Procedure (Conducted Method)

The fundamental emission output power was measured in accordance with the FCC KDB 558074 D01 DTS Meas Guidance v04.

Section 9.2.2.2 Method AVGSA-1 (trace averaging with the EUT transmitting at full power throughout each sweep) was used for the 802.11b/g modes.

Section 9.2.2.4 Method AVGSA-2 (trace averaging across on- and off-times of the EUT transmissions, followed by duty cycle correction) was used for the 802.11n 20/40 MHz modes. The justification for the duty cycle correction factor used is provided in Section 7.7.

The RF output of the equipment under test was directly connected to the input of the spectrum analyzer through suitable attenuation.

7.3.2 Measurement Results

Performed by: Thierry Jean-Charles

Table 7.3.2-1: RF Output Power – 802.11b

Frequency (MHz)	Level (dBm)
2412	10.42
2437	13.71
2462	12.29

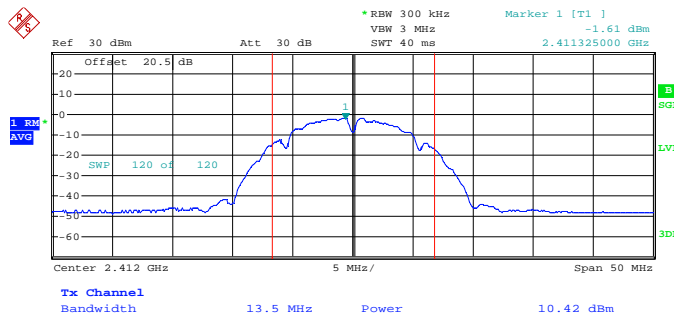

Date: 5.OCT.2017 21:18:52

Figure 7.3.2-1: RF Output Power - Low Channel – 802.11b

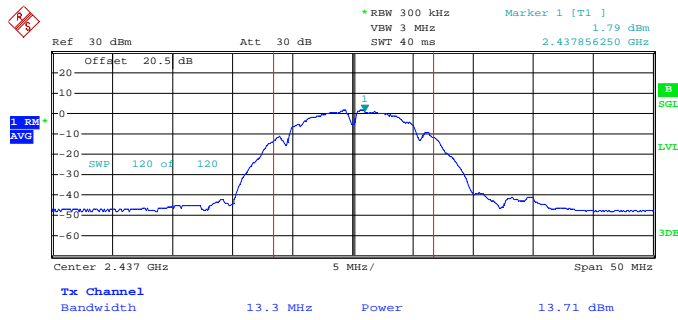

Date: 5.OCT.2017 21:17:03

Figure 7.3.2-2: RF Output Power - Middle Channel – 802.11b

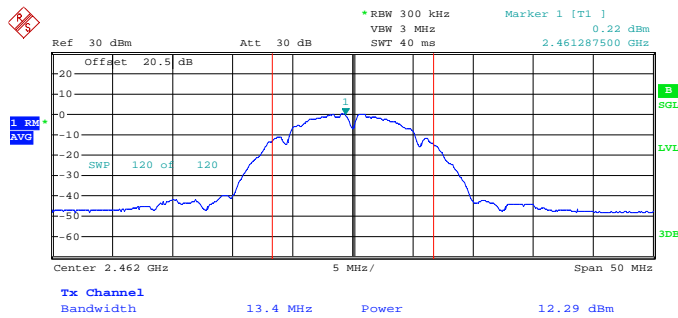

Date: 5.OCT.2017 21:21:59

Figure 7.3.2-3: RF Output Power - High Channel – 802.11b

Table 7.3.2-2: RF Output Power – 802.11g

Frequency (MHz)	Level (dBm)
2412	9.73
2437	12.60
2462	11.89

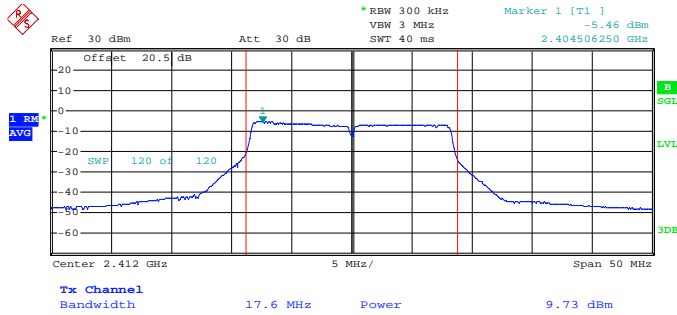

Date: 5.OCT.2017 21:39:38

Figure 7.3.2-4: RF Output Power - Low Channel – 802.11g

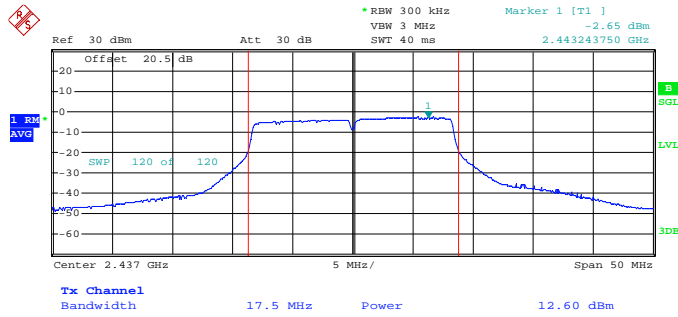

Date: 5.OCT.2017 21:35:55

Figure 7.3.2-5: RF Output Power - Middle Channel – 802.11g

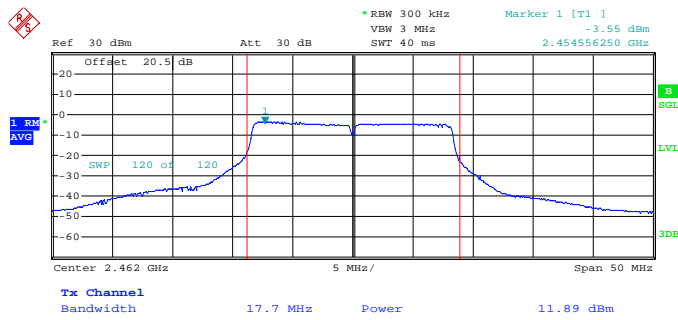

Date: 5.OCT.2017 21:42:48

Figure 7.3.2-6: RF Output Power - High Channel – 802.11g

Table 7.3.2-3: RF Output Power – 802.11n 20 MHz

Frequency (MHz)	Level (dBm)	Duty Cycle Correction Factor (dB)	Corrected Output Power (dBm)
2412	9.84	1.353	11.193
2437	12.74	1.353	14.093
2462	11.87	1.353	13.223

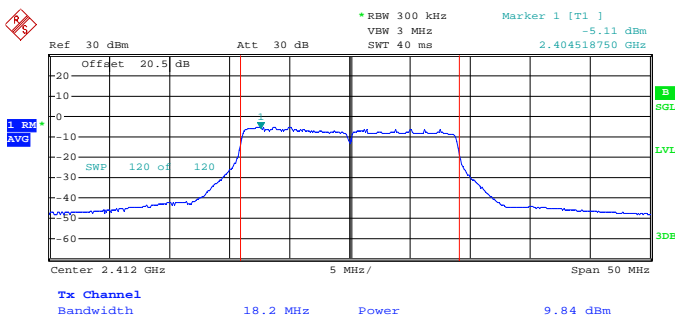

Date: 5.OCT.2017 21:56:50

Figure 7.3.2-7: RF Output Power - Low Channel – 802.11n 20 MHz

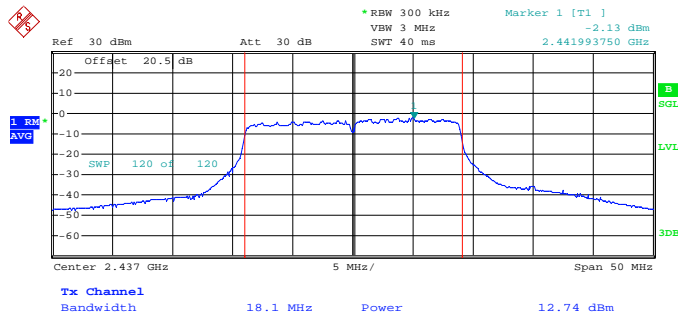

Date: 5.OCT.2017 21:50:09

Figure 7.3.2-8: RF Output Power - Middle Channel – 802.11n 20 MHz

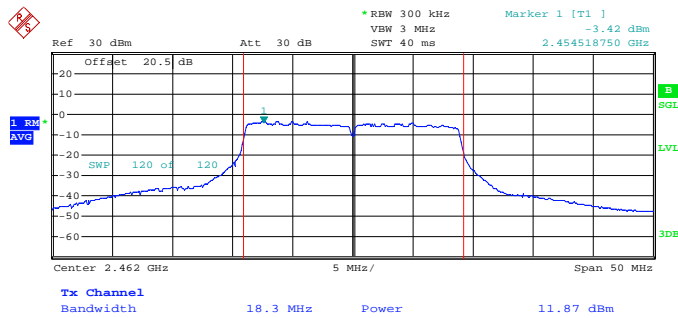

Date: 5.OCT.2017 22:00:26

Figure 7.3.2-9: RF Output Power - High Channel – 802.11n 20 MHz

Table 7.3.2-4: RF Output Power – 802.11n 40 MHz

Frequency (MHz)	Level (dBm)	Duty Cycle Correction Factor (dB)	Corrected Output Power (dBm)
2422	9.40	0.812	10.212
2437	10.03	0.812	10.842
2452	10.07	0.812	10.882

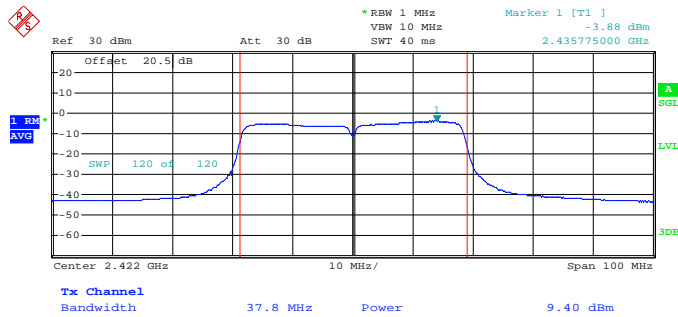

Date: 24.OCT.2017 15:25:53

Figure 7.3.2-10: RF Output Power - Low Channel – 802.11n 40 MHz

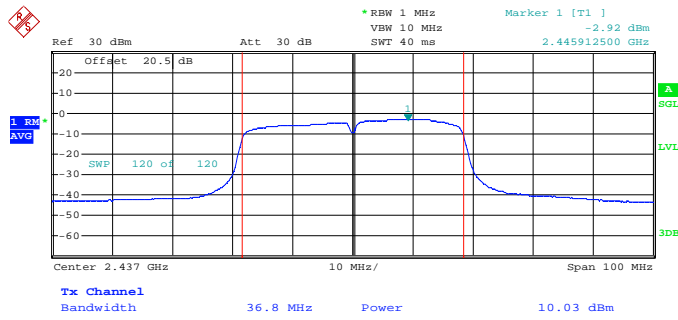

Date: 24.OCT.2017 14:52:58

Figure 7.3.2-11: RF Output Power - Middle Channel – 802.11n 40 MHz

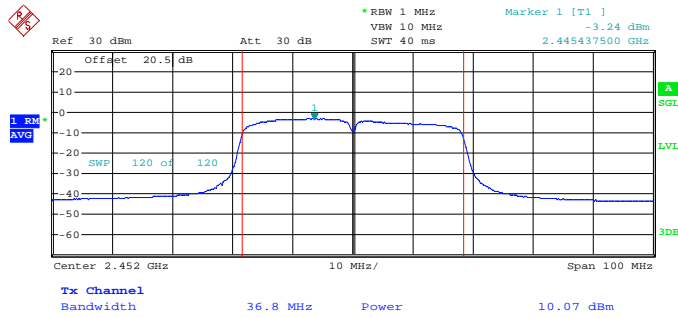

Date: 24.OCT.2017 14:54:36

Figure 7.3.2-12: RF Output Power - High Channel – 802.11n 40 MHz

7.4 Band-Edge and Spurious Emissions

7.4.1 Band-Edge Compliance of RF Conducted Emissions – FCC: Section 15.247(d); ISED Canada: RSS-247 5.5

7.4.1.1 Measurement Procedure

The RF output port of the EUT was directly connected to the input of the spectrum analyzer via suitable attenuation. The EUT was investigated at the lowest and highest channel available to determine band-edge compliance. For each measurement, the spectrum analyzer’s RBW was set to 100 kHz, and the VBW was set to 300 kHz.

7.4.1.2 Measurement Results

Performed by: Thierry Jean-Charles

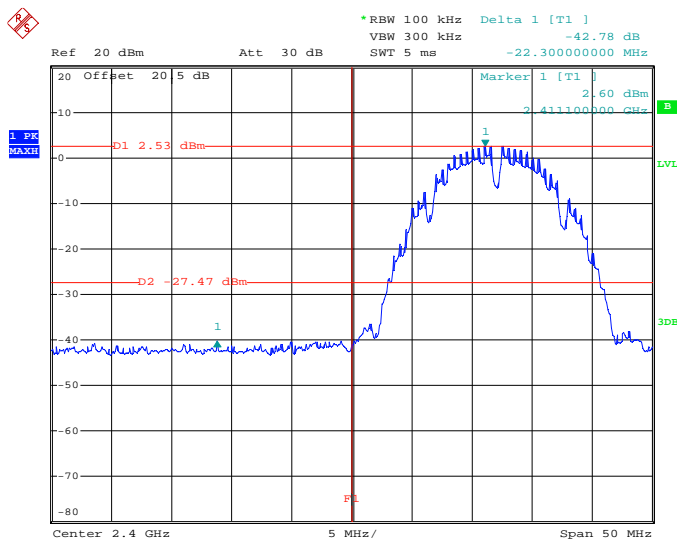

Date: 18.OCT.2017 22:26:02

Figure 7.4.1.2-1: Lower Band-edge – 802.11b

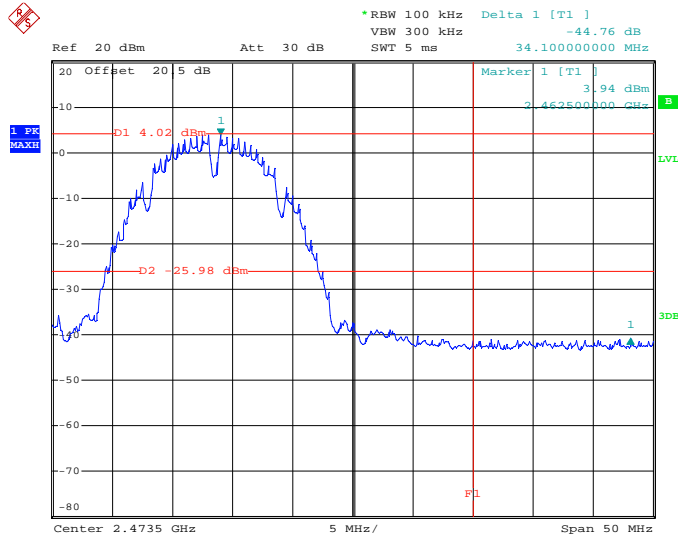

Date: 18.OCT.2017 23:05:26

Figure 7.4.1.2-2: Upper Band-edge – 802.11b

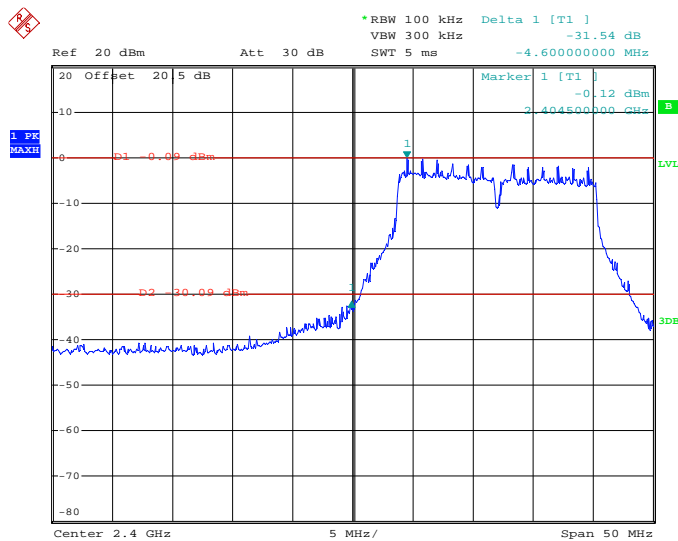

Date: 18.OCT.2017 22:13:34

Figure 7.4.1.2-3: Lower Band-edge – 802.11g

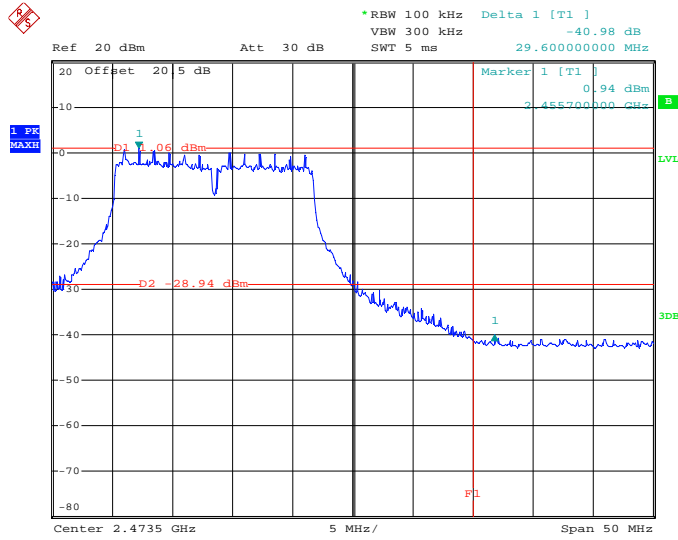

Date: 18.OCT.2017 21:40:42

Figure 7.4.1.2-4: Upper Band-edge – 802.11g

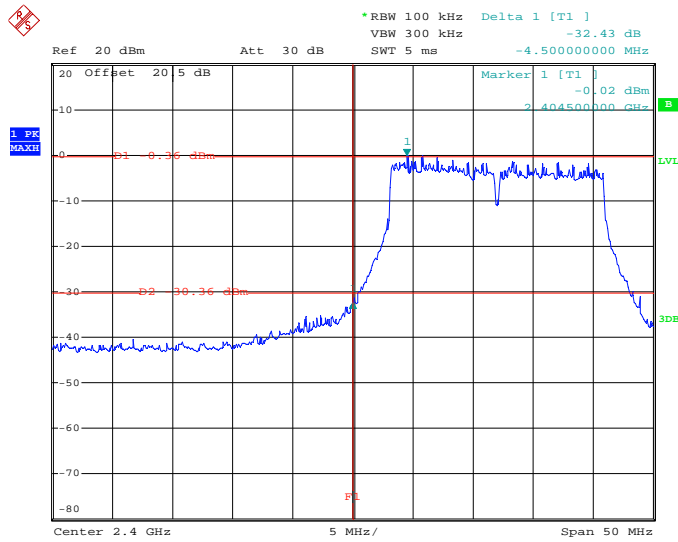

Date: 18.OCT.2017 21:06:07

Figure 7.4.1.2-5: Lower Band-edge – 802.11n 20 MHz

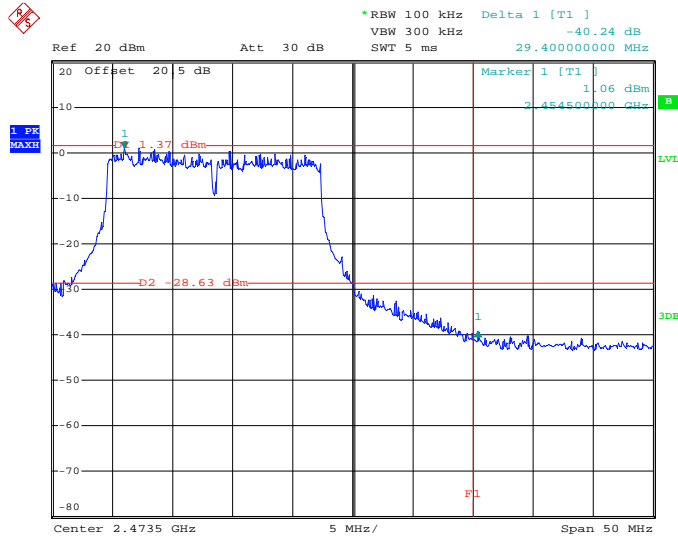

Date: 18.OCT.2017 21:35:22

Figure 7.4.1.2-6: Upper Band-edge – 802.11n 20 MHz

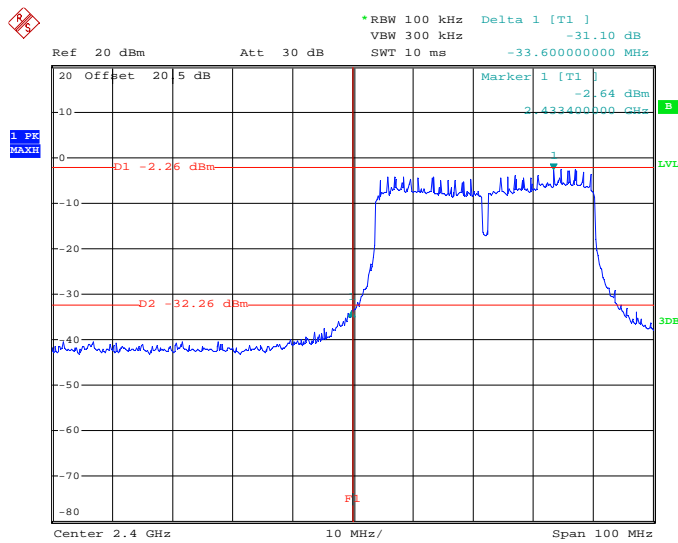

Date: 18.OCT.2017 20:59:40

Figure 7.4.1.2-7: Lower Band-edge – 802.11n 40 MHz

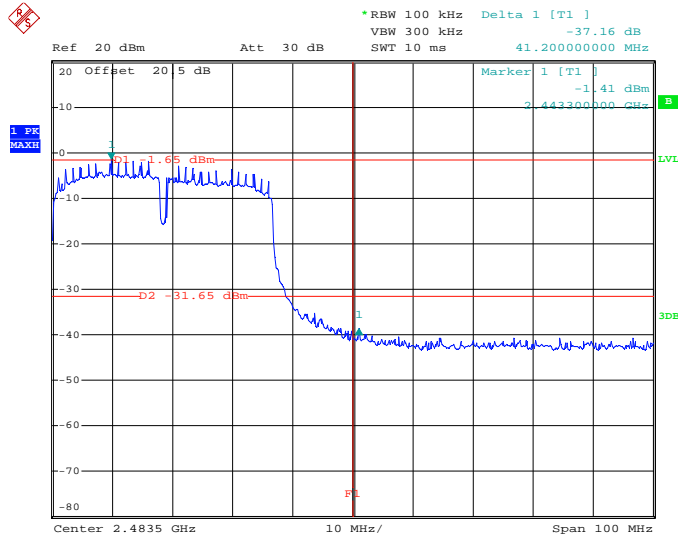

Date: 18.OCT.2017 20:35:28

Figure 7.4.1.2-8: Upper Band-edge – 802.11n 40 MHz

7.4.2 RF Conducted Spurious Emissions – FCC: Section 15.247(d); ISED Canada: RSS-247 5.5

7.4.2.1 Measurement Procedure

The RF Conducted Spurious Emissions were measured in accordance with the FCC KDB 558074 D01 DTS Meas Guidance v04 Section 11.3 Emission level measurement. The RF output port of the equipment under test was directly connected to the input of the spectrum analyzer. The EUT was investigated for conducted spurious emissions from 30 MHz to 26 GHz, 10 times the highest fundamental frequency. Measurements were made at the low, center and high channels of the EUT. For each measurement, the spectrum analyzer’s RBW was set to 100 kHz and the VBW was set to 50 MHz. The peak Max Hold function of the analyzer was utilized. The reference level was determined by measuring the Peak PSD level in any 100-kHz bandwidth within the DTS channel bandwidth.

7.4.2.2 Measurement Results

Performed by: Thierry Jean-Charles

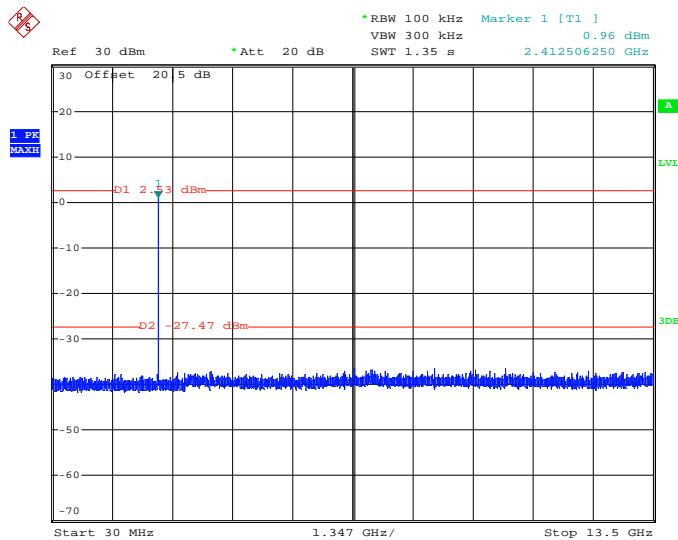

Date: 18.OCT.2017 22:43:11

Figure 7.4.2.2-1: 30 MHz – 13.5 GHz – Low Channel – 802.11b

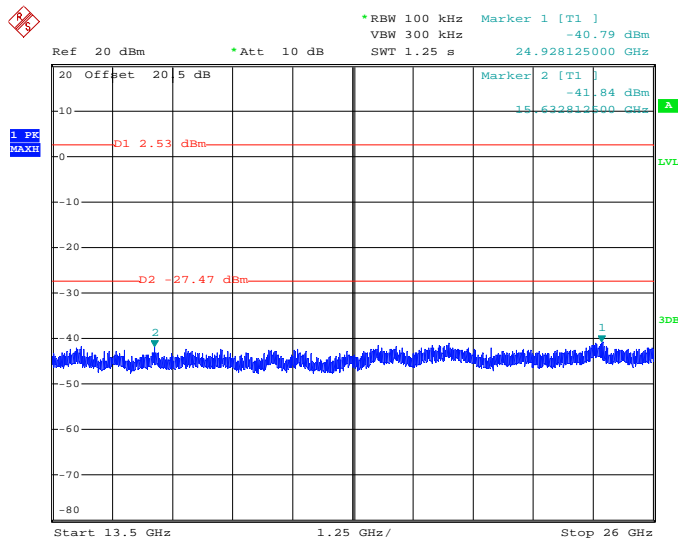

Date: 18.OCT.2017 22:44:57

Figure 7.4.2.2-2: 13.5 GHz – 26 GHz – Low Channel – 802.11b

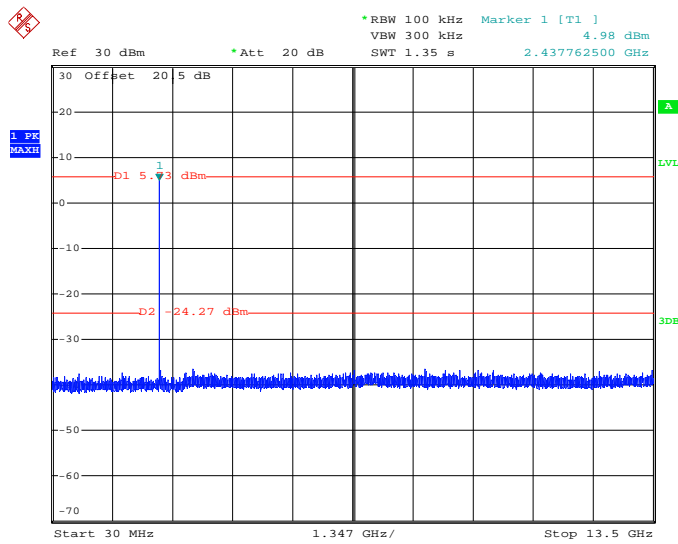

Date: 18.OCT.2017 22:52:13

Figure 7.4.2.2-3: 30 MHz – 13.5 GHz – Middle Channel – 802.11b

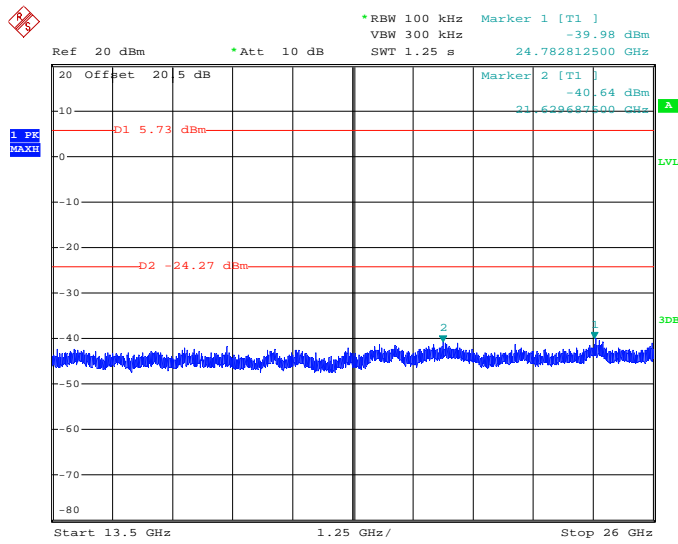

Date: 18.OCT.2017 22:47:28

Figure 7.4.2.2-4: 13.5 GHz – 26 GHz – Middle Channel – 802.11b

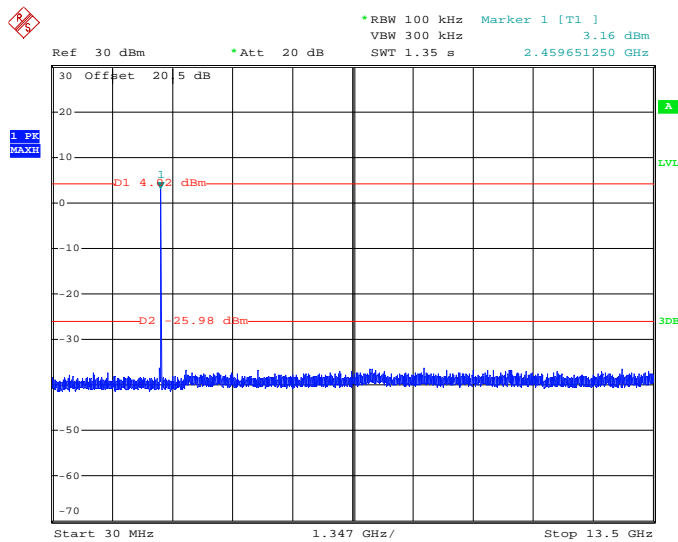

Date: 18.OCT.2017 23:00:06

Figure 7.4.2.2-5: 30 MHz – 13.5 GHz – High Channel – 802.11b

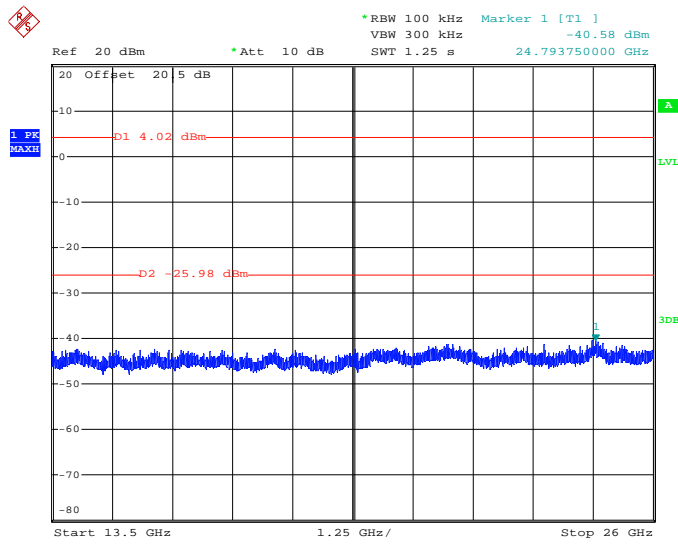

Date: 18.OCT.2017 23:01:54

Figure 7.4.2.2-6: 13.5 GHz – 26 GHz – High Channel – 802.11b

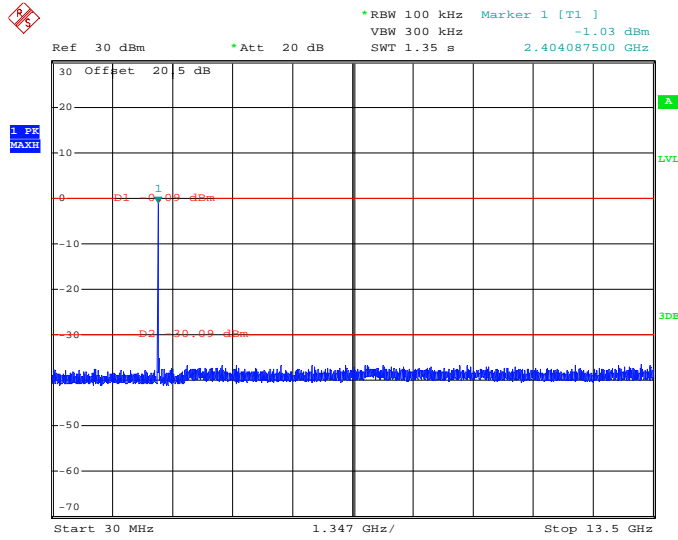

Date: 18.OCT.2017 22:38:52

Figure 7.4.2.2-7: 30 MHz – 13.5 GHz – Low Channel – 802.11g

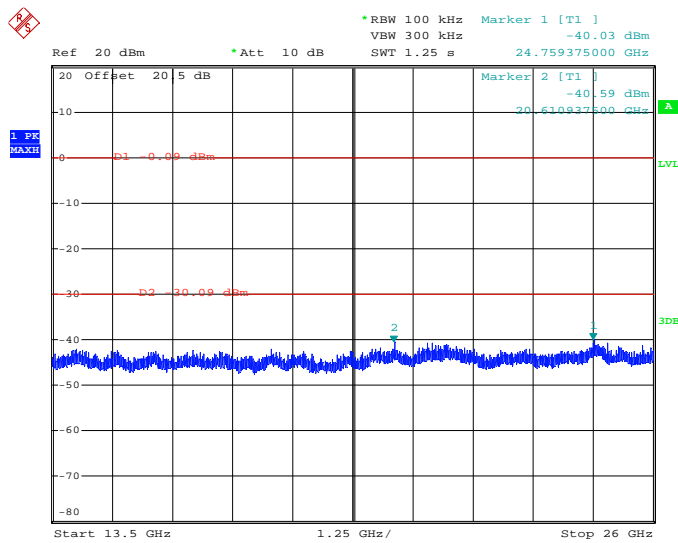

Date: 18.OCT.2017 22:16:09

Figure 7.4.2.2-8: 13.5 GHz – 26 GHz – Low Channel – 802.11g

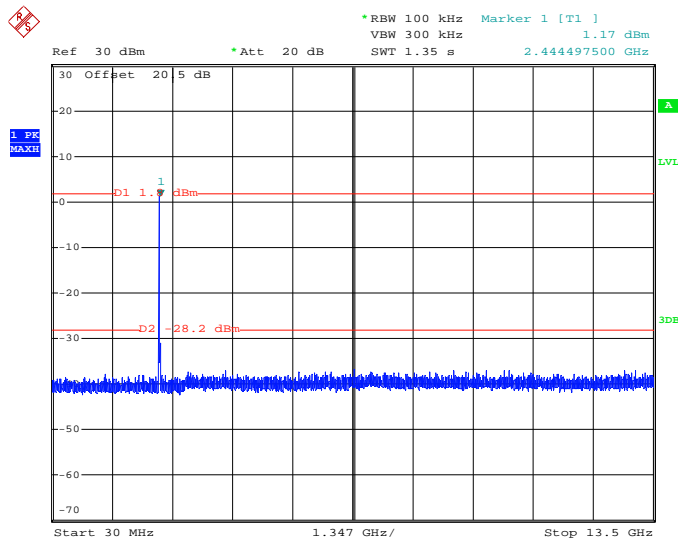

Date: 18.OCT.2017 21:51:41

Figure 7.4.2.2-9: 30 MHz – 13.5 GHz – Middle Channel – 802.11g

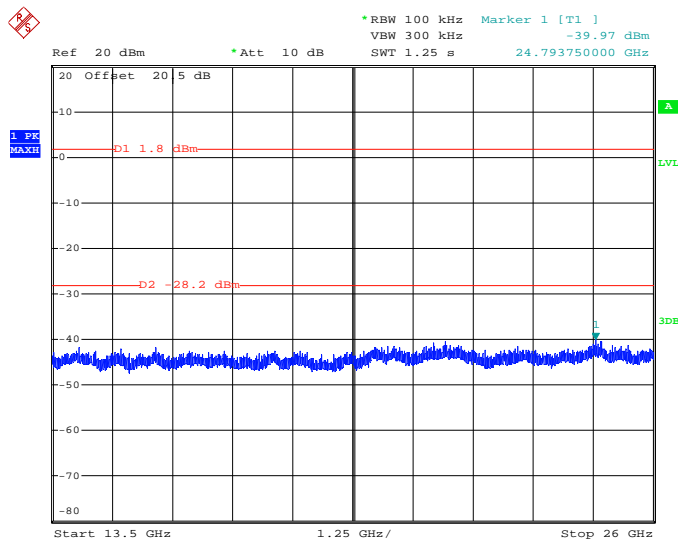

Date: 18.OCT.2017 21:49:29

Figure 7.4.2.2-10: 13.5 GHz – 26 GHz – Middle Channel – 802.11g

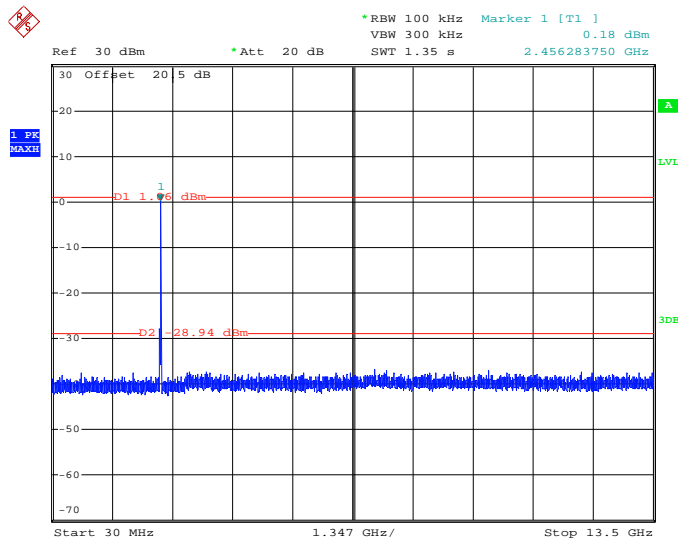

Date: 18.OCT.2017 21:42:39

Figure 7.4.2.2-11: 30 MHz – 13.5 GHz – High Channel – 802.11g

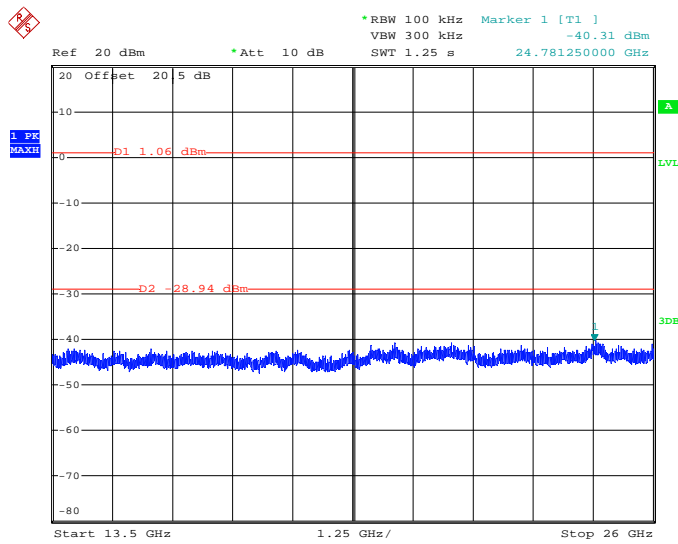

Date: 18.OCT.2017 21:46:06

Figure 7.4.2.2-12: 13.5 GHz – 26 GHz – High Channel – 802.11g

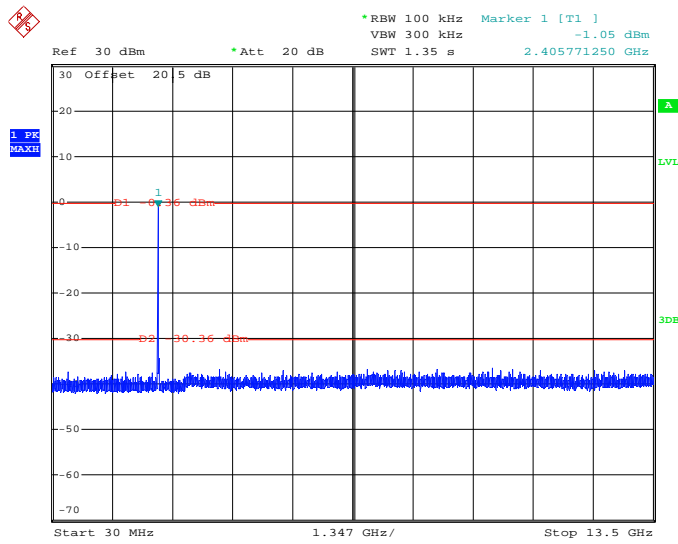

Date: 18.OCT.2017 21:13:13

Figure 7.4.2.2-13: 30 MHz – 13.5 GHz – Low Channel – 802.11n 20 MHz

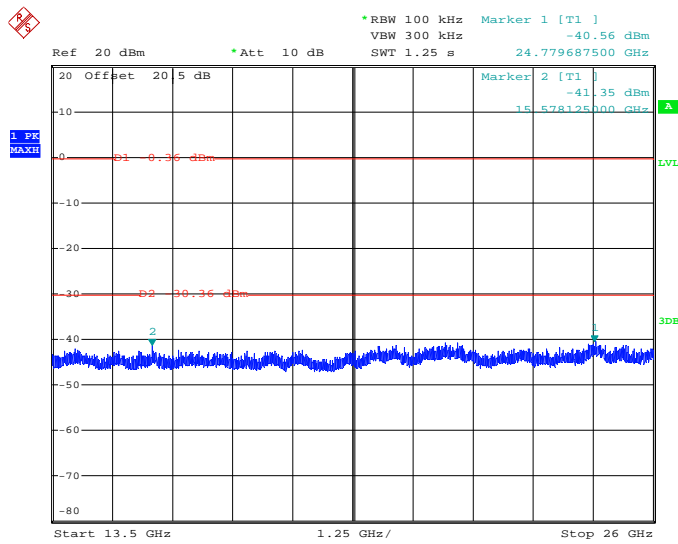

Date: 18.OCT.2017 21:09:12

Figure 7.4.2.2-14: 13.5 GHz – 26 GHz – Low Channel – 802.11n 20 MHz

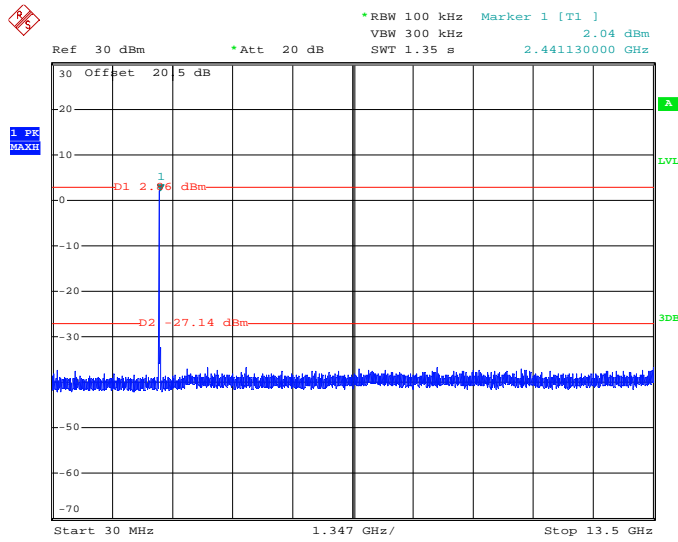

Date: 18.OCT.2017 21:17:06

Figure 7.4.2.2-15: 30 MHz – 13.5 GHz – Middle Channel – 802.11n 20 MHz

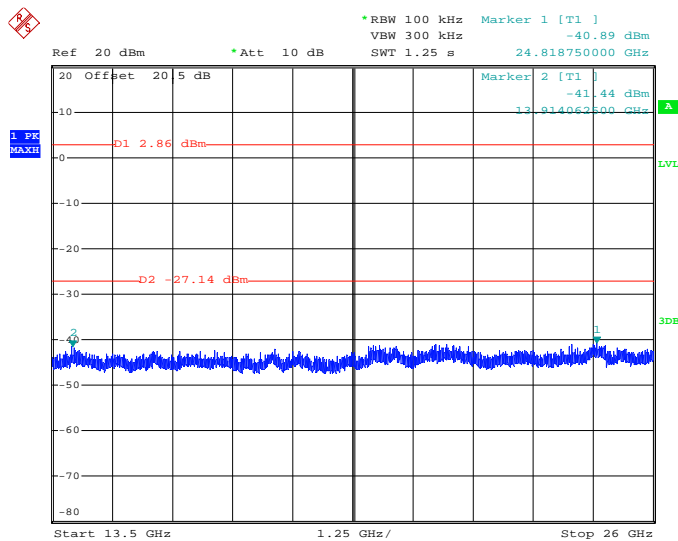

Date: 18.OCT.2017 21:22:09

Figure 7.4.2.2-16: 13.5 GHz – 26 GHz – Middle Channel – 802.11n 20 MHz

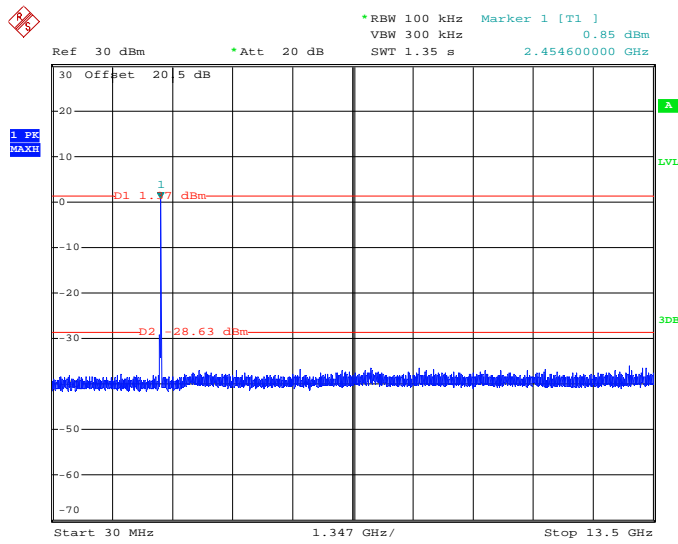

Date: 18.OCT.2017 21:32:02

Figure 7.4.2.2-17: 30 MHz – 13.5 GHz – High Channel – 802.11n 20 MHz

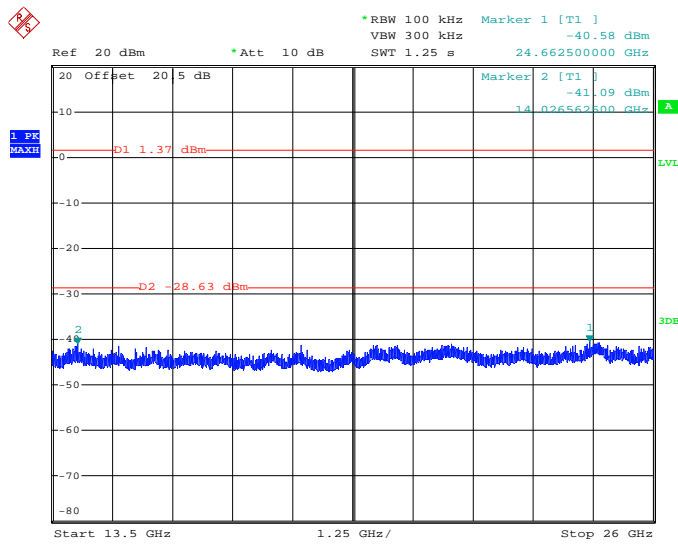

Date: 18.OCT.2017 21:26:07

Figure 7.4.2.2-18: 13.5 GHz – 26 GHz – High Channel – 802.11n 20 MHz

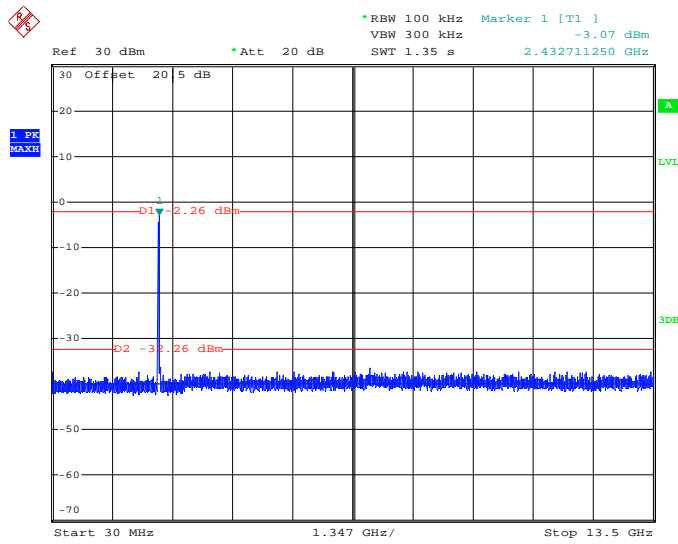

Date: 18.OCT.2017 20:53:46

Figure 7.4.2.2-19: 30 MHz – 13.5 GHz – Low Channel – 802.11n 40 MHz

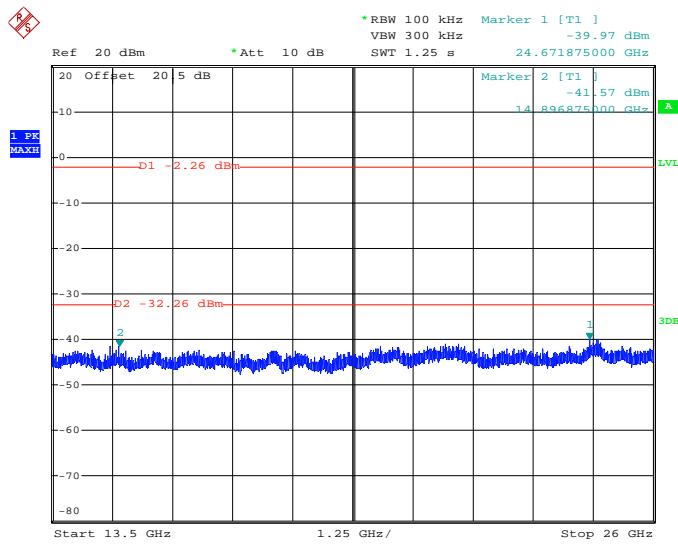

Date: 18.OCT.2017 20:56:14

Figure 7.4.2.2-20: 13.5 GHz – 26 GHz – Low Channel – 802.11n 40 MHz

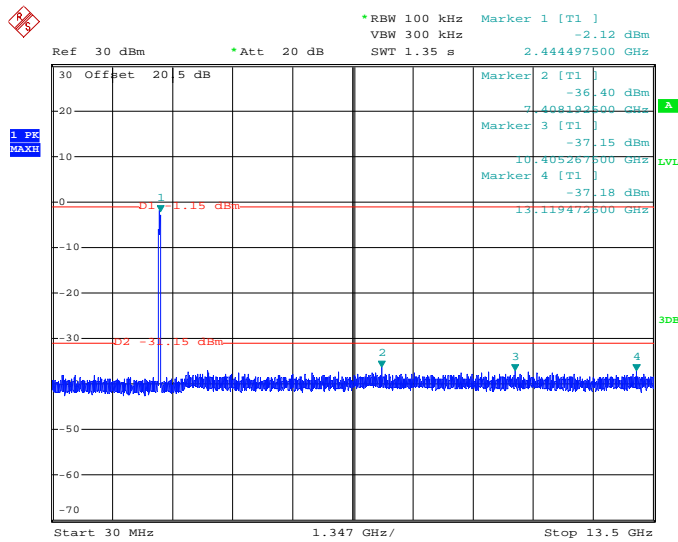

Date: 18.OCT.2017 20:51:04

Figure 7.4.2.2-21: 30 MHz – 13.5 GHz – Middle Channel – 802.11n 40 MHz

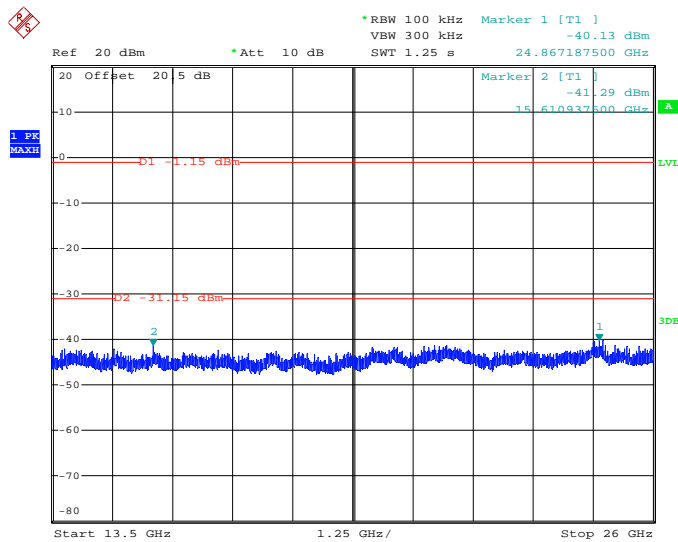

Date: 18.OCT.2017 20:48:30

Figure 7.4.2.2-22: 13.5 GHz – 26 GHz – Middle Channel – 802.11n 40 MHz

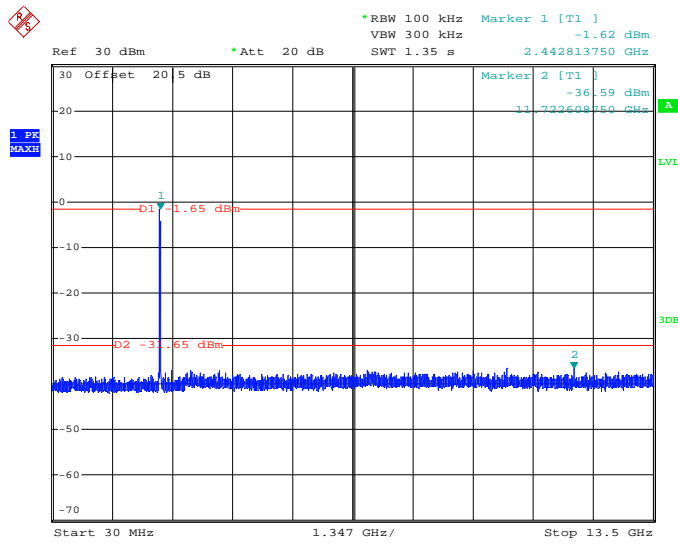

Date: 18.OCT.2017 20:44:21

Figure 7.4.2.2-23: 30 MHz – 13.5 GHz – High Channel – 802.11n 40 MHz

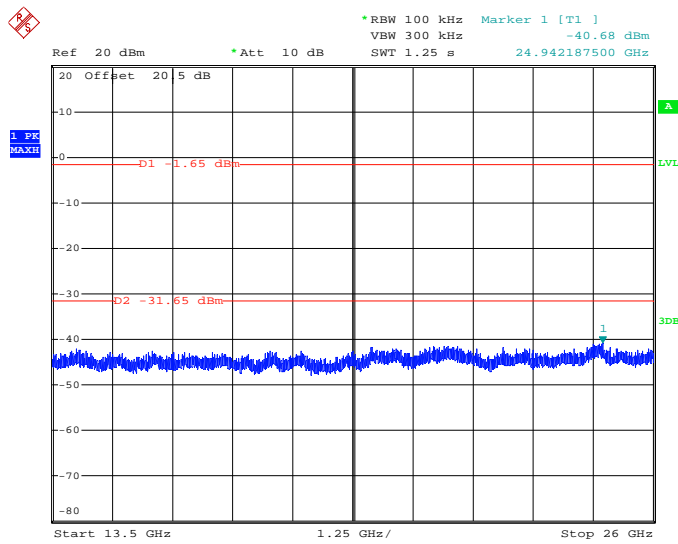

Date: 18.OCT.2017 20:46:21

Figure 7.4.2.2-24: 13.5 GHz – 26 GHz – High Channel – 802.11n 40 MHz

7.4.3 Radiated Spurious Emissions into Restricted Frequency Bands – FCC: Sections 15.205, 15.209; ISED Canada: RSS-Gen 8.9, 8.10

7.4.3.1 Measurement Procedure

Radiated emissions tests were made over the frequency range of 9 kHz to 26 GHz, 10 times the highest fundamental frequency. Each emission found to be in a restricted band as defined by section 15.205, including any emission at the operational band-edge, was compared to the radiated emission limits as defined in Section 15.209.

For measurements below 30 MHz, the receive antenna height was set to 1m and the EUT was rotated through 360 degrees. The resolution bandwidth was set to 200 Hz below 150 kHz and to 9 kHz above 150 kHz.

The EUT was rotated through 360° and the receive antenna height was varied from 1m to 4m so that the maximum radiated emissions level would be detected. For frequencies below 1000 MHz, quasi-peak measurements were made using a resolution bandwidth RBW of 120 kHz and a video bandwidth VBW of 300 kHz. For frequencies above 1000 MHz, peak measurements are made with RBW of 1 MHz and VBW of 3 MHz. Average measurements are performed in the linear scale using VBW of 30 Hz.

7.4.3.2 Measurement Results

Performed by: Jean Rene

Radiated band-edge and spurious emissions found in the restricted frequency bands of 9 kHz to 26 GHz are reported in the tables below.

Table 7.4.3.2-1: Radiated Spurious Emissions Tabulated Data – 802.11b

Frequency (MHz)	Level (dBuV)		Antenna Polarity (H/V)	Correction Factors (dB)	Corrected Level (dBuV/m)		Limit (dBuV/m)		Margin (dB)	
	pk	Qpk/Avg			pk	Qpk/Avg	pk	Qpk/Avg	pk	Qpk/Avg
Low Channel										
2390	58.49	43.97	H	-4.94	53.55	39.03	74.0	54.0	20.4	15.0
2390	57.42	44.31	V	-4.94	52.48	39.37	74.0	54.0	21.5	14.6
4874	47.94	42.08	H	4.32	52.26	46.40	74.0	54.0	21.7	7.6
4874	49.63	44.71	V	4.32	53.95	49.03	74.0	54.0	20.1	5.0
Middle Channel										
4874	46.58	38.88	H	4.32	50.90	43.20	74.0	54.0	23.1	10.8
4874	45.97	38.16	V	4.32	50.29	42.48	74.0	54.0	23.7	11.5
High Channel										
2483.5	57.46	44.01	H	-4.51	52.95	39.50	74.0	54.0	21.1	14.5
2483.5	58.12	45.03	V	-4.51	53.61	40.52	74.0	54.0	20.4	13.5
4924	47.79	41.24	H	4.53	52.32	45.77	74.0	54.0	21.7	8.2
4924	47.43	41.15	V	4.53	51.96	45.68	74.0	54.0	22.0	8.3

Notes:

All emissions above 4.924 GHz were attenuated below the limits and the noise floor of the measurement equipment.

Table 7.4.3.2-2: Radiated Spurious Emissions Tabulated Data – 802.11g

Frequency (MHz)	Level (dBuV)		Antenna Polarity (H/V)	Correction Factors (dB)	Corrected Level (dBuV/m)		Limit (dBuV/m)		Margin (dB)	
	pk	Qpk/Avg			pk	Qpk/Avg	pk	Qpk/Avg	pk	Qpk/Avg
Low Channel										
2390	64.16	46.35	H	-4.94	59.22	41.41	74.0	54.0	14.8	12.6
2390	65.36	47.91	V	-4.94	60.42	42.97	74.0	54.0	13.6	11.0
4824	44.44	31.37	H	4.11	48.55	35.48	74.0	54.0	25.5	18.5
Middle Channel										
4874	45.01	31.66	H	4.32	49.33	35.98	74.0	54.0	24.7	18.0
4874	45.62	32.82	V	4.32	49.94	37.14	74.0	54.0	24.1	16.9
High Channel										
2483.5	70.50	52.39	H	-4.51	65.99	47.88	74.0	54.0	8.0	6.1
2483.5	74.31	56.17	V	-4.51	69.80	51.66	74.0	54.0	4.2	2.3
4924	45.40	31.89	H	4.53	49.93	36.42	74.0	54.0	24.1	17.6
4924	45.78	32.88	V	4.53	50.31	37.41	74.0	54.0	23.7	16.6

Notes:

All emissions above 4.924 GHz were attenuated below the limits and the noise floor of the measurement equipment.

Table 7.4.3.2-3: Radiated Spurious Emissions Tabulated Data – 802.11n 20 MHz

Frequency (MHz)	Level (dBuV)		Antenna Polarity (H/V)	Correction Factors (dB)	Corrected Level (dBuV/m)		Limit (dBuV/m)		Margin (dB)	
	pk	Qpk/Avg			pk	Qpk/Avg	pk	Qpk/Avg	pk	Qpk/Avg
Low Channel										
2390	64.45	45.95	H	-4.94	59.51	41.01	74.0	54.0	14.5	13.0
2390	65.60	47.93	V	-4.94	60.66	42.99	74.0	54.0	13.3	11.0
4824	44.18	31.55	H	4.11	48.29	35.66	74.0	54.0	25.7	18.3
4824	44.91	32.22	V	4.11	49.02	36.33	74.0	54.0	25.0	17.7
Middle Channel										
4874	44.70	31.82	H	4.32	49.02	36.14	74.0	54.0	25.0	17.9
4874	45.53	32.70	V	4.32	49.85	37.02	74.0	54.0	24.2	17.0
High Channel										
2483.5	71.12	53.41	H	-4.51	66.61	48.90	74.0	54.0	7.4	5.1
2483.5	74.94	56.35	V	-4.51	70.43	51.84	74.0	54.0	3.6	2.2
4924	44.57	31.82	H	4.53	49.10	36.35	74.0	54.0	24.9	17.6
4924	46.35	32.93	V	4.53	50.88	37.46	74.0	54.0	23.1	16.5

Notes:

All emissions above 4.924 GHz were attenuated below the limits and the noise floor of the measurement equipment.

Table 7.4.3.2-4: Radiated Spurious Emissions Tabulated Data – 802.11n 40 MHz

Frequency (MHz)	Level (dBuV)		Antenna Polarity (H/V)	Correction Factors (dB)	Corrected Level (dBuV/m)		Limit (dBuV/m)		Margin (dB)	
	pk	Qpk/Avg			pk	Qpk/Avg	pk	Qpk/Avg	pk	Qpk/Avg
Low Channel										
2390	66.13	51.55	H	-4.94	61.19	46.61	74.0	54.0	12.8	7.4
2390	70.02	56.72	V	-4.94	65.08	51.78	74.0	54.0	8.9	2.2
Middle Channel										
4874	44.18	31.08	H	4.32	48.50	35.40	74.0	54.0	25.5	18.6
4874	44.23	31.71	V	4.32	48.55	36.03	74.0	54.0	25.5	18.0
High Channel										
2483.5	67.00	52.73	H	-4.51	62.49	48.22	74.0	54.0	11.5	5.8
2483.5	70.34	56.85	V	-4.51	65.83	52.34	74.0	54.0	8.2	1.7
4904	44.25	30.96	H	4.45	48.70	35.41	74.0	54.0	25.3	18.6
4904	44.32	31.31	V	4.45	48.77	35.76	74.0	54.0	25.2	18.2

Notes:

All emissions above 4.924 GHz were attenuated below the limits and the noise floor of the measurement equipment.

7.4.4 Sample Calculation

$$R_C = R_U + CF_T$$

Where:

CF_T = Total Correction Factor (AF+CA+AG)-DC (Average Measurements Only)

R_U = Uncorrected Reading

R_C = Corrected Level

AF = Antenna Factor

CA = Cable Attenuation

AG = Amplifier Gain

DC = Duty Cycle Correction Factor

Example Calculation: Peak

Corrected Level: $58.49 + (-4.94) = 53.55$ dB μ V/m

Margin: 74 dB μ V/m – 53.55 dB μ V/m = 20.4 dB

Example Calculation: Average

Corrected Level: $43.97 + (-4.94) = 39.03$ dB μ V/m

Margin: 54 dB μ V/m – 39.03 dB μ V/m = 15.0 dB

7.5 Power Spectral Density – FCC: Section 15.247(e); ISED Canada: RSS-247 5.2(b)

7.5.1 PSD Measurement Procedure (Conducted Method)

The power spectral density was measured in accordance with the FCC KDB 558074 D01 DTS Meas Guidance v04 Section 10.2 Method PKPSD (peak PSD). The RF output port of the EUT was directly connected to the input of the spectrum analyzer. Offset values were input for cable and external attenuation. The spectrum analyzer RBW was set to 3 kHz and VBW 10 kHz. Span was adjusted to 1.5 times the DTS bandwidth and the sweep time was set to auto.

7.5.2 Measurement Results

Performed by: Thierry Jean-Charles

Results are shown below.

Table 7.5.2-1: Power Spectral Density – 802.11b

Frequency (MHz)	PSD (dBm)	Limit (dBm)	Margin (dB)
2412	-9.75	8	17.75
2437	-6.96	8	14.96
2462	-9.04	8	17.04

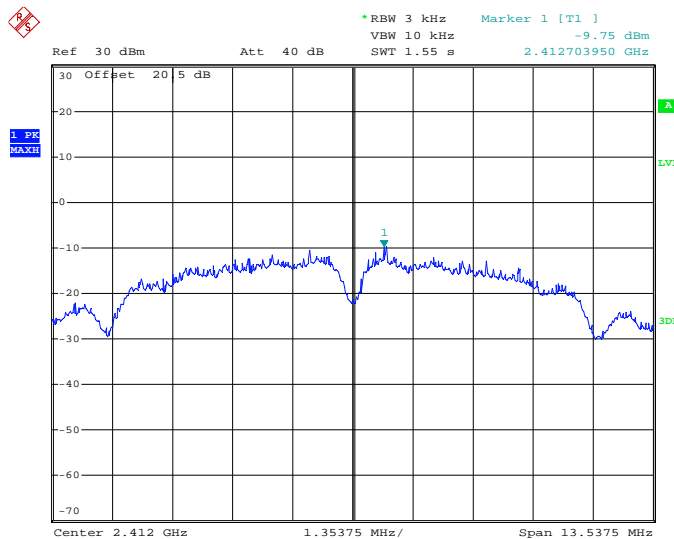

Date: 6.OCT.2017 17:09:51

Figure 7.5.2-1: Power Spectral Density - Low Channel – 802.11b

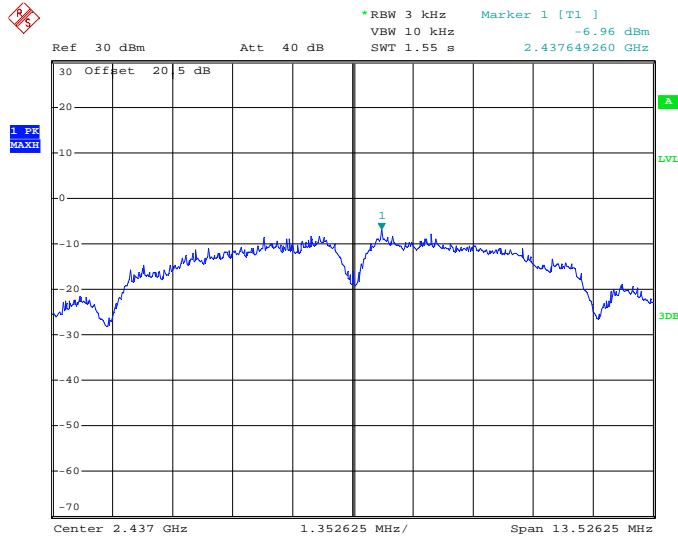

Date: 6.OCT.2017 16:59:59

Figure 7.5.2-2: Power Spectral Density - Middle Channel – 802.11b

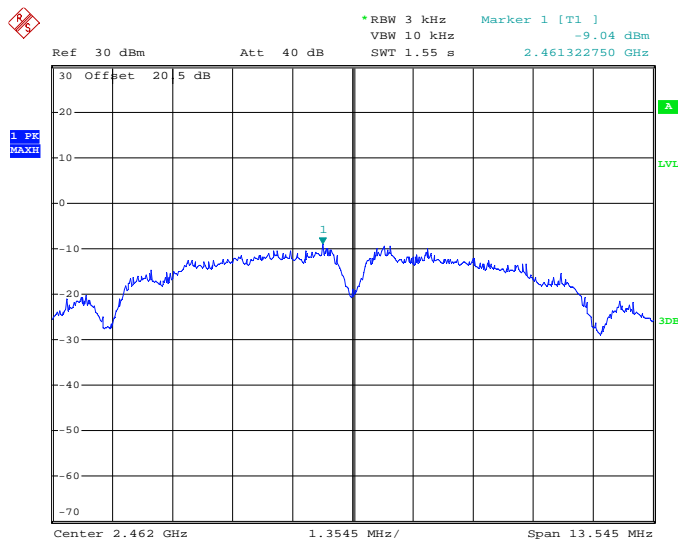

Date: 6.OCT.2017 17:29:43

Figure 7.5.2-3: Power Spectral Density – High Channel – 802.11b

Table 7.5.2-2: Power Spectral Density – 802.11g

Frequency (MHz)	PSD (dBm)	Limit (dBm)	Margin (dB)
2412	-13.27	8	21.27
2437	-12.23	8	20.23
2462	-11.24	8	19.24

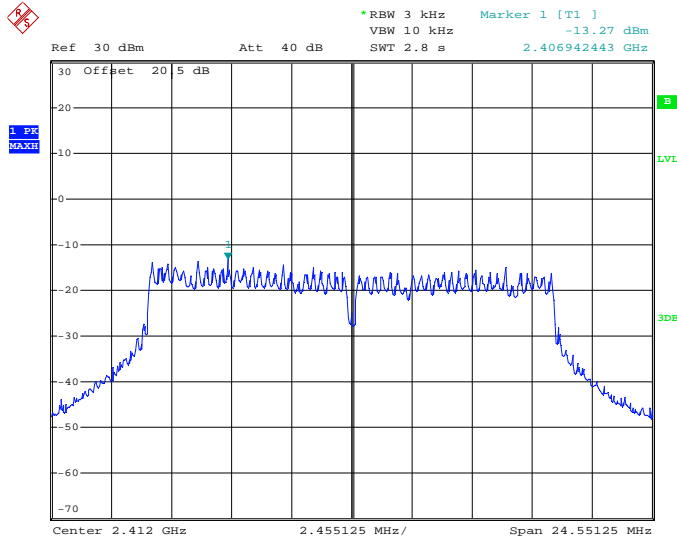

Date: 24.OCT.2017 17:32:23

Figure 7.5.2-4: Power Spectral Density - Low Channel – 802.11g

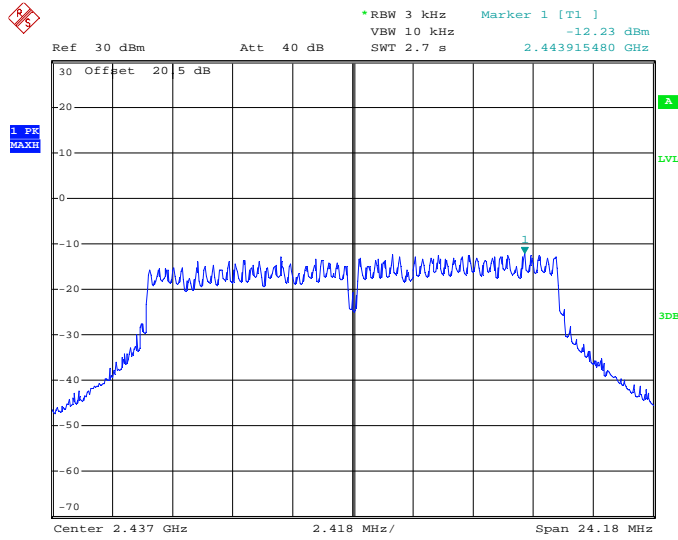

Date: 6.OCT.2017 15:00:22

Figure 7.5.2-5: Power Spectral Density - Middle Channel – 802.11g

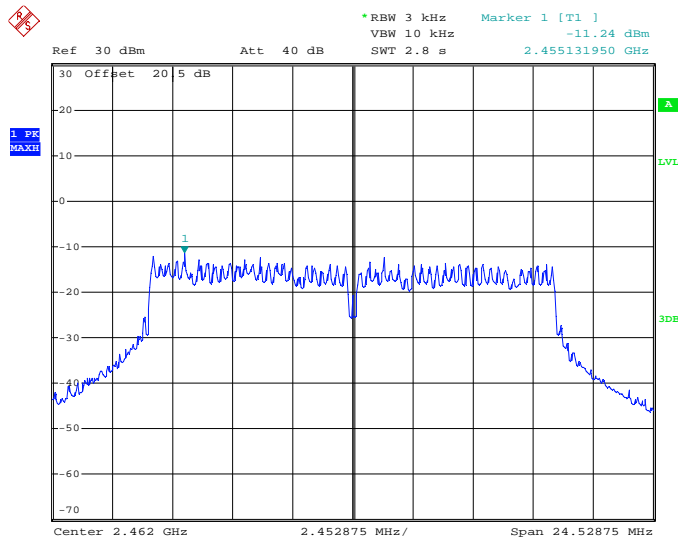

Date: 6.OCT.2017 16:37:49

Figure 7.5.2-6: Power Spectral Density – High Channel – 802.11g

Table 7.5.2-3: Power Spectral Density – 802.11n 20 MHz

Frequency (MHz)	PSD (dBm)	Limit (dBm)	Margin (dB)
2412	-14.24	8.0	22.24
2437	-11.57	8.0	19.57
2462	-12.02	8.0	20.02

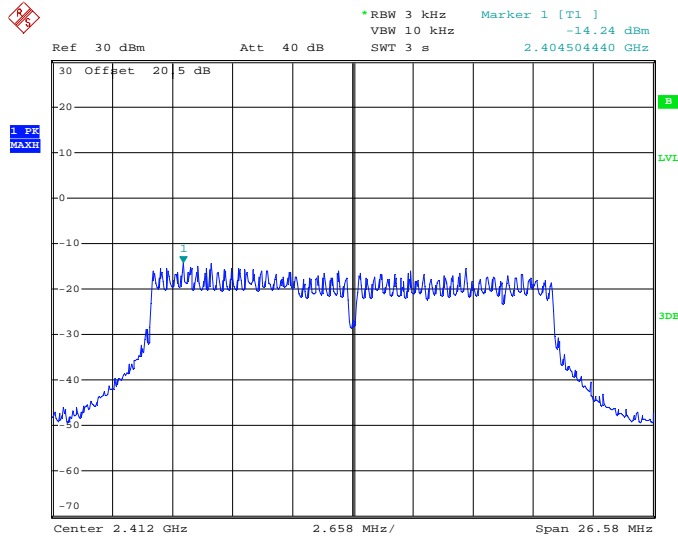

Date: 5.OCT.2017 23:10:41

Figure 7.5.2-7: Power Spectral Density - Low Channel – 802.11n 20 MHz

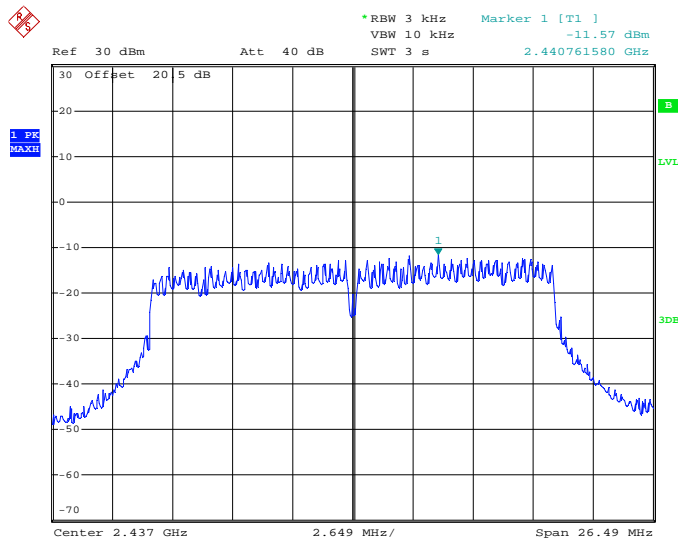

Date: 5.OCT.2017 22:59:49

Figure 7.5.2-8: Power Spectral Density - Middle Channel – 802.11n 20 MHz

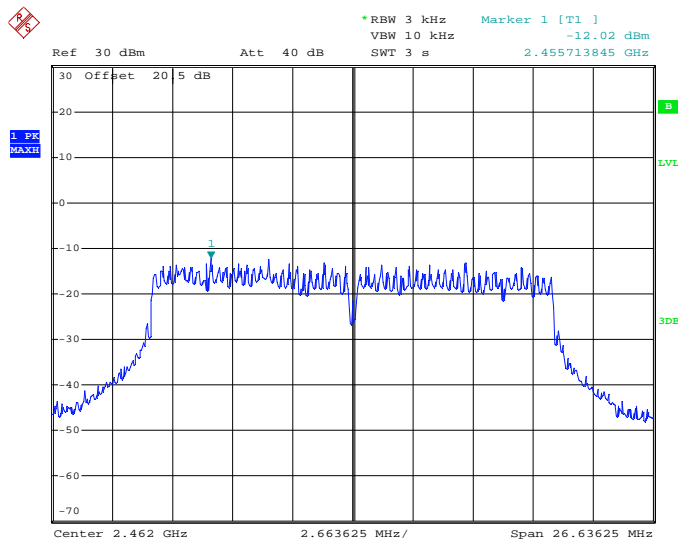

Date: 5.OCT.2017 23:19:07

Figure 7.5.2-9: Power Spectral Density – High Channel – 802.11n 20 MHz

Table 7.5.2-3: Power Spectral Density – 802.11n 40 MHz

Frequency (MHz)	PSD (dBm)	Limit (dBm)	Margin (dB)
2422	-16.14	8.0	24.14
2437	-15.01	8.0	23.01
2452	-15.47	8.0	23.47

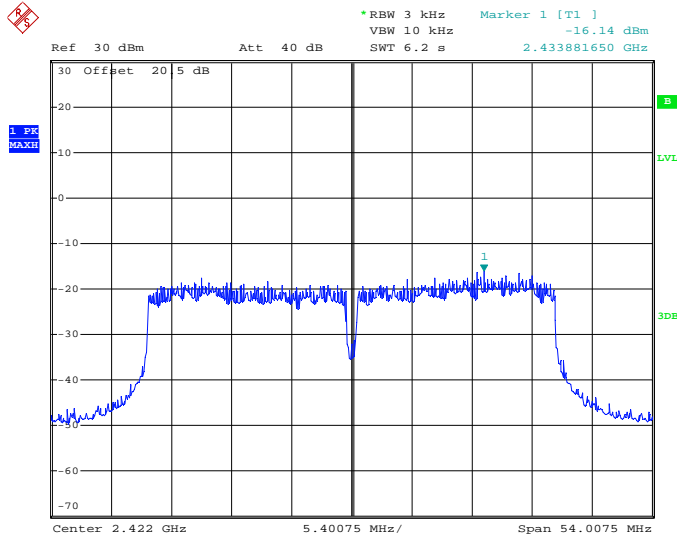

Date: 18.OCT.2017 20:18:16

Figure 7.5.2-10: Power Spectral Density - Low Channel – 802.11n 40 MHz

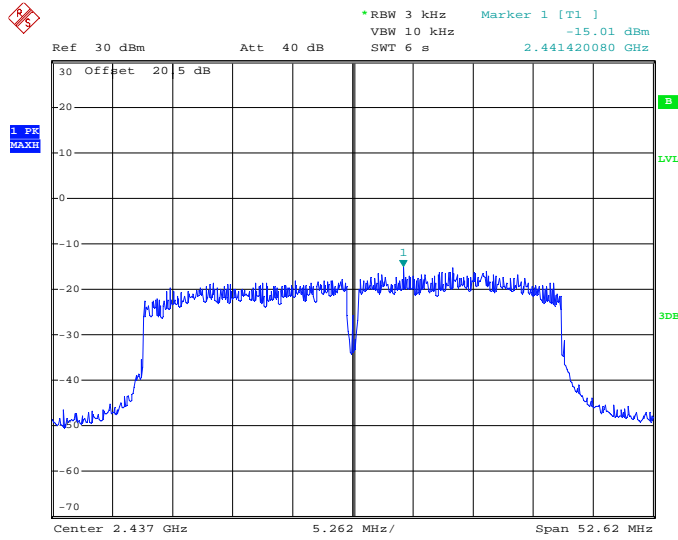

Date: 18.OCT.2017 20:11:16

Figure 7.5.2-11: Power Spectral Density - Middle Channel – 802.11n 40 MHz

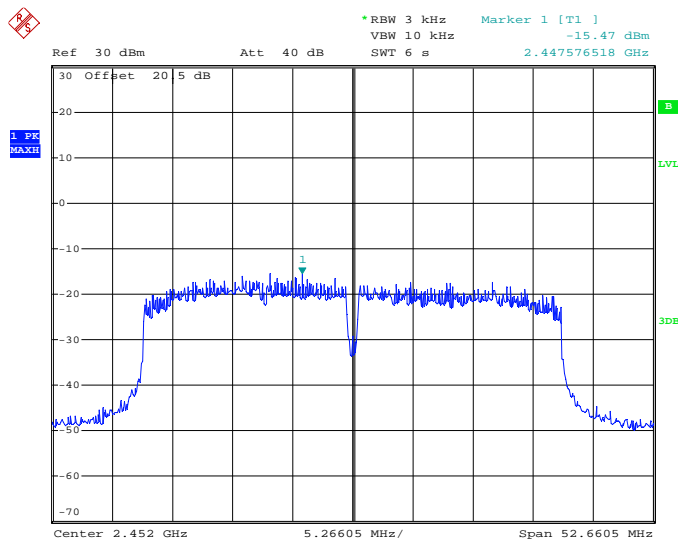

Date: 18.OCT.2017 20:31:55

Figure 7.5.2-12: Power Spectral Density – High Channel – 802.11n 40 MHz

7.6 Power Line Conducted Emissions – FCC: Section 15.207; ISED Canada: RSS-Gen 8.8

7.6.1 Measurement Procedure

ANSI C63.10 section 6.2 was the guiding document for this evaluation. Conducted emissions were performed from 150 kHz to 30 MHz with the spectrum analyzer’s resolution bandwidth set to 9 kHz and the video bandwidth set to 30 kHz. The calculation for the conducted emissions is as follows:

$$\text{Corrected Reading} = \text{Analyzer Reading} + \text{LISN Loss} + \text{Cable Loss}$$

$$\text{Margin} = \text{Applicable Limit} - \text{Corrected Reading}$$

7.6.2 Measurement Results

Performed by: Thierry Jean-Charles

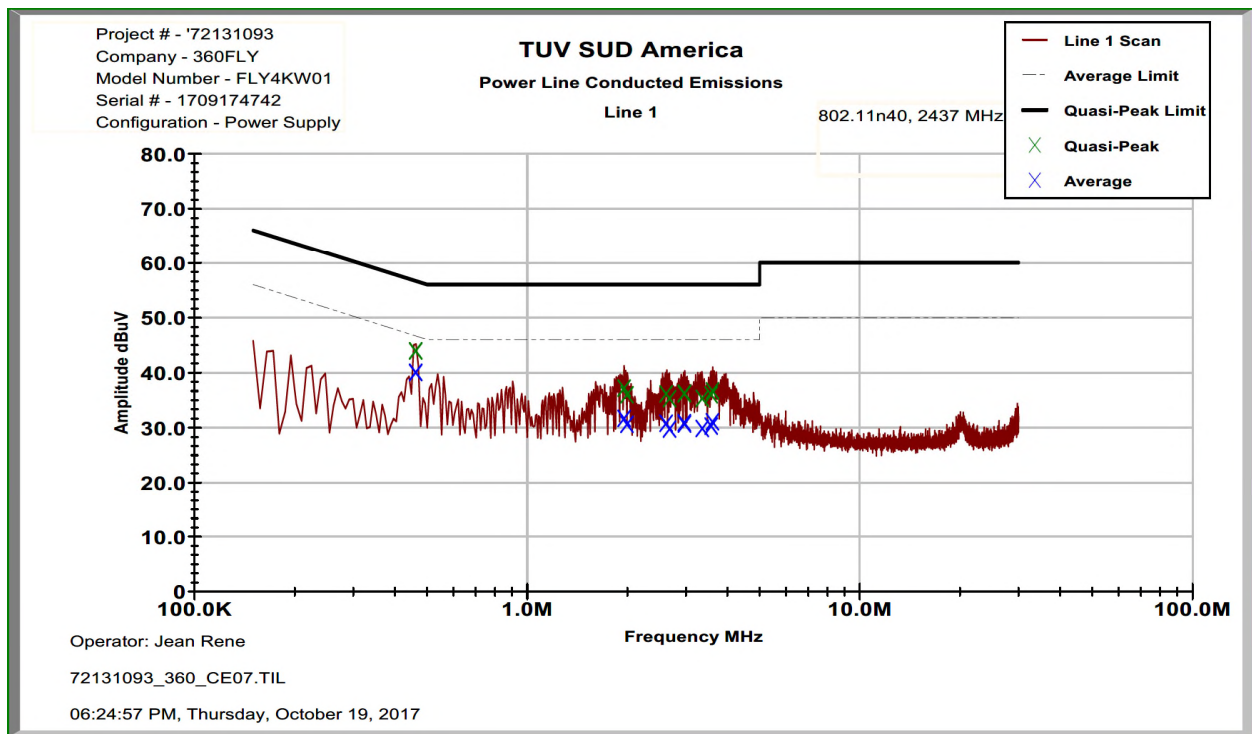

Figure 7.6.2-1: Conducted Emissions Results – Line 1

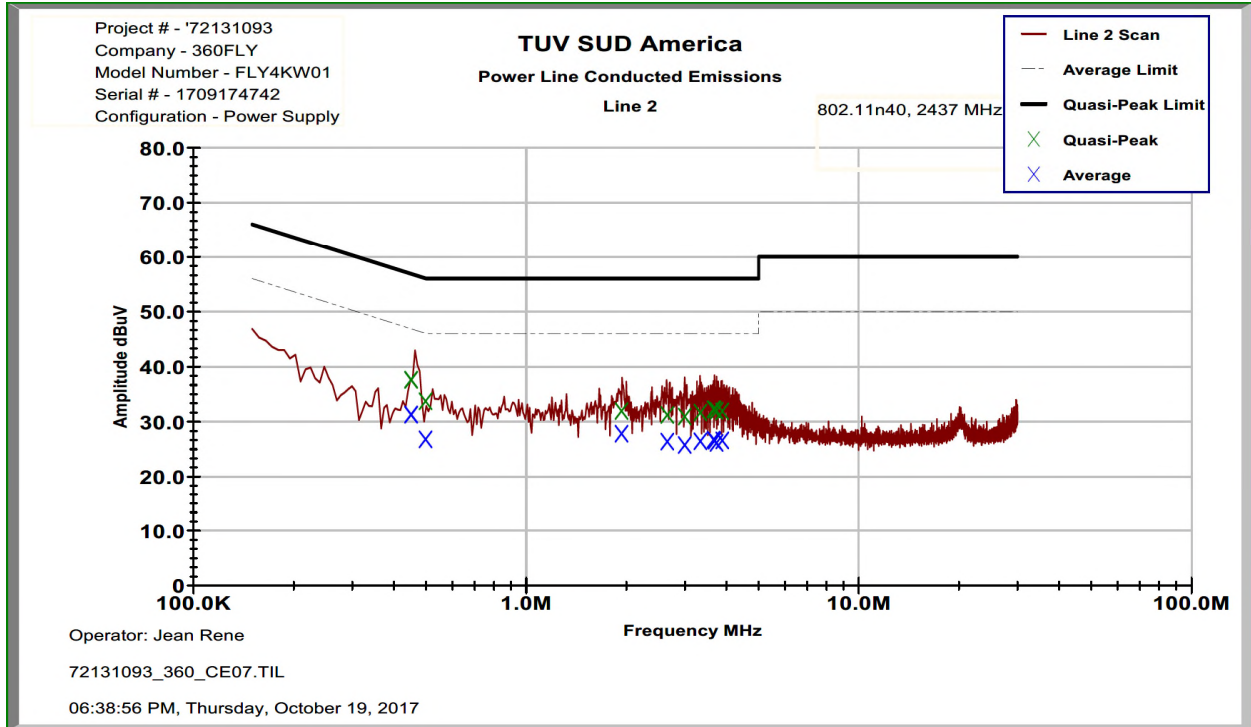

Figure 7.6.2-2: Conducted Emissions Results – Line 2

Table 7.6.2-1: Conducted EMI Results

Line 1 Line 2 Line 3
 Line 4
 To Ground Floating
 Telecom Port
 dBµV dBµA

Plot Number:
72131093 360 CE07
Power Supply Description: 5
VDC Power Supply

Frequency (MHz)	Uncorrected Reading		Total Correction Factor (dB)	Corrected Level		Limit		Margin (dB)	
	Quasi-Peak	Average		Quasi-Peak	Average	Quasi-Peak	Average	Quasi-Peak	Average
Line 1									
0.462075	33.612	29.682	10.23	43.84	39.91	56.66	46.66	12.8	6.7
1.95503	26.683	21.141	10.26	36.94	31.40	56.00	46.00	19.1	14.6
1.99555	25.44	20.078	10.26	35.70	30.33	56.00	46.00	20.3	15.7
2.6162	25.573	20.212	10.38	35.96	30.60	56.00	46.00	20.0	15.4
2.67838	24.666	19.154	10.38	35.05	29.54	56.00	46.00	21.0	16.5
2.9631	25.52	20.278	10.38	35.90	30.66	56.00	46.00	20.1	15.3
2.96694	25.648	20.039	10.38	36.03	30.42	56.00	46.00	20.0	15.6
3.35826	24.671	19.188	10.48	35.15	29.67	56.00	46.00	20.9	16.3
3.57002	25.325	19.597	10.48	35.80	30.08	56.00	46.00	20.2	15.9
3.6037	26.026	20.372	10.48	36.51	30.85	56.00	46.00	19.5	15.1
Line 2									
0.450475	27.287	20.944	10.27	37.56	31.21	56.87	46.87	19.3	15.7
0.498099	23.387	16.431	10.27	33.66	26.70	56.03	46.03	22.4	19.3
1.9332	21.397	17.307	10.30	31.69	27.60	56.00	46.00	24.3	18.4
2.65362	20.644	15.775	10.42	31.07	26.20	56.00	46.00	24.9	19.8
2.99446	20.336	15.168	10.42	30.76	25.59	56.00	46.00	25.2	20.4
3.33507	21.017	15.83	10.50	31.52	26.33	56.00	46.00	24.5	19.7
3.65857	21.575	16.058	10.50	32.07	26.56	56.00	46.00	23.9	19.4
3.68291	21.55	15.89	10.50	32.05	26.39	56.00	46.00	24.0	19.6
3.7318	21.305	15.49	10.50	31.80	25.99	56.00	46.00	24.2	20.0
3.88335	21.214	15.917	10.50	31.71	26.42	56.00	46.00	24.3	19.6

7.7 Duty Cycle

7.7.1 Measurement Procedure

The duty cycle was measured in accordance with ANSI C63.10 Section 11.6 Duty cycle (D), transmission duration (T), and maximum power control level. The unit was connected directly to the input of the spectrum analyzer via suitable attenuation. The RBW and VBW were set to 10 MHz and the number of sweep points across duration T was set to exceed 100.

7.7.2 Measurement Results

The results for all the modes of operation are provided below.

Table 7.7.2-1 Duty Cycle Correction Factor

Mode	Data Rate (Mbps)	Time On (ms)	Period (ms)	Duty Cycle (%)	Correction Factor (dB)
802.11b	1	12.19375	12.203125	99.92%	0.003
802.11g	6	2.024375	2.033125	99.57%	0.019
802.11n 20 MHz	52	0.268	0.366	73.22%	1.353
802.11n 40 MHz	27	0.484125	0.583625	82.95%	0.812

Notes:

The correction factor was calculated as $10 \cdot \log(1/(\text{Time on}/\text{Period}))$

Per ANSI C63.10 duty cycle correction factor is not needed for duty cycle > 98%

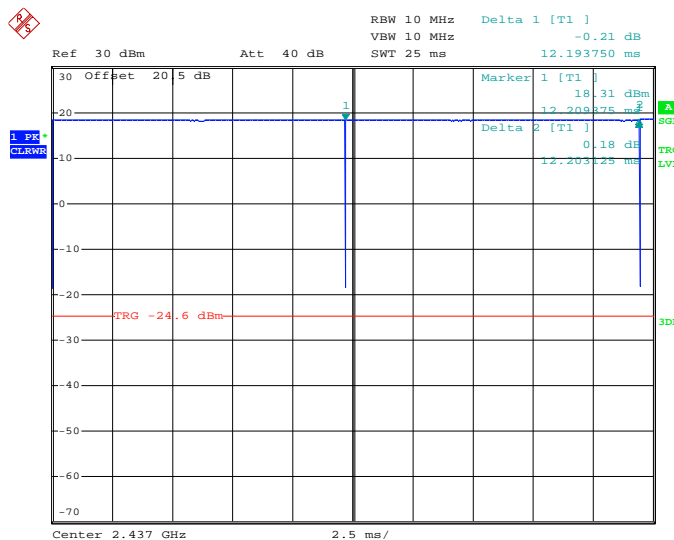
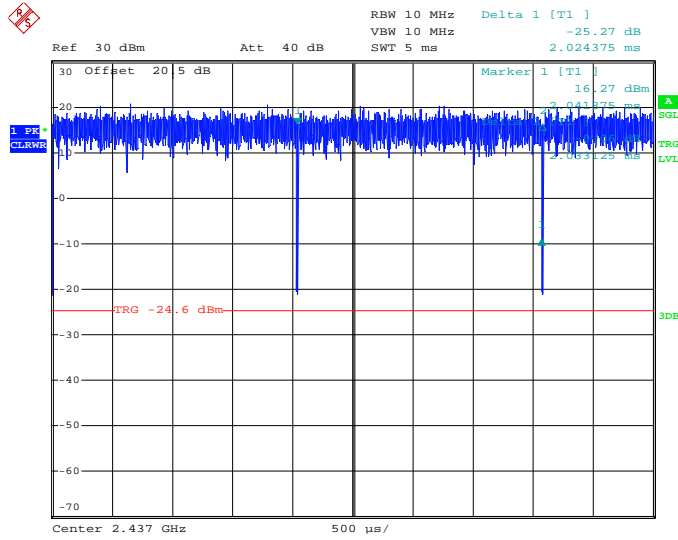
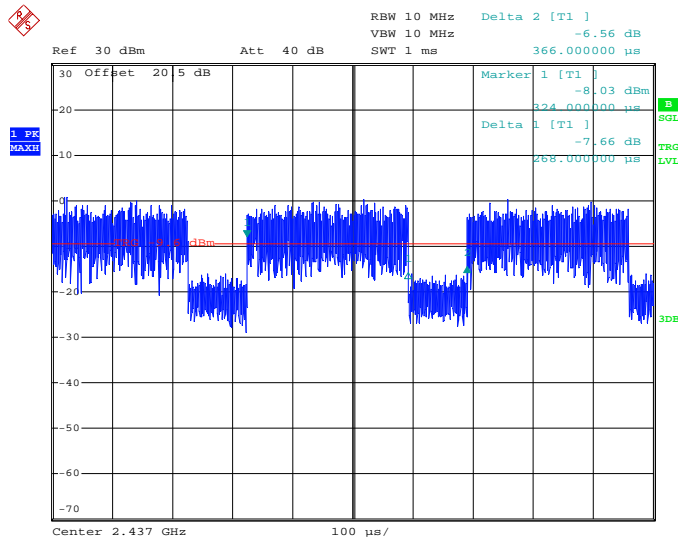

Figure 7.7.2-1: Duty Cycle 802.11b



Date: 25.SEP.2017 23:20:19

Figure 7.7.2-2: Duty Cycle 802.11g



Date: 28.SEP.2017 13:05:39

Figure 7.7.2-3: Duty Cycle 802.11n 20 MHz

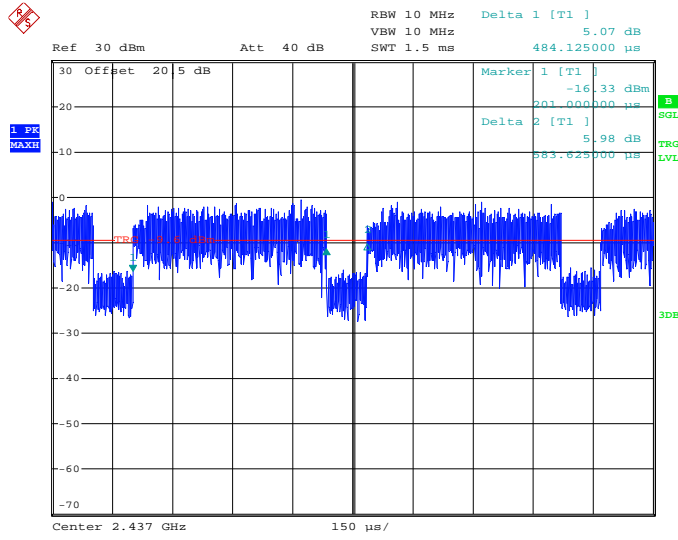

Date: 28.SEP.2017 15:57:21

Figure 7.7.2-4: Duty Cycle 802.11n 40 MHz

8 MEASUREMENT UNCERTAINTIES

The expanded laboratory measurement uncertainty figures (U_{Lab}) provided below correspond to an expansion factor (coverage factor) $k = 1.96$ which provide confidence levels of 95%.

Table 8-1: Measurement Uncertainties

Parameter	U_{lab}
Occupied Channel Bandwidth	$\pm 0.009 \%$
RF Conducted Output Power	$\pm 1.15 \text{ dB}$
Power Spectral Density	$\pm 1.15 \text{ dB}$
Antenna Port Conducted Emissions	$\pm 1.15 \text{ dB}$
Radiated Emissions $\leq 1\text{GHz}$	$\pm 5.86 \text{ dB}$
Radiated Emissions $> 1\text{GHz}$	$\pm 4.65 \text{ dB}$
Temperature	$\pm 0.860 \text{ }^\circ\text{C}$
Radio Frequency	$\pm 2.832 \times 10^{-8}$
AC Power Line Conducted Emissions	$\pm 3.72 \text{ dB}$

9 CONCLUSION

In the opinion of TÜV SÜD America, Inc. the model FLY4KW01, manufactured by 360fly, Inc., meets the requirements of FCC Part 15.247 and Industry Canada's Radio Standards Specification RSS-247 for the tests documented herein.

END REPORT