



MONOPRICE

5.1.2 Dolby Atmos[®] Soundbar SB-600





P/N 42034

Instruction Manual

Contents

1. Important Safety Instructions	3
1.1 Safety	3
1.2 Warning	4
2. What's in the Box	6
3. Identifying the Parts	7
3.1 Main Unit	7
3.2 Wireless Subwoofer	8
3.3 Wireless Surround	8
3.4 Remote Control	8
4. Preparations	9
4.1 Prepare the Remote Control	9
4.2 Replace the Remote Control Battery	9
4.3 Placement and Mounting	9
4.4 Wall Mounting (for unit)	9
4.5 Wall Mounting (for surround)	10
5. Connections	10
5.1 Dolby Atmos®	10
5.2 HDMI Connection	11
5.3 Use the OPTICAL Socket	11
5.4 Use the COAXIAL Socket	11
5.5 Use the AUX Socket	12
5.6 Connect Surround Speakers	12
5.7 Connect Power	12
5.8 Pair up with the Subwoofer & Surround	12
6. Basic Operation	13
6.1 Standby/ON	13
6.2 Select Modes	13
6.3 Adjust the Bass/Treble Level	13
6.4 Turn the Surround Sound ON/OFF	13
6.5 Select Equalizer (EQ) Effect	13
6.6 Adjust the Volume	13
6.7 About the Display Brightness	13
6.8 AV SYNC (Set the Audio Delay)	14
7. AUX / OPTICAL / COAXIAL / HDMI Operation	14
8. Bluetooth Operation	14
8.1 Pair Bluetooth-enabled Devices	14
8.2 Listen to Music from Bluetooth Device	15
9. USB Operation	15
10. Troubleshooting	16
11. Specifications	17

1. Important Safety Instructions

	CAUTION RISK OF ELECTRIC SHOCK DO NOT OPEN	
<p>CAUTION: TO REDUCE THE RISK OF ELECTRIC SHOCK, DO NOT REMOVE COVER (OR BACK). NO USER-SERVICEABLE PARTS INSIDE. REFER SERVICING TO QUALIFIED SERVICE PERSONNEL.</p>		

 The lightning flash with arrowhead symbol, within an equilateral triangle, is intended to alert the user to the presence of uninsulated “dangerous voltage” within the product’s enclosure that may be of sufficient magnitude as to constitute a risk of electric shock to persons.

 The exclamation point within an equilateral triangle is intended to alert the user to the presence of important operating and maintenance (servicing) instructions in the literature accompanying the appliance.

1.1 Safety

- 1 **Read these instructions** – All the safety and operating instructions should be read before this product is operated.
- 2 **Keep these instructions** – The safety and operating instructions should be retained for future reference.
- 3 **Heed all warnings** – All warnings on the appliance and in the operating instructions should be adhered to.
- 4 **Follow all instructions** – All operating and usage instructions should be followed.
- 5 **Do not use this apparatus near water** – The appliance should not be used near water or moisture – for example, in a wet basement or near a swimming pool and the like.
- 6 **Clean only with a dry cloth.**
- 7 **Do not block any ventilation openings.** Install in accordance with the manufacturer’s instructions.
- 8 Do not install near any heat sources such as radiators, heaters, stoves, or other apparatus (including amplifiers) that produce heat.
- 9 Do not defeat the safety purpose of the polarized or grounding plug. A polarized plug has two blades with one wider than the other. A grounding plug has two blades and a third grounding prong. The wide blade or

the third prong is provided for your safety. If the provided plug does not fit into your outlet, consult an electrician for replacement of the obsolete outlet.

- 10 Protect the power cord from being walked on or pinched particularly at plugs, convenience receptacles, and the point where they exit from the apparatus.
- 11 Only use attachments/accessories specified by the manufacturer.
- 12  Use only with the cart, stand, tripod, bracket or table specified by the manufacturer, or sold with the apparatus. When a cart or rack is used, use caution when moving the cart/apparatus combination to avoid injury from tip-over.
- 13 Unplug the apparatus during lightning storms or when unused for long periods of time.
- 14 Refer all servicing to qualified personnel. Servicing is required when the apparatus has been damaged in any way, such as power supply cord or plug is damaged, liquid has been spilled or objects have fallen into the apparatus, the unit has been exposed to rain or moisture, does not operate normally, or has been dropped.
- 15 This equipment is a Class II or double insulated electrical appliance. It has been designed in such a way that it does not require a safety connection to electrical earth.
- 16 The apparatus shall not be exposed to dripping or splashing. No objects filled with liquids, such as vases, shall be placed on the apparatus.
- 17 Minimum distance around the apparatus for sufficient ventilation is 5cm.
- 18 The ventilation should not be impeded by covering the ventilation openings with items, such as newspapers, table-cloths, curtains, etc...
- 19 No naked flame sources, such as lighted candles, should be placed on the apparatus.
- 20 Batteries should be recycled or disposed of as per state and local guidelines.
- 21 The use of apparatus in moderate climates.

Caution:

- Use of controls or adjustments or performance of procedures other than those described herein, may result in hazardous radiation exposure or other unsafe operation.
- To reduce the risk of fire or electric shock, do not expose this apparatus to rain or moisture. The apparatus must not be exposed to dripping or splashing and objects filled with liquids, such as vases, must not be placed on apparatus.
- The mains plug/appliance coupler is used as the disconnect device, the disconnect device must remain readily operable.
- Danger of explosion if battery is incorrectly replaced. Replace only with the same or equivalent type.

1.2 Warning

- The battery (batteries or battery pack) shall not be exposed to excessive heat such as sunshine, fire or the like.
- Before operating this system, check the voltage of this system to see if it is identical to the voltage of your local power supply.
- Do not place this unit close to strong magnetic fields.
- Do not place this unit on the amplifier or receiver.
- Do not place this unit close to damp areas as the moisture will affect the life of the laser head.
- If any solid object or liquid falls into the system, unplug the system and have it checked by qualified personnel before operating it any further.
- Do not attempt to clean the unit with chemical solvents as this may damage the finish. Use a clean, dry or slightly damp cloth.
- When removing the power plug from the wall outlet, always pull directly on the plug, never yank on the cord.
- Changes or modifications to this unit not expressly approved by the party responsible for compliance will void the user's authority to operate the equipment.
- The rating label is pasted on the bottom or back of the equipment.

~ **AC voltage:** This symbol indicates that the rated voltage marked with the symbol is AC voltage.

--- **DC voltage:** This symbol indicates that the rated voltage marked with the symbol is DC voltage.



Use only the power supplies listed in the user manual.

Battery usage CAUTION

To prevent battery leakage which may result in bodily injury, property damage, or damage to the apparatus:

- Install all batteries correctly, + and - as marked on the apparatus.
- Do not mix old and new batteries.
- Do not mix alkaline, standard (Carbon-Zinc) or rechargeable (Ni-Cd, Ni-MH, etc.) batteries.
- Remove batteries when the unit is not used for a long time.



The Bluetooth word mark and logos are registered trademarks owned by Bluetooth SIG, Inc.



The Adopted Trademarks HDMI, HDMI High-Definition Multimedia Interface, and the HDMI Logo are trademarks or registered trademarks of HDMI Licensing Administrator, Inc. in the United States and other countries.



Dolby, Dolby Audio, Dolby Atmos, and the double-D symbol are registered trademarks of Dolby Laboratories Licensing Corporation. Manufactured under license from Dolby Laboratories. Confidential unpublished works. Copyright © 2012-2020 Dolby Laboratories. All rights reserved.

FCC INFORMATION :

NOTE: This equipment has been tested and found to comply with the limits for a Class B digital device, pursuant to Part 15 of the FCC Rules. These limits are designed to provide reasonable protection against harmful interference in a residential installation. This equipment generates, uses and can radiate radio frequency energy and, if not installed and used in accordance with the instructions, may cause harmful interference to radio communications.

However, there is no guarantee that interference will not occur in a particular installation. If this equipment does cause harmful interference to radio or television reception, which can be determined by turning the equipment off and on, the user is encouraged to try to correct the interference by one or more of the following measures:

- Reorient or relocate the receiving antenna.
- Increase the separation between the equipment and receiver.
- Connect the equipment into an outlet on a circuit different from that to which the receiver is connected.
- Consult the dealer or an experienced radio / TV technician for help.

This device complies with Part 15 of the FCC Rules. Operation is subject to the following two conditions:

- (1) this device may not cause harmful interference, and
- (2) this device must accept any interference received, including interference that may cause undesired operation.

IC-Canada : CAN ICES-3(B)/NMB-3(B)

This device contains licence-exempt transmitter(s)/ receiver(s) that comply with Innovation, Science and Economic Development Canada's licence-exempt RSS(s). Operation is subject to the following two conditions:

- 1) This device may not cause interference.
- 2) This device must accept any interference, including interference that may cause undesired operation of the device.

FCC & IC Warning:

- Changes or modifications to this unit not expressly approved by the party responsible for compliance could void the user's authority to operate the equipment.
- This equipment should be installed and operated with minimum distance 20cm between the radiator & your body.

Déclaration de la FCC :

Remarque: cet équipement a été soumis à des essais et a été déclaré conforme aux limites stipulées pour un appareil numérique de classe B, conformément aux spécifications de la partie 15 du règlement de la FCC. Ces limites ont pour but d'assurer une protection raisonnable contre le brouillage nuisible dans une installation résidentielle. Cet équipement produit, utilise et peut émettre de l'énergie en radio fréquence et, s'il n'est pas installé et utilisé conformément aux directives, il peut causer un brouillage nuisible dans les communications radio.

Cependant, il est impossible de garantir qu'aucun brouillage ne se produira dans une installation particulière. Si cet équipement cause un brouillage de la réception de radio ou de télévision, ce qu'il est possible de déterminer en éteignant puis en rallumant l'équipement, l'utilisateur est prié d'essayer de corriger le brouillage au moyen de l'une ou de plusieurs des mesures suivantes :

- Réorienter ou déplacer l'antenne de réception.
- Augmenter la distance entre l'appareil et le récepteur.
- Brancher l'appareil à une prise sur un circuit différent de celui sur lequel le récepteur est branché.
- Consulter le revendeur ou un technicien radio/TV expérimenté.

Cet appareil est conforme à la partie 15 des règles de la FCC. Son fonctionnement est soumis aux deux conditions suivantes :

- (1) ce dispositif ne peut pas causer d'interférences nuisibles et
- (2) cet appareil doit accepter toute interférence reçue, y compris les interférences qui peuvent causer un mauvais fonctionnement.

IC-Canada : CAN ICES-3(B)/NMB-3(B)

L'émetteur/récepteur exempt de licence contenu dans le présent appareil est conforme aux CNR d'Innovation, Sciences et Développement économique Canada applicables aux appareils radio exempts de licence. L'exploitation est autorisée aux deux conditions suivantes :

- 1) L'appareil ne doit pas produire de brouillage;
- 2) L'appareil doit accepter tout brouillage radioélectrique subi, même si le brouillage est susceptible d'en compromettre le fonctionnement.

FCC & IC Avertissement :

- Les changements ou modifications de cet appareil non expressément approuvées par la partie responsable de la conformité pourraient annuler l'autorisation de l'utilisateur à utiliser l'équipement.
- Pour rester en conformité avec les consignes d'exposition aux RF, placez le produit à au moins 20 cm des personnes proches.

2. What's in the Box



Main Unit

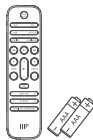

Remote Control /
AAA Batteries x 2

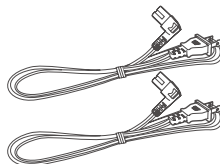

AC Power Cord x 2

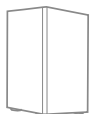

Wireless Subwoofer

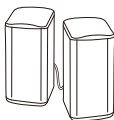

Wireless Surround



3.5mm to 3.5mm
Audio Cable

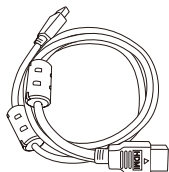

HDMI Cable



Adapter Cable



Surround Speaker Cable

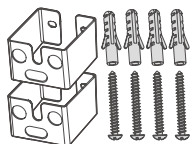

Wall Bracket
(for main unit)



Wall mounting Screw

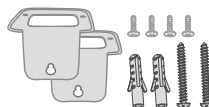

Wall Bracket
(for Surround)

- Power cord quantity and plug type vary by regions.
- Images, illustrations and drawings shown on this User Manual are for reference only, actual product may vary in appearance.

3. Identifying the Parts

3.1 Main Unit

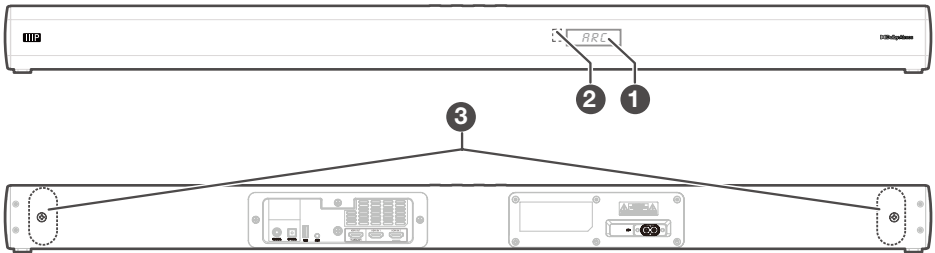

- 1 Display Window**
Show the current status.
- 2 Remote Control Sensor**
Receive signal from the remote control.
- 3 Screws**
Remove the screws then install the wall mounting screws into the back of the unit.
- 4** ⏻ (ON/OFF) button
Switch the unit between ON and Standby mode.
- 5** [SOURCE] button
Select the play function.
- 6** +/- (vol) buttons
Increase/decrease the volume level.
- 7 AC~ Socket**
Connect to power.
- 8 COAXIAL Socket**
- 9 OPTICAL Socket**
- 10 USB Socket**
Insert the USB device to play music.
- 11 AUX Socket**
Connect to an external audio device.
- 12 HDMI OUT (TV eARC/ARC) Sockets**
Connect to a TV via HDMI cable.
- 13 HDMI IN 1 / HDMI IN 2 Sockets**
Connect to HDMI OUT socket of external devices (e.g. games consoles, DVD players and blu-ray).

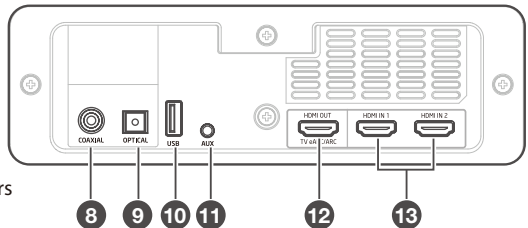
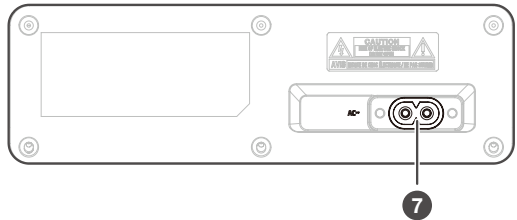
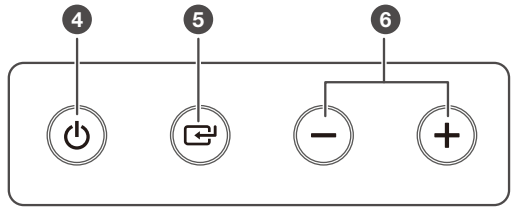

3.2 Wireless Subwoofer

- 1 **AC~ Socket**
Connect to power.
- 2 **PAIR button**
Press activate the pairing function between the main unit and the subwoofer.
- 3 **Subwoofer's PAIR Indicator**
Light stops blinking once the Subwoofer is paired with the Soundbar.

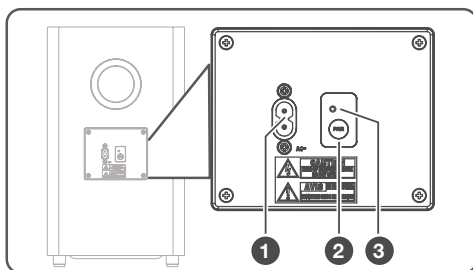

3.3 Wireless Surround

- 1 **Surround's PAIR Indicator**
Light stops blinking once the Subwoofer is paired with the Soundbar.
- 2 **DC~ Socket**
Connect to adapter.
- 3 **SPEAKER (R) Socket**
- 4 **PAIR button**
Press activate the pairing function between the main unit and the Surround.
- 5 **Screws**
Remove the screws then install the wall Bracket into the back of the unit.
- 6 **SPEAKER (L) Socket**

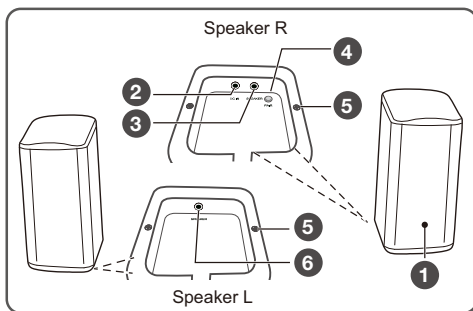

3.4 Remote Control

- 1 Switch the unit between ON and STANDBY mode.
- 2 **SOURCE** buttons
Select the play function.
- 3 **⏮ / ⏭**
Skip to previous/next track in BT/USB mode.
- 4 **⏮ | ⏭**
Play/pause/resume playback in BT/USB mode. Press and hold to activate the pairing function in Bluetooth mode or disconnect the existing paired Bluetooth device.
- 5 **BASS+/-**
Adjust bass level.
- 6 **TREBLE +/-**
Adjust treble level.
- 7 **🔊 (MUTE)**
Mute or resume the sound.
- **+/- (vol)**
Increase/decrease the volume level.
- 8 **EQ** buttons
Select Equalizer (EQ) Effect.
- 9 **SURR VOL+/-** buttons
Increase / decrease the Surround 's volume.
- 10 **AV SYNC+/-** buttons
Set the Audio Delay
- 11 **VERTICAL/SURROUND**
Adjust the surround ON/OFF.

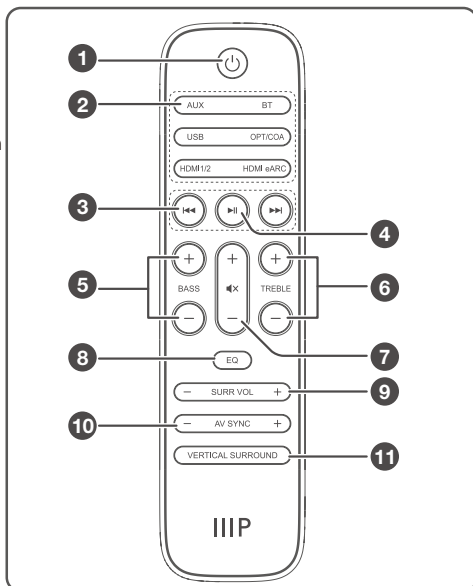

4. Preparations

4.1 Prepare the Remote Control

The provided remote control allows the unit to be operated from a distance.

- Even if the remote control is operated within the effective range 19.7 feet (6m), remote control operation may be impossible if there are any obstacles between the unit and the remote control.
- If the remote control is operated near other products which generate infrared rays, or if other remote control devices using infra-red rays are used near the unit, it may operate incorrectly. Conversely, the other products may operate incorrectly.

4.2 Replace the Remote Control Battery

- 1 Press and slide the back cover to open the battery compartment of the remote control.
- 2 Insert two **AAA** size batteries (included). Make sure the (+) and (-) ends of the batteries match the (+) and (-) ends indicated in the battery compartment.
- 3 Close the battery compartment cover.

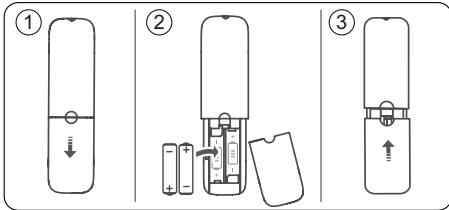

Precautions Concerning Batteries

- Be sure to insert the batteries with correct positive “⊕” and negative “⊖” polarities.
- Use batteries of the same type. Never use different types of batteries together.
- Either rechargeable or non-rechargeable batteries can be used. Refer to the precautions on their labels.
- Be aware of your fingernails when removing the battery cover and the battery.
- Do not drop the remote control.
- Do not allow anything to impact the remote control.
- Do not spill water or any liquid on the remote control.
- Do not place the remote control on a wet object.
- Do not place the remote control under direct sunlight or near sources of excessive heat.

- Remove the battery from the remote control when not in use for a long period of time, as corrosion or battery leakage may occur and result in physical injury, and/or property damage, and/or fire.
- Do not use any batteries other than those specified.
- Do not mix new batteries with old ones.
- Never recharge a battery unless it is confirmed to be a rechargeable type.

4.3 Placement and Mounting

Placement

- (A) You can place the unit on the table directly in front of the TV stand, centered with the TV screen. Or (B) you can mount the unit on the wall directly below the TV screen.
- Place the Subwoofer at least 1 meter (3 feet) away from your Soundbar, and ten centimeters away from the wall.
- Place the surround speakers in the left and right positions. For best results, place your Subwoofer & Surround as shown below.

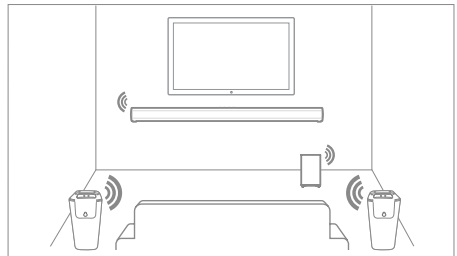

4.4 Wall Mounting (for unit)

Note:

- Installation must be carried out by qualified personnel only. Incorrect assembly can result in severe personal injury and property damage (if you intend to install this product yourself, you must check for installations such as electrical wiring and plumbing that may be buried inside the wall). It is the installer's responsibility to verify that the wall will safely support the total load of the unit and wall brackets.
- Additional tools (not included) are required for the installation.

- Do not overtighten screws.
 - Keep this instruction manual for future reference.
 - Use an electronic stud finder to check the wall type before drilling and mounting.
1. Drill 4 parallel holes (Ø 5.5-6 mm each according to wall type) in the wall. The distance between the holes should be **950 mm**.
 2. Firmly fix 1 dowel into each hole in the wall if necessary. Tighten the wall mount brackets on the wall with screws and screwdriver (not included). Make sure that they are securely installed.
- If necessary, stick the Silicone pad into the brackets to balance the machine.
3. Remove the screws at the back of the unit. Install the wall mounting screws into the back of the unit.
 4. Lift the unit onto the wall mount brackets and slot into place.

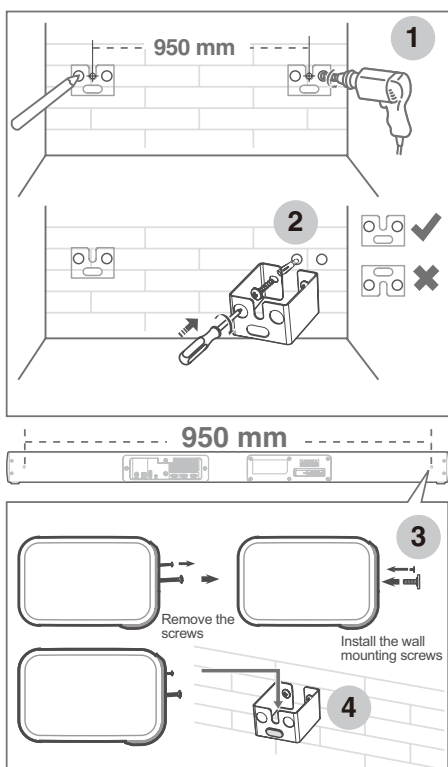

4.5 Wall Mounting (for surround)

- The (R/L) surround speakers can be fixed to the wall using the included wall mount package.
- Note: Before installing the wall bracket, you need to connect the power / speaker cables of the (R/L) surround speakers.

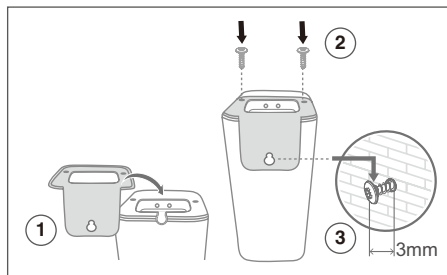

5. Connections

5.1 Dolby Atmos®

Dolby Atmos gives you immersive listening experience by delivering sound in three dimensional space, and all the richness, clarity, and power of Dolby sound. For more information, please visit dolby.com/technologies/dolby-atmos

For using Dolby Atmos®

Dolby Atmos® is available only in HDMI mode. For the details of the connection, please refer to “**HDMI Connection**”.

1. To use Dolby Atmos® in HDMI 1 and HDMI 2 mode, your TV has to support Dolby Atmos®.
2. Make sure that “No Encoding” is selected for bitstream in the audio output of the connected external device (e.g. Blu-ray DVD player, TV etc.).
3. While entering Dolby Atmos / Dolby Digital / PCM format, the soundbar will shows **DOLBY ATMOS / DOLBY AUDIO / PCM AUDIO**.

Tips:

- The full Dolby Atmos experience is only available when the Soundbar is connected to the source via a HDMI 2.0 cable.
- The Soundbar will still function when connected via other methods (such as a Digital Optical cable) but these are unable to support all of the Dolby features. Given this, our recommendation is to connect via HDMI, in order to ensure full Dolby support.

5.2 HDMI Connection

Some 4K HDR TVs require the HDMI input or picture settings to be set for HDR content reception. For further setup details on HDR display, please refer to the instruction manual of your TV.

Using HDMI to connect the soundbar, AV equipment and TV:

Method 1: eARC / ARC (Audio Return Channel)

The eARC / ARC (Audio Return Channel) function allows you to send audio from your ARC-compliant TV to your sound bar through a single HDMI connection. To enjoy the ARC function, please ensure your TV is both HDMI-CEC and ARC compliant and set up accordingly. When correctly set up, you can use your TV remote control to adjust the volume output (VOL +/- and MUTE) of the sound bar.

- Connect the HDMI cable (included) from unit's **HDMI OUT (TV eARC/eARC)** socket to the HDMI (ARC) socket on your ARC compliant TV. Then press the remote control to select **HDMI eARC**.

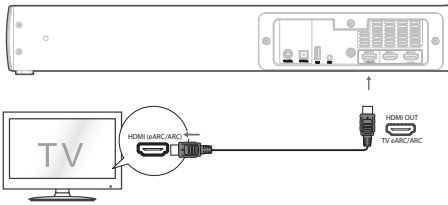

Tips:

- Your TV must support the HDMI-CEC and ARC function. HDMI-CEC and ARC must be set to On.
- The setting method of HDMI-CEC and ARC may differ depending on the TV. For details about ARC function, please refer to the owner's manual.
- Only HDMI 1.4 or higher version cable can support the ARC function.
- Your TV digital sound output S/PDIF mode setting must be PCM.

Method 2: Standard HDMI

- If your TV is not HDMI ARC-compliant, connect your soundbar to the TV through a standard HDMI connection.
1. Use an HDMI cable (included) to connect the soundbar's **HDMI OUT (TV eARC/eARC)** socket to the TV's HDMI IN socket.

2. Use an HDMI cable (not included) to connect the soundbar's **HDMI IN (1 or 2)** socket to your external devices (e.g. games consoles, DVD players and blu-ray).

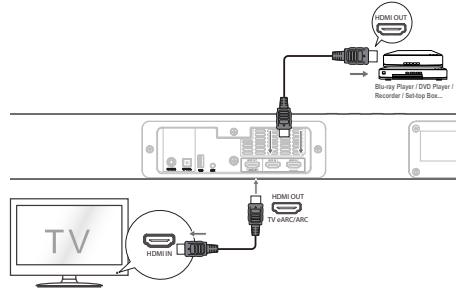

5.3 Use the OPTICAL Socket

- Remove the protective cap of the **OPTICAL** socket, then connect an OPTICAL cable (not included) to the TV's OPTICAL OUT socket and the **OPTICAL** socket on the unit.

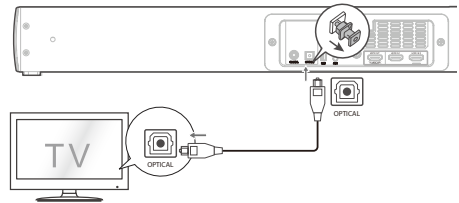

5.4 Use the COAXIAL Socket

- You also can use the COAXIAL cable (not included) to connect the TV's COAXIAL OUT socket and COAXIAL socket on the unit.

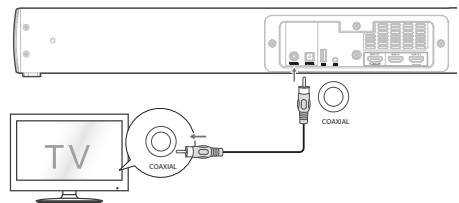

Tip: The unit may not be able to decode all digital audio formats from the input source. In this case, the unit will mute. This is NOT a defect. Ensure that the audio setting of the input source (e.g. TV, game console, DVD player, etc.) is set to **PCM** or **Dolby Digital** (Refer to the user manual of the input source device for its audio setting details) with HDMI / OPTICAL / COAXIAL input.

5.5 Use the AUX Socket

- A. Use a 3.5mm to 3.5mm audio cable (included) to connect the TV's or external audio device headphone socket to the **AUX** socket on the unit.
- B. Use a RCA to 3.5mm audio cable (not included) to connect the TV's audio output sockets to the **AUX** socket on the unit.

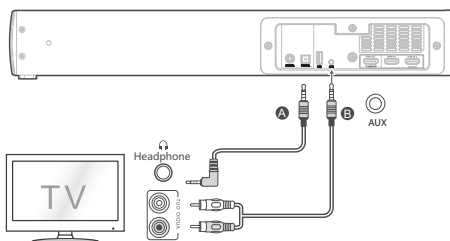

5.6 Connect Surround Speakers

1. Use the 2.5mm surround speaker cable (included) to connect to the **SPEAKER** speaker socket on the bottom of the (R / L) surround speakers.
2. Use the DC adapter, connect to the **DC IN** socket on the bottom of the main surround speakers and to a power outlet.

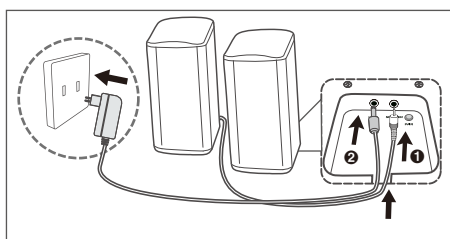

* When surround speakers are placed flat on a table, in order to prevent the vibration from falling, you need to put the power cord / speaker connection cable in the trough.

5.7 Connect Power

Risk of product damage!

- Ensure that the power supply voltage corresponds to the voltage printed on the back or the underside of the unit.
- Before connecting the AC power cord, ensure you have completed all other connections.

• Soundbar

Connect the mains cable to the AC~ socket of the main unit and then into a mains socket.

• Subwoofer

Connect the mains cable to the AC~ socket of the Subwoofer and then into a mains socket.

Note:

- If there is no power, ensure the power cord and plug are fully inserted and the power is turned on.
- Power cord quantity and plug type vary by regions.

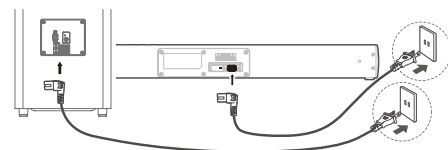

5.8 Pair up with the Subwoofer & Surround

Automatic pairing

Plug the Soundbar and the subwoofer into the mains sockets and then press **U** on the unit or remote control to switch the unit to On mode. The subwoofer and Soundbar will automatically pair.

- When the subwoofer is pairing with the Soundbar, the Pair indicator on the subwoofer will flash fast.
- When the subwoofer is paired with the Soundbar, the Pair indicator on the subwoofer will light up steadily.
- Do not press **Pair** on the rear of the subwoofer, except for manual pairing.

Manual Pairing

If no audio from the wireless subwoofer can be heard, manually pair up the subwoofer.

1. Unplug both units from the mains sockets again, then plug them in again after 3 minutes.
2. Press and hold the **PAIR** button on the rear of the subwoofer for a few seconds.
 - » The Pair indicator on the subwoofer will rapidly blink.
3. Then press **U** on the unit or remote control to switch the unit ON.

- » The Pair indicator on the subwoofer will become solid when successful.
- 4. If the Pair indicator still keeps blinking, repeat step 1-3.
- 5. If the Pair indicator blinks, the wireless connection has failed. Unplug the cable of the subwoofer and then reconnect the main cable after 4 minutes. Repeat step 1 ~ 4.

NOTE:

- The subwoofer should be within 6 m of the Soundbar in an open area (the closer the better).
- Remove any objects between the subwoofer and the Soundbar.
- If the wireless connection fails again, check if there is a conflict or strong interference (e. g. interference from an electronic device) around the location. Remove these conflicts or strong interferences and repeat the above procedures.
- If the main unit is not connected with the subwoofer and it is in ON mode, the Pair Indicator on the subwoofer will blink slowly.

6. Basic Operation

6.1 Standby/ON

When you first connect the main unit to the mains socket, the main unit will be in Standby mode.

- Press the **⏻** button on the unit or on the remote control to switch the unit ON.
- Press the **⏻** button again to switch the unit back to STANDBY mode.
- Disconnect the mains plug from the mains socket if you want to switch the unit OFF completely.
- **Auto Wake**
 - If a TV or an external device is connected (AUX / HDMI ARC), the unit will switch on automatically when the TV or the external device is switched on.
- **Automatic Power Off Function**
 - The unit automatically turns to **Standby** mode after about 15 minutes if the TV or the external unit is disconnected, switched off.
 - To switch the unit off completely, remove the mains plug from the mains socket.

- Please turn the unit off completely to save energy when not in use.

6.2 Select Modes

Press the **☐** (SOURCE) button on the unit or the **AUX, BT, OPT/COA, HDMI 1/2, HDMI eARC** and **USB** and buttons on the remote control to select the desired mode. The selected mode will shows on the display.

6.3 Adjust the Bass/Treble Level

- Press the **BASS +/-** buttons on the remote control to adjust bass level.
- Press the **TREBLE +/-** buttons on the remote control to adjust bass level.

6.4 Turn the Surround Sound ON/OFF

- Press the **VERTICAL/SURROUND** button on the remote control to turn on the surround sound. Press this button again to turn off the surround sound.

6.5 Select Equalizer (EQ) Effect

- Press the **VOICE / SPORT / MOVIE / MUSIC** buttons on the remote control to select your desired preset equalizer effects.

6.6 Adjust the Volume

• Adjust the Soundbar's Volume

Press the **+ / - (VOL)** buttons on the unit or on the remote control to adjust the volume.

If you wish to turn the sound off, press the **⏻ (MUTE)** button on the remote control. Press the **⏻ (MUTE)** button again or press the **+ / - (VOL)** buttons on the unit or on the remote control to resume normal listening.

• Adjust the Surround's Volume

Press **SURR+/-** (surround) to increase or decrease the Surround's volume level.

6.7 About the Display Brightness

- When no operation for **10** seconds, the brightness of the screen will automatically dim the brightness. When operated again, the brightest level will be automatically restored.

6.8 AV SYNC (Set the Audio Delay)

- Video image processing, sometimes longer than the time required to process the audio signal. This is called "delayed." Audio Delay feature is designed to remedy this delay.
- Set the audio delay, provided only for the current playback mode. (As provided in the HDMI eARC audio delay mode, the delay mode is valid only for the HDMI eARC).
- Press the **AV SYNC**+/- buttons on the remote control to adjust the delay time.
- AV00 ~ AV200 (By default, the audio delay is set to 00).

Tips

- In AUX / BT / USB mode, press the **AV SYNC**+/- buttons has no effect.
- The audio delay setting is only valid for digital audio (e.g HDMI 1, HDMI 2, HDMI eARC, OPTICAL, COAXIAL).

7. AUX / OPTICAL / COAXIAL / HDMI Operation

- 1 Ensure that the unit is connected to the TV or audio device.
- 2 Press the  (SOURCE) button repeatedly on the unit or the **AUX, OPT/COA, HDMI 1/2, HDMI ARC** buttons on the remote control to select the desired mode.
- 3 Operate your audio device directly for playback features.
- 4 Press the **VOL +/-** button to adjust the volume to your desired level.

Tip:

- The unit may not be able to decode all digital audio formats from the input source. In this case, the unit will mute. This is NOT a defect. Ensure that the audio setting of the input source (e.g. TV, game console, DVD player, etc.) is set to **PCM** or **Dolby Digital** (Refer to the user manual of the input source device for its audio setting details) with HDMI 1 / HDMI 2 / HDMI ARC / OPTICAL / COAXIAL input.
- In HDMI 1 / HDMI 2 mode, when entering DOLBY ATMOS audio format, the Soundbar display shows **DOLBY ATMOS**.

- When entering DOLBY DIGITAL audio format, the Soundbar display shows **DOLBY AUDIO**.
- When entering PCM audio format, the Soundbar display shows **PCM AUDIO**.
- When entering non-PCM or DOLBY DIGITAL audio formats, if there's no sound output from the unit, the display show **NONSUPPORT FORMAT**.

8. Bluetooth Operation

8.1 Pair Bluetooth-enabled Devices

The first time you connect your bluetooth device to this player, you need to pair your device to this player.

Note:

- The operational range between this player and a Bluetooth device is approximately 8 meters (without any object between the Bluetooth device and the unit).
 - Before you connect a Bluetooth device to this unit, ensure you know the device's capabilities.
 - Compatibility with all Bluetooth devices is not guaranteed.
 - Any obstacle between this unit and a Bluetooth device can reduce the operational range.
 - If the signal strength is weak, your Bluetooth receiver may disconnect, but it will re-enter pairing mode automatically.
- 1 During ON mode, press the  (SOURCE) button repeatedly on the unit or the **BT** button on the remote control to select Bluetooth mode. "**NO BT**" will show on the display if the unit is not paired to any Bluetooth device.
 - 2 Activate your Bluetooth device and select the search mode. "**SB-600**" will appear on your Bluetooth device list.
 - If you can't find the unit, press and hold the **▶|** or **BT** button on the remote control to be searchable. You will hear audio prompt from the unit and the display will show "**PAIR**".
 - 3 Select "**SB-600**" in the pairing list. After audio prompt, the system is successfully connected and the display panel shows "**BT**".

- 4 Play music from the connected Bluetooth device.

To disconnect the Bluetooth function, you can :

- Switch to another function on the unit.
- Disable the function from your Bluetooth device. The Bluetooth device will be disconnected from the soundbar after audio prompt.
- Press and hold the **▶||** or **BT** button on the remote control.

Tips:

- Enter "0000" for the password if necessary.
- If no other Bluetooth device pairs with this player within two minutes, the player will recover its previous connection.
- The player will also be disconnected when your device is moved beyond the operational range.
- If you want to reconnect your device to this player, place it within the operational range.
- If the device is moved beyond the operational range, when it is brought back, please check if the device is still connected to the player.
- If the connection is lost, follow the instructions above to pair your device to the player again.

8.2 Listen to Music from Bluetooth Device

- If the connected Bluetooth device supports Advanced Audio Distribution Profile (A2DP), you can listen to the music stored on the device through the player.
 - If the device also supports Audio Video Remote Control Profile (AVRCP), you can use the player's remote control to play music stored on the device.
1. Pair your device with the player.
 2. Play music via your device (if it supports A2DP).
 3. Use supplied remote control to control play (if it supports AVRCP).
- To pause/resume play, press the **▶||** button on the remote control.
 - To skip to a track, press the **◀◀ / ▶▶** buttons on the remote control.

9. USB Operation

- 1 Insert the USB device.

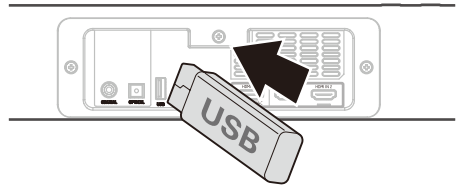

- 2 Press the **☐** (SOURCE) button repeatedly on the unit or press the **USB** button on the remote control to select **USB** mode.
- 3 During playback:
 - To pause or resume play, press the **▶||** button on the remote control.
 - To skip to the previous/next file, press the **◀◀ / ▶▶** buttons on the remote control.

Tips:

- The unit can support USB devices with up to 32 GB of memory.
- This unit can play MP3.
- USB file system should be FAT32 or FAT16.

10. Troubleshooting

To keep the warranty valid, never try to repair the system yourself. If you encounter problems when using this unit, check the following points before requesting service.

No power

- Ensure that the AC cord of the apparatus is properly connected .
- Ensure that there is power at the AC outlet.
- Press \cup (standby) button to turn the unit on.

Remote control does not work

- Before you press any playback control button, first select the correct source.
- Reduce the distance between the remote control and the unit.
- Insert the battery with its polarities (+/-) aligned as indicated.
- Replace the battery.
- Aim the remote control directly at the sensor on the front of the unit.

No sound

- Make sure that the unit is not muted. Press MUTE or VOL+/- button to resume normal listening.
- Press \cup on the unit or on the remote control to switch the soundbar to standby mode. Then press the \cup button again to switch the soundbar on.
- Unplug both the soundbar and the subwoofer from the mains socket, then plug them again. Switch on the soundbar.
- Ensure the audio setting of the input source (e.g. TV, game console, DVD player, etc.) is set to PCM or Dolby Digital mode while using digital (e.g. HDMI, OPTICAL, COAXIAL) connection.
- The subwoofer is out of range, please move the subwoofer closer to the soundbar. Make sure the subwoofer is within 5 m of the soundbar (the closer the better).
- The soundbar may have lost connection with the subwoofer. Re-pair the units by following the steps on the section "Pairing the Wireless Subwoofer with the Soundbar".
- The unit may not be able to decode all digital audio formats from the input source. In this case, the unit will mute. This is NOT a defect. device is not muted.

TV has display problem while viewing HDR content from HDMI source.

- Some 4K HDR TVs require the HDMI input or picture settings to be set for HDR content reception. For further setup details on HDR display, please refer to the instruction manual of your TV.

I can't find the Bluetooth name of this unit on my Bluetooth device for Bluetooth pairing

- Ensure the Bluetooth function is activated on your Bluetooth device.
- Ensure you have paired the unit with your Bluetooth device.

This is a 15 mins power off function, one of the ERPII standard requirement for saving power

- When the unit's external input signal level is too low, the unit will be turned off automatically in 15 minutes. Please increase the volume level of your external device.

The subwoofer is idle or the indicator of subwoofer do not light up.

- Please unplug power cord from the mains socket, and plug it in again after 4 minutes to reset the subwoofer.

11. Specifications

• Soundbar

Power Supply	100-240V~ 50/60Hz,
Power Consumption	30 W / < 0.5 W (StandBy)
MAX Output Power by speaker	25W x 2 (Left /Right) 50W (Center) 25W x 2 (Towards the top) 25W x 2 (Treble of top)
USB	5V $\overline{=}$ 500mA Hi-Speed USB (2.0) / FAT32 / FAT16 32G (max) , MP3
Dimension (WxHxD)	1032 x 75 x 110 mm
Net weight	4.0 kg
Speakers Impedance	8 Ω x 6 + 4 Ω
Audio input sensitivity	500mV
Frequency Response	120Hz - 20KHz

• Wireless Specification

Bluetooth Version / profiles	V 4.2 (A2DP, AVRCP)
Bluetooth Maximum power transmitted	\leq 5 dBm
Bluetooth Frequency bands	2400 MHz ~ 2483.5 MHz
5.8G wireless frequency range	5725 MHz ~ 5850 MHz
5.8G wireless maximum power	\leq 3dBm
Modulation	GFSK, $\pi/4$ -DQPSK, 8-DPSK, GFSK

• Wireless Subwoofer

Power Supply	100-240V~ 50/60Hz
Power Consumption	80 W / < 0.5 W (StandBy)
Output Power	180 W
Dimension (WxHxD)	240 x 420 x 240 mm
Net weight	6.0 kg
Frequency Response	40Hz - 120Hz
Impedance	3 Ω

• Wireless Surround

Adapter Mode Input	KA3601A-2401500US 100-240V~ 50/60Hz, 1.0A (Max)
Output	24V $\overline{=}$ 1500mA \diamond \leftarrow \diamond
Output Power	15 W x 2
Dimension (WxHxD)	71 x 150 x 71 mm
Net weight	1.0 kg (0.5kg x 2)
Frequency Response	120Hz - 20KHz
Impedance	8 Ω x 2

• Remote Control

Distance/Angle	6m / 30°
Battery type	AAA (1.5V X 2)

* Specification subject to change without prior notice. Measured under specific conditions.

