

OVERVIEW

The nLight® AIR rPODBA is a wireless, battery-powered wall switch including toggle and/or raise lower features with optional multi-pole control. It provides a user with local control of a lighting zone. A true wire-free switch, these single gang decorator style devices have soft-click buttons and a green LED indicator for each button. The wall switches communicate with other nLight AIR devices via radio frequency (RF). A battery-powered wall switch can work with any nLight AIR enabled fixture or power pack to provide toggle switch operation. Wall switches with the DX option have the added ability to adjust the level of any nLight AIR controlled dimmable light fixture.

FEATURES

- Powered with three off-the-shelf AAA Lithium size batteries and rated for 10 years of normal use, minimizing battery replacement. (Battery replacement with alkaline batteries does not guarantee a 10-year run time.)
- Communicates with nLight® AIR devices via radio frequency (RF) in the 900MHz spectrum
- Soft-click push-button control
- 1 or 2 on/off
- 1 or 2 raise/lower
- Batteries included and preinstalled... Just unbox and mount
- Wireless multi location dimming

CUSTOM BUTTON ENGRAVING

- Standard Button labeling is shown on back
- Custom lettering for units can be specified and ordered at: [nGrave Form](#)
- To ensure color uniformity, ordering templates facilitate specifying all buttons on a unit as custom lettered. Replacing single buttons not recommended
- Buttons may ship separately and require field installations

Warranty

Five-year limited warranty. Complete warranty terms located at:

www.acuitybrands.com/support/customer-support/terms-and-conditions

Note: Actual performance may differ as a result of end-user environment and application. Specifications subject to change without notice.



nLight® AIR rPODBA: Battery powered, Wall Switch



Note: nLight® AIR devices are only compatible with other nLight AIR enabled devices; and is not cross compatible with other nLight product lines at this time.



This item is an A+ capable component, which has been designed and tested to provide out-of-the-box luminaire compatibility with simple commissioning, when included as part of an A+ Certified™ Solution.

To learn more about A+, visit www.acuitybrands.com/aplus.

nLight, nLight AIR and the Acuity Controls and Acuity Brands logos are trademarks of Acuity Brands. Bluetooth is a trademark of Bluetooth SIG, Inc. used by Acuity Brands under license. Apple and the Apple logo are trademarks of Apple Inc. Android and Google Play are trademarks of Google, Inc. Other trademarks are property of their respective owners.

nPODBA		Example: RPODBA 2P DX WH G2		
Series	Poles & Scenes	Dimming Control	Color	Generation
RPODBA	[blank] Single Pole 2P Two Pole 2S 2 Scene control (2 buttons) 4S 4 Scene control (4 buttons)	[blank] On/off Control DX On/off + Raise/Lower Control	WH White IV Ivory AL Light Almond BK Black GY Gray RD Red	G2 Generation 2 Compatibility

ORDERING INFORMATION

ACCESSORIES

1. Available only for sample pack.

Series	# of Gangs	Color	Packaging
WS xPODA	1 GNG Single Gang	WH White	M5 5 Pack
		IV Ivory	M6 ¹ 6 Pack
		GY Gray	
		AL Light Almond	
		BK Black	
		RD Red	
		VP Variety Pack	

All rPODBA switches are shipped with wall plates, however, the following order information is available to acquire replacement wall plates.

SPECIFICATIONS

Dimensions	2.74" H x 1.68" W x 1.63" D (6.96 cm x 4.27 cm x 4.14 cm)
Weight	4.25 oz
Mounting	Single Gang Switch Box or Low Voltage Ring
Color	White, Ivory, Lt. Almond, Gray, Red, Black
Operating Temperature	-40C to 60C (Indoor Use Only)
Relative Humidity	Standard: 20 to 75% non-condensing
Radio Frequency	Dual Radio: 900Mhz & 2.4GHz
RF Transmit Power	900Mhz: +20dBm; 2.4GHz: Variable
Wireless Standard	900MHz: IEEE 802.15.4-based 2.4GHz: Version 4.0+ of the Bluetooth specification
Security	Application Data Encryption: AES-128 bit Mutual Entity Authentication Message Confidentiality Message Authentication and Replay Prevention Limited Anonymity
	Complies with California Civil Code Title 1.81.26, Security of Connected Devices, approved under Senate Bill No. 327 (2018)
Regulatory Compliance	FCC, IC, RoHS
Battery Type	3 AAA Lithium (included)
Battery Life	10 years (with Lithium batteries)
Programming Tool	Clarity PRO Mobile App

DEFAULT LABELING

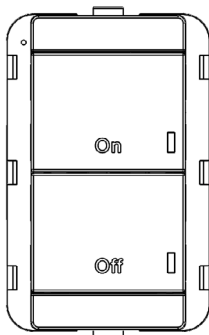

rPODBA

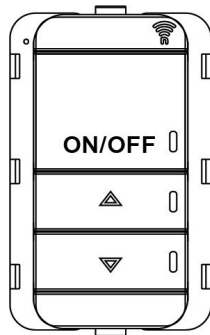

rPODBA DX

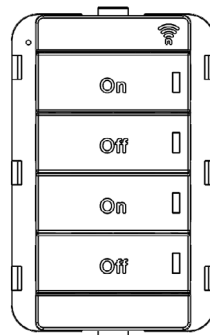

rPODBA 2P

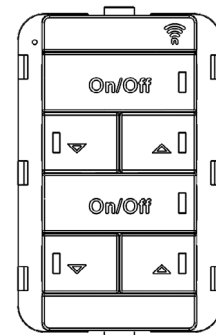

rPODBA 2P DX

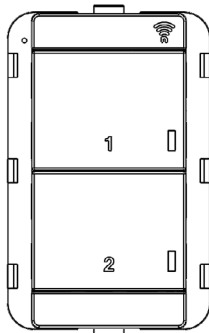

rPODBA 2S

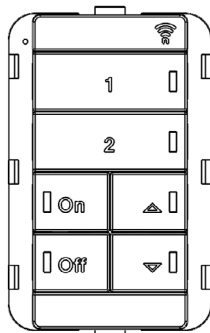

rPODBA 2S DX

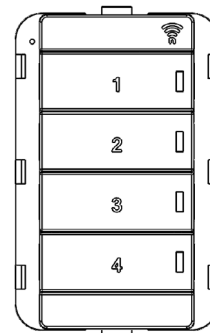

rPODBA 4S

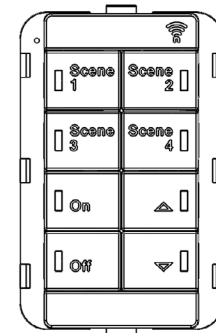

rPODBA 4S DX

INSTALLATION OVERVIEW

Installation of the rPODBA wall switch is simple, straight forward, and quick! A truly "wire-free" installation with preinstalled batteries and embedded nLight AIR radio. Follow the simple steps below to perform the mechanical installation of the rPODBA Wall Switch.

OUT-OF-THE-BOX DECORA WALL PLATE

- Remove the wall plate from the device by pulling the sides out to expand the wall plate and release it from the mounting flanges.
- Connect the unit to the gang box
 - The unit will connect to the gang box by screws, one at the top and one at the bottom
 - To ensure correct wall plate installation, drive the screws until the mounting flanges contact the wall surface. If the screws are overdriven, the mounting flanges will disengage, preventing wall plate installation. If this happens, reattach the mounting flange(s) and install to correct position. (The flanges may be reattached by inserting the two tabs in the side of the unit and pushing the part inward to engage the three snaps.)
- Reattach the wall plate
 - Expand the wall plate horizontally
 - Place the wall plate onto the unit
 - Contract the horizontally expanded wall plate onto the unit such that the side flange features seat inside the wall plate
- No wiring needed and

OFF-THE-SHELF DECORA WALL PLATE

When installing the unit with standard off-the-shelf decora wall plates, the following steps should be followed.

- Remove the Acuity wall plate from the device by pulling the sides out to expand the wall plate and releasing it from the mounting flanges.

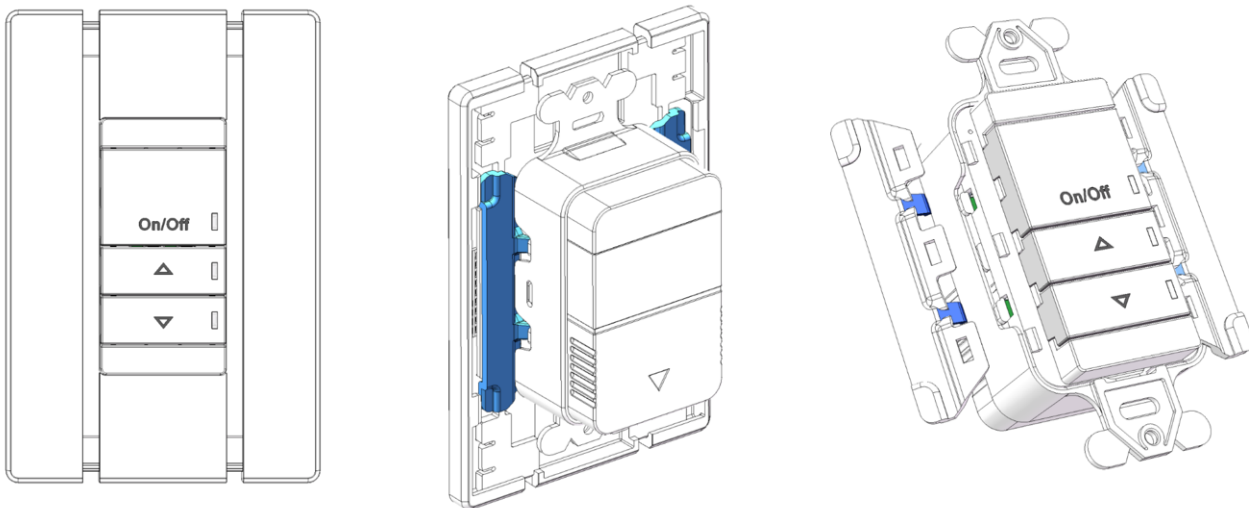

- Unhook and remove the side flanges from the device
- Connect the unit to the gang box
 - The unit will connect to the gang box by screws, one at the top and one at the bottom
- Attach the wall plate