



rPP20 Relay Pack

POWER/RELAY PACK
FAMILY INSTRUCTIONS



SPECIFICATIONS (rPP20)

Electrical Specifications

- Input Ratings** 120-277VAC
- Maximum Load** 20A general purpose, tungsten and standard ballast; 16A electronic ballast
- Dimming Load** Sinks 100mA; 0-10VDC dimmable ballasts or LED drivers; "D" 0-10V leads Class 1, "DS" 0-10V leads Class 2
- Minimum Load** None
- Class Rating** 0-10V Dimming can be wired Class 1 or 2

Mechanical

- Mounting** 1/2" Knockout (7/8" hole)
- Connection Type** Line and Low Voltage Leads

Environmental

- Warrantied Operating Temperature** -10°C to 60°C up to 5 amps; -10°C to 50°C up to 20 amps
- Standards/ Ratings** RoHS, UL 916, UL 924 (optional), FCC / IC / IFETEL

FCC ID: 2ADCB-RMODIT
IC: 6715C-RMODIT
IFETEL: RCPACRM18-1879
Acuity Brands Lighting Inc. RMODIT

This device complies with Part 15 of the FCC Rules. Operation is subject to the following two conditions: (1) This device may not cause harmful interference, and (2) this device must accept any interference received, including interference that may cause undesired operation.

Este equipo contiene el módulo con IFT #: RCPRIBM18-1491 La operación de este equipo está sujeta a las siguientes dos condiciones: (1) es posible que este equipo o dispositivo no cause interferencia perjudicial y (2) este equipo o dispositivo debe aceptar cualquier interferencia, incluyendo la que pueda causar su operación no deseada.

IMPORTANT SAFEGUARDS
WHEN USING ELECTRICAL EQUIPMENT, BASIC SAFETY PRECAUTIONS SHOULD ALWAYS BE FOLLOWED INCLUDING THE FOLLOWING:

- **DO NOT USE OUTDOORS.**
- DO NOT MOUNT NEAR GAS OR ELECTRIC HEATERS.
- EQUIPMENT SHOULD BE MOUNTED IN LOCATIONS AND AT HEIGHTS WHERE IT WILL NOT READILY BE SUBJECT TO TAMPERING BY UNAUTHORIZED PERSONNEL.
- THE USE OF ACCESSORY EQUIPMENT NOT RECOMMENDED BY THE MANUFACTURER MAY CAUSE AN UNSAFE CONDITION.

Changes or modifications not expressly approved by the party responsible for compliance could void the user's authority to operate this equipment.

This device contains licence-exempt transmitter(s)/receiver(s) that comply with Innovation, Science and Economic Development Canada's licence-exempt RSS(s). Operation is subject to the following two conditions:

1. This device may not cause interference.
2. This device must accept any interference, including interference that may cause undesired operation of the device.*

L'émetteur/récepteur exempt de licence contenu dans le présent appareil est conforme aux CNR d'Innovation, Sciences et Développement économique Canada applicables aux appareils radio exempts de licence. L'exploitation est autorisée aux deux conditions suivantes :

1. L'appareil ne doit pas produire de brouillage;
2. L'appareil doit accepter tout brouillage radioélectrique subi, même si le brouillage est susceptible d'en compromettre le fonctionnement.

NOTE: This equipment has been tested and found to comply with the limits for a Class B digital device, pursuant to part 15 of the FCC Rules. These limits are designed to provide reasonable protection against harmful interference in a residential installation. This equipment generates, uses and can radiate radio frequency energy and, if not installed and used in accordance with the instructions, may cause harmful interference to radio communications. However, there is no guarantee that interference will not occur in a particular installation. If this equipment does cause harmful interference to radio or television reception, which can be determined by turning the equipment off and on, the user is encouraged to try to correct the interference by one or more of the following measures:

1. Reorient or relocate the receiving antenna.
2. Increase the separation between the equipment and receiver.
3. Connect the equipment into an outlet on a circuit different from that to which the receiver is connected.
4. Consult the dealer or an experienced radio/TV technician for help.

READ AND FOLLOW ALL SAFETY INSTRUCTIONS!
SAVE THESE INSTRUCTIONS AND DELIVER TO OWNER AFTER INSTALLATION



Expanding the boundaries of lighting™



TITLE 20/24

WARRANTY

5-year limited warranty.

Full warranty terms located at: www.acuitybrands.com/CustomerResources/Terms_and_conditions.aspx
NOTE: Specifications subject to change without notice.

Actual performance may differ as a result of end-user environment and application.

- To reduce the risk of death, personal injury or property damage from fire, electric shock, falling parts, cuts/abrasions, and other hazards please read all warnings and instructions included with and on the fixture box and all fixture labels.
- Before installing, servicing, or performing routine maintenance upon this equipment, follow these general precautions.
- Installation and service should be performed by a qualified licensed electrician.
- Maintenance should be performed by qualified person(s) familiar with the products' construction & operation & any hazards involved. Regular maintenance programs recommended.
- To be installed to a circuit with overvoltage control to Overvoltage category Cat.III or less, minimum suppression rating 6.0 kV for a 600 V ac rms system voltage
- **DO NOT INSTALL DAMAGED PRODUCT!** This product has been properly packed so that no parts should have been damaged during transit. Inspect to confirm. Any part damaged or broken during or after assembly should be replaced.



CAUTION - RISK OF PRODUCT DAMAGE

- ✓ Electrostatic Discharge (ESD): ESD can damage product(s). Personal grounding equipment should be worn during all installation or servicing of the unit.
- ✓ Do not touch individual electrical components, as this can cause ESD and affect product performance.
- ✓ Do not stretch or use cable sets that are too short or are of insufficient length.
- ✓ Do not tamper with contacts.
- ✓ Do not modify the product.
- ✓ Do not change or alter internal wiring or installation circuitry.
- ✓ Do not use product for anything other than its intended use.

WARNING - RISK OF ELECTRIC SHOCK

- ✓ Disconnect or turn off power before installation or servicing.
- ✓ Verify that supply voltage is correct by comparing it with the product information.
- ✓ Make all electrical and grounded connections in accordance with the National Electrical Code (NEC) and any applicable local code requirements.
- ✓ All wiring connections should be capped with UL approved recognized wire connectors.
- ✓ All unused connector openings must be capped.

WARNING - RISK OF BURN OR FIRE

- ✓ Do not exceed maximum wattage, ratings, or published operation conditions of product.
- ✓ Do not overload.
- ✓ Follow all manufacturer's warnings, recommendations and restrictions to ensure proper operation of product.

CAUTION - RISK OF INJURY

- ✓ Wear gloves and safety glasses at all times when installing, servicing or performing maintenance.



rPP20 Relay Pack

POWER/RELAY PACK
FAMILY INSTRUCTIONS



OVERVIEW

nLight AIR **rPP/rPP20** is a device that provides on/off switching and dimming for light fixtures. It is suitable for control of commercial and industrial light fixtures in indoor environments. When installed as part of an nLight AIR lighting control system, the **rPP/rPP20** will respond to wireless commands from other devices, to be programmed during startup.

INSTALLATION INSTRUCTIONS

REQUIRED TOOLS & SUPPLIES

- Electrical Pliers
- Screwdriver
- Wire nuts
- Electrical box
- 2mm Precision Slotted Screwdriver, used for 24V terminals only



INSTALLATION STEPS

1. Turn power off at circuit breaker.
2. Install electrical box in accordance with state, local and national electrical codes and requirements.
3. Remove knock-out from side of electrical box.
4. Remove retaining nut and washer from power pack mounting nipple.
5. Feed Class 1* wires and mounting nipple through knockout hole.
6. Install washer and thread retaining nut onto nipple, and hand-tighten to wall of electrical box, then apply additional quarter-turn tightening with pliers.
7. Using wire nuts, connect line and low voltage wires as shown in the applicable wiring diagram in accordance to state, local and national codes and requirements.
8. "24V" models only: Connect +/- DC power leads from nLight AIR sensor(s) to 24VDC terminal block on side of rPP enclosure, if needed. See diagrams below for additional details.
9. For Chicago Plenum models only: Connect the antenna with the gasket to the inside of the sealed box, with the retaining nut on the outside of the box, as illustrated. Once installed, the antenna is IP 67 rated.
10. Install electrical box cover plate before restoring power.

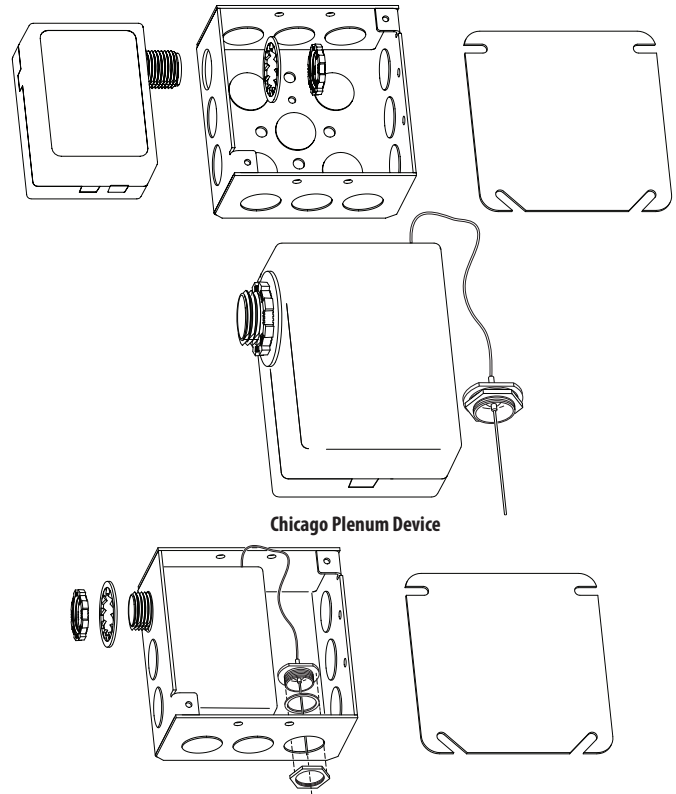

Chicago Plenum Device

*DS option provides Class 2 low voltage dimming wires on side of enclosure opposite from chase nipple.

*For Chicago Plenum option, see step 9.

INITIAL OPERATION

Following power up, the relay shall close to energize the load. The dimming output shall be at 100% light output. The device shall remain in this state until programmed with Clairity Pro mobile application. See Clairity Pro User Guide for additional programming information.

For Emergency Variant ER

The RPP/RPP20 ER version is a UL924 listed device that is powered on the Emergency circuit and provides full light output (at user-defined high-trim level) in absence of AC voltage on Normal Power sense leads. Normal operation of the control device is restored when AC line voltage is restored to the normal power sensing leads.

TROUBLESHOOTING TIPS

Device cannot be viewed in Clairity Pro

1. Press user button for specified time to reset the device to place the device in Maintenance Mode
2. Once the user-button LED confirms that the RP20 is in Maintenance Mode, open the Clairity Pro application and search for the device in Clairity Pro.
 - a. If you still cannot see the device in Clairity Pro, contact Technical Support for additional assistance; device may need to be replaced.
3. Once the device is identifiable Clairity Pro, attempt to group or configure the device. If you are still having issues, refer to the Clairity Pro User Manual or contact Technical Support for assistance using Clairity Pro to complete programming of your device.

For further troubleshooting guidance, please contact the Controls Technical Support Team

1(800)-535-2465



rPP20 Relay Pack

POWER/RELAY PACK
FAMILY INSTRUCTIONS



USER BUTTON

On the side of the controller is a lighted user button. This button can be used for testing and re-programming purposes.

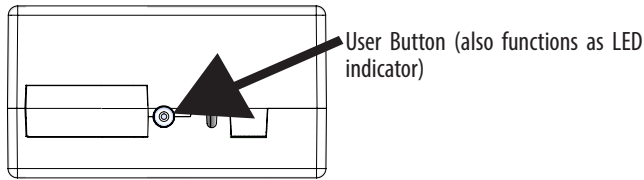

UL924 Test (ER model only)

Use this test to confirm that the lighting load is properly connected and provides the necessary output in event of loss of power.

1. Press and Release the button.
2. Relay will close and dimming output will go to full brightness for 4 seconds.
3. After 4 seconds expires, the device returns to its previous state and the indicator LED shuts off.

LED Diagnostics

The LED is illuminated whenever the button is depressed, and blinks to confirm the start of maintenance mode. Depress the button from the side to view LED and confirm that the device is operational.

Maintenance Mode

Use this mode if you are unable to identify this device within the Clarity Pro application.

1. Press and hold button for 10 seconds, then release. LED will begin to flash rapidly after 10 seconds and stop flashing when the button is released.
2. Immediately press and hold button again for 10 seconds, then release. LED will begin to flash rapidly after 10 seconds and stop flashing when the button is released.
3. The LED will flash twice to confirm entry into Maintenance Mode.

For 60 minutes, the device becomes identifiable in the Clarity Pro app and available for direct connection from mobile app to device (without requiring Group Monitor to be present, in case of a fault or connectivity issue with the Group Monitor).

Clarity Pro can then be used to perform functions such as:

- * Reprogram device settings
- * Reset device network settings
- * Firmware update
- * General troubleshooting and diagnostic functions

WIRING (DO NOT WIRE HOT)

RPP 24V

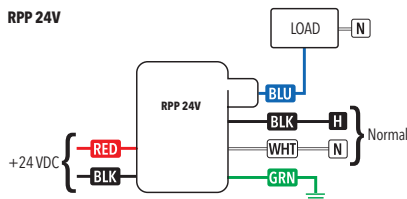

RPP DS 24V

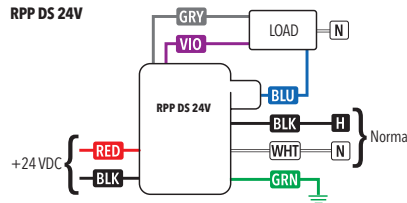

RPP D/DS 24V ER

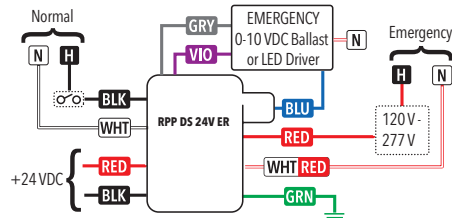

RPP D/DS 24V EM

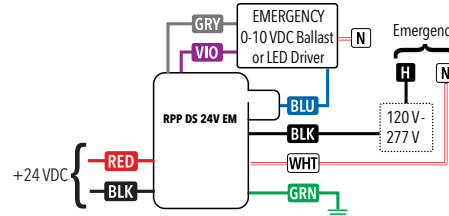

Legend

- RED - 120-277VAC Emergency Hot
- WHT/RED - Emergency Neutral
- BLK - Unswitched Norm. Hot*
- WHT - Norm. Neutral*
- BLU - Switched Output
- VIO - 0-10V Dim (+)
- GRY - 0-10V Com (-)
- RED (Terminal) - +24VDC
- BLK (Terminal) - DC Com
- GRN - Ground
- Optional Test Switch (by others)

* Emergency on EM devices

Do NOT wire while connected to live power, damage may occur.

UL924 Sequence of Operation

ER Units: When normal power sense leads have absence of voltage

EM Units: For 90 minutes following any complete AC power interruption 30 ms:

- Relay is closed and 0-10V dimming is at high end trim level
- Device ignores wireless lighting control commands
- 24VDC output is disabled

USING 24 VDC TERMINALS (24V models only)

Connecting Wire to 24V Terminals

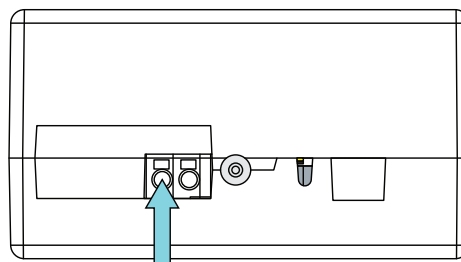

Strip length: 3/8"
Solid or tinned leads only
16-20 AWG

1. Strip jacket to correct length, then insert firmly into terminal hole.
2. Gently pull to confirm that terminal has securely captured wirelead.

Removing Wire from 24V Terminals

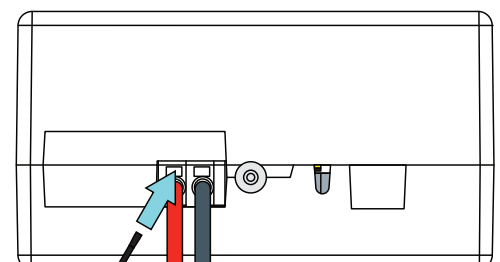

Max screwdriver size: 2mm

1. Insert precision slotted screwdriver into terminal slot.
2. Gently press screwdriver into terminal, then gently pull wire to remove.