

DFS TEST REPORT

Applicant: Libre Wireless Technologies Inc.

Address of Applicant: R2100 Geng Road, Suite 210 Palo Alto, CA 94303, USA

Equipment Under Test (EUT)

Product Name: WiFi Media Streaming Module

Model No.: LS9AD-AC11DBT, LS9AD-AC11DBT-V, LS9AD-AC11DBT-GV

Trade mark:



FCC ID: 2ADBM-LS9ADAC11DBT

Date of Test: FCC CFR Title 47 Part 15 Subpart E Section 15.407

Date of report issued: 01 Jul., 2017

Test Result: 01 Jul., to 11 Jul., 2017

*In the configuration tested, the EUT complied with the standards specified above.

Authorized Signature:

A blue circular stamp from CCIS (Shenzhen Zhongjian Nanfang Testing Co., Ltd.) is overlaid on a handwritten signature in black ink. The stamp contains the text "SHENZHEN ZHONGJIAN NANFANG TESTING CO., LTD." around the perimeter and "CCIS" in the center.

Bruce Zhang

Laboratory Manager

This report details the results of the testing carried out on one sample. The results contained in this test report do not relate to other samples of the same product and does not permit the use of the CCIS product certification mark. The manufacturer should ensure that all products in series production are in conformity with the product sample detailed in this report.

This report may only be reproduced and distributed in full. If the product in this report is used in any configuration other than that detailed in the report, the manufacturer must ensure the new system complies with all relevant standards.

This document cannot be reproduced except in full, without prior written approval of the Company. Any unauthorized alteration, forgery or falsification of the content or appearance of this document is unlawful and offenders may be prosecuted to the fullest extent of the law. Unless otherwise stated the results shown in this test report refer only to the sample(s) tested and such sample(s) are retained for 90 days only.

2 Version

Version No.	Date	Description
00	11 Jul., 2017	Original

Tested by:



Test Engineer

Date:

11 Jul., 2017

Reviewed by:



Project Engineer

Date:

11 Jul., 2017

3 Contents

	Page
1 COVER PAGE.....	1
2 VERSION	2
3 CONTENTS	3
4 TEST SUMMARY.....	4
5 GENERAL INFORMATION.....	5
5.1 CLIENT INFORMATION	5
5.2 GENERAL DESCRIPTION OF E.U.T.	5
5.3 DESCRIPTION OF SUPPORT UNITS.....	6
5.4 LABORATORY FACILITY	6
5.5 LABORATORY LOCATION	6
5.6 TEST INSTRUMENTS LIST.....	6
5.7 TEST ENVIRONMENT.....	6
6 DFS TECHNICAL REQUIREMENTS.....	7
6.1 DFS PARAMETERS	7
6.2 DFS TECHNICAL REQUIREMENTS	9
6.3 DFS THRESHOLD LEVEL	9
6.4 TEST SETUP BLOCK.....	9
6.5 EUT CONFIGURATION FOR DFS TEST.....	10
7 TEST RESULT	11
7.1 VERIFICATION OF RADAR TYPE AND LEVEL.....	11
7.2 CHANNEL MOVE TIME AND CHANNEL CLOSING TRANSMISSION TIME.....	18
7.3 NON-OCCUPANCY PERIOD	19
8 EUT CONSTRUCTIONAL DETAILS	20

4 Test Summary

Test Items	Limit	Result
Channel Availability Check	> 60 seconds	N/A
UNII Detection Bandwidth	> 100% of the UNII 99% transmission power bandwidth	N/A
Statistical Performance Check	Radar type 1,2,3,4 \geq 60% Aggregate Radar type 1~4 and 5 \geq 80% Radar type 6 \geq 70%	N/A
Channel Move Time	< 10 seconds	Pass
Channel Closing Transmission Time	< 20ms + aggregate of 60ms over remaining 10 second period	Pass
Non-Occupancy Period	> 30 minutes	Pass
Note: "Pass" means meet the requirements, "N/A" means not applicable		

5 General Information

5.1 Client Information

Applicant:	Libre Wireless Technologies Inc.
Address:	R2100 Geng Road, Suite 210 Palo Alto, CA 94303, USA
Manufacturer	Shenzhen Zowee Technology Co., Ltd.
Address:	NO.5 Zowee technology building, Science & Technology industrial park of privately owned enterprises, Pingshan, Xili, Nanshan district, Shenzhen
Factory:	Shenzhen Zowee Technology Co., Ltd.
Address:	No 149, Tongfuyu Industrial Zone Songgang, Baoan District Shenzhen Guangdong 518105 China

5.2 General Description of E.U.T.

Product Name:	WiFi Media Streaming Module
Model No.:	LS9AD-AC11DBT, LS9AD-AC11DBT-V, LS9AD-AC11DBT-GV
Transmitter frequency range:	5150MHz~5250MHz, 5250MHz~5350MHz, 5470MHz~5725MHz
Modulation type:	OFDM
WLAN Function:	802.11a/802.11n/802.11ac
Bandwidth:	20MHz/40MHz/80MHz
Antenna Type:	Internal Antenna
Antenna Gain:	5.9 dBi
DFS Operation Type:	<input type="checkbox"/> Master Device <input type="checkbox"/> Slaver Device with Radar detection function <input checked="" type="checkbox"/> Slaver Device without Radar detection function
Power supply:	DC 3.3V
Remark:	<p>The No.: LS9AD-AC11DBT, LS9AD-AC11DBT-V, LS9AD-AC11DBT-GV were identical inside, the electrical circuit design, layout, components used and internal wiring, with only difference being model name, DDR3, Flash for different customer</p> <p>LS9AD-AC11DBT: this is the standard LS9AD, and this is the variant used for testing at the BTL laboratory. Memory Configuration - 256MB Flash/ 256MB DDR3.</p> <p>LS9AD-AC11DBT-V: this variant is the same as the standard except for the memory configuration. Memory Configuration - 256MB Flash / 512MB DDR3. LS9AD-AC11DBT-V with different shield design.</p> <p>LS9AD-AC11DBT-GV: this variant is the same as the standard except for the memory configuration. Memory Configuration - 512MB Flash / 512MB DDR3.</p> <p>Base on the differences description, We chose LS9AD-AC11DB model No. as the main test, Conducted Emission and Spurious Emission was re-tested for LS9AD-AC11DBT-V and LS9AD-AC11DBT-GV.</p>

5.3 Description of Support Units

Manufacturer	Description	Model	Serial Number
LENOVO	Laptop	SL510	2847A65
WAVLINK	WiFi Router	WL-WN575A2	WL1512260097

5.4 Laboratory Facility

The test facility is recognized, certified, or accredited by the following organizations:

● **FCC - Registration No.: 817957**

Shenzhen Zhongjian Nanfang Testing Co., Ltd. EMC Laboratory has been registered and fully described in a report filed with the (FCC) Federal Communications Commission. The acceptance letter from the FCC is maintained in out files. Registration 817957, February 27, 2012.

● **IC - Registration No.: 10106A-1**

The 3m Semi-anechoic chamber of Shenzhen Zhongjian Nanfang Testing Co., Ltd. has been Registered by Certification and Engineering Bureau of Industry Canada for radio equipment testing with Registration No.: 10106A-1.

● **CNAS - Registration No.: CNAS L6048**

Shenzhen Zhongjian Nanfang Testing Co., Ltd. is accredited to ISO/IEC 17025:2005 General Requirements for the Competence of Testing and Calibration laboratories for the competence of testing. The Registration No. is CNAS L6048.

5.5 Laboratory Location

Shenzhen Zhongjian Nanfang Testing Co., Ltd.
 Address: No. B-C, 1/F., Building 2, Laodong No.2 Industrial Park, Xixiang Road,
 Bao'an District, Shenzhen, Guangdong, China
 Tel: +86-755-23118282, Fax: +86-755-23116366
 Email: info@ccis-cb.com, Website: http://www.ccis-cb.com

5.6 Test Instruments list

Test Equipment	Manufacturer	Model No.	Serial No.	Cal. Due date(mm-dd-yy)
Spectrum Analyser	Agilent	N9020A	MY50510123	10-23-2017
Vector Signal Generator	Agilent	N5182A	MY49060014	10-23-2017
RF Switch Unit	Ascentest	AT890-RFB	--	--
DFS Test Software	Ascentest	AT890	--	--
N7607B Signal Studio	KEYSIGHT	--	Version 2.0.0.1	--

5.7 Test Environment

Temperature:	20 ~ 25 °C
Humidity:	60% ~ 65%
Atmospheric pressure:	1012 kPa

6 DFS Technical Requirements

6.1 DFS Parameters

Table D.1: Applicability of DFS Requirements Prior to Use of a Channel			
Requirement	Operational Mode		
	Master	Client Without Radar Detection	Client With Radar Detection
Non-Occupancy period	Yes	Not required	Yes
DFS Detection Threshold	Yes	Not required	Yes
Channel Availability Check Time	Yes	Not required	Not required
U-NII Detection Bandwidth	Yes	Not required	Yes

Table D.2: Applicability of DFS requirements during normal operation		
Requirement	Operational Mode	
	Master	Client Without Radar Detection
DFS Detection Threshold	Yes	Not required
Channel Closing Transmission Time	Yes	Yes
Channel Move Time	Yes	Yes
U-NII Detection Bandwidth	Yes	Not required

Additional requirements for devices with multiple bandwidth modes	Operational Mode	
	Master Device or Client with Radar Detection	Client Without Radar Detection
U-NII Detection Bandwidth and Statistical Performance Check	All BW modes must be tested	Not required
Channel Move Time and Channel Closing Transmission Time	Test using widest BW mode available	Test using the widest BW mode available for the link
All other tests	Any single BW mode	Not required

Note: Frequencies selected for statistical performance check (Section 7.8.4) should include several frequencies within the radar detection bandwidth and frequencies near the edge of the radar detection bandwidth. For 802.11 devices it is suggested to select frequencies in each of the bonded 20 MHz channels and the channel center frequency.

Table D.3: DFS Detection Thresholds	
Maximum Transmit Power	Value (See Notes 1,2, and 3)
EIRP \geq 200 mW	-64 dBm
EIRP < 200 mW and power spectral density < 10 dBm/MHz	-62 dBm
EIRP < 200 mW that do not meet the power spectral density requirement	-64 dBm

Note 1: This is the level at the input of the receiver assuming a 0 dBi receive antenna.
 Note 2: Throughout these test procedures an additional 1 dB has been added to the amplitude of the test transmission waveforms to account for variations in measurement equipment. This will ensure that the test signal is at or above the detection threshold level to trigger a DFS response.
 Note3: EIRP is based on the highest antenna gain. For MIMO devices refer to KDB Publication 662911 D01.

Parameter	Value
Non-occupancy period	Minimum 30 minutes
Channel Availability Check Time	60 seconds
Channel Move Time	10 seconds (See Note 1)
Channel Closing Transmission Time	200 ms + an aggregate of 60ms over remaining 10 second period (See Notes 1 and 2)
U-NII Detection Bandwidth	Minimum 100% of the UNII 99% transmission power bandwidth (See Note 3)

Note 1: Channel Move Time and the Channel Closing Transmission Time should be performed with Radar Type 0. The measurement timing begins at the end of the Radar Type 0 burst.

Note 2: The Channel Closing Transmission Time is comprised of 200 milliseconds starting at the beginning of the Channel Move Time plus any additional intermittent control signals required to facilitate a Channel move (an aggregate of 60 milliseconds) during the remainder of the 10 second period. The aggregate duration of control signals will not count quiet periods in between transmissions.

Note 3: During the U-NII Detection Bandwidth detection test, radar type 0 should be used. For each frequency step, the minimum percentage of detection is 90 percent. Measurements are performed with no data traffic.

Radar Type	Pulse Width (µsec)	PRI (µsec)	Number of Pulses	Minimum Percentage of Successful Detection	Minimum Number of Trials
0	1	1428	18	See Note 1	See Note 1
1	1	Test A Test B	Roundup $\left\{ \begin{matrix} \frac{1}{360} \\ \frac{19 \cdot 10^6}{PRI_{\mu sec}} \end{matrix} \right\}$	60%	30
2	1-5	150-230	23-29	60%	30
3	6-10	200-500	16-18	60%	30
4	11-20	200-500	12-16	60%	30
Aggregate (Radar Types 1-4)				80%	120

Note 1: Short Pulse Radar Type 0 should be used for the detection bandwidth test, channel move time, and channel closing time tests.

Radar Type	Pulse Width (µsec)	Chirp Width (MHz)	PRI (µsec)	Number of Pulses per Burst	Number of Bursts	Minimum Percentage of Successful Detection	Minimum Number of Trials
5	50-100	5-20	1000-2000	1-3	8-20	80%	30

Long Pulse Radar Test Signal Wave form 12 second transmission

Radar Type	Pulse Width (µsec)	PRI (µsec)	Pulses per Hop	Hopping Rate (kHz)	Hopping Sequence Length (msec)	Minimum Percentage of Successful Detection	Minimum Number of Trials
6	1	333	0	0.333	300	70%	30

6.2 DFS Technical Requirements

Requirement	DFS Operational mode		
	<input type="checkbox"/> Master	<input checked="" type="checkbox"/> Slave without Radar Detection	<input type="checkbox"/> Slave with Radar Detection
Channel Availability Check	√	Not Required	Not Required
UNII Detection Bandwidth	√	Not Required	√
Statistical Performance Check	√	Not Required	√
Channel Move Time	√	√	√
Channel Closing Transmission Time	√	√	√
Non-Occupancy Period	√	√	√

6.3 DFS Threshold Level

DFS Threshold Level	
5250MHz ~ 5350MHz	-62 dBm @ antenna connector
5470MHz ~ 5725MHz	-62 dBm @ antenna connector
Note: The worst case level was selected to perform the test.	

6.4 Test Setup Block

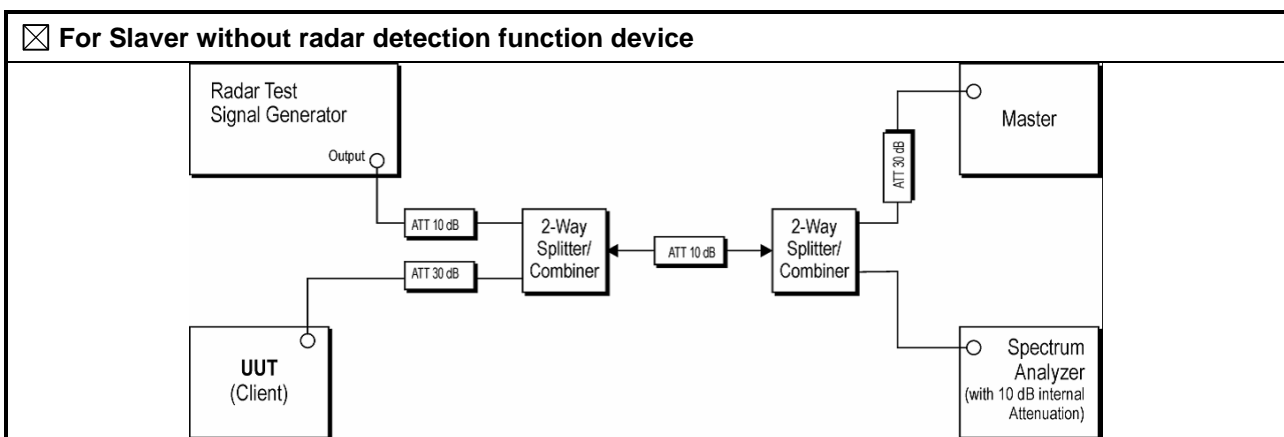
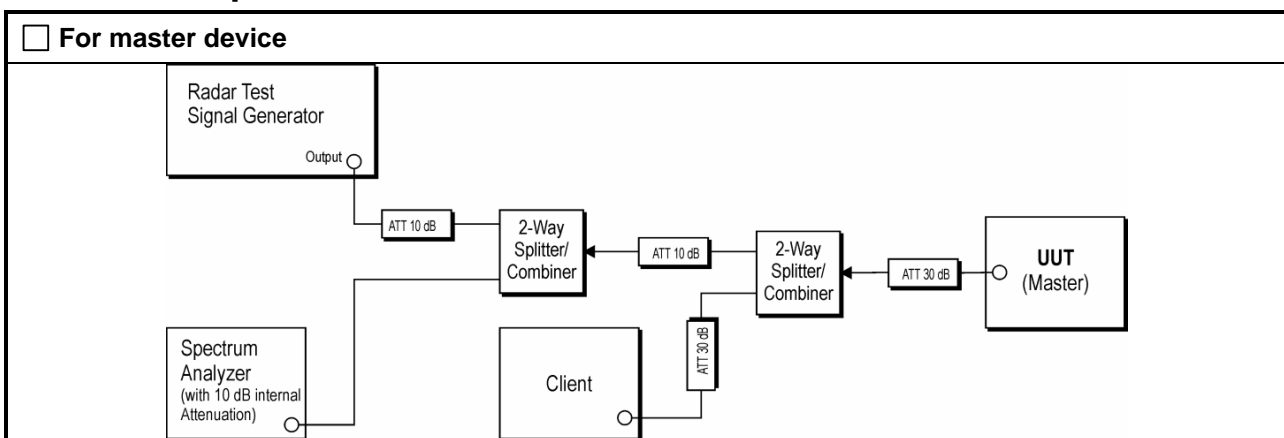

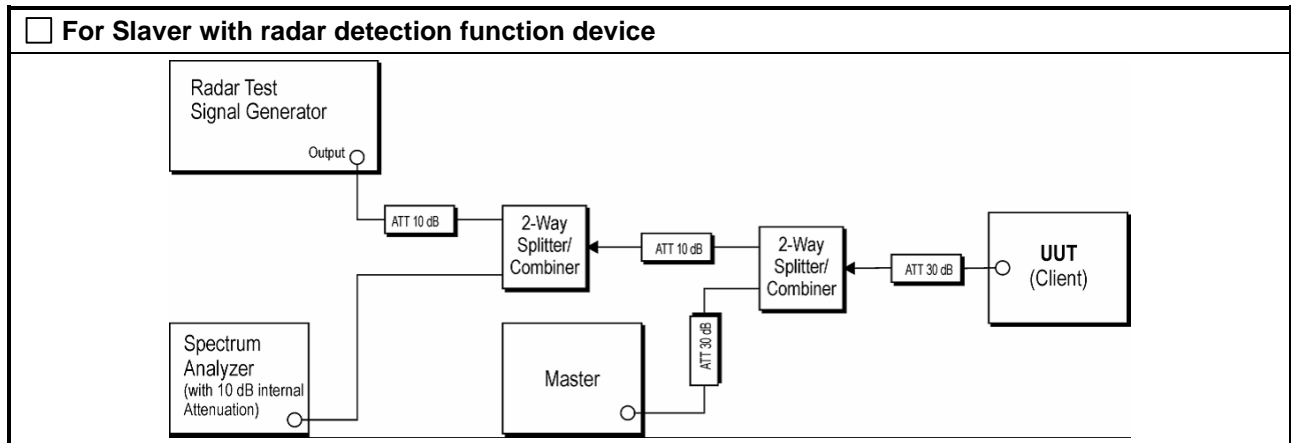

6.5 EUT Configuration for DFS Test

Test Items	Channel Frequency
Channel Move Time	5290MHz, 5530MHz
Channel Closing Transmission Time	5290MHz, 5530MHz
Non-Occupancy Period	5290MHz, 5530MHz

7 Test Result

7.1 Verification of Radar Type and Level

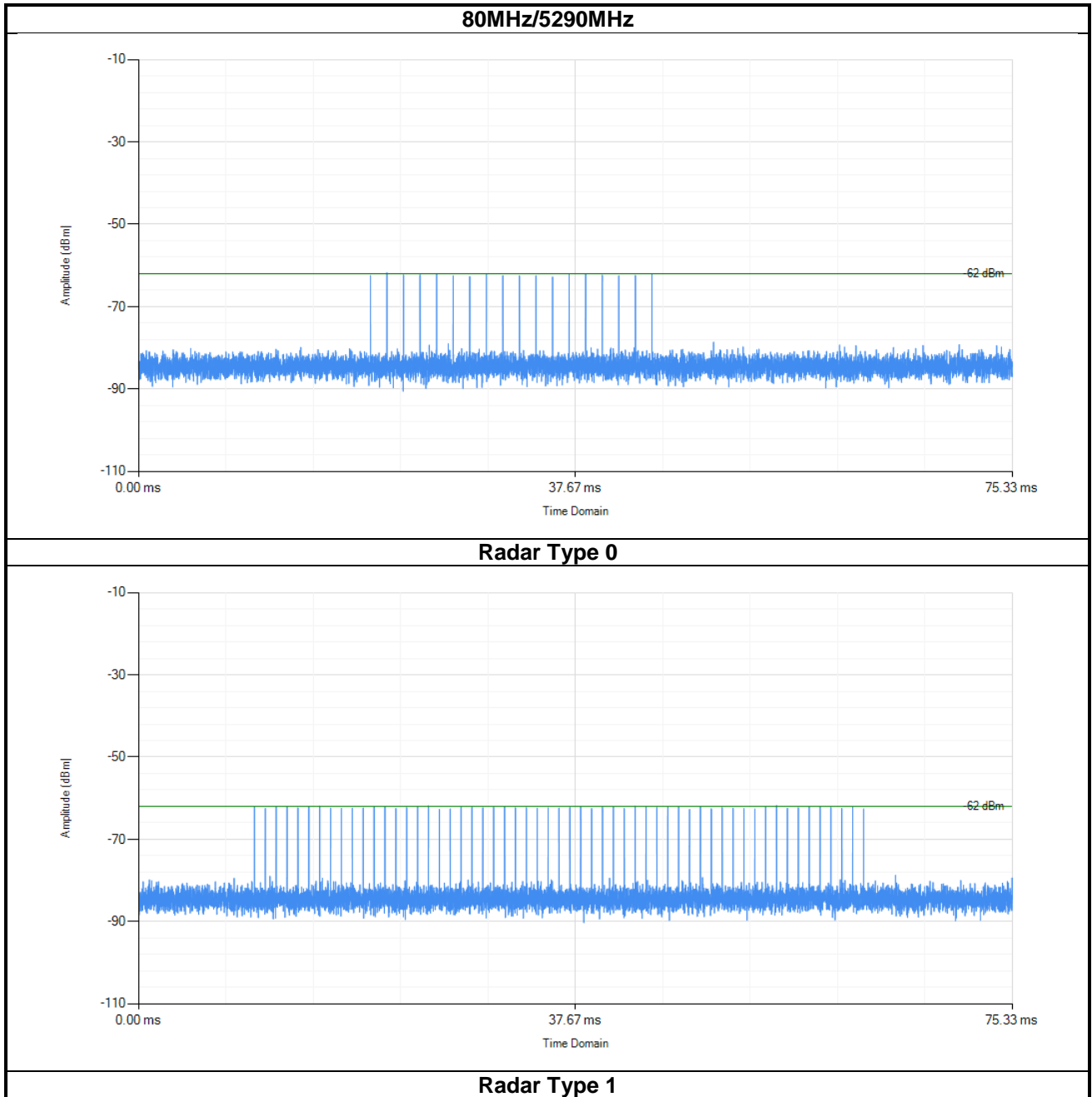

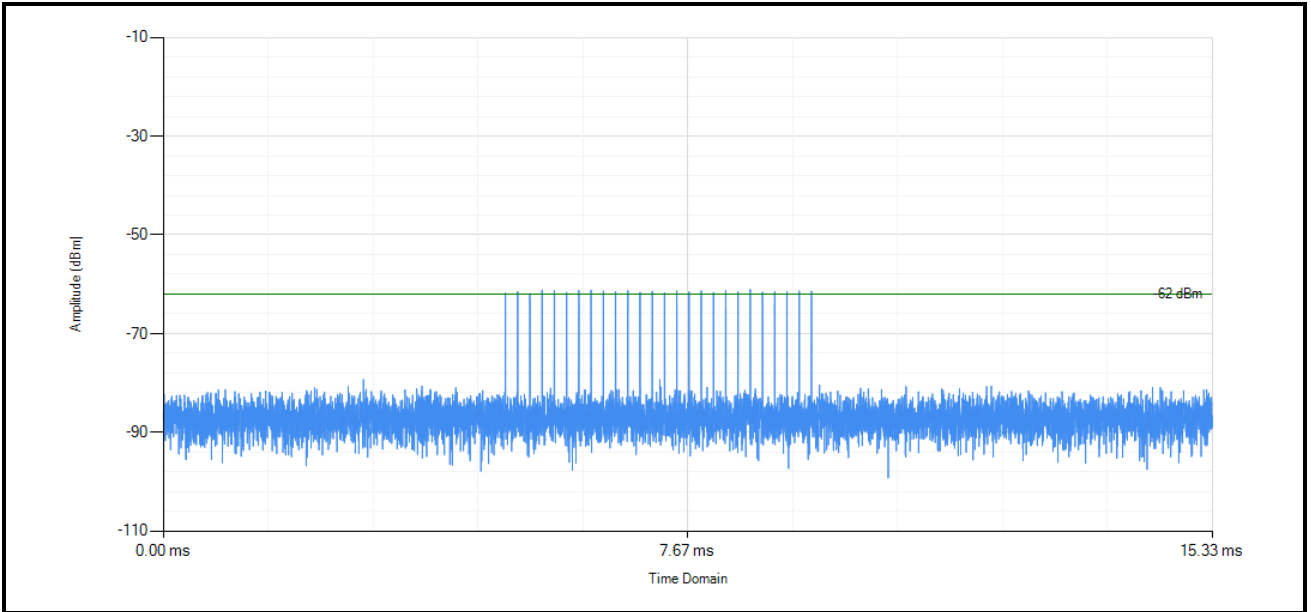

Radar Type 2

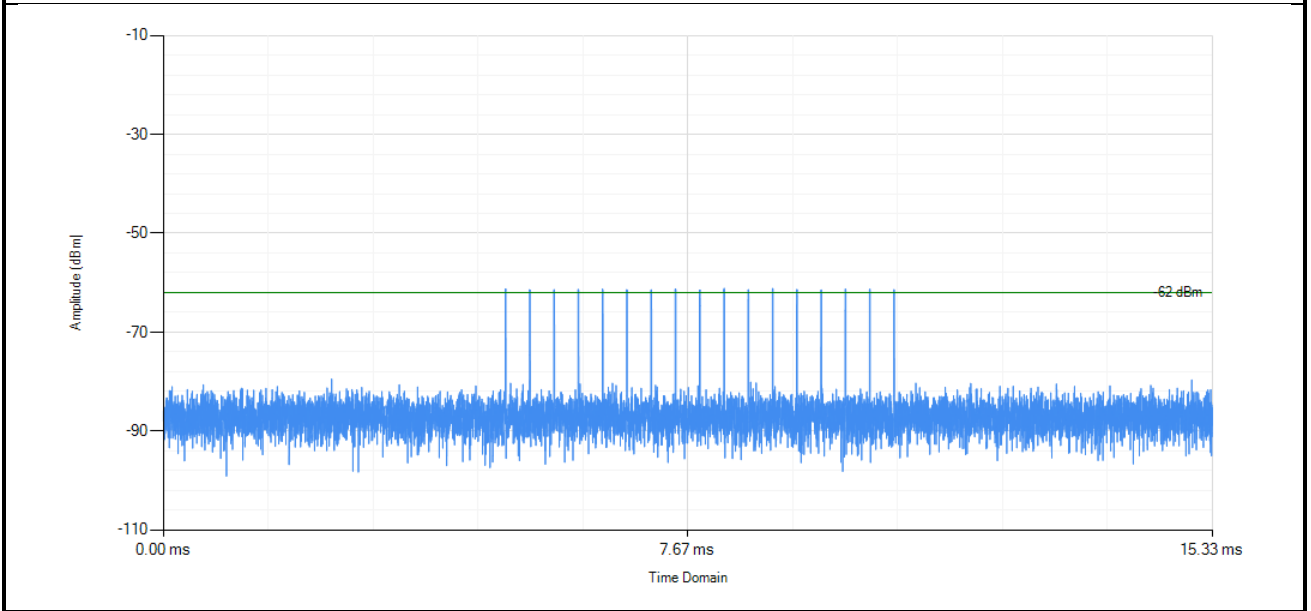

Radar Type 3

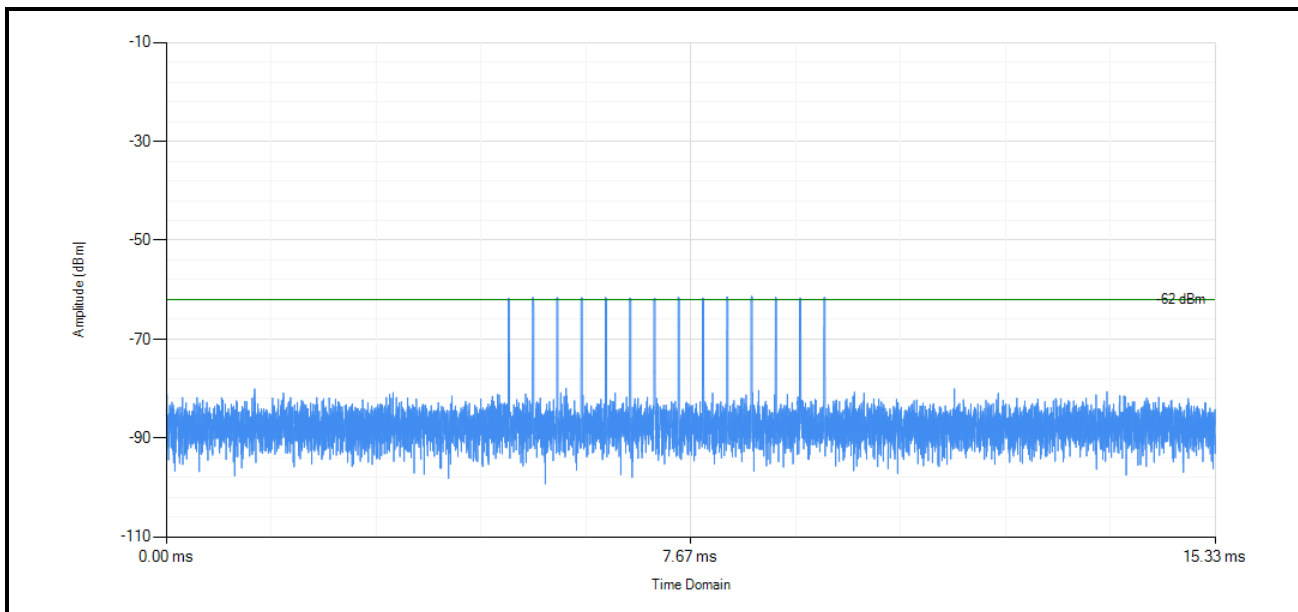

Radar Type 4

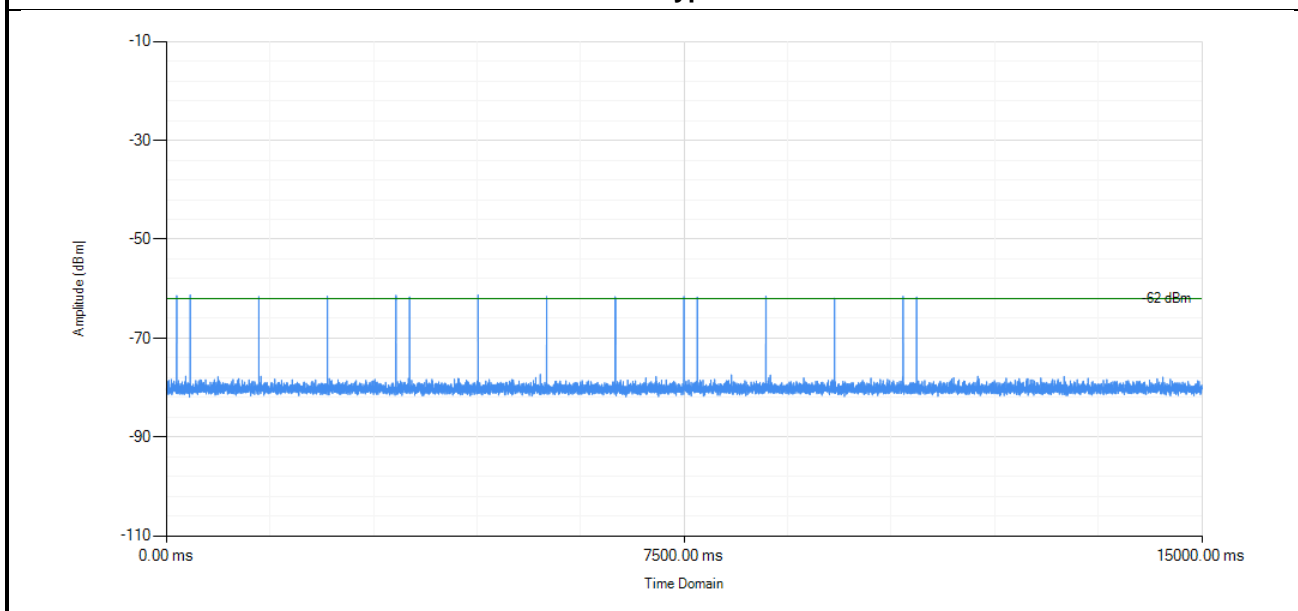

Radar Type 5

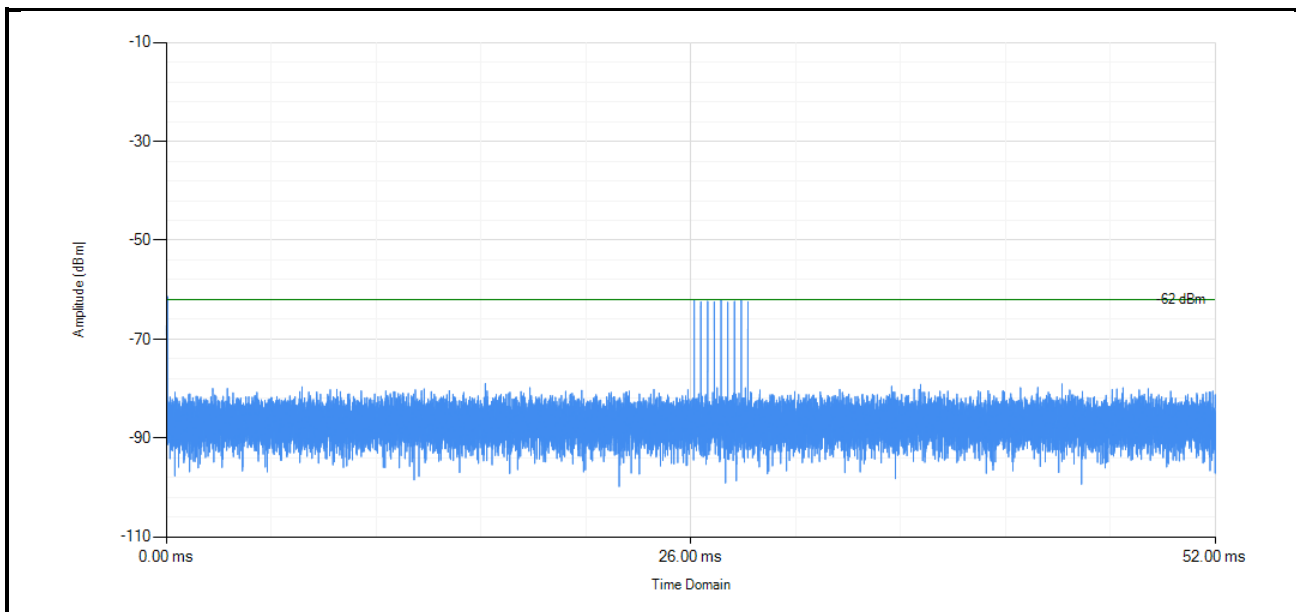

Radar Type 6
80MHz@5530MHz

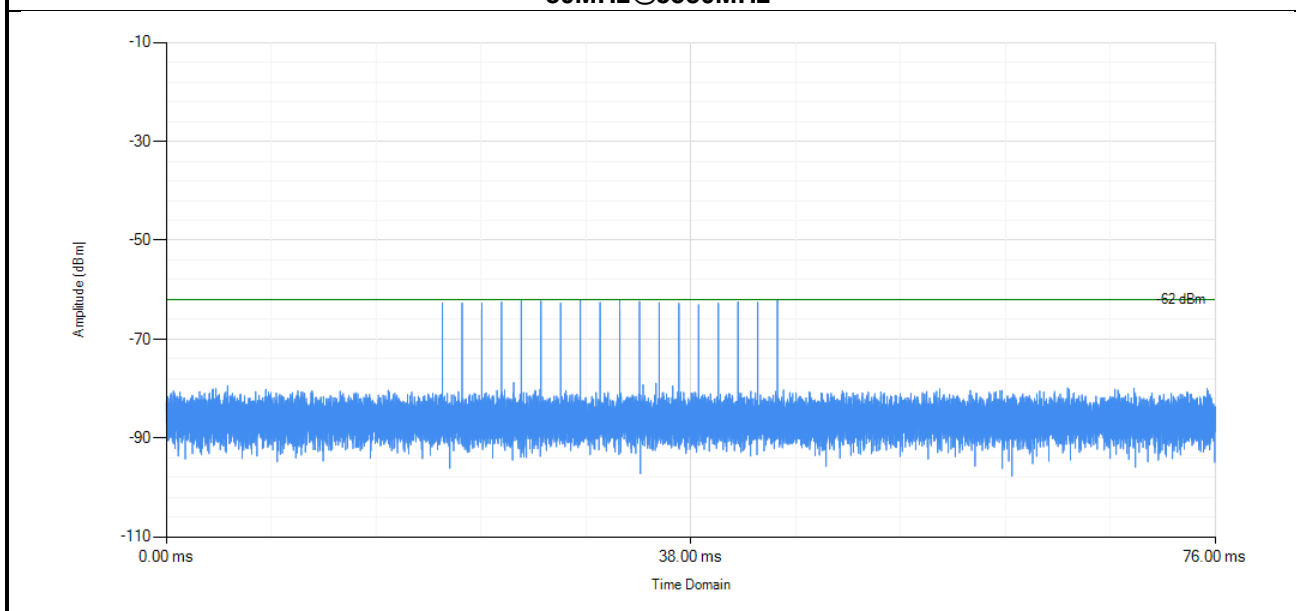

Radar Type 0

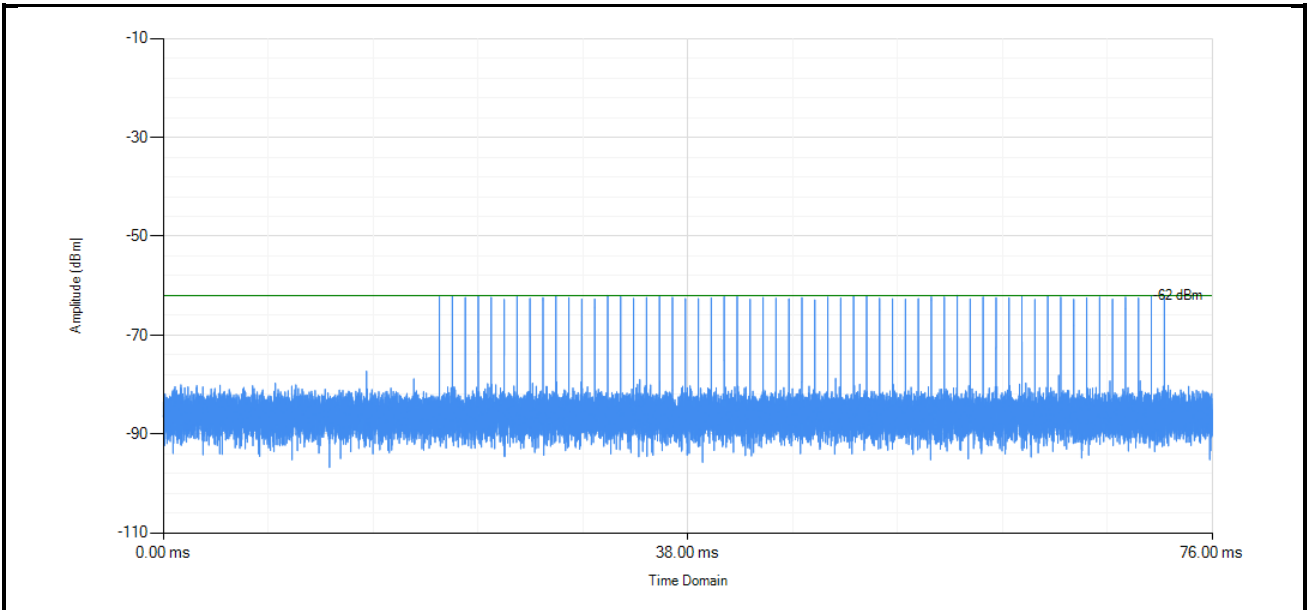

Radar Type 1

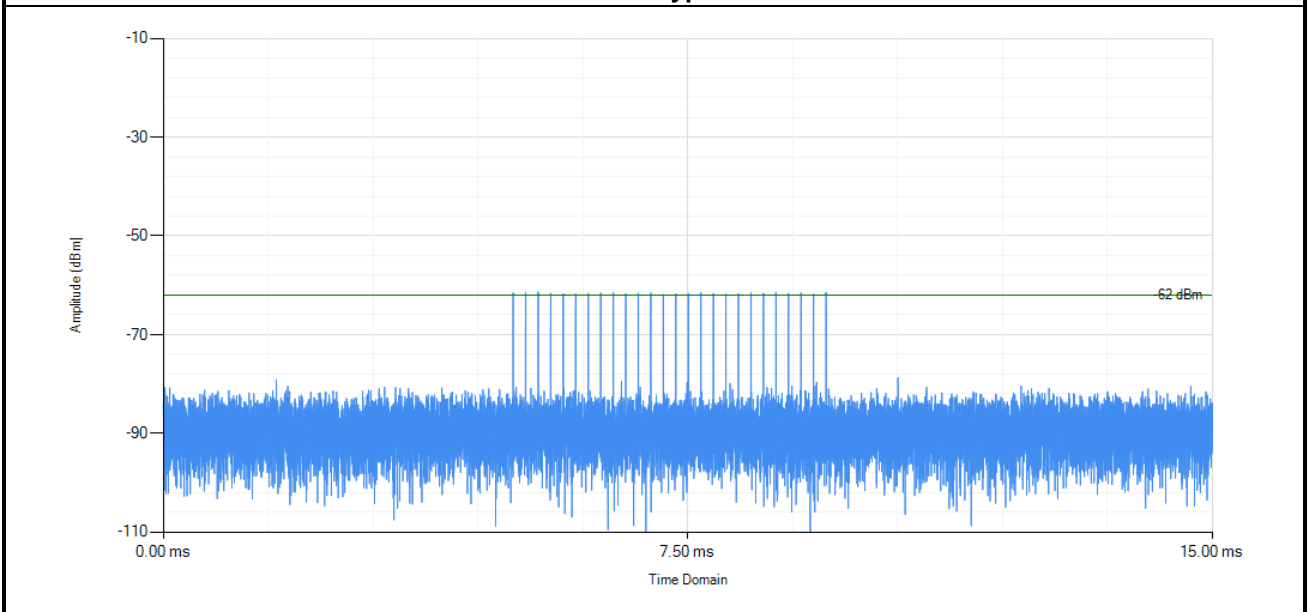

Radar Type 2

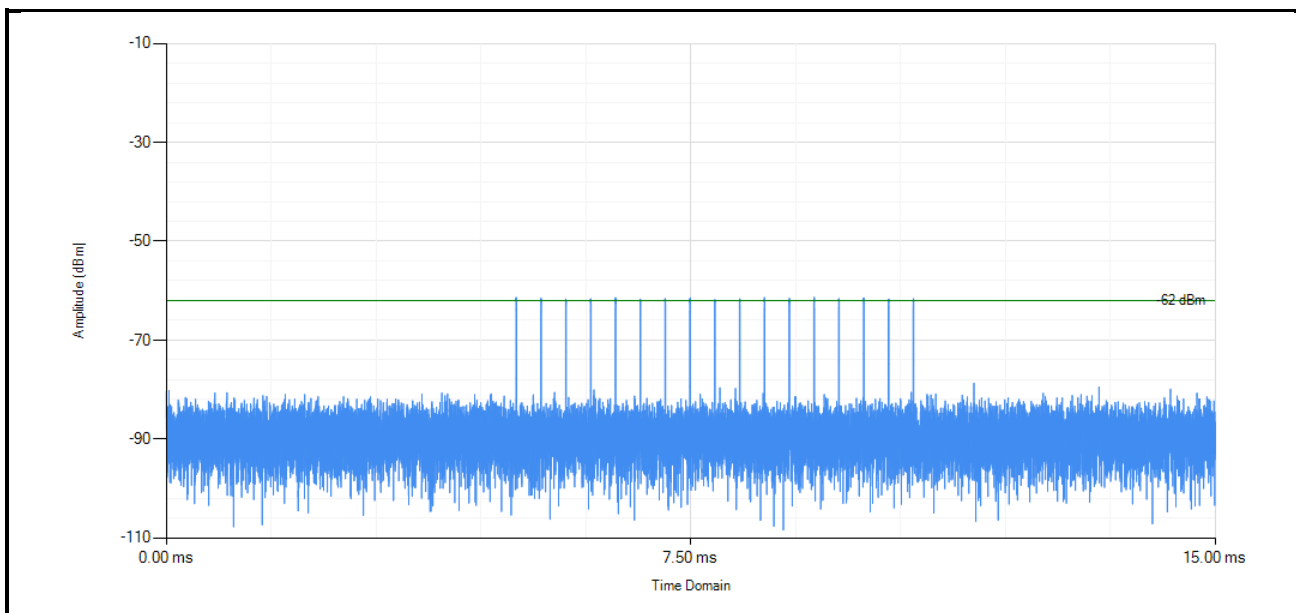

Radar Type 3

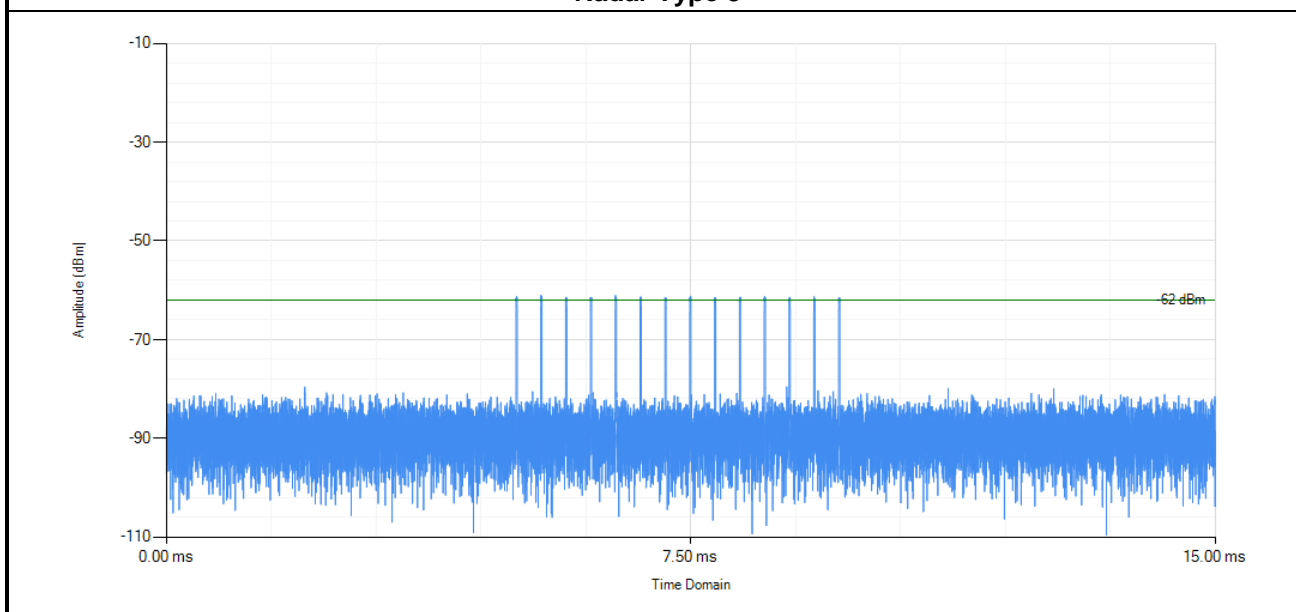

Radar Type 4

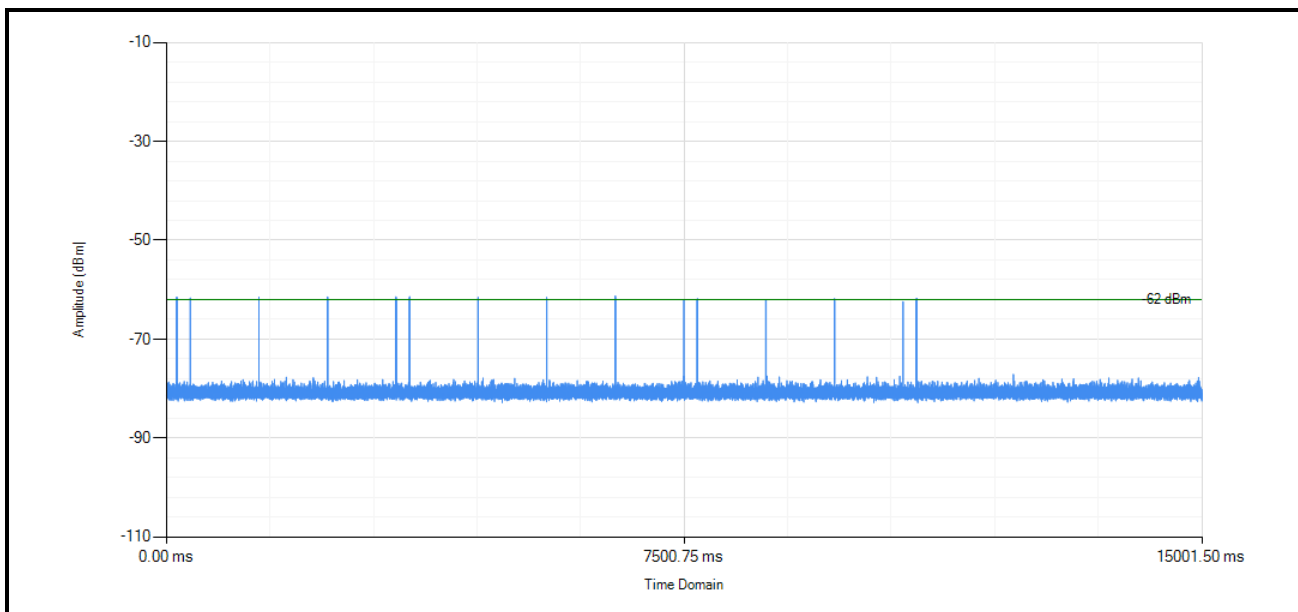

Radar Type 5

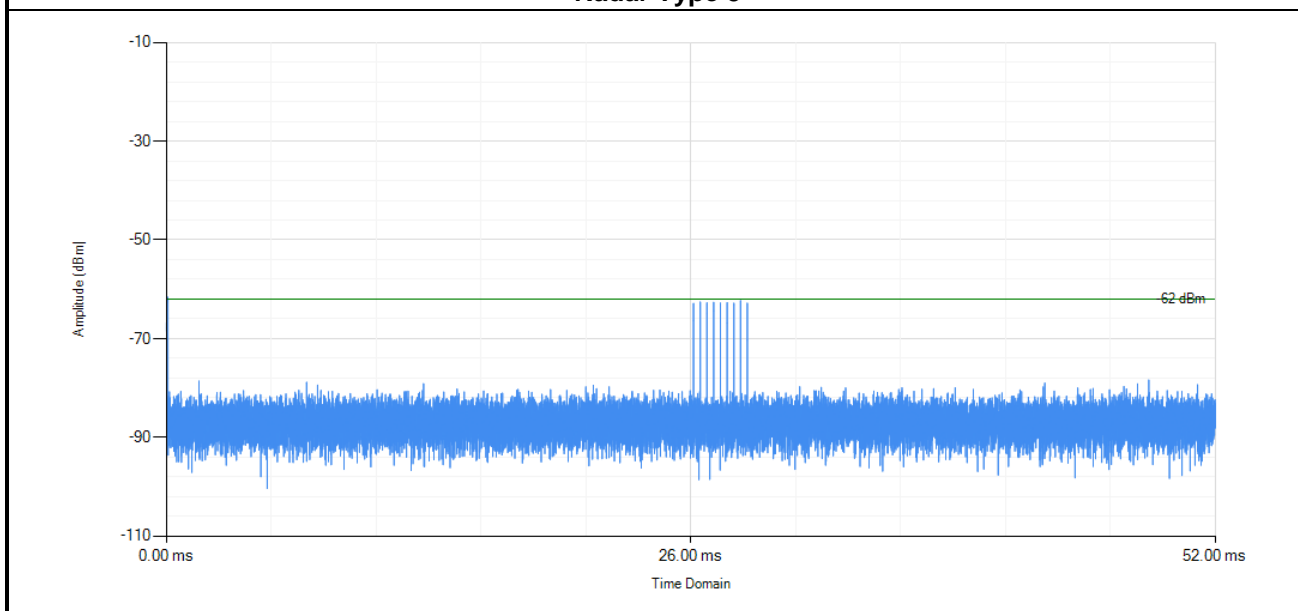

Radar Type 6

7.2 Channel Move Time and Channel Closing Transmission Time

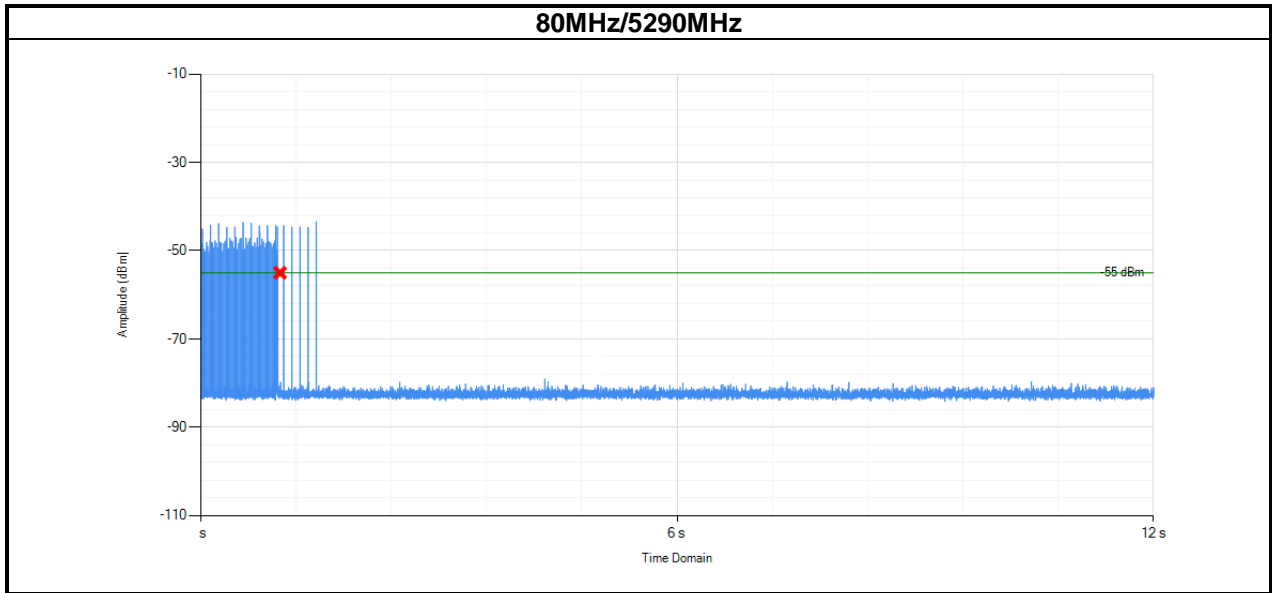

Test Items	Value	Limit
Channel Closing Transmission Time	8.4 ms	260 ms
Channel Move Time	456 ms	10 s

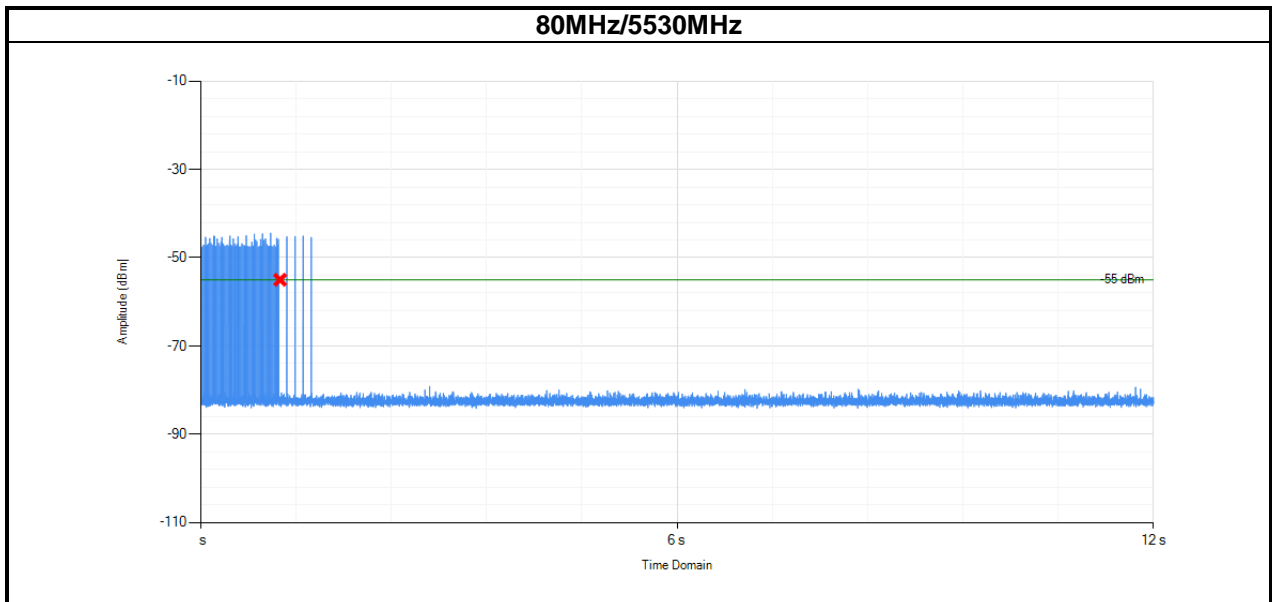

Test Items	Value	Limit
Channel Closing Transmission Time	4.8 ms	260 ms
Channel Move Time	392 ms	10 s

Test Result: Pass

7.3 Non-Occupancy Period

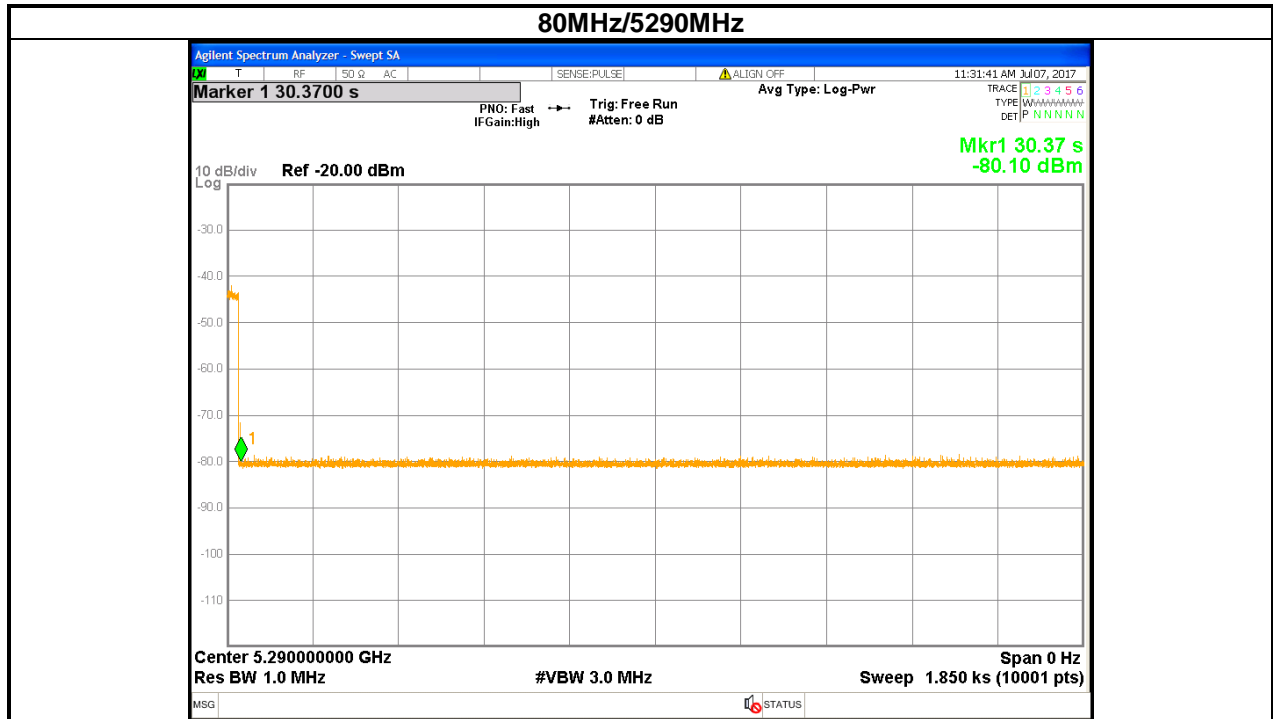

Test Items	Value	Limit
Non-Occupancy Period	1820 s	30 minutes (1800 s)

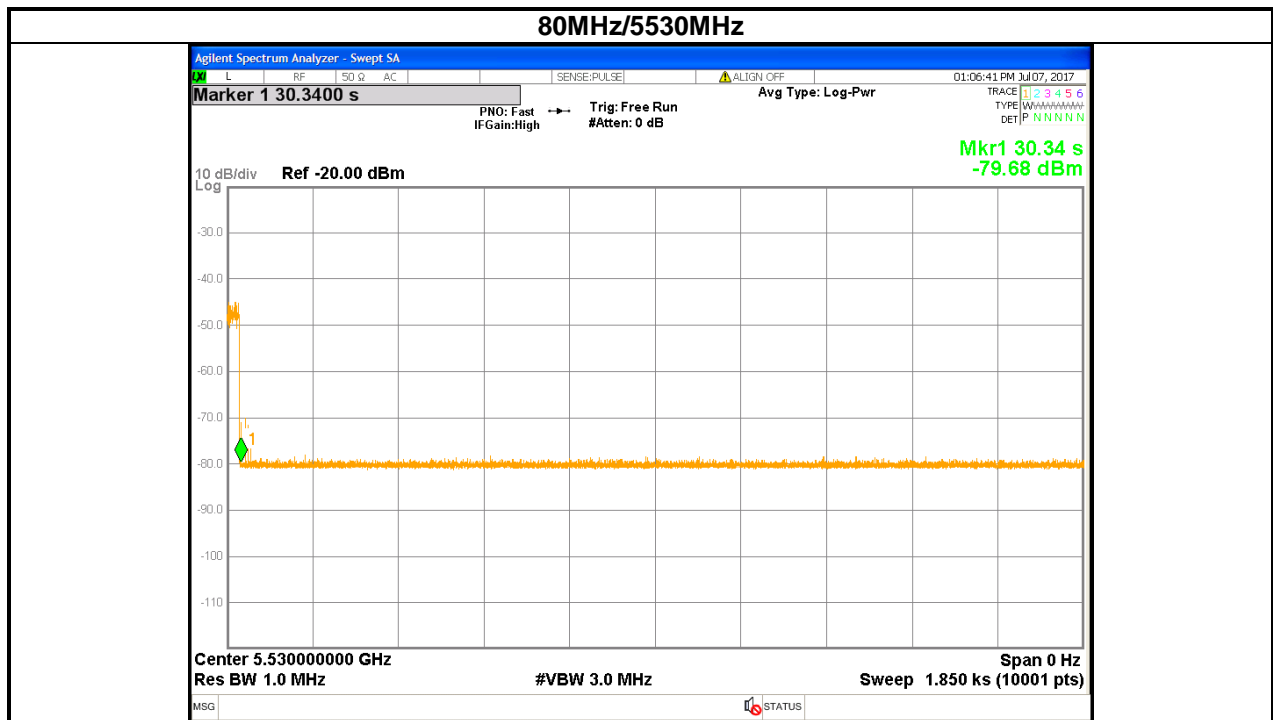

Non-Occupancy Period	1820 s	30 minutes (1800 s)
----------------------	--------	---------------------

Test Result: Pass

8 EUT Constructional Details

Reference to the test report No. CCISE170709601

----- End of report -----