



## **Dual-band (2.4 GHz/5 GHz) Antenna**

# **LIBRE SYNC**

### **Product Data Sheet** **Antenna: LSANT-XX-XXX Family**

**Rev: 1.2**

# 1. Introduction

Libre LSANT-1x-xx family RF Antennae are small in size, highly efficient and provide superior performance in Libre media streaming applications. They combine in one package the benefits of a loop and dipole antenna: high efficiency and resiliency to the surrounding environment. They are optimized for cost as well as performance and come in a various size of tuned FR4 boards and cable lengths providing industry leading cost/sensitivity performance. The unique isolation characteristics of LSANT antenna allow for two or more antennae to operate in close proximity. They are optimized to operate in either single or dual band modes and can also support Libre's modules with integrated Bluetooth for seamless Wi-Fi+BT managed coexistence on the LibreSync platform.

Customers can take advantage of industry-leading performance, drive faster design cycles, while realizing compact size at competitive costs.

ODM's and product designers can take advantage of Libre's fast design cycles using Quarry software and builder automated design. Additionally, due to the unique coupling structure of the LSANT family antenna, test cost savings are available via an over the air coupling test.

# 2. Product Feature Summary

## Key Features

- Supports Single and Dual Band applications (2.4 GHz and/or 5.0 GHz)
- RoHS Compliant
- high efficiency and resiliency to the surrounding environment
- small and highly efficient and provides superior performance
- Cable Lengths: 100mm, 180mm, 250mm
- Cable Diameter – 1.13 mm
- Connector - U.fl Compatible

**Product Variant '1A': Single and Dual Band RF antenna (2.4GHz & 5.0 GHz)**

- Dimensions: 23.8 x 20.0 x 0.4 mm<sup>3</sup>
- Cable: Micro-coaxial cable, diameter 1.13mm, u.fl compatible connector
- Cable length: 100mm, 180mm and 250mm
- Substrate: FR4, thickness 0.4mm, Adhesive backing 3M467

**Part Numbers:**

- 100mm cable length: LSANT-1A-100
- 180mm cable length: LSANT-1A-180
- 250mm cable length: LSANT-1A-250
- 250mm cable length: LSANT-1A-250-P5



- LSANT-1A-250-P5 has ferrite core (F9-BP RH 4\*10\*1.5) on the Antenna cable assembly.

**Product Variant '1B': Single and Dual Band RF antenna (2.4 GHz & 5.0 GHz)**

- Dimensions: 23.8 x 20.0 x 0.2 mm<sup>3</sup>
- Cable: Micro-coaxial cable, diameter 1.13mm, u.fl compatible connector
- Cable length: 100mm, 180mm and 250mm
- Substrate: FPC, thickness 0.2mm, Adhesive backing 3M467
- Flexible Printed Circuit (FPC) construction suitable for applications where the antenna, may need to be bent or fitted into tight positions.

**Part Numbers:**

- 100mm cable length: LSANT-1B-100
- 180mm cable length: LSANT-1B-180
- 250mm cable length: LSANT-1B-250

**Product Variant ‘1C’: Single and Dual Band RF antenna (2.4GHz & 5.0 GHz)**


- Dimensions: 36.6 x 10.3 x 0.4 mm<sup>3</sup>
  - Cable: Micro-coaxial cable, diameter 1.13mm, u.fl compatible connector
  - Cable length: 100mm, 180mm and 250mm
  - Substrate: FR4, thickness 0.4mm, Adhesive backing 3M467
  - **Part Numbers:**
    - o 100mm cable length: LSANT-1C-100
    - o 180mm cable length: LSANT-1C-180
    - o 250mm cable length: LSANT-1C-250

### 3. LSANT with LibreSync Platform

The LSANT family antennae are well tested and works very efficiently with LibreSync platform.

LibreSync platform has extensive software features for connected media streaming and control applications. These include system level control and interface features as well as networking features.

Please refer to the full “LibreSync Feature List” for details of supported features.



Platform features can vary based on module configuration/derivatives and commercial engagement details.

## 4. Specifications

### 4.1. General Specification

Parameter	Description / Values
Antenna Product Family	‘1’
Product variants in the family	1A, 1B, 1C
Cable diameters	1.13 mm

Cable	Micro-coaxial cable, diameter 1.13mm, u.fl compatible connector
Length options	100 mm, 180 mm, 250 mm
Connector	U.fl Compatible
RoHS Compliant	Compliant

## 4.2. Electrical Characteristics

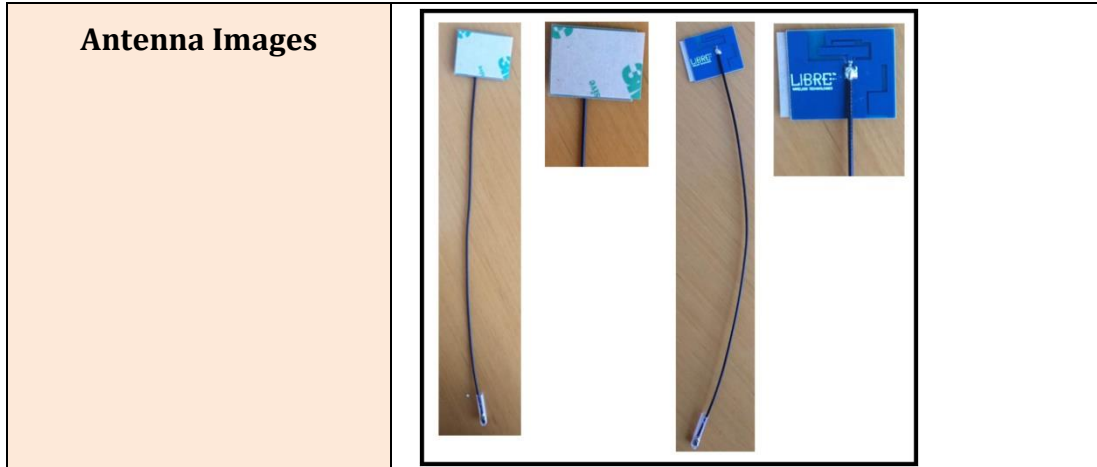
Frequency	2.4 - 2.5GHz	5.15 - 5.85GHz
<b>Cable length</b>	100mm	100mm
<b>Return Loss</b>	≤ -10dB	≤ -10dB
<b>Impedance</b>	50 Ω	50 Ω
<b>Radiation Pattern</b>	Omni-directional	Omni-directional
<b>Polarization</b>	Vertical	Vertical
<b>Efficiency (Variant 1A)</b>	50 - 60%	60 - 70%
<b>Efficiency (Variant 1B)</b>	60 - 65%	50 - 70%
<b>Efficiency (Variant 1C)</b>	60 - 70%	50 - 60%
<b>Peak Gain (Variant 1A)</b>	≤ 1.5 dB	≤ 3.1 dB
<b>Peak Gain (Variant 1B)</b>	≤ 2.3 dB	≤ 2.4 dB
<b>Peak Gain (Variant 1C)</b>	≤ 3.5 Db	≤ 5.9 dB
<b>Matching Circuit</b>	None	-
<b>Operating Temperature</b>	-40°C	+85°C

### 4.3. LSANT-1X-XX Antenna Ordering Information

Product Number	Cable length (in mm)	Antenna Dimension (L x W x H) in mm
LSANT-1A-100	100	FR4 23.8mm x 20.0 mm x 0.4mm
LSANT-1A-180	180	
LSANT-1A-250	250	
LSANT-1A-250-P5	250	FR4 23.8mm x 20.0 mm x 0.4mm (with Ferrite Core)
sLSANT-1B-100	100	FPC 23.8mm x 20.0 mm x 0.2mm
LSANT-1B-180	180	
LSANT-1B-250	250	
LSANT-1C-100	100	FR4 36.6mm x 10.3 mm x 0.4mm
LSANT-1C-180	180	
LSANT-1C-250	250	

### 4.4. Antenna Specification

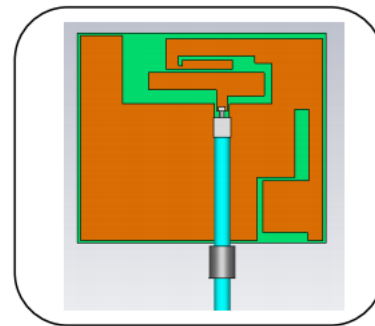
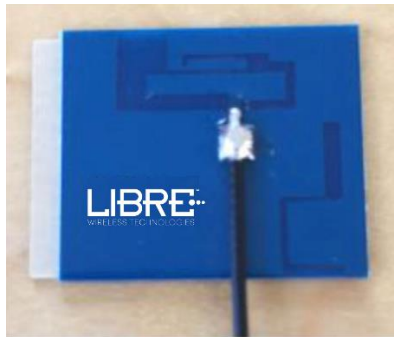
<b>Antenna Module</b>	LSANT-1A-180
<b>Antenna Gain</b>	≤ 1.5dBi
<b>Manufacturer of Antenna</b>	Golden Smart International Co., Ltd



## 5. Mechanical, Connectors and Interfaces

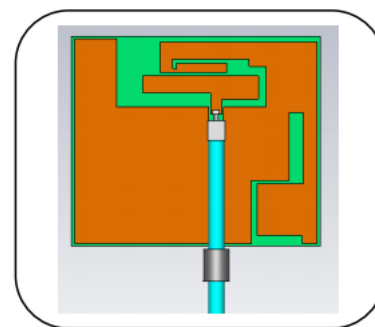
### 5.1. Physical Module

**Product '1A':** FR4 23.8mm x 20.0 mm x 0.4mm (L x W x H)



**Figure 5.1-1: LSANT-1A-xx product and Simulation model**

**Product '1B':** FPC 23.8mm x 20.0 mm x 0.2mm (L x W x H)



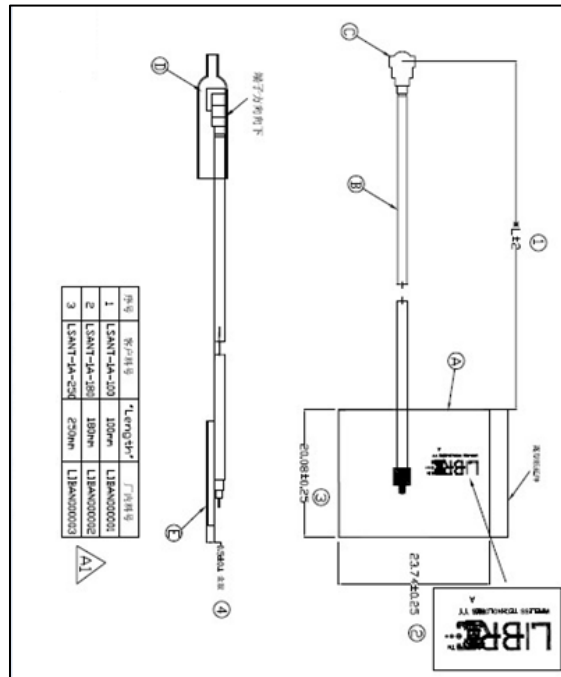
**Figure 5.1-2: LSANT-1B-xx product and Simulation model**

**Product '1C':** FR4 36.6mm x 10.3 mm x 0.4mm (L x W x H)



**Figure 5.1-3: LSANT-1C-xx product and Simulation model**

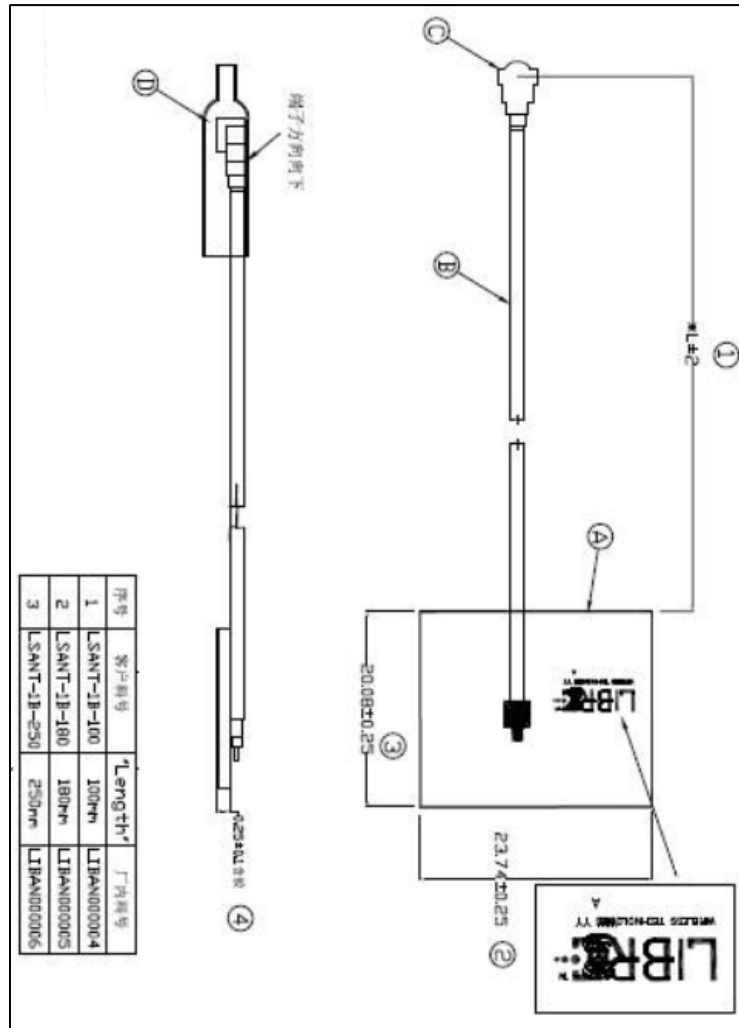
**Product '1A':** LSANT-1A-XXX



**Figure 5.1-4: LSANT-1A-XXX**

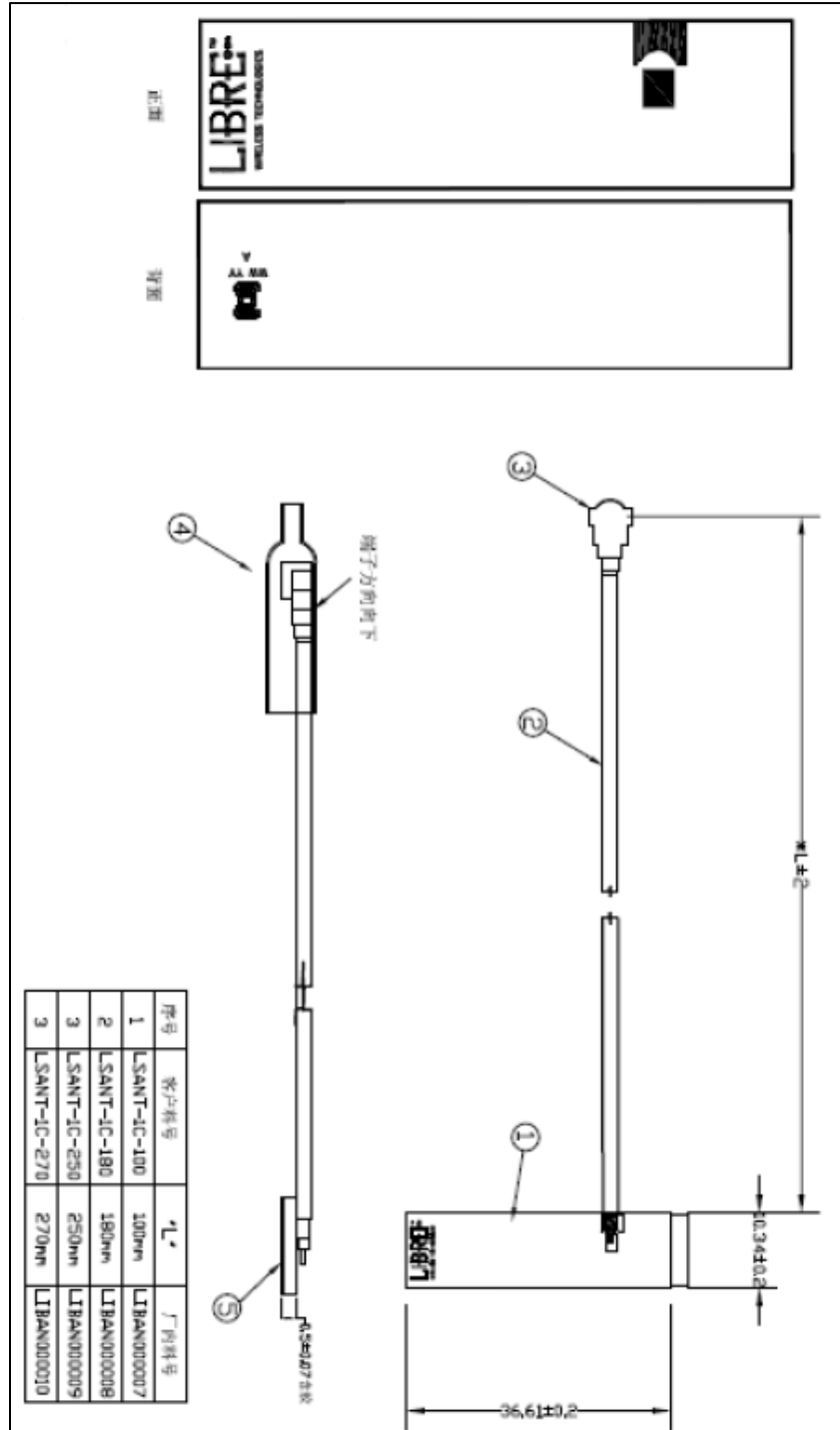


**Product '1B': LSANT-1B-XXX**



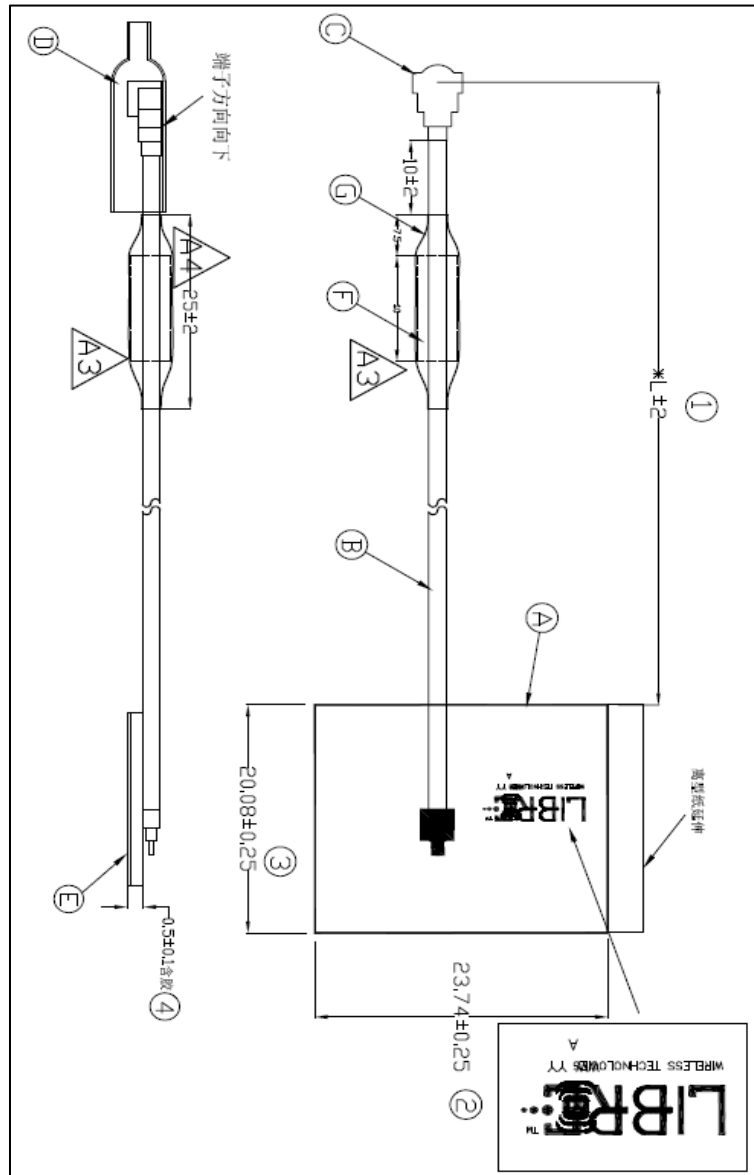
**Figure 5.1-5: LSANT-1B-XXX**

**Product '1C': LSANT-1C-XXX**



**Figure 5.1-6: LSANT-1C-XXX**

**Product '1A': LSANT-1A-250-P5**



**Figure 5.1-7: LSANT-1A-250-P5**

## 6. Design Recommendation

### 6.1. Antenna usage

In case the antenna is not well tuned in the operating bands (centered in the frequency band and efficient), it is always possible to:

- Relocate the antenna in a different position
- Increase the distance between the antenna and other antennae or components

- Retune the antenna pattern to compensate for the surroundings losses
- Optimize the cable length to minimize picked-up noise and RF losses
- Add a PI matching circuit behind the U.FL receptacle on the main PCB for some fine-tuning abilities with capacitors and inductors.

## 6.2. Cable losses

Off-Module antennas are connected to the product’s radio module using a micro-coaxial cable terminated by an U.FL compatible connector. These micro-coaxial cables are equivalent 50 Ohms transmission lines and possess attenuation factor properties affecting the losses of the RF signal through the RF propagation along the cable. Losses vary based on the cable manufacturer, the raw material and the manufacturing process used.

For example:

- Tight control of PTFE insulator material, dimensions and electrical properties, Single, double or triax (Cable) braiding, interconnect with the RF connector, Inner Conductor diameter, Outer cable diameter, Manufacturing process between the cable’s connector and the connector itself (crimping, crimping + soldering ...)

The Table below shows a typical 1.13mm outer diameter micro-coaxial cable attenuation values versus the operating frequency for a cable length of 100mm, (single braiding cable)

<b>Frequency (in MHz)</b>	<b>Attenuation /100 mm (in dB)</b>
700	0.20
800	0.20
900	0.23
1575	0.30
1800	0.30

1900	0.33
2100	0.33
2400 (2.4 GHz)	0.40
5000 (5.0 GHz)	0.55

### 6.3. Cable Routing Guidelines

Off-Module antennas are typically connected using a micro-coaxial cable. As a radiating component, antennas are very sensitive to their surroundings. Routing the cable of the antenna is not trivial and can have dramatic impact on throughput testing, or more generally, on the performances of the antenna. Below are listed a set of instructions on how to best route the antenna cable to optimize the antenna performance.

Avoid overlapping of the cable especially over the following components

- High speed digital lines
- Micro-processor,
  - CPU
  - RAM/ROM
  - LED
  - Any other cables in the device
  - Audio components
  - Crystal oscillators
  - Power management areas (PMIC)
  - DC-DC Converter, Power supply
  - LCD
  - Clock

- It is preferred that the u.fl receptacle is located as close as possible to the edge of the main PCB so that the cable routing does not overlap any components over the PCB.
- In case of strong coupling between a component and the antenna cable, it is possible to add ferrite beads, held in a steady position by a heat-shrink tube around the cable. This adds cost to the overall antenna assembly and can be avoided if all is taken into consideration during the design integration at an early stage.
- It is advised not to exceed a bending radius of more than 10 times the outer diameter of the cable. For a cable diameter of 1.13mm, the minimum bending radius is recommended to be greater than 11.3mm. If this recommendation is not followed, there is a risk of cracking the cable braiding, this could cause RF leakage or break the impedance transfer from the radio to the antenna and resulting in noise or creating a complete antenna mismatch, not ensuring a clean 50ohms connection.
- Regarding cable length, the shorter is better in terms of antenna integration in the device (noise, coupling optimization) and RF performances (mismatch, efficiency).  
See chapter 4.1 for cable losses table for a regular 1.13mm outer diameter cable.

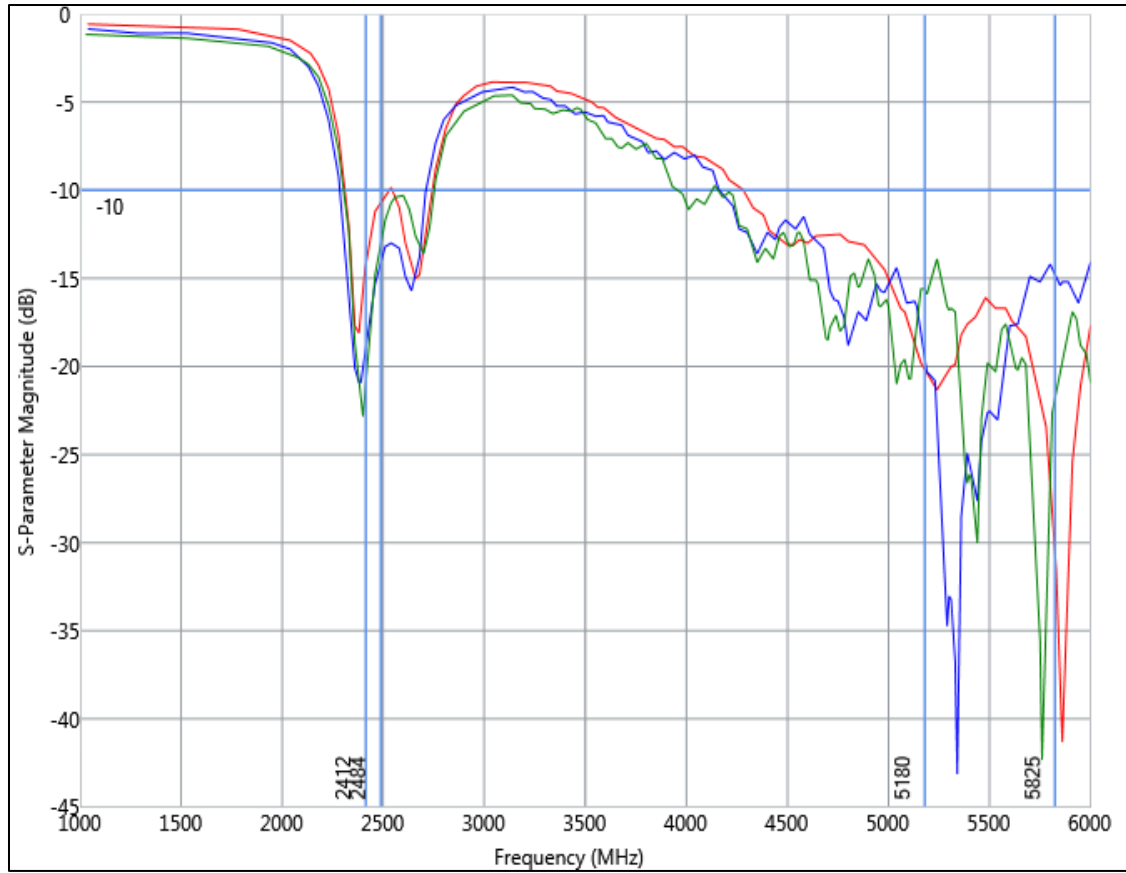
## 7. Antenna Performance

### 7.1. Return Loss

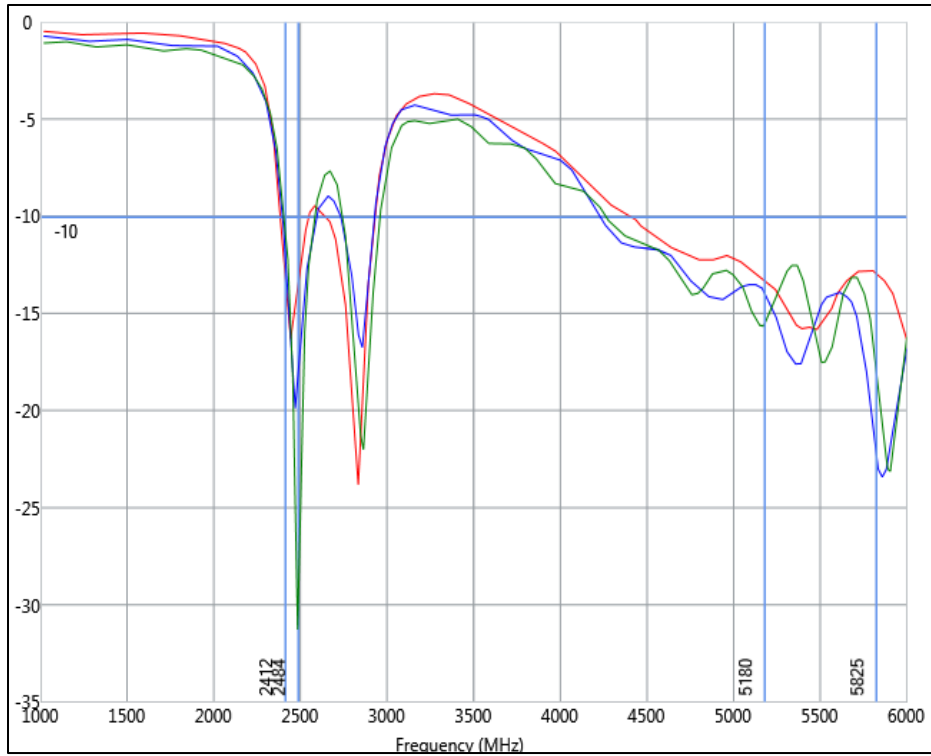
Antennas are connected to a Vector Network Analyzer (VNA) through the U.fl connector and the Return Loss plots are superposed in the chart below, showing that CPL antennas are tuned in the operating frequency bands. Antennas are taped on a plastic wall to reflect reality.

#### Figure Legend

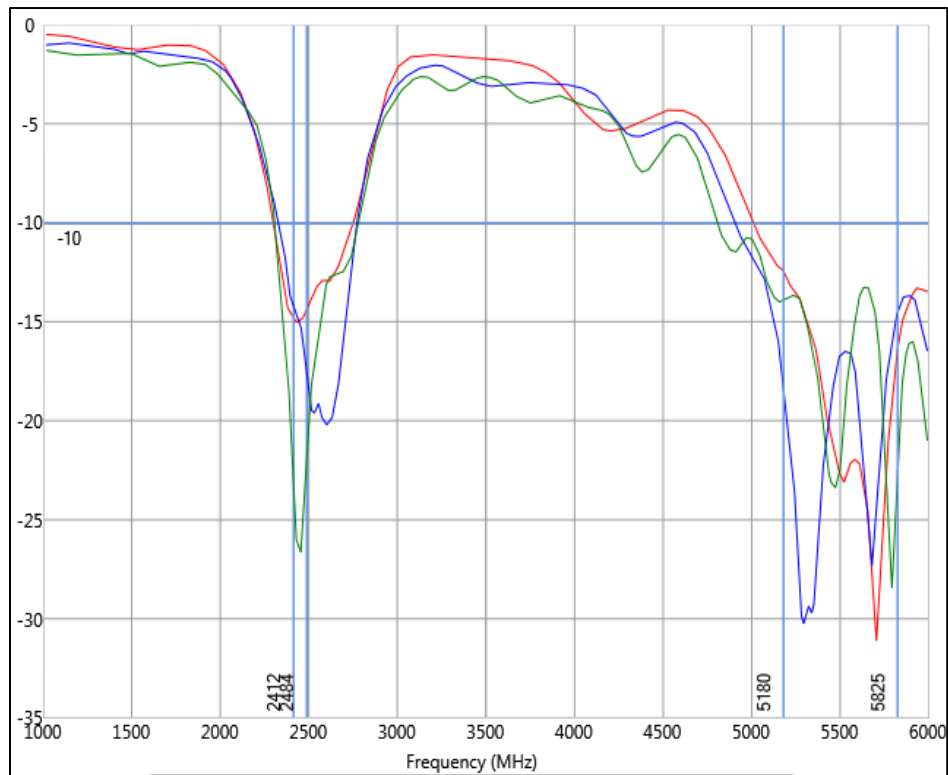
- **Cable: 100mm**
- **Cable: 180mm**
- **Cable: 250mm**



**Figure 7.1-1 – Return Loss for Product “1A” Variant**



**Figure 7.1-2 – Return Loss for Product “1B” Variant**



**Figure 7.1-3 – Return Loss for Product “1C” Variant**



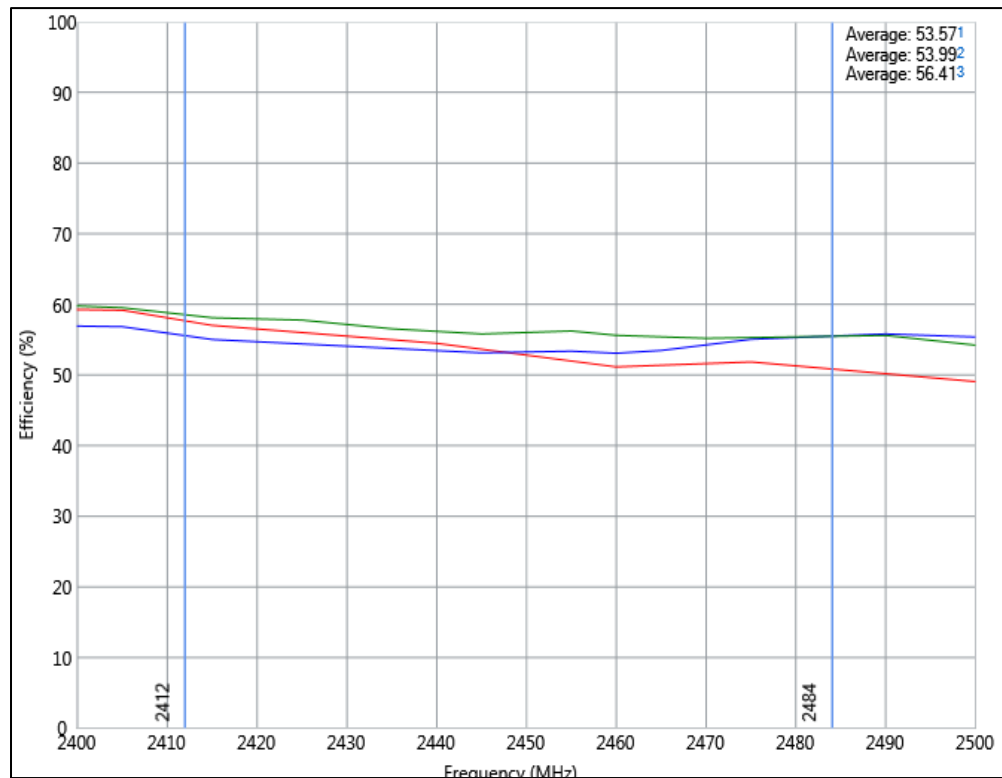
## 7.2. Efficiency

Antennas are measured in a state of the art **anechoic chamber**, where efficiency measurements and radiation patterns can be extracted. Due to Cable losses at RF frequencies, the longer the cable, the less efficient is the antenna. This effect increases with the frequency.

### 7.2.1. Efficiency at 2.4 GHz

#### Figure Legend

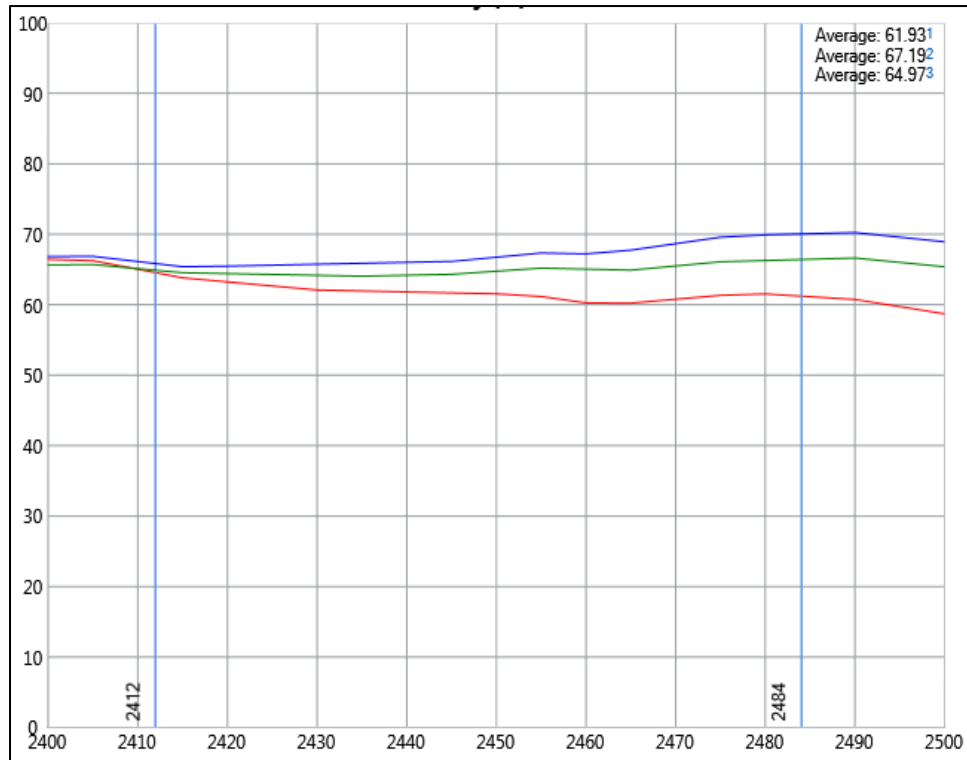
- **Cable: 100mm**
- **Cable: 180mm**
- **Cable: 250mm**



**Figure 7.2.1-1 – Efficiency for Product “1A” Variant**

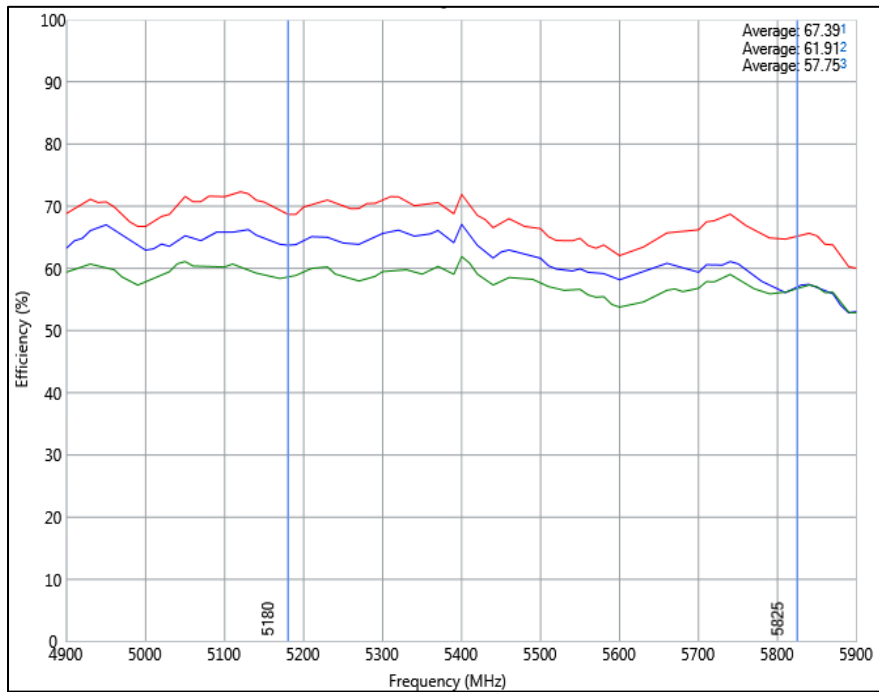


**Figure 7.2.1-2 – Efficiency for Product “1B” Variant**

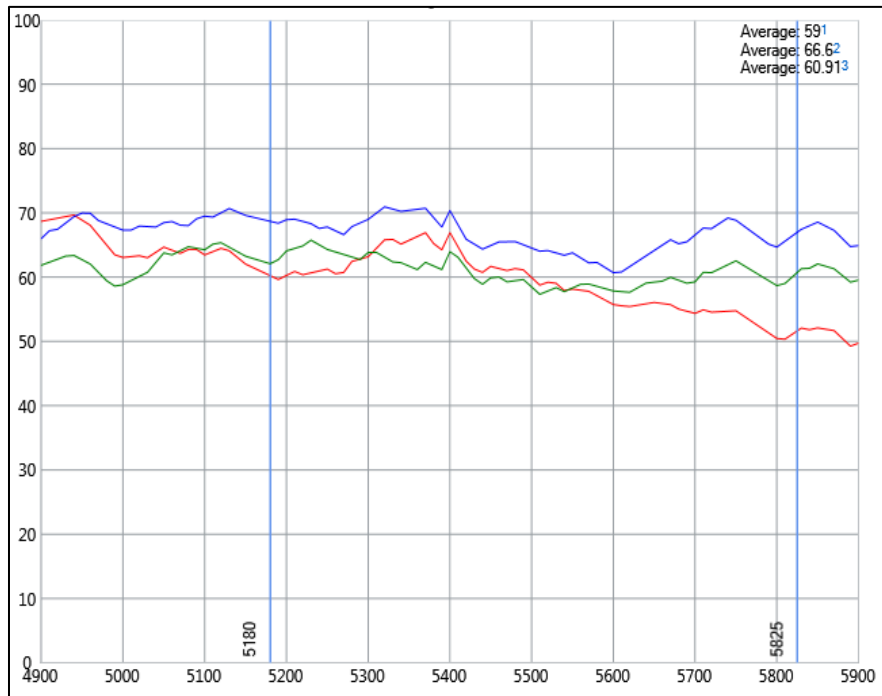


**Figure 7.2.1-3 – Efficiency for Product “1C” Variant**

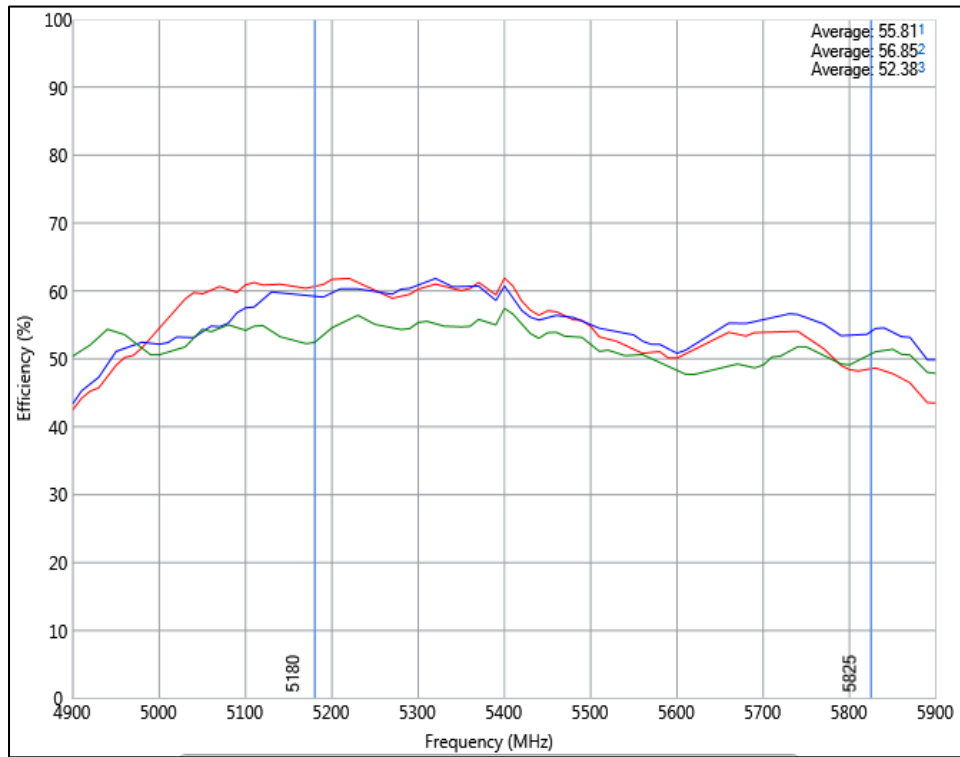
### 7.2.2. Efficiency at 5 GHz



**Figure 7.2.2-1 – Efficiency for Product “1A” Variant**



**Figure 7.2.2-2 – Efficiency for Product “1B” Variant**



**Figure 7.2.2-3 – Efficiency for Product “1C” Variant**

## 7.3. Radiation Pattern at 2.45GHz

### Figure Legend

- **Cable: 100mm**
- **Cable: 180mm**
- **Cable: 250mm**

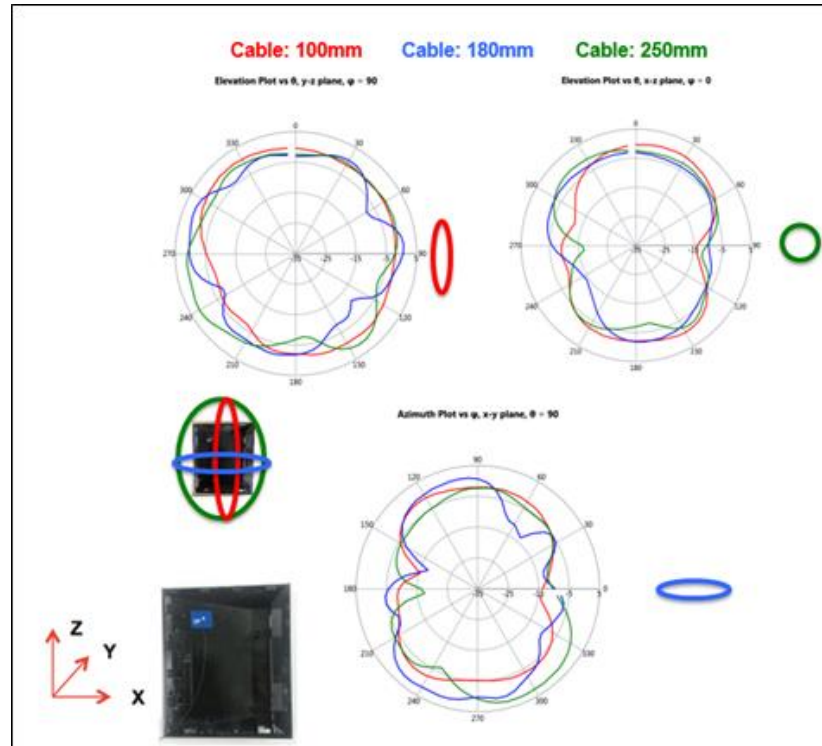
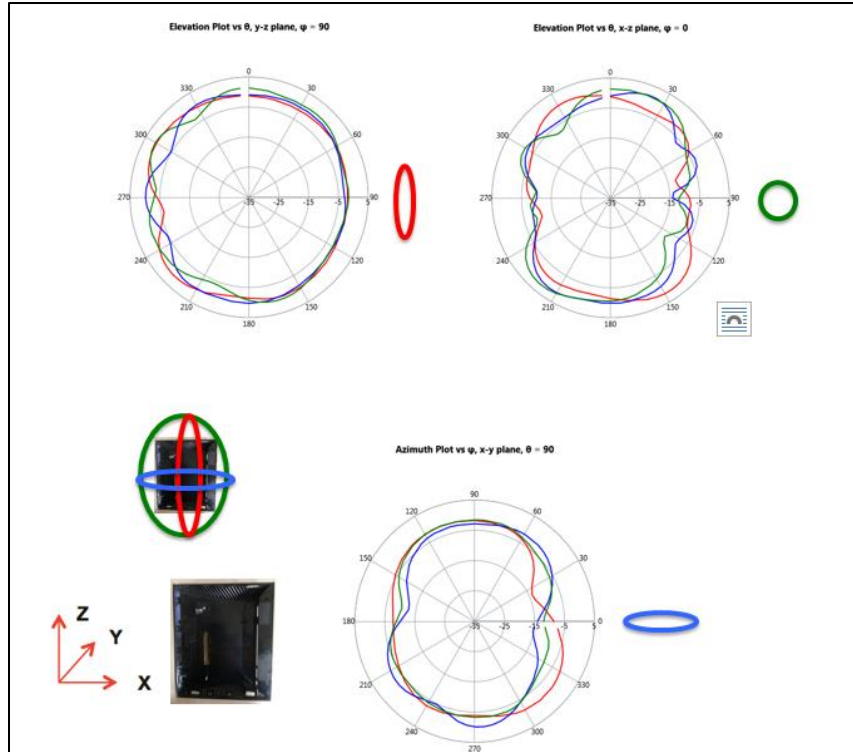
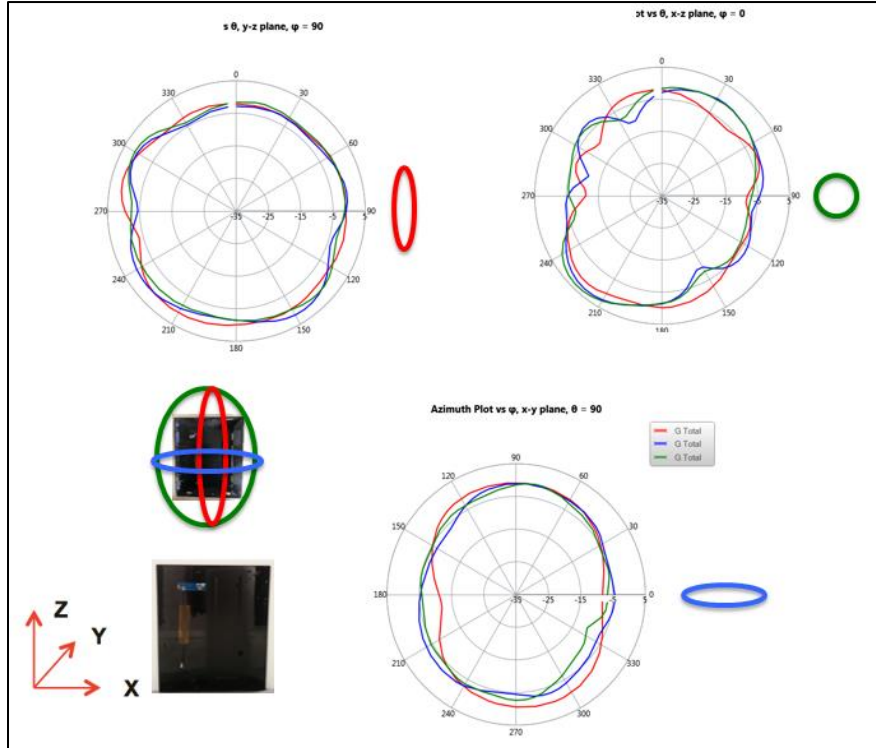


Figure 7.3-1 – Radiation Pattern for Product “1A” Variant

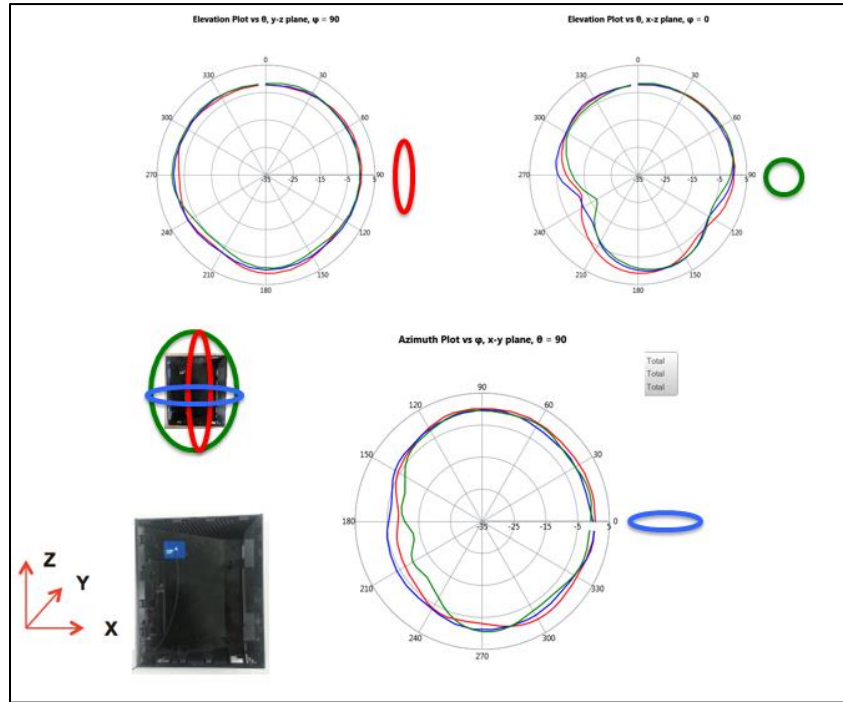


**Figure 7.3-2 – Radiation Pattern for Product “1B” Variant**

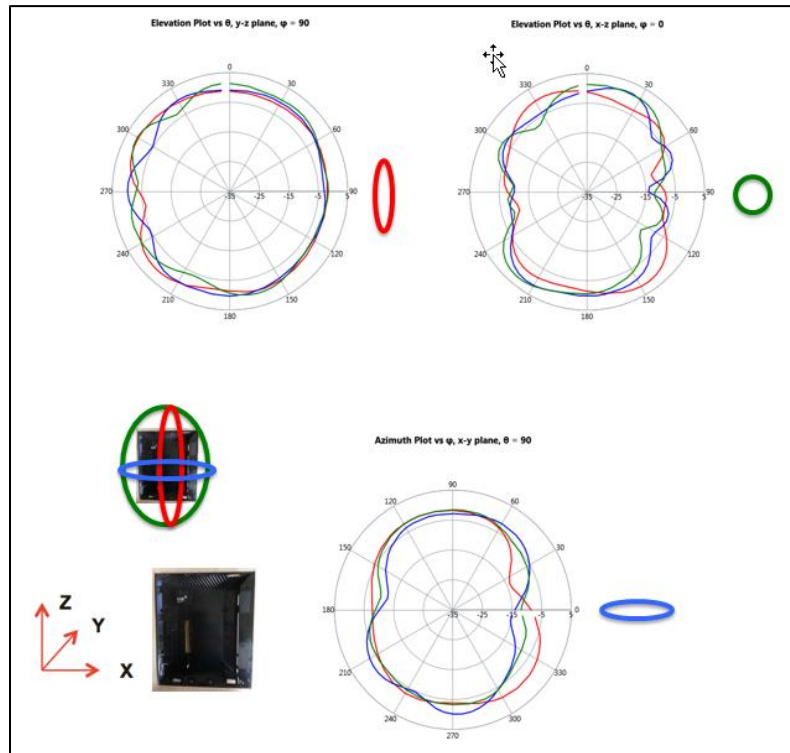


**Figure 7.3-3 – Radiation Pattern for Product “1C” Variant**

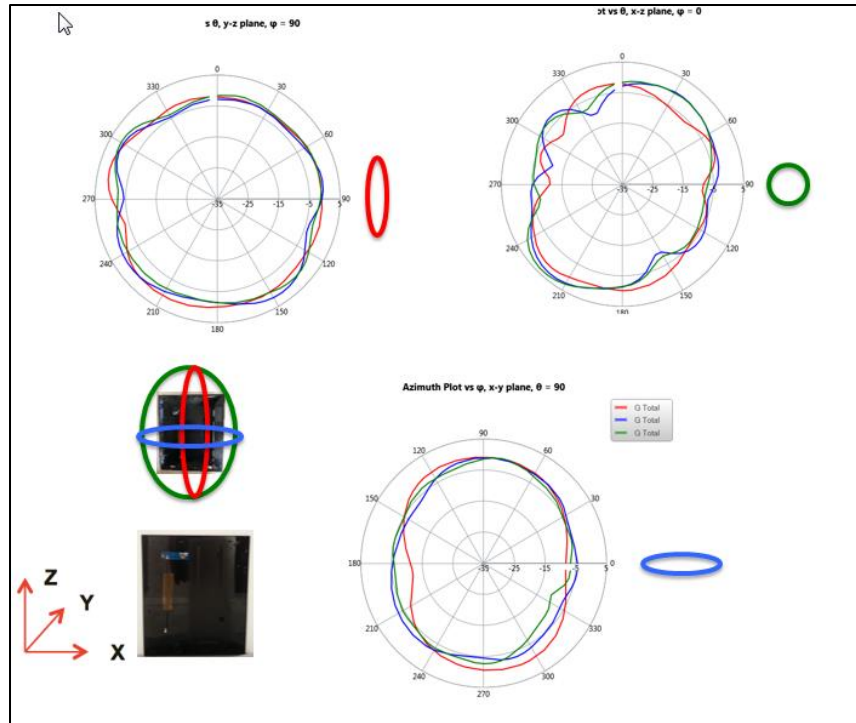
## 7.4. Radiation Pattern at 5.5 GHz



**Figure 7.4-1 - Radiation Pattern for Product "1A" Variant**



**Figure 7.4-2 - Radiation Pattern for Product "1B" Variant**



**Figure 7.4-3 – Radiation Pattern for Product “1C” Variant**

## 8. Environmental

### 8.1. Storage Conditions

The calculated shelf life in a sealed bag is 12 months if stored between 0°C and 40°C at less than 90% relative humidity (RH).

After the bag is opened, devices that are subjected to solder reflow or other high temperature processes must be handled in the following manner:

- Mounted within 168 hours in factory conditions, i.e. <30°C at 60% RH.
- Storage humidity needs to maintain at <10%RH.
- Baking is necessary if the customer exposes the component to air for over 168 hrs.
  - Baking conditions: 125°C for 8hrs.



## 9. Disclaimer

THE MATERIALS AND INFORMATION ARE PROVIDED “AS IS” WITHOUT WARRANTY OF ANY KIND, EITHER EXPRESS OR IMPLIED, INCLUDING BUT NOT LIMITED TO, THE IMPLIED WARRANTIES OF MERCHANTABILITY, FITNESS FOR A PARTICULAR PURPOSE OR NON-INFRINGEMENT.

We use reasonable efforts to include accurate and up-to-date information in this document. It does not however, make any representations as its accuracy or completeness of information. Use of this document is at your own risk. Libre Wireless Technologies, its suppliers, and other parties involved in creating and delivering this document’s contents shall not be liable for any special, indirect, incidental, or consequential damages, including without limitation, lost revenues or lost profits.