



**⚠ Read this manual carefully before operating the system.
This manual should stay with this system if it is sold.**

OWNER'S MANUAL

Drive Unit Display Unit Battery Pack Battery Charger

* This owner's manual is original instruction.

* Product and specifications are subject to change without notice.

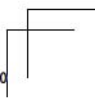
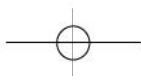
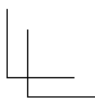
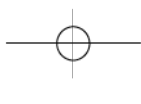

Introduction

These original instructions have been prepared for your Drive Unit, display unit, battery pack and battery charger.

TIP

This manual is not intended as a comprehensive use, service, repair or maintenance manual. Please see your dealer for all service, repairs or maintenance. Your dealer may also be able to refer you to classes, clinics or books on bicycle use, service, repair or maintenance.

**Drive Unit, Display Unit,
Battery Pack, Battery Charger
OWNER'S MANUAL
©2018 by Yamaha Motor Co., Ltd.
2nd edition, July 2018
All rights reserved.
Any reprinting or unauthorized use
without the written permission of
Yamaha Motor Co., Ltd.
is expressly prohibited.**





Contents

General warning	p. 1
1. Electric bike components	p. 2
A. Introduction	p. 2
B. Location of the warning and specification labels	p. 3
C. Description	p. 4
D. E-Bike Systems	p. 5
The e-Bike Systems are designed to give you the optimal amount of power assist.	p. 5
Multiple power assist modes are available.	p. 5
Conditions that could decrease remaining assist distance	p. 6
E. ⚠ Safety information	p. 7
F. Instrument and control functions	p. 10
Display unit (Display A)	p. 10
Display unit (Display X)	p. 16
Display unit (Display C)	p. 34
G. Battery pack and charging procedure	p. 57
Appropriate charging environments	p. 58
Inappropriate charging environments and solutions	p. 59
Charging the battery pack mounted on the bicycle (Down tube type)	p. 59
Charging the battery pack mounted on the bicycle (Multi location type)	p. 60
Charging the battery pack removed from the bicycle	p. 61
Reading the charging status for battery pack	p. 65
Reading the charging status for display unit (Applies only to models equipped with the Multi location type battery pack.)	p. 66
Charging time guidelines	p. 68
H. Checking the residual battery capacity	p. 69
Residual battery capacity indicator display and estimate of residual battery capacity for display unit	p. 69
Display of the battery capacity indicator lamps and the estimate of the residual battery capacity	p. 71
I. Pre-operation check	p. 72
J. Cleaning, maintenance and storage	p. 72
Caring for the battery pack	p. 72
Maintenance for the Drive Unit	p. 72
Storage	p. 73
Long storage period (1 month or longer) and using it again after a long storage period	p. 73
K. Transport	p. 73
L. Consumer information	p. 74
Disposal	p. 74
M. Troubleshooting	p. 75
E-Bike Systems	p. 75
Power supply of external devices via USB connection	p. 82
Wireless communication with Bluetooth low energy technology	p. 83
Battery pack and charger	p. 84
N. Specifications	p. 87

General warning

FAILURE TO FOLLOW THE WARNINGS CONTAINED IN THIS MANUAL CAN RESULT IN SERIOUS INJURY OR DEATH.

Particularly important information is distinguished in this manual by the following notations:

	This is the safety alert symbol. It is used to alert you to potential personal injury hazards. Obey all safety messages that follow this symbol to avoid possible injury or death.
	A WARNING indicates a hazardous situation which, if not avoided, could result in death or serious injury.
	A NOTICE indicates special precautions that must be taken to avoid damage to the vehicle or other property.
	A TIP provides key information to make procedures easier or clearer.

1. Electric bike components

A. Introduction



The Bluetooth® word mark and logos are registered trademarks owned by the Bluetooth SIG, Inc. and any use of such marks by YAMAHA MOTOR CO., LTD. is under license.

*Applies to Display X and Display C.

B. Location of the warning and specification labels

Read and understand all of the labels on your battery pack and battery charger. These labels contain important information for safe and proper operation. Never remove any labels from your battery pack and battery charger:

Battery pack

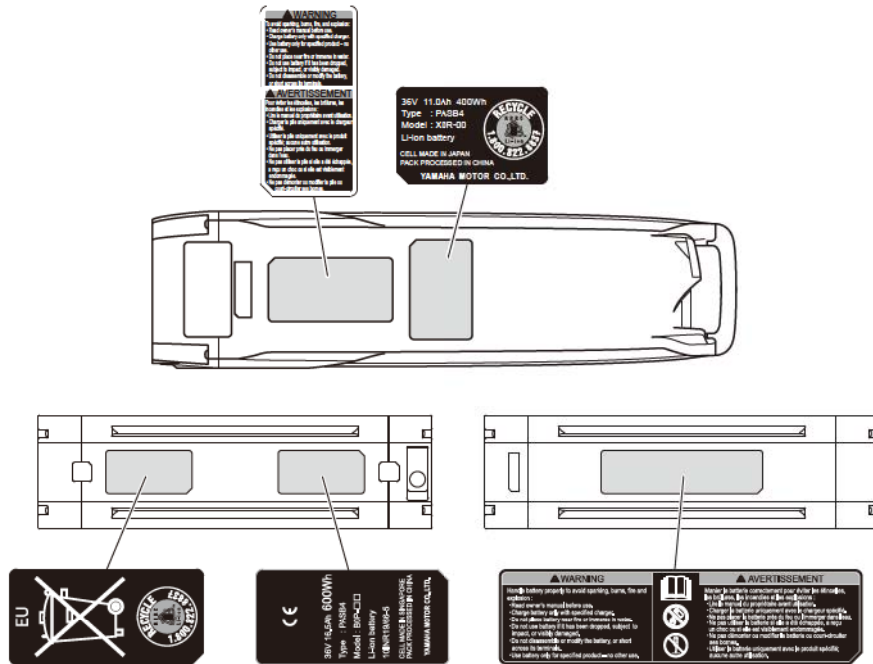

Battery charger

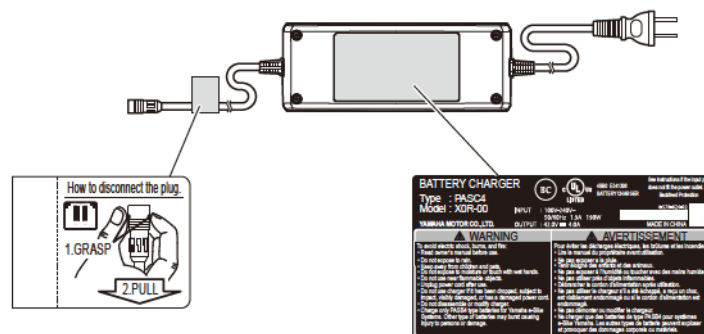

Familiarize yourself with the following pictograms and read the explanatory text, then make sure to check the pictograms that apply to your model.

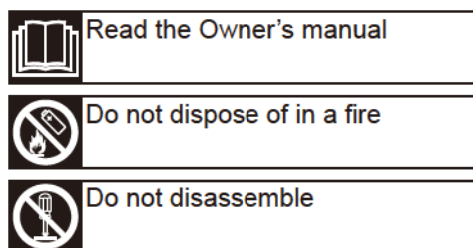

C. Description

1

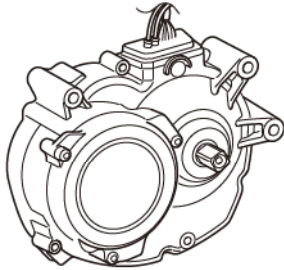

2

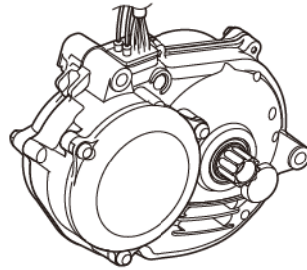

3

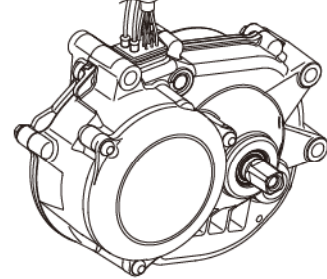

4

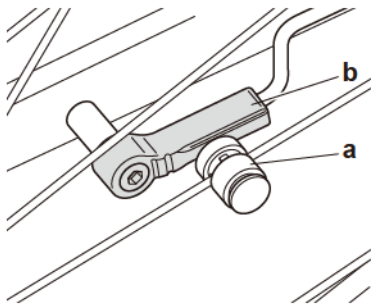

5

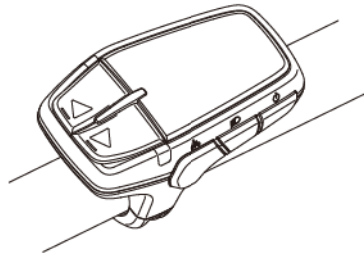

6

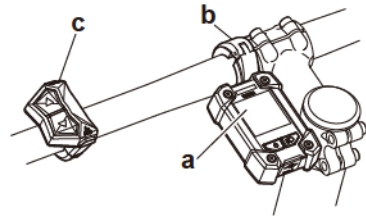

7

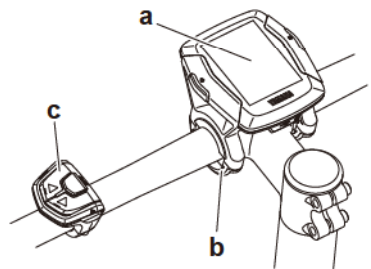

8

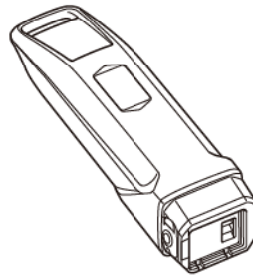

9

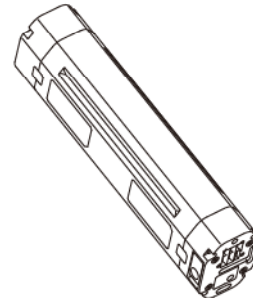

10

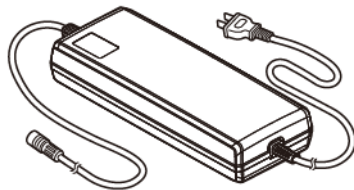

1. Drive Unit (PWseries SE)
2. Drive Unit (PW-X)
3. Drive Unit (PWseries TE)
4. Speed sensor set
 - a) Magnet sensor spoke type
 - b) Pick up
5. Display unit (Display A)

6. Display unit (Display X)
 - a) Display
 - b) Clamp
 - c) Switch
7. Display unit (Display C)
 - a) Display
 - b) Clamp
 - c) Switch

8. Battery pack (Down tube type
400 Wh/500 Wh)
9. Battery pack (Multi location
type 600 Wh)
10. Battery charger

D. E-Bike Systems

The e-Bike Systems are designed to give you the optimal amount of power assist.

It assists you within a standard range based on factors such as your pedaling strength, bicycle speed, and current gear.

The e-Bike Systems do not assist in the following situations:

- When the display unit's power is off.
- When you are moving 20 mph (32 km/h) or faster.
- When you are not pedaling and the pushing assist switch is released.
- When there is no residual battery capacity.
- When the automatic power off function* is operating.
 - * Power turns off automatically when you do not use the e-Bike Systems for 5 minutes.
- When the assist mode is set to Off mode.

Multiple power assist modes are available.

Choose from Extra Power mode, High-Performance mode, Standard mode, Eco mode, +Eco mode, Off mode and Automatic Support mode to suit your riding conditions.

See "Displaying and switching the assist mode" for information on switching between assist modes.

Extra Power mode^{*1}	Use when climbing rough terrain.
High-Performance mode	Use when you want to ride more comfortably, such as when climbing a steep hill.
Standard mode	Use when riding on flat roads or climbing gentle hills.
Eco mode +Eco mode	Use when you want to ride as far as possible.
Off mode	Use when you want to ride without power assist. You can still use the other display unit functions.
Automatic Support mode^{*2}	Use when you want the assist mode to change automatically to the best suited mode depending on the riding conditions.

*1 Applies only to the Drive Unit (PW-X).

*2 Applies only to the Drive Unit (PWseries TE).

Conditions that could decrease remaining assist distance

The remaining assist distance will decrease when riding in the following conditions:

- Frequent starts and stops
- Numerous steep inclines
- Poor road surface conditions
- When riding together with children
- Riding into a strong head wind
- Low air temperature
- Worn-out battery pack
- When using the headlight (applies only to models equipped with lights powered by the battery pack)
- Frequent acceleration
- Heavier rider and luggage weight
- Higher assist mode
- Higher riding speed

Remaining assist distance will also decrease if the bicycle is not maintained properly.

Examples of inadequate maintenance that could decrease remaining assist distance:

- Low tire pressure
- Chain not turning smoothly
- Brake engaged constantly

E. ⚠ Safety information

Never use this battery charger to charge other electrical appliances.

Do not use any other charger or charging method to recharge the special batteries. Using any other charger could result in fire, explosion, or damage the batteries.

This battery charger can be used by children aged from 8 years and above and persons with reduced physical, sensory or mental capabilities or lack of experience and knowledge if they have been given supervision or instruction concerning use of the battery charger in a safe way and understand the hazards involved. Children shall not play with the battery charger. Cleaning and user maintenance shall not be made by children without supervision.

Although the battery charger is waterproof, never allow it to become immersed in water or other fluids. In addition, never use the battery charger if the terminals are wet.

Never handle the power plug, charging plug or touch the charger contacts with wet hands. This could result in electric shock.

Do not touch charger contacts with metallic objects. Do not allow foreign material to cause short circuit of the contacts. This could result in electric shock, fire, or damage the battery charger.

Periodically remove dust from the power plug. Dampness or other issues could reduce the effectiveness of the insulation, resulting in fire.

Never disassemble or modify the battery charger. This could result in fire or electric shock.

Do not use with a power strip or extension cord. Using a power strip or similar methods may exceed rated current and can result in fire.

Do not use with the cable tied or rolled up, and do not store with the cable wrapped around the charger main body. Cable damage can result in fire or electric shock.

Firmly insert the power plug and the charging plug into the socket. Failure to insert the power plug and the charging plug completely can result in fire caused by electric shock or overheating.

Do not use the battery charger near flammable material or gas. This could result in fire or explosion.

Never cover the battery charger or place other objects on top of it while charging. This could result in internal overheating leading to fire.

Do not drop the battery charger or expose it to strong impacts. Otherwise, it could cause a fire or electric shock.

Store the battery pack and battery charger out of reach of children.

Do not touch the battery pack or battery charger while it is charging. As the battery pack or battery charger reaches 104–158 °F (40–70 °C) during charging, touching it could result in burns.

Do not use if the battery pack case is damaged, cracked, or if you smell any unusual odors. Leaking battery fluid can cause serious injury.

Do not short the contacts of the battery pack. Doing so could cause the battery pack to become hot or catch fire, resulting in serious injury or property damage.

Do not disassemble or modify the battery pack. Doing so could cause the battery pack to become hot or catch fire, resulting in serious injury or property damage.

If the power cable is damaged, stop using the battery charger and have it inspected at a bicycle dealer.

Do not turn the pedals or move the bicycle while the battery charger is connected. Doing so could cause the power cable to become tangled in the pedals, resulting in damage to the battery charger, power cable, and/or plug.

Handle the power cable with care. Connecting the battery charger from indoors while the bicycle is outdoors could result in the power cable becoming pinched and damaged in a doorway or window.

Do not run over the power cable or plug with the wheels of the bicycle. Doing so could result in damage to the power cable or plug.

Do not drop the battery pack or subject it to impact. Doing so could cause the battery pack to become hot or catch fire, resulting in serious injury or property damage.

Do not dispose of the battery pack in a fire or expose it to a heat source. Doing so could cause fire, or explosion, resulting in serious injury or property damage.

Do not modify or disassemble the e-Bike Systems. Do not install anything other than genuine parts and accessories. Doing so could result in product damage, malfunction, or increase your risk of injury.

When stopped, be sure to apply the front and rear brakes and keep both feet on the ground. Placing one's foot on the pedal when stopped may unintentionally engage the power assist function, which could result in loss of control and serious injury.

Do not ride the bicycle if there is any irregularity with the battery pack or e-Bike Systems. Doing so could lead to loss of control and serious injury.

Be sure to check the residual battery capacity before riding at night. The headlight powered by the battery pack will turn off soon after the residual battery capacity has decreased to where power assisted riding is no longer possible. Riding without an operating headlight can increase your risk of injury.

Do not start off by running with one foot on a pedal and one foot on the ground and then mounting the bicycle after it has reached a certain speed. Doing so could result in loss of control or serious injury. Be sure to start riding only after you are seated properly on the bicycle seat.

Do not press the pushing assist switch if the rear tire is off the ground. Otherwise, the tire will turn at high speed in the air and you could be injured.

Do not use the wireless function with Bluetooth low energy technology in areas such as hospitals or medical institutions where use of electronic equipment or wireless equipment is prohibited. Otherwise, this could affect the medical equipment, etc. and cause an accident.

When using the wireless function with Bluetooth low energy technology, keep the display at a safe distance from heart pacemakers in use. Otherwise, the radio waves could affect the heart pacemaker function.

Do not use the wireless function with Bluetooth low energy technology near automatic control equipment such as automatic doors, fire alarms, etc. Otherwise, the radio waves could affect the equipment and cause an accident through possible malfunction or unintentional operation.

F. Instrument and control functions

Display unit (Display A)

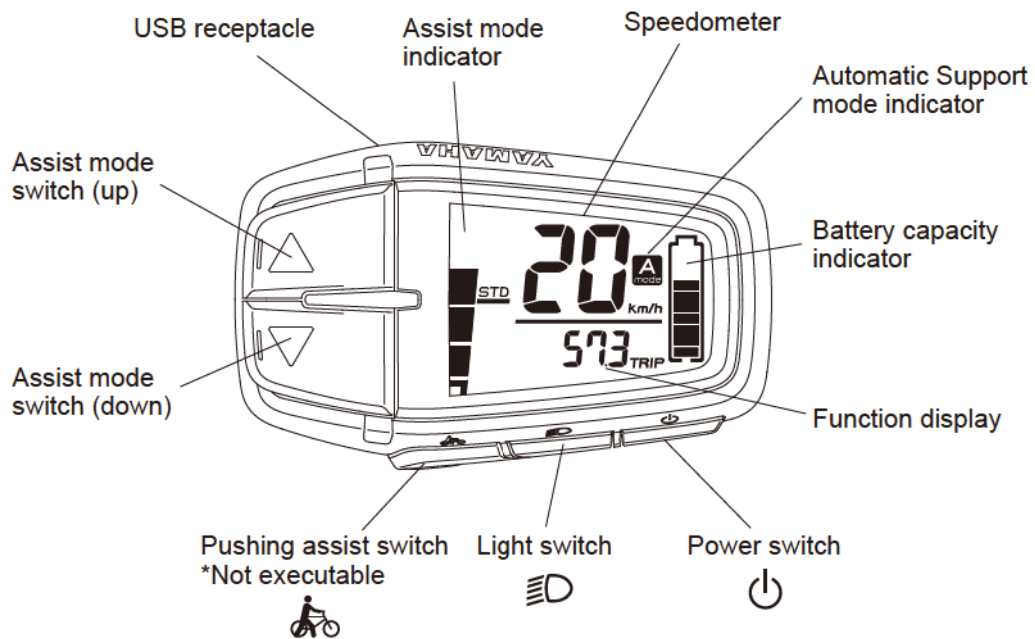

TIP

The USB receptacle is for connecting the designated YAMAHA tool; it cannot be used as a power supply.

Display unit (Display A)

The display unit offers the following operations and information displays.

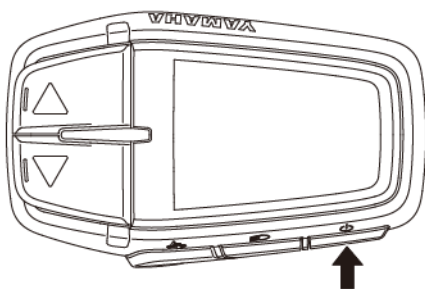
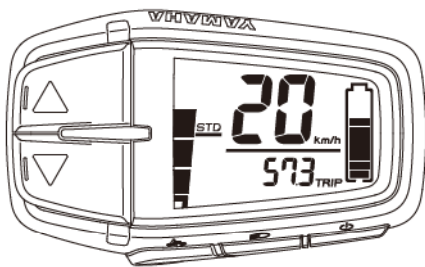

○ Power “On/Off”

Each time you press the power switch, the power switches between “On” and “Off”.

When you turn on the power, all of the displays come up. After that, it transitions to the main riding display.

TIP

- When you turn on the power, the assist mode is automatically set to Off mode.
- Keep your feet off the pedals when turning on the display unit. Also, do not start riding immediately after turning on the display unit. Doing so could weaken the assist power. (Weak assist power in either of these cases is not a malfunction.) If you did either of the above by accident, remove your feet from the pedals, turn on the power again, and wait a moment (approximately two seconds) before starting to ride.

○ Displaying and switching the assist mode

You can select the assist mode by using the assist mode switches (up & down).

The selected assist mode is displayed by the assist mode indicator.

- When you press the assist mode switch (up), the mode changes from “OFF” to “+ECO”, or from “+ECO” to “ECO”, or “ECO” to “STD”, or “STD” to “HIGH”, or “HIGH” to “EXPW”.
- When you press the assist mode switch (down), the mode changes from “EXPW” to “HIGH”, or from “HIGH” to “STD”, or “STD” to “ECO”, or “ECO” to “+ECO”, or “+ECO” to “OFF”.

TIP

- Bicycles equipped with the PWseries SE or PWseries TE drive unit have no Extra Power mode.
- Further pressing of the assist mode switch will not cycle the assist mode selections.

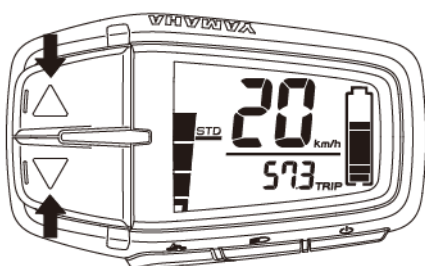

Bicycles equipped with the PWseries TE drive unit can use the Automatic Support mode.

TIP

The Automatic Support mode is a function enabling automatic change to the optimized assist mode according to the riding conditions.

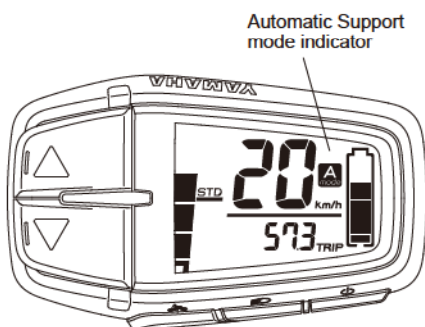

- To use the Automatic Support mode, press the assist mode switch (up) for 1 second or longer. The Automatic Support mode indicator will light up and the mode will be changed to the Automatic Support mode.
- To cancel the Automatic Support mode, press the assist mode switch (up) for 1 second or longer. The Automatic Support mode indicator will go off and the Automatic Support mode will be canceled.

TIP

Even if you press the assist mode switches (up & down) while in Automatic Support mode, the assist mode cannot be changed.

Assist mode	Assist mode indicator
EXPW	
HIGH	
STD	
ECO	
+ECO	
OFF	

PW-X drive unit

Assist mode	Assist mode indicator
HIGH	
STD	
ECO	
+ECO	
OFF	

PWseries SE drive unit

Assist mode	Assist mode indicator
Automatic Support mode	

PWseries TE drive unit

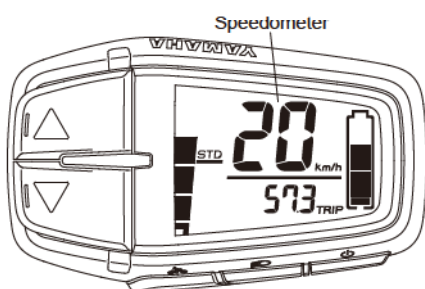
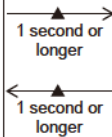

○ **Speedometer**

The speedometer displays your bicycle speed (in kilometer per hour or mile per hour). To select the km/mile, see “km/mile setting”.

TIP

If your bicycle speed is less than 2.0 km/h or 1.2 MPH, the speedometer displays “0 km/h or 0 MPH”.

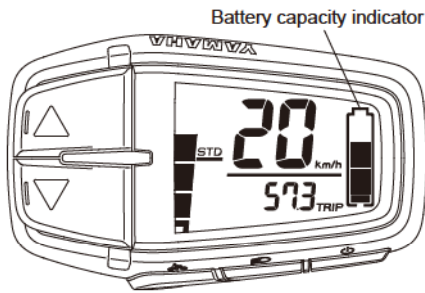

Battery capacity indicator

○ Battery capacity indicator

The battery capacity indicator displays an estimate of how much capacity is left in the battery.

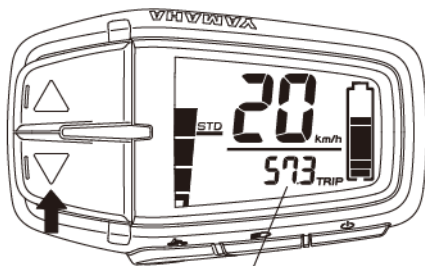

Function display

○ Function display

The function display can display the following functions.

- Odometer
- Trip meter
- Range (Remaining assist distance)

Push the assist mode switch (down) for 1 second or longer, the display changes as follows:

Odometer → Trip meter → Range → Odometer

You can reset the data for trip meter.

● Odometer

This displays the total distance (in kilometers or miles) ridden while the power was on. The odometer cannot be reset.

157^{ODO}

● Trip meter

This displays the total riding distance (in kilometers or miles) since it was last reset.

When you turn off the power, the data up to that point will be saved.

To reset the trip meter and begin counting a new total, press the assist mode switch (up) and assist mode switch (down) simultaneously for 2 seconds or longer when the trip meter is displayed.

33.1^{TRIP}

● Range (Remaining assist distance)

This displays an estimate of the distance (in kilometers or miles) that can be ridden with assist on the residual battery capacity of the battery installed. If you switch the assist mode when the remaining assist distance is displayed, the estimate of the distance that can be ridden with assist changes.

The remaining assist distance estimate cannot be reset.

86
RANGE

TIP

- The remaining assist distance changes depending on the riding situation (hills, headwind, etc.) and as the battery runs down.
- If in Off mode, “- - -” is displayed.

- **Headlight “On/Off” (Applies only to models equipped with a headlight powered by the battery pack. The taillight, which is powered by the battery pack, is switched on/off with the headlight.)** 

Each time you press the light switch, the headlight switches between “On” and “Off”.

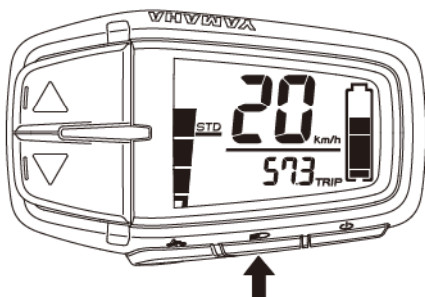

- **km/mile setting**

Use the following steps to set the km/mile setting.

1. Make sure that the display unit is turned on.
2. Select the odometer display in the function display.
3. Press the assist mode switch (up) and assist mode switch (down) simultaneously for 2 seconds or longer.
4. When either “km/h” or “MPH” flashes, release the switch.
5. Use the assist mode switches (up & down) to set either the km or mile unit.
6. While the unit that you want to set is flashing, press the assist mode switch (down) for 1 second or longer, and release the switch when the display returns to the main riding display.

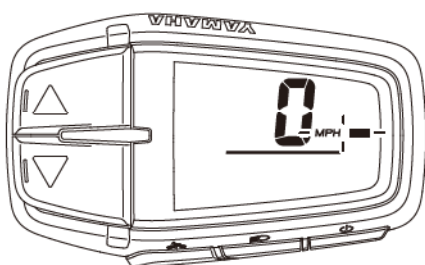
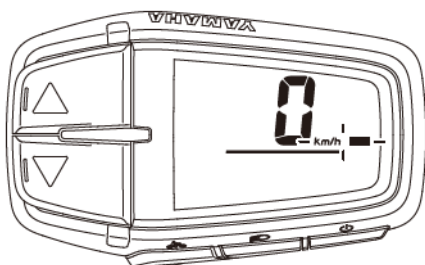
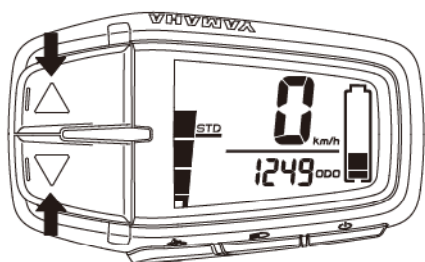

WARNING

For all setting procedures, be sure to stop the bicycle and perform the required settings in a safe location. Otherwise, lack of attention to surrounding traffic or other hazards could cause an accident.

TIP

- The settings cannot be adjusted while riding.
- If you do the following during setting, the item that you are setting will be canceled and the display will return to the main riding display.
 - Turning the crank (pedal) in the traveling direction
 - Turning the rear wheel at 1.2 mph (2 km/h) and more
 - Pushing the pushing assist switch

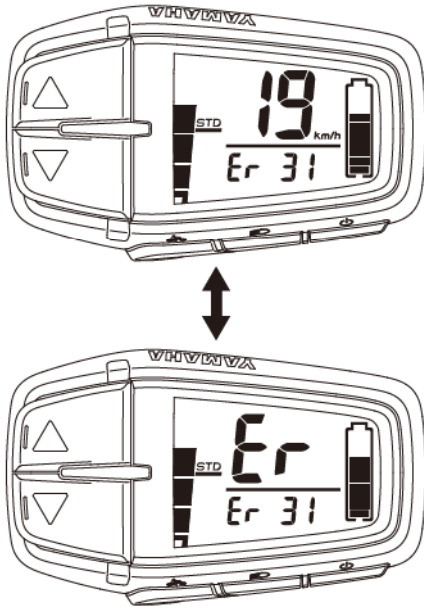

○ Diagnosis mode

The e-Bike Systems are equipped with a diagnosis mode. If a malfunction or fault occurs in the e-Bike Systems, the main riding display and “Er” will be shown alternately, while an error description will inform you of the type of error in the function display. See “Troubleshooting” regarding symptoms and remedies for abnormal displays and abnormal flashing.

⚠ WARNING

If the problem cannot be solved, have your bicycle inspected by a dealer as soon as possible.

Display unit (Display X)

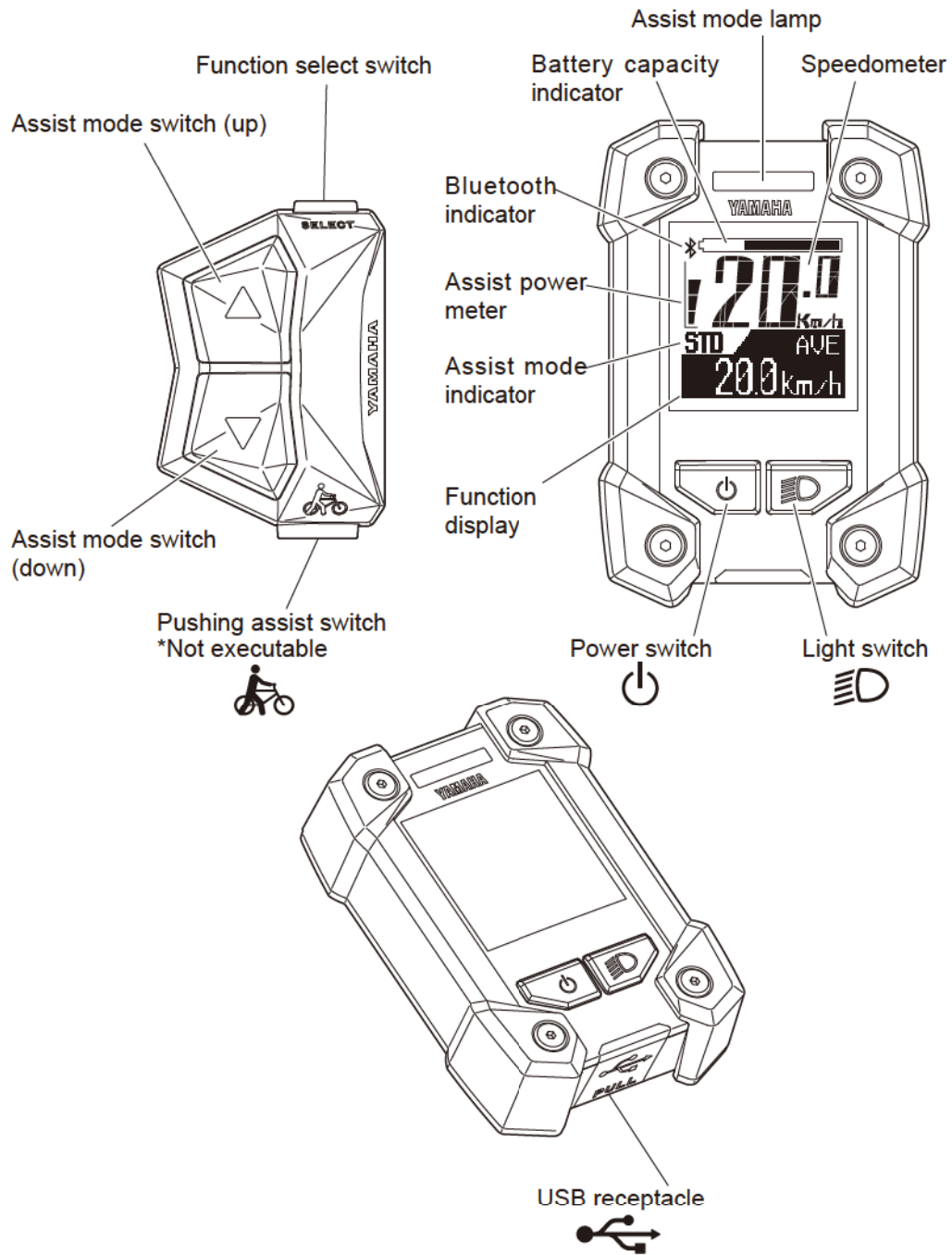

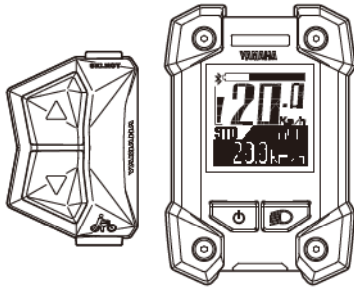

Display unit (Display X)

The display unit offers the following operations and information displays.

NOTICE

This device complies with part 15 of the FCC Rules and Industry Canada licence exempt RSS-247 standard. Operations is subject to the following two conditions (1) This device may not cause harmful interference, and (2) This device must accept any interference received, including interference that may cause undesired operation.

Le manuel d'utilisation des appareils radio exempts de licence doit contenir l'énoncé qui suit, ou l'équivalent, à un endroit bien en vue et/ou sur les appareils : Le présent appareil est conforme aux CNR d'Industrie Canada applicables aux appareils radio exempts de licence. L'exploitation est autorisée aux deux conditions suivantes : (1) l'appareil ne doit pas produire de brouillage, et (2) l'utilisateur de l'appareil doit accepter tout brouillage radioélectrique subi, même si le brouillage est susceptible d'en compromettre le fonctionnement.

FCC ID : 2ADBKX0P10
IC : 740A-X0P10
CAN ICES-3 (B)/NMB-3 (B)

Brand name : YAMAHA
Model no. : X0P10
Manufacturer name : YAMAHA MOTOR CO., LTD.

MADE IN CHINA

NOTICE

Federal Communication Commission Interference Statement

This equipment has been tested and found to comply with the limits for a Class B digital device, pursuant to Part 15 of the FCC Rules. These limits are designed to provide reasonable protection against harmful interference in a residential installation. This equipment generates, uses and can radiate radio frequency energy and, if not installed and used in accordance with the instructions, may cause harmful interference to radio communications. However, there is no guarantee that interference will not occur in a particular installation. If this equipment does cause harmful interference to radio or television reception, which can be determined by turning the equipment off and on, the user is encouraged to try to correct the interference by one of the following measures:

- Reorient or relocate the receiving antenna.
- Increase the separation between the equipment and receiver.
- Connect the equipment into an outlet on a circuit different from that to which the receiver is connected.
- Consult the dealer or an experienced radio/TV technician for help.

FCC Caution:

To assure continued compliance, any changes or modifications not expressly approved by the party responsible for compliance could void the user's authority to operate this equipment. (Example - use only shielded interface cables when connecting to computer or peripheral devices.)

FCC Radiation Exposure Statement:

This equipment complies with FCC RF radiation exposure limits set forth for an uncontrolled environment. This transmitter must not be co-located or operating in conjunction with any other antenna or transmitter.

IC Radiation Exposure Statement:

This equipment complies with IC RSS-102 radiation exposure limits set forth for an uncontrolled environment. This equipment should be installed and operated with minimum distance 0.5 cm between the radiator and your body.

Déclaration d'exposition à la radiation:

Cet équipement respecte les limites d'exposition aux rayonnements IC RSS-102 définies pour un environnement non contrôlé. Cet équipement doit être installé et mis en marche à une distance minimale de 0.5 cm qui sépare l'élément rayonnant de votre corps.

The display unit offers the following operations and information displays.

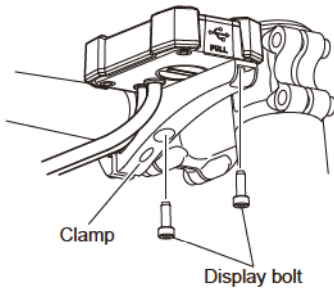

○ Installing the battery

The display unit needs to be removed and installed for changing the battery.

- Remove the two display bolts on back side of the clamp, and then remove the display unit.
- When installing the display unit, tighten the two display bolts from the back side of the clamp.

⚠ WARNING

Tighten the display bolts to 2 N·m. Otherwise, during riding, vibration could cause the display bolts to come loose with the risk that the display unit may fall off. A loose display could distract the rider or interfere with control.

TIP

- The clamp and display unit might be installed on the right side of the stem.
- For models without this clamp, the above note does not apply.

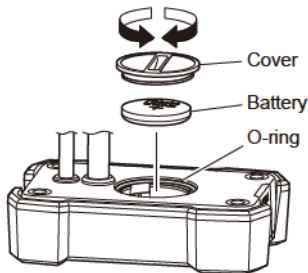

○ Battery

Check if the rated battery (CR2032) is installed in the rear of the display unit.

If a battery is not installed, or if there is not sufficient battery power remaining, install a new battery.

To adjust the time, see "Stopwatch and settings".

TIP

- Make sure that the O-ring is installed correctly.
- Use a new CR2032 button cell battery (sold separately).
- When a battery is drained, whenever it turns on the vehicle power supply, the clock begins to count from 11:00. Please replace the battery, if such a condition appears.

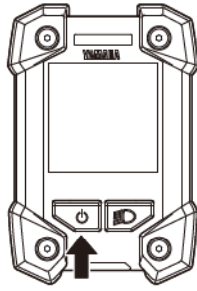

○ Power “On/Off”

Each time you press the power switch, the power switches between “On” and “Off”.

When you turn on the power, all of the displays come up. After that, it transitions to the main riding display.

TIP

- When you turn on the power, the assist mode is automatically set to Off mode.
- Keep your feet off the pedals when turning on the display unit. Also, do not start riding immediately after turning on the display unit. Doing so could weaken the assist power. (Weak assist power in either of these cases is not a malfunction.) If you did either of the above by accident, remove your feet from the pedals, turn on the power again, and wait a moment (approximately two seconds) before starting to ride.

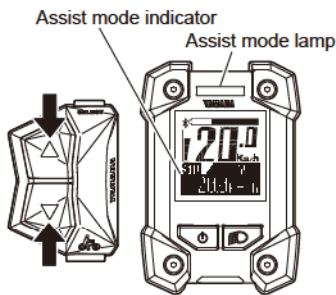

○ Displaying and switching the assist mode

You can select the assist mode by using the assist mode switches (up & down).

The selected assist mode is displayed by the assist mode indicator and assist mode lamp color.

- When you press the assist mode switch (up), the mode changes from “OFF” to “+ECO”, or from “+ECO” to “ECO”, or “ECO” to “STD”, or “STD” to “HIGH”, or “HIGH” to “EXPW”.
- When you press the assist mode switch (down), the mode changes from “EXPW” to “HIGH”, or from “HIGH” to “STD”, or “STD” to “ECO”, or “ECO” to “+ECO”, or “+ECO” to “OFF”.

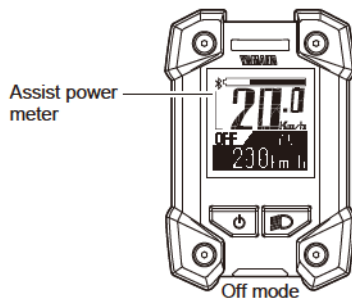

TIP

- Bicycles equipped with the PWseries SE or PWseries TE drive unit have no Extra Power mode.
- Further pressing of the assist mode switch will not cycle the assist mode selections.
- In the Off mode, the assist power meter is not displayed.
- You can keep the assist mode lamp unlit. For more information, see “Stopwatch and settings”.

Bicycles equipped with the PWseries TE drive unit can use the Automatic Support mode.

TIP

The Automatic Support mode is a function enabling automatic change to the optimized assist mode according to the riding conditions.

- When you use the Automatic Support mode, press the assist mode switch (up) for 1 second or longer. "A:" will be added to the assist mode indicator and the mode will be changed to the Automatic Support mode.
- To cancel the Automatic Support mode, press the assist mode switch (up) for 1 second or longer. "A:" will disappear from the assist mode indicator and the Automatic Support mode will be canceled.

TIP

Even if you press the assist mode switches (up & down) while in Automatic Support mode, the assist mode cannot be changed.

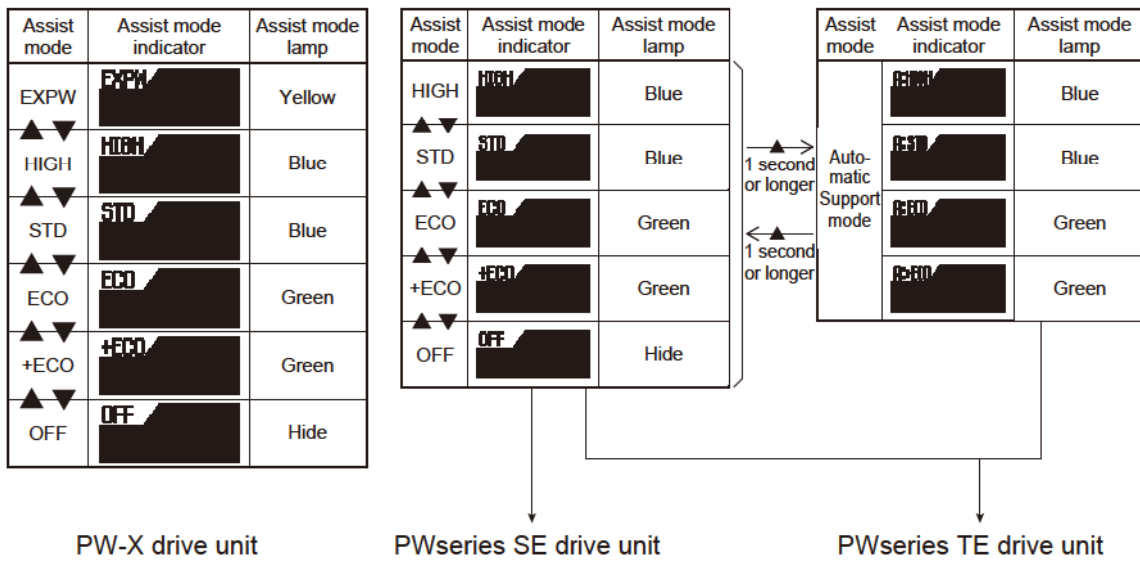

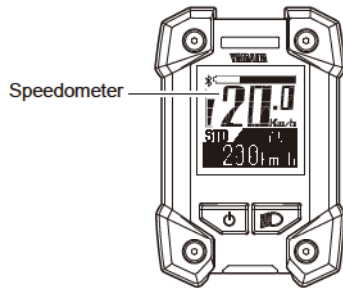

○ Speedometer

The speedometer displays your bicycle speed (in kilometer per hour or mile per hour). To select the km/mile, see “Stopwatch and settings”.

TIP

If your bicycle speed is less than 2.0 km/h or 1.2 MPH, the speedometer displays “0.0 km/h” or “0.0 MPH”.

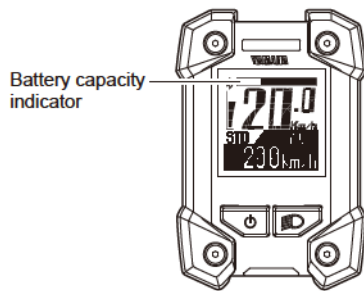

○ Battery capacity indicator

The battery capacity indicator displays an estimate of how much capacity is left in the battery.

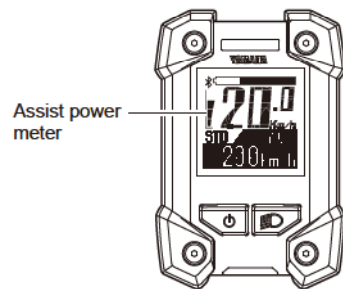

○ Assist power meter

The assist power meter displays an estimate of the assist power during riding.

When the e-Bike Systems are not in operation, none of the segments of the assist power meter are displayed. When the e-Bike Systems are operating, as the assist power increases, the segments of the assist power meter are added one by one.

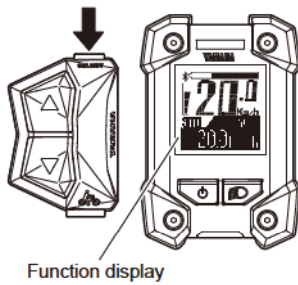

Function display

○ Function display

The function display can display the following functions.

- Odometer
- Trip meter
- Average bicycle speed
- Maximum bicycle speed
- Range (Remaining assist distance)
- Battery capacity (%)
- Cadence
- Clock

Push the function select switch, the display changes as follows:

Odometer → Trip meter → Average bicycle speed → Maximum bicycle speed → Range → Battery capacity (%) → Cadence → Clock → Odometer

You can select the items to be displayed.

For more information, see “Stopwatch and settings”.

You can reset the data for trip meter, average bicycle speed, and maximum bicycle speed.

For more information, see “Stopwatch and settings”.



● Odometer

This displays the total distance (in kilometers or miles) ridden while the power was on.

The odometer cannot be reset.



● Trip meter

This displays the total riding distance (in kilometers or miles) since it was last reset.

When you turn off the power, the data up to that point will be saved.

For the procedure of resetting the trip meter to measure a new distance traveled, see “Stopwatch and settings”.



● Average bicycle speed

This displays the average bicycle speed (in kilometers per hour or miles per hour) since it was last reset.

When you turn off the power, the data up to that point will be saved.

For the procedure of resetting the average bicycle speed, see “Stopwatch and settings”.



● Maximum bicycle speed

This displays the maximum bicycle speed (in kilometers per hour or miles per hour) since it was last reset.

When you turn off the power, the data up to that point will be saved.

For the procedure of resetting the maximum bicycle speed, see “Stopwatch and settings”.



● Range (Remaining assist distance)

This displays an estimate of the distance (in kilometers or miles) that can be ridden with assist on the residual battery capacity of the battery installed. If you switch the assist mode when the remaining assist distance is displayed, the estimate of the distance that can be ridden with assist changes.

The remaining assist distance estimate cannot be reset.

TIP

- The remaining assist distance changes depending on the riding situation (hills, headwind, etc.) and as the battery runs down.
- If in Off mode, “- - -” is displayed.



● Battery capacity (%)

This displays the power remaining in the battery.

The residual battery capacity display cannot be reset.



● Cadence

This displays your pedaling speed in revolutions per minute.

The pedaling cadence display cannot be reset.

TIP

If you pedal in backward, “0” is displayed.



● Clock

Displays the current time in 24 hour format. To adjust the time, see “Stopwatch and settings”.

- **Headlight “On/Off” (Applies only to models equipped with a headlight powered by the battery pack. The taillight, which is powered by the battery pack, is switched on/off with the headlight.)** 

Each time you press the light switch, the headlight switches between “On” and “Off”.

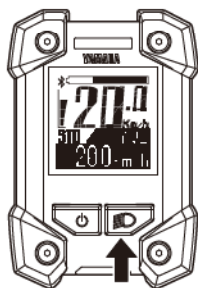

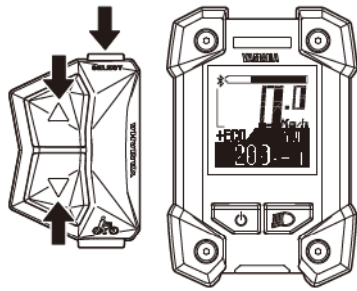

Main riding display

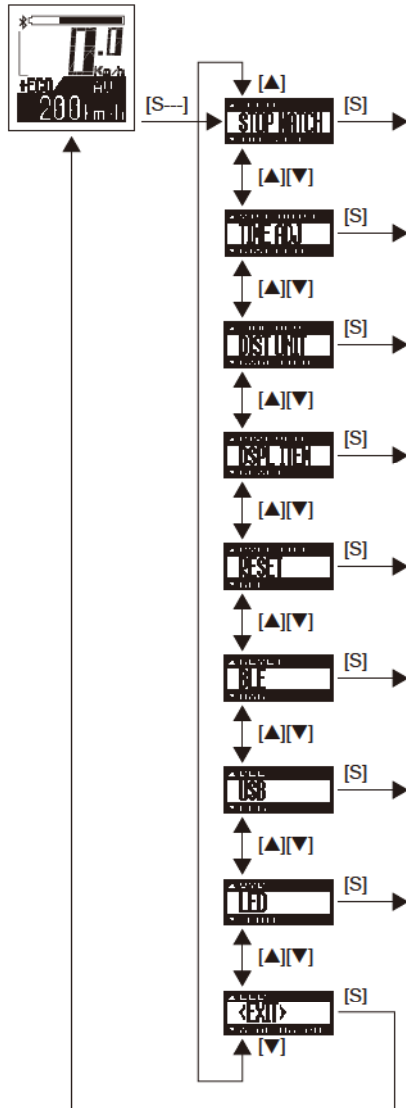

○ Stopwatch and settings

The display enables the following.

- STOPWATCH
Stopwatch function
- TIME ADJ (TIME ADJUST)
Clock setting
- DIST UNIT (DISTANCE UNIT)
km/mile setting
- DSPL ITEM (DISPLAY ITEM)
Sets the items to be displayed in the function display during normal riding.
- RESET
Resets the values of the trip meter, average bicycle speed, and maximum bicycle speed.
- BLE (Bluetooth low energy technology)
Switches the profiles and turns off the wireless function.
- USB
Switches the USB receptacle between a power supply port and a wired communication port.
- LED
Changes between lighting the assist mode lamp and keeping the assist mode lamp unit.

1. Press the function select switch for 2 seconds or longer.
2. Select an item by using the assist mode switches (up & down).

Press the function select switch at the displayed item that you want to select, and the selected item will then be displayed.
Selecting "EXIT" returns to the main riding display.

⚠ WARNING

For all setting procedures, be sure to stop the bicycle and perform the required settings in a safe location. Otherwise, lack of attention to surrounding traffic or other hazards could cause an accident.

TIP

- The settings cannot be adjusted while riding.
- If you do the following during setting, the item that you are setting will be canceled and the display will return to the main riding display.
 - Turning the crank (pedal) in the traveling direction
 - Turning the rear wheel at 1.2 mph (2 km/h) and more
 - Pushing the pushing assist switch

[S---] Press the function select switch for 2 seconds or longer

[S] Press the function select switch

[▲] Press the assist mode switch (up)

[▼] Press the assist mode switch (down)

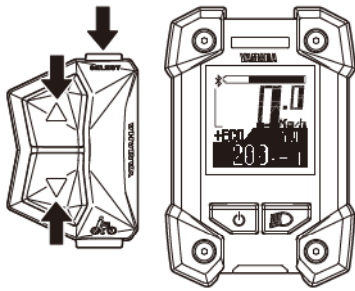

● STOPWATCH

The stopwatch counts time in seconds up to a maximum of 9 hours 59 minutes 59 seconds.

If this maximum is reached, it will automatically start over from 0 (zero) and continue counting.

• TIME MEASUREMENT

Use the function select switch to start and stop time measurement.

Press the function select switch for 2 seconds or longer to “RESET” the measured time.

• RESET

When the function select switch is pressed, the measured time will be reset and the measuring display will be shown.

Use the assist mode switches (up & down) to go to the “EXIT” display.

• EXIT

When the function select switch is pressed, the display will return to the main riding display.

Use the assist mode switches (up & down) to go to the “RESET” display.

TIP

- It is possible to return to the main riding display without interrupting time measurement.
- When the power is turned off, the measured time will be reset.

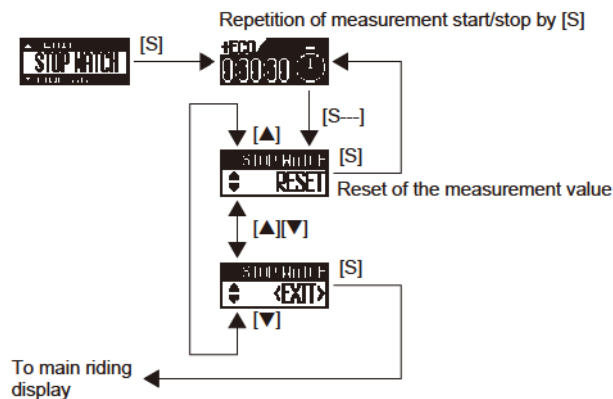

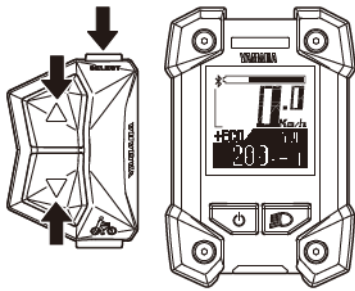

● TIME ADJ (TIME ADJUST)

You can adjust the time of the clock.

1. Check that the “Hour” is flashing and adjust the hour by using the assist mode switches (up & down).
2. Press the function select switch to adjust the minutes.
3. Check that the “Minute” is flashing and adjust the minutes by using the assist mode switches (up & down).
4. Press the function select switch to return to the main riding display.

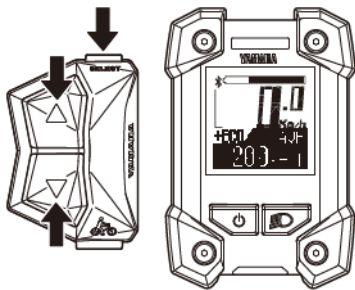
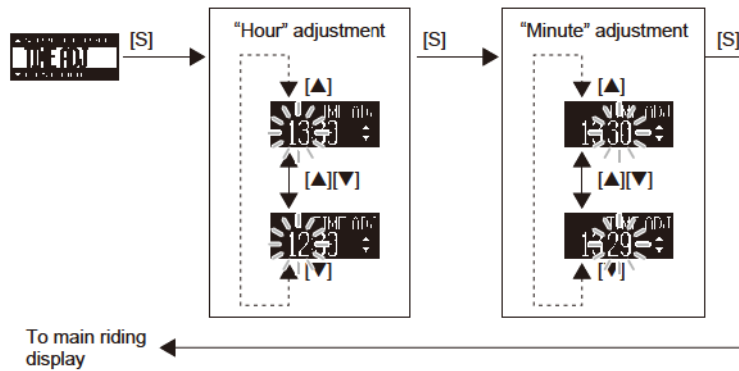

● DIST UNIT (DISTANCE UNIT)

You can select the display units for distance and speed. When “km” is selected, the traveled distance will be indicated in kilometers and the speed in km/h. When “mile” is selected, the traveled distance will be indicated in miles and the speed in mph.

1. Select “km” or “mile” by using the assist mode switches (up & down).
2. Press the function select switch when the desired unit is indicated in the display. This setting will then be kept and the display will return to the main riding display.

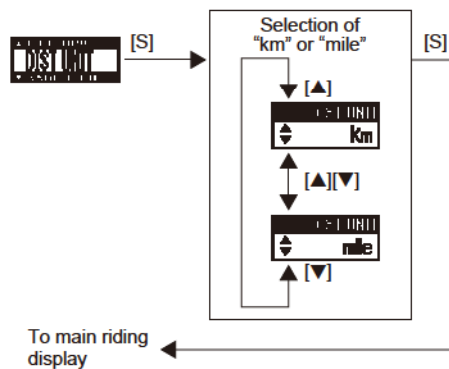

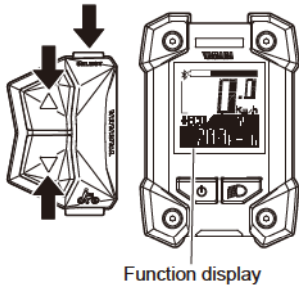

● DSPL ITEM (DISPLAY ITEM)

You can select to show or hide different items in the function display during normal riding.

The items which you can select to show or hide are: TRIP (trip meter), AVE (average bicycle speed), MAX (maximum bicycle speed), RANGE (remaining assist distance), BATTERY (battery capacity (%)), CADENCE (cadence), and TIME (clock).

TIP

You cannot hide the odometer indication.

1. Select an item by using the assist mode switches (up & down).
2. Use the function select switch to show or hide the selected item. (When an item is shown, a check mark will be shown in the check box.)
3. When you press the function select switch in the "EXIT" display, the setting will be kept and the display will return to the main riding display.

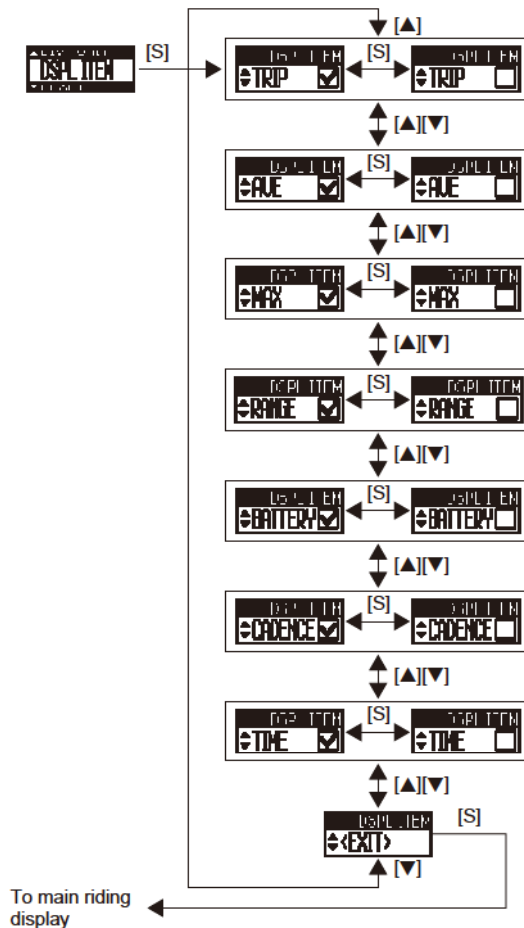

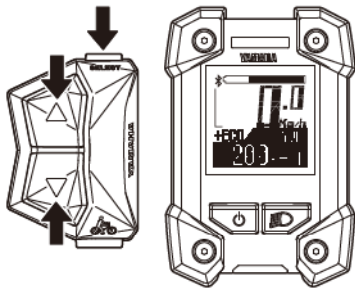

● RESET

You can reset the TRIP (trip meter), AVE (average bicycle speed), and MAX (maximum bicycle speed) values.

TIP

You cannot reset the odometer.

1. Select an item by using the assist mode switches (up & down) and use the function select switch to place a check mark in the check box for the item that you want to reset.
2. When you press the function select switch in the “EXIT” display, the items with check marks will be reset and the display will return to the main riding display.

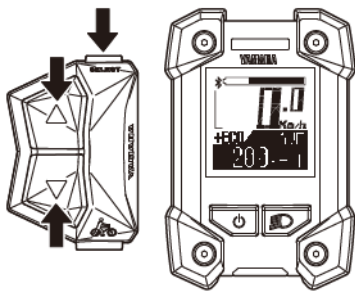
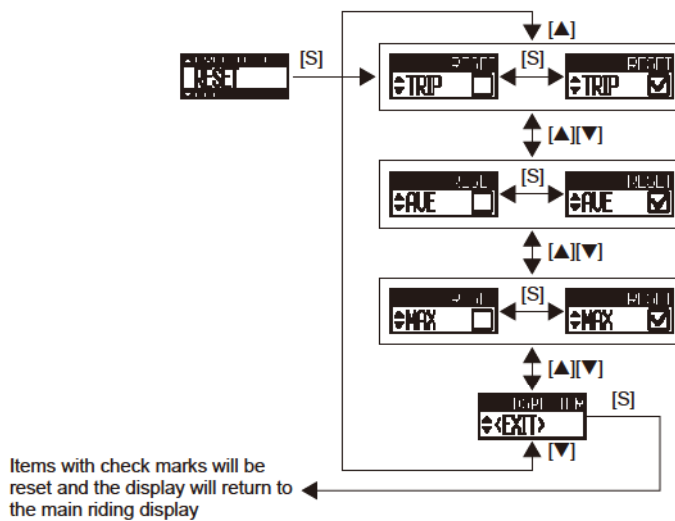

● BLE (Bluetooth low energy technology)

You can set the profile to use the wireless function with Bluetooth low energy technology, or you can select not to use the wireless function.

When “CSCP” is selected, the Cycling Speed and Cadence Profile will be available.

When “CPP” is selected, the Cycling Power Profile will be available.

When “OFF” is selected, the wireless function will be inactive.

TIP

- Set the profile according to the wireless communication equipment that communicates via Bluetooth low energy technology.
- For the output power level of each profile, see “Specifications”.
- Even if the power is turned off, the setting will be kept. When the power is turned on the next time, the last used setting will be selected.