

# Test Report

## FCC: 2ADAO-CT183QV110

Product Name:	kontakt.io Card Tag CT18-3Q
Trademark:	kontakt.io
Model Name :	kontakt.io Card Tag CT18-3Q
Prepared For :	Kontakt Micro-Location Sp. z o.o.
Address :	Ul. Stoczniewców 3,30-709 Kraków, Poland
Prepared By :	Shenzhen BCTC Testing Co., Ltd.
Address :	BCTC Building & 1-2F, East of B Building, Pengzhou Industrial, Fuyuan 1st Road, Qiaotou Community, Fuyong Street, Bao'an District, Shenzhen, China
Test Date:	Sep. 16, 2019 to Oct. 15, 2019
Date of Report :	Oct. 15, 2019
Report No.:	BCTC-LH190901155E

## TEST RESULT CERTIFICATION

**Applicant's name** ..... : Kontakt Micro-Location Sp. z o.o.  
**Address** ..... : Ul. Stoczniowców 3,30-709 Kraków, Poland

**Manufacture's Name** ..... : Kontakt Micro-Location Sp. z o.o.  
**Address** ..... : Ul. Stoczniowców 3,30-709 Kraków, Poland

### Product description

**Product name** ..... : kontakt.io Card Tag CT18-3Q  
**Trademark** ..... : kontakt.io  
**Model and/or type reference** : kontakt.io Card Tag CT18-3Q

**Standards** ..... : FCC Part15.247  
ANSI C63.10:2013  
KDB558074 D01 15.247 Meas Guidance v05r02

This device described above has been tested by BCTC, and the test results show that the equipment under test (EUT) is in compliance with the FCC requirements. And it is applicable only to the tested sample identified in the report.

This report shall not be reproduced except in full, without the written approval of BCTC, this document may be altered or revised by BCTC, personal only, and shall be noted in the revision of the document.

**Prepared by(Engineer):** Bin Mei

**Reviewer(Supervisor):** Eric Yang

**Approved(Manager):** Zero Zhou



	Page
<b>1 . SUMMARY OF TEST RESULTS</b>	<b>5</b>
1.1 TEST FACILITY	6
1.2 MEASUREMENT UNCERTAINTY	6
<b>2 . GENERAL INFORMATION</b>	<b>7</b>
2.1 GENERAL DESCRIPTION OF EUT	7
2.2 DESCRIPTION OF TEST MODES	8
2.3 BLOCK DIGRAM SHOWING THE CONFIGURATION OF SYSTEM TESTED	9
2.4 DESCRIPTION OF SUPPORT UNITS(CONDUCTED MODE)	9
2.5 EQUIPMENTS LIST FOR ALL TEST ITEMS	10
<b>3 . EMC EMISSION TEST</b>	<b>12</b>
3.1 CONDUCTED EMISSION MEASUREMENT	12
3.1.1 POWER LINE CONDUCTED EMISSION LIMITS	12
3.1.2 TEST PROCEDURE	12
3.1.3 DEVIATION FROM TEST STANDARD	12
3.1.4 TEST SETUP	13
3.1.5 EUT OPERATING CONDITIONS	13
3.1.6 TEST RESULTS	13
3.2 RADIATED EMISSION MEASUREMENT	14
3.2.1 RADIATED EMISSION LIMITS	14
3.2.2 TEST PROCEDURE	15
3.2.3 DEVIATION FROM TEST STANDARD	15
3.2.4 TEST SETUP	16
3.2.5 EUT OPERATING CONDITIONS	17
3.2.6 TEST RESULTS (BETWEEN 9KHZ – 30 MHZ)	18
3.2.7 TEST RESULTS (BETWEEN 30MHZ – 1GHZ)	19
3.3 RADIATED BAND EMISSION MEASUREMENT AND RESTRICTED BANDS OF OPERATION	22
3.3.1 TEST REQUIREMENT:	22
3.3.2 TEST PROCEDURE	22
3.3.3 DEVIATION FROM TEST STANDARD	23
3.3.4 TEST SETUP	23
3.3.5 EUT OPERATING CONDITIONS	23
<b>4 . POWER SPECTRAL DENSITY TEST</b>	<b>25</b>
4.1 APPLIED PROCEDURES / LIMIT	25

	<b>Page</b>
<b>Table of Contents</b>	
4.1.1 TEST PROCEDURE	25
4.1.2 DEVIATION FROM STANDARD	25
4.1.3 TEST SETUP	25
4.1.4 EUT OPERATION CONDITIONS	25
4.1.5 TEST RESULTS	26
<b>5 . BANDWIDTH TEST</b>	<b>28</b>
5.1 APPLIED PROCEDURES / LIMIT	28
5.1.1 TEST PROCEDURE	28
5.1.2 DEVIATION FROM STANDARD	28
5.1.3 TEST SETUP	28
5.1.4 EUT OPERATION CONDITIONS	28
5.1.5 TEST RESULTS	29
<b>6 . PEAK OUTPUT POWER TEST</b>	<b>31</b>
6.1 APPLIED PROCEDURES / LIMIT	31
6.1.1 TEST PROCEDURE	31
6.1.2 DEVIATION FROM STANDARD	31
6.1.3 TEST SETUP	31
6.1.4 EUT OPERATION CONDITIONS	31
6.1.5 TEST RESULTS	32
<b>7 . 100 KHZ BANDWIDTH OF FREQUENCY BAND EDGE</b>	<b>33</b>
7.1 APPLICABLE STANDARD	33
7.2 TEST PROCEDURE	33
7.3 DEVIATION FROM STANDARD	33
7.4 TEST SETUP	33
7.5 EUT OPERATION CONDITIONS	33
<b>8 . ANTENNA REQUIREMENT</b>	<b>36</b>
8.1 STANDARD REQUIREMENT	36
8.2 EUT ANTENNA	36
<b>9 . EUT TEST PHOTO</b>	<b>37</b>
<b>10 . EUT PHOTO</b>	<b>38</b>
<b>APPENDIX-PHOTOGRAPHS OF EUT CONSTRUCTIONAL DETAILS</b>	

## 1. SUMMARY OF TEST RESULTS

Test procedures according to the technical standards:

<b>FCC Part15 (15.247) , Subpart C</b>			
Standard Section	Test Item	Judgment	Remark
RSS-GEN 8.8 RSS-247 3.1 15.207	Conducted Emission	N/A	
RSS-247 5.2 (a) 15.247 (a)(2)	6dB Bandwidth	PASS	
RSS-247 5.4 (b) 15.247 (b)	Peak Output Power	PASS	
RSS-247 5.5 15.247 (d), 15.205	Radiated Spurious Emission	PASS	
RSS-247 5.2 (b) 15.247 (e)	Power Spectral Density	PASS	
RSS-247 5.5 15.205	Restricted Band of Operation	PASS	
RSS-Gen.6.7 15.247(d)	Band Edge (Out of Band Emissions)	PASS	
RSS-GEN 8.8 RSS-247 3.1 15.203	Antenna Requirement	PASS	

**NOTE:**

(1) "N/A" denotes test is not applicable in this Test Report

### 1.1 TEST FACILITY

Shenzhen BCTC Testing Co., Ltd.  
 Add.: BCTC Building & 1-2F, East of B Building, Pengzhou Industrial, Fuyuan 1st Road, Qiaotou Community, Fuyong Street, Bao'an District, Shenzhen, China  
 FCC Test Firm Registration Number: 712850  
 Test site MRA number: CN1212  
 IC Registered No.: 23583

### 1.2 MEASUREMENT UNCERTAINTY

The reported uncertainty of measurement  $y \pm U$ , where expanded uncertainty  $U$  is based on a standard uncertainty multiplied by a coverage factor of  $k=2$ , providing a level of confidence of approximately 95 %.

No.	Item	Uncertainty
1	3m chamber Radiated spurious emission(30MHz-1GHz)	U=4.3dB
2	3m chamber Radiated spurious emission(1GHz-18GHz)	U=4.5dB
3	3m chamber Radiated spurious emission(18GHz-40GHz)	U=3.34dB
4	Conducted Adjacent channel power	U=1.38dB
5	Conducted output power uncertainty Above 1G	U=1.576dB
6	Conducted output power uncertainty below 1G	U=1.28dB
7	humidity uncertainty	U=5.3%
8	Temperature uncertainty	U=0.59 °C

## 2. GENERAL INFORMATION

### 2.1 GENERAL DESCRIPTION OF EUT

Equipment	kontakt.io Card Tag CT18-3Q	
Trade Name	kontakt.io	
Model Name	kontakt.io Card Tag CT18-3Q	
Model Difference	N/A	
Product Description	The EUT is a kontakt.io Card Tag CT18-3Q	
	Operation Frequency:	2401-2481 MHz
	Modulation Type:	GFSK
	Number Of Channel	81CH
	Antenna Designation:	Please see Note 3.
Based on the application, features, or specification exhibited in User's Manual, the EUT is considered as an ITE/Computing Device. More details of EUT technical specification, please refer to the User's Manual.		
Channel List	Please refer to the Note 2.	
Power Source	DC 3.0V	
Connecting I/O Port(s)	Please refer to the User's Manual	
Product SW/HW version	PSW:	A1.1
	PHW:	V1.1
Radio SW/HW version	RSW:	V1.1
	RHW:	A1.1
Test SW Version	V1.1	

Note:

1. For a more detailed features description, please refer to the manufacturer's specifications or the User's Manual.



2.

Channel List					
Channel	Frequency (MHz)	Channel	Frequency (MHz)	Channel	Frequency (MHz)
01	2401	31	2431	61	2461
02	2402	32	2432	62	2462
03	2403	33	2433	63	2463
04	2404	34	2434	64	2464
05	2405	35	2435	65	2465
06	2406	36	2436	66	2466
07	2407	37	2437	67	2467
08	2408	38	2438	68	2468
09	2409	39	2439	69	2469
10	2410	40	2440	70	2470
11	2411	41	2441	71	2471
12	2412	42	2442	72	2472
13	2413	43	2443	73	2473
14	2414	44	2444	74	2474
15	2415	45	2445	75	2475
16	2416	46	2446	76	2476
17	2417	47	2447	77	2477
18	2418	48	2448	78	2478
19	2419	49	2449	79	2479
20	2420	50	2450	80	2480
21	2421	51	2451	81	2481
22	2422	52	2452		
23	2423	53	2453		
24	2424	54	2454		
25	2425	55	2455		
26	2426	56	2456		
27	2427	57	2457		
28	2428	58	2458		
29	2429	59	2459		
30	2430	60	2460		

3.

Table for Filed Antenna

Ant.	Brand	Model Name	Antenna Type	Gain (dBi)
1	N/A	N/A	PCB antenna	1.1

## 2.2 DESCRIPTION OF TEST MODES

To investigate the maximum EMI emission characteristics generates from EUT, the test system was pre-scanning tested base on the consideration of following EUT operation mode or test configuration mode which possible have effect on EMI emission level. Each of these EUT operation mode(s) or test configuration mode(s) mentioned above was evaluated respectively.



For All Mode	Description	Modulation Type
Mode 1	CH01	GFSK
Mode 2	CH41	
Mode 3	CH81	
Mode 4	Link mode(Radiated emission)	

Note:

- (1) The measurements are performed at the highest, middle, lowest available channels.
- (2) Fully-charged battery is used during the test

## 2.3 BLOCK DIGRAM SHOWING THE CONFIGURATION OF SYSTEM TESTED

### Radiated Spurious Emission Test

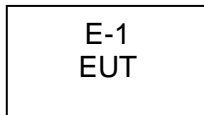

## 2.4 DESCRIPTION OF SUPPORT UNITS(CONDUCTED MODE)

The EUT has been tested as an independent unit together with other necessary accessories or support units. The following support units or accessories were used to form a representative test configuration during the tests.

No.	Device Type	Brand	Model	Series No.	Data Cable
E-1	kontakt.io Card Tag CT18-3Q	kontakt.io	kontakt.io Card Tag CT18-3Q	N/A	EUT

Note:

- (1) The support equipment was authorized by Declaration of Confirmation.
- (2) For detachable type I/O cable should be specified the length in cm in 『Length』 column.

## 2.5 EQUIPMENTS LIST FOR ALL TEST ITEMS

### Radiation Test equipment

Item	Equipment	Manufacturer	Type No.	Serial No.	Last calibration	Calibrated until
1	Spectrum Analyzer (9kHz-26.5GHz)	Agilent	E4407B	MY45109572	Jun. 13, 2019	Jun. 12, 2020
2	Test Receiver (9kHz-7GHz)	R&S	ESR7	101154	Jun. 13, 2019	Jun. 12, 2020
3	Bilog Antenna (30MHz-3GHz)	SCHWARZBE CK	VULB9163	VULB9163-94 2	Jun. 22, 2019	Jun. 21, 2020
4	Horn Antenna (1GHz-18GHz)	SCHWARZBE CK	BBHA9120D	1541	Jun. 22, 2019	Jun. 21, 2020
5	Horn Antenna (18GHz-40GHz)	SCHWARZBE CK	BBHA9170	822	Jun. 22, 2019	Jun. 21, 2020
6	Amplifier (9KHz-6GHz)	SCHWARZBE CK	BBV9744	9744-0037	Jun. 25, 2019	Jun. 24, 2020
7	Amplifier (0.5GHz-18GHz)	SCHWARZBE CK	BBV9718	9718-309	Jun. 25, 2019	Jun. 24, 2020
8	Amplifier (18GHz-40GHz)	MITEQ	TTA1840-35- HG	2034381	Jun. 17, 2019	Jun. 16, 2020
9	Loop Antenna (9KHz-30MHz)	SCHWARZBE CK	FMZB1519B	014	Jul. 02, 2019	Jul. 01, 2020
10	RF cables1 (9kHz-30MHz)	Huber+Suhnar	9kHz-30MHz	B1702988-000 8	Jun. 25, 2019	Jun. 24, 2020
11	RF cables2 (30MHz-1GHz)	Huber+Suhnar	30MHz-1GHz	1486150	Jun. 25, 2019	Jun. 24, 2020
12	RF cables3 (1GHz-40GHz)	Huber+Suhnar	1GHz-40GHz	1607106	Jun. 25, 2019	Jun. 24, 2020
13	Power Metter	Keysight	E4419B	\	Jun. 17, 2019	Jun. 16, 2020
14	Power Sensor (AV)	Keysight	E9 300A	\	Jun. 17, 2019	Jun. 16, 2020
15	Signal Analyzer 20kHz-26.5GHz	KEYSIGHT	N9020A	MY49100060	Jun. 13, 2019	Jun. 12, 2020
16	Spectrum Analyzer 9kHz-40GHz	R&S	FSP40	100363	Jun. 13, 2019	Jun. 12, 2020
17	D.C. Power Supply	LongWei	TPR-6405D	\	\	\
18	Software	Frad	EZ-EMC	FA-03A2 RE	\	\



Conduction Test equipment

Item	Equipment	Manufacturer	Type No.	Serial No.	Last calibration	Calibrated until
1	Test Receiver	R&S	ESR3	102075	Jun. 13, 2019	Jun. 12, 2020
2	LISN	SCHWARZBEC K	NSLK8127	8127739	Jun. 13, 2019	Jun. 12, 2020
3	LISN	R&S	ENV216	101375	Jun. 13, 2019	Jun. 12, 2020
4	RF cables	Huber+Suhnar	9kHz-30MHz	B1702988-00 08	Jun. 25, 2019	Jun. 24, 2020
5	Software	Frad	EZ-EMC	EMC-CON 3A1	\	\

### 3. EMC EMISSION TEST

#### 3.1 CONDUCTED EMISSION MEASUREMENT

##### 3.1.1 POWER LINE CONDUCTED EMISSION Limits (Frequency Range 150KHz-30MHz)

FREQUENCY (MHz)	Limit (dBuV)		Standard
	Quasi-peak	Average	
0.15 -0.5	66 - 56 *	56 - 46 *	FCC
0.50 -5.0	56.00	46.00	FCC
5.0 -30.0	60.00	50.00	FCC

Note:

- (1) The tighter limit applies at the band edges.
- (2) The limit of " \* " marked band means the limitation decreases linearly with the logarithm of the frequency in the range.

The following table is the setting of the receiver

Receiver Parameters	Setting
Attenuation	10 dB
Start Frequency	0.15 MHz
Stop Frequency	30 MHz
IF Bandwidth	9 kHz

#### 3.1.2 TEST PROCEDURE

- a. The EUT was placed 0.8 meters from the horizontal ground plane with EUT being connected to the power mains through a line impedance stabilization network (LISN). All other support equipments powered from additional LISN(s). The LISN provide 50 Ohm/ 50uH of coupling impedance for the measuring instrument.
- b. Interconnecting cables that hang closer than 40 cm to the ground plane shall be folded back and forth in the center forming a bundle 30 to 40 cm long.
- c. I/O cables that are not connected to a peripheral shall be bundled in the center. The end of the cable may be terminated, if required, using the correct terminating impedance. The overall length shall not exceed 1 m.
- d. LISN at least 80 cm from nearest part of EUT chassis.
- e. For the actual test configuration, please refer to the related Item –EUT Test Photos.

#### 3.1.3 DEVIATION FROM TEST STANDARD

No deviation

### 3.1.4 TEST SETUP

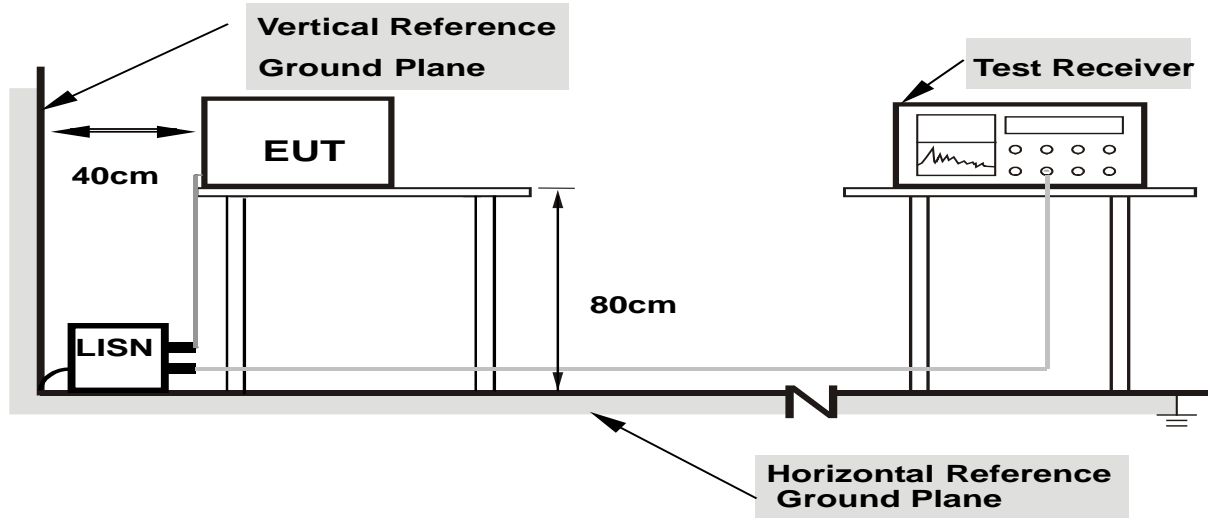

- Note:**
- 1.Support units were connected to second LISN.
  - 2.Both of LISNs (AMN) are 80 cm from EUT and at least 80 from other units and other metal planes

### 3.1.5 EUT OPERATING CONDITIONS

The EUT was configured for testing in a typical fashion (as a customer would normally use it). The EUT has been programmed to continuously transmit during test. This operating condition was tested and used to collect the included data.

### 3.1.6 TEST RESULTS

NOTE: This EUT is powered by the battery only, this test item is not applicable.

### 3.2 RADIATED EMISSION MEASUREMENT

#### 3.2.1 RADIATED EMISSION LIMITS (Frequency Range 9kHz-1000MHz)

20dBc in any 100 kHz bandwidth outside the operating frequency band. In case the emission fall within the restricted band specified on 15.205(a), then the 15.209(a) limit in the table below has to be followed.

Frequencies (MHz)	Field Strength (micorvolts/meter)	Measurement Distance (meters)
0.009~0.490	2400/F(KHz)	300
0.490~1.705	24000/F(KHz)	30
1.705~30.0	30	30
30~88	100	3
88~216	150	3
216~960	200	3
Above 960	500	3

#### LIMITS OF RADIATED EMISSION MEASUREMENT (Above 1000MHz)

FREQUENCY (MHz)	Limit (dBuV/m) (at 3M)	
	PEAK	AVERAGE
Above 1000	74	54

Notes:

- (1) The limit for radiated test was performed according to FCC PART 15C.
- (2) The tighter limit applies at the band edges.
- (3) Emission level (dBuV/m)=20log Emission level (uV/m).

#### FREQUENCY RANGE OF RADIATED MEASUREMENT (For unintentional radiators)

Highest frequency generated or Upper frequency of measurement used in the device or on which the device operates or tunes (MHz)	Range (MHz)
Below 1.705	30
1.705 – 108	1000
108 – 500	2000
500 – 1000	5000
Above 1000	5 <sup>th</sup> harmonic of the highest frequency or 40 GHz, whichever is lower

Spectrum Parameter	Setting
Attenuation	Auto
Start Frequency	1000 MHz
Stop Frequency	10th carrier harmonic
RB / VB (emission in restricted band)	1 MHz / 1 MHz for Peak, 1 MHz / 10Hz for Average

Receiver Parameter	Setting
Attenuation	Auto
Start ~ Stop Frequency	9kHz~150kHz / RB 200Hz for QP
Start ~ Stop Frequency	150kHz~30MHz / RB 9kHz for QP
Start ~ Stop Frequency	30MHz~1000MHz / RB 120kHz for QP

### 3.2.2 TEST PROCEDURE

- a. The measuring distance of at 3 m shall be used for measurements at frequency up to 25GHz. For frequencies above 1GHz, any suitable measuring distance may be used.
- b. The EUT was placed on the top of a rotating table 0.8 meters above the ground at a 3 meter semi-chamber test. The table was rotated 360 degrees to determine the position of the highest radiation.
- c. The height of the equipment or of the substitution antenna shall be 0.8m; above 1GHz, the height was 1.5m, the height of the test antenna shall vary between 1 m to 4 m. Both horizontal and vertical polarizations of the antenna are set to make the measurement.
- d. The initial step in collecting conducted emission data is a spectrum analyzer peak detector mode pre-scanning the measurement frequency range. Significant peaks are then marked and then Quasi Peak detector mode re-measured.
- e. If the Peak Mode measured value compliance with and lower than Quasi Peak Mode Limit, the EUT shall be deemed to meet QP Limits and then no additional QP Mode measurement performed.
- f. For the actual test configuration, please refer to the related Item –EUT Test Photos.
- g. For the radiated emission test above 1GHz:  
Place the measurement antenna away from each area of the EUT determined to be a source of emissions at the specified measurement distance, while keeping the measurement antenna aimed at the source of emissions at each frequency of significant emissions, with polarization oriented for maximum response.

The measurement antenna may have to be higher or lower than the EUT, depending on the radiation pattern of the emission and staying aimed at the emission source for receiving the maximum signal. The final measurement antenna elevation shall be that which maximizes the emissions. The measurement antenna elevation for maximum emissions shall be restricted to a range of heights of from 1 m to 4 m above the ground or reference ground plane.

Note:

Both horizontal and vertical antenna polarities were tested and performed pretest to three orthogonal axis. The worst case emissions were reported

### 3.2.3 DEVIATION FROM TEST STANDARD

No deviation

### 3.2.4 TEST SETUP

#### (A) Radiated Emission Test-Up Frequency Below 30MHz

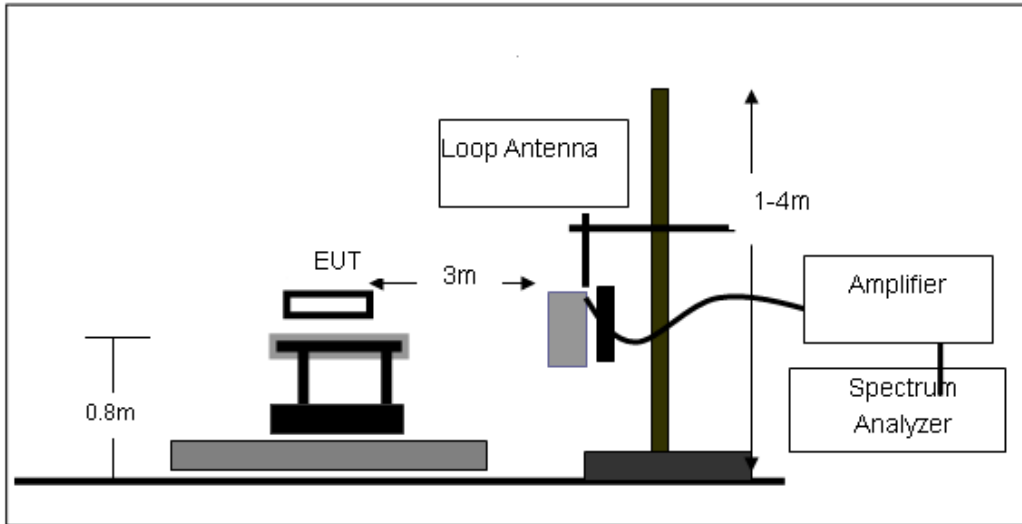

#### (B) Radiated Emission Test-Up Frequency 30MHz~1GHz

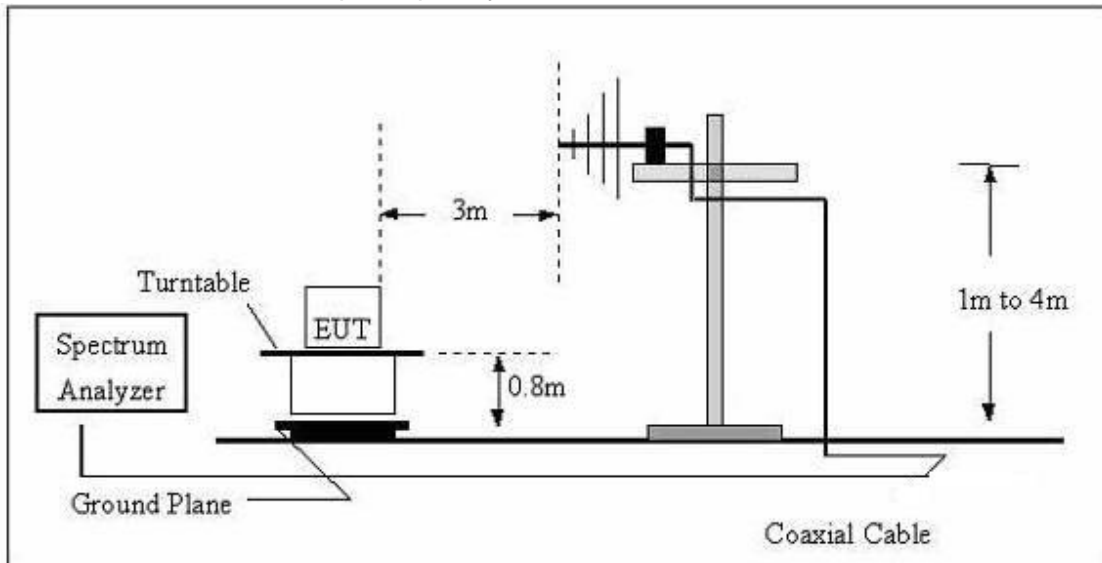



(C) Radiated Emission Test-Up Frequency Above 1GHz

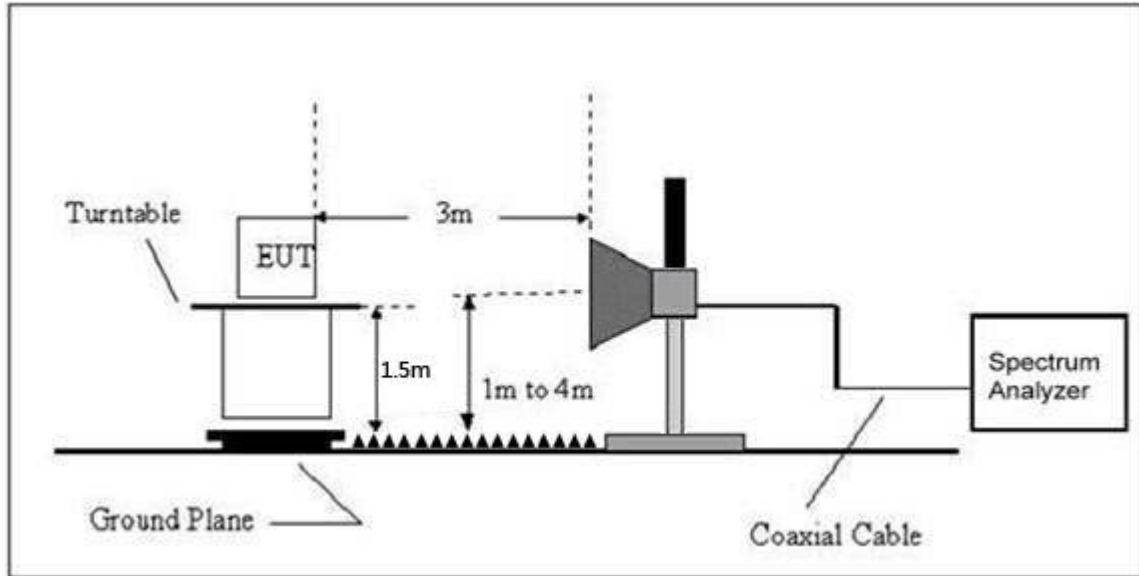

### 3.2.5 EUT OPERATING CONDITIONS

The EUT tested system was configured as the statements of 2.4 Unless otherwise a special operating condition is specified in the follows during the testing.

**3.2.6 TEST RESULTS (BETWEEN 9KHZ – 30 MHZ)**

Temperature:	23℃	Relative Humidity:	54%
Pressure:	101 kPa	Test Voltage :	DC 3.0V
Test Mode :	Mode 4	Polarization :	--

Freq.	Reading	Limit	Margin	State
(MHz)	(dBuV/m)	(dBuV/m)	(dB)	P/F
--	--	--	--	PASS
--	--	--	--	PASS

**NOTE:**

The amplitude of spurious emissions which are attenuated by more than 20dB below the permissible value has no need to be reported.

Distance extrapolation factor =  $40 \log(\text{specific distance}/\text{test distance})$ (dB);

Limit line = specific limits(dBuv) + distance extrapolation factor.



3.2.7 TEST RESULTS (BETWEEN 30MHZ – 1GHZ)

Temperature :	23℃	Relative Humidity :	54%
Pressure :	101 kPa	Polarization :	Horizontal
Test Voltage :	DC 3.0V		
Test Mode :	Mode 4		

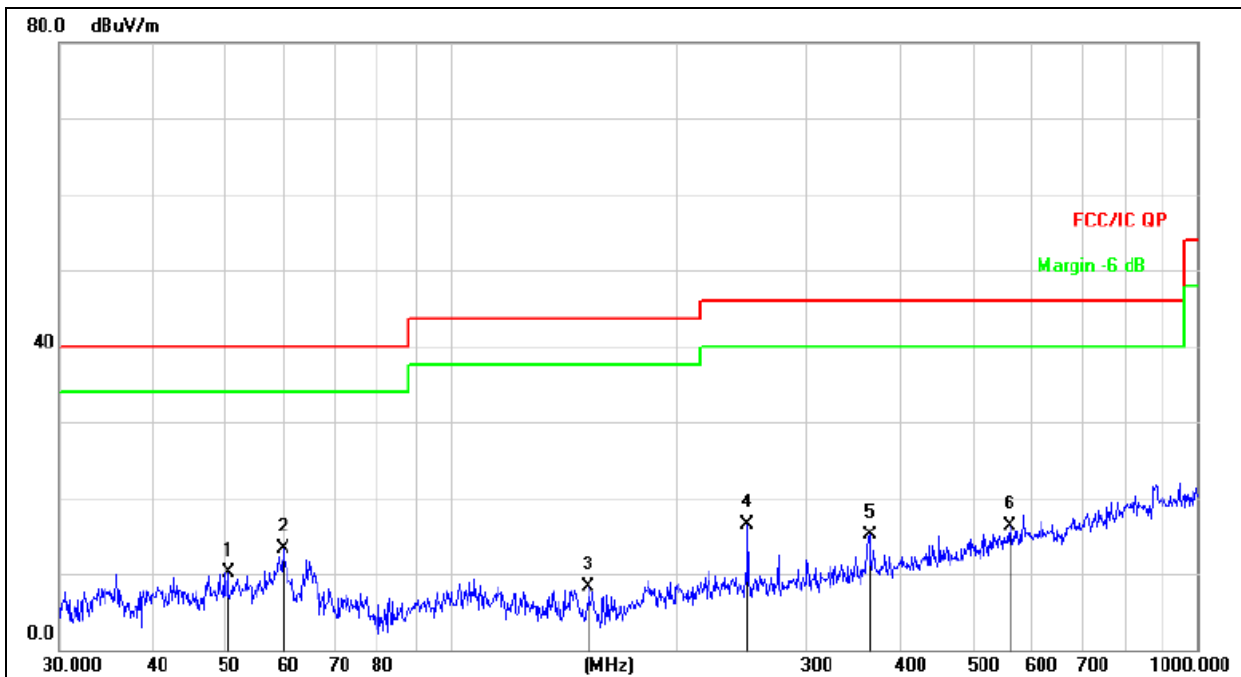

Remark:  
Factor = Antenna Factor + Cable Loss – Pre-amplifier.

No.	Mk.	Freq. MHz	Reading Level dBuV	Correct Factor dB	Measure- ment dBuV/m	Limit dB/m	Over dB	Detector
1		50.4089	25.03	-14.89	10.14	40.00	-29.86	QP
2	*	59.6493	29.25	-15.87	13.38	40.00	-26.62	QP
3		153.2004	27.53	-19.30	8.23	43.50	-35.27	QP
4		250.3012	31.72	-15.14	16.58	46.00	-29.42	QP
5		364.2595	27.04	-11.90	15.14	46.00	-30.86	QP
6		560.6928	23.76	-7.43	16.33	46.00	-29.67	QP



Temperature :	23℃	Relative Humidity :	54%
Pressure :	101kPa	Polarization :	Vertical
Test Voltage :	DC 3.0V		
Test Mode :	Mode 4		

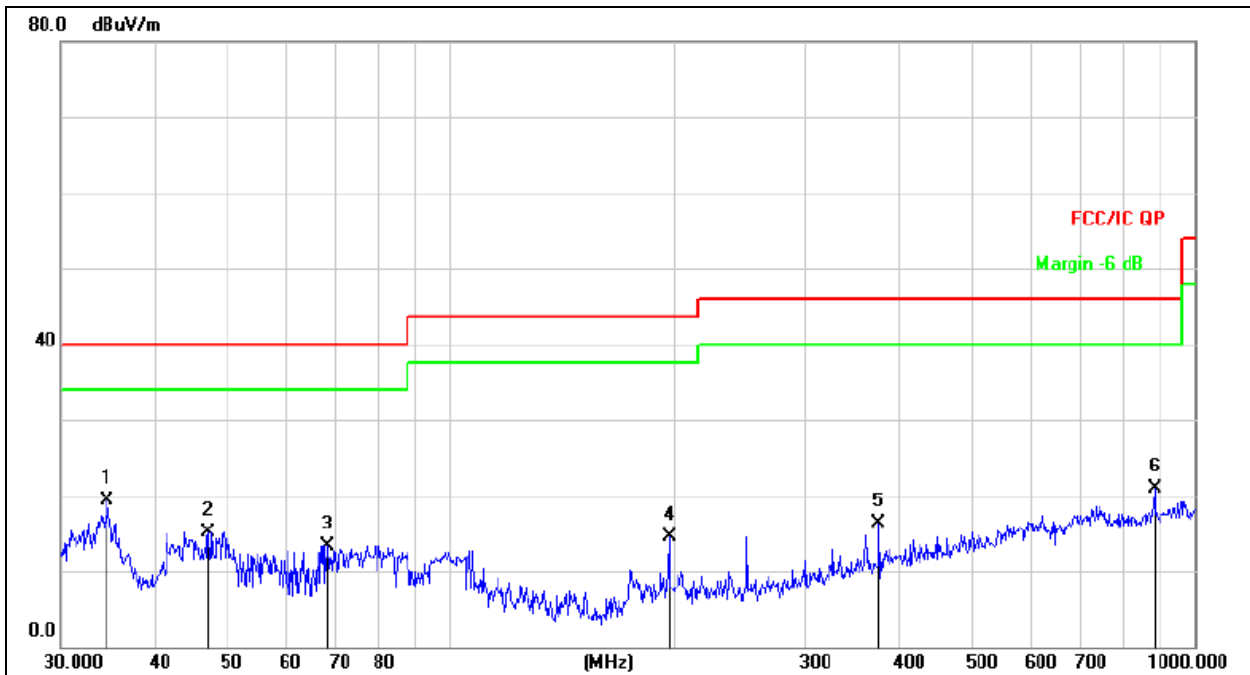

Remark:  
Factor = Antenna Factor + Cable Loss – Pre-amplifier.

No.	Mk.	Freq. MHz	Reading Level dBuV	Correct Factor dB	Measure- ment dBuV/m	Limit dB/m	Over dB	Detector
1	*	34.6385	35.74	-16.41	19.33	40.00	-20.67	QP
2		47.3255	30.12	-15.00	15.12	40.00	-24.88	QP
3		68.3908	31.15	-17.82	13.33	40.00	-26.67	QP
4		196.5098	31.10	-16.52	14.58	43.50	-28.92	QP
5		375.9385	27.86	-11.64	16.22	46.00	-29.78	QP
6		881.4067	22.75	-1.88	20.87	46.00	-25.13	QP

Remark:  
Test all the modes and only worst case was reported.

## 3.2.8 TEST RESULTS (1ghz~25ghz)

**GFSK**

Polar (H/V)	Frequency	Meter Reading	Pre-amplifier	Cable Loss	Antenna Factor	Emission Level	Limits	Margin	Detector Type
	(MHz)	(dBuV)	(dB)	(dB)	(dB)	(dBuV/m)	(dBuV/m)	(dB)	
<b>Low Channel:2401MHz</b>									
V	4802.00	53.40	39.55	7.77	25.66	47.28	74.00	-26.72	PK
V	4802.00	43.83	39.55	7.77	25.66	37.71	54.00	-16.29	AV
V	7203.00	50.24	38.33	7.3	24.55	43.76	74.00	-30.24	PK
V	7203.00	43.32	38.33	7.3	24.55	36.84	54.00	-17.16	AV
V	15450.00	53.61	35.23	6.6	26.59	51.57	74.00	-22.43	PK
H	4802.00	52.21	39.55	7.77	25.66	46.09	74.00	-27.91	PK
H	4802.00	43.03	39.55	7.77	25.66	36.91	54.00	-17.09	AV
H	7203.00	52.70	38.33	7.3	23.55	45.22	74.00	-28.78	PK
H	7203.00	43.20	38.33	7.3	23.22	35.39	54.00	-18.61	AV
H	15450.00	50.79	35.45	6.6	27.88	49.82	74.00	-24.18	PK

Polar (H/V)	Frequency	Meter Reading	Pre-amplifier	Cable Loss	Antenna Factor	Emission Level	Limits	Margin	Detector Type
	(MHz)	(dBuV)	(dB)	(dB)	(dB)	(dBuV/m)	(dBuV/m)	(dB)	
<b>Middle Channel:2441MHz</b>									
V	4882.00	51.99	38.89	7.57	25.45	46.12	74.00	-27.88	PK
V	4882.00	43.87	38.89	7.57	25.45	38.00	54.00	-16.00	AV
V	7323.00	50.26	38.78	7.35	24.78	43.61	74.00	-30.39	PK
V	7323.00	43.05	38.78	7.35	24.78	36.40	54.00	-17.60	AV
V	15450.00	52.66	35.89	6.42	26.47	49.66	74.00	-24.34	PK
H	4882.00	53.48	38.89	7.57	25.45	47.61	74.00	-26.39	PK
H	4882.00	43.27	38.89	7.57	25.45	37.40	54.00	-16.60	AV
H	7323.00	53.34	38.78	7.35	24.78	46.69	74.00	-27.31	PK
H	7323.00	43.14	38.78	7.35	24.78	36.49	54.00	-17.51	AV
H	15450.00	50.96	36.68	6.42	26.65	47.35	74.00	-26.65	PK

Polar (H/V)	Frequency	Meter Reading	Pre-amplifier	Cable Loss	Antenna Factor	Emission Level	Limits	Margin	Detector Type
	(MHz)	(dBuV)	(dB)	(dB)	(dB)	(dBuV/m)	(dBuV/m)	(dB)	
<b>High Channel: 2481MHz</b>									
V	4962.00	54.69	38.75	7.38	25.45	48.77	74.00	-25.23	PK
V	4962.00	43.63	38.75	7.38	25.45	37.71	54.00	-16.29	AV
V	7443.00	54.76	38.65	7.15	24.78	48.04	74.00	-25.96	PK
V	7443.00	43.93	38.65	7.15	24.78	37.21	54.00	-16.79	AV
V	15450.00	50.34	35.58	6.25	26.47	47.48	74.00	-26.52	PK
H	4962.00	51.55	38.75	7.38	25.45	45.63	74.00	-28.37	PK
H	4962.00	43.24	38.75	7.38	25.45	37.32	54.00	-16.68	AV
H	7443.00	52.14	38.65	7.15	24.78	45.42	74.00	-28.58	PK
H	7443.00	43.74	38.65	7.15	24.78	37.02	54.00	-16.98	AV
H	15450.00	54.41	36.42	6.25	26.65	50.89	74.00	-23.11	PK

Remark:

1. Emission Level = Meter Reading + Antenna Factor + Cable Loss – Pre-amplifier,  
Margin= Emission Level - Limit
- 2.If peak below the average limit, the average emission was no test.
3. In restricted bands of operation, The spurious emissions below the permissible value more than 20dB
4. The amplitude of spurious emissions which are attenuated by more than 20dB below the permissible value has no need to be reported.

### 3.3 RADIATED BAND EMISSION MEASUREMENT AND RESTRICTED BANDS OF OPERATION

#### 3.3.1 TEST REQUIREMENT:

FCC Part15 C Section 15.209 and 15.205

(a) Except as shown in paragraph (d) of this section, only spurious emissions are permitted in any of the frequency bands listed below:

MHz	MHz	MHz	GHz
0.090-0.110	16.42-16.423	399.9-410	4.5-5.15
0.495-0.505	16.69475-16.69525	608-614	5.35-5.46
2.1735-2.1905	16.80425-16.80475	960-1240	7.25-7.75
4.125-4.128	25.5-25.67	1300-1427	8.025-8.5
4.17725-4.17775	37.5-38.25	1435-1626.5	9.0-9.2
4.20725-4.20775	73-74.6	1645.5-1646.5	9.3-9.5
6.215-6.218	74.8-75.2	1660-1710	10.6-12.7
6.26775-6.26825	108-121.94	1718.8-1722.2	13.25-13.4
6.31175-6.31225	123-138	2200-2300	14.47-14.5
8.291-8.294	149.9-150.05	2310-2390	15.35-16.2
8.362-8.366	156.52475-156.52525	2483.5-2500	17.7-21.4
8.37625-8.38675	156.7-156.9	2690-2900	22.01-23.12
8.41425-8.41475	162.0125-167.17	3260-3267	23.6-24.0
12.29-12.293	167.72-173.2	3332-3339	31.2-31.8
12.51975-12.52025	240-285	3345.8-3358	36.43-36.5
12.57675-12.57725	322-335.4	3600-4400	( <sup>2</sup> )
13.36-13.41			

#### LIMITS OF RADIATED EMISSION MEASUREMENT (Above 1000MHz)

FREQUENCY (MHz)	Limit (dBuV/m) (at 3M)	
	PEAK	AVERAGE
Above 1000	74	54

Notes:

- (1) The limit for radiated test was performed according to FCC PART 15C.
- (2) The tighter limit applies at the band edges.
- (3) Emission level (dBuV/m)=20log Emission level (uV/m).

Spectrum Parameter	Setting
Attenuation	Auto
Start Frequency	2300MHz
Stop Frequency	2520
RB / VB (emission in restricted band)	1 MHz / 1 MHz for Peak, 1 MHz / 10Hz for Average

#### 3.3.2 TEST PROCEDURE

Above 1GHz test procedure as below:

- a. 1. The EUT was placed on the top of a rotating table 1.5 meters above the ground at a 3 meter camber. The table was rotated 360 degrees to determine the position of the highest radiation.
- b. The EUT was set 3 meters away from the interference-receiving antenna, which was mounted on the top of a variable-height antenna tower.
- c. The antenna height is varied from one meter to four meters above the ground to determine the maximum value of the field strength. Both horizontal and vertical polarizations of the antenna are set to make the measurement.

- d. For each suspected emission, the EUT was arranged to its worst case and then the antenna was tuned to heights from 1 meter to 4 meters and the rota table was turned from 0 degrees to 360 degrees to find the maximum reading.
- e. The test-receiver system was set to Peak Detect Function and Specified Bandwidth with Maximum Hold Mode.
- f. If the emission level of the EUT in peak mode was 10dB lower than the limit specified, then testing could be stopped and the peak values of the EUT would be reported. Otherwise the emissions that did not have 10dB margin would be re-tested one by one using peak, quasi-peak or average method as specified and then reported in a data sheet.
- g. Test the EUT in the lowest channel, the Highest channel

Note:

Both horizontal and vertical antenna polarities were tested and performed pretest to three orthogonal axis. The worst case emissions were reported

### 3.3.3 DEVIATION FROM TEST STANDARD

No deviation

### 3.3.4 TEST SETUP

Radiated Emission Test-Up Frequency Above 1GHz

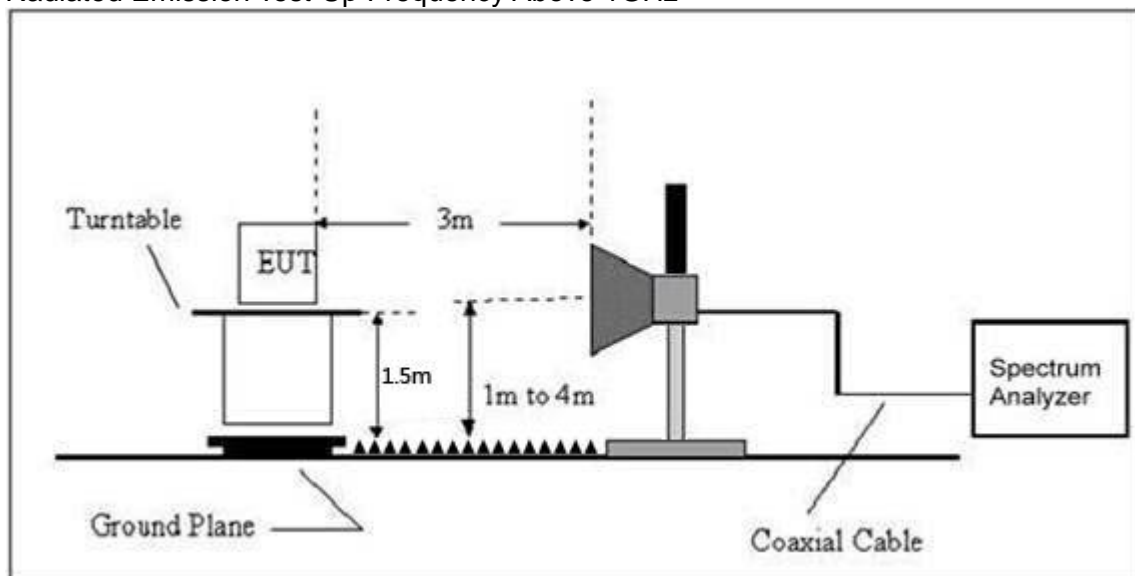

### 3.3.5 EUT OPERATING CONDITIONS

The EUT tested system was configured as the statements of 2.3 Unless otherwise a special operating condition is specified in the follows during the testing.



3.3.6 TEST RESULT

	Polar (H/V)	Frequency (MHz)	Meter Reading (dBuV)	Pre-amplifier (dB)	Cable Loss (dB)	Antenna Factor (dB/m)	Emission level (dBuV/m)	Limits (dBuV/m)		Result	
							PK	□PK	AV		
<b>Low Channel 2401MHz</b>											
<b>GFSK</b>	H	2390.00	61.01	38.06	7.42	20.15	50.52	74.00	54.00	PASS	
	H	2400.00	55.17	38.06	7.42	20.15	44.68	74.00	54.00	PASS	
	V	2390.00	62.64	38.06	7.42	20.15	52.15	74.00	54.00	PASS	
	V	2400.00	55.11	38.06	7.42	20.15	44.62	74.00	54.00	PASS	
	<b>High Channel 2481MHz</b>										
	H	2483.50	59.81	38.17	7.45	20.54	49.63	74.00	54.00	PASS	
	H	2485.50	52.87	38.17	7.45	20.54	42.69	74.00	54.00	PASS	
	V	2483.50	61.36	38.2	7.45	20.54	51.15	74.00	54.00	PASS	
V	2485.50	53.20	38.2	7.45	20.54	42.99	74.00	54.00	PASS		

**Remark:**

1. Emission Level = Meter Reading + Antenna Factor + Cable Loss – Pre-amplifier, Margin= Emission Level - Limit
2. If the PK measured levels comply with average limit, then the average level were deemed to comply with average limit.
- 3 In restricted bands of operation, The spurious emissions below the permissible value more than 20dB
4. The amplitude of spurious emissions which are attenuated by more than 20dB below the permissible value has no need to be reported.



## 4. POWER SPECTRAL DENSITY TEST

### 4.1 APPLIED PROCEDURES / LIMIT

FCC Part15 (15.247) , Subpart C				
Section	Test Item	Limit	Frequency Range (MHz)	Result
15.247	Power Spectral Density	8 dBm (in any 3KHz)	2400-2483.5	PASS

#### 4.1.1 TEST PROCEDURE

1. Set analyzer center frequency to DTS channel center frequency.
2. Set the span to 1.5 times the DTS bandwidth.
3. Set the RBW to:  $3 \text{ kHz} \leq \text{RBW} \leq 100 \text{ kHz}$ .
4. Set the VBW  $\geq 3 \times \text{RBW}$ .
5. Detector = peak.
6. Sweep time = auto couple.
7. Trace mode = max hold.
8. Allow trace to fully stabilize.
9. Use the peak marker function to determine the maximum amplitude level within the RBW.
10. If measured value exceeds limit, reduce RBW (no less than 3 kHz) and repeat.

#### 4.1.2 DEVIATION FROM STANDARD

No deviation.

#### 4.1.3 TEST SETUP

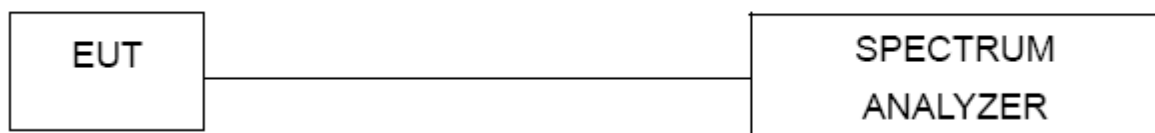

#### 4.1.4 EUT OPERATION CONDITIONS

The EUT tested system was configured as the statements of 2.1 Unless otherwise a special operating condition is specified in the follows during the testing.

Note: Power Spectral Density(dBm)=Reading+Cable Loss

### 4.1.5 TEST RESULTS

Temperature :	26°C	Relative Humidity :	54%
Test Mode :	GFSK	Test Voltage :	DC 3.0V

Frequency	Power Spectral Density (dBm/3KHz)	Limit (dBm/3KHz)	Result
2401 MHz	-11.073	8	PASS
2441 MHz	-11.188	8	PASS
2481 MHz	-11.101	8	PASS

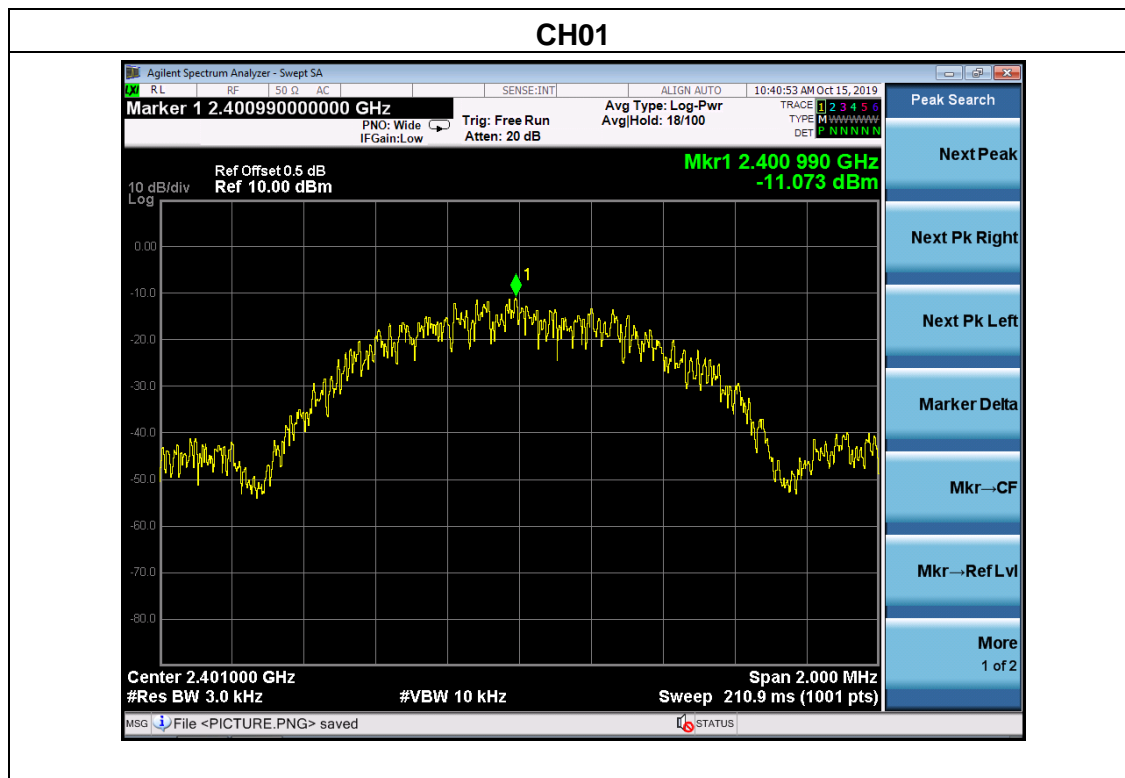



### CH41

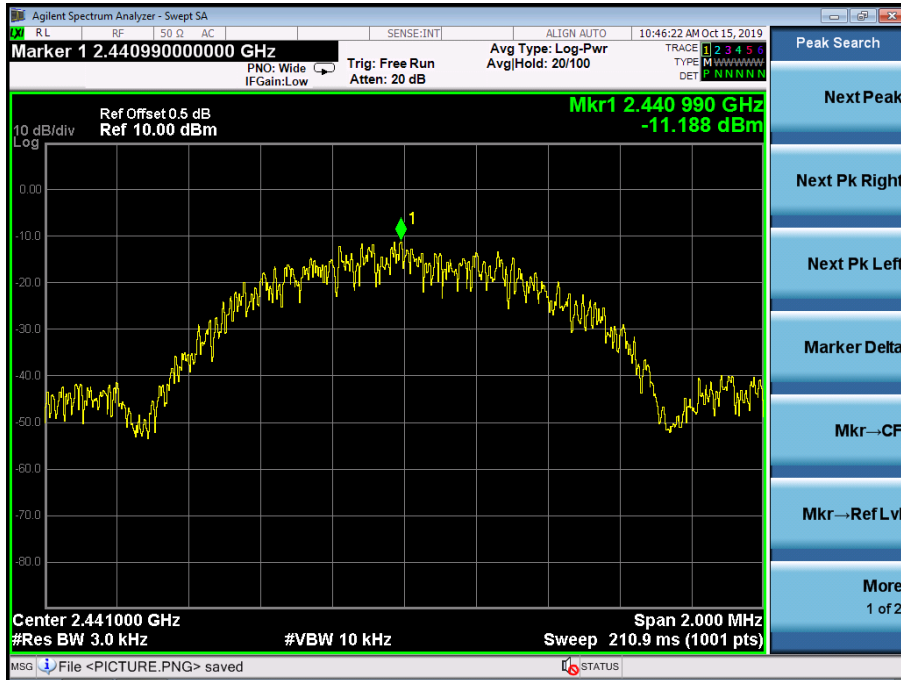

### CH81

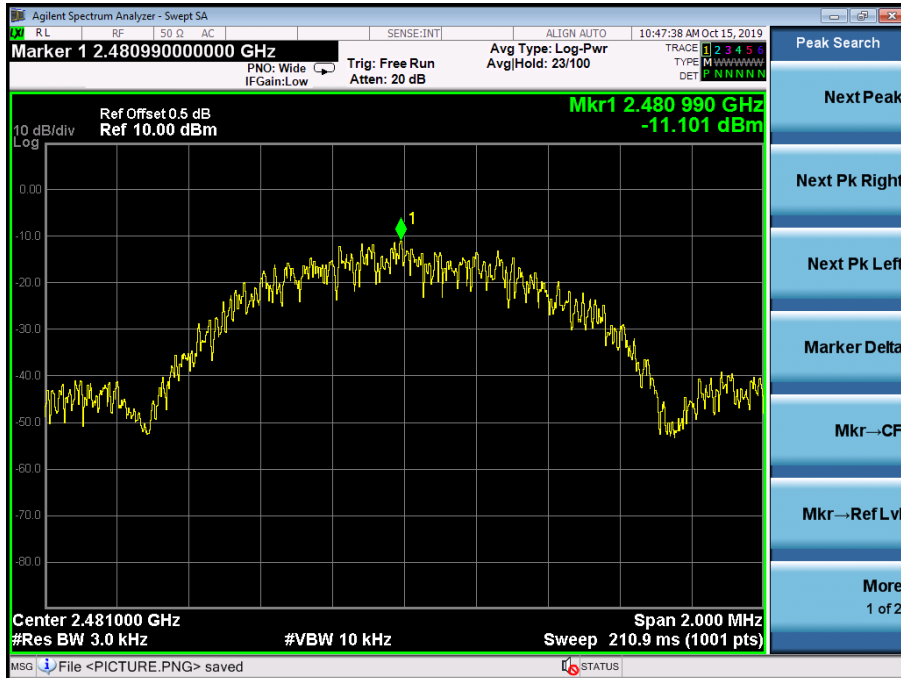

## 5. BANDWIDTH TEST

### 5.1 APPLIED PROCEDURES / LIMIT

FCC Part15 (15.247) , Subpart C				
Section	Test Item	Limit	Frequency Range (MHz)	Result
15.247(a)(2)	Bandwidth	$\geq 500\text{KHz}$ (6dB bandwidth)	2400-2483.5	PASS

#### 5.1.1 TEST PROCEDURE

1. Set RBW = 100 kHz.
2. Set the video bandwidth (VBW)  $\geq 3 \times$  RBW.
3. Detector = Peak.
4. Trace mode = max hold.
5. Sweep = auto couple.
6. Allow the trace to stabilize.
7. Measure the maximum width of the emission that is constrained by the frequencies associated with the two outermost amplitude points (upper and lower frequencies) that are attenuated by 6 dB relative to the maximum level measured in the fundamental emission.

#### 5.1.2 DEVIATION FROM STANDARD

No deviation.

#### 5.1.3 TEST SETUP

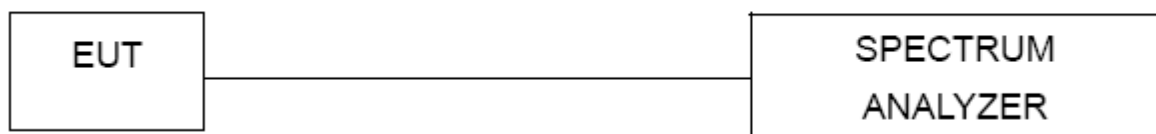

#### 5.1.4 EUT OPERATION CONDITIONS

The EUT tested system was configured as the statements of 2.4 Unless otherwise a special operating condition is specified in the follows during the testing.

**5.1.5 TEST RESULTS**

Temperature :	26°C	Relative Humidity :	54%
Test Mode :	GFSK	Test Voltage :	DC 3.0V

Frequency (MHz)	6dB bandwidth (MHz)	Limit (kHz)	Result
2401	0.690	500	Pass
2441	0.692	500	Pass
2481	0.707	500	Pass

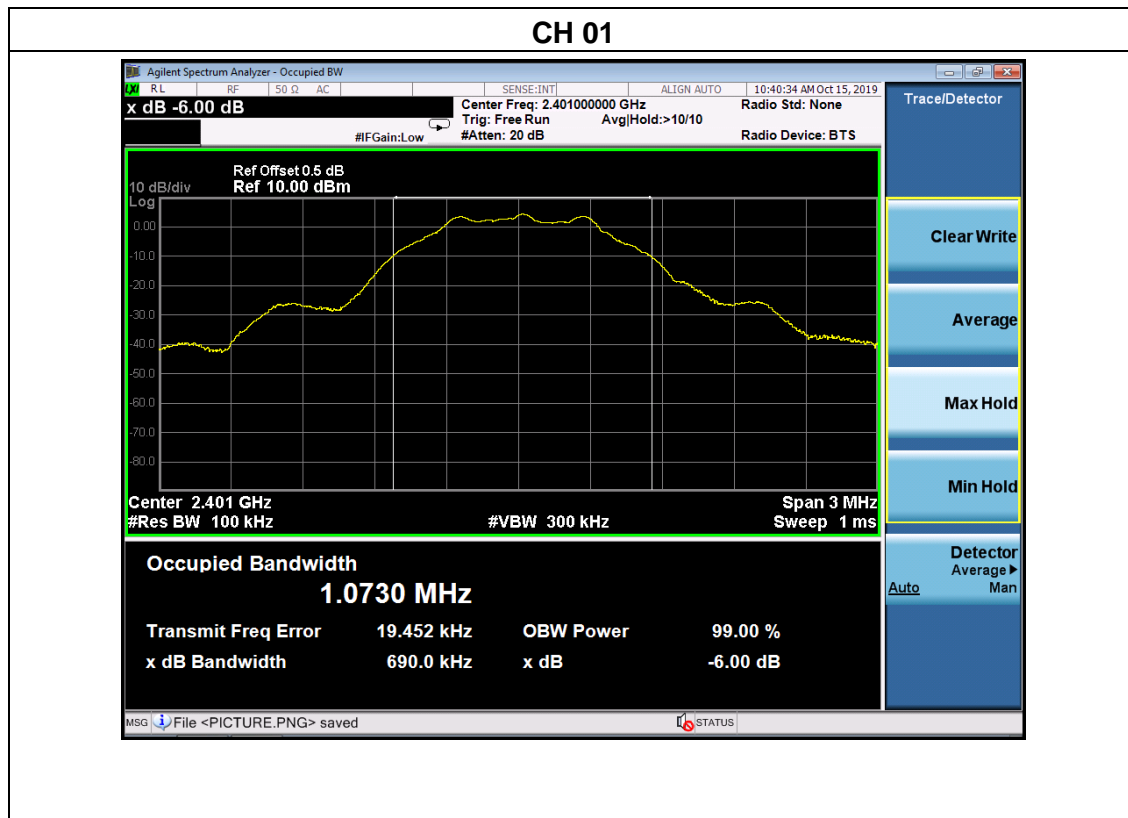

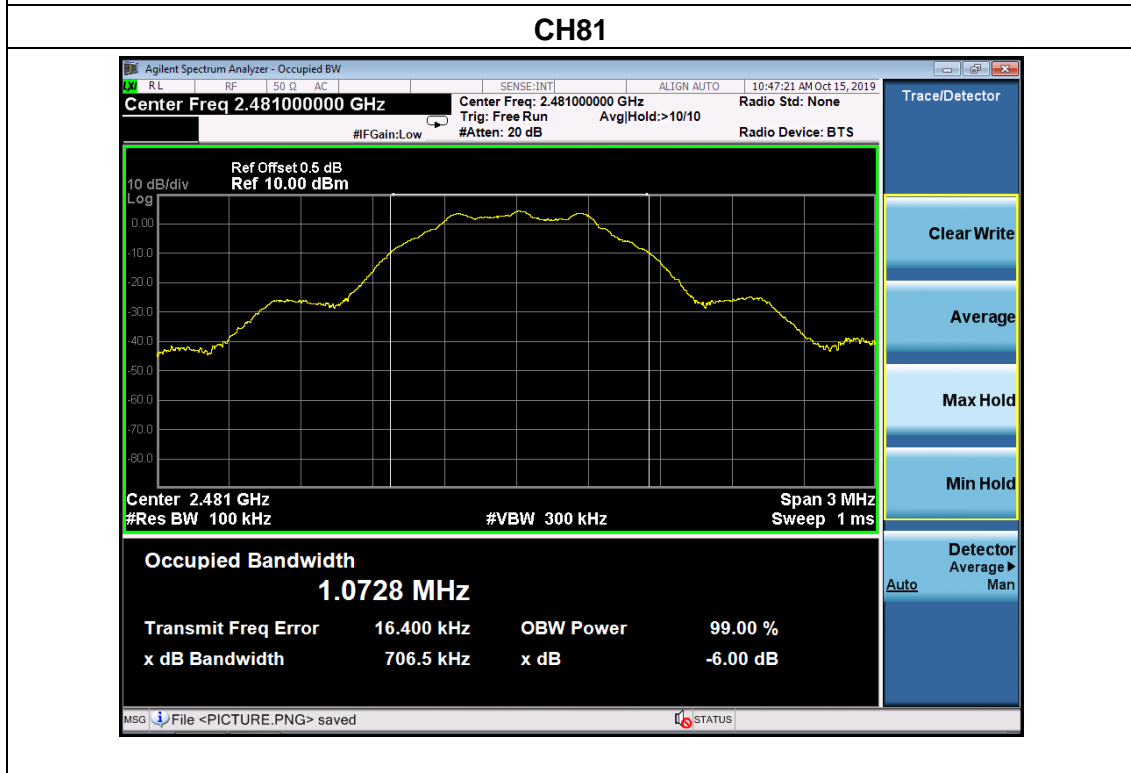
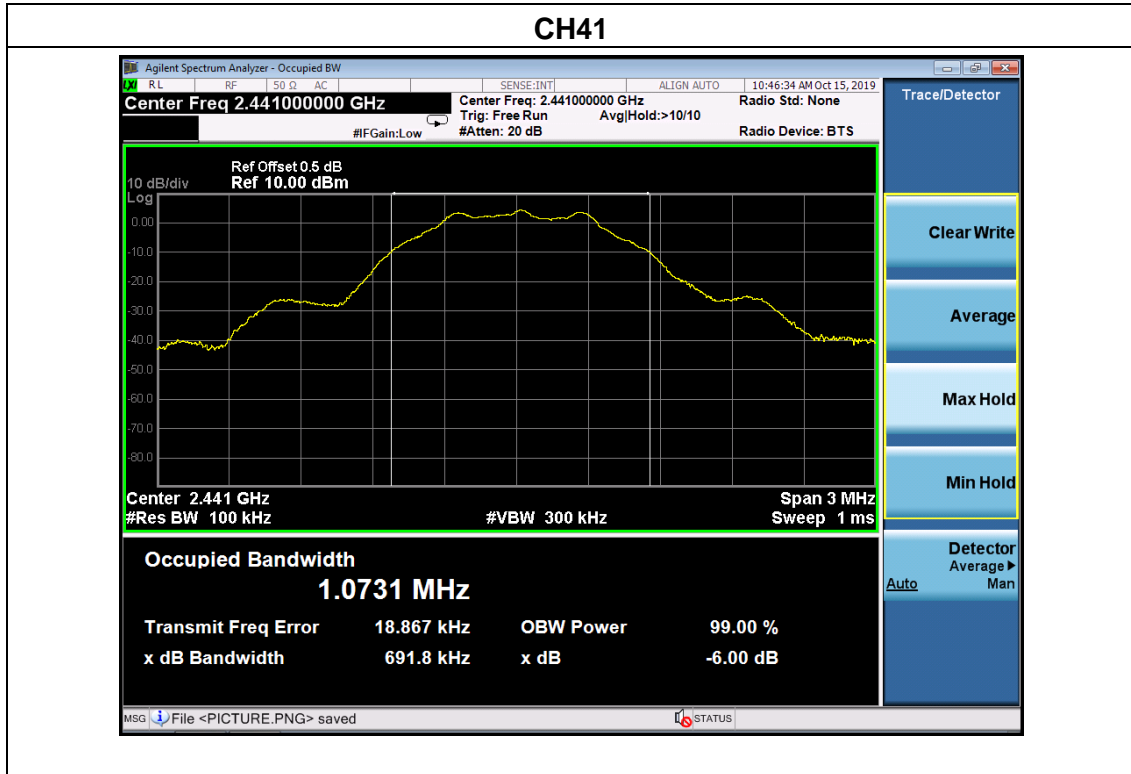

## 6. PEAK OUTPUT POWER TEST

### 6.1 APPLIED PROCEDURES / LIMIT

FCC Part15 (15.247) , Subpart C				
Section	Test Item	Limit	Frequency Range (MHz)	Result
15.247(b)(3)	Peak Output Power	1 watt or 30dBm	2400-2483.5	PASS

#### 6.1.1 TEST PROCEDURE

- a. The EUT was directly connected to the Power meter

#### 6.1.2 DEVIATION FROM STANDARD

No deviation.

#### 6.1.3 TEST SETUP



#### 6.1.4 EUT OPERATION CONDITIONS

The EUT tested system was configured as the statements of 2.4 Unless otherwise a special operating condition is specified in the follows during the testing.



### 6.1.5 TEST RESULTS

Temperature :	26℃	Relative Humidity :	54%
Test Voltage :	DC 3.0V		

	Frequency	Maximum Conducted Output Power(PK)	Conducted Output Power Limit
	(MHz)	(dBm)	dBm
GFSK	2401	4.32	30
	2441	4.30	30
	2481	4.37	30



## 7. 100 KHZ BANDWIDTH OF FREQUENCY BAND EDGE

### 7.1 APPLICABLE STANDARD

In any 100 kHz bandwidth outside the frequency band in which the spread spectrum intentional radiator is operating, the radio frequency power that is produced by the intentional radiator shall be at least 20 dB below that in the 100 kHz bandwidth within the band that contains the highest level of the desired power, based on either an RF conducted or a radiated measurement.

### 7.2 TEST PROCEDURE

Using the following spectrum analyzer setting:

- Set instrument center frequency to DTS channel center frequency.
- Set the span to  $\geq 1.5$  times the DTS bandwidth.
- Set the RBW = 100 kHz.
- Set the VBW  $\geq [3 \times \text{RBW}]$ .
- Detector = peak.
- Sweep time = auto couple.
- Trace mode = max hold.
- Allow trace to fully stabilize.
- Use the peak marker function to determine the maximum PSD level.

### 7.3 DEVIATION FROM STANDARD

No deviation.

### 7.4 TEST SETUP



### 7.5 EUT OPERATION CONDITIONS

The EUT tested system was configured as the statements of 2.4 Unless otherwise a special operating condition is specified in the follows during the testing.

### 7.6 TEST RESULTS



GFSK: Band Edge, Left Side

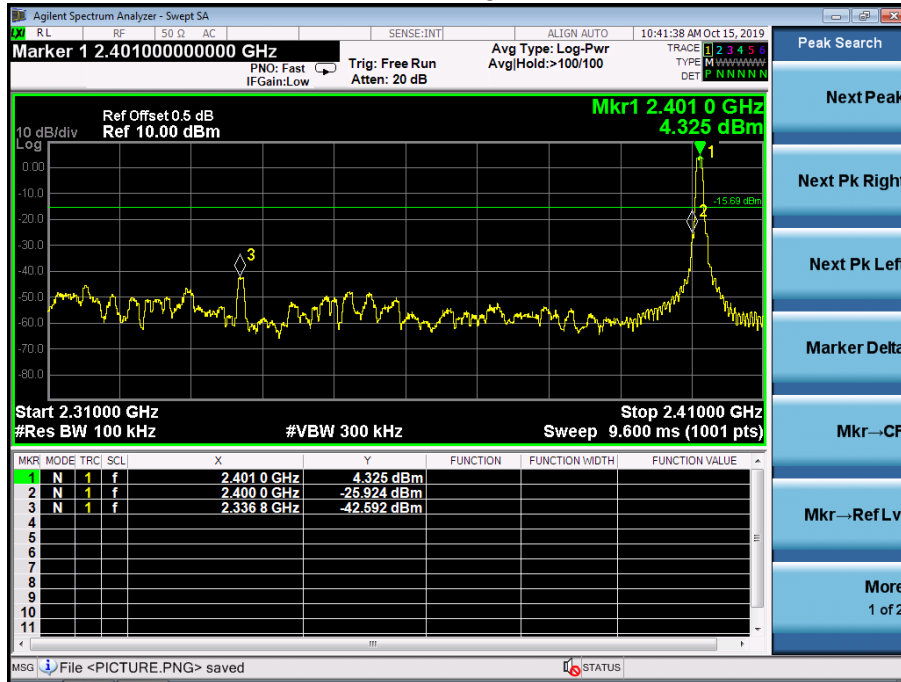

GFSK: Band Edge, Right Side

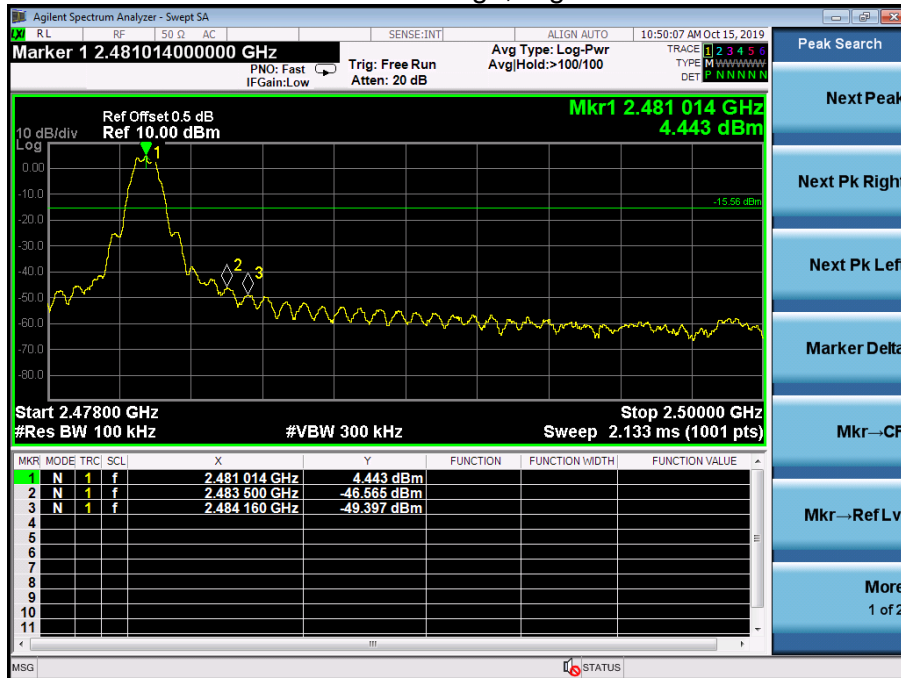



### CONDUCTED EMISSION MEASUREMENT

GFSK

#### Low Channel 2401MHz

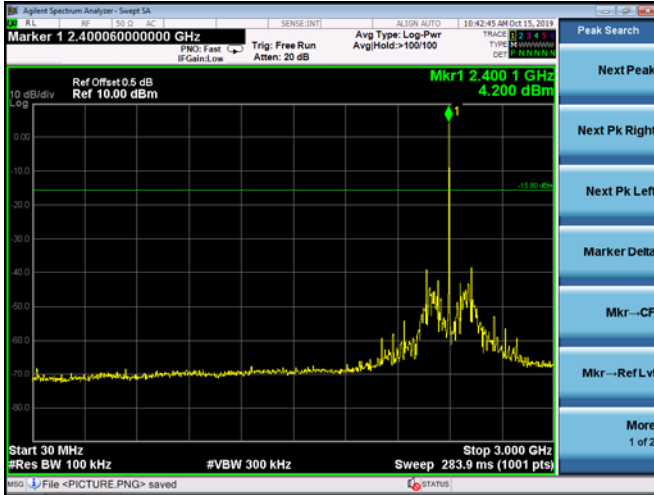

#### Middle Channel 2441MHz



#### High Channel 2481MHz

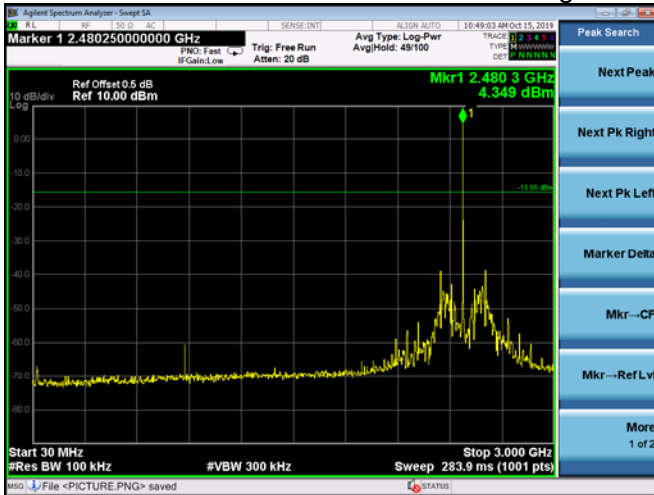

## 8. ANTENNA REQUIREMENT

### 8.1 STANDARD REQUIREMENT

15.203 requirement: For intentional device, according to 15.203: an intentional radiator shall be designed to ensure that no antenna other than that furnished by the responsible party shall be used with the device.

### 8.2 EUT ANTENNA

The EUT antenna is PCB antenna, fulfill the requirement of this section.

## 9. EUT TEST PHOTO

### Radiated Measurement Photos

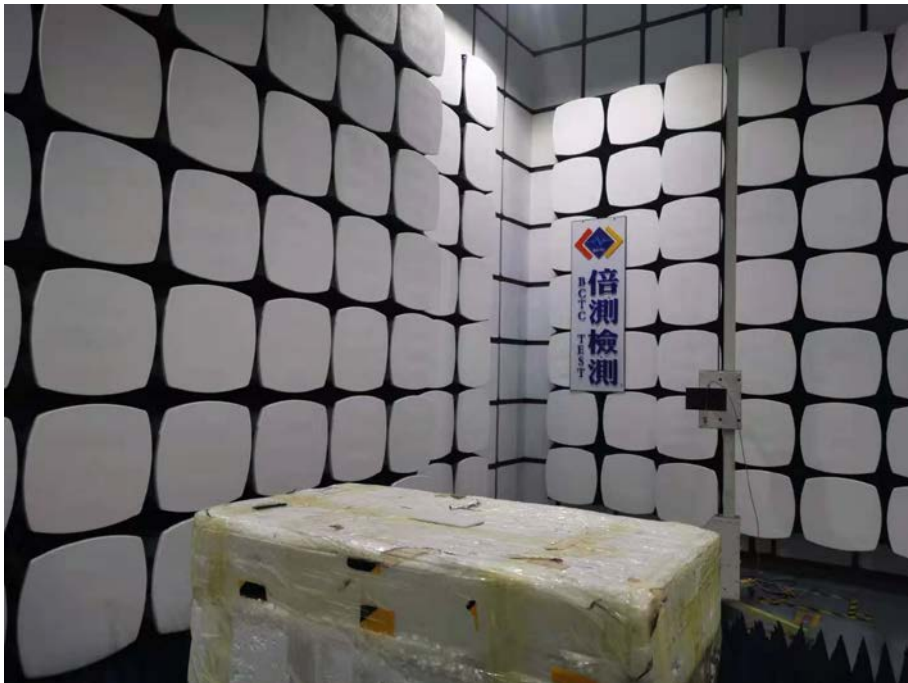



### 10. EUT PHOTO



\*\*\*\*\* END OF REPORT

\*\*\*\*\*