

RADIO TEST REPORT

Report No: STS1703216F04

Issued for

MOBIWIRE MOBILES (NINGBO) CO.,LTD

No.999, Dacheng East Road, Fenghua City, Zhejiang, China

| | |
|-----------------------|-----------------|
| Product Name: | 3G Featurephone |
| Brand Name: | Mobiwire |
| Model Name: | XB52U |
| Series Model: | N/A |
| FCC ID: | 2ADA4XB52U |
| Test Standard: | FCC Part 15.247 |

Any reproduction of this document must be done in full. No single part of this document may be reproduced without permission from BZT, All Test Data Presented in this report is only applicable to presented Test sample.

TEST RESULT CERTIFICATION

Applicant's name : MOBIWIRE MOBILES (NINGBO) CO.,LTD
 Address : No.999, Dacheng East Road, Fenghua City, Zhejiang, China
Manufacture's Name : MOBIWIRE MOBILES (NINGBO) CO.,LTD
 Address : No.999, Dacheng East Road, Fenghua City, Zhejiang, China

Product description

Product name : 3G Featurephone
 Brand name : Mobiwire
 Model and/or type reference : XB52U
 Series Model : N/A

Standards : FCC Part15.247

Test procedure ANSI C63.10-2013

This device described above has been tested by BZT, the test results show that the equipment under test (EUT) is in compliance with the FCC requirements. And it is applicable only to the tested sample identified in the report.

This report shall not be reproduced except in full, without the written approval of BZT, this document may be altered or revised by BZT, personal only, and shall be noted in the revision of the document.

Date of Test :

Date (s) of performance of tests : 27 Mar. 2017 ~ 01 Apr. 2017

Date of Issue : 05 Apr. 2017

Test Result : **Pass**

Testing Engineer :



(Leo li)

Technical Manager :



(Tony liu)

Authorized Signatory :



(Vita Li)

| Table of Content | page |
|---|-----------|
| 1. SUMMARY OF TEST RESULTS | 5 |
| 1.1 TEST FACTORY | 5 |
| 1.2 MEASUREMENT UNCERTAINTY | 6 |
| 2. GENERAL INFORMATION | 7 |
| 2.1 GENERAL DESCRIPTION OF EUT | 7 |
| 2.2 DESCRIPTION OF TEST MODES | 9 |
| 2.3 BLOCK DIGRAM SHOWING THE CONFIGURATION OF SYSTEM TESTED | 10 |
| 2.4 DESCRIPTION OF SUPPORT UNITS(CONDUCTED MODE) | 11 |
| 2.5 EQUIPMENTS LIST FOR ALL TEST ITEMS | 12 |
| 3. EMC EMISSION TEST | 13 |
| 3.1 CONDUCTED EMISSION MEASUREMENT | 13 |
| 3.2 TEST PROCEDURE | 14 |
| 3.3 TEST SETUP | 14 |
| 3.4 EUT OPERATING CONDITIONS | 14 |
| 3.5 TEST RESULTS | 15 |
| 4. RADIATED EMISSION MEASUREMENT | 17 |
| 4.1 RADIATED EMISSION LIMITS | 17 |
| 4.2 TEST PROCEDURE | 18 |
| 4.3 TEST SETUP | 19 |
| 4.4 EUT OPERATING CONDITIONS | 19 |
| 4.5 TEST RESULTS | 20 |
| 4.6 TEST RESULTS (RESTRICTED BANDS REQUIREMENTS) | 26 |
| 5. CONDUCTED SPURIOUS & BAND EDGE EMISSION | 27 |
| 5.1 REQUIREMENT | 27 |
| 5.2 TEST PROCEDURE | 27 |
| 5.3 TEST SETUP | 27 |
| 5.4 EUT OPERATION CONDITIONS | 27 |
| 5.5 TEST RESULTS | 28 |
| 6. POWER SPECTRAL DENSITY TEST | 31 |
| 6.1 APPLIED PROCEDURES / LIMIT | 31 |
| 6.2 TEST PROCEDURE | 31 |
| 6.3 TEST SETUP | 31 |
| 6.4 EUT OPERATION CONDITIONS | 31 |
| 6.5 TEST RESULTS | 32 |

| Table of Content | page |
|----------------------------------|-----------|
| 7. BANDWIDTH TEST | 34 |
| 7.1 APPLIED PROCEDURES / LIMIT | 34 |
| 7.2 TEST PROCEDURE | 34 |
| 7.3 TEST SETUP | 34 |
| 7.4 EUT OPERATION CONDITIONS | 34 |
| 7.5 TEST RESULTS | 35 |
| 8. PEAK OUTPUT POWER TEST | 37 |
| 8.1 APPLIED PROCEDURES / LIMIT | 37 |
| 8.2 TEST PROCEDURE | 37 |
| 8.3 TEST SETUP | 37 |
| 8.4 EUT OPERATION CONDITIONS | 37 |
| 8.5 TEST RESULTS | 38 |
| 9. ANTENNA REQUIREMENT | 39 |
| 9.1 STANDARD REQUIREMENT | 39 |
| 9.2 EUT ANTENNA | 39 |
| 10. EUT TEST PHOTO | 40 |

1. SUMMARY OF TEST RESULTS

Test procedures according to the technical standards:
KDB 558074 D01 DTS Meas Guidance v03r05

| FCC Part 15.247, Subpart C | | | |
|-----------------------------------|---|----------|--------|
| Standard Section | Test Item | Judgment | Remark |
| 15.207 | Conducted Emission | PASS | -- |
| 15.247 (a)(2) | 6dB Bandwidth | PASS | -- |
| 15.247 (b)(3) | Output Power | PASS | -- |
| 15.247 (c) | Radiated Spurious Emission | PASS | -- |
| 15.247 (d) | Conducted Spurious & Band Edge Emission | PASS | -- |
| 15.247 (e) | Power Spectral Density | PASS | -- |
| 15.205 | Restricted Band Edge Emission | PASS | -- |
| Part 15.247(d)/part 15.209(a) | Band Edge Emission | PASS | -- |
| 15.203 | Antenna Requirement | PASS | -- |

NOTE:

- (1) "N/A" denotes test is not applicable in this Test Report
- (2) All tests are according to ANSI C63.10-2013

1.1 TEST FACTORY

BZT Testing Technology Co., Ltd
Add. : Buliding 17, Xinghua Road Xingwei industrial Park Fuyong,
Baoan District, Shenzhen, Guangdong, China
FCC Registration No.: 701733

1.2 MEASUREMENT UNCERTAINTY

The reported uncertainty of measurement $y \pm U$, where expanded uncertainty U is based on a standard uncertainty multiplied by a coverage factor of $k=2$, providing a level of confidence of approximately **95 %**.

| No. | Item | Uncertainty |
|-----|--|---------------------------|
| 1 | Conducted Emission (9KHz-150KHz) | $\pm 2.88\text{dB}$ |
| 2 | Conducted Emission (150KHz-30MHz) | $\pm 2.67\text{dB}$ |
| 3 | RF power,conducted | $\pm 0.70\text{dB}$ |
| 4 | Spurious emissions,conducted | $\pm 1.19\text{dB}$ |
| 5 | All emissions,radiated(<30M) (9KHz-30MHz) | $\pm 2.45\text{dB}$ |
| 6 | All emissions,radiated(<1G) 30MHz-200MHz | $\pm 2.83\text{dB}$ |
| 7 | All emissions,radiated(<1G) 200MHz-1000MHz | $\pm 2.94\text{dB}$ |
| 8 | All emissions,radiated(>1G) | $\pm 3.03\text{dB}$ |
| 9 | Temperature | $\pm 0.5^{\circ}\text{C}$ |
| 10 | Humidity | $\pm 2\%$ |

2. GENERAL INFORMATION

2.1 GENERAL DESCRIPTION OF EUT

| | | |
|-------------------------|--|--------------------|
| Equipment | 3G Featurephone | |
| Trade Name | Mobiwire | |
| Model Name | XB52U | |
| Series Model | N/A | |
| Model Difference | N/A | |
| Product Description | The EUT is a 3G Featurephone | |
| | Operation Frequency: | 2402~2480 MHz |
| | Modulation Type: | GFSK |
| | Radio Technology | BLE |
| | Number Of Channel | 40 |
| | Antenna Designation: | Please see Note 3. |
| | Antenna Gain (dBi) | -1 dBi |
| Channel List | Please refer to the Note 2. | |
| Adapter | Input: AC100-240V, 200mA, 50/60 Hz Output: DC 5V, 550mA | |
| Battery | Rated Voltage: 3.7V capacity :800mAh | |
| Hardware version number | V00 | |
| Software version number | UP249_XB52U_Digicel_debug_FCC | |
| Connecting I/O Port(s) | Please refer to the User's Manual | |

Note:

1. For a more detailed features description, please refer to the manufacturer's specifications or the User's Manual.

2.

| Channel List | | | | | | | |
|--------------|-----------------|---------|-----------------|---------|-----------------|---------|-----------------|
| Channel | Frequency (MHz) | Channel | Frequency (MHz) | Channel | Frequency (MHz) | Channel | Frequency (MHz) |
| 01 | 2402 | 11 | 2422 | 21 | 2442 | 31 | 2462 |
| 02 | 2404 | 12 | 2424 | 22 | 2444 | 32 | 2464 |
| 03 | 2406 | 13 | 2426 | 23 | 2446 | 33 | 2466 |
| 04 | 2408 | 14 | 2428 | 24 | 2448 | 34 | 2468 |
| 05 | 2410 | 15 | 2430 | 25 | 2450 | 35 | 2470 |
| 06 | 2412 | 16 | 2432 | 26 | 2452 | 36 | 2472 |
| 07 | 2414 | 17 | 2434 | 27 | 2454 | 37 | 2474 |
| 08 | 2416 | 18 | 2436 | 28 | 2456 | 38 | 2476 |
| 09 | 2418 | 19 | 2438 | 29 | 2458 | 39 | 2478 |
| 10 | 2420 | 20 | 2440 | 30 | 2460 | 40 | 2480 |

3.

Table for Filed Antenna

| Ant. | Brand | Model Name | Antenna Type | Connector | Gain (dBi) | NOTE |
|------|----------|------------|--------------|-----------|------------|------------|
| 1 | Mobiwire | XB52U | PIFA | N/A | -1 | BT 4.0 ANT |

2.2 DESCRIPTION OF TEST MODES

For conducted test items and radiated spurious emissions
Each of these EUT operation mode(s) or test configuration mode(s) mentioned below was evaluated respectively..

| Worst Mode | Description | Data/Modulation |
|------------|------------------|-----------------|
| Mode 1 | TX CH1(2402MHz) | 1 MHz/GFSK |
| Mode 2 | TX CH20(2440MHz) | 1 MHz/GFSK |
| Mode 3 | TX CH40(2480MHz) | 1 MHz/GFSK |

Note:

- (1) The measurements are performed at all Bit Rate of Transmitter, the worst data was reported
- (2) We have be tested for all avaiable U.S. voltage and frequencies(For 120V,50/60Hz and 240V, 50/60Hz) for which the device is capable of operation.
- (3) The EUT was programmed to be in continuously transmitting with a modulated carrier at maximum power on bottom/middle/top channels as required using the supported data rates/modulation types and the transmit duty cycle is not less than 98%.
- (4) Controlled using a bespoke application on the laptop PC supplied by the customer. The application was used to enable a continuous transmission mode and to select the test channels, data rates and modulation schemes as required.

For AC Conducted Emission

| Test Case | |
|-----------------------|------------------------|
| AC Conducted Emission | Mode 4 : Keeping BT TX |

2.3 BLOCK DIGRAM SHOWING THE CONFIGURATION OF SYSTEM TESTED

Radiated Spurious Emission Test

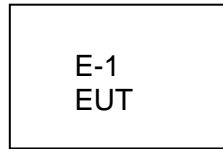

Conducted Emission Test

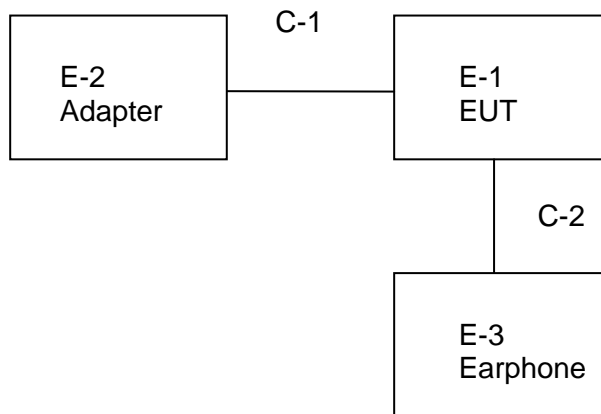

2.4 DESCRIPTION OF SUPPORT UNITS(CONDUCTED MODE)

The EUT has been tested as an independent unit together with other necessary accessories or support units. The following support units or accessories were used to form a representative test configuration during the tests.

| Item | Equipment | Mfr/Brand | Model/Type No. | Serial No. | Note |
|------|-----------------|-----------|------------------|------------|------|
| E-1 | 3G Featurephone | Mobiwire | XB52U | N/A | EUT |
| E-2 | Adapter | Mobiwire | A31A-050055U-US1 | N/A | EUT |
| E-3 | Earphone | N/A | N/A | N/A | EUT |
| | | | | | |
| | | | | | |
| | | | | | |

| Item | Shielded Type | Ferrite Core | Length | Note |
|------|--|--------------|--------|------|
| C-1 | USB Cable shielded line (Charging) | NO | 100cm | N/A |
| C-2 | Unshielded Cable | NO | 110cm | N/A |
| | | | | |
| | | | | |

Note:

- (1) The support equipment was authorized by Declaration of Confirmation.
- (2) For detachable type I/O cable should be specified the length in cm in 『Length』 column.
- (3) “YES” is means “shielded” “with core”; “NO” is means “unshielded” “without core”.

2.5 EQUIPMENTS LIST FOR ALL TEST ITEMS

Radiation Test equipment

| Kind of Equipment | Manufacturer | Type No. | Serial No. | Last calibration | Calibrated until |
|-----------------------|--------------|---------------------|--------------------|------------------|------------------|
| Spectrum Analyzer | Agilent | E4407B | MY50140340 | 2016.10.23 | 2017.10.22 |
| Test Receiver | R&S | ESCI | 101427 | 2016.10.23 | 2017.10.22 |
| Bilog Antenna | TESEQ | CBL6111D | 34678 | 2014.11.24 | 2017.11.23 |
| Horn Antenna | Schwarzbeck | BBHA 9120D(1201) | 9120D-1343 | 2015.03.05 | 2018.03.04 |
| Horn Antenna | Schwarzbeck | BBHA 9170 | 9170-0741 | 2016.03.06 | 2019.03.05 |
| 50Ω Coaxial Switch | Anritsu | MP59B | 6200264416 | 2016.06.06 | 2017.06.05 |
| PreAmplifier | Agilent | 8449B | 60538 | 2016.10.23 | 2017.10.22 |
| Loop Antenna | EMCO | 6502 | 9003-2485 | 2016.03.06 | 2019.03.05 |
| Preamplifier | Agilent | 8449B | 60538 | 2016.10.23 | 2017.10.22 |
| Low frequency cable | EM | R01 | N/A | NCR | NCR |
| High frequency cable | SCHWARZBECK | AK9515H | SN-96286/9628 7 | NCR | NCR |
| Semi-anechoic chamber | Changling | 966 | N/A | 2016.10.23 | 2017.10.22 |

Conduction Test equipment

| Kind of Equipment | Manufacturer | Type No. | Serial No. | Last calibration | Calibrated until |
|-------------------|--------------|----------|------------|------------------|------------------|
| EMI Test Receiver | R&S | ESPI | 102086 | 2016.10.23 | 2017.10.22 |
| LISN | R&S | ENV216 | 101242 | 2016.10.23 | 2017.10.22 |
| LISN | EMCO | 3810/2NM | 000-23625 | 2016.10.23 | 2017.10.22 |
| Conduction Cable | EM | C01 | N/A | NCR | NCR |
| Shielding Room | Changling | 854 | N/A | 2016.10.23 | 2017.10.22 |

RF Connected Test

| Kind of Equipment | Manufacturer | Type No. | Serial No. | Last calibration | Calibrated until |
|---------------------|--------------|----------|---------------|------------------|------------------|
| USB RF power sensor | DARE | RPR3006W | 15I00041SNO03 | 2016.10.23 | 2017.10.22 |
| Spectrum Analyzer | Agilent | E4407B | MY50140340 | 2016.10.23 | 2017.10.22 |
| Signal Analyzer | Agilent | N9020A | MY49100060 | 2016.10.23 | 2017.10.22 |

Note: The temporary antenna connector is soldered on the PCB board in order to perform conducted tests and this temporary antenna connector is listed in the equipment list.

3. EMC EMISSION TEST

3.1 CONDUCTED EMISSION MEASUREMENT

3.1.1 POWER LINE CONDUCTED EMISSION LIMITS

operating frequency band. In case the emission fall within the restricted band specified on Part 207(a) limit in the table below has to be followed.

| FREQUENCY (MHz) | Conducted Emission limit (dBuV) | |
|-----------------|---------------------------------|-----------|
| | Quasi-peak | Average |
| 0.15 -0.5 | 66 - 56 * | 56 - 46 * |
| 0.50 -5.0 | 56.00 | 46.00 |
| 5.0 -30.0 | 60.00 | 50.00 |

Note:

- (1) The tighter limit applies at the band edges.
- (2) The limit of " * " marked band means the limitation decreases linearly with the logarithm of the frequency in the range.

The following table is the setting of the receiver

| Receiver Parameters | Setting |
|---------------------|----------|
| Attenuation | 10 dB |
| Start Frequency | 0.15 MHz |
| Stop Frequency | 30 MHz |
| IF Bandwidth | 9 kHz |

3.2 TEST PROCEDURE

- The EUT was 0.8 meters from the horizontal ground plane and 0.4 meters from the vertical ground plane with EUT being connected to the power mains through a line impedance stabilization network (LISN). All other support equipments powered from additional LISN(s). The LISN provide 50 Ohm/ 50uH of coupling impedance for the measuring instrument.
- Interconnecting cables that hang closer than 40 cm to the ground plane shall be folded back and forth in the center forming a bundle 30 to 40 cm long.
- I/O cables that are not connected to a peripheral shall be bundled in the center. The end of the cable may be terminated, if required, using the correct terminating impedance. The overall length shall not exceed 1 m.
- LISN at least 80 cm from nearest part of EUT chassis.
- For the actual test configuration, please refer to the related Item –EUT Test Photos.

3.3 TEST SETUP

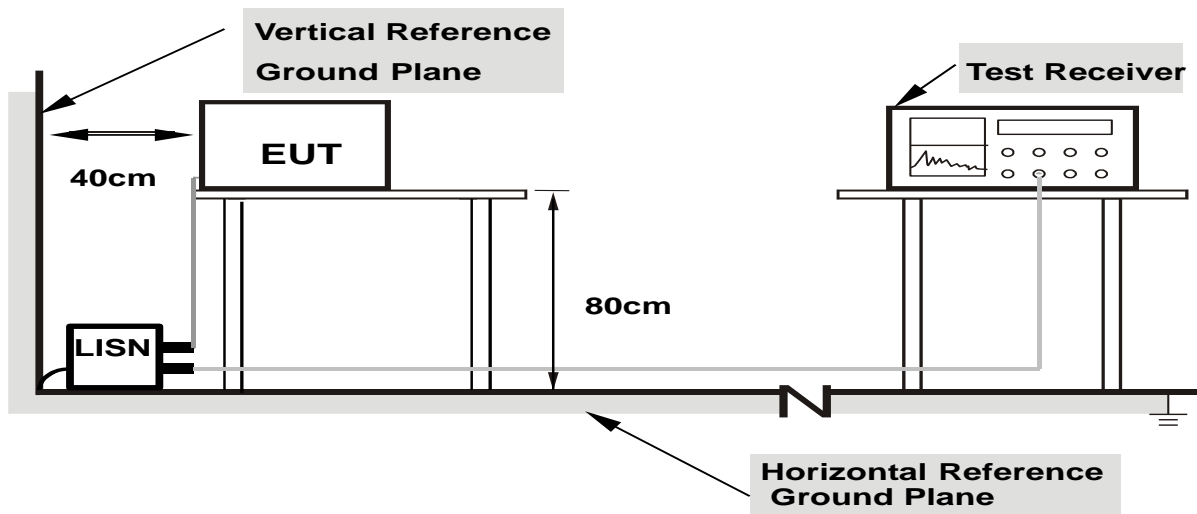

Note: 1.Support units were connected to second LISN.

2.Both of LISNs (AMN) are 80 cm from EUT and at least 80 from other units and other metal planes

3.4 EUT OPERATING CONDITIONS

The EUT was configured for testing in a typical fashion (as a customer would normally use it). The EUT has been programmed to continuously transmit during test. This operating condition was tested and used to collect the included data.

3.5 TEST RESULTS

| | | | |
|---------------|--------------|--------------------|--------|
| Temperature: | 23.1 °C | Relative Humidity: | 61% |
| Pressure: | 1010hPa | Phase: | L |
| Test Voltage: | AC 120V/60Hz | Test Mode: | Mode 4 |

| Frequency (MHz) | Reading (dBuV) | Correct Factor(dB) | Result (dBuV) | Limit (dBuV) | Margin (dB) | Remark |
|--------------------|-------------------|-----------------------|------------------|-----------------|----------------|--------|
| 0.1750 | 37.42 | 9.23 | 46.65 | 64.72 | -18.07 | QP |
| 0.1750 | 23.56 | 9.23 | 32.79 | 54.72 | -21.93 | AVG |
| 0.3910 | 30.57 | 9.41 | 39.98 | 58.04 | -18.06 | QP |
| 0.3910 | 17.55 | 9.41 | 26.96 | 48.04 | -21.08 | AVG |
| 1.2430 | 29.27 | 9.17 | 38.44 | 56.00 | -17.56 | QP |
| 1.2430 | 17.12 | 9.17 | 26.29 | 46.00 | -19.71 | AVG |
| 2.5710 | 33.49 | 9.26 | 42.75 | 56.00 | -13.25 | QP |
| 2.5710 | 18.48 | 9.26 | 27.74 | 46.00 | -18.26 | AVG |
| 4.2110 | 36.74 | 9.27 | 46.01 | 56.00 | -9.99 | QP |
| 4.2110 | 21.57 | 9.27 | 30.84 | 46.00 | -15.16 | AVG |
| 21.6990 | 27.02 | 9.88 | 36.90 | 60.00 | -23.10 | QP |
| 21.6990 | 15.74 | 9.88 | 25.62 | 50.00 | -24.38 | AVG |

Remark:

- All readings are Quasi-Peak and Average values.
- Margin = Result (Result = Reading + Factor) – Limit

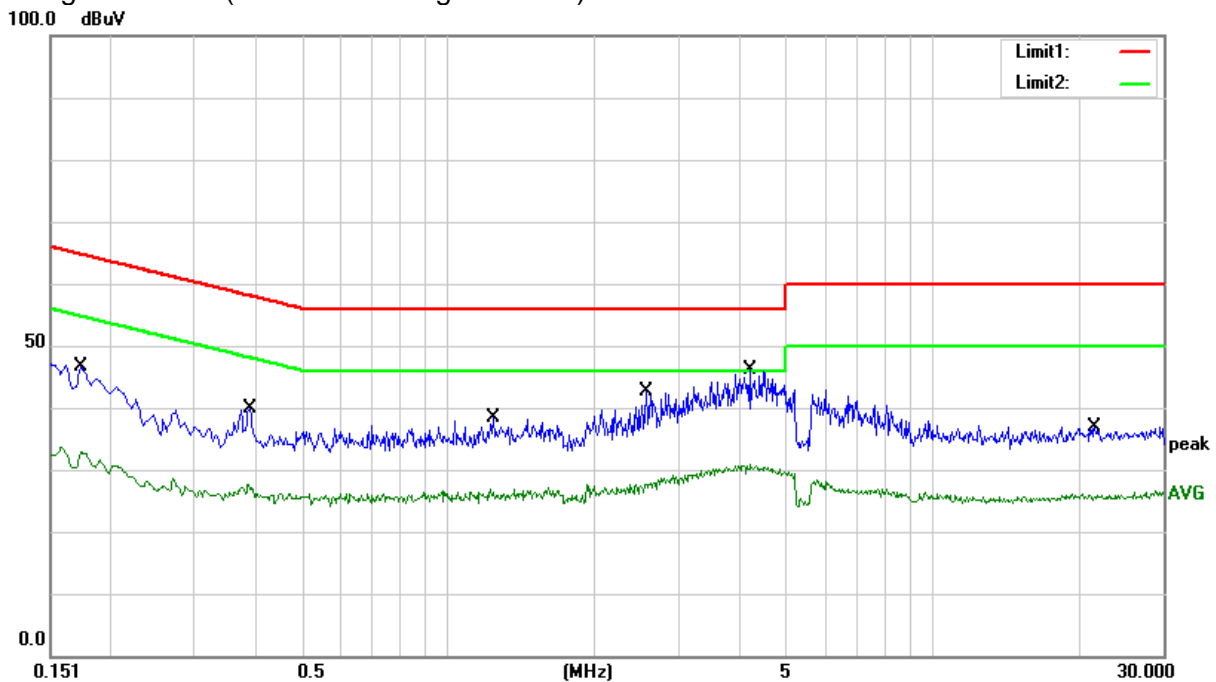

| | | | |
|---------------|--------------|--------------------|--------|
| Temperature: | 23.1 °C | Relative Humidity: | 61% |
| Pressure: | 1010hPa | Phase: | N |
| Test Voltage: | AC 120V/60Hz | Test Mode: | Mode 4 |

| Frequency (MHz) | Reading (dBuV) | Correct Factor(dB) | Result (dBuV) | Limit (dBuV) | Margin (dB) | Remark |
|--------------------|-------------------|-----------------------|------------------|-----------------|----------------|--------|
| 0.2051 | 36.06 | 9.22 | 45.28 | 63.40 | -18.12 | QP |
| 0.2051 | 21.38 | 9.22 | 30.60 | 53.40 | -22.80 | AVG |
| 0.3830 | 31.25 | 9.39 | 40.64 | 58.21 | -17.57 | QP |
| 0.3830 | 21.28 | 9.39 | 30.67 | 48.21 | -17.54 | AVG |
| 0.8150 | 28.94 | 9.21 | 38.15 | 56.00 | -17.85 | QP |
| 0.8150 | 18.14 | 9.21 | 27.35 | 46.00 | -18.65 | AVG |
| 2.0790 | 32.11 | 9.26 | 41.37 | 56.00 | -14.63 | QP |
| 2.0790 | 17.79 | 9.26 | 27.05 | 46.00 | -18.95 | AVG |
| 4.2310 | 38.69 | 9.27 | 47.96 | 56.00 | -8.04 | QP |
| 4.2310 | 23.01 | 9.27 | 32.28 | 46.00 | -13.72 | AVG |
| 17.2550 | 27.62 | 9.68 | 37.30 | 60.00 | -22.70 | QP |
| 17.2550 | 16.05 | 9.68 | 25.73 | 50.00 | -24.27 | AVG |

Remark:

- All readings are Quasi-Peak and Average values.
- Margin = Result (Result = Reading + Factor) – Limit

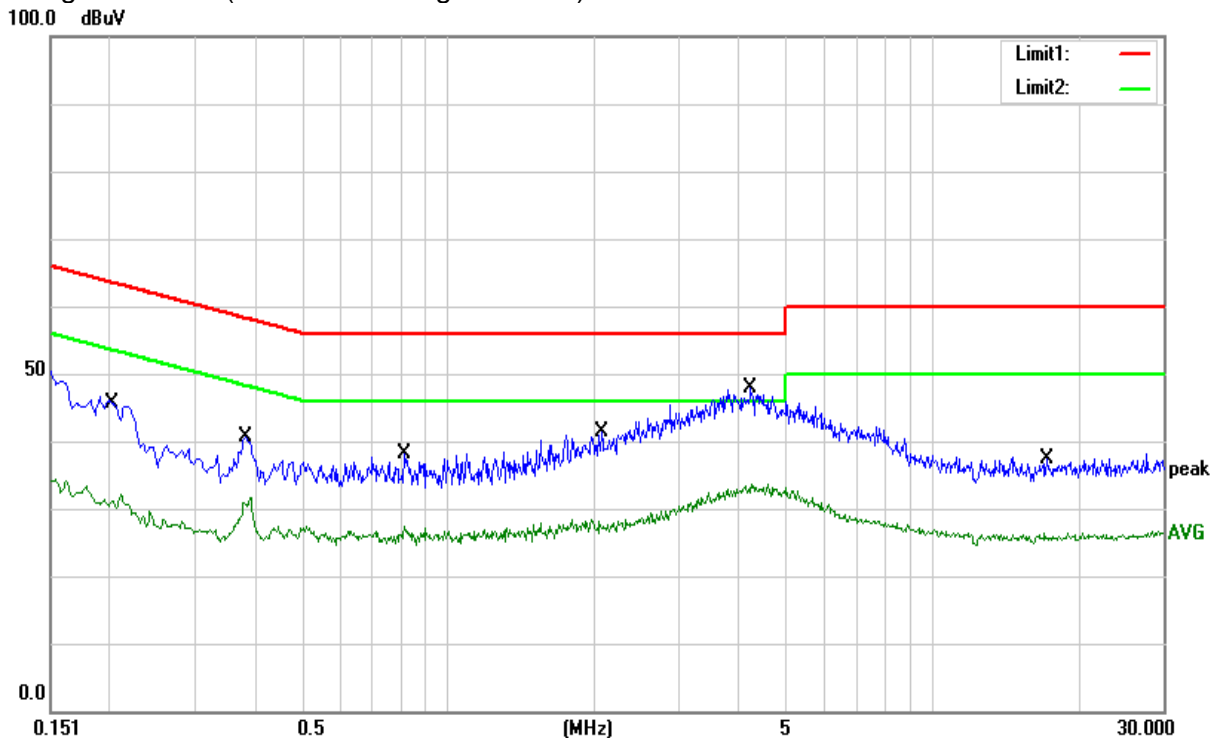

4. RADIATED EMISSION MEASUREMENT

4.1 RADIATED EMISSION LIMITS

in any 100 kHz bandwidth outside the operating frequency band. In case the emission fall within the Restricted band specified on Part15.205(a)&209(a) limit in the table and according to ANSI C63.10-2013 below has to be followed.

LIMITS OF RADIATED EMISSION MEASUREMENT (Frequency Range 9kHz-1000MHz)

| Frequencies (MHz) | Field Strength (micorvolts/meter) | Measurement Distance (meters) |
|-------------------|-----------------------------------|-------------------------------|
| 0.009~0.490 | 2400/F(KHz) | 300 |
| 0.490~1.705 | 24000/F(KHz) | 30 |
| 1.705~30.0 | 30 | 30 |
| 30~88 | 100 | 3 |
| 88~216 | 150 | 3 |
| 216~960 | 200 | 3 |
| Above 960 | 500 | 3 |

LIMITS OF RADIATED EMISSION MEASUREMENT (Above 1000MHz)

| FREQUENCY (MHz) | (dBuV/m) (at 3M) | |
|-----------------|------------------|---------|
| | PEAK | AVERAGE |
| Above 1000 | 74 | 54 |

Notes:

- (1) The limit for radiated test was performed according to FCC PART 15C.
- (2) The tighter limit applies at the band edges.
- (3) Emission level (dBuV/m)=20log Emission level (uV/m).

For Radiated Emission

| Spectrum Parameter | Setting |
|---------------------------------------|-------------------------------|
| Attenuation | Auto |
| Detector | Peak |
| Start Frequency | 1000 MHz(Peak/AV) |
| Stop Frequency | 10th carrier hamonic(Peak/AV) |
| RB / VB (emission in restricted band) | 1 MHz / 3 MHz |

For Band edge

| Spectrum Parameter | Setting |
|---------------------------------------|--|
| Detector | Peak |
| Start/Stop Frequency | Lower Band Edge: 2300 to 2403 MHz Upper Band Edge: 2479 to 2500 MHz |
| RB / VB (emission in restricted band) | 1 MHz / 3 MHz |

| Receiver Parameter | Setting |
|------------------------|--------------------------------------|
| Start ~ Stop Frequency | 9kHz~90kHz / RB 200Hz for PK & AV |
| Start ~ Stop Frequency | 90kHz~110kHz / RB 200Hz for QP |
| Start ~ Stop Frequency | 110kHz~490kHz / RB 200Hz for PK & AV |
| Start ~ Stop Frequency | 490kHz~30MHz / RB 9kHz for QP |
| Start ~ Stop Frequency | 30MHz~1000MHz / RB 120kHz for QP |

4.2 TEST PROCEDURE

- a. The measuring distance of at 3 m shall be used for measurements at frequency 0.009MHz up to 1GHz, and above 1GHz.
- b. The EUT was placed on the top of a rotating table 0.8 meters(above 1GHz is 1.5 m) above the ground at a 3 meter anechoic chamber. The table was rotated 360 degrees to determine the position of the highest radiation.
- c. The height of the equipment shall be 0.8 m(above 1GHz is 1.5 m); the height of the test antenna shall vary between 1 m to 4 m. Horizontal and vertical polarizations of the antenna are set to make the measurement
- d. The initial step in collecting conducted emission data is a spectrum analyzer peak detector mode pre-scanning the measurement frequency range. Significant peaks are then marked and then Quasi Peak detector mode re-measured.
- e. If the Peak Mode measured value compliance with and lower than Quasi Peak Mode Limit, the EUT shall be deemed to meet QP Limits and then no additional QP Mode measurement performed.
- f. For the actual test configuration, please refer to the related Item –EUT Test Photos.

Note:

Both horizontal and vertical antenna polarities were tested and performed pretest to three orthogonal axis. The worst case emissions were reported.

4.3 TEST SETUP

(A) Radiated Emission Test-Up Frequency Below 30MHz

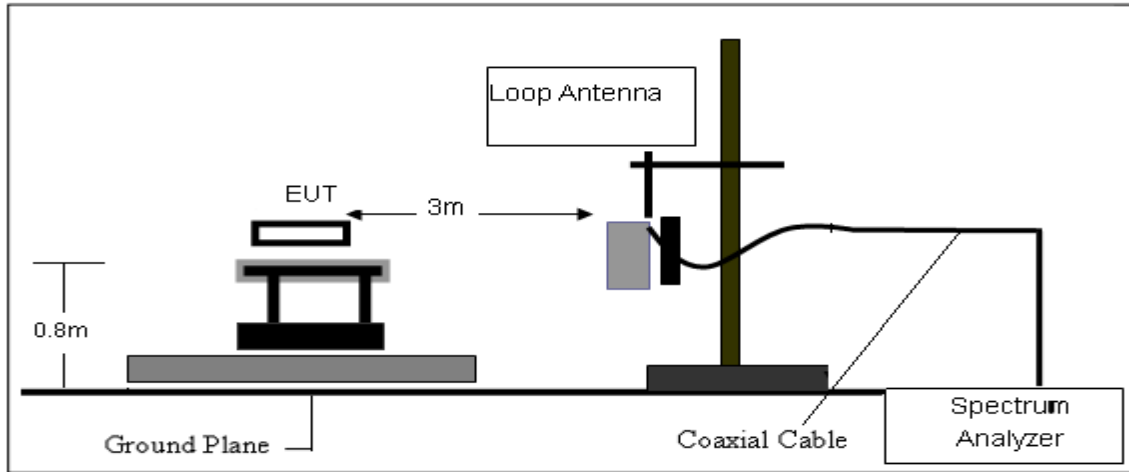

(B) Radiated Emission Test-Up Frequency 30MHz~1GHz

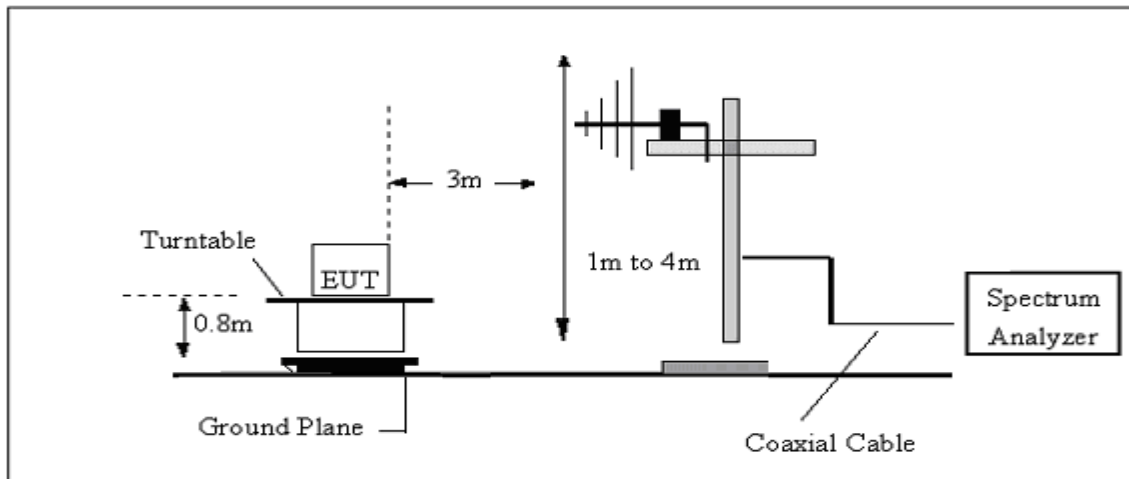

(C) Radiated Emission Test-Up Frequency Above 1GHz

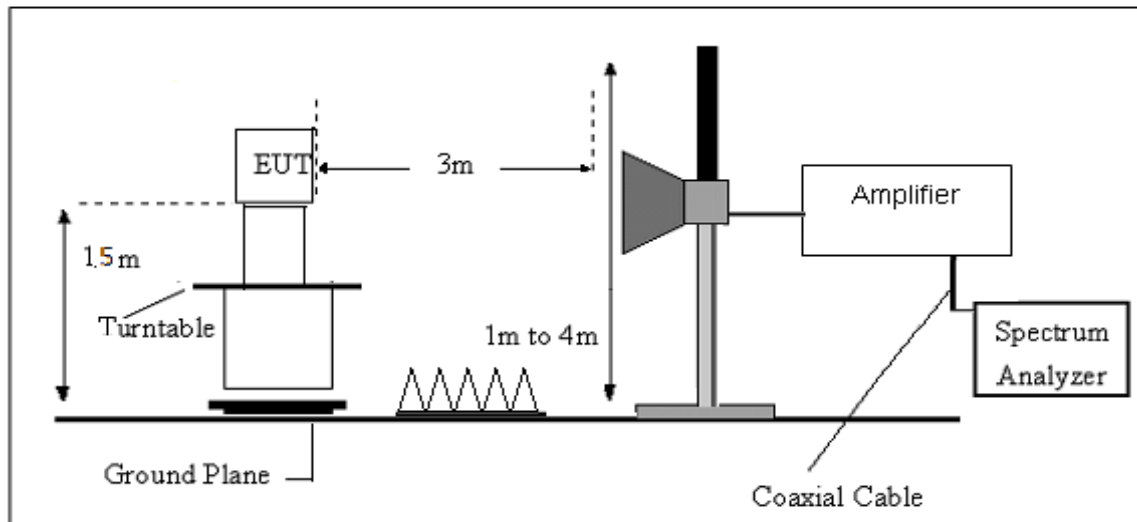

4.4 EUT OPERATING CONDITIONS

The EUT tested system was configured as the statements of 2.3 Unless otherwise a special operating condition is specified in the follows during the testing.

4.5 TEST RESULTS

(Between 9KHz – 30 MHz)

| | | | |
|--------------|----------|--------------------|-------------------|
| Temperature: | 20 °C | Relative Humidity: | 48% |
| Pressure: | 1010 hPa | Test Voltage: | 3.7V from Battery |
| Test Mode: | TX Mode | Polarization: | -- |

| Freq. | Reading | Limit | Margin | State |
|-------|----------|----------|--------|-------|
| (MHz) | (dBuV/m) | (dBuV/m) | (dB) | P/F |
| -- | -- | -- | -- | PASS |
| -- | -- | -- | -- | PASS |

Note:

The amplitude of spurious emissions which are attenuated by more than 20dB below the permissible value has no need to be reported.

Distance extrapolation factor = $40 \log(\text{specific distance}/\text{test distance})(\text{dB})$;

Limit line = specific limits(dBuv) + distance extrapolation factor.

(30MHz -1000MHz)

| | | | |
|---------------|-------------------|--------------------|-------------------------------------|
| Temperature: | 26 °C | Relative Humidity: | 60% |
| Pressure: | 1010hPa | Phase: | Horizontal |
| Test Voltage: | 3.7V from Battery | Test Mode: | Mode1/2/3 (Mode 1-1M worst mode) |

| Frequency (MHz) | Reading (dBuV) | Correct Factor(dB/m) | Result (dBuV/m) | Limit (dBuV/m) | Margin (dB) | Remark |
|--------------------|-------------------|-------------------------|--------------------|-------------------|----------------|--------|
| 47.8260 | 43.25 | -20.36 | 22.89 | 40.00 | -17.11 | QP |
| 89.2764 | 34.07 | -20.37 | 13.70 | 43.50 | -29.80 | QP |
| 150.0108 | 35.26 | -17.97 | 17.29 | 43.50 | -26.21 | QP |
| 250.3012 | 37.15 | -16.29 | 20.86 | 46.00 | -25.14 | QP |
| 400.4320 | 32.35 | -11.22 | 21.13 | 46.00 | -24.87 | QP |
| 750.1083 | 33.07 | -3.56 | 29.51 | 46.00 | -16.49 | QP |

Remark:

1. Margin = Result (Result =Reading + Factor)–Limit

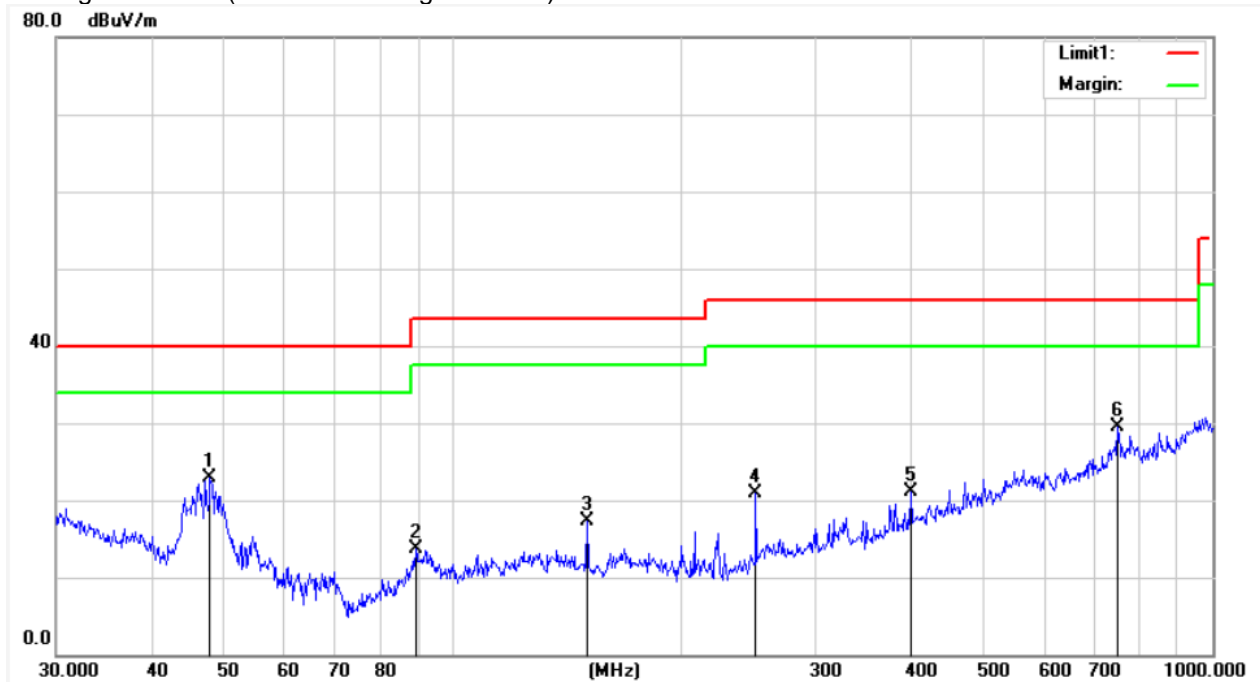

| | | | |
|---------------|-------------------|--------------------|--------------------------------------|
| Temperature: | 26 °C | Relative Humidity: | 60% |
| Pressure: | 1010hPa | Phase: | Vertical |
| Test Voltage: | 3.7V from Battery | Test Mode: | Mode 1/2/3 (Mode 1-1M worst mode) |

| Frequency (MHz) | Reading (dBuV) | Correct Factor(dB/m) | Result (dBuV/m) | Limit (dBuV/m) | Margin (dB) | Remark |
|--------------------|-------------------|-------------------------|--------------------|-------------------|----------------|--------|
| 31.3992 | 41.54 | -11.91 | 29.63 | 40.00 | -10.37 | QP |
| 38.0783 | 44.34 | -15.33 | 29.01 | 40.00 | -10.99 | QP |
| 90.5374 | 40.30 | -20.14 | 20.16 | 43.50 | -23.34 | QP |
| 141.3298 | 33.37 | -17.58 | 15.79 | 43.50 | -27.71 | QP |
| 199.2855 | 38.06 | -20.17 | 17.89 | 43.50 | -25.61 | QP |
| 601.4265 | 33.65 | -7.12 | 26.53 | 46.00 | -19.47 | QP |

Remark:

1. Margin = Result (Result =Reading + Factor)–Limit

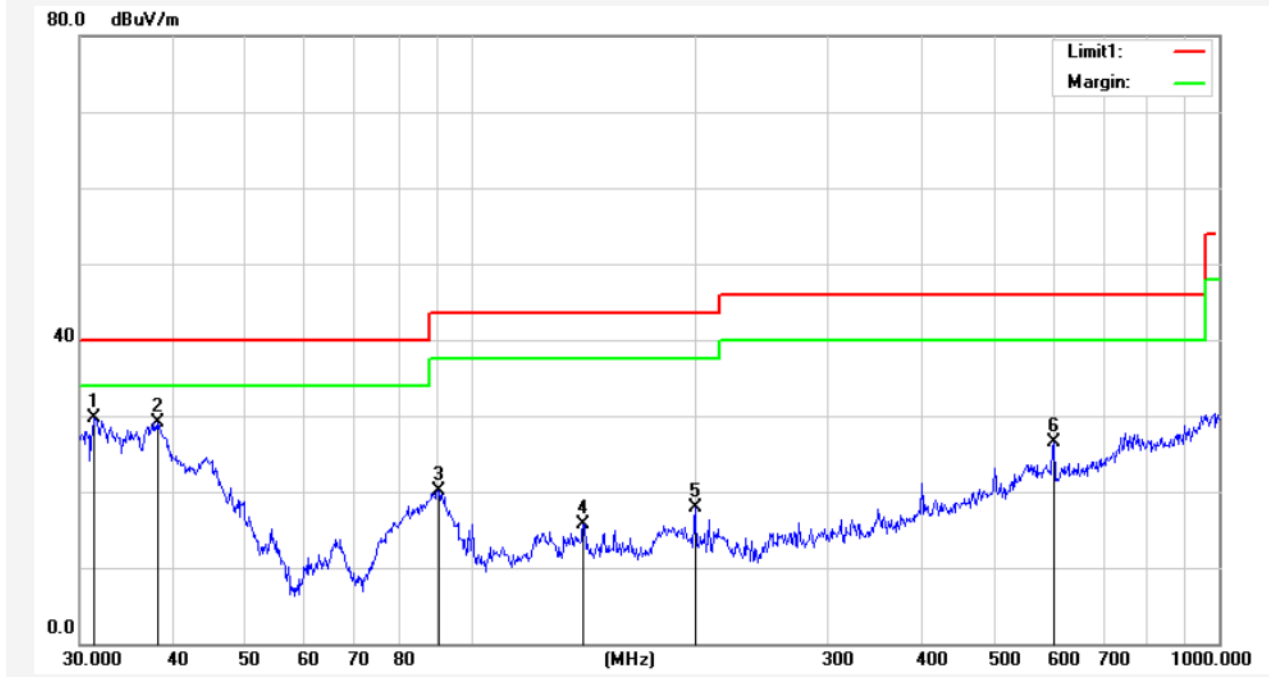

(1GHz-25GHz)Restricted band and Spurious emission Requirements

GFSK Low Channel

| Frequency (MHz) | Reading (dBμV) | Amplifier (dB) | Loss (dB) | Antenna | Corrected | Emission | | Margin (dB) | Detector Type | Comment |
|------------------------|-------------------|-------------------|--------------|------------------|----------------|-------------------|--------------------|----------------|------------------|------------|
| | | | | Factor (dB/m) | Factor (dB) | Level (dBμV/m) | Limits (dBμV/m) | | | |
| Low Channel (2402 MHz) | | | | | | | | | | |
| 3264.90 | 47.98 | 44.70 | 6.70 | 28.20 | -9.80 | 38.18 | 74.00 | -35.82 | PK | Vertical |
| 3264.90 | 39.76 | 44.70 | 6.70 | 28.20 | -9.80 | 29.96 | 54.00 | -24.04 | AV | Vertical |
| 3264.80 | 48.59 | 44.70 | 6.70 | 28.20 | -9.80 | 38.79 | 74.00 | -35.21 | PK | Horizontal |
| 3264.80 | 37.87 | 44.70 | 6.70 | 28.20 | -9.80 | 28.07 | 54.00 | -25.93 | AV | Horizontal |
| 4804.54 | 58.77 | 44.20 | 9.04 | 31.60 | -3.56 | 55.21 | 74.00 | -18.79 | PK | Vertical |
| 4804.54 | 38.22 | 44.20 | 9.04 | 31.60 | -3.56 | 34.66 | 54.00 | -19.34 | AV | Vertical |
| 4804.46 | 58.68 | 44.20 | 9.04 | 31.60 | -3.56 | 55.12 | 74.00 | -18.88 | PK | Horizontal |
| 4804.46 | 39.05 | 44.20 | 9.04 | 31.60 | -3.56 | 35.49 | 54.00 | -18.51 | AV | Horizontal |
| 5359.62 | 45.50 | 44.20 | 9.86 | 32.00 | -2.34 | 43.16 | 74.00 | -30.84 | PK | Vertical |
| 5359.62 | 38.06 | 44.20 | 9.86 | 32.00 | -2.34 | 35.72 | 54.00 | -18.28 | AV | Vertical |
| 5359.66 | 45.08 | 44.20 | 9.86 | 32.00 | -2.34 | 42.74 | 74.00 | -31.26 | PK | Horizontal |
| 5359.66 | 37.73 | 44.20 | 9.86 | 32.00 | -2.34 | 35.39 | 54.00 | -18.61 | AV | Horizontal |
| 7205.86 | 51.79 | 43.50 | 11.40 | 35.50 | 3.40 | 55.19 | 74.00 | -18.81 | PK | Vertical |
| 7205.86 | 33.49 | 43.50 | 11.40 | 35.50 | 3.40 | 36.89 | 54.00 | -17.11 | AV | Vertical |
| 7205.66 | 51.76 | 43.50 | 11.40 | 35.50 | 3.40 | 55.16 | 74.00 | -18.84 | PK | Horizontal |
| 7205.66 | 32.75 | 43.50 | 11.40 | 35.50 | 3.40 | 36.15 | 54.00 | -17.85 | AV | Horizontal |
| 11035.77 | 40.83 | 43.60 | 14.30 | 39.50 | 10.20 | 51.03 | 74.00 | -22.97 | PK | Vertical |
| 11035.77 | 30.42 | 43.60 | 14.30 | 39.50 | 10.20 | 40.62 | 54.00 | -13.38 | AV | Vertical |
| 11036.12 | 40.60 | 43.60 | 14.30 | 39.50 | 10.20 | 50.80 | 74.00 | -23.20 | PK | Horizontal |
| 11036.12 | 30.33 | 43.60 | 14.30 | 39.50 | 10.20 | 40.53 | 54.00 | -13.47 | AV | Horizontal |
| 13299.28 | 40.01 | 42.60 | 15.90 | 38.90 | 12.20 | 52.21 | 74.00 | -21.79 | PK | Vertical |
| 13299.28 | 28.54 | 42.60 | 15.90 | 38.90 | 12.20 | 40.74 | 54.00 | -13.26 | AV | Vertical |
| 13299.53 | 40.51 | 42.60 | 15.90 | 38.90 | 12.20 | 52.71 | 74.00 | -21.29 | PK | Horizontal |
| 13299.53 | 28.57 | 42.60 | 15.90 | 38.90 | 12.20 | 40.77 | 54.00 | -13.23 | AV | Horizontal |
| 15999.76 | 40.01 | 42.70 | 18.00 | 37.10 | 12.40 | 52.41 | 74.00 | -21.59 | PK | Vertical |
| 15999.76 | 28.64 | 42.70 | 18.00 | 37.10 | 12.40 | 41.04 | 54.00 | -12.96 | AV | Vertical |
| 15999.61 | 40.30 | 42.70 | 18.00 | 37.10 | 12.40 | 52.70 | 74.00 | -21.30 | PK | Horizontal |
| 15999.61 | 29.83 | 42.70 | 18.00 | 37.10 | 12.40 | 42.23 | 54.00 | -11.77 | AV | Horizontal |
| 17997.68 | 30.63 | 42.70 | 19.40 | 46.50 | 23.20 | 53.83 | 74.00 | -20.17 | PK | Vertical |
| 17997.68 | 19.96 | 42.70 | 19.40 | 46.50 | 23.20 | 43.16 | 54.00 | -10.84 | AV | Vertical |
| 17997.60 | 30.91 | 42.70 | 19.40 | 46.50 | 23.20 | 54.11 | 74.00 | -19.89 | PK | Horizontal |
| 17997.60 | 18.57 | 42.70 | 19.40 | 46.50 | 23.20 | 41.77 | 54.00 | -12.23 | AV | Horizontal |

GFSK Mid Channel

| Frequency (MHz) | Reading (dBμV) | Amplifier (dB) | Loss (dB) | Antenna | Corrected | Emission | | Margin (dB) | Detector Type | Comment |
|------------------------|-------------------|-------------------|--------------|------------------|----------------|-------------------|--------------------|----------------|------------------|------------|
| | | | | Factor (dB/m) | Factor (dB) | Level (dBμV/m) | Limits (dBμV/m) | | | |
| Low Channel (2440 MHz) | | | | | | | | | | |
| 3264.78 | 49.14 | 44.70 | 6.70 | 28.20 | -9.80 | 39.34 | 74.00 | -34.66 | PK | Vertical |
| 3264.78 | 38.97 | 44.70 | 6.70 | 28.20 | -9.80 | 29.17 | 54.00 | -24.83 | AV | Vertical |
| 3264.72 | 48.97 | 44.70 | 6.70 | 28.20 | -9.80 | 39.17 | 74.00 | -34.83 | PK | Horizontal |
| 3264.72 | 38.61 | 44.70 | 6.70 | 28.20 | -9.80 | 28.81 | 54.00 | -25.19 | AV | Horizontal |
| 4880.44 | 58.79 | 44.20 | 9.04 | 31.60 | -3.56 | 55.23 | 74.00 | -18.77 | PK | Vertical |
| 4880.44 | 38.39 | 44.20 | 9.04 | 31.60 | -3.56 | 34.83 | 54.00 | -19.17 | AV | Vertical |
| 4880.50 | 59.21 | 44.20 | 9.04 | 31.60 | -3.56 | 55.65 | 74.00 | -18.35 | PK | Horizontal |
| 4880.50 | 39.24 | 44.20 | 9.04 | 31.60 | -3.56 | 35.68 | 54.00 | -18.32 | AV | Horizontal |
| 5359.67 | 46.30 | 44.20 | 9.86 | 32.00 | -2.34 | 43.96 | 74.00 | -30.04 | PK | Vertical |
| 5359.67 | 37.91 | 44.20 | 9.86 | 32.00 | -2.34 | 35.57 | 54.00 | -18.43 | AV | Vertical |
| 5359.77 | 45.15 | 44.20 | 9.86 | 32.00 | -2.34 | 42.81 | 74.00 | -31.19 | PK | Horizontal |
| 5359.77 | 37.68 | 44.20 | 9.86 | 32.00 | -2.34 | 35.34 | 54.00 | -18.66 | AV | Horizontal |
| 7310.78 | 51.92 | 43.50 | 11.40 | 35.50 | 3.40 | 55.32 | 74.00 | -18.68 | PK | Vertical |
| 7310.78 | 33.34 | 43.50 | 11.40 | 35.50 | 3.40 | 36.74 | 54.00 | -17.26 | AV | Vertical |
| 7310.75 | 50.54 | 43.50 | 11.40 | 35.50 | 3.40 | 53.94 | 74.00 | -20.06 | PK | Horizontal |
| 7310.75 | 33.66 | 43.50 | 11.40 | 35.50 | 3.40 | 37.06 | 54.00 | -16.94 | AV | Horizontal |
| 9607.80 | 40.04 | 43.60 | 14.30 | 39.50 | 10.20 | 50.24 | 74.00 | -23.76 | PK | Vertical |
| 9607.80 | 30.50 | 43.60 | 14.30 | 39.50 | 10.20 | 40.70 | 54.00 | -13.30 | AV | Vertical |
| 9608.01 | 40.92 | 43.60 | 14.30 | 39.50 | 10.20 | 51.12 | 74.00 | -22.88 | PK | Horizontal |
| 9608.01 | 30.20 | 43.60 | 14.30 | 39.50 | 10.20 | 40.40 | 54.00 | -13.60 | AV | Horizontal |
| 13299.20 | 39.62 | 42.60 | 15.90 | 38.90 | 12.20 | 51.82 | 74.00 | -22.18 | PK | Vertical |
| 13299.20 | 28.54 | 42.60 | 15.90 | 38.90 | 12.20 | 40.74 | 54.00 | -13.26 | AV | Vertical |
| 13299.49 | 39.94 | 42.60 | 15.90 | 38.90 | 12.20 | 52.14 | 74.00 | -21.86 | PK | Horizontal |
| 13299.49 | 29.46 | 42.60 | 15.90 | 38.90 | 12.20 | 41.66 | 54.00 | -12.34 | AV | Horizontal |
| 15999.94 | 39.70 | 42.70 | 18.00 | 37.10 | 12.40 | 52.10 | 74.00 | -21.90 | PK | Vertical |
| 15999.94 | 28.64 | 42.70 | 18.00 | 37.10 | 12.40 | 41.04 | 54.00 | -12.96 | AV | Vertical |
| 15999.76 | 40.10 | 42.70 | 18.00 | 37.10 | 12.40 | 52.50 | 74.00 | -21.50 | PK | Horizontal |
| 15999.76 | 29.51 | 42.70 | 18.00 | 37.10 | 12.40 | 41.91 | 54.00 | -12.09 | AV | Horizontal |
| 17997.71 | 30.43 | 42.70 | 19.40 | 46.50 | 23.20 | 53.63 | 74.00 | -20.37 | PK | Vertical |
| 17997.71 | 19.03 | 42.70 | 19.40 | 46.50 | 23.20 | 42.23 | 54.00 | -11.77 | AV | Vertical |
| 17997.61 | 29.89 | 42.70 | 19.40 | 46.50 | 23.20 | 53.09 | 74.00 | -20.91 | PK | Horizontal |
| 17997.61 | 18.41 | 42.70 | 19.40 | 46.50 | 23.20 | 41.61 | 54.00 | -12.39 | AV | Horizontal |

GFSK High Channel

| Frequency (MHz) | Reading (dBμV) | Amplifier (dB) | Loss (dB) | Antenna | Corrected | Emission | | Margin (dB) | Detector Type | Comment |
|------------------------|-------------------|-------------------|--------------|------------------|----------------|-------------------|--------------------|----------------|------------------|------------|
| | | | | Factor (dB/m) | Factor (dB) | Level (dBμV/m) | Limits (dBμV/m) | | | |
| Low Channel (2480 MHz) | | | | | | | | | | |
| 3264.74 | 47.84 | 44.70 | 6.70 | 28.20 | -9.80 | 38.04 | 74.00 | -35.96 | PK | Vertical |
| 3264.74 | 38.38 | 44.70 | 6.70 | 28.20 | -9.80 | 28.58 | 54.00 | -25.42 | AV | Vertical |
| 3264.59 | 48.21 | 44.70 | 6.70 | 28.20 | -9.80 | 38.41 | 74.00 | -35.59 | PK | Horizontal |
| 3264.59 | 38.48 | 44.70 | 6.70 | 28.20 | -9.80 | 28.68 | 54.00 | -25.32 | AV | Horizontal |
| 4960.38 | 58.31 | 44.20 | 9.04 | 31.60 | -3.56 | 54.75 | 74.00 | -19.25 | PK | Vertical |
| 4960.38 | 38.77 | 44.20 | 9.04 | 31.60 | -3.56 | 35.21 | 54.00 | -18.79 | AV | Vertical |
| 4960.39 | 58.34 | 44.20 | 9.04 | 31.60 | -3.56 | 54.78 | 74.00 | -19.22 | PK | Horizontal |
| 4960.39 | 38.93 | 44.20 | 9.04 | 31.60 | -3.56 | 35.37 | 54.00 | -18.63 | AV | Horizontal |
| 5359.83 | 45.45 | 44.20 | 9.86 | 32.00 | -2.34 | 43.11 | 74.00 | -30.89 | PK | Vertical |
| 5359.83 | 38.07 | 44.20 | 9.86 | 32.00 | -2.34 | 35.73 | 54.00 | -18.27 | AV | Vertical |
| 5359.65 | 45.12 | 44.20 | 9.86 | 32.00 | -2.34 | 42.78 | 74.00 | -31.22 | PK | Horizontal |
| 5359.65 | 37.75 | 44.20 | 9.86 | 32.00 | -2.34 | 35.41 | 54.00 | -18.59 | AV | Horizontal |
| 7439.92 | 51.24 | 43.50 | 11.40 | 35.50 | 3.40 | 54.64 | 74.00 | -19.36 | PK | Vertical |
| 7439.92 | 33.87 | 43.50 | 11.40 | 35.50 | 3.40 | 37.27 | 54.00 | -16.73 | AV | Vertical |
| 7439.86 | 51.40 | 43.50 | 11.40 | 35.50 | 3.40 | 54.80 | 74.00 | -19.20 | PK | Horizontal |
| 7439.86 | 33.35 | 43.50 | 11.40 | 35.50 | 3.40 | 36.75 | 54.00 | -17.25 | AV | Horizontal |
| 9919.77 | 41.26 | 43.60 | 14.30 | 39.50 | 10.20 | 51.46 | 74.00 | -22.54 | PK | Vertical |
| 9919.77 | 30.37 | 43.60 | 14.30 | 39.50 | 10.20 | 40.57 | 54.00 | -13.43 | AV | Vertical |
| 9920.08 | 40.78 | 43.60 | 14.30 | 39.50 | 10.20 | 50.98 | 74.00 | -23.02 | PK | Horizontal |
| 9920.08 | 29.79 | 43.60 | 14.30 | 39.50 | 10.20 | 39.99 | 54.00 | -14.01 | AV | Horizontal |
| 13299.41 | 40.62 | 42.70 | 18.00 | 37.10 | 12.40 | 53.02 | 74.00 | -20.98 | PK | Vertical |
| 13299.41 | 28.54 | 42.70 | 18.00 | 37.10 | 12.40 | 40.94 | 54.00 | -13.06 | AV | Vertical |
| 13299.30 | 39.89 | 42.70 | 18.00 | 37.10 | 12.40 | 52.29 | 74.00 | -21.71 | PK | Horizontal |
| 13299.30 | 29.69 | 42.70 | 18.00 | 37.10 | 12.40 | 42.09 | 54.00 | -11.91 | AV | Horizontal |
| 17997.79 | 30.83 | 42.70 | 19.40 | 46.50 | 23.20 | 54.03 | 74.00 | -19.97 | PK | Vertical |
| 17997.79 | 19.00 | 42.70 | 19.40 | 46.50 | 23.20 | 42.20 | 54.00 | -11.80 | AV | Vertical |
| 17997.64 | 31.26 | 42.70 | 19.40 | 46.50 | 23.20 | 54.46 | 74.00 | -19.54 | PK | Horizontal |
| 17997.64 | 19.07 | 42.70 | 19.40 | 46.50 | 23.20 | 42.27 | 54.00 | -11.73 | AV | Horizontal |

Note:

1) Factor = Antenna Factor + Cable Loss – Pre-amplifier.

Emission Level = Meter Reading + Factor

4.6 TEST RESULTS (Restricted Bands Requirements)

| Frequency (MHz) | Reading (dB μ V) | Amplifier (dB) | Loss (dB) | Antenna | Corrected | Emission | | Margin (dB) | Detector Type | Comment |
|--|-------------------------|-------------------|--------------|------------------|----------------|-------------------------|--------------------------|----------------|------------------|------------|
| | | | | Factor (dB/m) | Factor (dB) | Level (dB μ V/m) | Limits (dB μ V/m) | | | |
| GFSK | | | | | | | | | | |
| 2400.00 | 67.59 | 43.80 | 4.91 | 25.90 | -12.99 | 54.60 | 74.00 | -19.40 | PK | Vertical |
| 2400.00 | 54.33 | 43.80 | 4.91 | 25.90 | -12.99 | 41.34 | 54.00 | -12.66 | AV | Vertical |
| 2400.00 | 68.29 | 43.80 | 4.91 | 25.90 | -12.99 | 55.30 | 74.00 | -18.70 | PK | Horizontal |
| 2400.00 | 52.39 | 43.80 | 4.91 | 25.90 | -12.99 | 39.40 | 54.00 | -14.60 | AV | Horizontal |
| 2483.50 | 70.41 | 43.80 | 5.12 | 25.90 | -12.78 | 57.63 | 74.00 | -16.37 | PK | Vertical |
| 2483.50 | 52.22 | 43.80 | 5.12 | 25.90 | -12.78 | 39.44 | 54.00 | -14.56 | AV | Vertical |
| 2483.50 | 70.52 | 43.80 | 5.12 | 25.90 | -12.78 | 57.74 | 74.00 | -16.26 | PK | Horizontal |
| 2483.50 | 52.50 | 43.80 | 5.12 | 25.90 | -12.78 | 39.72 | 54.00 | -14.28 | AV | Horizontal |
| <p>Low measurement frequencies is range from 2300 to 2403 MHz, high measurement frequencies is range from 2479 to 2500 MHz. Only show the worst point data of the emissions in the frequency 2300-2403 MHz and 2479-2500 MHz.</p> | | | | | | | | | | |

5. CONDUCTED SPURIOUS & BAND EDGE EMISSION

5.1 REQUIREMENT

According to FCC section 15.247(d), in any 100kHz bandwidth outside the frequency band in which the spread spectrum or digitally modulated intentional radiator is operating, the radio frequency power that is produced by the intentional radiator shall be at least 20dB below that in the 100kHz bandwidth within the band that contains the highest level of the desired power, based on either an RF conducted or a radiated measurement.

5.2 TEST PROCEDURE

| Spectrum Parameter | Setting |
|---------------------------------------|---------------------------------|
| Detector | Peak |
| Start/Stop Frequency | 30 MHz to 10th carrier harmonic |
| RB / VB (emission in restricted band) | 100 KHz/300 KHz |
| Trace-Mode: | Max hold |

For Band edge

| Spectrum Parameter | Setting |
|---------------------------------------|--|
| Detector | Peak |
| Start/Stop Frequency | Lower Band Edge: 2300 – 2403 MHz Upper Band Edge: 2479 – 2500 MHz |
| RB / VB (emission in restricted band) | 100 KHz/300 KHz |
| Trace-Mode: | Max hold |

5.3 TEST SETUP

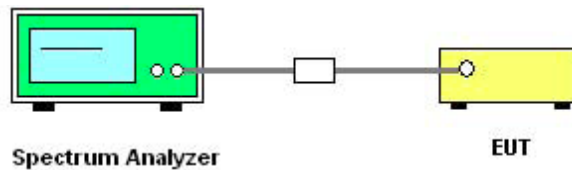

The EUT which is powered by the Battery, is coupled to the Spectrum Analyzer; the RF load attached to the EUT antenna terminal is 50 Ohm; the path loss as the factor is calibrated to correct the reading. Make the measurement with the spectrum analyzer's resolution bandwidth(RBW) = 100 kHz. In order to make an accurate measurement, set the span greater than RBW.

5.4 EUT OPERATION CONDITIONS

The EUT tested system was configured as the statements of 2.3 Unless otherwise a special operating condition is specified in the follows during the testing.

20 CH

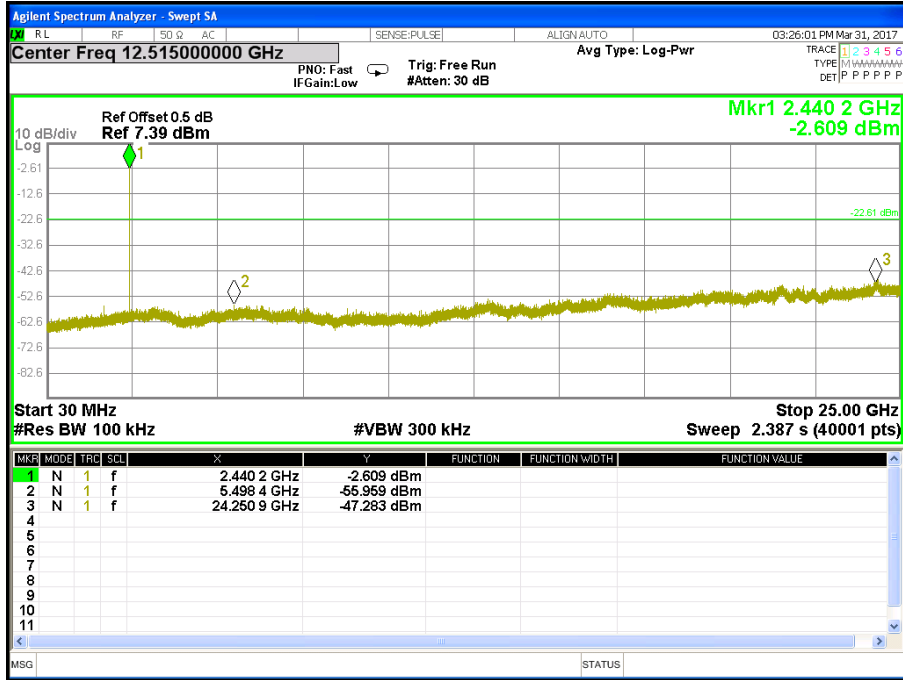

40 CH

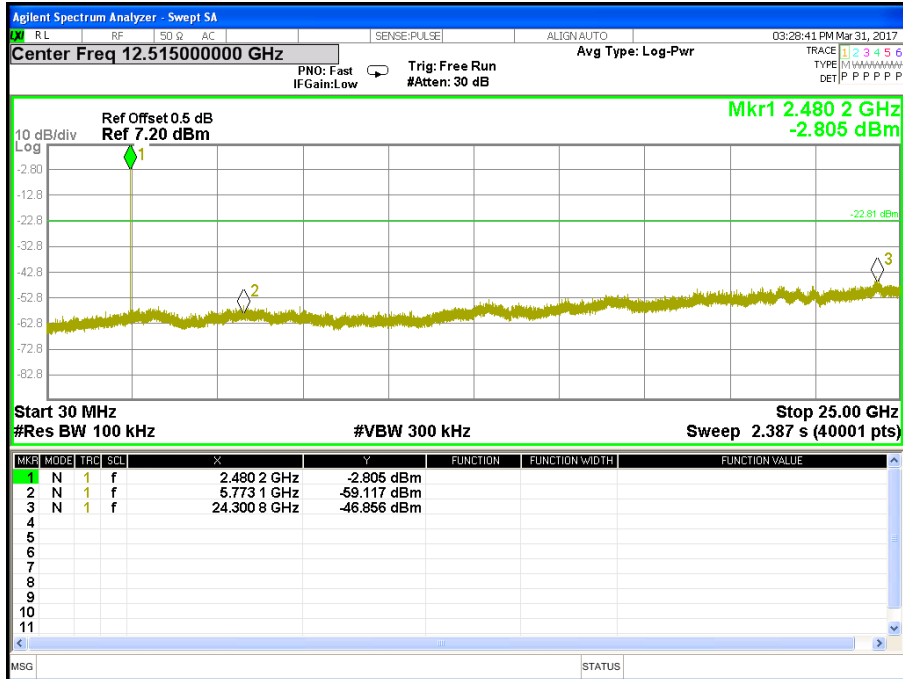

For Band edge

01 CH

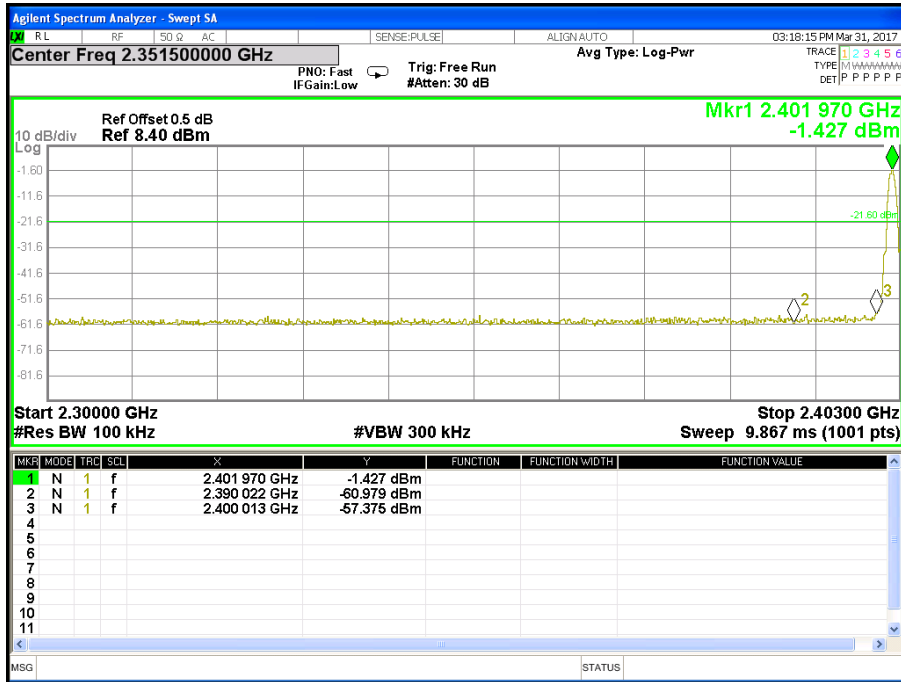

40 CH

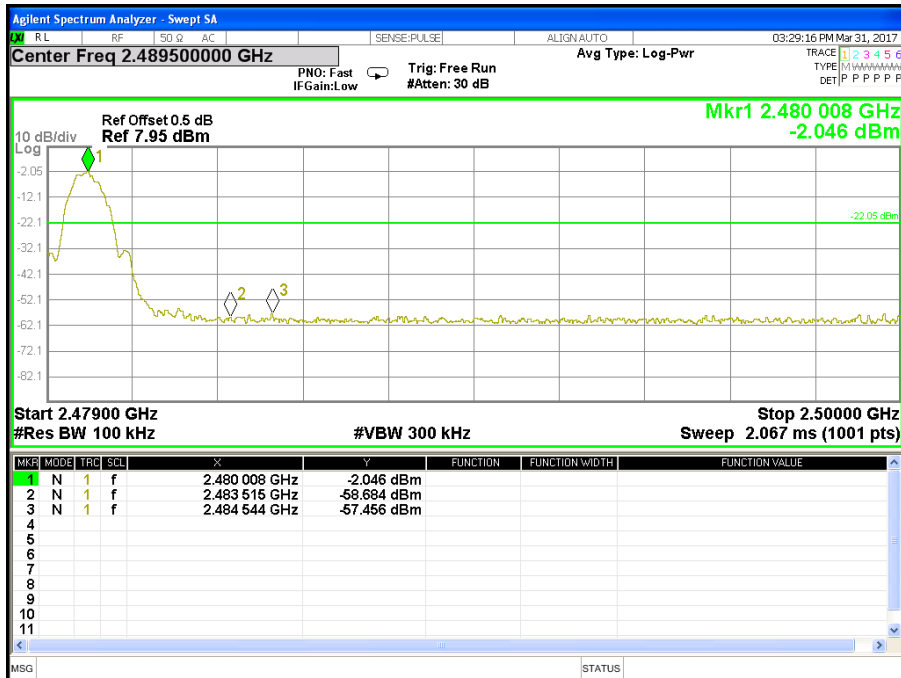

6. POWER SPECTRAL DENSITY TEST

6.1 APPLIED PROCEDURES / LIMIT

| FCC Part 15.247, Subpart C | | | | |
|----------------------------|------------------------|------------------------------------|-----------------------|--------|
| Section | Test Item | Limit | Frequency Range (MHz) | Result |
| 15.247(e) | Power Spectral Density | ≤ 8 dBm (RBW ≥ 3 KHz) | 2400-2483.5 | PASS |

6.2 TEST PROCEDURE

1. Set analyzer center frequency to DTS channel center frequency.
2. Set the span to 1.5 times the DTS channel bandwidth.
3. Set the RBW to: $100 \text{ kHz} \geq \text{RBW} \geq 3 \text{ kHz}$.
4. Set the VBW $\geq 3 \times \text{RBW}$.
5. Detector = peak.
6. Sweep time = auto couple.
7. Trace mode = max hold.
8. Allow trace to fully stabilize.
9. Use the peak marker function to determine the maximum amplitude level.
10. If measured value exceeds limit, reduce RBW (no less than 3 kHz) and repeat.

6.3 TEST SETUP

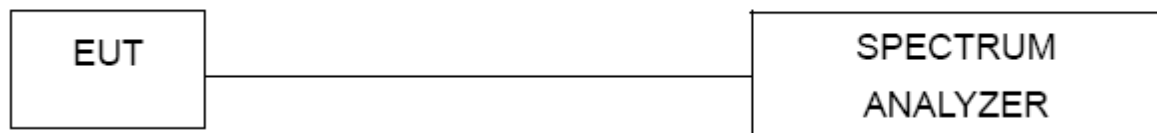

6.4 EUT OPERATION CONDITIONS

The EUT tested system was configured as the statements of 2.3 Unless otherwise a special operating condition is specified in the follows during the testing.

6.5 TEST RESULTS

| | | | |
|--------------|---------------------------|--------------------|---------|
| Temperature: | 25 °C | Relative Humidity: | 60% |
| Pressure: | 1015 hPa | Test Voltage: | DC 3.7V |
| Test Mode: | TX Mode /CH01, CH20, CH40 | | |

| Frequency | Power Density (dBm/3kHz) | Limit (dBm/3kHz) | Result |
|-----------|--------------------------|------------------|--------|
| 2402 MHz | -7.661 | ≤8 | PASS |
| 2440 MHz | -7.684 | ≤8 | PASS |
| 2480 MHz | -8.256 | ≤8 | PASS |

TX CH01

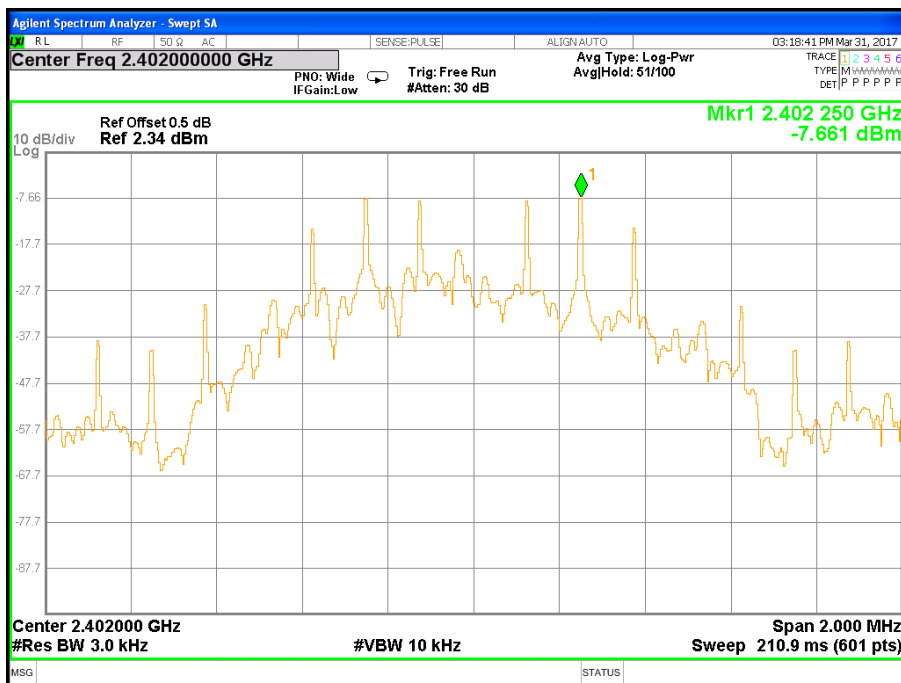

TX CH20

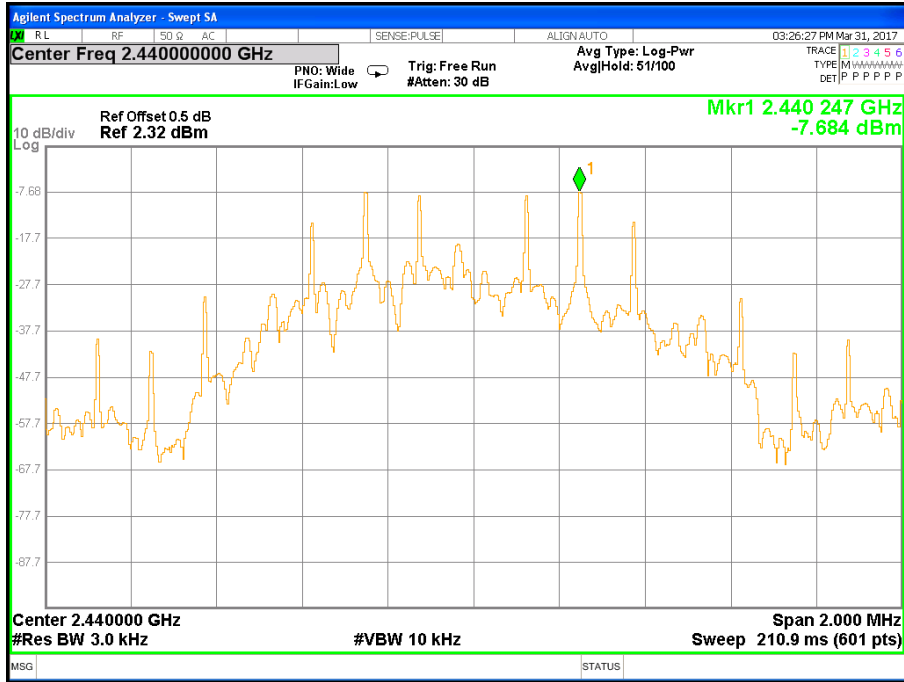

TX CH40

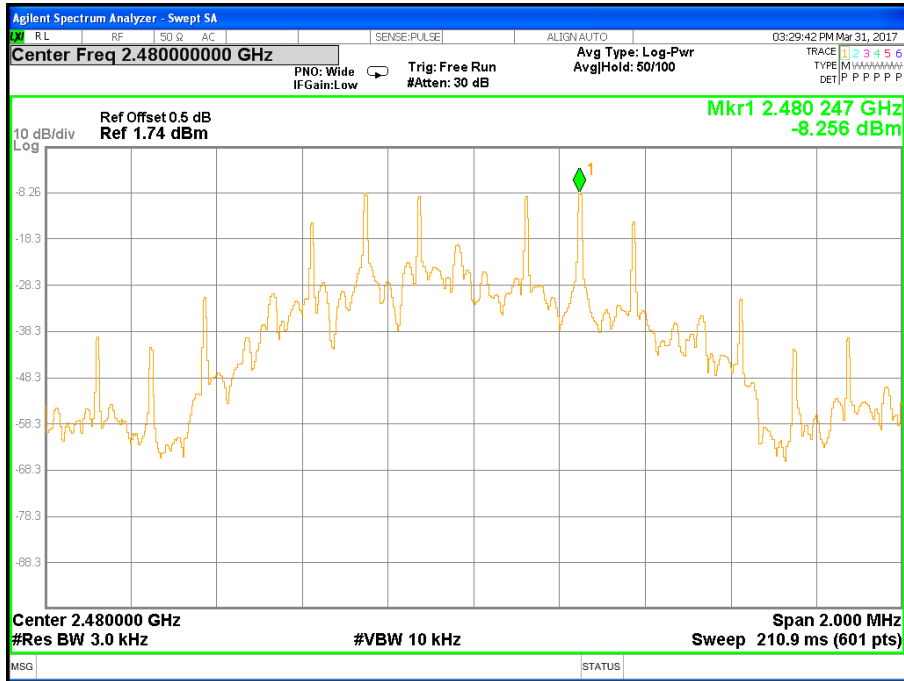

7. BANDWIDTH TEST

7.1 APPLIED PROCEDURES / LIMIT

| FCC Part 15.247,Subpart C | | | | |
|---------------------------|-----------|---|-----------------------|--------|
| Section | Test Item | Limit | Frequency Range (MHz) | Result |
| 15.247(a)(2) | Bandwidth | $\geq 500\text{KHz}$ (6dB bandwidth) | 2400-2483.5 | PASS |

7.2 TEST PROCEDURE

The automatic bandwidth measurement capability of an instrument may be employed using the X dB bandwidth mode with X set to 6 dB, if the functionality described above (i.e., RBW = 100 kHz, VBW \geq RBW, peak detector with maximum hold) is implemented by the instrumentation function. When using this capability, care shall be taken so that the bandwidth measurement is not influenced by any intermediate power nulls in the fundamental emission that might be \geq 8 dB.

7.3 TEST SETUP

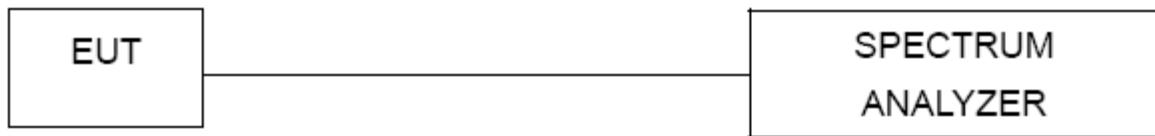

7.4 EUT OPERATION CONDITIONS

The EUT tested system was configured as the statements of 2.3 Unless otherwise a special operating condition is specified in the follows during the testing.

7.5 TEST RESULTS

| | | | |
|--------------|---------------------------|--------------------|---------|
| Temperature: | 25 °C | Relative Humidity: | 60% |
| Pressure: | 1012 hPa | Test Voltage: | DC 3.7V |
| Test Mode: | TX Mode /CH01, CH20, CH40 | | |

| Frequency | 6dB Bandwidth (MHz) | Channel Separation (MHz) | Result |
|-----------|---------------------|--------------------------|--------|
| 2402 MHz | 0.642 | >=500KHz | PASS |
| 2440 MHz | 0.639 | >=500KHz | PASS |
| 2480 MHz | 0.646 | >=500KHz | PASS |

TX CH 01

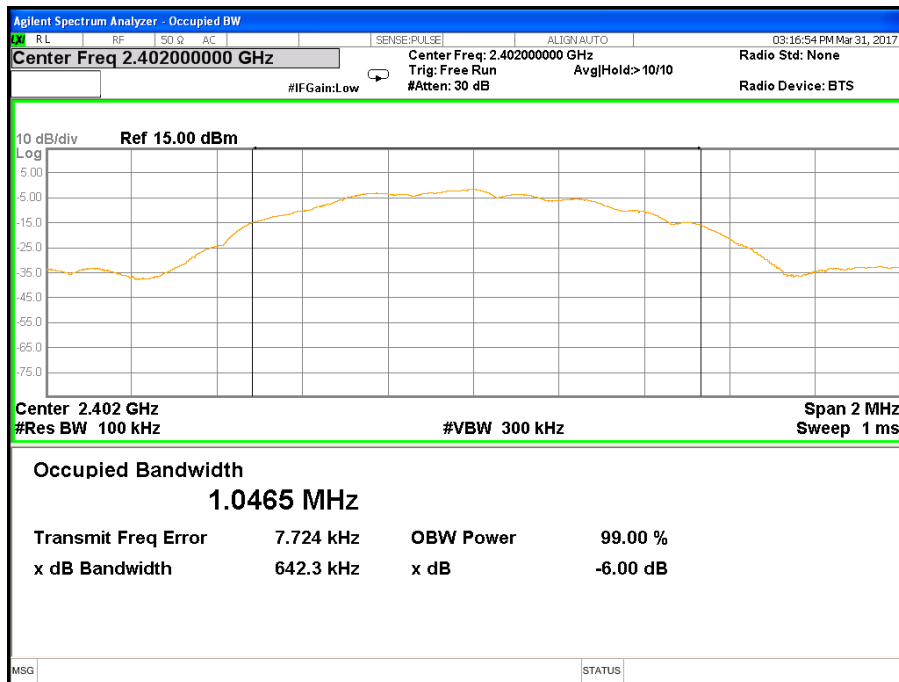

TX CH 20

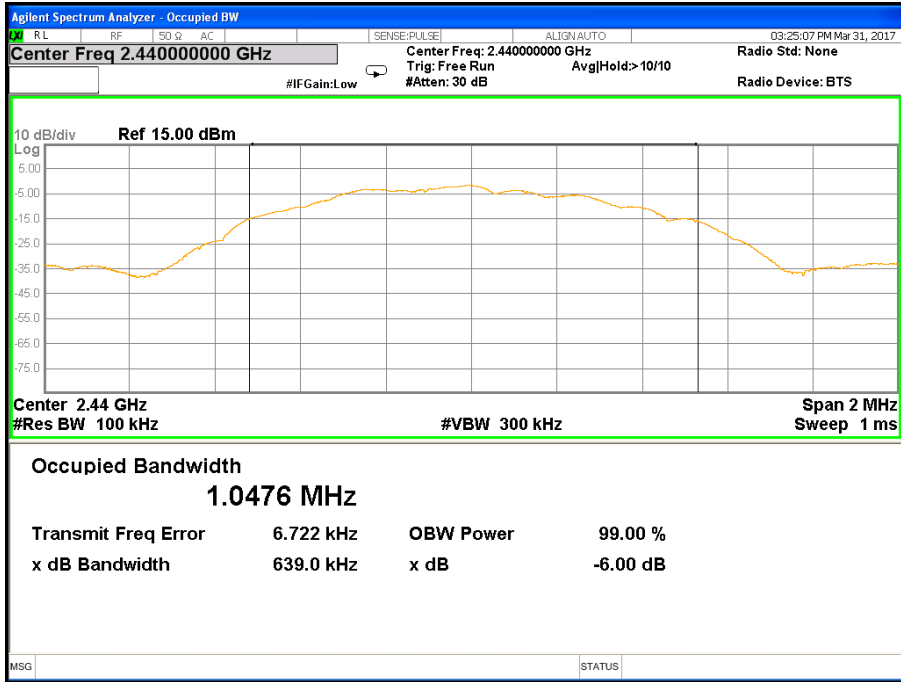

TX CH 40

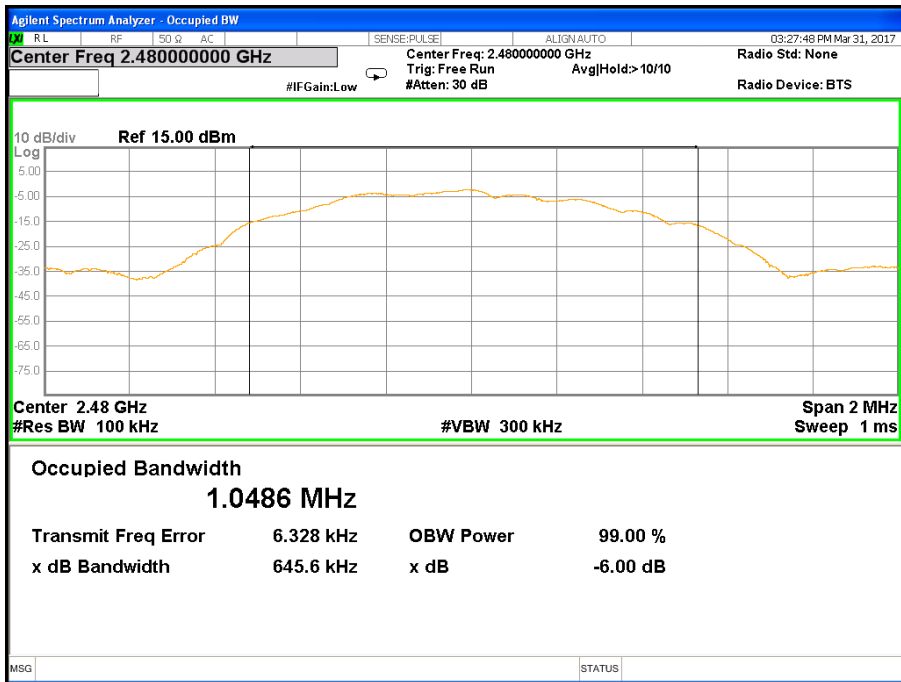

8. PEAK OUTPUT POWER TEST

8.1 APPLIED PROCEDURES / LIMIT

| FCC Part 15.247, Subpart C | | | | |
|----------------------------|--------------|-----------------|-----------------------|--------|
| Section | Test Item | Limit | Frequency Range (MHz) | Result |
| 15.247(b)(3) | Output Power | 1 watt or 30dBm | 2400-2483.5 | PASS |

8.2 TEST PROCEDURE

- a. The EUT was directly connected to the Power Sensor&PC

8.3 TEST SETUP



8.4 EUT OPERATION CONDITIONS

The EUT tested system was configured as the statements of 2.3 Unless otherwise a special operating condition is specified in the follows during the testing.

8.5 TEST RESULTS

| | | | |
|--------------|---------------------------|--------------------|---------|
| Temperature: | 25 °C | Relative Humidity: | 60% |
| Pressure: | 1012 hPa | Test Voltage: | DC 3.7V |
| Test Mode: | TX Mode /CH01, CH20, CH40 | | |

| TX Mode | | | | |
|--------------|-----------|------------------------|-----------|-------|
| Test Channel | Frequency | Conducted Output Power | | LIMIT |
| | (MHz) | Peak (dBm) | AVG (dBm) | dBm |
| CH01 | 2402 | 0.74 | -1.52 | 30 |
| CH20 | 2440 | 0.72 | -1.54 | 30 |
| CH40 | 2480 | 0.43 | -1.81 | 30 |

9. ANTENNA REQUIREMENT

9.1 STANDARD REQUIREMENT

15.203 requirement: For intentional device, according to 15.203: an intentional radiator shall be designed to ensure that no antenna other than that furnished by the responsible party shall be used with the device.

9.2 EUT ANTENNA

The EUT antenna is Internal PIFA Antenna. It comply with the standard requirement.

10. EUT TEST PHOTO

Radiated Measurement Photos

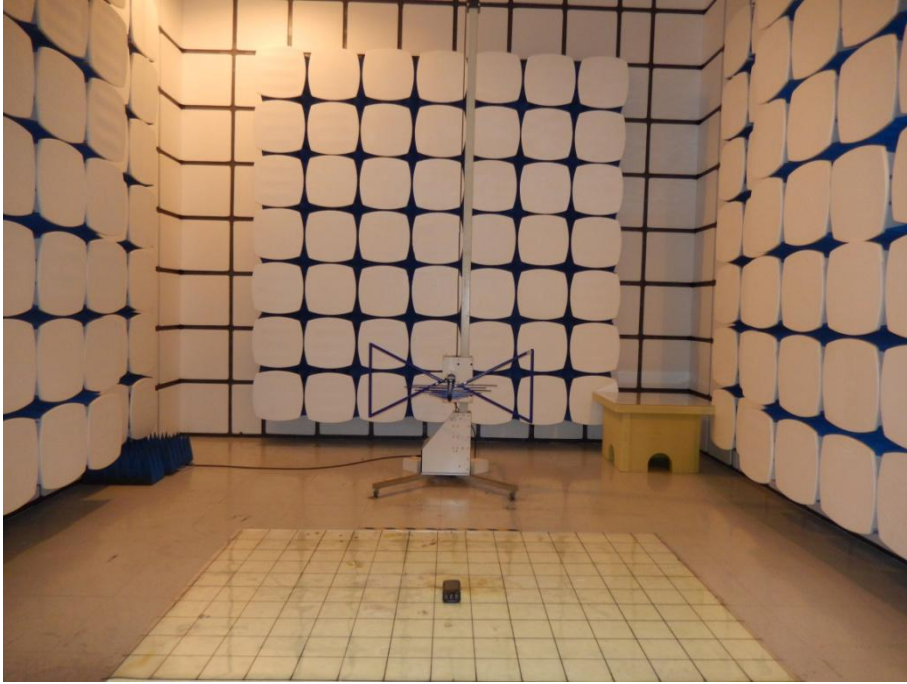

Conducted Measurement Photos

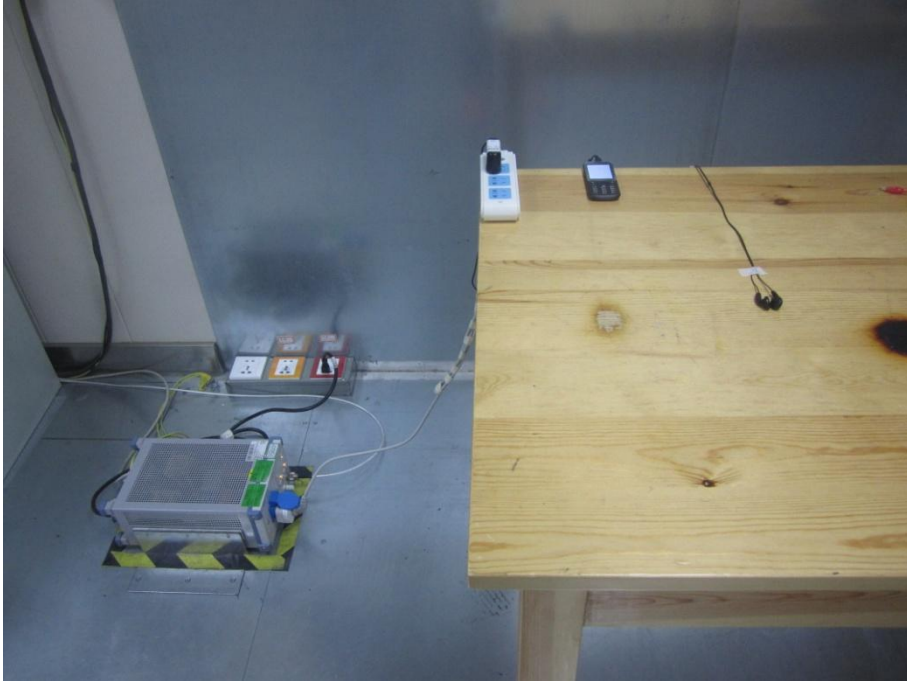

*****END OF THE REPORT*****