

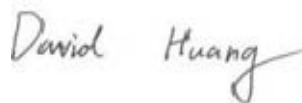

RF TEST REPORT



Report No.: 16070816-FCC-R4

Supersede Report No.: N/A

Applicant	MOBIWIRE MOBILES (NINGBO) CO.,LTD	
Product Name	4G LTE SMARTPHONE	
Model No.	N551	
Serial No.	N/A	
Test Standard	FCC Part 15.247: 2015, ANSI C63.10: 2013	
Test Date	July 19 to August 14, 2016	
Issue Date	August 15, 2016	
Test Result	<input checked="" type="checkbox"/> Pass <input type="checkbox"/> Fail	
Equipment complied with the specification	<input checked="" type="checkbox"/>	
Equipment did not comply with the specification	<input type="checkbox"/>	
		
Loren Luo Test Engineer	David Huang Checked By	
This test report may be reproduced in full only Test result presented in this test report is applicable to the tested sample only		

Issued by:

SIEMIC (SHENZHEN-CHINA) LABORATORIES

Zone A, Floor 1, Building 2 Wan Ye Long Technology Park

South Side of Zhoushi Road, Bao' an District, Shenzhen, Guangdong China 518108

Phone: +86 0755 2601 4629801 Email: China@siemic.com.cn

Laboratories Introduction

SIEMIC, headquartered in the heart of Silicon Valley, with superior facilities in US and Asia, is one of the leading independent testing and certification facilities providing customers with one-stop shop services for Compliance Testing and Global Certifications.



In addition to testing and certification, SIEMIC provides initial design reviews and compliance management throughout a project. Our extensive experience with China, Asia Pacific, North America, European, and International compliance requirements, assures the fastest, most cost effective way to attain regulatory compliance for the global markets.

Accreditations for Conformity Assessment

Country/Region	Scope
USA	EMC, RF/Wireless, SAR, Telecom
Canada	EMC, RF/Wireless, SAR, Telecom
Taiwan	EMC, RF, Telecom, SAR, Safety
Hong Kong	RF/Wireless, SAR, Telecom
Australia	EMC, RF, Telecom, SAR, Safety
Korea	EMI, EMS, RF, SAR, Telecom, Safety
Japan	EMI, RF/Wireless, SAR, Telecom
Singapore	EMC, RF, SAR, Telecom
Europe	EMC, RF, SAR, Telecom, Safety

Test Report No.	16070816-FCC-R4
Page	3 of 44

This page has been left blank intentionally.

CONTENTS

1. REPORT REVISION HISTORY	5
2. CUSTOMER INFORMATION	5
3. TEST SITE INFORMATION.....	5
4. EQUIPMENT UNDER TEST (EUT) INFORMATION.....	6
5. TEST SUMMARY.....	9
6. MEASUREMENTS, EXAMINATION AND DERIVED RESULTS	10
6.1 ANTENNA REQUIREMENT.....	10
6.2 DTS (6 DB) CHANNEL BANDWIDTH	11
6.3 MAXIMUM OUTPUT POWER	13
6.4 POWER SPECTRAL DENSITY.....	15
6.5 BAND-EDGE & UNWANTED EMISSIONS INTO RESTRICTED FREQUENCY BANDS	17
6.6 AC POWER LINE CONDUCTED EMISSIONS.....	20
6.7 RADIATED SPURIOUS EMISSIONS & RESTRICTED BAND	26
ANNEX A. TEST INSTRUMENT.....	32
ANNEX B. EUT AND TEST SETUP PHOTOGRAPHS.....	33
ANNEX C. TEST SETUP AND SUPPORTING EQUIPMENT.....	39
ANNEX D. USER MANUAL / BLOCK DIAGRAM / SCHEMATICS / PARTLIST	43
ANNEX E. DECLARATION OF SIMILARITY.....	44

1. Report Revision History

Report No.	Report Version	Description	Issue Date
16070816-FCC-R4	NONE	Original	August 15, 2016

2. Customer information

Applicant Name	MOBIWIRE MOBILES (NINGBO) CO.,LTD
Applicant Add	No.999,Dacheng East Road,Fenghua City,Zhejiang
Manufacturer	MOBIWIRE MOBILES (NINGBO) CO.,LTD
Manufacturer Add	No.999,Dacheng East Road,Fenghua City,Zhejiang

3. Test site information

Lab performing tests	SIEMIC (Shenzhen-China) LABORATORIES
Lab Address	Zone A, Floor 1, Building 2 Wan Ye Long Technology Park South Side of Zhoushi Road, Bao' an District, Shenzhen, Guangdong China 518108
FCC Test Site No.	718246
IC Test Site No.	4842E-1
Test Software	Radiated Emission Program-To Shenzhen v2.0

4. Equipment under Test (EUT) Information

Description of EUT:	4G LTE SMARTPHONE
Main Model:	N551
Serial Model:	N/A
Date EUT received:	July 18, 2016
Test Date(s):	July 19 to August 14, 2016
Equipment Category :	DTS
Antenna Gain:	GSM850: -3dBi PCS1900: -1dBi UMTS-FDD Band V: -3dBi UMTS-FDD Band II:-1dBi LTE Band IV: -3dBi Bluetooth/BLE/WIFI: -1dBi GPS: -1dBi
Antenna Type:	PIFA antenna
Type of Modulation:	GSM / GPRS: GMSK EGPRS: GMSK,8PSK UMTS-FDD: QPSK LTE Band: QPSK, 16QAM 802.11b/g/n: DSSS, OFDM Bluetooth: GFSK, π /4DQPSK, 8DPSK BLE: GFSK GPS:BPSK

Test Report No.	16070816-FCC-R4
Page	7 of 44

	GSM850 TX: 824.2 ~ 848.8 MHz; RX: 869.2 ~ 893.8 MHz PCS1900 TX: 1850.2 ~ 1909.8 MHz; RX: 1930.2 ~ 1989.8 MHz UMTS-FDD Band V TX: 826.4 ~ 846.6 MHz; RX: 871.4 ~ 891.6 MHz UMTS-FDD Band II TX: 1852.4 ~ 1907.6 MHz; RX: 1932.4 ~ 1987.6 MHz
RF Operating Frequency (ies):	LTE Band IV TX: 1712.5 ~ 1752.5 MHz; RX : 2112.5 ~ 2152.5 MHz WIFI: 802.11b/g/n(20M): 2412-2462 MHz WIFI: 802.11n(40M): 2422-2452 MHz Bluetooth& BLE: 2402-2480 MHz GPS: 1575.42 MHz
Max. Output Power:	-1.961dBm
Number of Channels:	GSM 850: 124CH PCS1900: 299CH UMTS-FDD Band V: 102CH UMTS-FDD Band II: 277CH WIFI :802.11b/g/n(20M): 11CH WIFI :802.11n(40M): 7CH Bluetooth: 79CH BLE: 40CH GPS:1CH
Port:	Power Port, Earphone Port, USB Port
Trade Name :	Noblex
Input Power:	Adapter: Model: S005UA0500100 Input: AC100-240V~50/60Hz,150mA Output: DC 5.0V,1000mA Battery: Spec: 3.8V,3000mAh(11.4Wh)
GPRS/EGPRS Multi-slot class:	8/10/12

Test Report No.	16070816-FCC-R4
Page	8 of 44

FCC ID:

2ADA4N551

5. Test Summary

The product was tested in accordance with the following specifications.

All testing has been performed according to below product classification:

FCC Rules	Description of Test	Result
§15.203	Antenna Requirement	Compliance
§15.247 (a)(2)	DTS (6 dB) CHANNEL BANDWIDTH	Compliance
§15.247(b)(3)	Conducted Maximum Output Power	Compliance
§15.247(e)	Power Spectral Density	Compliance
§15.247(d)	Band-Edge & Unwanted Emissions into Restricted Frequency Bands	Compliance
§15.207 (a),	AC Power Line Conducted Emissions	Compliance
§15.205, §15.209, §15.247(d)	Radiated Spurious Emissions & Unwanted Emissions into Restricted Frequency Bands	Compliance

Measurement Uncertainty

Emissions		
Test Item	Description	Uncertainty
Band Edge and Radiated Spurious Emissions	Confidence level of approximately 95% (in the case where distributions are normal), with a coverage factor of 2 (for EUTs < 0.5m X 0.5m X 0.5m)	+5.6dB/-4.5dB
-	-	-

6. Measurements, Examination And Derived Results

6.1 Antenna Requirement

Applicable Standard

According to § 15.203, an intentional radiator shall be designed to ensure that no antenna other than that furnished by the responsible party shall be used with the device. The use of a permanently attached antenna or of an antenna that uses a unique coupling to the intentional radiator shall be considered sufficient to comply with the provisions of this section. The manufacturer may design the unit so that a broken antenna can be replaced by the user, but the user of a standard antenna jack or electrical connector is prohibited. The structure and application of the EUT were analyzed to determine compliance with section §15.203 of the rules. §15.203 state that the subject device must meet the following criteria:

- a. Antenna must be permanently attached to the unit.
- b. Antenna must use a unique type of connector to attach to the EUT.

Unit must be professionally installed, and installer shall be responsible for verifying that the correct antenna is employed with the unit.

And according to FCC 47 CFR section 15.247 (b), if the transmitting antennas of directional gain greater than 6dBi are used, the power shall be reduced by the amount in dB that the directional gain of the antenna exceeds 6 dBi.

Antenna Connector Construction

The EUT has 3 antennas:

A permanently attached PIFA antenna for Bluetooth/BLE/WIFI/GPS, the gain is -1dBi for Bluetooth/BLE/WIFI/GPS.

A permanently attached PIFA antenna for GSM/PCS/UMTS, the gain is -3dBi for GSM850, -1dBi for PCS1900, -3dBi for UMTS-FDD Band V, -1dBi for UMTS-FDD Band II.

A permanently attached PIFA antenna for LTE Band IV, the gain is -3dBi for LTE Band IV.

The antenna meets up with the ANTENNA REQUIREMENT.

Result: Compliance.

6.2 DTS (6 dB) Channel Bandwidth

Temperature	25°C
Relative Humidity	52%
Atmospheric Pressure	1028mbar
Test date :	July 28, 2016
Tested By :	Loren Luo

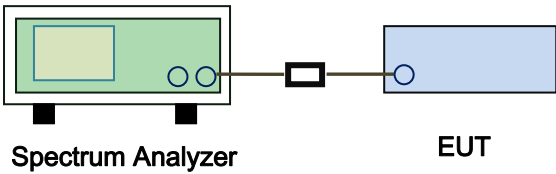
Spec	Item	Requirement	Applicable
§ 15.247(a)(2)	a)	6dB BW ≥ 500kHz;	<input checked="" type="checkbox"/>
RSS Gen(4.6.1)	b)	99% BW: For FCC reference only; required by IC.	<input checked="" type="checkbox"/>
Test Setup	 <p style="text-align: center;">Spectrum Analyzer EUT</p>		
Test Procedure	<p>558074 D01 DTS MEAS Guidance v03r03, 8.1 DTS bandwidth <u>6dB Emission bandwidth measurement procedure</u></p> <ul style="list-style-type: none"> - Set RBW = 100 kHz. - Set the video bandwidth (VBW) ≥ 3 RBW. - Detector = Peak. - Trace mode = max hold. - Sweep = auto couple. - Allow the trace to stabilize. <p>Measure the maximum width of the emission that is constrained by the frequencies associated with the two outermost amplitude points (upper and lower frequencies) that are attenuated by 6 dB relative to the maximum level measured in the fundamental emission.</p>		
Remark			
Result	<input checked="" type="checkbox"/> Pass <input type="checkbox"/> Fail		

Test Data Yes N/A

Test Plot Yes (See below) N/A

6dB Bandwidth measurement result

Test Data

CH	Frequency (MHz)	6dB Bandwidth (kHz)	99% Occupied Bandwidth (MHz)
Low	2402	694.3	1.0398
Mid	2440	695.2	1.0344
High	2480	691.2	1.0356

Test Plots

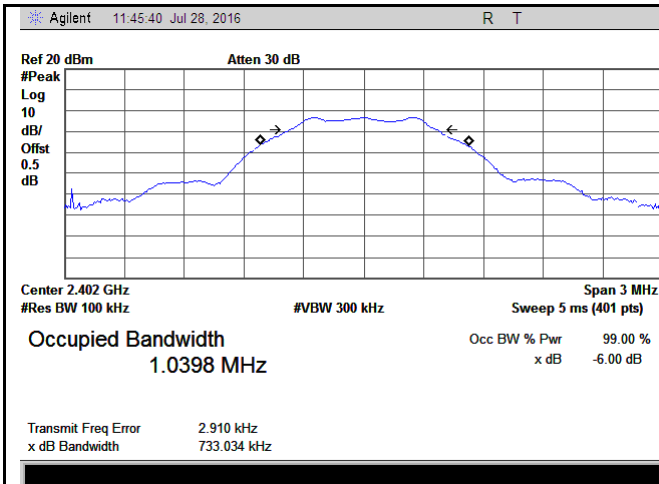

6dB Bandwidth - Low CH 2402

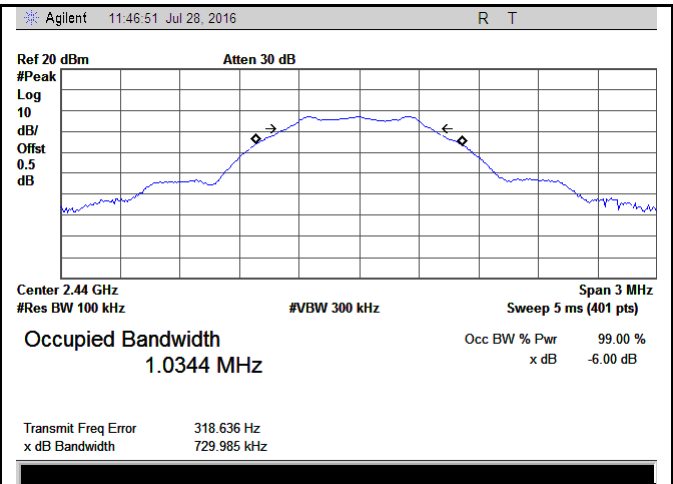

6dB Bandwidth - Mid CH 2440

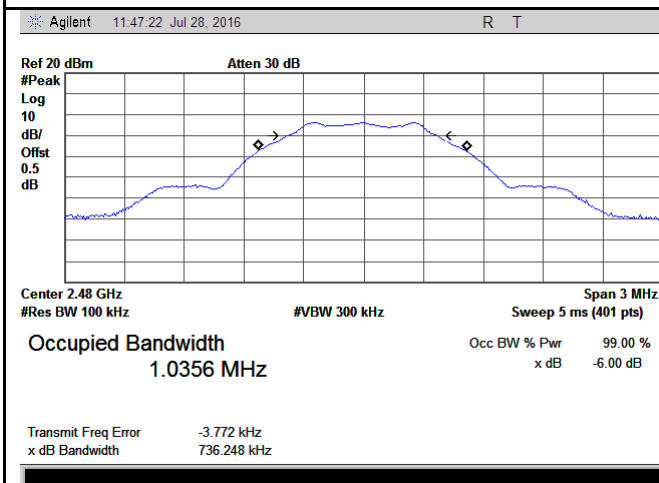

6dB Bandwidth - High CH 2480

6.3 Maximum Output Power

Temperature	25°C
Relative Humidity	52%
Atmospheric Pressure	1028mbar
Test date :	July 28, 2016
Tested By :	Loren Luo

Requirement(s):

Spec	Item	Requirement	Applicable
§15.247(b) (3),RSS210 (A8.4)	a)	FHSS in 2400-2483.5MHz with ≥ 75 channels: ≤ 1 Watt	<input type="checkbox"/>
	b)	FHSS in 5725-5850MHz: ≤ 1 Watt	<input type="checkbox"/>
	c)	For all other FHSS in the 2400-2483.5MHz band: ≤ 0.125 Watt.	<input type="checkbox"/>
	d)	FHSS in 902-928MHz with ≥ 50 channels: ≤ 1 Watt	<input type="checkbox"/>
	e)	FHSS in 902-928MHz with ≥ 25 & <50 channels: ≤ 0.25 Watt	<input type="checkbox"/>
	f)	DTS in 902-928MHz, 2400-2483.5MHz: ≤ 1 Watt	<input checked="" type="checkbox"/>

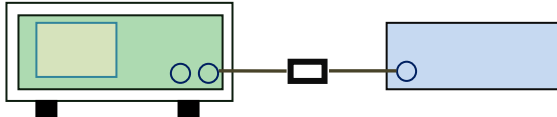
Test Setup	 <p style="text-align: center;">Spectrum Analyzer EUT</p>
------------	--

Test Procedure	<p>558074 D01 DTS MEAS Guidance v03r03, 9.1.2 Integrated band power method Maximum output power measurement procedure</p> <ol style="list-style-type: none"> Set the RBW \geq DTS bandwidth. Set VBW $\geq 3 \times$ RBW. Set span $\geq 3 \times$ RBW Sweep time = auto couple. Detector = peak. Trace mode = max hold. Allow trace to fully stabilize. Use peak marker function to determine the peak amplitude level.
----------------	---

Remark	
--------	--

Result	<input checked="" type="checkbox"/> Pass <input type="checkbox"/> Fail
--------	--

Test Data Yes N/A
 Test Plot Yes (See below) N/A

Output Power measurement result

Test Data

Type	CH	Frequency (MHz)	Conducted Power (dBm)	Limit (dBm)	Result
Output power	Low	2402	-2.452	30	Pass
	Mid	2440	-1.961	30	Pass
	High	2480	-2.855	30	Pass

Test Plots

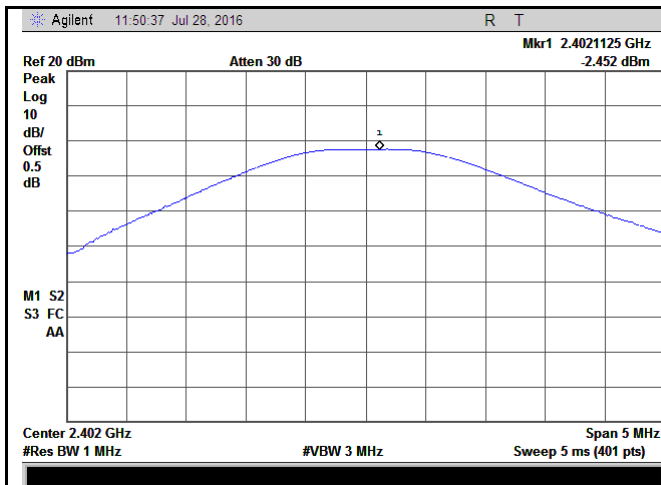

AV Output power - Low CH 2402

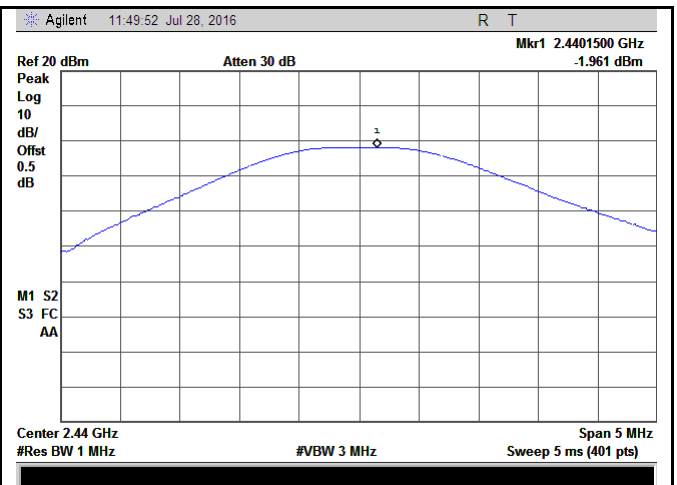

AV Output power - Mid CH 2440

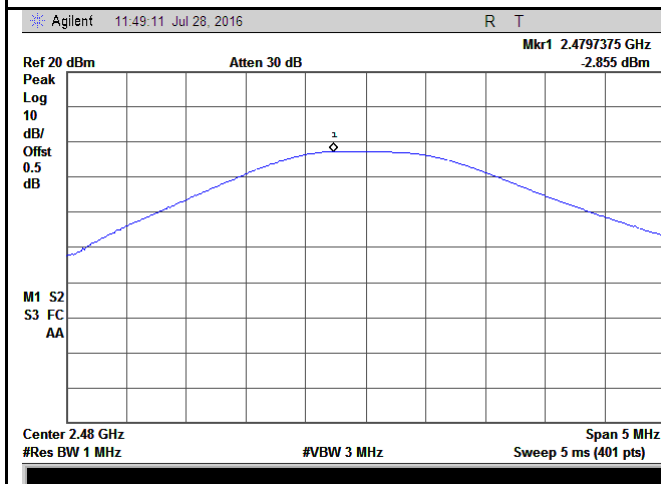

AV Output power - High CH 2480

6.4 Power Spectral Density

Temperature	25°C
Relative Humidity	52%
Atmospheric Pressure	1028mbar
Test date :	July 28, 2016
Tested By :	Loren Luo

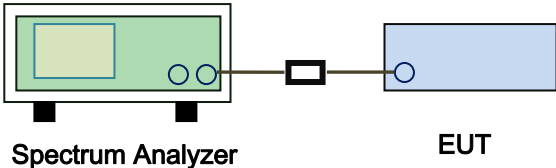
Spec	Item	Requirement	Applicable
§15.247(e)	a)	The power spectral density conducted from the intentional radiator to the antenna shall not be greater than 8 dBm in any 3 kHz band during any time interval of continuous transmission.	<input checked="" type="checkbox"/>
Test Setup	 <p style="text-align: center;">Spectrum Analyzer EUT</p>		
Test Procedure	<p>558074 D01 DTS MEAS Guidance v03r03, 10.2 power spectral density method power spectral density measurement procedure</p> <ul style="list-style-type: none"> - a) Set analyzer center frequency to DTS channel center frequency. - b) Set the span to 1.5 times the DTS bandwidth. - c) Set the RBW to: 3 kHz ≤ RBW ≤ 100 kHz. - d) Set the VBW ≥ 3 × RBW. - e) Detector = peak. - f) Sweep time = auto couple. - g) Trace mode = max hold. - h) Allow trace to fully stabilize. - i) Use the peak marker function to determine the maximum amplitude level within the RBW. - j) If measured value exceeds limit, reduce RBW (no less than 3 kHz) and repeat. 		
Remark			
Result	<input checked="" type="checkbox"/> Pass <input type="checkbox"/> Fail		

Test Data Yes N/A
 Test Plot Yes (See below) N/A

Power Spectral Density measurement result

Test Data

Type	CH	Freq (MHz)	Reading (dBm)	Factor (dB)	Result (dBm)	Limit (dBm)	Result
PSD	Low	2402	-11.72	-5.23	-16.95	8	Pass
	Mid	2440	-11.19	-5.23	-16.42	8	Pass
	High	2480	-12.15	-5.23	-17.38	8	Pass

Note: factor=10log(3/10)=-5.23

Test Plots

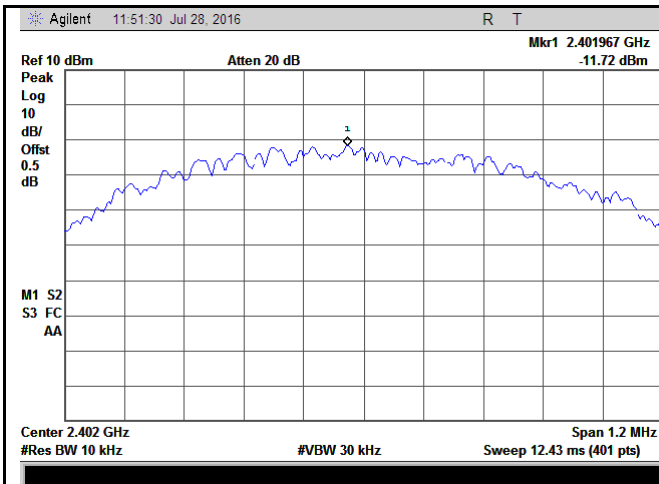

PSD - Low CH 2402

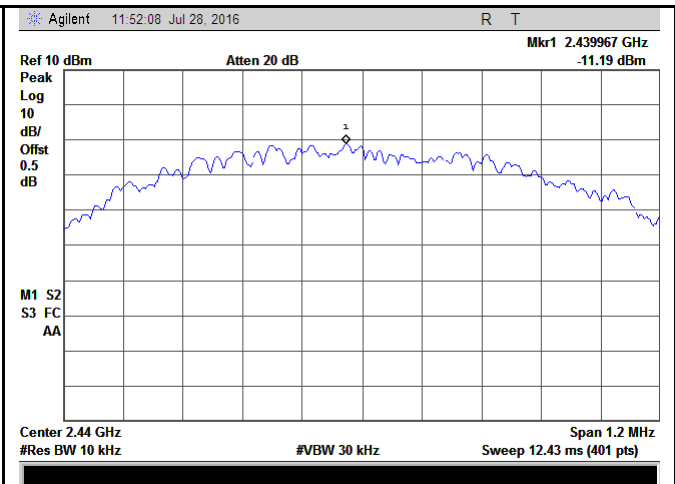

PSD - Mid CH 2440

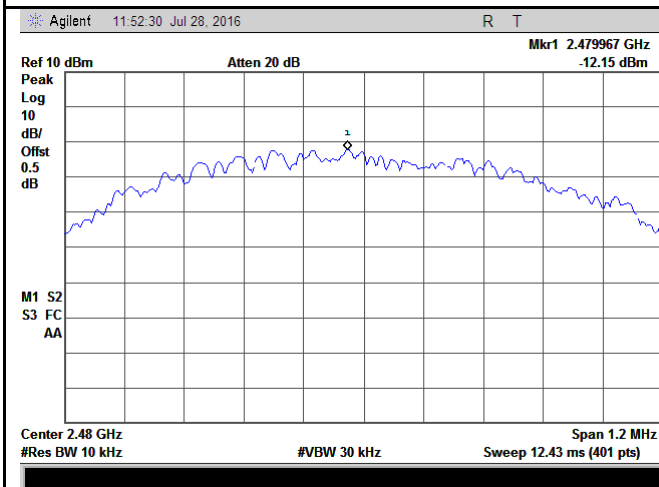

PSD - High CH 2480

6.5 Band-Edge & Unwanted Emissions into Restricted Frequency Bands

Temperature	22°C
Relative Humidity	53%
Atmospheric Pressure	1029mbar
Test date :	July 29, 2016
Tested By :	Loren Luo

Requirement(s):

Spec	Item	Requirement	Applicable
§15.247(d)	a)	In any 100 kHz bandwidth outside the frequency band in which the spread spectrum or digitally modulated intentional radiator is operating, the radio frequency power that is produced by the intentional radiator shall be at least 20 dB below that in the 100 kHz bandwidth within the band that contains the highest level of the desired power, based on either an RF conducted or a radiated measurement, provided the transmitter demonstrates compliance with the peak conducted power limits.	<input checked="" type="checkbox"/>

Test Setup	
------------	--

Test Procedure	<p>Radiated Method Only</p> <ul style="list-style-type: none"> - 1. Check the calibration of the measuring instrument using either an internal calibrator or a known signal from an external generator. - 2. Position the EUT without connection to measurement instrument. Put it on the Rotated table and turn on the EUT and make it operate in transmitting mode. Then set it to Low Channel and High Channel within its operating range, and make sure the instrument is operated in its linear range.
----------------	---

Test Report No.	16070816-FCC-R4
Page	18 of 44

	<ul style="list-style-type: none"> - 3. First, set both RBW and VBW of spectrum analyzer to 100 kHz with a convenient frequency span including 100kHz bandwidth from band edge, check the emission of EUT, if pass then set Spectrum Analyzer as below: <ul style="list-style-type: none"> a. The resolution bandwidth and video bandwidth of test receiver/spectrum analyzer is 120 kHz for Quasiy Peak detection at frequency below 1GHz. b. The resolution bandwidth of test receiver/spectrum analyzer is 1MHz and video bandwidth is 3MHz with Peak detection for Peak measurement at frequency above 1GHz. c. The resolution bandwidth of test receiver/spectrum analyzer is 1MHz and the video bandwidth is 10Hz with Peak detection for Average Measurement as below at frequency above 1GHz. - 4. Measure the highest amplitude appearing on spectral display and set it as a reference level. Plot the graph with marking the highest point and edge frequency. - 5. Repeat above procedures until all measured frequencies were complete.
Remark	
Result	<input checked="" type="checkbox"/> Pass <input type="checkbox"/> Fail

Test Data Yes N/A
 Test Plot Yes (See below) N/A

Test Plots

Band Edge measurement result

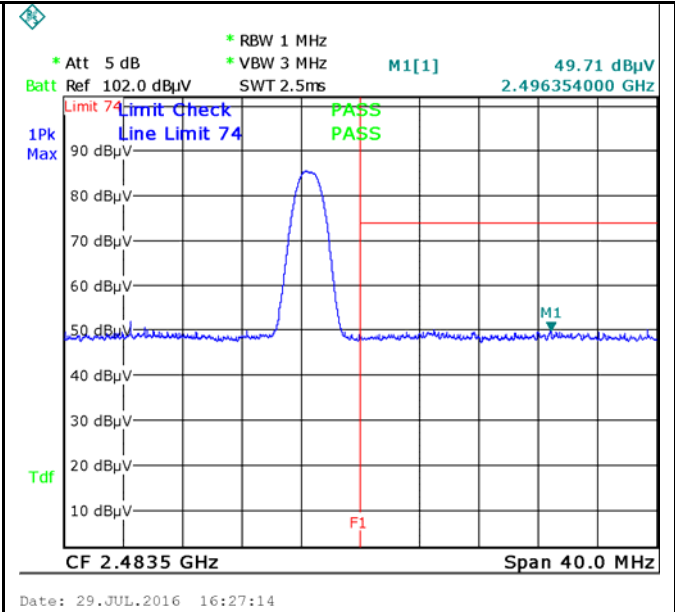
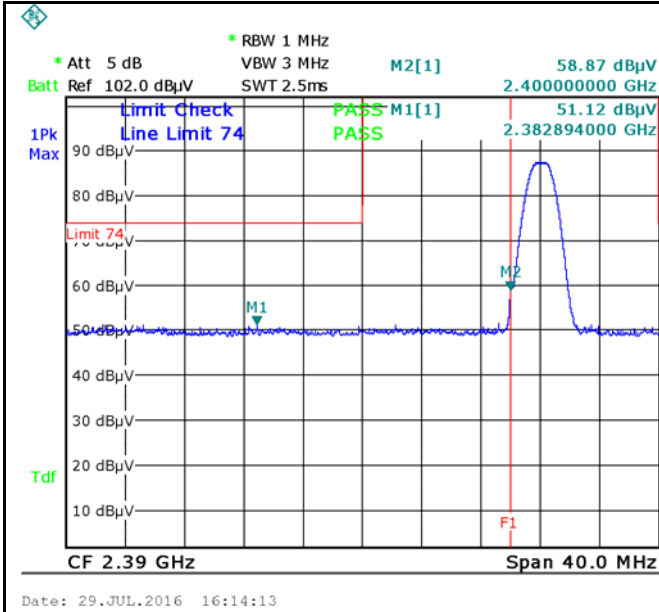

Band Edge, Left Side (Peak)

Note: F1 is frequency 2390MHz; F2 is frequency 2400MHz

Band Edge, Right Side (Peak)

Note: F1 is frequency 2483.5MHz

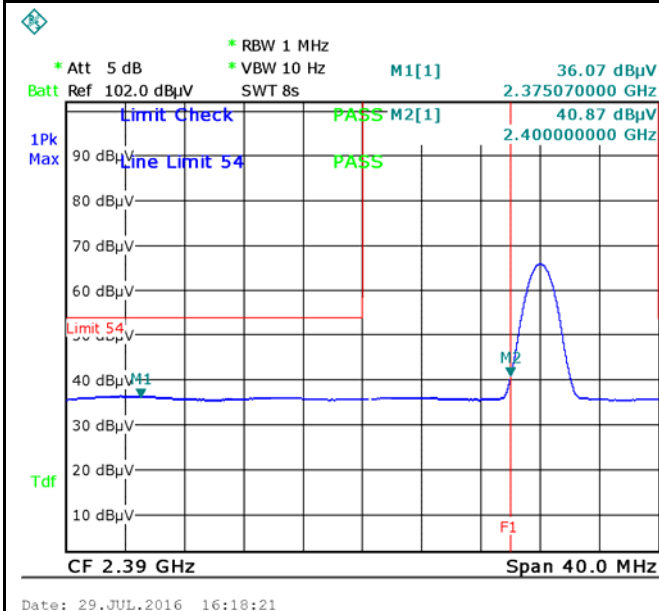

Note: (no need if PK value less than the AV limit)

Band Edge, Left Side-AV

Band Edge, Right Side-AV

6.6 AC Power Line Conducted Emissions

Temperature	22°C
Relative Humidity	53%
Atmospheric Pressure	1029mbar
Test date :	July 29, 2016
Tested By :	Loren Luo

Requirement(s):

Spec	Item	Requirement	Applicable														
47CFR§15.207, RSS210 (A8.1)	a)	For Low-power radio-frequency devices that is designed to be connected to the public utility (AC) power line, the radio frequency voltage that is conducted back onto the AC power line on any frequency or frequencies, within the band 150 kHz to 30 MHz, shall not exceed the limits in the following table, as measured using a 50 [μ] H/50 ohms line impedance stabilization network (LISN). The lower limit applies at the boundary between the frequencies ranges.	<input checked="" type="checkbox"/>														
		<table border="1"> <thead> <tr> <th rowspan="2">Frequency ranges (MHz)</th> <th colspan="2">Limit (dBμV)</th> </tr> <tr> <th>QP</th> <th>Average</th> </tr> </thead> <tbody> <tr> <td>0.15 ~ 0.5</td> <td>66 – 56</td> <td>56 – 46</td> </tr> <tr> <td>0.5 ~ 5</td> <td>56</td> <td>46</td> </tr> <tr> <td>5 ~ 30</td> <td>60</td> <td>50</td> </tr> </tbody> </table>		Frequency ranges (MHz)	Limit (dBμV)		QP	Average	0.15 ~ 0.5	66 – 56	56 – 46	0.5 ~ 5	56	46	5 ~ 30	60	50
		Frequency ranges (MHz)			Limit (dBμV)												
				QP	Average												
		0.15 ~ 0.5		66 – 56	56 – 46												
0.5 ~ 5	56	46															
5 ~ 30	60	50															

Test Setup	<p>Note: 1.Support units were connected to second LISN. 2.Both of LISNs (AMN) are 80cm from EUT and at least 80cm from other units and other metal planes support units.</p>
------------	--

Procedure	<ol style="list-style-type: none"> The EUT and supporting equipment were set up in accordance with the requirements of the standard on top of a 1.5m x 1m x 0.8m high, non-metallic table. The power supply for the EUT was fed through a 50W/50mH EUT LISN, connected to filtered mains. The RF OUT of the EUT LISN was connected to the EMI test receiver via a low-loss
-----------	---

Test Report No.	16070816-FCC-R4
Page	21 of 44

	<p>coaxial cable.</p> <ol style="list-style-type: none"> 4. All other supporting equipment were powered separately from another main supply. 5. The EUT was switched on and allowed to warm up to its normal operating condition. 6. A scan was made on the NEUTRAL line (for AC mains) or Earth line (for DC power) over the required frequency range using an EMI test receiver. 7. High peaks, relative to the limit line, The EMI test receiver was then tuned to the selected frequencies and the necessary measurements made with a receiver bandwidth setting of 10 kHz. 8. Step 7 was then repeated for the LIVE line (for AC mains) or DC line (for DC power).
Remark	
Result	<input checked="" type="checkbox"/> Pass <input type="checkbox"/> Fail

Test Data Yes N/A

Test Plot Yes (See below) N/A

Test Mode: Transmitting Mode

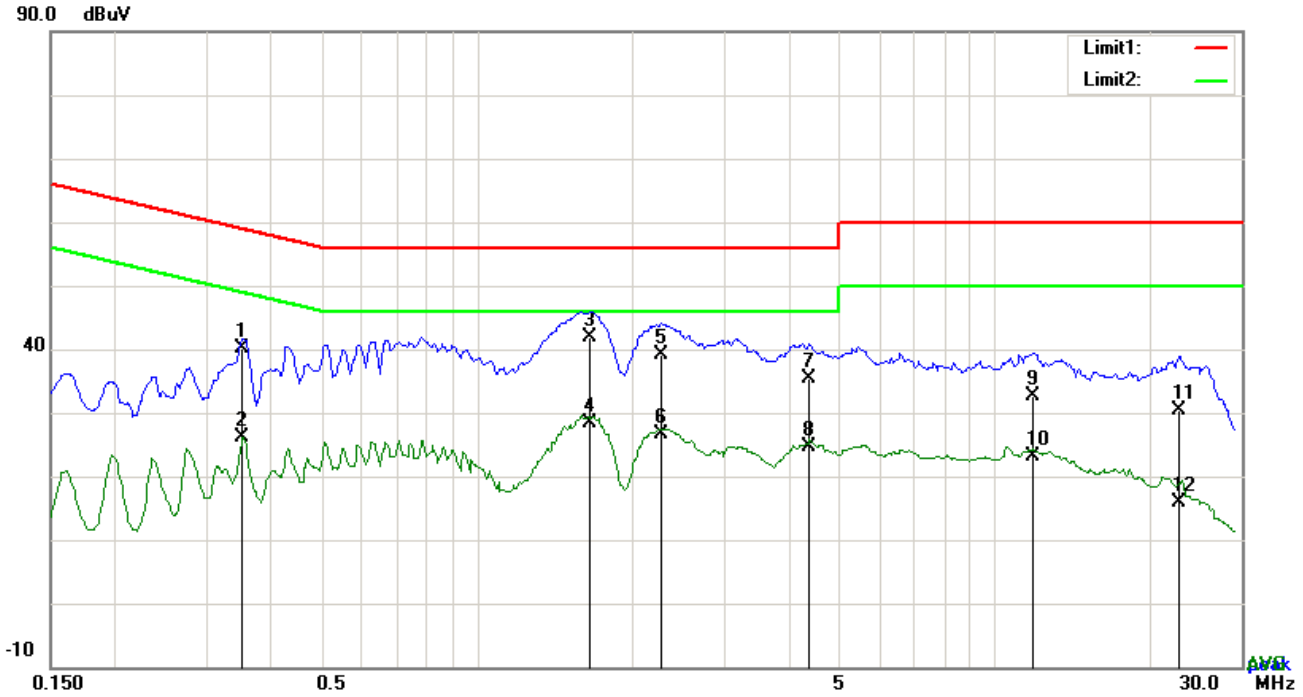

Test Data

Phase Line Plot at 120Vac, 60Hz

No.	P/L	Frequency (MHz)	Reading (dBµV)	Detector	Corrected (dB)	Result (dBµV)	Limit (dBµV)	Margin (dB)
1	L1	0.3528	30.15	QP	10.03	40.18	58.90	-18.72
2	L1	0.3528	15.98	AVG	10.03	26.01	48.90	-22.89
3	L1	1.6593	31.94	QP	10.04	41.98	56.00	-14.02
4	L1	1.6593	18.27	AVG	10.04	28.31	46.00	-17.69
5	L1	2.2716	29.16	QP	10.05	39.21	56.00	-16.79
6	L1	2.2716	16.69	AVG	10.05	26.74	46.00	-19.26
7	L1	4.3650	25.25	QP	10.07	35.32	56.00	-20.68
8	L1	4.3650	14.51	AVG	10.07	24.58	46.00	-21.42
9	L1	11.8920	22.47	QP	10.18	32.65	60.00	-27.35
10	L1	11.8920	13.04	AVG	10.18	23.22	50.00	-26.78
11	L1	22.7418	20.00	QP	10.35	30.35	60.00	-29.65
12	L1	22.7418	5.64	AVG	10.35	15.99	50.00	-34.01

Test Mode:	Transmitting Mode
-------------------	--------------------------

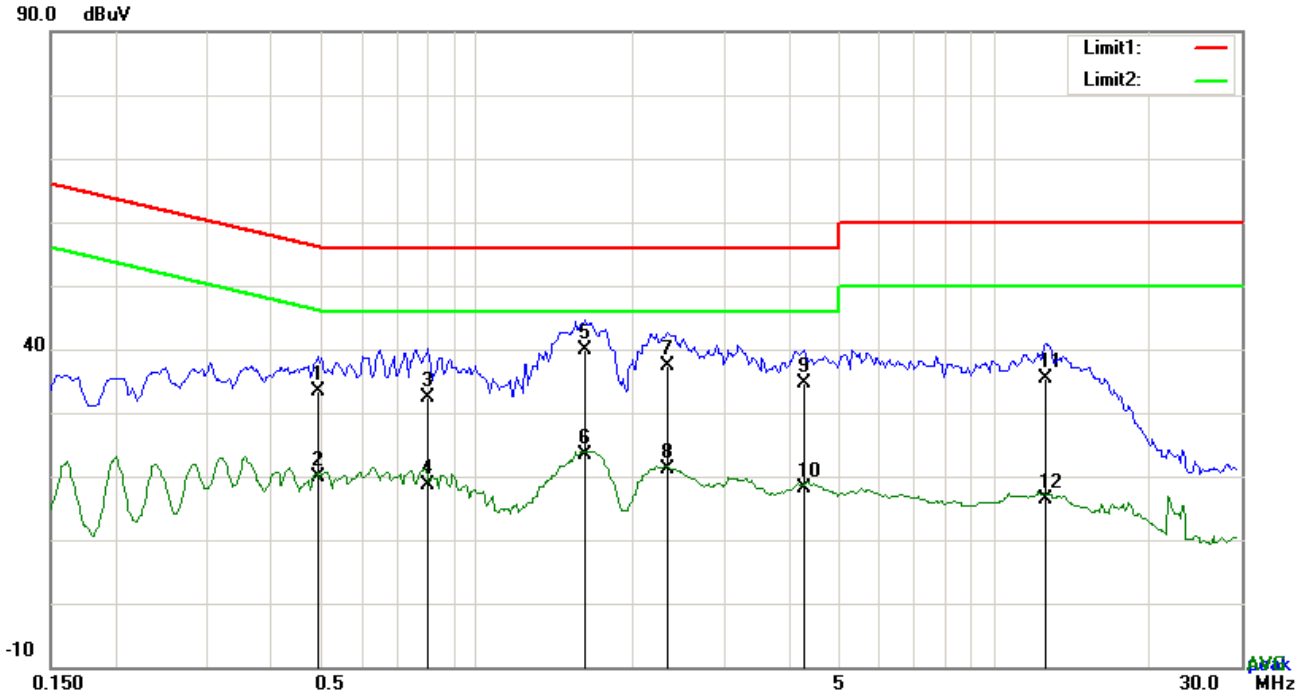

Test Data

Phase Neutral Plot at 120Vac, 60Hz

No.	P/L	Frequency (MHz)	Reading (dBµV)	Detector	Corrected (dB)	Result (dBµV)	Limit (dBµV)	Margin (dB)
1	N	0.4932	23.24	QP	10.02	33.26	56.11	-22.85
2	N	0.4932	9.98	AVG	10.02	20.00	46.11	-26.11
3	N	0.8052	22.28	QP	10.03	32.31	56.00	-23.69
4	N	0.8052	8.59	AVG	10.03	18.62	46.00	-27.38
5	N	1.6242	29.74	QP	10.04	39.78	56.00	-16.22
6	N	1.6242	13.34	AVG	10.04	23.38	46.00	-22.62
7	N	2.3379	27.22	QP	10.04	37.26	56.00	-18.74
8	N	2.3379	11.06	AVG	10.04	21.10	46.00	-24.90
9	N	4.2714	24.57	QP	10.06	34.63	56.00	-21.37
10	N	4.2714	8.03	AVG	10.06	18.09	46.00	-27.91
11	N	12.5394	25.33	QP	10.17	35.50	60.00	-24.50
12	N	12.5394	6.24	AVG	10.17	16.41	50.00	-33.59

Test Mode: Transmitting Mode

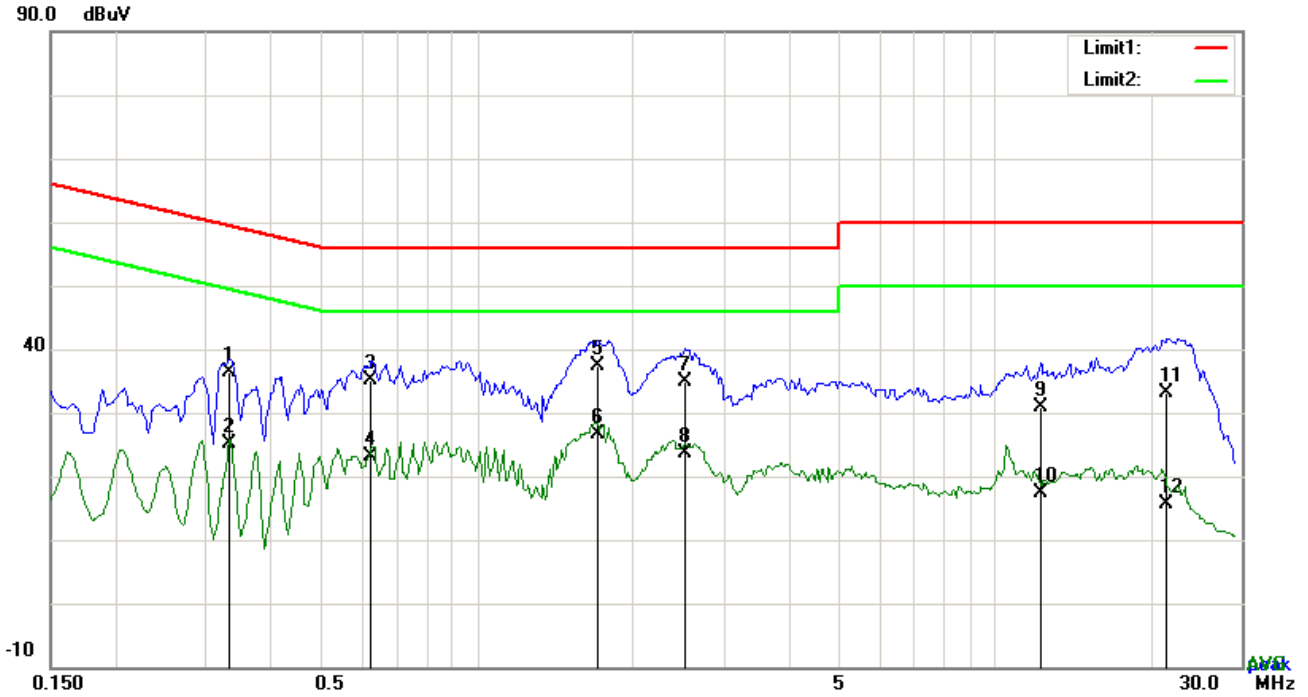

Test Data

Phase Line Plot at 240Vac, 60Hz

No.	P/L	Frequency (MHz)	Reading (dBμV)	Detector	Corrected (dB)	Result (dBμV)	Limit (dBμV)	Margin (dB)
1	L1	0.3333	26.28	QP	10.03	36.31	59.37	-23.06
2	L1	0.3333	15.19	AVG	10.03	25.22	49.37	-24.15
3	L1	0.6258	25.08	QP	10.03	35.11	56.00	-20.89
4	L1	0.6258	12.98	AVG	10.03	23.01	46.00	-22.99
5	L1	1.7100	27.38	QP	10.04	37.42	56.00	-18.58
6	L1	1.7100	16.54	AVG	10.04	26.58	46.00	-19.42
7	L1	2.5212	24.90	QP	10.05	34.95	56.00	-21.05
8	L1	2.5212	13.64	AVG	10.05	23.69	46.00	-22.31
9	L1	12.3093	20.69	QP	10.18	30.87	60.00	-29.13
10	L1	12.3093	7.09	AVG	10.18	17.27	50.00	-32.73
11	L1	21.5874	22.86	QP	10.33	33.19	60.00	-26.81
12	L1	21.5874	5.22	AVG	10.33	15.55	50.00	-34.45

Test Mode:	Transmitting Mode
-------------------	--------------------------

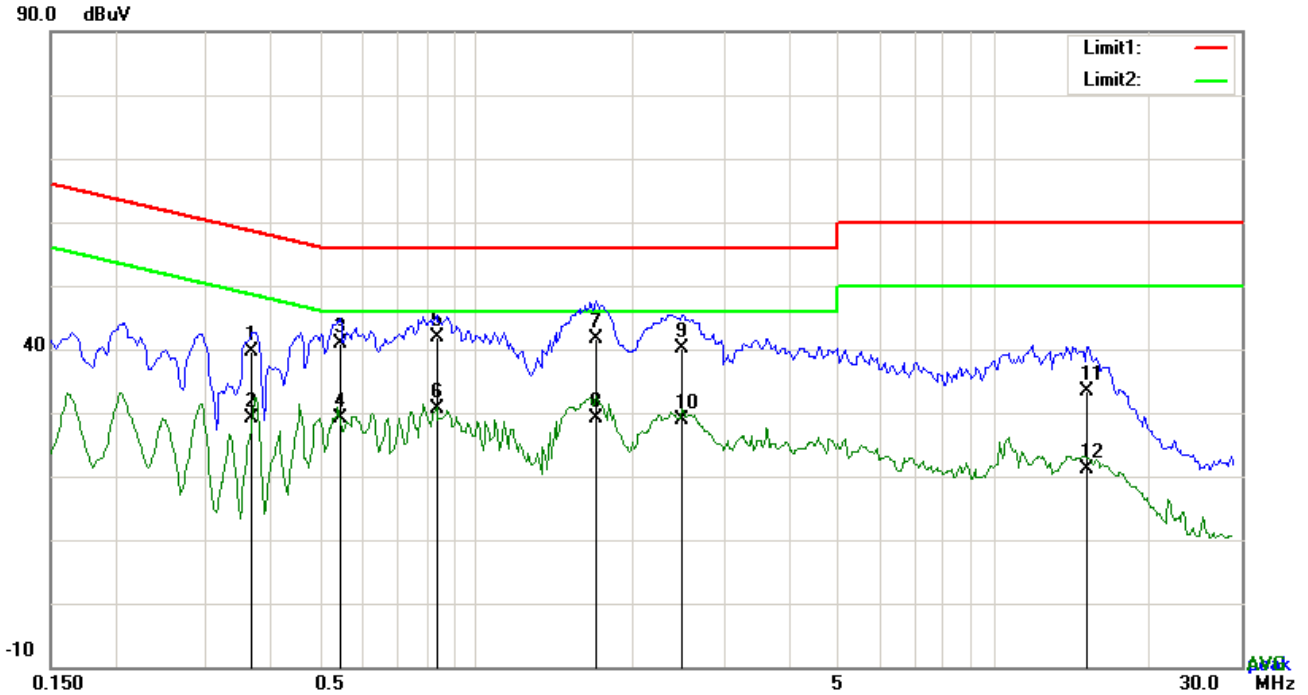

Test Data

Phase Neutral Plot at 240Vac, 60Hz

No.	P/L	Frequency (MHz)	Reading (dBμV)	Detector	Corrected (dB)	Result (dBμV)	Limit (dBμV)	Margin (dB)
1	N	0.3684	29.69	QP	10.02	39.71	58.54	-18.83
2	N	0.3684	19.08	AVG	10.02	29.10	48.54	-19.44
3	N	0.5439	30.88	QP	10.02	40.90	56.00	-15.10
4	N	0.5439	19.15	AVG	10.02	29.17	46.00	-16.83
5	N	0.8364	31.94	QP	10.03	41.97	56.00	-14.03
6	N	0.8364	20.53	AVG	10.03	30.56	46.00	-15.44
7	N	1.7022	31.66	QP	10.04	41.70	56.00	-14.30
8	N	1.7022	19.21	AVG	10.04	29.25	46.00	-16.75
9	N	2.4900	30.08	QP	10.04	40.12	56.00	-15.88
10	N	2.4900	18.89	AVG	10.04	28.93	46.00	-17.07
11	N	15.1407	23.15	QP	10.20	33.35	60.00	-26.65
12	N	15.1407	10.98	AVG	10.20	21.18	50.00	-28.82

6.7 Radiated Spurious Emissions & Restricted Band

Temperature	22°C
Relative Humidity	53%
Atmospheric Pressure	1029mbar
Test date :	July 29, 2016
Tested By :	Loren Luo

Requirement(s):

Spec	Item	Requirement	Applicable										
47CFR§15.247(d), RSS210 (A8.5)	a)	<p>Except higher limit as specified elsewhere in other section, the emissions from the low-power radio-frequency devices shall not exceed the field strength levels specified in the following table and the level of any unwanted emissions shall not exceed the level of the fundamental emission. The tighter limit applies at the band edges</p> <table border="1"> <thead> <tr> <th>Frequency range (MHz)</th> <th>Field Strength (µV/m)</th> </tr> </thead> <tbody> <tr> <td>30 – 88</td> <td>100</td> </tr> <tr> <td>88 – 216</td> <td>150</td> </tr> <tr> <td>216 960</td> <td>200</td> </tr> <tr> <td>Above 960</td> <td>500</td> </tr> </tbody> </table>	Frequency range (MHz)	Field Strength (µV/m)	30 – 88	100	88 – 216	150	216 960	200	Above 960	500	<input checked="" type="checkbox"/>
	Frequency range (MHz)	Field Strength (µV/m)											
	30 – 88	100											
88 – 216	150												
216 960	200												
Above 960	500												
b)	<p>For non-restricted band, In any 100 kHz bandwidth outside the frequency band in which the spread spectrum or digitally modulated intentional radiator is operating, the radio frequency power that is produced by the intentional radiator shall be at least 20 dB or 30dB below that in the 100 kHz bandwidth within the band that contains the highest level of the desired power, determined by the measurement method on output power to be used. Attenuation below the general limits specified in § 15.209(a) is not required</p> <p><input checked="" type="checkbox"/> 20 dB down <input type="checkbox"/> 30 dB down</p>	<input checked="" type="checkbox"/>											
c)	<p>or restricted band, emission must also comply with the radiated emission limits specified in 15.209</p>	<input checked="" type="checkbox"/>											

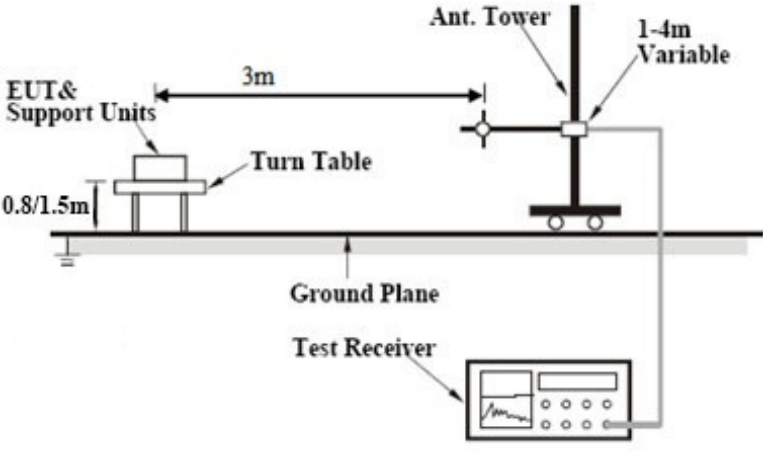
<p>Test Setup</p>	
<p>Procedure</p>	<ol style="list-style-type: none"> 1. The EUT was switched on and allowed to warm up to its normal operating condition. 2. The test was carried out at the selected frequency points obtained from the EUT characterization. Maximization of the emissions, was carried out by rotating the EUT, changing the antenna polarization, and adjusting the antenna height in the following manner: <ol style="list-style-type: none"> a. Vertical or horizontal polarization (whichever gave the higher emission level over a full rotation of the EUT) was chosen. b. The EUT was then rotated to the direction that gave the maximum emission. c. Finally, the antenna height was adjusted to the height that gave the maximum emission. 3. The resolution bandwidth and video bandwidth of test receiver/spectrum analyzer is 120 kHz for Quasiy Peak detection at frequency below 1GHz. 4. The resolution bandwidth of test receiver/spectrum analyzer is 1MHz and video bandwidth is 3MHz with Peak detection for Peak measurement at frequency above 1GHz. The resolution bandwidth of test receiver/spectrum analyzer is 1MHz and the video bandwidth is 10Hz with Peak detection for Average Measurement as below at frequency above 1GHz. 5. Steps 2 and 3 were repeated for the next frequency point, until all selected frequency points were measured.
<p>Remark</p>	<p>Different RF configuration has been evaluated but not much difference was found. The data presented here is the worst case data with EUT under 802.11n – HT20-2437MHz mode.</p>
<p>Result</p>	<p><input checked="" type="checkbox"/> Pass <input type="checkbox"/> Fail</p>

Test Data Yes N/A
 Test Plot Yes (See below) N/A

Test Mode:	Transmitting Mode
-------------------	--------------------------

Below 1GHz

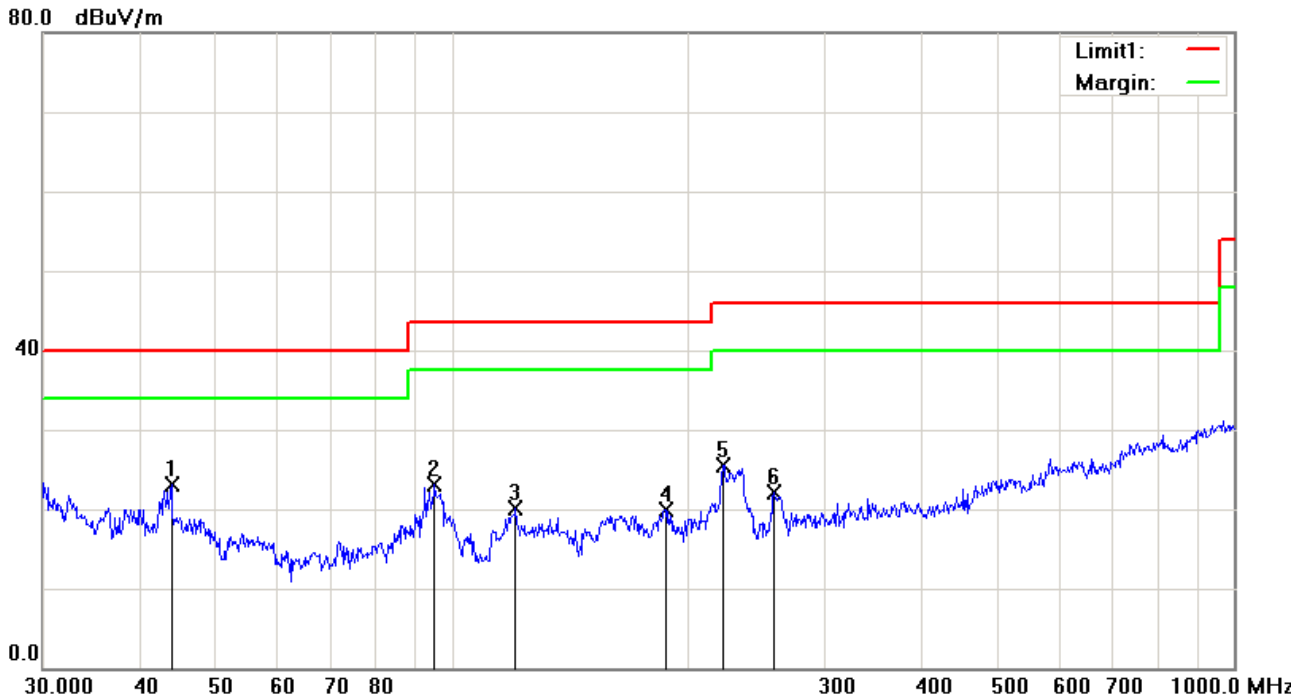

Test Data

Vertical Polarity Plot @3m

No	P/L	Frequency (MHz)	Reading (dBμV)	Detector	Corrected (dB)	Result (dBμV)	Limit (dBμV)	Margin (dB)	Height	Degree
1	H	43.8119	33.16	peak	-10.15	23.01	40.00	-16.99	100	165
2	H	95.0930	35.23	peak	-12.11	23.12	43.50	-20.38	100	81
3	H	120.6991	27.37	peak	-7.35	20.02	43.50	-23.48	100	227
4	H	187.7530	29.22	peak	-9.37	19.85	43.50	-23.65	100	153
5	H	222.1698	34.49	peak	-8.94	25.55	46.00	-20.45	100	249
6	H	258.3264	30.88	peak	-8.81	22.07	46.00	-23.93	100	316

Below 1GHz

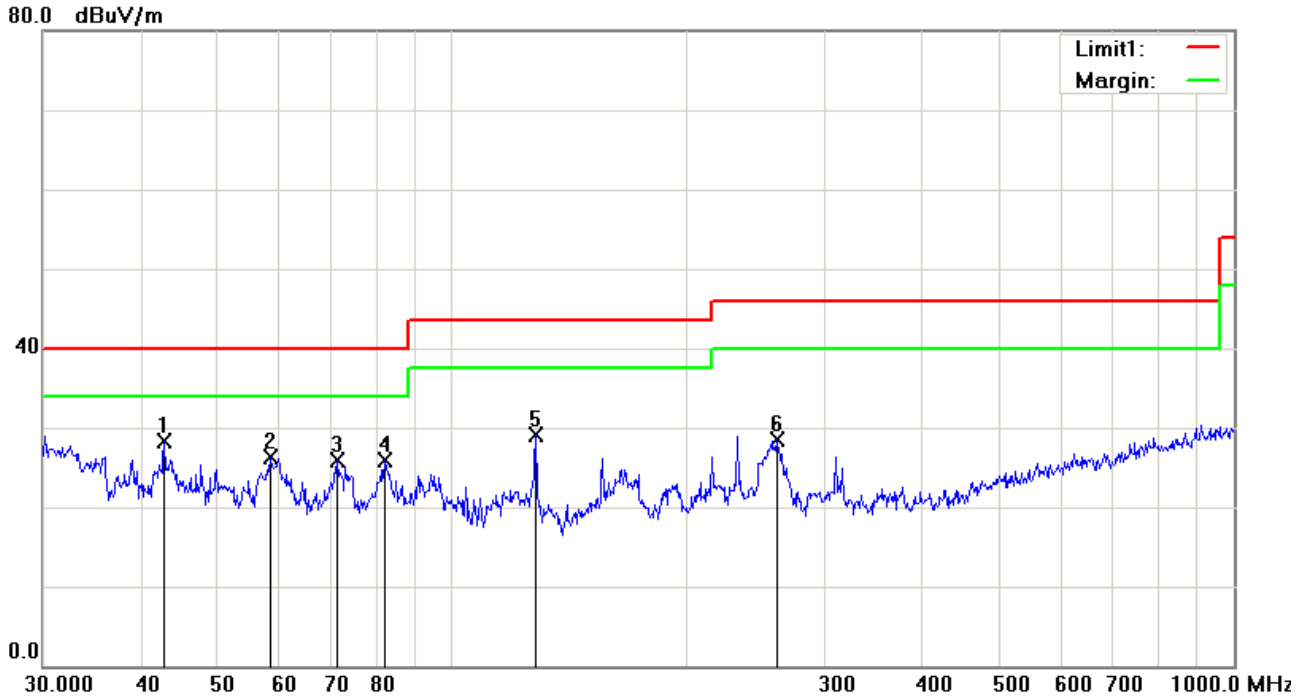

Test Data

Horizontal Polarity Plot @3m

No	P/L	Frequency (MHz)	Reading (dBμV)	Detector	Corrected (dB)	Result (dBμV)	Limit (dBμV)	Margin (dB)	Height	Degree
1	V	42.8998	37.77	peak	-9.53	28.24	40.00	-11.76	100	191
2	V	58.6126	40.53	peak	-14.20	26.33	40.00	-13.67	100	56
3	V	71.3300	39.51	peak	-13.65	25.86	40.00	-14.14	100	183
4	V	82.0706	39.62	peak	-13.66	25.96	40.00	-14.04	100	261
5	V	128.1130	36.89	peak	-7.82	29.07	43.50	-14.43	100	79
6	V	260.1444	37.28	peak	-8.72	28.56	46.00	-17.44	100	145

Above 1GHz

Test Mode:	Transmitting Mode
-------------------	--------------------------

Low Channel (2402 MHz)

Frequency (MHz)	S.A. Reading (dB μ V)	Detector (PK/AV)	Polarity (H/V)	Ant. Factor (dB/m)	Cable Loss (dB)	Pre-Amp. Gain (dB)	Cord. Amp. (dB μ V/m)	Limit (dB μ V/m)	Margin (dB)
4804	39.23	AV	V	33.83	6.86	31.72	48.2	54	-5.8
4804	38.91	AV	H	33.83	6.86	31.72	47.88	54	-6.12
4804	48.67	PK	V	33.83	6.86	31.72	57.64	74	-16.36
4804	48.34	PK	H	33.83	6.86	31.72	57.31	74	-16.69
17853	24.81	AV	V	45.03	11.21	32.38	48.67	54	-5.33
17853	24.75	AV	H	45.03	11.21	32.38	48.61	54	-5.39
17853	41.52	PK	V	45.03	11.21	32.38	65.38	74	-8.62
17853	41.38	PK	H	45.03	11.21	32.38	65.24	74	-8.76

Middle Channel (2440 MHz)

Frequency (MHz)	S.A. Reading (dB μ V)	Detector (PK/AV)	Polarity (H/V)	Ant. Factor (dB/m)	Cable Loss (dB)	Pre-Amp. Gain (dB)	Cord. Amp. (dB μ V/m)	Limit (dB μ V/m)	Margin (dB)
4880	39.35	AV	V	33.86	6.82	31.82	48.21	54	-5.79
4880	39.11	AV	H	33.86	6.82	31.82	47.97	54	-6.03
4880	48.53	PK	V	33.86	6.82	31.82	57.39	74	-16.61
4880	48.29	PK	H	33.86	6.82	31.82	57.15	74	-16.85
17825	24.55	AV	V	45.15	11.18	32.41	48.47	54	-5.53
17825	24.41	AV	H	45.15	11.18	32.41	48.33	54	-5.67
17825	41.19	PK	V	45.15	11.18	32.41	65.11	74	-8.89
17825	41.26	PK	H	45.15	11.18	32.41	65.18	74	-8.82

High Channel (2480 MHz)

Frequency (MHz)	S.A. Reading (dB μ V)	Detector (PK/AV)	Polarity (H/V)	Ant. Factor (dB/m)	Cable Loss (dB)	Pre-Amp. Gain (dB)	Cord. Amp. (dB μ V/m)	Limit (dB μ V/m)	Margin (dB)
4960	39.42	AV	V	33.9	6.76	31.92	48.16	54	-5.84
4960	39.28	AV	H	33.9	6.76	31.92	48.02	54	-5.98
4960	48.43	PK	V	33.9	6.76	31.92	57.17	74	-16.83
4960	48.19	PK	H	33.9	6.76	31.92	56.93	74	-17.07
17846	24.34	AV	V	45.22	11.35	32.38	48.53	54	-5.47
17846	24.17	AV	H	45.22	11.35	32.38	48.36	54	-5.64
17846	41.26	PK	V	45.22	11.35	32.38	65.45	74	-8.55
17846	41.02	PK	H	45.22	11.35	32.38	65.21	74	-8.79

Note:

- 1, The testing has been conformed to $10 \times 2480 \text{ MHz} = 24,800 \text{ MHz}$
- 2, All other emissions more than 30 dB below the limit
- 3, X-Axis, Y-Axis and Z-Axis were investigated. The results above show only the worst case.

Annex A. TEST INSTRUMENT

Instrument	Model	Serial #	Cal Date	Cal Due	In use
AC Line Conducted					
EMI test receiver	ESCS30	8471241027	09/17/2015	09/16/2016	<input checked="" type="checkbox"/>
Line Impedance	LI-125A	191106	09/25/2015	09/24/2016	<input checked="" type="checkbox"/>
Line Impedance	LI-125A	191107	09/25/2015	09/24/2016	<input checked="" type="checkbox"/>
LISN	ISN T800	34373	09/25/2015	09/24/2016	<input checked="" type="checkbox"/>
Double Ridge Horn Antenna (1 ~18GHz)	AH-118	71283	09/24/2015	09/23/2016	<input checked="" type="checkbox"/>
Transient Limiter	LIT-153	531118	09/01/2015	08/31/2016	<input checked="" type="checkbox"/>
RF conducted test					
Agilent ESA-E SERIES	E4407B	MY45108319	09/17/2015	09/16/2016	<input checked="" type="checkbox"/>
Power Splitter	1#	1#	09/01/2015	08/31/2016	<input checked="" type="checkbox"/>
DC Power Supply	E3640A	MY40004013	09/17/2015	09/16/2016	<input checked="" type="checkbox"/>
Radiated Emissions					
EMI test receiver	ESL6	100262	09/17/2015	09/16/2016	<input checked="" type="checkbox"/>
Positioning Controller	UC3000	MF780208282	11/19/2015	11/18/2016	<input checked="" type="checkbox"/>
OPT 010 AMPLIFIER (0.1-1300MHz)	8447E	2727A02430	09/01/2015	08/31/2016	<input checked="" type="checkbox"/>
Microwave Preamplifier (1 ~ 26.5GHz)	8449B	3008A02402	03/24/2016	03/23/2017	<input checked="" type="checkbox"/>
Bilog Antenna (30MHz~6GHz)	JB6	A110712	09/21/2015	09/20/2016	<input checked="" type="checkbox"/>
Double Ridge Horn Antenna (1 ~18GHz)	AH-118	71283	09/24/2015	09/23/2016	<input checked="" type="checkbox"/>
Universal Radio Communication Tester	CMU200	121393	09/25/2015	09/24/2016	<input checked="" type="checkbox"/>

Annex B. EUT And Test Setup Photographs

Annex B.i. Photograph: EUT External Photo

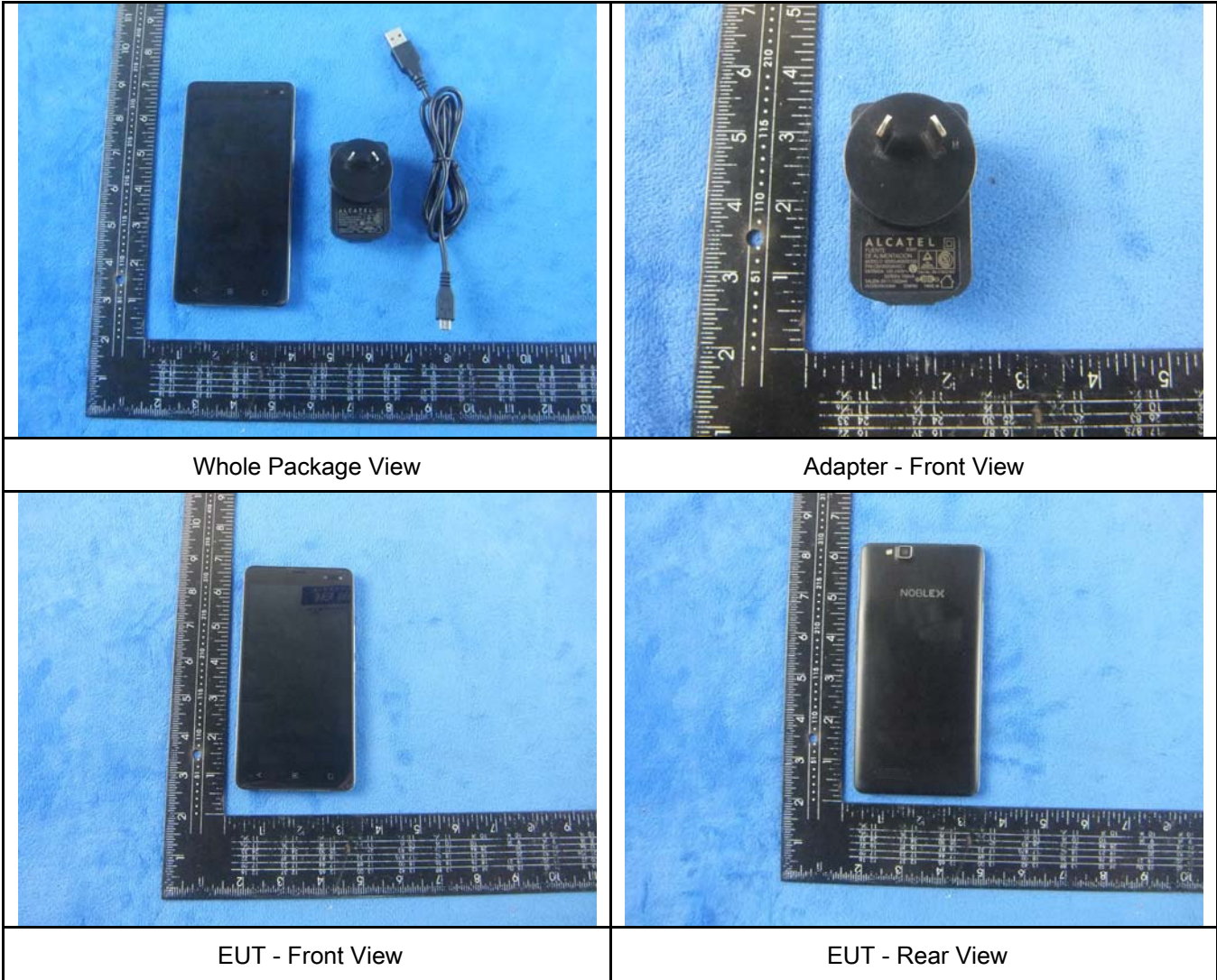

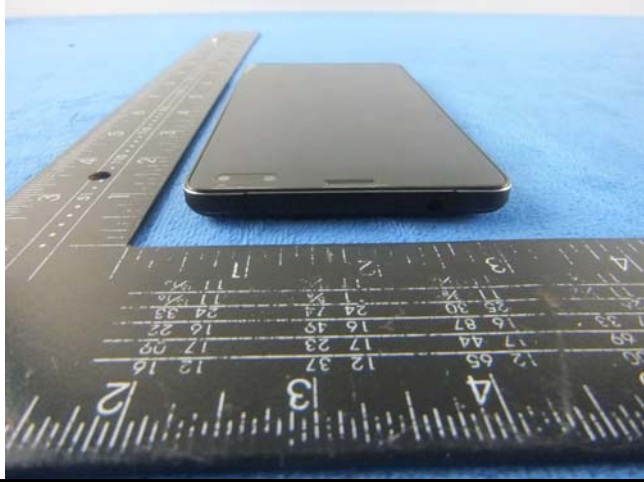

EUT - Top View



EUT - Bottom View



EUT - Left View



EUT - Right View

Annex B.ii. Photograph: EUT Internal Photo



Cover Off - Top View 1



Cover Off - Top View 2



Battery - Front View

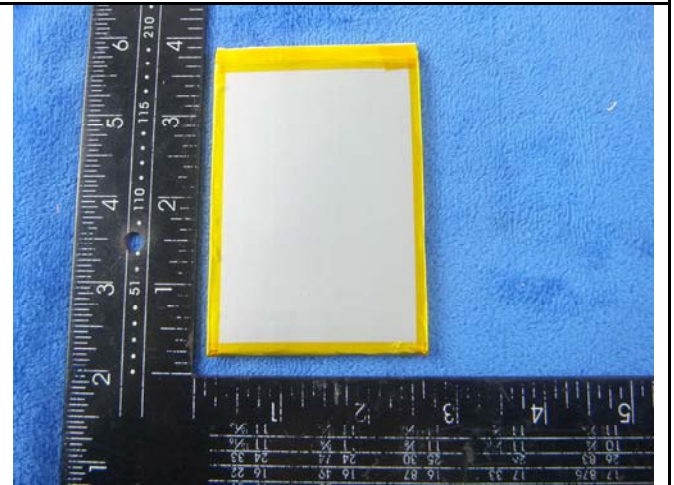

Battery - Rear View

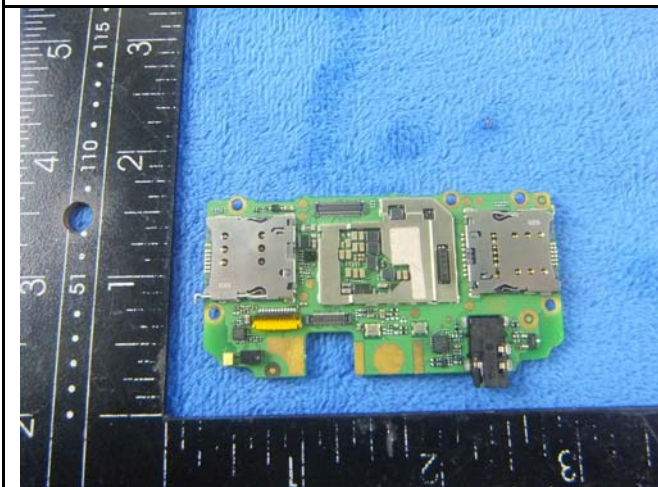

Mainboard with Shielding - Front View

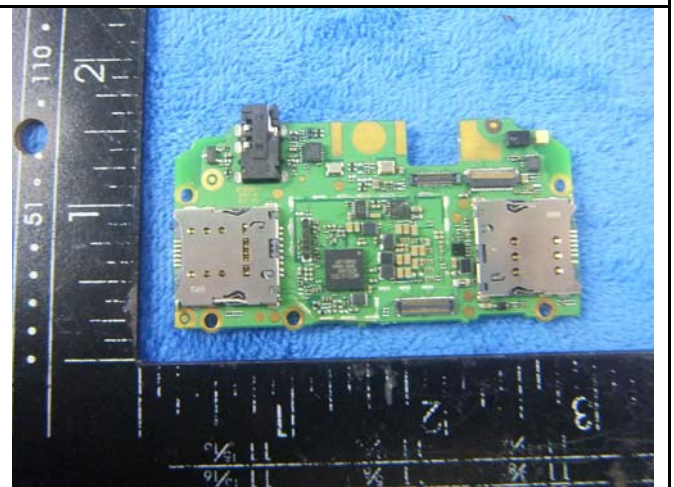

Mainboard without Shielding - Front View

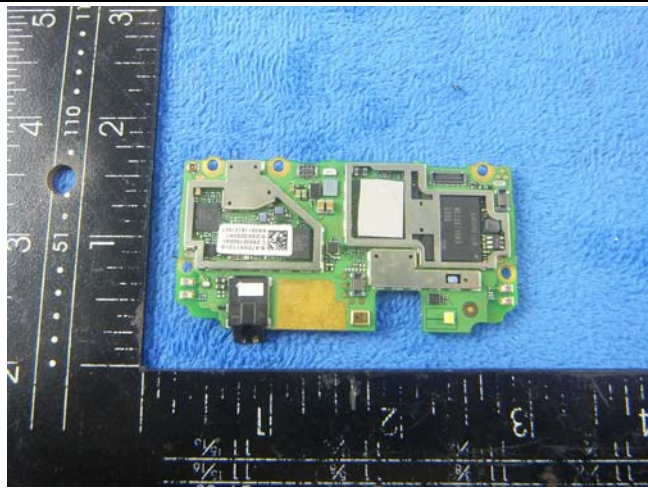

Mainboard with Shielding - Rear View

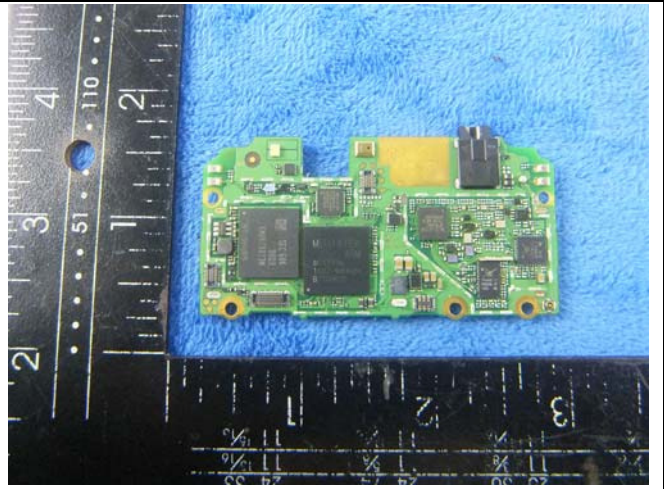

Mainboard without Shielding - Rear View



LCD – Front View



LCD – Rear View



GSM/PCS/UMTS-FDD Antenna View



WIFI/BT/BLE/GPS - Antenna View

Test Report No.	16070816-FCC-R4
Page	37 of 44



LTE Antenna View

Annex B.iii. Photograph: Test Setup Photo



Conducted Emissions Test Setup Front View



Conducted Emissions Test Setup Side View

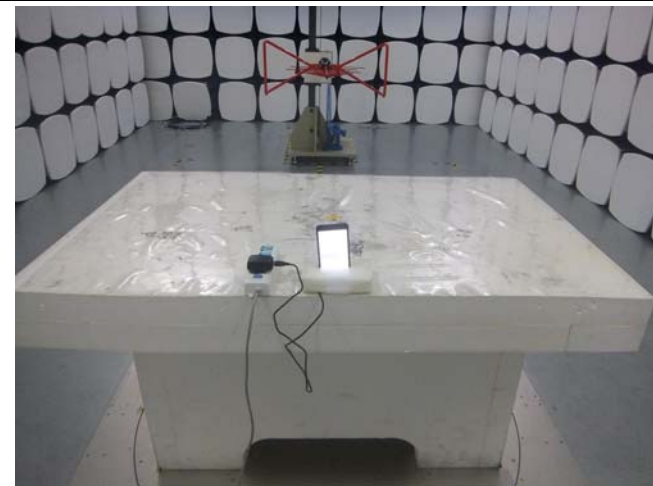

Radiated Spurious Emissions Test Setup Below 1GHz



Radiated Spurious Emissions Test Setup Above 1GHz

Annex C. TEST SETUP AND SUPPORTING EQUIPMENT

Annex C.ii. TEST SET UP BLOCK

Block Configuration Diagram for AC Line Conducted Emissions

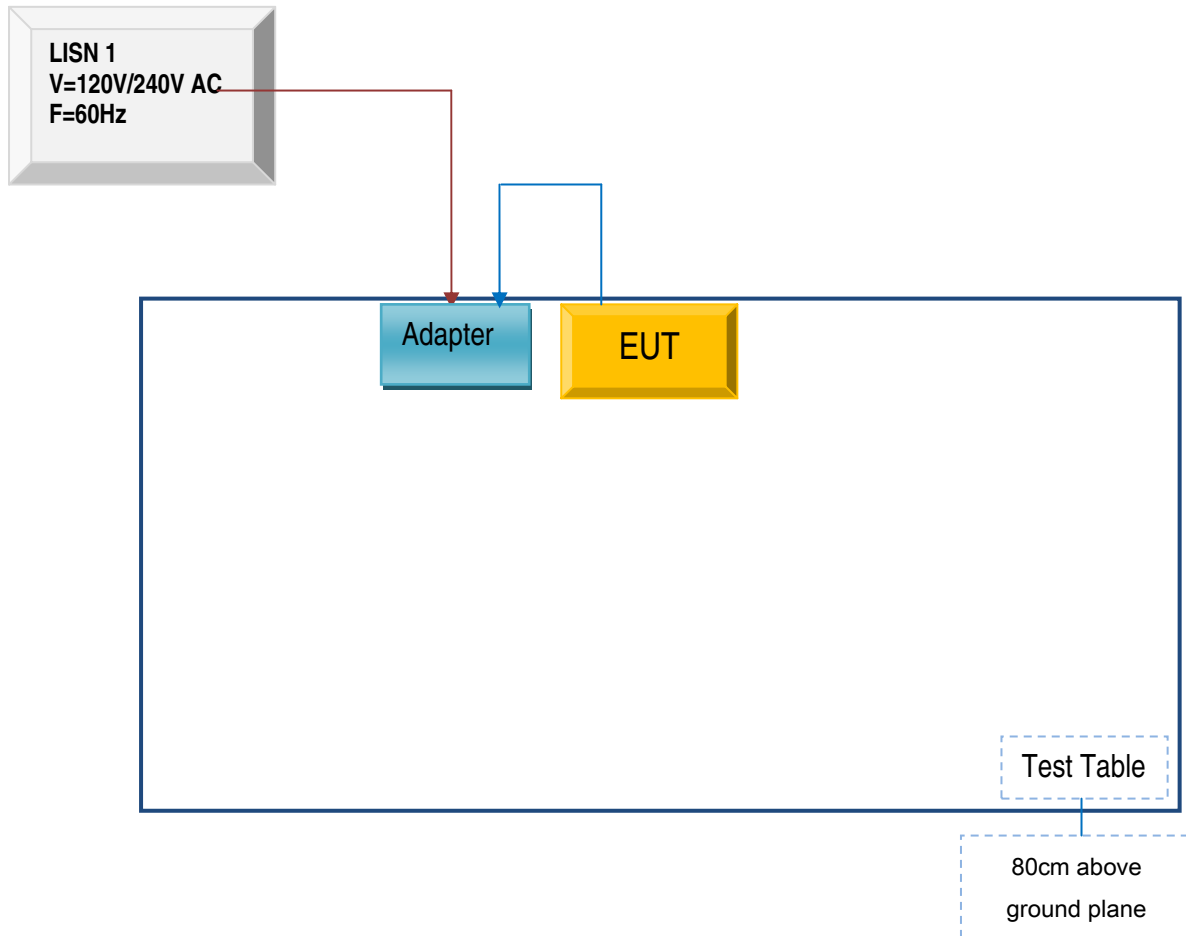

Block Configuration Diagram for Radiated Emissions (Below 1GHz) .

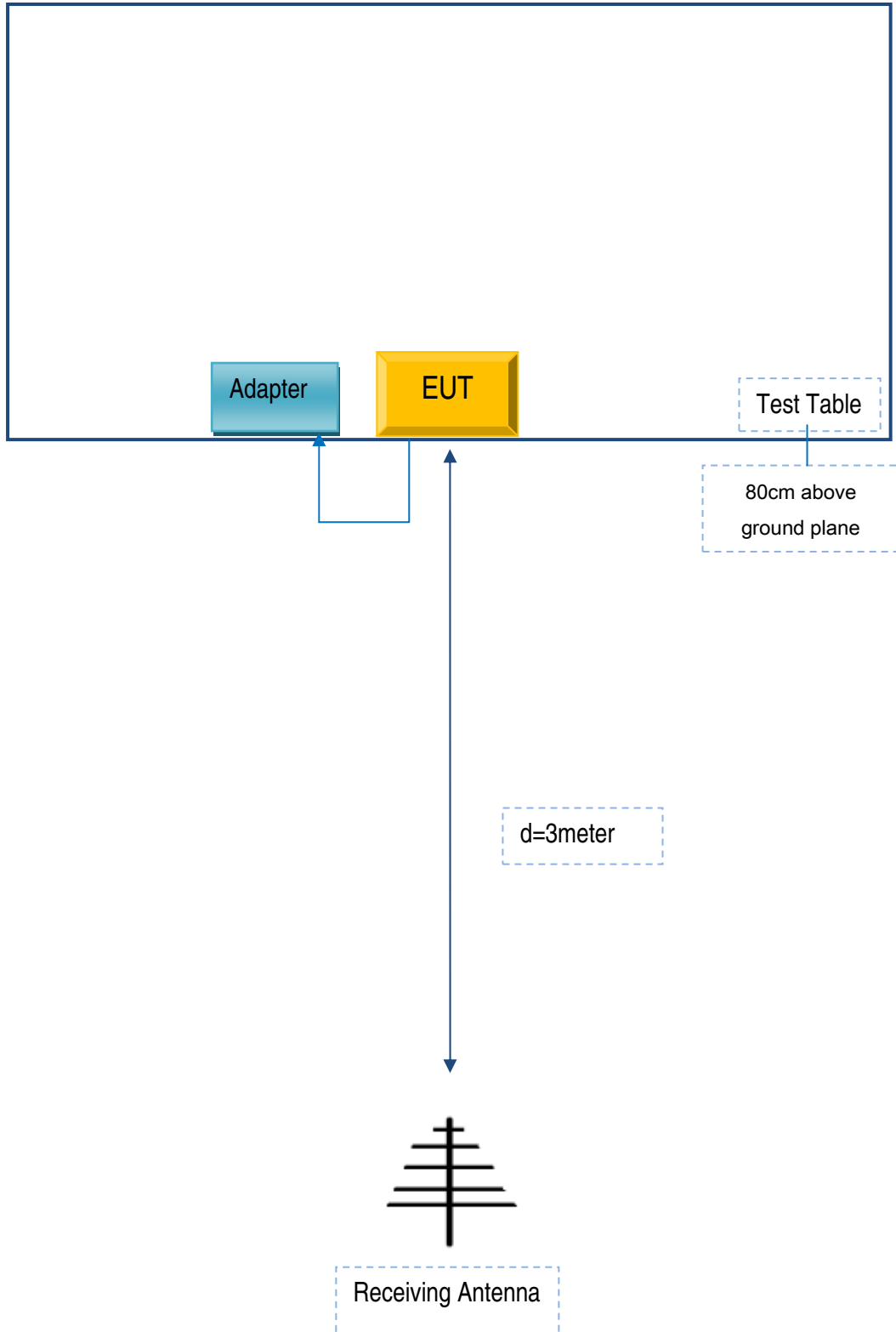

Block Configuration Diagram for Radiated Emissions (Above 1GHz) .

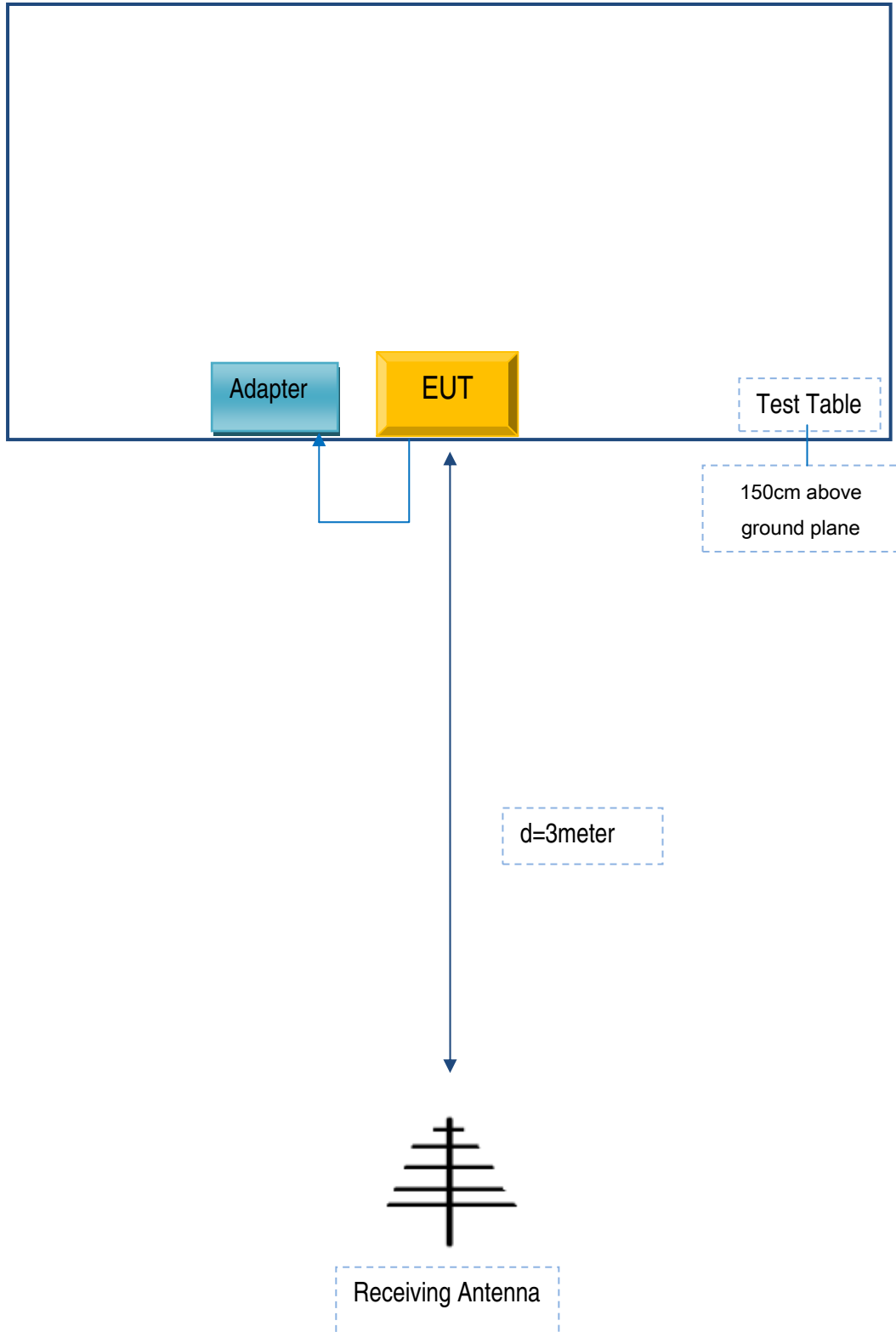

Annex C. ii. SUPPORTING EQUIPMENT DESCRIPTION

The following is a description of supporting equipment and details of cables used with the EUT.

Supporting Equipment:

Manufacturer	Equipment Description	Model	Serial No
MOBIWIRE MOBILES (NINGBO) CO.,LTD	Adapter	S005UA0500100	CBA3000AH0C1

Supporting Cable:

Cable type	Shield Type	Ferrite Core	Length	Serial No
USB Cable	Un-shielding	No	0.8m	CBA3000AH0C1

Test Report No.	16070816-FCC-R4
Page	43 of 44

Annex D. User Manual / Block Diagram / Schematics / Partlist

Please see the attachment

Test Report No.	16070816-FCC-R4
Page	44 of 44

Annex E. DECLARATION OF SIMILARITY

N/A