

# SAR TEST REPORT



Report No.: 17070028-FCC-H

Supersede Report No.:N/A

|                                                                                                                                      |                                                                                                           |                                                                                       |
|--------------------------------------------------------------------------------------------------------------------------------------|-----------------------------------------------------------------------------------------------------------|---------------------------------------------------------------------------------------|
| Applicant                                                                                                                            | MOBIWIRE MOBILES (NINGBO) CO.,LTD                                                                         |                                                                                       |
| Product Name                                                                                                                         | 3G feature phone                                                                                          |                                                                                       |
| Model No.                                                                                                                            | F1035                                                                                                     |                                                                                       |
| Standards                                                                                                                            | FCC 47 CFR Part2(2.1093)<br>ANSI/IEEE C95.1-1999<br>IEEE 1528-2013 & Published RF Exposure KDB Procedures |                                                                                       |
| Test Date                                                                                                                            | Jan 16 to Jan 17, 2017                                                                                    |                                                                                       |
| Issue Date                                                                                                                           | Jan 24, 2017                                                                                              |                                                                                       |
| Test Result                                                                                                                          | PASS                                                                                                      |                                                                                       |
| Equipment complied with the specification                                                                                            | <input checked="" type="checkbox"/>                                                                       |                                                                                       |
| Equipment did not comply with the specification                                                                                      | <input type="checkbox"/>                                                                                  |                                                                                       |
|                                                   |                        |  |
| Wiky Jam<br>Test Engineer                                                                                                            | David Huang<br>Checked By                                                                                 |                                                                                       |
| This test report may be reproduced in full only<br>Test result presented in this test report is applicable to the tested sample only |                                                                                                           |                                                                                       |

Issued by:

**SIEMIC (SHENZHEN-CHINA) LABORATORIES**

Zone A, Floor 1, Building 2 Wan Ye Long Technology Park

South Side of Zhoushi Road, Bao'an District, Shenzhen, Guangdong China 518108

Phone: +86 0755 2601 4629801 Email: [China@siemic.com.cn](mailto:China@siemic.com.cn)

## Laboratory Introduction

SIEMIC, headquartered in the heart of Silicon Valley, with superior facilities in US and Asia, is one of the leading independent testing and certification facilities providing customers with one-stop shop services for Compliance Testing and Global Certifications.



In addition to testing and certification, SIEMIC provides initial design reviews and compliance management throughout a project. Our extensive experience with China, Asia Pacific, North America, European, and International compliance requirements, assures the fastest, most cost effective way to attain regulatory compliance for the global markets.

### Accreditations for Conformity Assessment

| Country/Region | Scope                              |
|----------------|------------------------------------|
| USA            | EMC, RF/Wireless, SAR, Telecom     |
| Canada         | EMC, RF/Wireless, SAR, Telecom     |
| Taiwan         | EMC, RF, Telecom, SAR, Safety      |
| Hong Kong      | RF/Wireless, SAR, Telecom          |
| Australia      | EMC, RF, Telecom, SAR, Safety      |
| Korea          | EMI, EMS, RF, SAR, Telecom, Safety |
| Japan          | EMI, RF/Wireless, SAR, Telecom     |
| Singapore      | EMC, RF, SAR, Telecom              |
| Europe         | EMC, RF, SAR, Telecom, Safety      |

|             |                |
|-------------|----------------|
| Test Report | 17070028-FCC-H |
| Page        | 3 of 86        |

---

This page has been left blank intentionally.

**CONTENTS**

|    |                                                |    |
|----|------------------------------------------------|----|
| 1  | EUT INFORMATION.....                           | 5  |
| 2  | TECHNICAL DETAILS .....                        | 6  |
| 3  | INTRODUCTION .....                             | 7  |
| 4  | SAR MEASUREMENT SETUP .....                    | 8  |
| 5  | ANSI/IEEE C95.1 – 1999 RF EXPOSURE LIMIT ..... | 19 |
| 6  | SYSTEM AND LIQUID VERIFICATION .....           | 20 |
| 7  | UNCERTAINTY ASSESSMENT .....                   | 28 |
| 8  | TEST INSTRUMENT .....                          | 31 |
| 9  | OUTPUT POWER VERIFICATION .....                | 32 |
| 10 | SAR TEST RESULTS.....                          | 38 |
| 11 | SAR MEASUREMENT REFERENCES.....                | 41 |
|    | ANNEX A CALIBRATION REPORTS .....              | 50 |
|    | ANNEX B SAR SYSTEM PHOTOGRAPHS.....            | 83 |
|    | ANNEX C SETUP PHOTOGRAPHS .....                | 84 |

# 1 EUT INFORMATION

| EUT Information                                    |                                                                                                                                        |
|----------------------------------------------------|----------------------------------------------------------------------------------------------------------------------------------------|
| <b>EUT Description</b>                             | 3G feature phone                                                                                                                       |
| <b>Model No</b>                                    | F1035                                                                                                                                  |
| <b>Input Power</b>                                 | Rechargeable Li-ion Battery<br>Model: Own F1035<br>Voltage: 3.7V<br>Battery Capacity: 800mAh,2.96Wh<br>Maximum chargeable voltage:4.2V |
| <b>Maximum Conducted Output Power to Antenna</b>   | GSM 850 Voice : 32.79dBm<br>PCS 1900 Voice : 29.81dBm<br>WCDMA Band V (Class 3): 21.73dBm<br>WCDMA Band II (Class 3): 22.07dBm         |
| <b>Highest Reported SAR Level(s)</b>               | 0.95W/Kg 1g Head Tissue<br>1.00W/Kg 1g Body Tissue                                                                                     |
| <b>Classification Per Stipulated Test Standard</b> | Portable Device, Class B, No DTM Mode                                                                                                  |
| <b>Multi-SIM</b>                                   | N/A                                                                                                                                    |
| <b>Co-located TX</b>                               | N/A                                                                                                                                    |
| <b>Antenna Type(s)</b>                             | PIFA Antenna(WWAN)                                                                                                                     |
| <b>Accessory</b>                                   | N/A                                                                                                                                    |

## SAR Test Result

| Equipment Class  | Frequency Band |          | Highest 1g SAR Summary |                        |                           | Highest Simultaneous Transmission 1g SAR(W/kg) |
|------------------|----------------|----------|------------------------|------------------------|---------------------------|------------------------------------------------|
|                  |                |          | Head (Separation 0mm)  | Body (Separation 10mm) | Hotspot (Separation 10mm) |                                                |
|                  |                |          | 1g SAR(W/kg)           |                        |                           |                                                |
| Licensed         | GSM            | GSM850   | 0.49                   | <b>1.00</b>            | <b>1.00</b>               | <b>1.12</b>                                    |
|                  |                | GSM1900  | 0.47                   | 0.75                   | 0.75                      |                                                |
|                  | WCDMA          | WCDMA II | <b>0.95</b>            | 0.82                   | 0.82                      |                                                |
|                  |                | WCDMA V  | 0.43                   | 0.36                   | 0.36                      |                                                |
| Date of Testing: |                |          | Jan 16 to Jan 17, 2017 |                        |                           |                                                |

## 2 TECHNICAL DETAILS

|                                 |                                                                                                                                                                                                                                                                                 |
|---------------------------------|---------------------------------------------------------------------------------------------------------------------------------------------------------------------------------------------------------------------------------------------------------------------------------|
| Purpose                         | Compliance testing of 3G feature phone model F1035 with stipulated standard                                                                                                                                                                                                     |
| Applicant / Client              | MOBIWIRE MOBILES (NINGBO) CO.,LTD<br>No.999,Dacheng East Road,Fenghua City,Zhejiang                                                                                                                                                                                             |
| Manufacturer                    | MOBIWIRE MOBILES (NINGBO) CO.,LTD<br>No.999,Dacheng East Road,Fenghua City,Zhejiang                                                                                                                                                                                             |
| Laboratory performing the tests | SIEMIC(Shenzhen-China) Laboratories<br>Zone A, Floor 1, Building 2, Wan Ye Long Technology Park, South Side of Zhoushi Road, Bao'an District, Shenzhen 518108, Guangdong, P.R.C.<br>Tel: +(86) 0755-26014629<br>VIP Line:950-4038-0435                                          |
| Software Version                | OpenSAR V4_02_31                                                                                                                                                                                                                                                                |
| Test report reference number    | 17070028-FCC-H                                                                                                                                                                                                                                                                  |
| Date EUT received               | Jan 12, 2016                                                                                                                                                                                                                                                                    |
| Standard applied                | See Page 41                                                                                                                                                                                                                                                                     |
| Dates of test (from – to)       | Jan 16, 2017~ Jan 17, 2017                                                                                                                                                                                                                                                      |
| No of Units:                    | 1                                                                                                                                                                                                                                                                               |
| Equipment Category:             | PCE                                                                                                                                                                                                                                                                             |
| Trade                           | OWN                                                                                                                                                                                                                                                                             |
| Model Name:                     | F1035                                                                                                                                                                                                                                                                           |
| RF Operating Frequency (ies)    | GSM850 TX: 824.2 ~ 848.8 MHz; RX: 869.2 ~ 893.8 MHz<br>PCS1900 TX: 1850.2 ~ 1909.8 MHz; RX: 1930.2 ~ 1989.8 MHz<br>UMTS-FDD Band V TX: 826.4 ~ 846.6 MHz; RX: 871.4 ~ 891.6 MHz<br>UMTS-FDD Band II TX:1852.4 ~ 1907.6 MHz; RX: 1932.4 ~ 1987.6 MHz<br>Bluetooth: 2402-2480 MHz |
| Modulation:                     | GSM / GPRS: GMSK<br>EGPRS: GMSK,8PSK<br>UMTS-FDD: QPSK<br>Bluetooth: GFSK, $\pi$ /4-DQPSK, 8DPSK                                                                                                                                                                                |
| GPRS/EGPRS Multi-slot class     | 8/10/12                                                                                                                                                                                                                                                                         |
| FCC ID                          | 2ADA4F1035D                                                                                                                                                                                                                                                                     |

## 3 INTRODUCTION

### Introduction

This measurement report shows compliance of the EUT with ANSI/IEEE C95.1-1999 and FCC 47 CFR Part2 (2.1093)

The test procedures, as described in IEEE 1528-2013 Standard for IEEE Recommended Practice for Determining the Peak Spatial-Average Specific Absorption Rate (SAR) in the Human Head from Wireless Communications Devices: Measurement Techniques(300MHz~6GHz) and Published RF Exposure KDB Procedures

### SAR Definition

Specific Absorption Rate is defined as the time derivative (rate) of the incremental energy (dW) absorbed by (dissipated in) an incremental mass (dm) contained in a volume element (dV) of a given density ( $\rho$ ).

$$SAR = \frac{d}{dt} \left( \frac{dW}{dm} \right) = \frac{d}{dt} \left( \frac{dW}{\rho dV} \right)$$

SAR is expressed in units of watts per kilogram (W/kg). SAR can be related to the electric field at a point by

$$SAR = \frac{\sigma |E|^2}{\rho}$$

where:

- $\sigma$  = conductivity of the tissue (S/m)
- $\rho$  = mass density of the tissue (kg/m<sup>3</sup>)
- E = rms electric field strength (V/m)

## 4 SAR MEASUREMENT SETUP

### Dosimetric Assessment System

These measurements were performed with the automated near-field scanning system OPENSAR from SATIMO. The system is based on a high precision robot (working range: 850 mm), which positions the probes with a positional repeatability of better than  $\pm 0.02$  mm. Special E- and H-field probes have been developed for measurements close to material discontinuity, the sensors of which are directly loaded with a Schottky diode and connected via highly resistive lines to the data acquisition unit.

The SAR measurements were conducted with dosimetric probe (manufactured by SATIMO), designed in the classical triangular configuration and optimized for dosimetric evaluation. The probe has been calibrated according to the procedure described in SAR standard with accuracy of better than  $\pm 10\%$ . The spherical isotropy was evaluated with the procedure described in SAR standard and found to be better than  $\pm 0.25$  dB. The phantom used was the SAM Phantom as described in FCC supplement C, IEEE P1528 and CENELEC EN62209-1.

### Measurement System Diagram

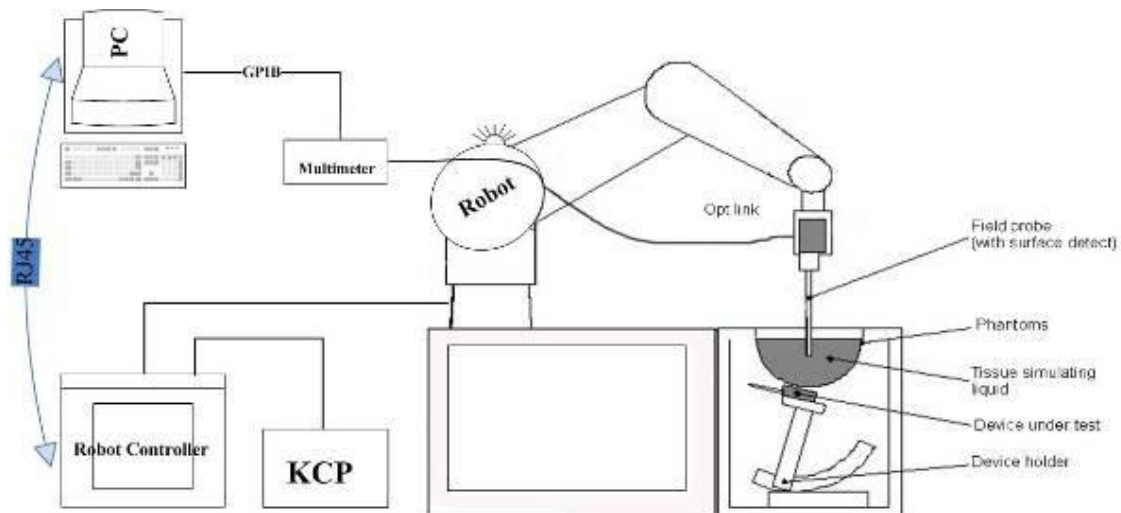

**The OPENSAR system for performing compliance tests consist of the following items:**

1. A standard high precision 6-axis robot (KUKA) with controller and software.
2. KUKA Control Panel (KCP).
3. A dosimetric probe, i.e., an isotropic E-field probe optimized and calibrated for usage in tissue simulating liquid. The probe is equipped with an optical surface detector system.
4. The functions of the PC plug-in card are to perform the time critical task such as signal filtering, surveillance of the robot operation fast movement interrupts.



|             |                |
|-------------|----------------|
| Test Report | 17070028-FCC-H |
| Page        | 9 of 86        |

5. A computer operating Windows XP.
6. OPENSAR software.
7. Remote control with teaches pendant and additional circuitry for robot safety such as warning lamps, etc.
8. The SAM phantom enabling testing left-hand right-hand and body usage.
9. The Position device for handheld EUT.
10. Tissue simulating liquid mixed according to the given recipes (see Application Note).
11. System validation dipoles to validate the proper functioning of the system.

## EP100 Probe



Construction Symmetrical design with triangular Core. Built-in shielding against static charges Calibration in air from 100 MHz to 2.5 GHz. In brain and muscle simulating tissue at frequencies from 800 to 6000 MHz (accuracy of 8%) .

Frequency 100 MHz to 6 GHz;

Linearity ; 0.25 dB (100 MHz to 6 GHz) ,

Directivity : 0.25 dB in brain tissue (rotation around probe axis) 0.5 dB in brain tissue (rotation normal probe axis)

Dynamic : 0.001W/kg to > 100W/kg;

Range Linearity: 0.25 dB

Surface : 0.2 mm repeatability in air and liquids

Dimensions Overall length: 330 mm

Tip length: 16 mm

Body diameter: 8 mm

Tip diameter: 2.6 mm

Distance from probe tip to dipole centers: <1.5 mm

Application General dosimetric up to 6 GHz

Compliance tests of GSM Phones

Fast automatic scanning in arbitrary phantoms

The SAR measurements were conducted with the dosimetric probe designed in the classical triangular configuration and optimized for dosimetric evaluation. The probe is constructed using the thick film technique, with printed resistive lines on ceramic substrates.

It is connected to the KRC box on the robot arm and provides an automatic detection of the phantom surface. The 3D file of the phantom is include in OpenSAR software. The Video Positioning System allow the system to take the automatic reference and to move the probe safely and accurately on the phantom.

### E-Field Probe Calibration Process

Probe calibration is realized, in compliance with CENELEC EN50361; CEI/IEC 62209 and IEEE 1528 std, with CALISAR, SATIMO proprietary calibration system. The calibration is performed with the technique using reference waveguide.

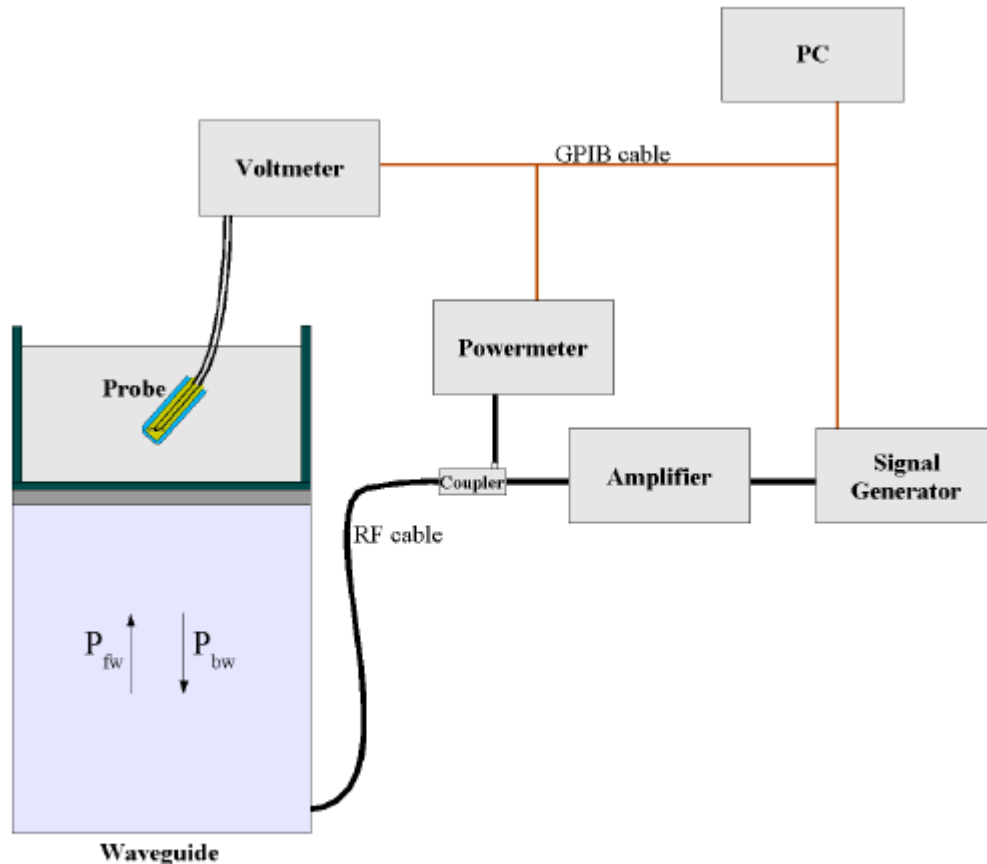

$$SAR = \frac{4(P_{fw} - P_{bw})}{ab\delta} \cos^2\left(\pi \frac{y}{a}\right) e^{-(2z/\delta)}$$

Where :

- $P_{fw}$  = Forward Power
- $P_{bw}$  = Backward Power
- a and b = Waveguide dimensions
- $\delta$  = Skin depth

*Keithley configuration:*

Rate = Medium; Filter =ON; RDGS=10; FILTER TYPE =MOVING AVERAGE; RANGE AUTO

*After each calibration, a SAR measurement is performed on a validation dipole and compared with a NPL calibrated probe, to verify it.*

Each probe is calibrated according to a dosimetric assessment procedure described in SAR standard with accuracy better than +/- 10%. The spherical isotropy was evaluated with the procedure described in SAR standard and found to be better than +/-0.25dB. The sensitivity parameters (NormX, NormY, NormZ), the diode compression parameter (DCP) and the conversion factor (ConvF) of the probe are tested. The free space E-field from probe outputs is determined in a test chamber. This is performed in a TEM cell for frequencies below 0.8 GHz, and in a waveguide above 0.8 GHz for free space. For the free space calibration, the probe is placed in the volumetric center of the cavity and at the proper orientation with the field. E-field correlation calibration is performed in a flat phantom filled with the appropriate simulated brain tissue.

## SAM Phantom

The SAM Phantom SAM29 is constructed of a fiberglass shell integrated in a wooden table. The shape of the shell is in compliance with the specification set in IEEE 1528 and CENELEC EN62209-1, IEC62209-2.

The phantom enables the dosimetric evaluation of left and right hand phone usage as well as body mounted usage at the flat phantom region.

A cover prevents the evaporation of the liquid.

Reference markings on the Phantom allow the complete setup of all predefined phantom positions and measurement grids by manually teaching three points in the robot.

Shell Thickness: 2 0.2 mm

Filling Volume: Approx. 25 liters

Dimensions (H x L x W): 810 x 1000 x 500 mm

Liquid is filled to at least 15mm from the bottom of Phantom.



## Device Holder

In combination with the Generic Twin Phantom V3.0, the Mounting Device enables the rotation of the mounted transmitter in spherical coordinates whereby the rotation points is the ear opening. The devices can be easily, accurately, and repeatedly positioned according to the FCC and CENELEC specifications. The device holder can be locked at different phantom locations (left head, right head, flat phantom).



**Note:** A simulating human hand is not used due to the complex anatomical and geometrical structure of the hand that may produced infinite number of configurations [10]. To produce the worst-case condition (the hand absorbs antenna output power), the hand is omitted during the tests.

## Data Evaluation

The OPENSAR software automatically executes the following procedure to calculate the field units from the microvolt readings at the probe connector. The parameters used in the valuation are stored in the configuration modules of the software:

|                  |                                |                   |
|------------------|--------------------------------|-------------------|
| Probe Parameters | - Sensitivity                  | Norm <sub>i</sub> |
|                  | - Conversion factor            | ConvFi            |
|                  | - Diode compression point Dcpi |                   |
| Device Parameter | - Frequency                    | f                 |
|                  | - Crest factor                 | cf                |
| Media Parametrs  | - Conductivity                 | σ                 |
|                  | - Density                      | ρ                 |

These parameters must be set correctly in the software. They can either be found in the component documents or be imported into the software from the configuration files issued for the OPENSAR components.

The first step of the evaluation is a linearization of the filtered input signal to account for the compression characteristics of the detector diode. The compensation depends on the input signal, the diode type and the DC-transmission factor from the diode to the evaluation electronics. If the exciting field is pulsed, the crest factor of the signal must be known to correctly compensate for peak power. The formula for each channel can be given as

$$V_i = U_i + U_i^2 \cdot \frac{cf}{dcp_i}$$

Where  $V_i$  = Compensated signal of channel  $i$  ( $i = x, y, z$ )

$U_i$  = Input signal of channel  $i$  ( $i = x, y, z$ )

$cf$  = Crest factor of exciting field (DASY parameter)

$dcp_i$  = Diode compression point (DASY parameter)

From the compensated input signals the primary field data for each channel can be evaluated:

$$E\text{-field probes: } E_i = \sqrt{\frac{V_i}{\text{Norm}_i \cdot \text{ConvF}}}$$

$$H\text{-field probes: } H_i = \sqrt{V_i} \cdot \frac{a_{i0} + a_{i1}f + a_{i2}f^2}{f}$$

Where  $V_i$  = Compensated signal of channel  $i$  ( $i = x, y, z$ )  
 $\text{Norm}_i$  = Sensor sensitivity of channel  $i$  ( $i = x, y, z$ )  
 $\mu\text{V}/(\text{V/m})^2$  for E0field Probes  
 $\text{ConvF}$  = Sensitivity enhancement in solution  
 $a_{ij}$  = Sensor sensitivity factors for H-field probes

$f$  = Carrier frequency (GHz)  
 $E_i$  = Electric field strength of channel  $i$  in V/m  
 $H_i$  = Magnetic field strength of channel  $i$  in A/m

The RSS value of the field components gives the total field strength (Hermitian magnitude):

$$E_{\text{tot}} = \sqrt{E_x^2 + E_y^2 + E_z^2}$$

The primary field data are used to calculate the derived field units.

$$SAR = E_{\text{tot}}^2 \cdot \frac{\sigma}{\rho \cdot 1000}$$

where  $SAR$  = local specific absorption rate in mW/g  
 $E_{\text{tot}}$  = total field strength in V/m  
 $\sigma$  = conductivity in [mho/m] or [siemens/m]  
 $\rho$  = equivalent tissue density in g/cm<sup>3</sup>

Note that the density is normally set to 1 (or 1.06), to account for actual brain density rather than the density of the simulation liquid.

The power flow density is calculated assuming the excitation field as a free space field.

$$P_{\text{pwe}} = \frac{E_{\text{tot}}^2}{3770} \quad \text{or} \quad P_{\text{pwe}} = H_{\text{tot}}^2 \cdot 37.7$$

where  $P_{\text{pwe}}$  = Equivalent power density of a plane wave in mW/cm<sup>2</sup>  
 $E_{\text{tot}}$  = total electric field strength in V/m  
 $H_{\text{tot}}$  = total magnetic field strength in A/m

## SAR Evaluation – Peak Spatial - Average

The procedure for assessing the peak spatial-average SAR value consists of the following steps

- **Power Reference Measurement**

The reference and drift jobs are useful jobs for monitoring the power drift of the device under test in the batch process. Both jobs measure the field at a specified reference position, at a selectable distance from the phantom surface. The reference position can be either the selected section's grid reference point or a user point in this section. The reference job projects the selected point onto the phantom surface, orients the probe perpendicularly to the surface, and approaches the surface using the selected detection method.

- **Area Scan**

The area scan is used as a fast scan in two dimensions to find the area of high field values, before doing a finer measurement around the hot spot. The sophisticated interpolation routines implemented in OPENSAR software can find the maximum locations even in relatively coarse grids. The scan area is defined by an editable grid. This grid is anchored at the grid reference point of the selected section in the phantom. When the area scan's property sheet is brought-up, grid was at to 15 mm by 15 mm and can be edited by a user.

- **Zoom Scan**

Zoom scans are used to assess the peak spatial SAR values within a cubic averaging volume containing 1 g and 10 g of simulated tissue. The default zoom scan measures 5 x 5 x 7 points within a cube whose base faces are centered around the maximum found in a preceding area scan job within the same procedure. If the preceding Area Scan job indicates more than one maximum, the number of Zoom Scans has to be enlarged accordingly (The default number inserted is 1).

- **Power Drift measurement**

The drift job measures the field at the same location as the most recent reference job within the same procedure, and with the same settings. The drift measurement gives the field difference in dB from the reading conducted within the last reference measurement. Several drift measurements are possible for one reference measurement. This allows a user to monitor the power drift of the device under test within a batch process. In the properties of the Drift job, the user can specify a limit for the drift and have OPENSAR software stop the measurements if this limit is exceeded.

## SAR Evaluation – Peak SAR

The procedure for spatial peak SAR evaluation has been implemented according to the IEEE1529 standard. It can be conducted for 1 g and 10 g. The OPENSAR system allows evaluations that combine measured data and robot positions, such as:

- maximum search
- extrapolation
- boundary correction
- peak search for averaged SAR

During a maximum search, global and local maximum searches are automatically performed in 2-D after each Area Scan measurement with at least 6 measurement points. It is based on the evaluation of the local SAR gradient calculated by the Quadratic Shepard's method. The algorithm will find the global maximum and all local maxima within -2 dB of the global maxima for all SAR distributions.

## Extrapolation

Extrapolation routines are used to obtain SAR values between the lowest measurement points and the inner phantom surface. The extrapolation distance is determined by the surface detection distance and the probe sensor offset. Several measurements at different distances are necessary for the extrapolation.

They are used in the Cube Scan to obtain SAR values between the lowest measurement points and the inner phantom surface. The routine uses the fourth order least square polynomial method for extrapolation. For a grid using 5x5x7 measurement points with 5mm resolution amounting to 343 measurement points, the uncertainty of the extrapolation routines is less than 1% for 1 g and 10 g cubes.

## Definition of Reference Points

### Ear Reference Point

Figure 6.2 shows the front, back and side views of the SAM Phantom. The point "M" is the reference point for the center of the mouth, "LE" is the left ear reference point (ERP), and "RE" is the right ERP. The ERPs are 15mm posterior to the entrance to the ear canal (EEC) along the B-M line (Back-Mouth), as shown in Figure 6.1. The plane passing through the two ear canals and M is defined as the Reference Plane. The line N-F (Neck-Front) is perpendicular to the reference plane and passing through the RE (or LE) is called the Reference Pivoting Line (see Figure 6.1). Line B-M is perpendicular to the N-F line. Both N-F and B-M lines are marked on the external phantom shell to facilitate handset positioning [5].

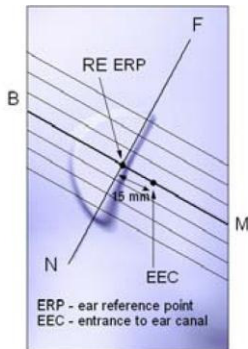

**Figure 6.1 Close-up side view of ERP's**



**Figure 6.2 Front, back and side view of SAM**

## Device Reference Points

Two imaginary lines on the device need to be established: the vertical centerline and the horizontal line. The test device is placed in a normal operating position with the "test device reference point" located along the "vertical centerline" on the front of the device aligned to the "ear reference point" (See Fig. 6.3). The "test device reference point" is then located at the same level as the center of the ear reference point. The test device is positioned so that the "vertical centerline" is bisecting the front surface of the device at its top and bottom edges, positioning the "ear reference point" on the outer surface of both the left and right head phantoms on the ear reference point [5].

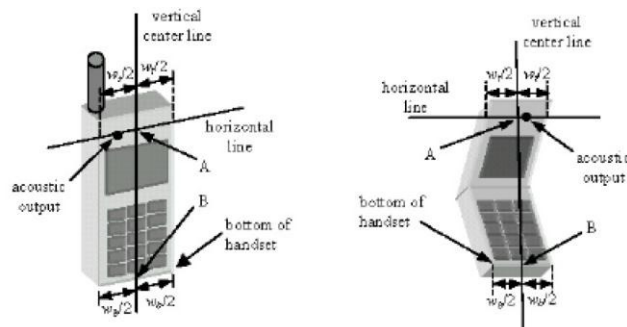
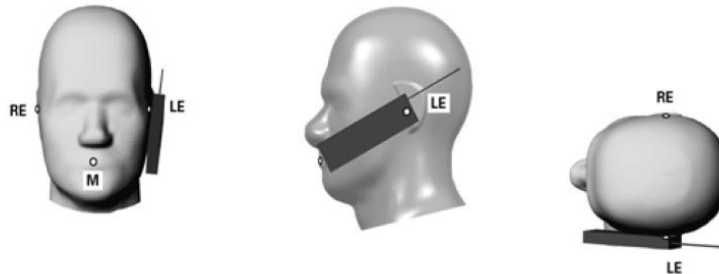

**Figure 6.3 Handset Vertical Center & Horizontal Line Reference Points**



## Test Configuration – Positioning for Cheek / Touch

1. Position the device close to the surface of the phantom such that point A is on the (virtual) extension of the line passing through points RE and LE on the phantom (see Figure below), such that the plane defined by the vertical center line and the horizontal line of the device is approximately parallel to the sagittal plane of the phantom



**Figure 7.1 Front, Side and Top View of Cheek/Touch Position**

2. Translate the device towards the phantom along the line passing through RE and LE until the device touches the ear.
3. While maintaining the device in this plane, rotate it around the LE-RE line until the vertical centerline is in the plane normal to MB-NF including the line MB (called the reference plane).
4. Rotate the device around the vertical centerline until the device (horizontal line) is symmetrical with respect to the line NF.
5. While maintaining the vertical centerline in the reference plane, keeping point A on the line passing through RE and LE and maintaining the device contact with the ear, rotate the device about the line NF until any point on the device is in contact with a phantom point below the ear (cheek). See Figure below.

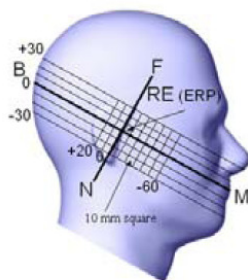
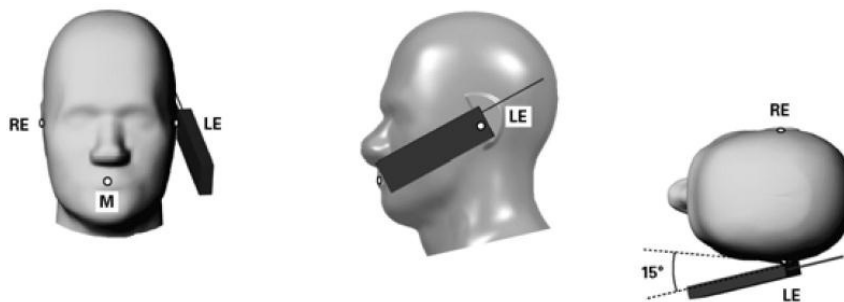

**Figure 7.2 Side view w/ relevant markings**

## Test Configuration – Positioning for Ear / 15° Tilt

With the test device aligned in the Cheek/Touch Position”:

1. While maintaining the orientation of the device, retracted the device parallel to the reference plane far enough to enable a rotation of the device by 15 degrees.
2. Rotate the device around the horizontal line by 15 degrees.
3. While maintaining the orientation of the device, move the device parallel to the reference plane until any part of the device touches the head. (In this position, point A is located on the line RE-LE). The tilted position is obtained when the contact is on the pinna. If the contact is at any location other than the pinna, the angle of the device shall be reduced. The tilted position is obtained when any part of the device is in contact with the ear as well as a second part of the device is in contact with the head (see Figure below).

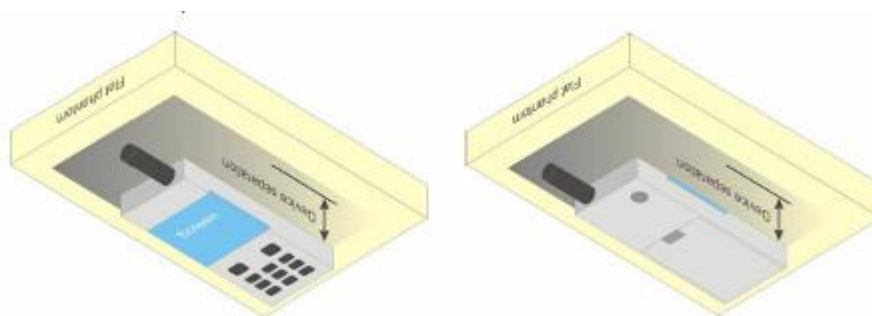

**Figure 7.3 Front, Side and Top View of Ear/15° Tilt Position**

## Test Position – Body Worn Configurations

Body Worn Position

- (a) To position the device parallel to the phantom surface with either keypad up or down.
- (b) To adjust the device parallel to the flat phantom.
- (c) To adjust the distance between the device surface and the flat phantom to 1.5 cm or holster surface and the flat phantom to 0 cm.



## **5 ANSI/IEEE C95.1 – 1999 RF EXPOSURE LIMIT**

In order for users to be aware of the body-worn operating requirements for meeting RF exposure compliance, operating instructions and cautions statements are included in the user's manual.

### **Uncontrolled Environment**

Uncontrolled Environments are defined as locations where there is the exposure of individuals who have no knowledge or control of their exposure. The general population/uncontrolled exposure limits are applicable to situations in which the general public may be exposed or in which persons who are exposed as a consequence of their employment may not be made fully aware of the potential for exposure or cannot exercise control over their exposure. Members of the general public would come under this category when exposure is not employment-related; for example, in the case of a wireless transmitter that exposes persons in its vicinity.

### **Controlled Environment**

Controlled Environments are defined as locations where there is exposure that may be incurred by persons who are aware of the potential for exposure, (i.e. as a result of employment or occupation). In general, occupational/controlled exposure limits are applicable to situations in which persons are exposed as a consequence of their employment, who have been made fully aware of the potential for exposure and can exercise control over their exposure. This exposure category is also applicable when the exposure is of a transient nature due to incidental passage through a location where the exposure levels may be higher than the general population/uncontrolled limits, but the exposed person is fully aware of the potential for exposure and can exercise control over his or her exposure by leaving the area or by some other appropriate means.

**Table 8.1 Human Exposure Limits**

|                                                              | UNCONTROLLED ENVIRONMENT<br>General Population<br>(W/kg) or (mW/g) | CONTROLLED ENVIROMENT<br>Professional Population<br>(W/kg) or (mW/g) |
|--------------------------------------------------------------|--------------------------------------------------------------------|----------------------------------------------------------------------|
| SPATIAL PEAK SAR <sup>1</sup><br>Brain                       | 1.60                                                               | 8.00                                                                 |
| SPATIAL AVERAGE SAR <sup>2</sup><br>Whole Body               | 0.08                                                               | 0.40                                                                 |
| SPATIAL PEAK SAR <sup>3</sup><br>Hands, Feet, Ankles, Wrists | 4.00                                                               | 20.00                                                                |

<sup>1</sup> The Spatial Peak value of the SAR averaged over any 1 gram of tissue (defined as a tissue volume in the shape of a cube) and over the appropriate averaging time.

<sup>2</sup> The Spatial Average value of the SAR averaged over the whole body.

<sup>3</sup> The Spatial Peak value of the SAR averaged over any 10 grams of tissue (defined as a tissue volume in the shape of a cube) and over the appropriate averaging time.

## 6 SYSTEM AND LIQUID VERIFICATION

### Basic SAR system validation requirements

The SAR system must be validated against its performance specifications before it is deployed. When SAR probes, system components or software are changed, upgraded or recalibrated, these must be validated with the SAR system(s) that operates with such components. Reference dipoles are used with the required tissue-equivalent media for system validation,

The detailed system validation results are maintained by each test laboratory, which are normally not required for equipment approval. Only a tabulated summary of the system validation status, according to the validation date(s), measurement frequencies, SAR probes and tissue dielectric parameters is required in the SAR report.

### System Setup

The system performance check verifies that the system operates within its specifications. System and operator errors can be detected and corrected. It is recommended that the system performance check be performed prior to any usage of the system in order to guarantee reproducible results. The system performance check uses normal SAR measurements in a simplified setup with a well characterized source. This setup was selected to give a high sensitivity to all parameters that might fail or vary over time. The system check does not intend to replace the calibration of the components, but indicates situations where the system uncertainty is exceeded due to drift or failure.

In the simplified setup for system evaluation, the DUT is replaced by a calibrated dipole and the power source is replaced by a continuous wave that comes from a signal generator. The calibrated dipole must be placed beneath the flat phantom section of the SAM twin phantom with the correct distance holder. The distance holder should touch the phantom surface with a light pressure at the reference marking and be oriented parallel to the long side of the phantom. The equipment setup is shown below:

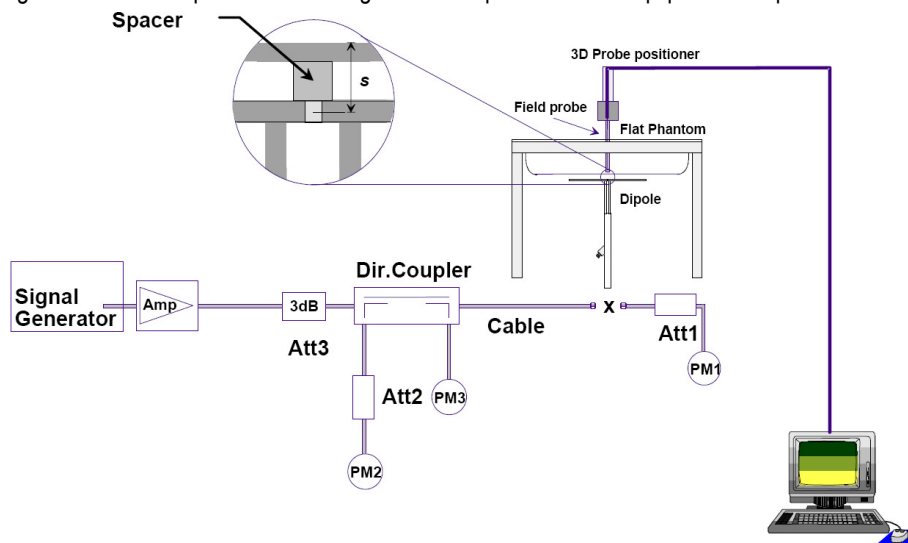

Fig 8.1 System Setup for System Evaluation

1. Signal Generator
2. Amplifier
3. Directional Coupler
4. Power Meter
5. Calibrated Dipole

Note: The output power on dipole port must be calibrated to 30 dBm (1000 mW) before dipole is connected.

## System Verification Results

Prior to SAR assessment, the system is verified to 10% of the SAR measurement on the reference dipole at the time of calibration by the calibration facility. Full system validation status and result summary can be found in below

**Target and measurement SAR after Normalized (1W):**

| Measurement Date | Frequency (MHz) | Liquid Type (head/body) | Target SAR1g (W/kg) | Measured SAR1g (W/kg) | Normalized SAR1g (W/kg) | Deviation (%) |
|------------------|-----------------|-------------------------|---------------------|-----------------------|-------------------------|---------------|
| Jan 16, 2017     | 835             | head                    | 9.65                | 0.0967                | 9.67                    | 0.21          |
| Jan 16, 2017     | 835             | body                    | 9.98                | 0.0993                | 9.93                    | -0.50         |
| Jan 17, 2017     | 1900            | head                    | 39.52               | 0.4036                | 40.36                   | 2.13          |
| Jan 17, 2017     | 1900            | body                    | 42.88               | 0.4275                | 42.75                   | -0.30         |

Note: system check input power: 10mW

## **Liquid Verification**

The dielectric parameters were checked prior to assessment using the HP85070C dielectric probe kit. The dielectric parameters measured are reported in each correspondent section.

### **KDB 865664 recommended Tissue Dielectric Parameters**

The head and body tissue parameters given in this below table should be used to measure the SAR of transmitters operating in 100 MHz to 6 GHz frequency range. The tissue dielectric parameters of the tissue medium at the test frequency should be within the tolerance required in this document. The dielectric parameters should be linearly interpolated between the closest pair of target frequencies to determine the applicable dielectric parameters corresponding to the device test frequency.

The head tissue dielectric parameters recommended by IEEE Std 1528-2013 have been incorporated in the following table. These head parameters are derived from planar layer models simulating the highest expected SAR for the dielectric properties and tissue thickness variations in a human head. Other head and body tissue parameters that have not been specified in 1528 are derived from tissue dielectric parameters computed from the 4-Cole-Cole equations described above and extrapolated according to the head parameters specified in 1528.

### **Liquid Confirmation Result:**

#### 1. Measured Head liquid Properties

| Date         | Freq.(MHz) | Liquid Parameters                       | Measured | Target | Delta (%) | Limit±(%) |
|--------------|------------|-----------------------------------------|----------|--------|-----------|-----------|
| Jan 16, 2017 | 835        | Relative Permittivity ( $\epsilon_r$ ): | 41.8     | 41.5   | 0.72      | 5         |
|              |            | Conductivity ( $\sigma$ ):              | 0.86     | 0.90   | -4.44     | 5         |
| Jan 17, 2017 | 1900       | Relative Permittivity ( $\epsilon_r$ ): | 40.5     | 40.0   | 1.25      | 5         |
|              |            | Conductivity ( $\sigma$ ):              | 1.42     | 1.40   | 1.43      | 5         |

#### 2. Measured Body liquid Properties

| Date         | Freq.(MHz) | Liquid Parameters                       | Measured | Target | Delta (%) | Limit±(%) |
|--------------|------------|-----------------------------------------|----------|--------|-----------|-----------|
| Jan 16, 2017 | 835        | Relative Permittivity ( $\epsilon_r$ ): | 55.18    | 55.20  | -0.04     | 5         |
|              |            | Conductivity ( $\sigma$ ):              | 0.95     | 0.97   | -2.06     | 5         |
| Jan 17, 2017 | 1900       | Relative Permittivity ( $\epsilon_r$ ): | 53.32    | 53.3   | 0.04      | 5         |
|              |            | Conductivity ( $\sigma$ ):              | 1.47     | 1.52   | -3.29     | 5         |

## System Verification Plots

Product Description: Dipole

Model: SID835

Test Date: Jan 16, 2017

|                                   |                            |
|-----------------------------------|----------------------------|
| Medium(liquid type)               | HSL_835                    |
| Frequency (MHz)                   | 835.000000                 |
| Relative permittivity (real part) | 41.8                       |
| Conductivity (S/m)                | 0.86                       |
| Input power                       | 10mW                       |
| E-Field Probe                     | SN 27/15 EPGO262           |
| Crest factor                      | 1.0                        |
| Conversion Factor                 | 1.74                       |
| Sensor-surface                    | 4mm                        |
| Area Scan                         | dx=8mm dy=8mm              |
| Zoom Scan                         | 5x5x7,dx=8mm dy=8mm dz=5mm |
| Variation (%)                     | 0.110000                   |
| SAR 10g (W/Kg)                    | 0.074811                   |
| SAR 1g (W/Kg)                     | 0.096752                   |

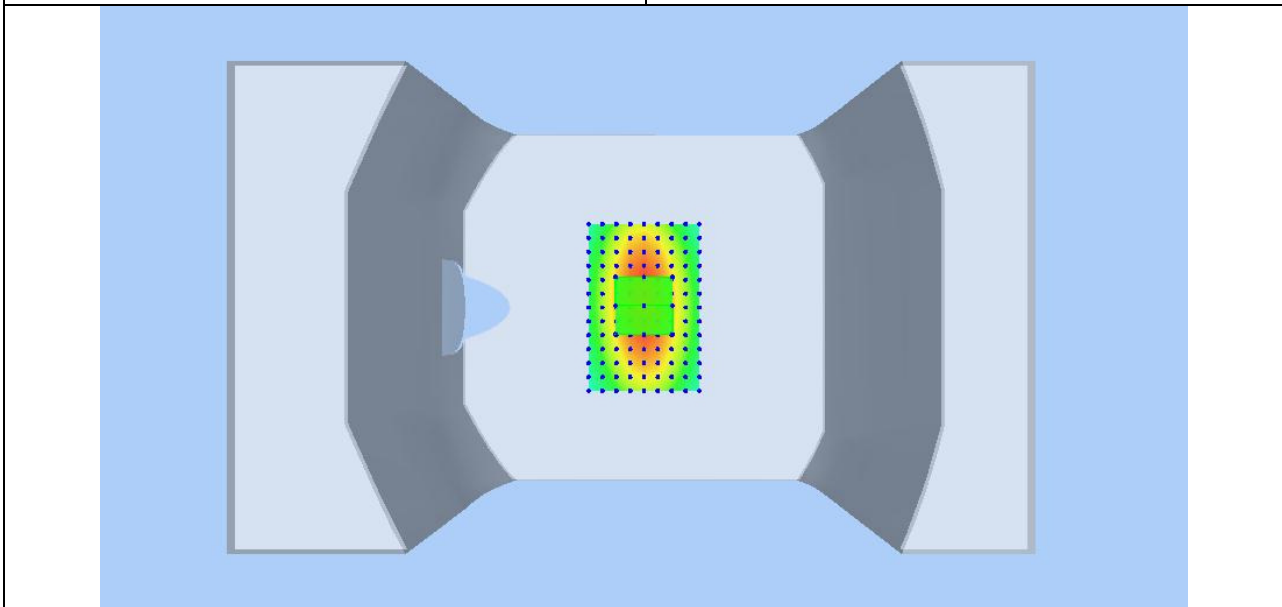
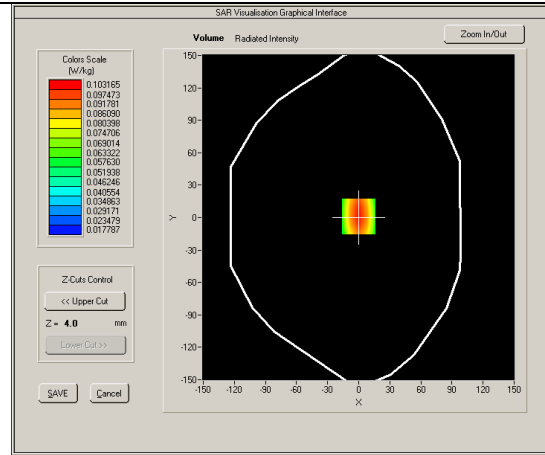
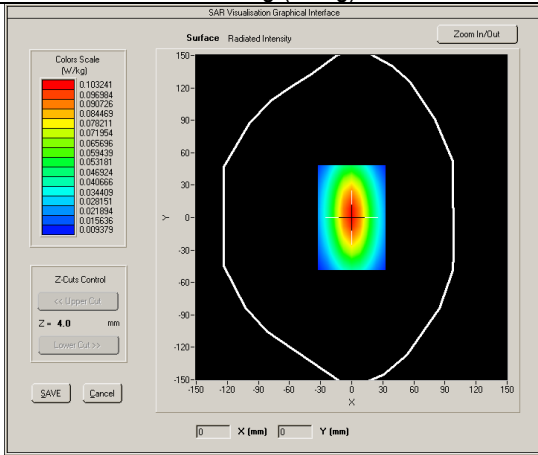



Product Description: Dipole  
 Model: SID835  
 Test Date: Jan 16, 2017

|                                   |                            |
|-----------------------------------|----------------------------|
| Medium(liquid type)               | MSL_835                    |
| Frequency (MHz)                   | 835.000000                 |
| Relative permittivity (real part) | 55.18                      |
| Conductivity (S/m)                | 0.95                       |
| Input power                       | 10mW                       |
| E-Field Probe                     | SN 27/15 EPGO262           |
| Crest factor                      | 1.0                        |
| Conversion Factor                 | 1.81                       |
| Sensor-surface                    | 4mm                        |
| Area Scan                         | dx=8mm dy=8mm              |
| Zoom Scan                         | 5x5x7,dx=8mm dy=8mm dz=5mm |
| Variation (%)                     | -0.25000                   |
| SAR 10g (W/Kg)                    | 0.063528                   |
| SAR 1g (W/Kg)                     | 0.099326                   |

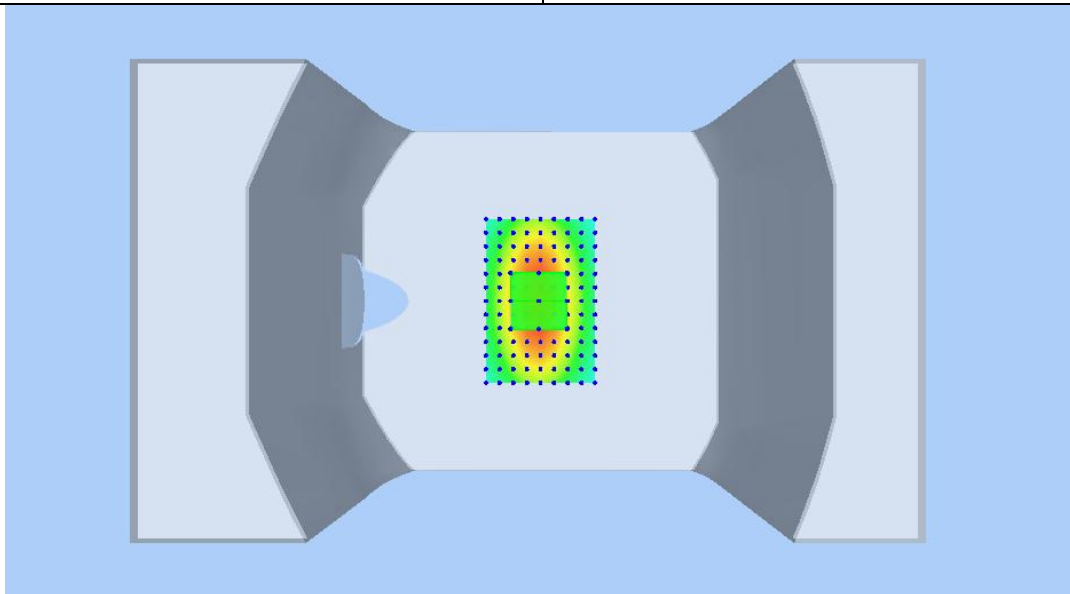
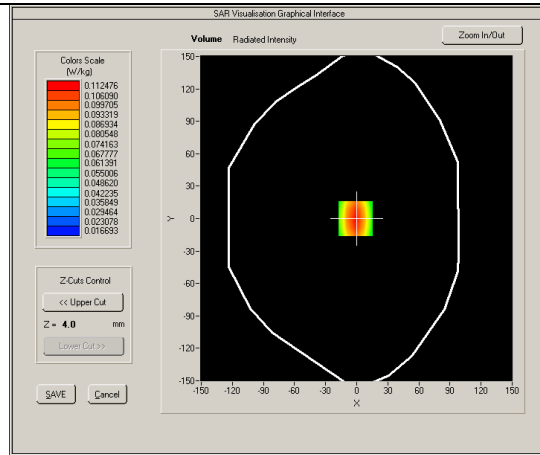
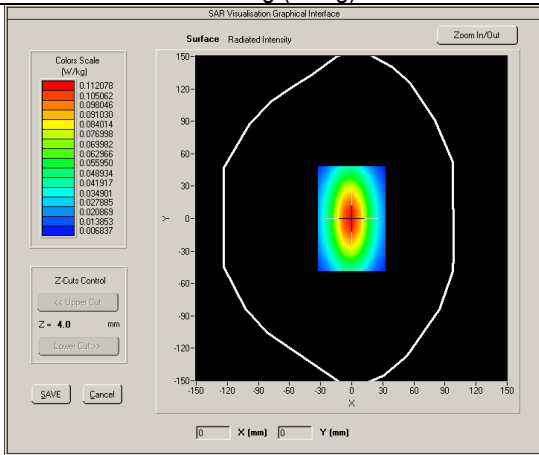

Product Description: Dipole  
 Model: SID1900  
 Test Date: Jan 17, 2017

|                                   |                            |
|-----------------------------------|----------------------------|
| Medium(liquid type)               | HSL_1900                   |
| Frequency (MHz)                   | 1900.000                   |
| Relative permittivity (real part) | 40.5                       |
| Conductivity (S/m)                | 1.42                       |
| Input power                       | 10mW                       |
| E-Field Probe                     | SN 27/15 EPGO262           |
| Crest factor                      | 1.0                        |
| Conversion Factor                 | 2.01                       |
| Sensor-Surface                    | 4mm                        |
| Area Scan                         | dx=8mm dy=8mm              |
| Zoom Scan                         | 5x5x7,dx=8mm dy=8mm dz=5mm |
| Variation (%)                     | 0.330000                   |
| SAR 10g (W/Kg)                    | 0.166045                   |
| SAR 1g (W/Kg)                     | 0.403605                   |

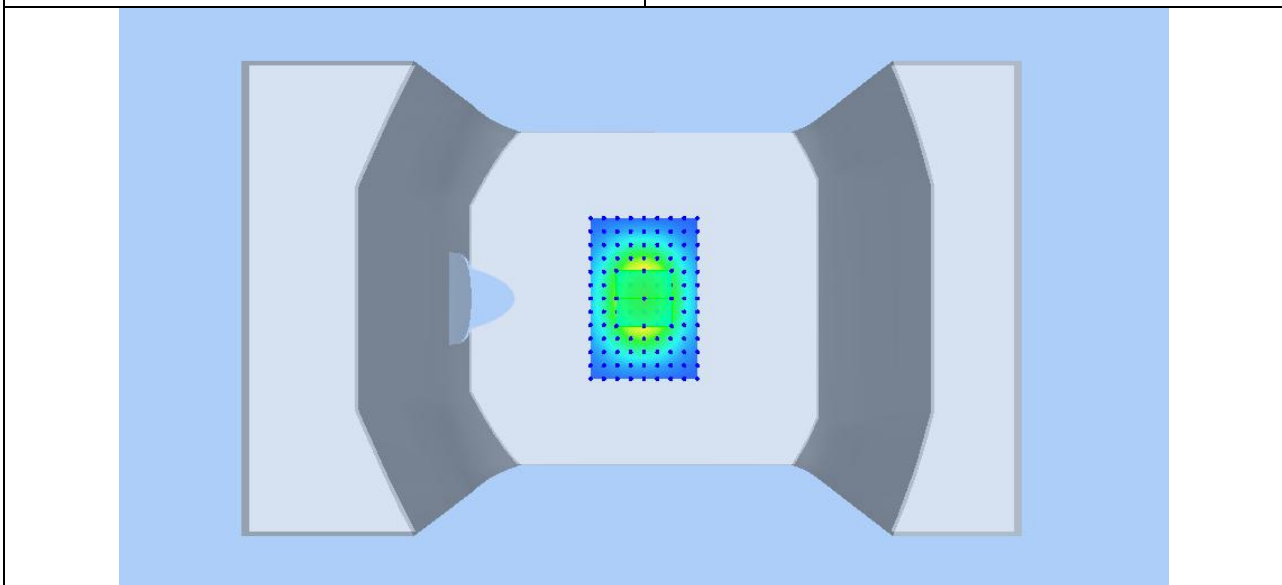
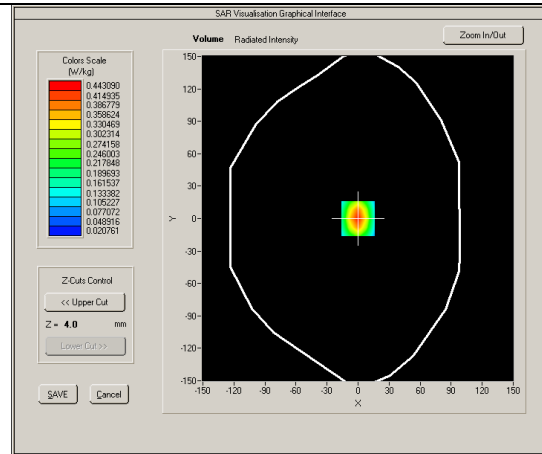
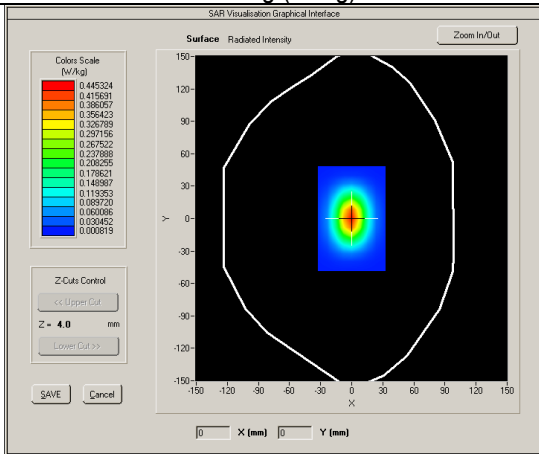

Product Description: Dipole  
 Model: SID1900  
 Test Date: Jan 17, 2017

|                                   |                            |
|-----------------------------------|----------------------------|
| Medium(liquid type)               | MSL_1900                   |
| Frequency (MHz)                   | 1900.000                   |
| Relative permittivity (real part) | 53.32                      |
| Conductivity (S/m)                | 1.47                       |
| Input power                       | 10mW                       |
| E-Field Probe                     | SN 27/15 EPGO262           |
| Crest factor                      | 1.0                        |
| Conversion Factor                 | 2.05                       |
| Sensor-Surface                    | 4mm                        |
| Area Scan                         | dx=8mm dy=8mm              |
| Zoom Scan                         | 5x5x7,dx=8mm dy=8mm dz=5mm |
| Variation (%)                     | -0.850000                  |
| SAR 10g (W/Kg)                    | 0.202144                   |
| SAR 1g (W/Kg)                     | 0.427573                   |

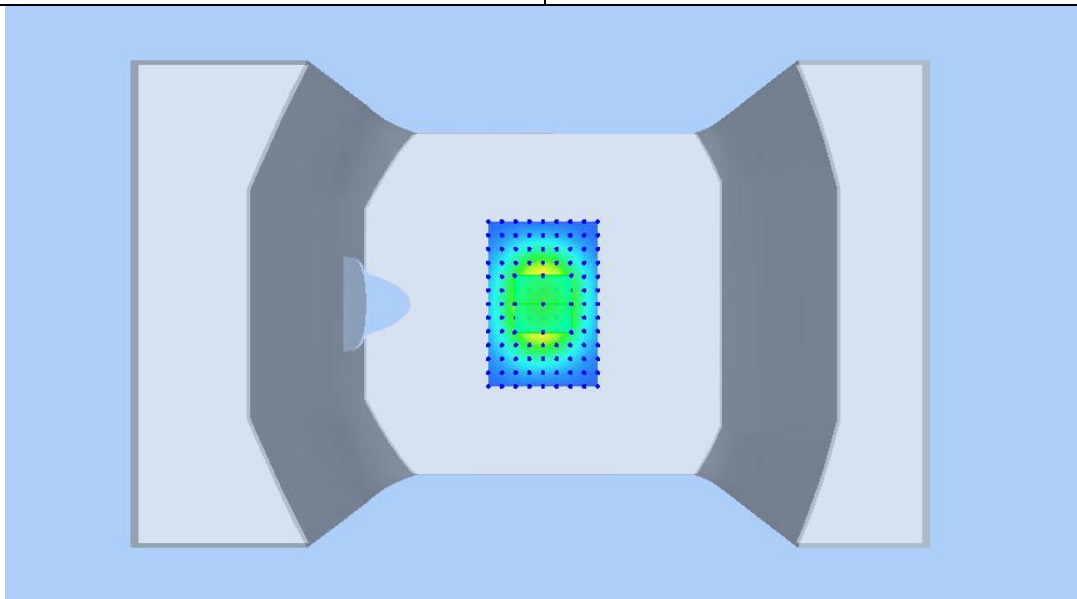
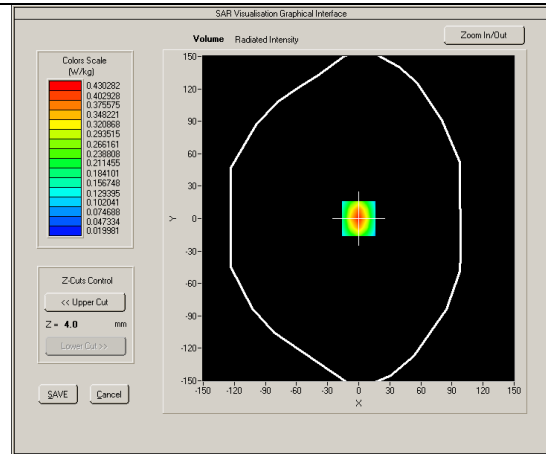
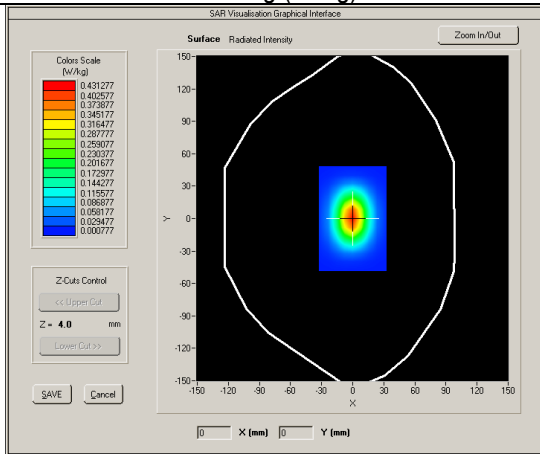

## **7 UNCERTAINTY ASSESSMENT**

The component of uncertainty may generally be categorized according to the methods used to evaluate them. The evaluation of uncertainty by the statistical analysis of a series of observations is termed a Type A evaluation of uncertainty. The evaluation of uncertainty by means other than the statistical analysis of a series of observation is termed a Type B evaluation of uncertainty. Each component of uncertainty, however evaluated, is represented by an estimated standard deviation, termed standard uncertainty, which is determined by the positive square root of the estimated variance

A Type A evaluation of standard uncertainty may be based on any valid statistical method for treating data. This includes calculating the standard deviation of the mean of a series of independent observations; using the method of least squares to fit a curve to the data in order to estimate the parameter of the curve and their standard deviations; or carrying out an analysis of variance in order to identify and quantify random effects in certain kinds of measurement.

A type B evaluation of standard uncertainty is typically based on scientific judgment using all of the relevant information available. These may include previous measurement data, experience and specification, data provided in calibration reports and uncertainties assigned to reference data taken from handbooks. Broadly speaking, the uncertainty is either obtained from an outdoor source or obtained from an assumed distribution, such as the normal distribution, rectangular or triangular distributions indicated in Table below :

| Uncertainty Distribution           | Normal             | Rectangle      | Triangular     | U Shape        |
|------------------------------------|--------------------|----------------|----------------|----------------|
| Multi-plying Factor <sup>(a)</sup> | 1/k <sup>(b)</sup> | 1 / $\sqrt{3}$ | 1 / $\sqrt{6}$ | 1 / $\sqrt{2}$ |

(a) standard uncertainty is determined as the product of the multiplying factor and the estimated range of variations in the measured quantity

(b)  $\kappa$  is the coverage factor

### Standard Uncertainty for Assumed Distribution

The combined standard uncertainty of the measurement result represents the estimated standard deviation of the result. It is obtained by combining the individual standard uncertainties of both Type A and Type -sum-by taking the positive square root of the estimated variances.

Expanded uncertainty is a measure of uncertainty that defines an interval about the measurement result within which the measured value is confidently believed to lie. It is obtained by multiplying the combined standard uncertainty by a coverage factor. Typically, the coverage factor ranges from 2 to 3. Using a coverage factor allows the true value of a measured quantity to be specified with a defined probability within the specified uncertainty range. For purpose of this document, a coverage factor two is used, which corresponds to confidence interval of about 95 %.

The COMOSAR Uncertainty Budget is show in below table:

The following table includes the uncertainty table of the IEEE 1528 from 300MHz to 3GHz and KDB865664 to 6GHZ too, The values are determined by Satimo.

## UNCERTAINTY FOR SYSTEM PERFORMANCE CHECK

| Uncertainty Component                                                           | Tol.<br>(± %) | Prob.<br>Dist. | Div. | ci<br>(1 g)           | ci<br>(10 g)          | 1 g<br>ui<br>(± %) | 10 g<br>ui<br>(± %) | Vi  |
|---------------------------------------------------------------------------------|---------------|----------------|------|-----------------------|-----------------------|--------------------|---------------------|-----|
| <b>Measurement System</b>                                                       |               |                |      |                       |                       |                    |                     |     |
| Probe Calibration                                                               | 5,8           | N              | 1    | 1                     | 1                     | 5,8                | 5,8                 | ∞   |
| Axial Isotropy                                                                  | 3,5           | R              | √3   | (1-cp) <sup>1/2</sup> | (1-cp) <sup>1/2</sup> | 1,42887            | 1,42887             | ∞   |
| Hemispherical Isotropy                                                          | 5,9           | R              | √3   | √Cp                   | √Cp                   | 2,40866            | 2,40866             | ∞   |
| Boundary Effect                                                                 | 1             | R              | √3   | 1                     | 1                     | 0,57735            | 0,57735             | ∞   |
| Linearity                                                                       | 4,7           | R              | √3   | 1                     | 1                     | 2,71355            | 2,71355             | ∞   |
| System Detection Limits                                                         | 1             | R              | √3   | 1                     | 1                     | 0,57735            | 0,57735             | ∞   |
| Readout Electronics                                                             | 0,5           | N              | 1    | 1                     | 1                     | 0,5                | 0,5                 | ∞   |
| Response Time                                                                   | 0             | R              | √3   | 1                     | 1                     | 0                  | 0                   | ∞   |
| Integration Time                                                                | 1,4           | R              | √3   | 1                     | 1                     | 0,80829            | 0,80829             | ∞   |
| RF Ambient Conditions                                                           | 3             | R              | √3   | 1                     | 1                     | 1,73205            | 1,73205             | ∞   |
| Probe Positioner Mechanical Tolerance                                           | 1,4           | R              | √3   | 1                     | 1                     | 0,80829            | 0,80829             | ∞   |
| Probe Positioning with respect to Phantom Shell                                 | 1,4           | R              | √3   | 1                     | 1                     | 0,80829            | 0,80829             | ∞   |
| Extrapolation, interpolation and Integration Algorithms for Max. SAR Evaluation | 2,3           | R              | √3   | 1                     | 1                     | 1,32791            | 1,32791             | ∞   |
| <b>Dipole</b>                                                                   |               |                |      |                       |                       |                    |                     |     |
| Dipole Axis to Liquid Distance                                                  | 2             | N              | √3   | 1                     | 1                     | 1,1547             | 1,1547              | N-1 |
| Input Power and SAR drift measurement                                           | 5             | R              | √3   | 1                     | 1                     | 2,88675            | 2,88675             | ∞   |
| <b>Phantom and Tissue Parameters</b>                                            |               |                |      |                       |                       |                    |                     |     |
| Phantom Uncertainty (shape and thickness tolerances)                            | 4             | R              | √3   | 1                     | 1                     | 2,3094             | 2,3094              | ∞   |
| Liquid Conductivity - deviation from target values                              | 5             | R              | √3   | 0,64                  | 0,43                  | 1,84752            | 1,2413              | ∞   |
| Liquid Conductivity - measurement uncertainty                                   | 4             | N              | 1    | 0,64                  | 0,43                  | 2,56               | 1,72                | M   |
| Liquid Permittivity - deviation from target values                              | 5             | R              | √3   | 0,6                   | 0,49                  | 1,73205            | 1,41451             | ∞   |
| Liquid Permittivity - measurement uncertainty                                   | 5             | N              | 1    | 0,6                   | 0,49                  | 3                  | 2,45                | M   |
| Combined Standard Uncertainty                                                   |               | RSS            |      |                       |                       | 9,6671             | 9,1645              |     |
| Expanded Uncertainty (95% CONFIDENCE INTERVAL)                                  |               | k              |      |                       |                       | 19,3342            | 18,3290             |     |

## UNCERTAINTY EVALUATION FOR HANDSET SAR TEST

| Uncertainty Component                                                           | Tol.<br>(± %) | Prob.<br>Dist. | Div.       | $c_i$<br>(1 g)  | $c_i$<br>(10 g) | 1 g<br>$u_i$<br>(± %) | 10 g<br>$u_i$<br>(± %) | $v_i$ |
|---------------------------------------------------------------------------------|---------------|----------------|------------|-----------------|-----------------|-----------------------|------------------------|-------|
| <b>Measurement System</b>                                                       |               |                |            |                 |                 |                       |                        |       |
| Probe Calibration                                                               | 5,8           | N              | 1          | 1               | 1               | 5,8                   | 5,8                    | ∞     |
| Axial Isotropy                                                                  | 3,5           | R              | $\sqrt{3}$ | $(1-c_p)^{1/2}$ | $(1-c_p)^{1/2}$ | 1,43                  | 1,43                   | ∞     |
| Hemispherical Isotropy                                                          | 5,9           | R              | $\sqrt{3}$ | $\sqrt{C_p}$    | $\sqrt{C_p}$    | 2,41                  | 2,41                   | ∞     |
| Boundary Effect                                                                 | 1             | R              | $\sqrt{3}$ | 1               | 1               | 0,58                  | 0,58                   | ∞     |
| Linearity                                                                       | 4,7           | R              | $\sqrt{3}$ | 1               | 1               | 2,71                  | 2,71                   | ∞     |
| System Detection Limits                                                         | 1             | R              | $\sqrt{3}$ | 1               | 1               | 0,58                  | 0,58                   | ∞     |
| Readout Electronics                                                             | 0,5           | N              | 1          | 1               | 1               | 0,50                  | 0,50                   | ∞     |
| Response Time                                                                   | 0             | R              | $\sqrt{3}$ | 1               | 1               | 0,00                  | 0,00                   | ∞     |
| Integration Time                                                                | 1,4           | R              | $\sqrt{3}$ | 1               | 1               | 0,81                  | 0,81                   | ∞     |
| RF Ambient Conditions                                                           | 3             | R              | $\sqrt{3}$ | 1               | 1               | 1,73                  | 1,73                   | ∞     |
| Probe Positioner Mechanical Tolerance                                           | 1,4           | R              | $\sqrt{3}$ | 1               | 1               | 0,81                  | 0,81                   | ∞     |
| Probe Positioning with respect to Phantom Shell                                 | 1,4           | R              | $\sqrt{3}$ | 1               | 1               | 0,81                  | 0,81                   | ∞     |
| Extrapolation, interpolation and Integration Algorithms for Max. SAR Evaluation | 2,3           | R              | $\sqrt{3}$ | 1               | 1               | 1,33                  | 1,33                   | ∞     |
| <b>Test sample Related</b>                                                      |               |                |            |                 |                 |                       |                        |       |
| Test Sample Positioning                                                         | 2,6           | N              | 1          | 1               | 1               | 2,60                  | 2,60                   | N-1   |
| Device Holder Uncertainty                                                       | 3             | N              | 1          | 1               | 1               | 3,00                  | 3,00                   | N-1   |
| Output Power Variation - SAR drift measurement                                  | 5             | R              | $\sqrt{3}$ | 1               | 1               | 2,89                  | 2,89                   | ∞     |
| <b>Phantom and Tissue Parameters</b>                                            |               |                |            |                 |                 |                       |                        |       |
| Phantom Uncertainty (shape and thickness tolerances)                            | 4             | R              | $\sqrt{3}$ | 1               | 1               | 2,31                  | 2,31                   | ∞     |
| Liquid Conductivity - deviation from target values                              | 5             | R              | $\sqrt{3}$ | 0,64            | 0,43            | 1,85                  | 1,24                   | ∞     |
| Liquid Conductivity - measurement uncertainty                                   | 4             | N              | 1          | 0,64            | 0,43            | 2,56                  | 1,72                   | M     |
| Liquid Permittivity - deviation from target values                              | 5             | R              | $\sqrt{3}$ | 0,6             | 0,49            | 1,73                  | 1,41                   | ∞     |
| Liquid Permittivity - measurement uncertainty                                   | 5             | N              | 1          | 0,6             | 0,49            | 3,00                  | 2,45                   | M     |
| Combined Standard Uncertainty                                                   |               | RSS            |            |                 |                 | 10,39                 | 9,92                   |       |
| Expanded Uncertainty (95% CONFIDENCE INTERVAL)                                  |               | k              |            |                 |                 | 20,78                 | 19,84                  |       |

## 8 TEST INSTRUMENT

### TEST INSTRUMENTATION

| Name of Equipment                                | Manufacturer             | Type/Model      | Serial Number     | Calibration Date | Calibration Due |
|--------------------------------------------------|--------------------------|-----------------|-------------------|------------------|-----------------|
| P C                                              | Compaq                   | PV 3.06GHz      | 375052-AA1        | N/A              | N/A             |
| Signal Generator                                 | Agilent                  | 8665B-008       | 3744A10293        | 05/15/2016       | 05/15/2017      |
| MultiMeter                                       | Keithley                 | MiltiMeter 2000 | 1259033           | 06/21/2016       | 06/21/2017      |
| S-Parameter Network Analyzer                     | Agilent                  | 8753ES          | US39173518        | 08/04/2016       | 08/04/2017      |
| Wireless Communication Test Set                  | R & S                    | CMU200          | 111078            | 07/22/2016       | 07/22/2017      |
| Power Meter                                      | HP                       | 437B            | 3038A03648        | 05/17/2016       | 05/17/2017      |
| E-field PROBE                                    | MVG                      | SSE2            | SN 27/15 EPGO262  | 09/20/2016       | 09/20/2017      |
| DIPOLE 835                                       | SATIMO                   | SID 835         | SN 18/11 DIPC 150 | 06/24/2016       | 06/18/2017      |
| DIPOLE 1900                                      | SATIMO                   | SID 1900        | SN 18/11 DIPG 153 | 06/24/2016       | 06/18/2017      |
| Communication Antenna                            | SATIMO                   | ANTA3           | SN 20/11 ANTA 3   | 06/21/2016       | 06/20/2017      |
| Laptop POSITIONING DEVICE                        | SATIMO                   | LSH15           | SN 24/11 LSH15    | N/A              | N/A             |
| ePOSITIONING DEVICE                              | SATIMO                   | MSH73           | SN 24/11 MSH73    | N/A              | N/A             |
| DUMMY PROBE                                      | ANTENNESSA               |                 | DP41              | N/A              | N/A             |
| SAM PHANTOM                                      | SATIMO                   | SAM87           | SN 24/11 SAM87    | N/A              | N/A             |
| Elliptic Phantom                                 | SATIMO                   | ELLI20          | SN 20/11ELLI20    | N/A              | N/A             |
| PHANTOM TABLE                                    | SATIMO                   | N/A             | N/A               | N/A              | N/A             |
| 6 AXIS ROBOT                                     | KUKA                     | KR5             | 949272            | N/A              | N/A             |
| high Power Solid State Amplifier (80MHz~1000MHz) | Instruments for Industry | CMC150          | M631-0408         | 05/16/2016       | 05/16/2017      |
| Medium Power Solid State Amplifier (0.8~4.2GHz)  | Instruments for Industry | S41-25          | M629-0408         | 06/28/2016       | 06/28/2017      |
| Wave Tube Amplifier 4-8 GHz at 20Watt            | Hughes Aircraft Company  | 1277H02F000     | 81                | 08/22/2016       | 08/22/2017      |

## 9 OUTPUT POWER VERIFICATION

### Test Condition:

1. Conducted Measurement  
EUT was set for low, mid, high channel with modulated mode and highest RF output power.  
The base station simulator was connected to the antenna terminal.
2. Conducted Emissions Measurement Uncertainty  
All test measurements carried out are traceable to national standards. The uncertainty of the measurement at a confidence level of approximately 95% (in the case where distributions are normal), with a coverage factor of 2, in the range 30MHz – 40GHz is  $\pm 1.5$ dB.
3. Environmental Conditions
 

|                      |          |
|----------------------|----------|
| Temperature          | 23°C     |
| Relative Humidity    | 53%      |
| Atmospheric Pressure | 1019mbar |
4. Test Date : Jan 16, 2017  
Tested By : Wiky Jam

### Test Procedures:

#### 3G feature phone radio output power measurement

1. The transmitter output port was connected to base station emulator.
2. Establish communication link between emulator and EUT and set EUT to operate at maximum output power all the time.
3. Select lowest, middle, and highest channels for each band and different possible test mode.
4. Measure the conducted peak burst power and conducted average burst power from EUT antenna port.

#### Other radio output power measurement

The output power was measured using power meter at low, mid, and hi channels.

### Source-based Time Averaged Burst Power Calculation:

For TDMA, the following duty cycle factor was used to calculate the source-based time average power

| Number of Time slot | 1        | 2        | 3        | 4        |
|---------------------|----------|----------|----------|----------|
| Duty Cycle          | 1:8      | 1:4      | 1:2.66   | 1:2      |
| Duty cycle factor   | -9.03 dB | -6.02 dB | -4.26 dB | -3.01 dB |
| Crest Factor        | 8        | 4        | 2.66     | 2        |

**Remark:** *Time slot duty cycle factor =  $10 * \log (1 / \text{Time Slot Duty Cycle})$*

*Source based time averaged power = Maximum burst averaged power (1 Uplink) – 9.03 dB*

*Source based time averaged power = Maximum burst averaged power (2 Uplink) – 6.02 dB*

*Source based time averaged power = Maximum burst averaged power (4 Uplink) – 3.01 dB*



**Test Result:**

**GSM:**

| Burst Average Power (dBm);                                                                                                                                                                                                                                                                                                       |        |       |       |                        |         |       |        |                        |
|----------------------------------------------------------------------------------------------------------------------------------------------------------------------------------------------------------------------------------------------------------------------------------------------------------------------------------|--------|-------|-------|------------------------|---------|-------|--------|------------------------|
| Band                                                                                                                                                                                                                                                                                                                             | GSM850 |       |       |                        | PCS1900 |       |        |                        |
| Channel                                                                                                                                                                                                                                                                                                                          | 128    | 190   | 251   | Tune up Power tolerant | 512     | 661   | 810    | Tune up Power tolerant |
| Frequency (MHz)                                                                                                                                                                                                                                                                                                                  | 824.2  | 836.6 | 848.8 | /                      | 1850.2  | 1880  | 1909.8 | /                      |
| GSM Voice (1 uplink),GMSK                                                                                                                                                                                                                                                                                                        | 32.60  | 32.71 | 32.79 | 32±1                   | 29.81   | 29.71 | 29.62  | 29±1                   |
| GPRS Multi-Slot Class 8 (1 uplink),GMSK                                                                                                                                                                                                                                                                                          | 32.58  | 32.70 | 32.78 | 32±1                   | 29.89   | 29.73 | 29.65  | 29±1                   |
| GPRS Multi-Slot Class 10 (2 uplink),GMSK                                                                                                                                                                                                                                                                                         | 31.56  | 31.70 | 31.75 | 31±1                   | 29.02   | 28.85 | 28.72  | 29±1                   |
| GPRS Multi-Slot Class 12 (4 uplink),GMSK                                                                                                                                                                                                                                                                                         | 28.90  | 29.02 | 29.06 | 29±1                   | 26.07   | 25.95 | 25.86  | 26±1                   |
| EGPRS Multi-Slot Class 8 (1 uplink) MCS1 GMSK                                                                                                                                                                                                                                                                                    | 32.56  | 32.64 | 32.75 | 32±1                   | 29.08   | 29.95 | 29.83  | 29±1                   |
| EGPRS Multi-Slot Class 10 (2 uplink) MCS1 GMSK                                                                                                                                                                                                                                                                                   | 31.55  | 31.69 | 31.74 | 31±1                   | 29.13   | 29.01 | 28.91  | 29±1                   |
| EGPRS Multi-Slot Class 12 (4 uplink) MCS1 GMSK                                                                                                                                                                                                                                                                                   | 28.88  | 29.01 | 29.04 | 29±1                   | 26.23   | 26.11 | 25.96  | 26±1                   |
| EGPRS Multi-Slot Class 8 (1 uplink) MCS5 8PSK                                                                                                                                                                                                                                                                                    | 27.60  | 27.78 | 27.94 | 27±1                   | 25.57   | 25.47 | 25.42  | 25±1                   |
| EGPRS Multi-Slot Class 10 (2 uplink) MCS5 8PSK                                                                                                                                                                                                                                                                                   | 26.66  | 26.67 | 26.65 | 26±1                   | 24.64   | 24.60 | 24.48  | 24±1                   |
| EGPRS Multi-Slot Class 12 (4 uplink) MCS5 8PSK                                                                                                                                                                                                                                                                                   | 23.93  | 23.95 | 23.91 | 23±1                   | 21.82   | 21.86 | 21.79  | 21±1                   |
| Remark :<br>GPRS, CS1 coding scheme.<br>EGPRS, MCS1 coding scheme.<br>EGPRS, MCS5 coding scheme.<br>Multi-Slot Class 8 , Support Max 4 downlink, 1 uplink , 5 working link<br>Multi-Slot Class 10 , Support Max 4 downlink, 2 uplink , 5 working link<br>Multi-Slot Class 12 , Support Max 4 downlink, 4 uplink , 5 working link |        |       |       |                        |         |       |        |                        |

| Source Based time Average Power (dBm)                                                                                                                                                                                                                                   |        |       |       |                     |         |       |        |                     |
|-------------------------------------------------------------------------------------------------------------------------------------------------------------------------------------------------------------------------------------------------------------------------|--------|-------|-------|---------------------|---------|-------|--------|---------------------|
| Band                                                                                                                                                                                                                                                                    | GSM850 |       |       |                     | PCS1900 |       |        |                     |
| Channel                                                                                                                                                                                                                                                                 | 128    | 190   | 251   | Time Average factor | 512     | 661   | 810    | Time Average factor |
| Frequency (MHz)                                                                                                                                                                                                                                                         | 824.2  | 836.6 | 848.8 | /                   | 1850.2  | 1880  | 1909.8 | /                   |
| GSM Voice (1 uplink),GMSK                                                                                                                                                                                                                                               | 23.57  | 23.68 | 23.76 | -9.03               | 20.78   | 20.68 | 20.59  | -9.03               |
| GPRS Multi-Slot Class 8 (1 uplink),GMSK                                                                                                                                                                                                                                 | 23.55  | 23.67 | 23.75 | -9.03               | 20.86   | 20.70 | 20.62  | -9.03               |
| GPRS Multi-Slot Class 10 (2 uplink),GMSK                                                                                                                                                                                                                                | 25.54  | 25.68 | 25.73 | -6.02               | 23.00   | 22.83 | 22.70  | -6.02               |
| GPRS Multi-Slot Class 12 (4 uplink),GMSK                                                                                                                                                                                                                                | 25.89  | 26.01 | 26.05 | -3.01               | 23.06   | 22.94 | 22.85  | -3.01               |
| EGPRS Multi-Slot Class 8 (1 uplink) MCS1 GMSK                                                                                                                                                                                                                           | 23.53  | 23.61 | 23.72 | -9.03               | 20.05   | 20.92 | 20.80  | -9.03               |
| EGPRS Multi-Slot Class 10 (2 uplink) MCS1 GMSK                                                                                                                                                                                                                          | 25.53  | 25.67 | 25.72 | -6.02               | 23.11   | 22.99 | 22.89  | -6.02               |
| EGPRS Multi-Slot Class 12 (4 uplink) MCS1 GMSK                                                                                                                                                                                                                          | 25.87  | 26.00 | 26.03 | -3.01               | 23.22   | 23.10 | 22.95  | -3.01               |
| EGPRS Multi-Slot Class 8 (1 uplink) MCS5 8PSK                                                                                                                                                                                                                           | 18.57  | 18.75 | 18.91 | -9.03               | 16.54   | 16.44 | 16.39  | -9.03               |
| EGPRS Multi-Slot Class 10 (2 uplink) MCS5 8PSK                                                                                                                                                                                                                          | 20.64  | 20.65 | 20.63 | -6.02               | 18.62   | 18.58 | 18.46  | -6.02               |
| EGPRS Multi-Slot Class 12 (4 uplink) MCS5 8PSK                                                                                                                                                                                                                          | 20.92  | 20.94 | 20.90 | -3.01               | 18.81   | 18.85 | 18.78  | -3.01               |
| Remark :<br>Time average factor = 1 uplink , $10 \cdot \log(1/8) = -9.03\text{dB}$ , 2 uplink , $10 \cdot \log(2/8) = -6.02\text{dB}$ , 4 uplink , $10 \cdot \log(4/8) = -3.01\text{dB}$<br>Source based time average power = Burst Average power + Time Average factor |        |       |       |                     |         |       |        |                     |

**Note:** 1. due to the source based time average power; Body SAR was performed at GPRS Multi-slot class 12 for GPRS850 and EGPRS Multi-slot class 12 for GPRS1900.

**WCDMA BAND V**

| Band/ Time Slot configuration | Channel | Frequency | Average power (dBm) | Tune up Power tolerant |
|-------------------------------|---------|-----------|---------------------|------------------------|
| RMC<br>12.2kbps               | 4132    | 826.4     | 21.63               | 22±1                   |
|                               | 4175    | 835.0     | 21.73               | 22±1                   |
|                               | 4233    | 846.6     | 21.52               | 22±1                   |
| HSDPA<br>Subtest1             | 4132    | 826.4     | 20.56               | 21.3±1                 |
|                               | 4175    | 835.0     | 20.58               | 21.3±1                 |
|                               | 4233    | 846.6     | 20.51               | 21.3±1                 |
| HSDPA<br>Subtest2             | 4132    | 826.4     | 20.53               | 21.3±1                 |
|                               | 4175    | 835.0     | 20.52               | 21.3±1                 |
|                               | 4233    | 846.6     | 20.53               | 21.3±1                 |
| HSDPA<br>Subtest3             | 4132    | 826.4     | 20.56               | 21.3±1                 |
|                               | 4175    | 835.0     | 20.58               | 21.3±1                 |
|                               | 4233    | 846.6     | 20.51               | 21.3±1                 |
| HSDPA<br>Subtest4             | 4132    | 826.4     | 20.49               | 21.3±1                 |
|                               | 4175    | 835.0     | 20.47               | 21.3±1                 |
|                               | 4233    | 846.6     | 20.39               | 21.3±1                 |
| HSUPA<br>Subtest1             | 4132    | 826.4     | 20.48               | 21.3±1                 |
|                               | 4175    | 835.0     | 20.58               | 21.3±1                 |
|                               | 4233    | 846.6     | 20.51               | 21.3±1                 |
| HSUPA<br>Subtest2             | 4132    | 826.4     | 20.53               | 21.3±1                 |
|                               | 4175    | 835.0     | 20.59               | 21.3±1                 |
|                               | 4233    | 846.6     | 20.53               | 21.3±1                 |
| HSUPA<br>Subtest3             | 4132    | 826.4     | 20.55               | 21.3±1                 |
|                               | 4175    | 835.0     | 20.54               | 21.3±1                 |
|                               | 4233    | 846.6     | 20.46               | 21.3±1                 |
| HSUPA<br>Subtest4             | 4132    | 826.4     | 20.49               | 21.3±1                 |
|                               | 4175    | 835.0     | 20.41               | 21.3±1                 |
|                               | 4233    | 846.6     | 20.56               | 21.3±1                 |
| HSUPA<br>Subtest5             | 4132    | 826.4     | 20.48               | 21.3±1                 |
|                               | 4175    | 835.0     | 20.53               | 21.3±1                 |
|                               | 4233    | 846.6     | 20.53               | 21.3±1                 |

**Note:** 1. Due to the maximum SAR for 12.2kbps RMC < 75% of the SAR limit, SAR was performed at RMC 12.2kbps.

**WCDMA Band II :**

| Band/ Time Slot configuration | Channel | Frequency | Average power (dBm) | Tune up Power tolerant |
|-------------------------------|---------|-----------|---------------------|------------------------|
| RMC<br>12.2kbps               | 9262    | 1852.4    | 21.93               | 22±1                   |
|                               | 9400    | 1880.0    | 22.07               | 22±1                   |
|                               | 9538    | 1907.6    | 21.86               | 22±1                   |
| HSDPA<br>Subtest1             | 9262    | 1852.4    | 20.80               | 21.3±1                 |
|                               | 9400    | 1880.0    | 20.75               | 21.3±1                 |
|                               | 9538    | 1907.6    | 20.86               | 21.3±1                 |
| HSDPA<br>Subtest2             | 9262    | 1852.4    | 20.86               | 21.3±1                 |
|                               | 9400    | 1880.0    | 20.85               | 21.3±1                 |
|                               | 9538    | 1907.6    | 20.84               | 21.3±1                 |
| HSDPA<br>Subtest3             | 9262    | 1852.4    | 20.84               | 21.3±1                 |
|                               | 9400    | 1880.0    | 20.8/1              | 21.3±1                 |
|                               | 9538    | 1907.6    | 20.59               | 21.3±1                 |
| HSDPA<br>Subtest4             | 9262    | 1852.4    | 20.84               | 21.3±1                 |
|                               | 9400    | 1880.0    | 20.87               | 21.3±1                 |
|                               | 9538    | 1907.6    | 20.88               | 21.3±1                 |
| HSUPA<br>Subtest1             | 9262    | 1852.4    | 20.83               | 21.3±1                 |
|                               | 9400    | 1880.0    | 20.85               | 21.3±1                 |
|                               | 9538    | 1907.6    | 20.89               | 21.3±1                 |
| HSUPA<br>Subtest2             | 9262    | 1852.4    | 20.89               | 21.3±1                 |
|                               | 9400    | 1880.0    | 20.87               | 21.3±1                 |
|                               | 9538    | 1907.6    | 20.84               | 21.3±1                 |
| HSUPA<br>Subtest3             | 9262    | 1852.4    | 20.79               | 21.3±1                 |
|                               | 9400    | 1880.0    | 20.69               | 21.3±1                 |
|                               | 9538    | 1907.6    | 20.68               | 21.3±1                 |
| HSUPA<br>Subtest4             | 9262    | 1852.4    | 20.74               | 21.3±1                 |
|                               | 9400    | 1880.0    | 20.77               | 21.3±1                 |
|                               | 9538    | 1907.6    | 20.76               | 21.3±1                 |
| HSUPA<br>Subtest5             | 9262    | 1852.4    | 20.79               | 21.3±1                 |
|                               | 9400    | 1880.0    | 20.81               | 21.3±1                 |
|                               | 9538    | 1907.6    | 20.83               | 21.3±1                 |

**Note:** 1. Due to the maximum SAR for 12.2kbps RMC < 75% of the SAR limit, SAR was performed at RMC 12.2kbps.

### Bluetooth Measurement Result

| Mode          | Frequency (MHz) | Output Power(dBm) | Tune up limited(dBm) |
|---------------|-----------------|-------------------|----------------------|
| GFSK          | 2402            | 4.751             | 5 ± 1                |
|               | 2441            | 5.828             | 5 ± 1                |
|               | 2480            | 5.850             | 5 ± 1                |
| $\pi$ /4DQPSK | 2402            | 4.572             | 5 ± 1                |
|               | 2441            | 5.599             | 5 ± 1                |
|               | 2480            | 5.596             | 5 ± 1                |
| 8DPSK         | 2402            | 4.488             | 5 ± 1                |
|               | 2441            | 5.786             | 5 ± 1                |
|               | 2480            | 5.804             | 5 ± 1                |

**Note:** **Note: 1.** BT power was test and only Maximum Power was provide here.

**2.** SAR Test Exclusion Threshold for BT is about 9.6mW, the maximum tune up power of BT is 6dBm=4mW, no stand-alone SAR is required.

## 10 SAR TEST RESULTS

### Test Condition:

|    |                                                                                                                                                                                                                 |                      |          |
|----|-----------------------------------------------------------------------------------------------------------------------------------------------------------------------------------------------------------------|----------------------|----------|
| 1. | SAR Measurement<br>The distance between the EUT and the antenna of the emulator is more than 50 cm and the output power radiated from the emulator antenna is at least 30 dB less than the output power of EUT. |                      |          |
| 2. | Measurement Uncertainty: See page 34 for detail                                                                                                                                                                 |                      |          |
| 3. | Environmental Conditions                                                                                                                                                                                        | Temperature          | 23°C     |
|    |                                                                                                                                                                                                                 | Relative Humidity    | 53%      |
|    |                                                                                                                                                                                                                 | Atmospheric Pressure | 1019mbar |
| 4. | Test Date : Jan 16, 2017~ Jan 17, 2017<br>Tested By : Wiky Jam                                                                                                                                                  |                      |          |

### Generally Test Procedures:

1. Establish communication link between EUT and base station emulation by air link.
2. Place the EUT in the selected test position. (Cheek, tilt or flat)
3. Perform SAR testing at middle or highest output power channel under the selected test mode. If the measured 1-g SAR is  $\leq 0.8$  W/kg, then testing for the other channel will not be performed.
4. When SAR is  $< 0.8$  W/kg, no repeated SAR measurement is required

### For WCDMA test:

1. KDB941225 D01-Body SAR is not required for HSDPA when the average output of each RF channel with HSDPA active is less than 0.25dB higher than measured without HSDPA using 12.2kbps RMC or the maximum SAR for 12.2kbps RMC  $< 75\%$  of the SAR limit.
2. KDB941225 D01-Body SAR is not required for handset with HSPA capabilities when the maximum average output of each RF channel with HSUPA/HSDPA active is less than 0.25dB higher than that measure without HSUPA/HSDPA using 12.2kbps RMC and the maximum SAR for 12.2kbps RMC is  $< 75\%$  of the SAR limit

### SAR Summary Test Result:

#### GSM850

| Date of Measured : Jan 16, 2017 |         |                 | Body-worn/Hotspot Separation Distance: 15mm |                 |                       |                                  |                                      |                                |
|---------------------------------|---------|-----------------|---------------------------------------------|-----------------|-----------------------|----------------------------------|--------------------------------------|--------------------------------|
| Position                        | Channel | Mode            | SAR<br>1g(W/kg)                             | Limit<br>(W/kg) | Power<br>Drift<br>(%) | Maximum<br>Turn-up<br>Power(dBm) | measured<br>output<br>power<br>(dBm) | Scaled<br>Maximum<br>SAR(W/kg) |
| Right Head<br>Cheek             | Mid     | GSM<br>voice    | 0.461                                       | 1.6             | 2.30                  | 33                               | 32.71                                | 0.49                           |
| Right Head<br>Tilt              | Mid     | GSM<br>voice    | 0.364                                       | 1.6             | 2.14                  | 33                               | 32.71                                | 0.39                           |
| Left Head<br>Cheek              | Mid     | GSM<br>voice    | 0.443                                       | 1.6             | -0.20                 | 33                               | 32.71                                | 0.47                           |
| Left Head<br>Tilt               | Mid     | GSM<br>voice    | 0.378                                       | 1.6             | 1.36                  | 33                               | 32.71                                | 0.40                           |
| Body<br>Front-side              | Mid     | GPRS<br>Class12 | 0.795                                       | 1.6             | -4.05                 | 30                               | 29.02                                | 1.00                           |
| Body<br>Back-side               | Mid     | GPRS<br>Class12 | 0.758                                       | 1.6             | -2.00                 | 30                               | 29.02                                | 0.95                           |

**WCDMA BAND V (850)**

| Date of Measured : Jan 16, 2017 |         |                 | Body-worn/Hotspot Separation Distance: 15mm |                 |                       |                                  |                                      |                                |
|---------------------------------|---------|-----------------|---------------------------------------------|-----------------|-----------------------|----------------------------------|--------------------------------------|--------------------------------|
| Position                        | Channel | Mode            | SAR<br>1g(W/kg)                             | Limit<br>(W/kg) | Power<br>Drift<br>(%) | Maximum<br>Turn-up<br>Power(dBm) | measured<br>output<br>power<br>(dBm) | Scaled<br>Maximum<br>SAR(W/kg) |
| Right Head<br>Cheek             | Mid     | RMC<br>12.2kbps | 0.310                                       | 1.6             | 3.32                  | 23                               | 21.73                                | 0.42                           |
| Right Head<br>Tilt              | Mid     | RMC<br>12.2kbps | 0.234                                       | 1.6             | 2.07                  | 23                               | 21.73                                | 0.31                           |
| Left Head<br>Cheek              | Mid     | RMC<br>12.2kbps | 0.322                                       | 1.6             | 0.36                  | 23                               | 21.73                                | 0.43                           |
| Left Head<br>Tilt               | Mid     | RMC<br>12.2kbps | 0.257                                       | 1.6             | 2.14                  | 23                               | 21.73                                | 0.34                           |
| Body<br>Front side              | Mid     | RMC<br>12.2kbps | 0.271                                       | 1.6             | -0.50                 | 23                               | 21.73                                | 0.36                           |
| Body<br>Back-side               | Mid     | RMC<br>12.2kbps | 0.265                                       | 1.6             | -0.41                 | 23                               | 21.73                                | 0.36                           |

**PCS1900:**

| Date of Measured : Jan 17, 2017 |         |                  | Body-worn/Hotspot Separation Distance:15mm |                 |                       |                                  |                                      |                                |
|---------------------------------|---------|------------------|--------------------------------------------|-----------------|-----------------------|----------------------------------|--------------------------------------|--------------------------------|
| Position                        | Channel | Mode             | SAR<br>1g(W/kg)                            | Limit<br>(W/kg) | Power<br>Drift<br>(%) | Maximum<br>Turn-up<br>Power(dBm) | measured<br>output<br>power<br>(dBm) | Scaled<br>Maximum<br>SAR(W/kg) |
| Right Head<br>Cheek             | Mid     | GSM<br>voice     | 0.292                                      | 1.6             | 2.29                  | 30                               | 29.71                                | 0.31                           |
| Right Head<br>Tilt              | Mid     | GSM<br>voice     | 0.211                                      | 1.6             | -0.53                 | 30                               | 29.71                                | 0.23                           |
| Left Head<br>Cheek              | Mid     | GSM<br>voice     | 0.439                                      | 1.6             | 1.40                  | 30                               | 29.71                                | 0.47                           |
| Left Head<br>Tilt               | Mid     | GSM<br>voice     | 0.365                                      | 1.6             | -3.62                 | 30                               | 29.71                                | 0.39                           |
| Body<br>Front side              | Mid     | EGPRS<br>Class12 | 0.437                                      | 1.6             | 0.46                  | 27                               | 26.11                                | 0.54                           |
| Body<br>Back side               | Mid     | EGPRS<br>Class12 | 0.612                                      | 1.6             | 0.22                  | 27                               | 26.11                                | 0.75                           |

**WCDMA BAND II (1900):**

| Date of Measured : Jan 17, 2017 |         |                 | Body-worn/Hotspot Separation Distance: 15mm |                 |                       |                                  |                                      |                                |
|---------------------------------|---------|-----------------|---------------------------------------------|-----------------|-----------------------|----------------------------------|--------------------------------------|--------------------------------|
| Position                        | Channel | Mode            | SAR<br>1g(W/kg)                             | Limit<br>(W/kg) | Power<br>Drift<br>(%) | Maximum<br>Turn-up<br>Power(dBm) | measured<br>output<br>power<br>(dBm) | Scaled<br>Maximum<br>SAR(W/kg) |
| Right Head<br>Cheek             | Mid     | RMC<br>12.2kbps | 0.763                                       | 1.6             | 0.70                  | 23                               | 22.07                                | 0.95                           |
| Right Head<br>Tilt              | Mid     | RMC<br>12.2kbps | 0.687                                       | 1.6             | -0.27                 | 23                               | 22.07                                | 0.85                           |
| Left Head<br>Cheek              | Mid     | RMC<br>12.2kbps | 0.753                                       | 1.6             | -2.51                 | 23                               | 22.07                                | 0.93                           |
| Left Head<br>Tilt               | Mid     | RMC<br>12.2kbps | 0.662                                       | 1.6             | -1.72                 | 23                               | 22.07                                | 0.82                           |
| Body<br>Front-side              | Mid     | RMC<br>12.2kbps | 0.506                                       | 1.6             | -0.57                 | 23                               | 22.07                                | 0.63                           |
| Body<br>Back-side               | Mid     | RMC<br>12.2kbps | 0.663                                       | 1.6             | -0.26                 | 23                               | 22.07                                | 0.82                           |

### Measurement variability consideration

According to KDB 865664 D01v01 section 2.8.1, repeated measurements are required following the procedures as below:

1. Repeated measurement is not required when the original highest measured SAR is  $< 0.80\text{W/kg}$ ; steps 2) through 4) do not apply.
2. When the original highest measured SAR is  $\geq 0.80\text{ W/kg}$ , repeat that measurement once.
3. Perform a second repeated measurement only if the ratio of largest to smallest SAR for the original and first repeated measurements is  $> 1.20$  or when the original or repeated measurement is  $\geq 1.45\text{ W/kg}$  (~ 10% from the 1-g SAR limit).
4. Perform a third repeated measurement only if the original, first or second repeated measurement is  $\geq 1.5\text{ W/kg}$  and the ratio of largest to smallest SAR for the original, first and second repeated measurements is  $> 1.20$ .  
Measured SAR (W/Kg)

### Simultaneous Transmission SAR Analysis.

| No. | Applicable Simultaneous Transmission Combination |
|-----|--------------------------------------------------|
| 1.  | WWAN+BT                                          |

Note:

1. For simultaneous transmission analysis, WiFi and Bluetooth SAR is estimated per KDB 447498 D01 v06 base on the formula below:
  - $(\text{max. power of channel, including tune-up tolerance, mW}) / (\text{min. test separation distance, mm}) \cdot [\sqrt{f_{\text{(GHz)}}/x}] \text{ W/kg}$  for test separation distances  $\leq 50\text{ mm}$ ;  
where  $x = 7.5$  for 1-g SAR, and  $x = 18.75$  for 10-g SAR.
  - $0.4\text{ W/kg}$  for 1-g SAR and  $1.0\text{ W/kg}$  for 10-g SAR, when the test separation distances is  $> 50\text{ mm}$ .<sup>21</sup>
2. If the test Separation distances is  $\leq 5\text{mm}$ , 5mm is used for estimated SAR calculation.
3. BT's maximum tune up power is 6dBm and the estimated SAR is listed below.

| Test position          | Head(0cm) | Body-worn(1.5cm) |
|------------------------|-----------|------------------|
| BT Estimated SAR(W/kg) | 0.17      | 0.06             |

Maximum Summation:

|            | WWAN            | BT              | WWAN+BT |
|------------|-----------------|-----------------|---------|
| position   | Max. Scaled SAR | Max. Scaled SAR |         |
| Head 0.0cm | 0.95            | 0.17            | 1.12    |
| Body 1.0cm | 1.00            | 0.06            | 1.06    |

Note: 1g-SAR scalar summation  $< 1.6\text{W/kg}$ , so no simultaneous SAR is required.



## **11 SAR MEASUREMENT REFERENCES**

### **References**

1. FCC 47 CFR Part 2 “Frequency Allocations and Radio Treaty Matters; General Rules and Regulations”
2. IEEE Std. C95.1-1999, “IEEE Standard for Safety Levels with Respect to Human Exposure to Radio Frequency Electromagnetic Fields, 3kHz to 300GHz”, 1999
3. IEEE Std. 1528-2013, “IEEE Recommended Practice for Determining the Peak Spatial-Average Specific Absorption Rate (SAR) in the Human Head from Wireless Communications Devices: Measurement Techniques”, June 2013
4. IEC 62209-2, “Human exposure to radio frequency fields from hand-held and body-mounted wireless communication devices—Human models, instrumentation, and procedures – Part 2: Procedure to determine the specific absorption rate(SAR) for wireless communication devices used in close proximity to the human body(frequency range of 30MHz to 6GHz)”, March 2010
5. FCC KDB 447498 D01 v06, “RF Exposure Procedures and Equipment Authorization Policies For Mobile and Portable Device”, October 23, 2015
6. FCC KDB 941225 D01 v03r01, “3G SAR Measurement Procedures”, October 23, 2015
7. FCC KDB 865664 D01 v01r04, “SAR Measurement Requirements For 100MHz to 6GHz”, August 7, 2015
8. FCC KDB648474 D04 v01r03, “SAR Evaluation Considerations for Wireless Handsets”. October 23, 2015

### Maximum SAR measurement Plots

Test mode: GSM850, Middle channel (Right Head Cheek)

Product Description: 3G feature phone

Model: F1035

Test Date: Jan 16, 2017

|                                   |                             |
|-----------------------------------|-----------------------------|
| Medium(liquid type)               | HSL_835                     |
| Frequency (MHz)                   | 836.6000                    |
| Relative permittivity (real part) | 41.8                        |
| Conductivity (S/m)                | 0.86                        |
| E-Field Probe                     | SN 27/15 EPGO262            |
| Crest factor                      | 8.0                         |
| Conversion Factor                 | 1.74                        |
| Sensor-Surface                    | 4mm                         |
| Area Scan                         | dx=8mm dy=8mm               |
| Zoom Scan                         | 5x5x7, dx=8mm dy=8mm dz=5mm |
| Variation (%)                     | 2.300000                    |
| SAR 10g (W/Kg)                    | 0.339306                    |
| SAR 1g (W/Kg)                     | 0.460534                    |
| <b>SURFACE SAR</b>                | <b>VOLUME SAR</b>           |

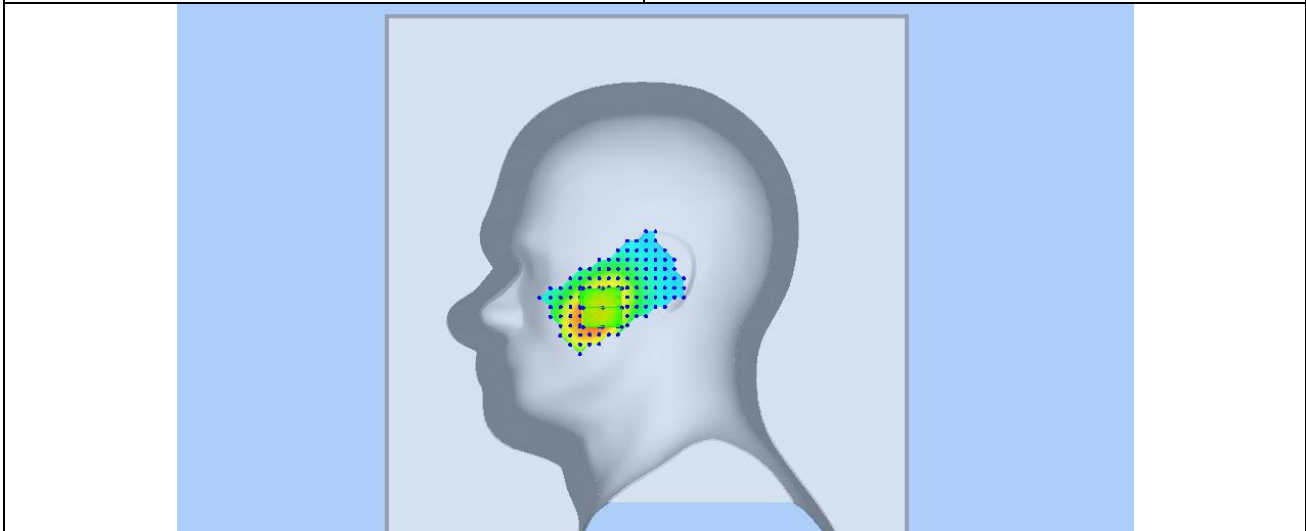
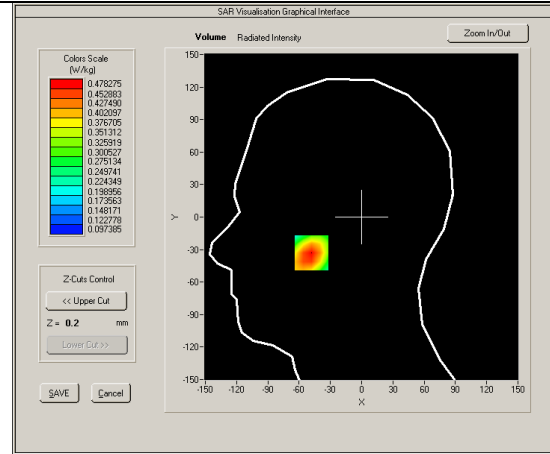
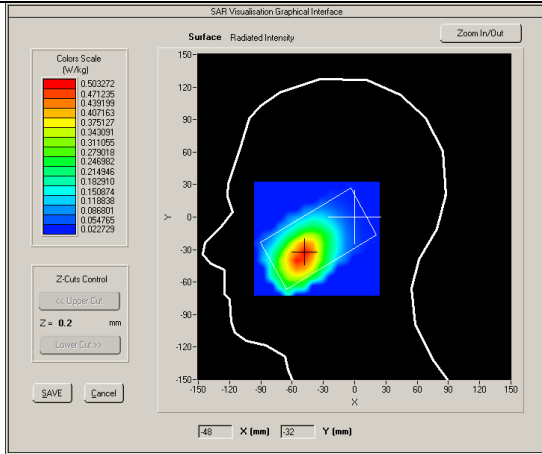

Test mode: GPRS850, Mid channel (Body Front Side)  
 Product Description: 3G feature phone  
 Model: F1035  
 Test Date: Jan 16, 2017

|                                   |                            |
|-----------------------------------|----------------------------|
| Medium(liquid type)               | MSL_835                    |
| Frequency (MHz)                   | 836.6000                   |
| Relative permittivity (real part) | 55.18                      |
| Conductivity (S/m)                | 0.95                       |
| E-Field Probe                     | SN 27/15 EPGO262           |
| Crest factor                      | 2.0                        |
| Conversion Factor                 | 1.81                       |
| Sensor-Surface                    | 4mm                        |
| Area Scan                         | dx=8mm dy=8mm              |
| Zoom Scan                         | 5x5x7,dx=8mm dy=8mm dz=5mm |
| Variation (%)                     | -4.050000                  |
| SAR 10g (W/Kg)                    | 0.576361                   |
| SAR 1g (W/Kg)                     | 0.794989                   |

**SURFACE SAR**

**VOLUME SAR**

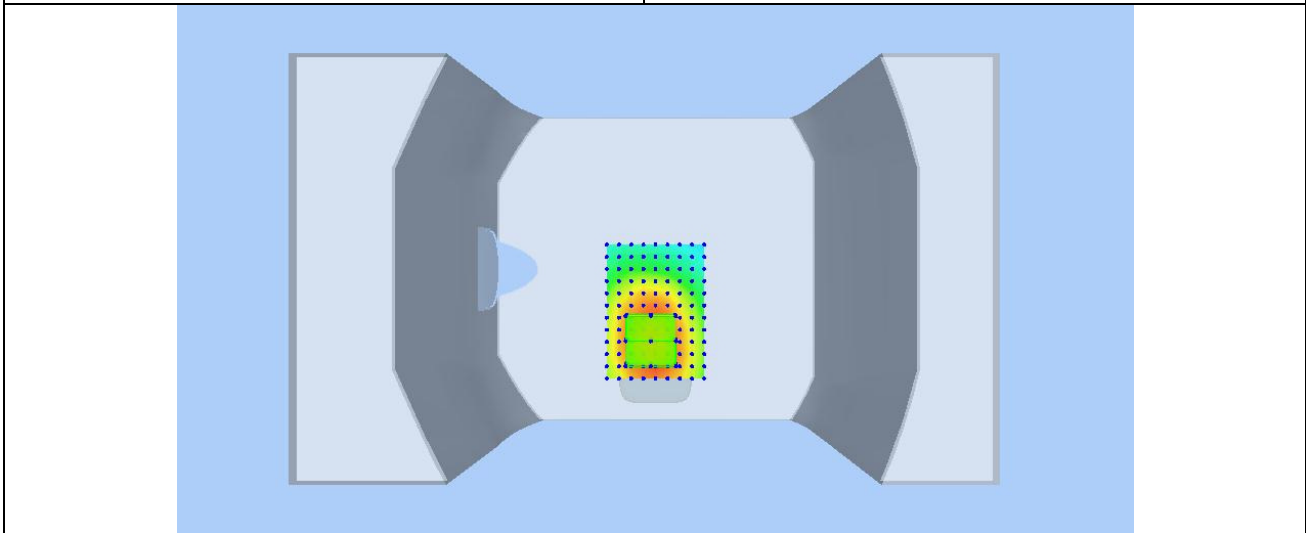
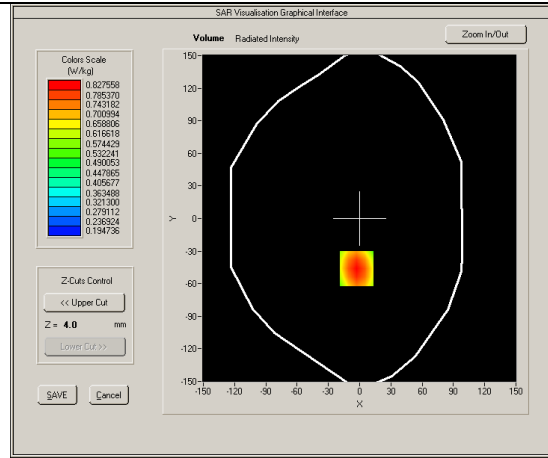
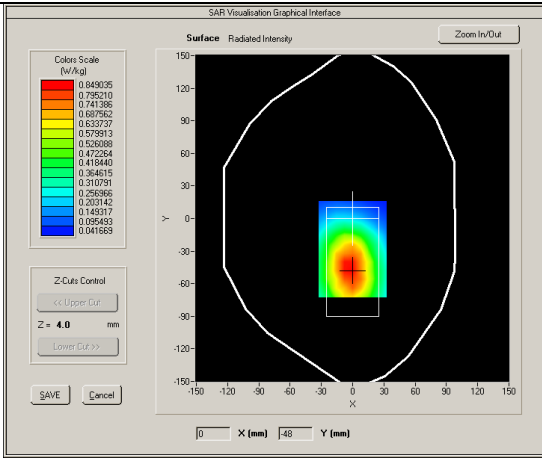

Test mode: WCDMA Band V, Middle channel (Left Head Cheek)

Product Description: 3G feature phone

Model: F1035

Test Date: Jan 16, 2017

|                                   |                            |
|-----------------------------------|----------------------------|
| Medium(liquid type)               | HSL_835                    |
| Frequency (MHz)                   | 835.000                    |
| Relative permittivity (real part) | 41.8                       |
| Conductivity (S/m)                | 0.86                       |
| E-Field Probe                     | SN 27/15 EPGO262           |
| Crest factor                      | 1.0                        |
| Conversion Factor                 | 1.74                       |
| Sensor-Surface                    | 4mm                        |
| Area Scan                         | dx=8mm dy=8mm              |
| Zoom Scan                         | 5x5x7,dx=8mm dy=8mm dz=5mm |
| Variation (%)                     | 0.360000                   |
| SAR 10g (W/Kg)                    | 0.236372                   |
| SAR 1g (W/Kg)                     | 0.322333                   |

**SURFACE SAR**

**VOLUME SAR**

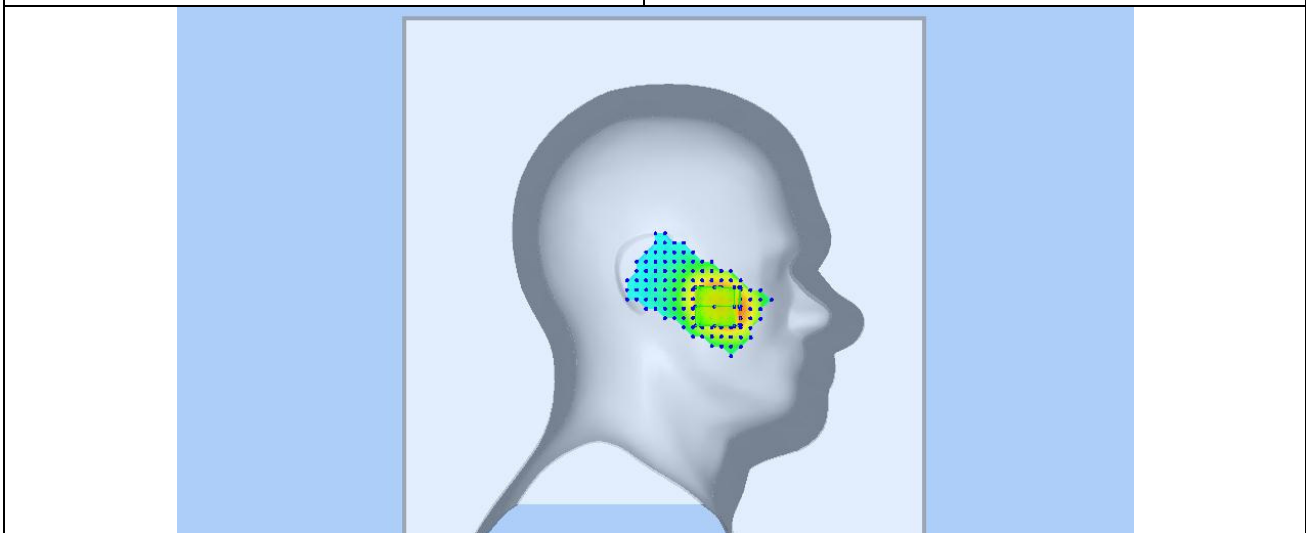
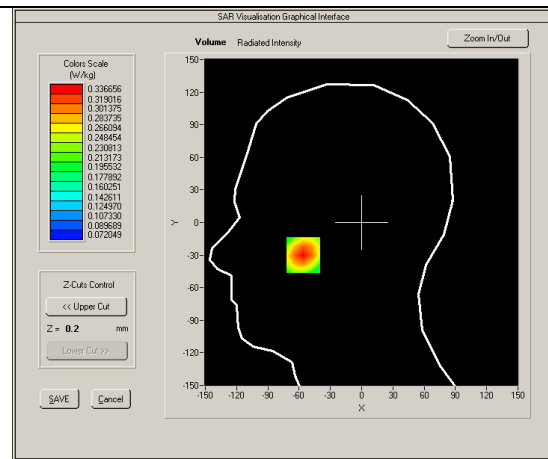
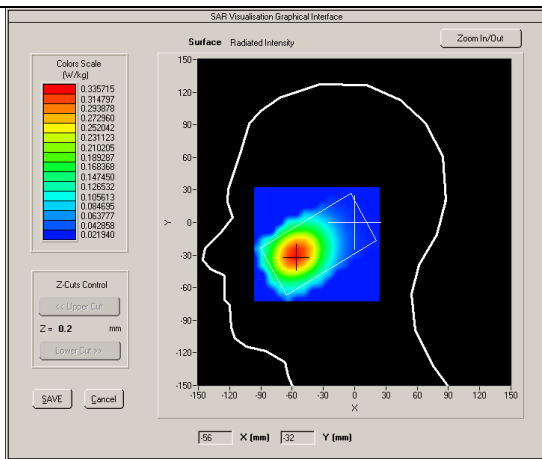

Test mode: WCDMA Band V, Middle channel (Body Front Side)

Product Description: 3G feature phone

Model: F1035

Test Date: Jan 16, 2017

|                                   |                            |
|-----------------------------------|----------------------------|
| Medium(liquid type)               | MSL_835                    |
| Frequency (MHz)                   | 835.0000                   |
| Relative permittivity (real part) | 55.18                      |
| Conductivity (S/m)                | 0.95                       |
| E-Field Probe                     | SN 27/15 EPGO262           |
| Crest factor                      | 1.0                        |
| Conversion Factor                 | 1.81                       |
| Sensor-Surface                    | 4mm                        |
| Area Scan                         | dx=8mm dy=8mm              |
| Zoom Scan                         | 5x5x7,dx=8mm dy=8mm dz=5mm |
| Variation (%)                     | -0.500000                  |
| SAR 10g (W/Kg)                    | 0.201090                   |
| SAR 1g (W/Kg)                     | 0.270744                   |

**SURFACE SAR**

**VOLUME SAR**

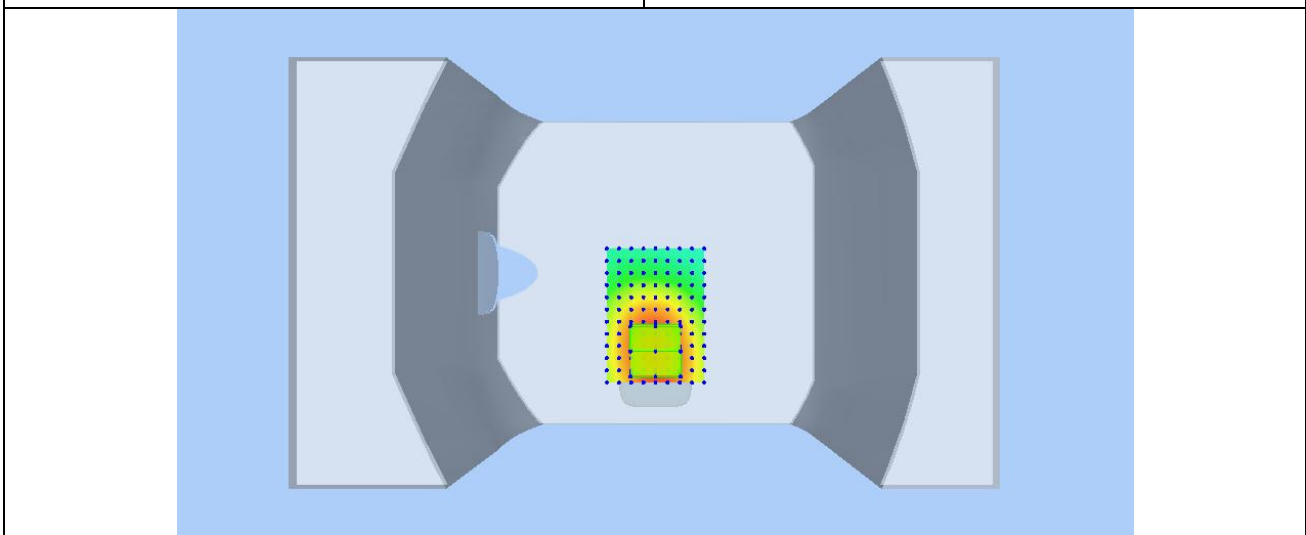
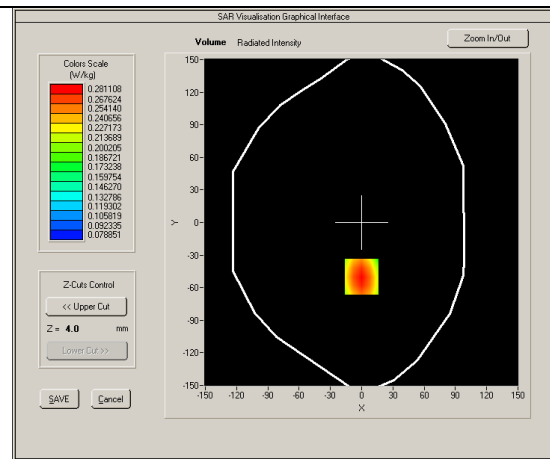
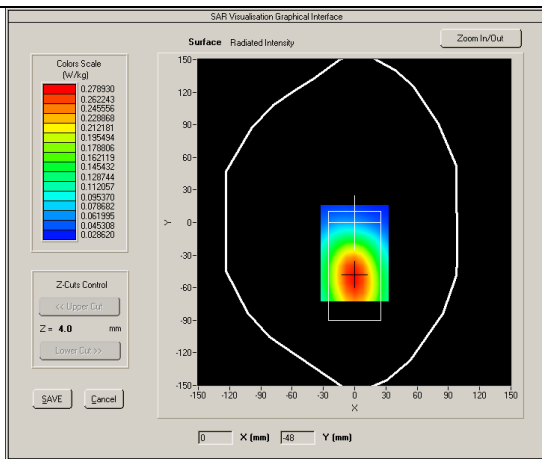

Test mode: PCS1900, Middle channel (Left Head Cheek)  
 Product Description: 3G feature phone  
 Model: F1035  
 Test Date: Jan 17, 2017

|                                   |                            |
|-----------------------------------|----------------------------|
| Medium(liquid type)               | HSL_1900                   |
| Frequency (MHz)                   | 1880.000                   |
| Relative permittivity (real part) | 40.5                       |
| Conductivity (S/m)                | 1.42                       |
| E-Field Probe                     | SN 27/15 EPGO262           |
| Crest factor                      | 8.0                        |
| Conversion Factor                 | 2.01                       |
| Sensor-Surface                    | 4mm                        |
| Area Scan                         | dx=8mm dy=8mm              |
| Zoom Scan                         | 5x5x7,dx=8mm dy=8mm dz=5mm |
| Variation (%)                     | 1.400000                   |
| SAR 10g (W/Kg)                    | 0.262195                   |
| SAR 1g (W/Kg)                     | 0.438603                   |

**SURFACE SAR**

**VOLUME SAR**

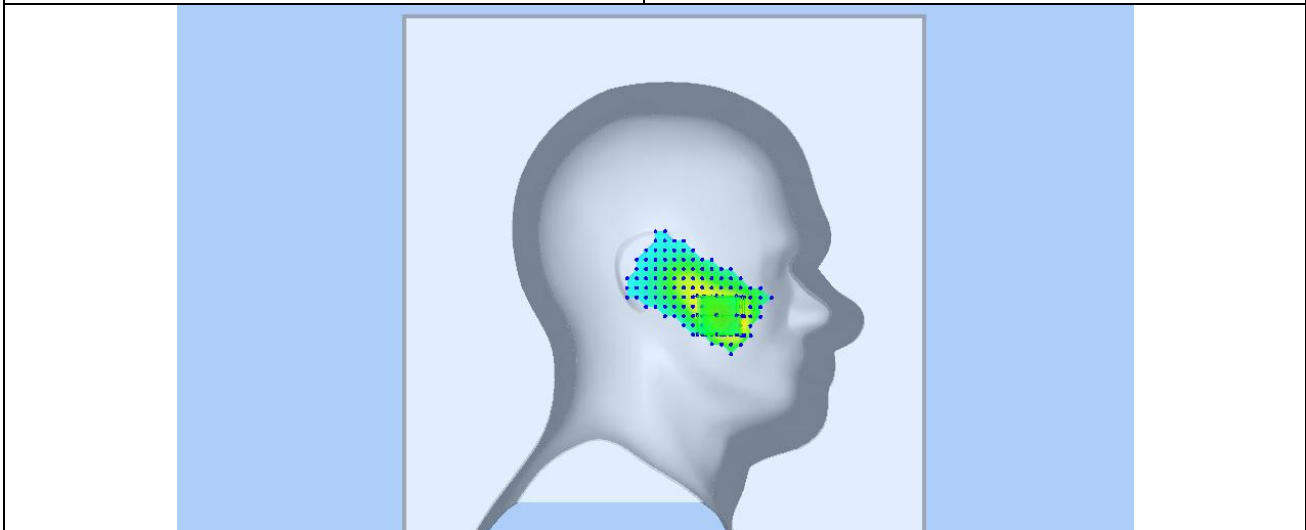
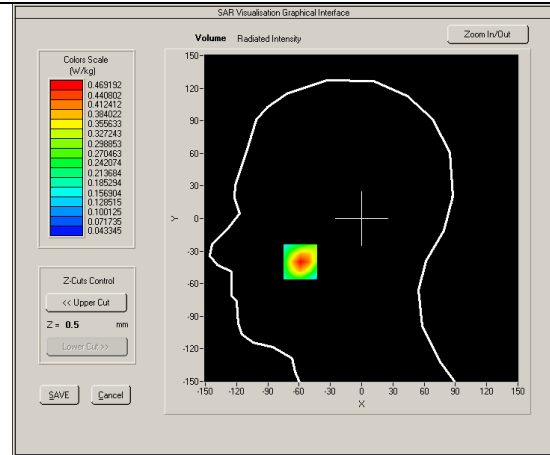
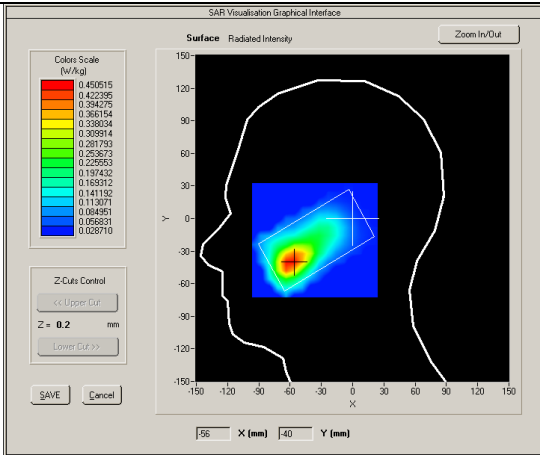

Test mode: GPRS1900, Middle channel (Body Back Side)  
 Product Description: 3G feature phone  
 Model: F1035  
 Test Date: Jan 17, 2017

|                                   |                            |
|-----------------------------------|----------------------------|
| Medium(liquid type)               | MSL_1900                   |
| Frequency (MHz)                   | 1850.200                   |
| Relative permittivity (real part) | 53.32                      |
| Conductivity (S/m)                | 1.47                       |
| E-Field Probe                     | SN 27/15 EPGO262           |
| Crest factor                      | 2.0                        |
| Conversion Factor                 | 2.05                       |
| Sensor-Surface                    | 4mm                        |
| Area Scan                         | dx=8mm dy=8mm              |
| Zoom Scan                         | 5x5x7,dx=8mm dy=8mm dz=5mm |
| Variation (%)                     | 0.220000                   |
| SAR 10g (W/Kg)                    | 0.373359                   |
| SAR 1g (W/Kg)                     | 0.612413                   |

**SURFACE SAR**

**VOLUME SAR**

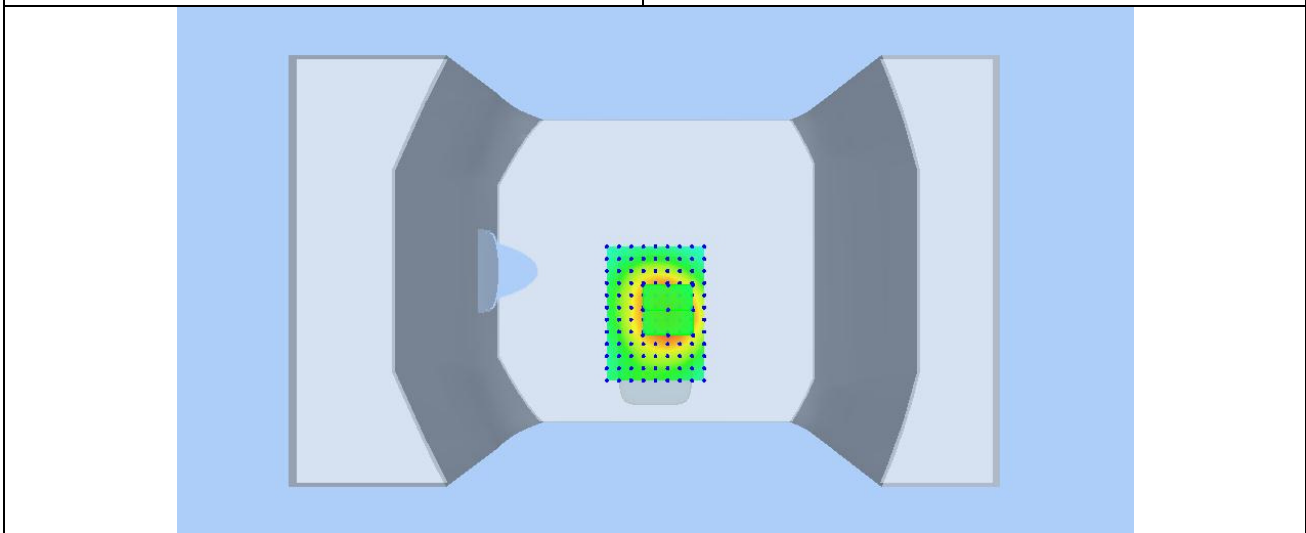
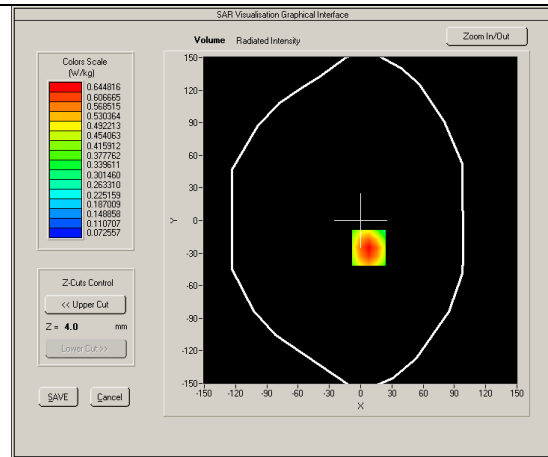
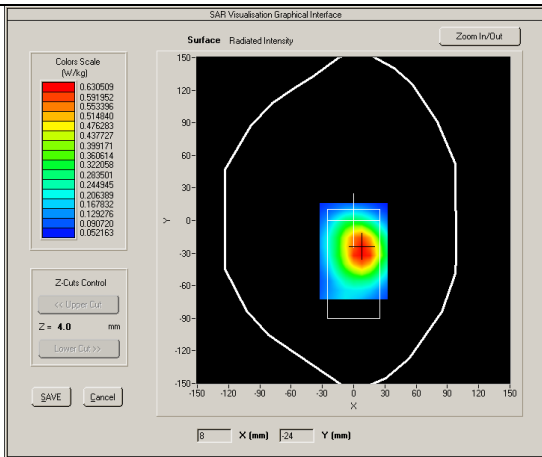

Test mode: WCDMA Band II , Middle channel (Right Head Cheek)

Product Description: 3G feature phone

Model: F1035

Test Date: Jan 17, 2017

|                                   |                            |
|-----------------------------------|----------------------------|
| Medium(liquid type)               | HSL_1900                   |
| Frequency (MHz)                   | 1880.000                   |
| Relative permittivity (real part) | 40.5                       |
| Conductivity (S/m)                | 1.42                       |
| E-Field Probe                     | SN 27/15 EPGO262           |
| Crest factor                      | 1.0                        |
| Conversion Factor                 | 2.01                       |
| Sensor-Surface                    | 4mm                        |
| Area Scan                         | dx=8mm dy=8mm              |
| Zoom Scan                         | 5x5x7,dx=8mm dy=8mm dz=5mm |
| Variation (%)                     | 0.700000                   |
| SAR 10g (W/Kg)                    | 0.449727                   |
| SAR 1g (W/Kg)                     | 0.763097                   |

**SURFACE SAR**

**VOLUME SAR**

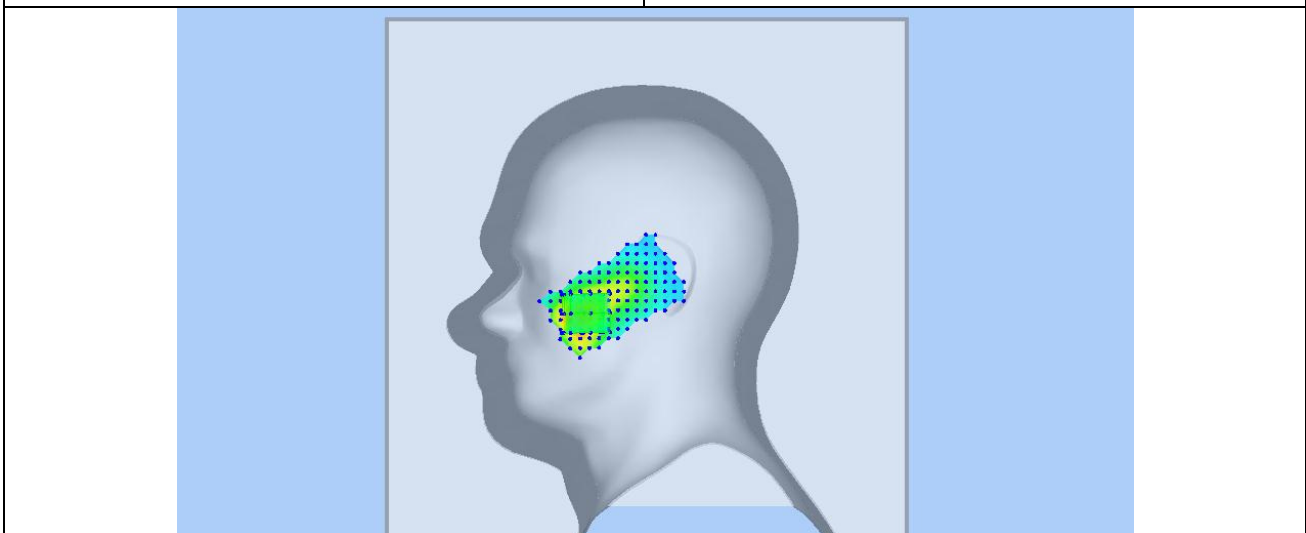
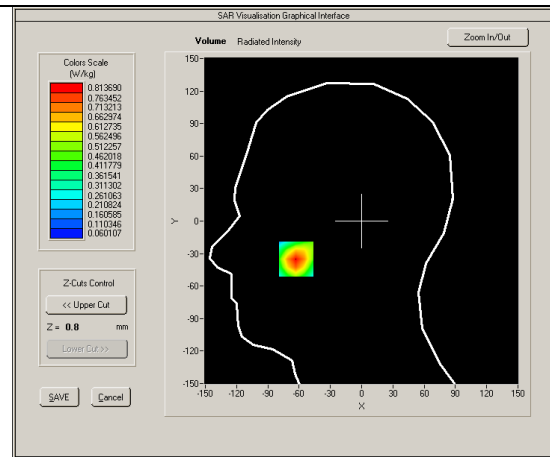
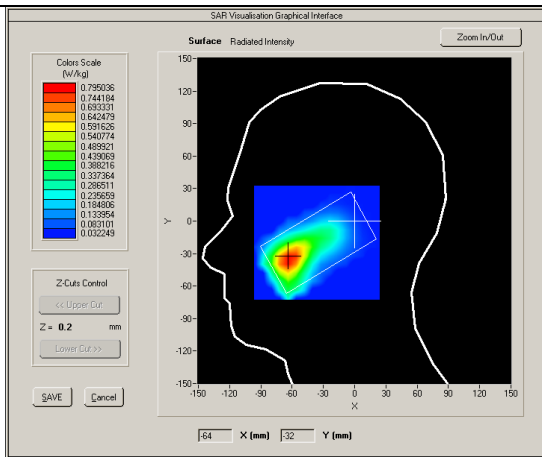



Test mode: WCDMA Band II , Middle channel (Body Back Side)  
 Product Description: 3G feature phone  
 Model: F1035  
 Test Date: Jan 17, 2017

|                                   |                            |
|-----------------------------------|----------------------------|
| Medium(liquid type)               | MSL_1900                   |
| Frequency (MHz)                   | 1880.000                   |
| Relative permittivity (real part) | 53.32                      |
| Conductivity (S/m)                | 1.47                       |
| E-Field Probe                     | SN 27/15 EPGO262           |
| Crest factor                      | 1.0                        |
| Conversion Factor                 | 2.05                       |
| Sensor-Surface                    | 4mm                        |
| Area Scan                         | dx=8mm dy=8mm              |
| Zoom Scan                         | 5x5x7,dx=8mm dy=8mm dz=5mm |
| Variation (%)                     | -0.26000                   |
| SAR 10g (W/Kg)                    | 0.405056                   |
| SAR 1g (W/Kg)                     | 0.662819                   |
| <b>SURFACE SAR</b>                | <b>VOLUME SAR</b>          |

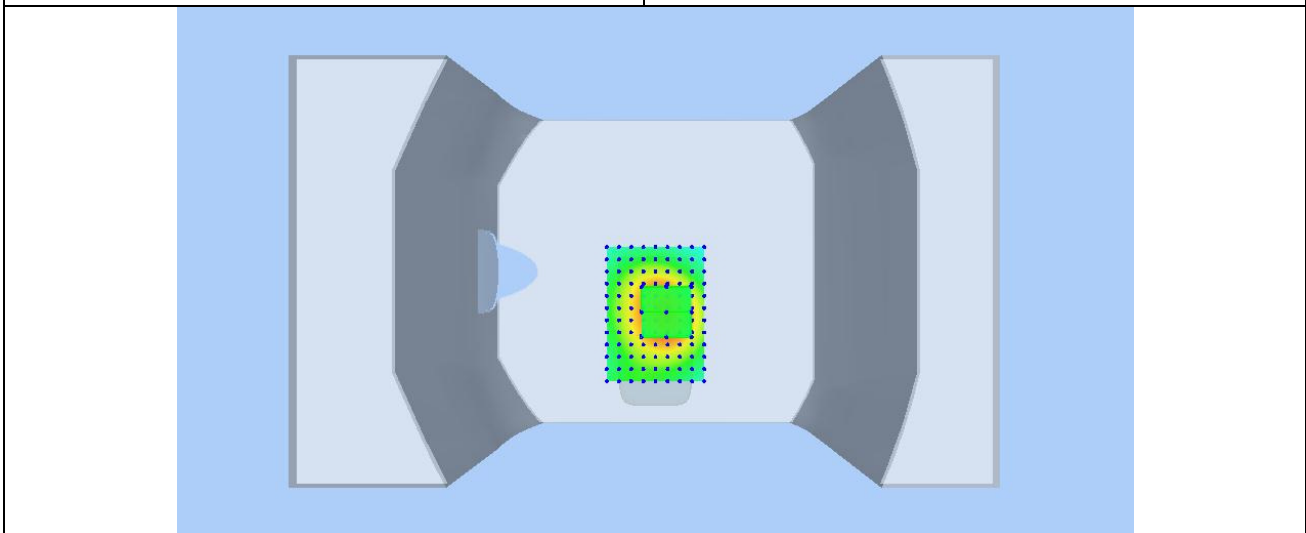
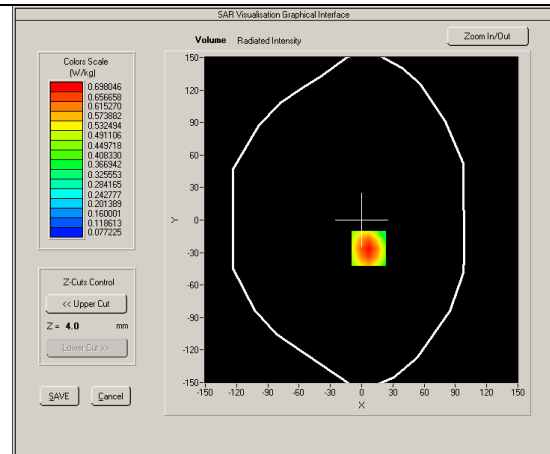
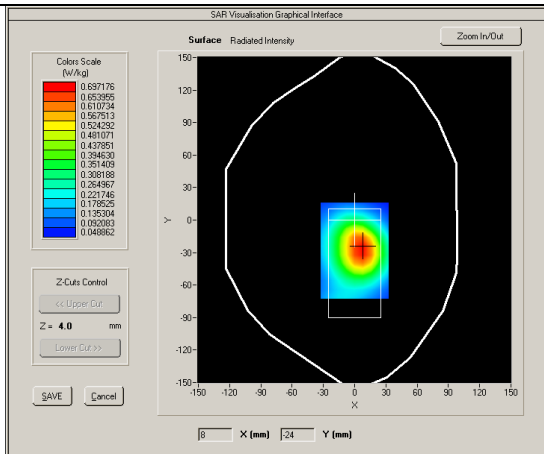

## Annex A CALIBRATION REPORTS

### SARTIMO Calibration Certificate-Extended Dipole Calibrations

According to KDB865664 D01, Dipoles must be recalibrated at least once every three years; however, immediate re-calibration is required for following conditions. The test laboratory must ensure that the required supporting information and documentation have been included in the SAR report to qualify for extended 3-year calibration interval.

- 1) When the most recent return-loss, measured at least annually, deviates by more than 20% from the previous measurement (i.e. 0.2 of the dB value) or not meeting the required -20 dB return-loss specification
- 2) When the most recent measurement of the real or imaginary parts of the impedance, measured at least annually, deviates by more than  $5\Omega$  from the previous measurement

**Dipole Verification plot: SID 835 SN 18/11 DIPC150**  
**835MHz for Head:**

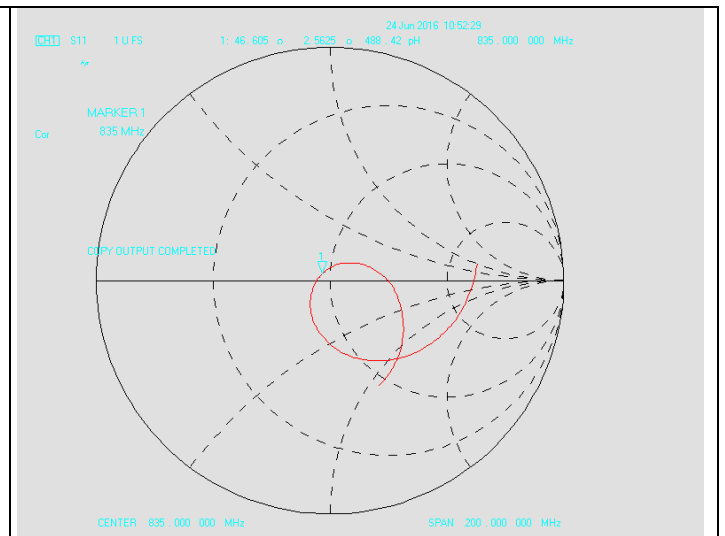
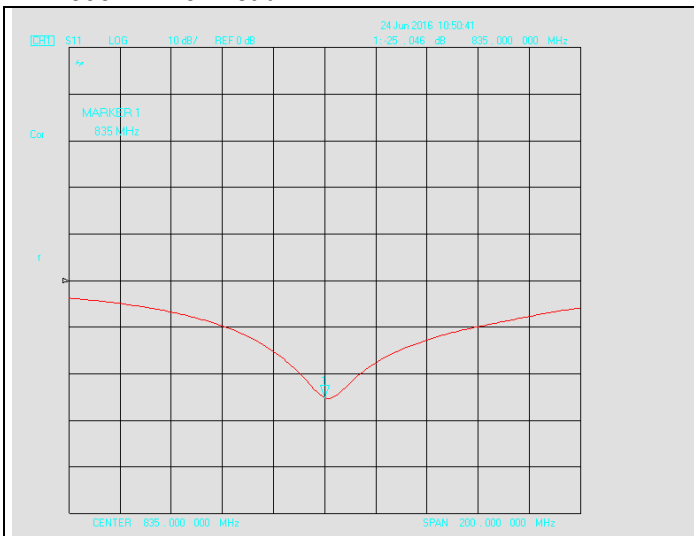

**835MHz for Body:**

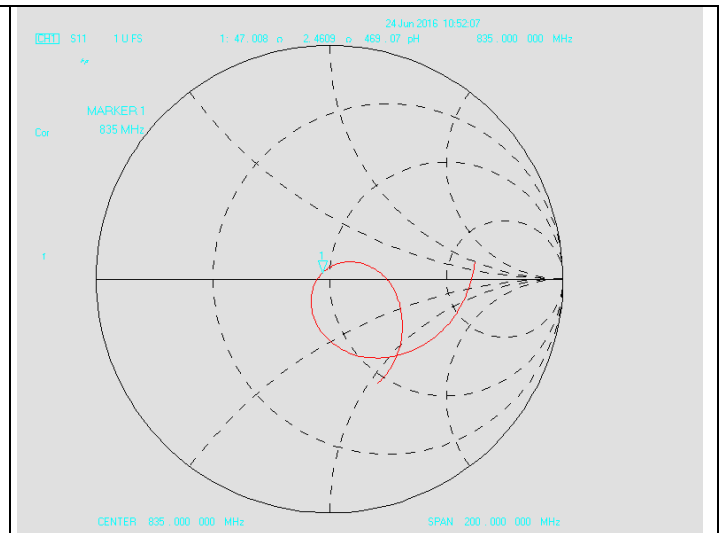
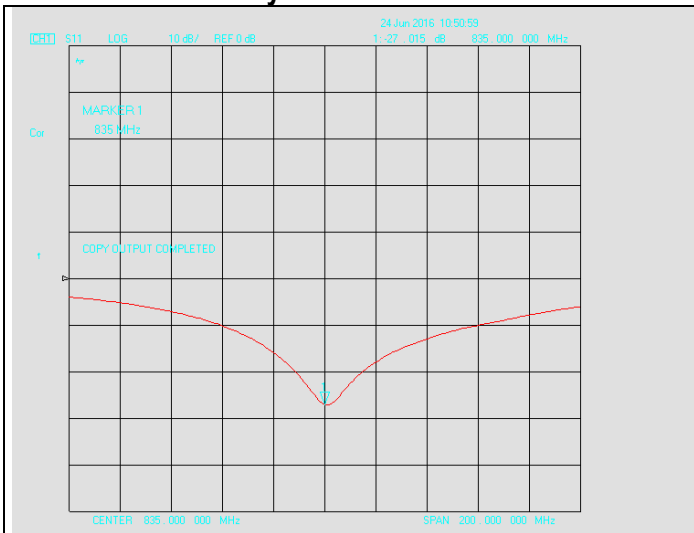

**Dipole Verification plot: SID 1900 SN 18/11 DIPG153  
 1900MHz for Head:**

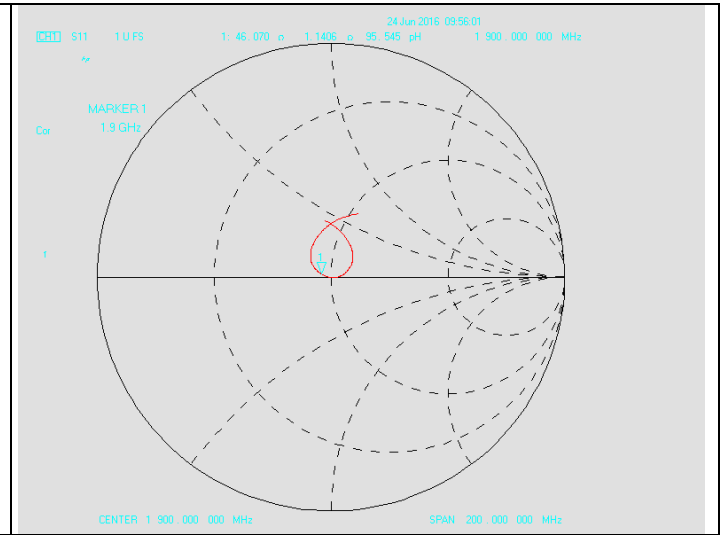
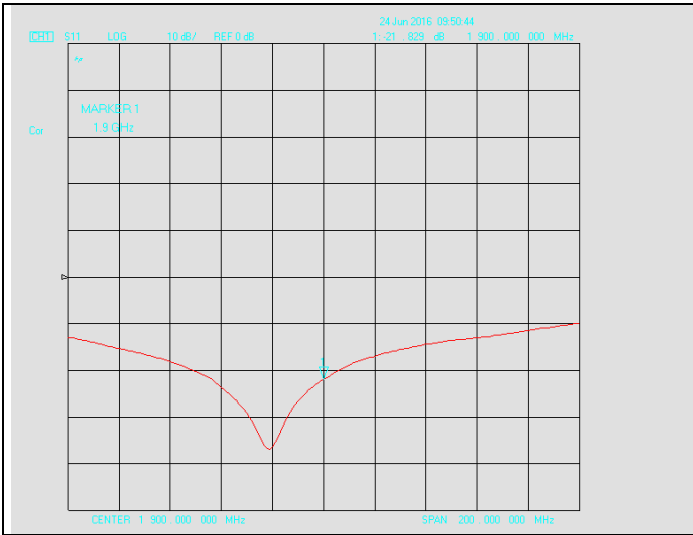

**1900MHz for Body:**

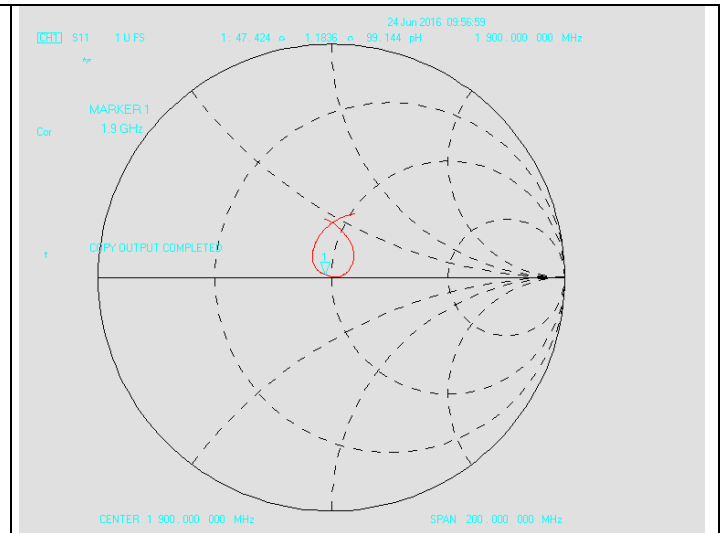
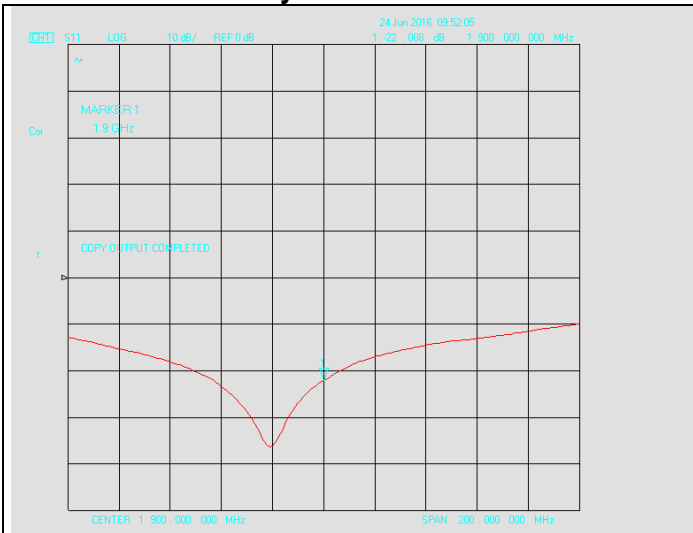

**SID 835 SN 18/11 DIPC150 For Head**

| Return- Loss (dB) | Deviat (dB) | Real Impedance (Ω) | Imaginary Impedance (Ω) | Deviat (Ω) | Calibrate Date |
|-------------------|-------------|--------------------|-------------------------|------------|----------------|
| -26.34            | -----       | -----              | 50                      | -----      | 06/018/2014    |
| -25.046           | -1.294      | 47.008             | 50                      | -2.992     | 06/24/2016     |

**SID 835 SN 18/11 DIPC150 For Body**

|         |       |        |    |        |            |
|---------|-------|--------|----|--------|------------|
| -27.015 | 0.675 | 46.605 | 50 | -3.395 | 06/24/2016 |
|---------|-------|--------|----|--------|------------|

|             |                |
|-------------|----------------|
| Test Report | 17070028-FCC-H |
| Page        | 52 of 86       |

| <b>SID 1900 SN 18/11 DIPG153 For Head</b> |                     |                                             |                                                  |                                      |                       |
|-------------------------------------------|---------------------|---------------------------------------------|--------------------------------------------------|--------------------------------------|-----------------------|
| <b>Return- Loss (dB)</b>                  | <b>Deviate (dB)</b> | <b>Real Impedance (<math>\Omega</math>)</b> | <b>Imaginary Impedance (<math>\Omega</math>)</b> | <b>Deviate (<math>\Omega</math>)</b> | <b>Calibrate Date</b> |
| -21.22                                    | -----               | -----                                       | 50                                               | -----                                | 06/18/2014            |
| -21.829                                   | 0.609               | 46.070                                      | 50                                               | -3.930                               | 06/24/2016            |
| <b>SID 1900 SN 18/11 DIPG153 For Body</b> |                     |                                             |                                                  |                                      |                       |
| -22.008                                   | 0.788               | 47.424                                      | 50                                               | -2.576                               | 06/24/2016            |

**According to up table, the return loss is <-20dB, deviates by less than 20% from the previous measurement; the real impedance are all within 5  $\Omega$  compared to the required impedance (50  $\Omega$ ).**

|             |                |
|-------------|----------------|
| Test Report | 17070028-FCC-H |
| Page        | 53 of 86       |



## COMOSAR E-Field Probe Calibration Report

Ref : ACR.264.3.16.SATU.A

### SIEMIC TESTING AND CERTIFICATION SERVICES

ZONE A, FLOOR 1, BUILDING 2, WAN YE LONG  
TECHNOLOGY PARK, SOUTH SIDE OF ZHOUSHI ROAD,  
SHIYAN STREET, BAO'AN DISTRICT, SHENZHEN 518108 ,  
GUANGDONG , P.R.C.

**MVG COMOSAR DOSIMETRIC E-FIELD PROBE**  
SERIAL NO.: SN 27/15 EPG0262

Calibrated at MVG US  
2105 Barrett Park Dr. - Kennesaw, GA 30144



Calibration Date: 09/20/2016

#### *Summary:*

This document presents the method and results from an accredited COMOSAR Dosimetric E-Field Probe calibration performed in MVG USA using the CALISAR / CALIBAIR test bench, for use with a COMOSAR system only. All calibration results are traceable to national metrology institutions.

|             |                |
|-------------|----------------|
| Test Report | 17070028-FCC-H |
| Page        | 54 of 86       |



**COMOSAR E-FIELD PROBE CALIBRATION REPORT**

Ref: ACR.264.3.16.SATU.A

|                      | <i>Name</i>   | <i>Function</i> | <i>Date</i> | <i>Signature</i>     |
|----------------------|---------------|-----------------|-------------|----------------------|
| <i>Prepared by :</i> | Jérôme LUC    | Product Manager | 9/20/2016   | <i>JS</i>            |
| <i>Checked by :</i>  | Jérôme LUC    | Product Manager | 9/20/2016   | <i>JS</i>            |
| <i>Approved by :</i> | Kim RUTKOWSKI | Quality Manager | 9/20/2016   | <i>Kim Rutkowski</i> |

|                       |                                                                         |
|-----------------------|-------------------------------------------------------------------------|
| <i>Distribution :</i> | <i>Customer Name</i><br>SIEMIC Testing<br>and Certification<br>Services |
|-----------------------|-------------------------------------------------------------------------|

| <i>Issue</i> | <i>Date</i> | <i>Modifications</i> |
|--------------|-------------|----------------------|
| A            | 9/20/2016   | Initial release      |
|              |             |                      |
|              |             |                      |

|             |                |
|-------------|----------------|
| Test Report | 17070028-FCC-H |
| Page        | 55 of 86       |



**TABLE OF CONTENTS**

|     |                                       |    |
|-----|---------------------------------------|----|
| 1   | Device Under Test .....               | 4  |
| 2   | Product Description .....             | 4  |
| 2.1 | General Information .....             | 4  |
| 3   | Measurement Method .....              | 4  |
| 3.1 | Linearity .....                       | 4  |
| 3.2 | Sensitivity .....                     | 5  |
| 3.3 | Lower Detection Limit .....           | 5  |
| 3.4 | Isotropy .....                        | 5  |
| 3.5 | Boundary Effect .....                 | 5  |
| 4   | Measurement Uncertainty .....         | 5  |
| 5   | Calibration Measurement Results ..... | 6  |
| 5.1 | Sensitivity in air .....              | 6  |
| 5.2 | Linearity .....                       | 7  |
| 5.3 | Sensitivity in liquid .....           | 7  |
| 5.4 | Isotropy .....                        | 8  |
| 6   | List of Equipment .....               | 10 |



## 1 DEVICE UNDER TEST

| Device Under Test                        |                                                                         |
|------------------------------------------|-------------------------------------------------------------------------|
| Device Type                              | COMOSAR DOSIMETRIC E FIELD PROBE                                        |
| Manufacturer                             | MVG                                                                     |
| Model                                    | SSE2                                                                    |
| Serial Number                            | SN 27/15 EPGO262                                                        |
| Product Condition (new / used)           | Used                                                                    |
| Frequency Range of Probe                 | 0.7 GHz-6GHz                                                            |
| Resistance of Three Dipoles at Connector | Dipole 1: R1=0.221 MΩ<br>Dipole 2: R2=0.199 MΩ<br>Dipole 3: R3=0.199 MΩ |

A yearly calibration interval is recommended.

## 2 PRODUCT DESCRIPTION

### 2.1 GENERAL INFORMATION

MVG's COMOSAR E field Probes are built in accordance to the IEEE 1528, OET 65 Bulletin C and CEI/IEC 62209 standards.



Figure 1 – MVG COMOSAR Dosimetric E field Dipole

|                                            |        |
|--------------------------------------------|--------|
| Probe Length                               | 330 mm |
| Length of Individual Dipoles               | 2 mm   |
| Maximum external diameter                  | 8 mm   |
| Probe Tip External Diameter                | 2.5 mm |
| Distance between dipoles / probe extremity | 1 mm   |

## 3 MEASUREMENT METHOD

The IEEE 1528, OET 65 Bulletin C, CENELEC EN50361 and CEI/IEC 62209 standards provide recommended practices for the probe calibrations, including the performance characteristics of interest and methods by which to assess their affect. All calibrations / measurements performed meet the fore mentioned standards.

### 3.1 LINEARITY

The evaluation of the linearity was done in free space using the waveguide, performing a power sweep to cover the SAR range 0.01W/kg to 100W/kg.





### 3.2 SENSITIVITY

The sensitivity factors of the three dipoles were determined using a two step calibration method (air and tissue simulating liquid) using waveguides as outlined in the standards.

### 3.3 LOWER DETECTION LIMIT

The lower detection limit was assessed using the same measurement set up as used for the linearity measurement. The required lower detection limit is 10 mW/kg.

### 3.4 ISOTROPY

The axial isotropy was evaluated by exposing the probe to a reference wave from a standard dipole with the dipole mounted under the flat phantom in the test configuration suggested for system validations and checks. The probe was rotated along its main axis from 0 - 360 degrees in 15 degree steps. The hemispherical isotropy is determined by inserting the probe in a thin plastic box filled with tissue-equivalent liquid, with the plastic box illuminated with the fields from a half wave dipole. The dipole is rotated about its axis (0°–180°) in 15° increments. At each step the probe is rotated about its axis (0°–360°).

### 3.5 BOUNDARY EFFECT

The boundary effect is defined as the deviation between the SAR measured data and the expected exponential decay in the liquid when the probe is oriented normal to the interface. To evaluate this effect, the liquid filled flat phantom is exposed to fields from either a reference dipole or waveguide. With the probe normal to the phantom surface, the peak spatial average SAR is measured and compared to the analytical value at the surface.

## 4 MEASUREMENT UNCERTAINTY

The guidelines outlined in the IEEE 1528, OET 65 Bulletin C, CENELEC EN50361 and CEI/IEC 62209 standards were followed to generate the measurement uncertainty associated with an E-field probe calibration using the waveguide technique. All uncertainties listed below represent an expanded uncertainty expressed at approximately the 95% confidence level using a coverage factor of k=2, traceable to the Internationally Accepted Guides to Measurement Uncertainty.

| Uncertainty analysis of the probe calibration in waveguide |                       |                          |            |    |                          |
|------------------------------------------------------------|-----------------------|--------------------------|------------|----|--------------------------|
| ERROR SOURCES                                              | Uncertainty value (%) | Probability Distribution | Divisor    | ci | Standard Uncertainty (%) |
| Incident or forward power                                  | 3.00%                 | Rectangular              | $\sqrt{3}$ | 1  | 1.732%                   |
| Reflected power                                            | 3.00%                 | Rectangular              | $\sqrt{3}$ | 1  | 1.732%                   |
| Liquid conductivity                                        | 5.00%                 | Rectangular              | $\sqrt{3}$ | 1  | 2.887%                   |
| Liquid permittivity                                        | 4.00%                 | Rectangular              | $\sqrt{3}$ | 1  | 2.309%                   |
| Field homogeneity                                          | 3.00%                 | Rectangular              | $\sqrt{3}$ | 1  | 1.732%                   |
| Field probe positioning                                    | 5.00%                 | Rectangular              | $\sqrt{3}$ | 1  | 2.887%                   |



COMOSAR E-FIELD PROBE CALIBRATION REPORT

Ref: ACR.264.3.16.SATULA

|                                                     |       |             |            |   |        |
|-----------------------------------------------------|-------|-------------|------------|---|--------|
| Field probe linearity                               | 3.00% | Rectangular | $\sqrt{3}$ | 1 | 1.732% |
| Combined standard uncertainty                       |       |             |            |   | 5.831% |
| Expanded uncertainty<br>95 % confidence level k = 2 |       |             |            |   | 12.0%  |

5 CALIBRATION MEASUREMENT RESULTS

| Calibration Parameters |       |
|------------------------|-------|
| Liquid Temperature     | 21 °C |
| Lab Temperature        | 21 °C |
| Lab Humidity           | 45 %  |

5.1 SENSITIVITY IN AIR

| Normx dipole 1 ( $\mu\text{V}/(\text{V}/\text{m})^2$ ) | Normy dipole 2 ( $\mu\text{V}/(\text{V}/\text{m})^2$ ) | Normz dipole 3 ( $\mu\text{V}/(\text{V}/\text{m})^2$ ) |
|--------------------------------------------------------|--------------------------------------------------------|--------------------------------------------------------|
| 0.80                                                   | 0.71                                                   | 0.72                                                   |

| DCP dipole 1 (mV) | DCP dipole 2 (mV) | DCP dipole 3 (mV) |
|-------------------|-------------------|-------------------|
| 92                | 90                | 91                |

Calibration curves  $c_i=f(V)$  ( $i=1,2,3$ ) allow to obtain H-field value using the formula:

$$E = \sqrt{E_1^2 + E_2^2 + E_3^2}$$

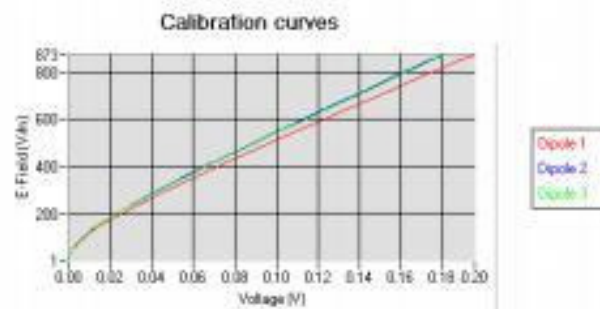



**COMOSAR E-FIELD PROBE CALIBRATION REPORT**

Ref: ACR.264.3.16.SATULA

**5.2 LINEARITY**

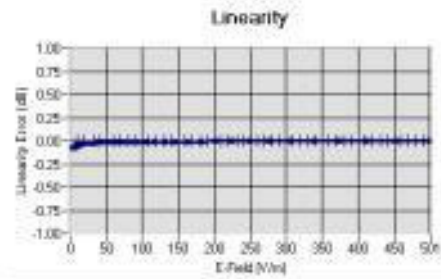

Linearity:  $\pm 1.89\%$  ( $\pm 0.07\text{dB}$ )

**5.3 SENSITIVITY IN LIQUID**

| Liquid | Frequency (MHz $\pm 1\%$ 100MHz) | Permittivity | Epsilon (S/m) | ConvF |
|--------|----------------------------------|--------------|---------------|-------|
| HL750  | 750                              | 40.03        | 0.93          | 1.57  |
| BL750  | 750                              | 56.83        | 1.00          | 1.62  |
| HL850  | 835                              | 42.19        | 0.90          | 1.74  |
| BL850  | 835                              | 54.67        | 1.01          | 1.81  |
| HL900  | 900                              | 42.08        | 1.01          | 1.67  |
| BL900  | 900                              | 55.25        | 1.08          | 1.73  |
| HL1800 | 1800                             | 41.68        | 1.46          | 1.81  |
| BL1800 | 1800                             | 53.86        | 1.46          | 1.87  |
| HL1900 | 1900                             | 38.45        | 1.45          | 2.01  |
| BL1900 | 1900                             | 53.32        | 1.56          | 2.05  |
| HL2000 | 2000                             | 38.26        | 1.38          | 1.86  |
| BL2000 | 2000                             | 52.70        | 1.51          | 1.91  |
| HL2450 | 2450                             | 37.50        | 1.80          | 2.04  |
| BL2450 | 2450                             | 53.22        | 1.89          | 2.12  |
| HL2600 | 2600                             | 39.80        | 1.99          | 2.05  |
| BL2600 | 2600                             | 52.52        | 2.23          | 2.12  |
| HL3500 | 3500                             | 38.21        | 2.98          | 2.02  |
| BL3500 | 3500                             | 52.95        | 3.43          | 2.08  |
| HL5200 | 5200                             | 35.64        | 4.67          | 1.51  |
| BL5200 | 5200                             | 48.64        | 5.51          | 1.55  |
| HL5400 | 5400                             | 36.44        | 4.87          | 1.56  |
| BL5400 | 5400                             | 46.52        | 5.77          | 1.61  |
| HL5600 | 5600                             | 36.66        | 5.17          | 1.55  |
| BL5600 | 5600                             | 46.79        | 5.77          | 1.60  |
| HL5800 | 5800                             | 35.31        | 5.31          | 1.44  |
| BL5800 | 5800                             | 47.04        | 6.10          | 1.48  |

LOWER DETECTION LIMIT: 7mW/kg



5.4 ISOTROPY

**HL 900 MHz**

- Axial isotropy: 0.04 dB
- Hemispherical isotropy: 0.05 dB

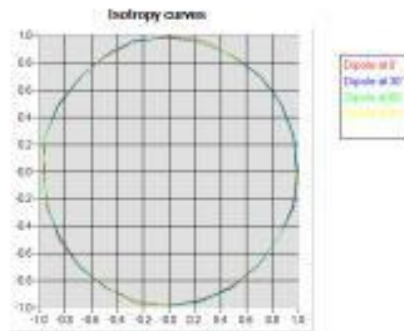

**HL 1800 MHz**

- Axial isotropy: 0.04 dB
- Hemispherical isotropy: 0.06 dB

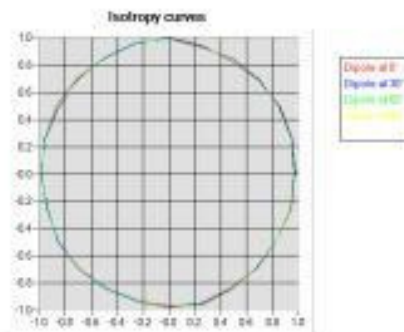

|             |                |
|-------------|----------------|
| Test Report | 17070028-FCC-H |
| Page        | 61 of 86       |



**COMOSAR E-FIELD PROBE CALIBRATION REPORT**

Ref: ACR\_264.3.16,SATULA

**HL5600 MHz**

- Axial isotropy: 0.06 dB
- Hemispherical isotropy: 0.08 dB

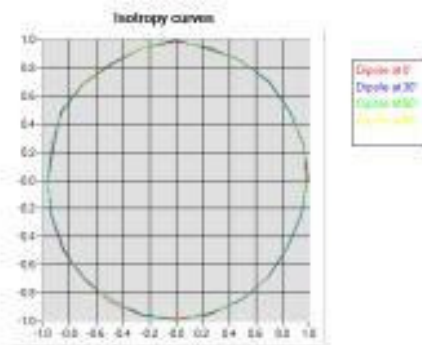



## 6 LIST OF EQUIPMENT

| Equipment Summary Sheet       |                      |                    |                                               |                                               |
|-------------------------------|----------------------|--------------------|-----------------------------------------------|-----------------------------------------------|
| Equipment Description         | Manufacturer / Model | Identification No. | Current Calibration Date                      | Next Calibration Date                         |
| Flat Phantom                  | MVG                  | SN-20/09-SAM71     | Validated. No cal required.                   | Validated. No cal required.                   |
| COMOSAR Test Bench            | Version 3            | NA                 | Validated. No cal required.                   | Validated. No cal required.                   |
| Network Analyzer              | Rhode & Schwarz ZVA  | SN100132           | 02/2016                                       | 02/2019                                       |
| Reference Probe               | MVG                  | EP 94 SN 37/08     | 10/2015                                       | 10/2016                                       |
| Multimeter                    | Keithley 2000        | 1188656            | 12/2013                                       | 12/2016                                       |
| Signal Generator              | Agilent E4438C       | MY49070581         | 12/2013                                       | 12/2016                                       |
| Amplifier                     | Aethercomm           | SN 046             | Characterized prior to test. No cal required. | Characterized prior to test. No cal required. |
| Power Meter                   | HP E4418A            | US38261498         | 12/2013                                       | 12/2016                                       |
| Power Sensor                  | HP ECP-E26A          | US37181460         | 12/2013                                       | 12/2016                                       |
| Directional Coupler           | Narda 4216-20        | 01386              | Characterized prior to test. No cal required. | Characterized prior to test. No cal required. |
| Waveguide                     | Mega Industries      | 069Y7-158-13-712   | Validated. No cal required.                   | Validated. No cal required.                   |
| Waveguide Transition          | Mega Industries      | 069Y7-158-13-701   | Validated. No cal required.                   | Validated. No cal required.                   |
| Waveguide Termination         | Mega Industries      | 069Y7-158-13-701   | Validated. No cal required.                   | Validated. No cal required.                   |
| Temperature / Humidity Sensor | Control Company      | 150798832          | 10/2015                                       | 10/2017                                       |



## SAR Reference Dipole Calibration Report

Ref : ACR.170.1.14.SATU.A

### SIEMIC TESTING AND CERTIFICATION SERVICES

ZONE A,FLOOR 1,BUILDING 2,WAN YE LONG  
TECHNOLOGY PARK,SOUTH SIDE OF ZHOUSHI ROAD,  
SHIYAN STREET,BAO'AN DISTRICT, SHENZHEN 518108 ,  
GUANGDONG , P.R.C.

### SATIMO COMOSAR REFERENCE DIPOLE

FREQUENCY: 835 MHZ

SERIAL NO.: SN 18/11 DIPC150

Calibrated at SATIMO US

2105 Barrett Park Dr. - Kennesaw, GA 30144



06/18/2014

#### Summary:

This document presents the method and results from an accredited SAR reference dipole calibration performed in SATIMO USA using the COMOSAR test bench. All calibration results are traceable to national metrology institutions.

|             |                |
|-------------|----------------|
| Test Report | 17070028-FCC-H |
| Page        | 64 of 86       |



SAR REFERENCE DIPOLE CALIBRATION REPORT

Ref: ACR.170.1.14.SATU.A

|                      | <i>Name</i>   | <i>Function</i> | <i>Date</i> | <i>Signature</i>     |
|----------------------|---------------|-----------------|-------------|----------------------|
| <i>Prepared by :</i> | Jérôme LUC    | Product Manager | 6/19/2014   | <i>JS</i>            |
| <i>Checked by :</i>  | Jérôme LUC    | Product Manager | 6/19/2014   | <i>JS</i>            |
| <i>Approved by :</i> | Kim RUTKOWSKI | Quality Manager | 6/19/2014   | <i>Kim Rutkowski</i> |

|                       |                                                 |
|-----------------------|-------------------------------------------------|
|                       | <i>Customer Name</i>                            |
| <i>Distribution :</i> | SIEMIC Testing<br>and Certification<br>Services |

| <i>Issue</i> | <i>Date</i> | <i>Modifications</i> |
|--------------|-------------|----------------------|
| A            | 6/19/2014   | Initial release      |
|              |             |                      |
|              |             |                      |
|              |             |                      |



**TABLE OF CONTENTS**

|     |                                       |    |
|-----|---------------------------------------|----|
| 1   | Introduction.....                     | 4  |
| 2   | Device Under Test .....               | 4  |
| 3   | Product Description .....             | 4  |
| 3.1 | General Information .....             | 4  |
| 4   | Measurement Method .....              | 5  |
| 4.1 | Return Loss Requirements .....        | 5  |
| 4.2 | Mechanical Requirements .....         | 5  |
| 5   | Measurement Uncertainty .....         | 5  |
| 5.1 | Return Loss .....                     | 5  |
| 5.2 | Dimension Measurement .....           | 5  |
| 5.3 | Validation Measurement .....          | 5  |
| 6   | Calibration Measurement Results ..... | 6  |
| 6.1 | Return Loss and Impedance .....       | 6  |
| 6.2 | Mechanical Dimensions .....           | 6  |
| 7   | Validation measurement .....          | 7  |
| 7.1 | Measurement Condition .....           | 7  |
| 7.2 | Head Liquid Measurement .....         | 7  |
| 7.3 | Measurement Result .....              | 8  |
| 7.4 | Body Measurement Result .....         | 9  |
| 8   | List of Equipment .....               | 10 |

## 1 INTRODUCTION

This document contains a summary of the requirements set forth by the IEEE 1528, OET 65 Bulletin C and CEI/IEC 62209 standards for reference dipoles used for SAR measurement system validations and the measurements that were performed to verify that the product complies with the fore mentioned standards.

## 2 DEVICE UNDER TEST

| Device Under Test              |                                  |
|--------------------------------|----------------------------------|
| Device Type                    | COMOSAR 835 MHz REFERENCE DIPOLE |
| Manufacturer                   | Satimo                           |
| Model                          | SID835                           |
| Serial Number                  | SN 18/11 DIPC150                 |
| Product Condition (new / used) |                                  |

A yearly calibration interval is recommended.

## 3 PRODUCT DESCRIPTION

### 3.1 GENERAL INFORMATION

Satimo's COMOSAR Validation Dipoles are built in accordance to the IEEE 1528, OET 65 Bulletin C and CEI/IEC 62209 standards. The product is designed for use with the COMOSAR test bench only.



**Figure 1 – Satimo COMOSAR Validation Dipole**

#### 4 MEASUREMENT METHOD

The IEEE 1528, OET 65 Bulletin C and CEI/IEC 62209 standards provide requirements for reference dipoles used for system validation measurements. The following measurements were performed to verify that the product complies with the fore mentioned standards.

##### 4.1 RETURN LOSS REQUIREMENTS

The dipole used for SAR system validation measurements and checks must have a return loss of -20 dB or better. The return loss measurement shall be performed against a liquid filled flat phantom, with the phantom constructed as outlined in the fore mentioned standards.

##### 4.2 MECHANICAL REQUIREMENTS

The IEEE Std. 1528 and CEI/IEC 62209 standards specify the mechanical components and dimensions of the validation dipoles, with the dimensions frequency and phantom shell thickness dependent. The COMOSAR test bench employs a 2 mm phantom shell thickness therefore the dipoles sold for use with the COMOSAR test bench comply with the requirements set forth for a 2 mm phantom shell thickness.

#### 5 MEASUREMENT UNCERTAINTY

All uncertainties listed below represent an expanded uncertainty expressed at approximately the 95% confidence level using a coverage factor of  $k=2$ , traceable to the Internationally Accepted Guides to Measurement Uncertainty.

##### 5.1 RETURN LOSS

The following uncertainties apply to the return loss measurement:

| Frequency band | Expanded Uncertainty on Return Loss |
|----------------|-------------------------------------|
| 400-6000MHz    | 0.1 dB                              |

##### 5.2 DIMENSION MEASUREMENT

The following uncertainties apply to the dimension measurements:

| Length (mm) | Expanded Uncertainty on Length |
|-------------|--------------------------------|
| 3 - 300     | 0.05 mm                        |

##### 5.3 VALIDATION MEASUREMENT

The guidelines outlined in the IEEE 1528, OET 65 Bulletin C, CENELEC EN50361 and CEI/IEC 62209 standards were followed to generate the measurement uncertainty for validation measurements.

| Scan Volume | Expanded Uncertainty |
|-------------|----------------------|
| 1 g         | 20.3 %               |
| 10 g        | 20.1 %               |



## 6 CALIBRATION MEASUREMENT RESULTS

### 6.1 RETURN LOSS AND IMPEDANCE

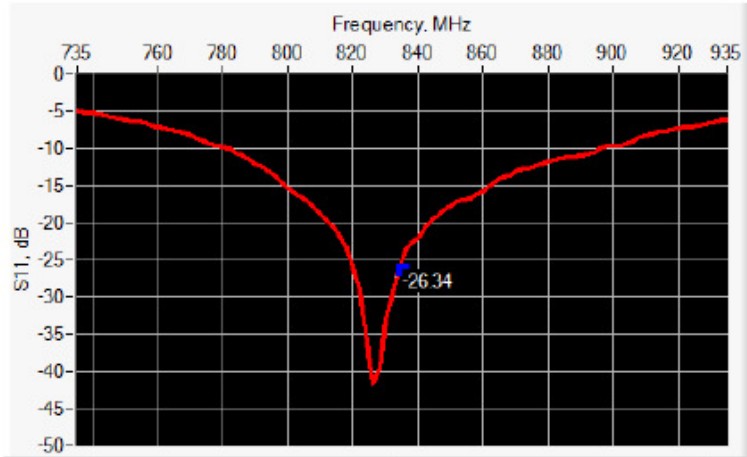

| Frequency (MHz) | Return Loss (dB) | Requirement (dB) | Impedance       |
|-----------------|------------------|------------------|-----------------|
| 835             | -26.34           | -20              | 54.8 Ω + 1.3 jΩ |

### 6.2 MECHANICAL DIMENSIONS

| Frequency MHz | L mm       |          | h mm       |          | d mm      |          |
|---------------|------------|----------|------------|----------|-----------|----------|
|               | required   | measured | required   | measured | required  | measured |
| 300           | 420.0 ±1 % |          | 250.0 ±1 % |          | 6.35 ±1 % |          |
| 450           | 290.0 ±1 % |          | 166.7 ±1 % |          | 6.35 ±1 % |          |
| 750           | 176.0 ±1 % |          | 100.0 ±1 % |          | 6.35 ±1 % |          |
| 835           | 161.0 ±1 % | PASS     | 89.8 ±1 %  | PASS     | 3.6 ±1 %  | PASS     |
| 900           | 149.0 ±1 % |          | 83.3 ±1 %  |          | 3.6 ±1 %  |          |
| 1450          | 89.1 ±1 %  |          | 51.7 ±1 %  |          | 3.6 ±1 %  |          |
| 1500          | 80.5 ±1 %  |          | 50.0 ±1 %  |          | 3.6 ±1 %  |          |
| 1640          | 79.0 ±1 %  |          | 45.7 ±1 %  |          | 3.6 ±1 %  |          |
| 1750          | 75.2 ±1 %  |          | 42.9 ±1 %  |          | 3.6 ±1 %  |          |
| 1800          | 72.0 ±1 %  |          | 41.7 ±1 %  |          | 3.6 ±1 %  |          |
| 1900          | 68.0 ±1 %  |          | 39.5 ±1 %  |          | 3.6 ±1 %  |          |
| 1950          | 66.3 ±1 %  |          | 38.5 ±1 %  |          | 3.6 ±1 %  |          |
| 2000          | 64.5 ±1 %  |          | 37.5 ±1 %  |          | 3.6 ±1 %  |          |
| 2100          | 61.0 ±1 %  |          | 35.7 ±1 %  |          | 3.6 ±1 %  |          |
| 2300          | 55.5 ±1 %  |          | 32.6 ±1 %  |          | 3.6 ±1 %  |          |
| 2450          | 51.5 ±1 %  |          | 30.4 ±1 %  |          | 3.6 ±1 %  |          |
| 2600          | 48.5 ±1 %  |          | 28.8 ±1 %  |          | 3.6 ±1 %  |          |
| 3000          | 41.5 ±1 %  |          | 25.0 ±1 %  |          | 3.6 ±1 %  |          |
| 3500          | 37.0 ±1 %  |          | 26.4 ±1 %  |          | 3.6 ±1 %  |          |
| 3700          | 34.7 ±1 %  |          | 26.4 ±1 %  |          | 3.6 ±1 %  |          |

## 7 VALIDATION MEASUREMENT

The IEEE Std. 1528, OET 65 Bulletin C and CEI/IEC 62209 standards state that the system validation measurements must be performed using a reference dipole meeting the fore mentioned return loss and mechanical dimension requirements. The validation measurement must be performed against a liquid filled flat phantom, with the phantom constructed as outlined in the fore mentioned standards. Per the standards, the dipole shall be positioned below the bottom of the phantom, with the dipole length centered and parallel to the longest dimension of the flat phantom, with the top surface of the dipole at the described distance from the bottom surface of the phantom.

### 7.1 MEASUREMENT CONDITION

|                                           |                                                         |
|-------------------------------------------|---------------------------------------------------------|
| Software                                  | OPENSAR V4                                              |
| Phantom                                   | SN 20/09 SAM71                                          |
| Probe                                     | SN 18/11 EPG122                                         |
| Liquid                                    | Head Liquid Values: $\epsilon_r$ : 43.8 $\sigma$ : 0.91 |
| Distance between dipole center and liquid | 15.0 mm                                                 |
| Area scan resolution                      | $dx=8mm/dy=8mm$                                         |
| Zoon Scan Resolution                      | $dx=8mm/dy=8m/dz=5mm$                                   |
| Frequency                                 | 835 MHz                                                 |
| Input power                               | 20 dBm                                                  |
| Liquid Temperature                        | 21 °C                                                   |
| Lab Temperature                           | 21 °C                                                   |
| Lab Humidity                              | 45 %                                                    |

### 7.2 HEAD LIQUID MEASUREMENT

| Frequency<br>MHz | Relative permittivity ( $\epsilon_r$ ) |          | Conductivity ( $\sigma$ ) S/m |          |
|------------------|----------------------------------------|----------|-------------------------------|----------|
|                  | required                               | measured | required                      | measured |
| 300              | 45.3 ±5 %                              |          | 0.87 ±5 %                     |          |
| 450              | 43.5 ±5 %                              |          | 0.87 ±5 %                     |          |
| 750              | 41.9 ±5 %                              |          | 0.89 ±5 %                     |          |
| 835              | 41.5 ±5 %                              | PASS     | 0.90 ±5 %                     | PASS     |
| 900              | 41.5 ±5 %                              |          | 0.97 ±5 %                     |          |
| 1450             | 40.5 ±5 %                              |          | 1.20 ±5 %                     |          |
| 1500             | 40.4 ±5 %                              |          | 1.23 ±5 %                     |          |
| 1640             | 40.2 ±5 %                              |          | 1.31 ±5 %                     |          |
| 1750             | 40.1 ±5 %                              |          | 1.37 ±5 %                     |          |
| 1800             | 40.0 ±5 %                              |          | 1.40 ±5 %                     |          |
| 1900             | 40.0 ±5 %                              |          | 1.40 ±5 %                     |          |
| 1950             | 40.0 ±5 %                              |          | 1.40 ±5 %                     |          |
| 2000             | 40.0 ±5 %                              |          | 1.40 ±5 %                     |          |
| 2100             | 39.8 ±5 %                              |          | 1.49 ±5 %                     |          |
| 2300             | 39.5 ±5 %                              |          | 1.67 ±5 %                     |          |
| 2450             | 39.2 ±5 %                              |          | 1.80 ±5 %                     |          |
| 2600             | 39.0 ±5 %                              |          | 1.96 ±5 %                     |          |
| 3000             | 38.5 ±5 %                              |          | 2.40 ±5 %                     |          |
| 3500             | 37.9 ±5 %                              |          | 2.91 ±5 %                     |          |

### 7.3 MEASUREMENT RESULT

The IEEE Std. 1528 and CEI/IEC 62209 standards state that the system validation measurements should produce the SAR values shown below (for phantom thickness of 2 mm), within the uncertainty for the system validation. All SAR values are normalized to 1 W forward power. In bracket, the measured SAR is given with the used input power.

| Frequency<br>MHz | 1 g SAR (W/kg/W) |             | 10 g SAR (W/kg/W) |             |
|------------------|------------------|-------------|-------------------|-------------|
|                  | required         | measured    | required          | measured    |
| 300              | 2.85             |             | 1.94              |             |
| 450              | 4.58             |             | 3.06              |             |
| 750              | 8.49             |             | 5.55              |             |
| 835              | 9.56             | 9.65 (0.96) | 6.22              | 6.17 (0.62) |
| 900              | 10.9             |             | 6.99              |             |
| 1450             | 29               |             | 16                |             |
| 1500             | 30.5             |             | 16.8              |             |
| 1640             | 34.2             |             | 18.4              |             |
| 1750             | 36.4             |             | 19.3              |             |
| 1800             | 38.4             |             | 20.1              |             |
| 1900             | 39.7             |             | 20.5              |             |
| 1950             | 40.5             |             | 20.9              |             |
| 2000             | 41.1             |             | 21.1              |             |
| 2100             | 43.6             |             | 21.9              |             |
| 2300             | 48.7             |             | 23.3              |             |
| 2450             | 52.4             |             | 24                |             |
| 2600             | 55.3             |             | 24.6              |             |
| 3000             | 63.8             |             | 25.7              |             |
| 3500             | 67.1             |             | 25                |             |

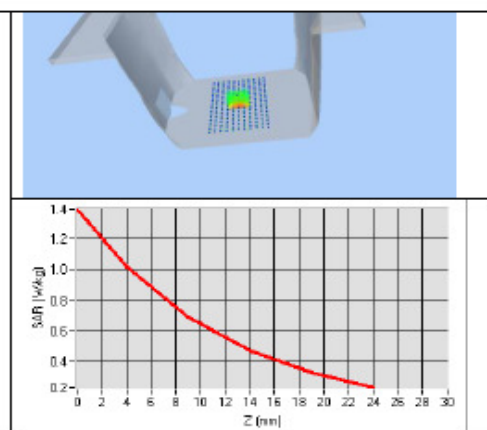
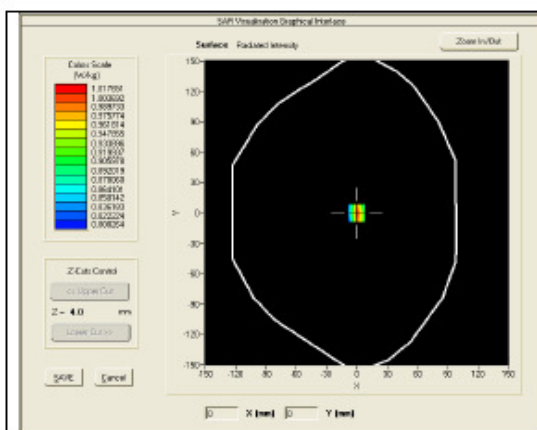

7.4 BODY MEASUREMENT RESULT

|                                           |                                              |
|-------------------------------------------|----------------------------------------------|
| Software                                  | OPENSAR V4                                   |
| Phantom                                   | SN 20/09 SAM71                               |
| Probe                                     | SN 18/11 EPG122                              |
| Liquid                                    | Body Liquid Values: eps' : 54.4 sigma : 0.94 |
| Distance between dipole center and liquid | 15.0 mm                                      |
| Area scan resolution                      | dx=8mm/dy=8mm                                |
| Zoon Scan Resolution                      | dx=8mm/dy=8m/dz=5mm                          |
| Frequency                                 | 835 MHz                                      |
| Input power                               | 20 dBm                                       |
| Liquid Temperature                        | 21 °C                                        |
| Lab Temperature                           | 21 °C                                        |
| Lab Humidity                              | 45 %                                         |

| Frequency MHz | 1 g SAR (W/kg/W) | 10 g SAR (W/kg/W) |
|---------------|------------------|-------------------|
|               | measured         | measured          |
| 835           | 9.98 (1.00)      | 6.38 (0.64)       |

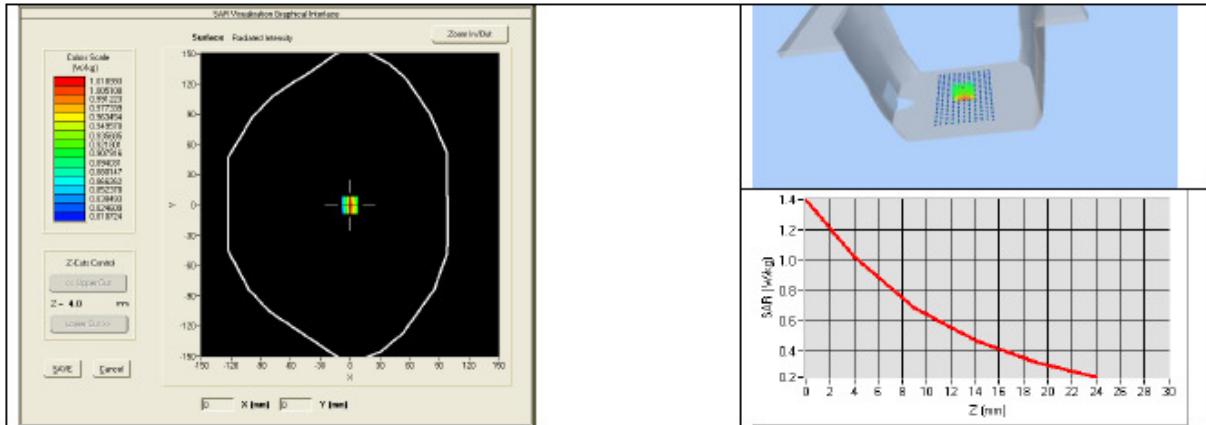

## 8 LIST OF EQUIPMENT

| Equipment Summary Sheet         |                      |                    |                                               |                                               |
|---------------------------------|----------------------|--------------------|-----------------------------------------------|-----------------------------------------------|
| Equipment Description           | Manufacturer / Model | Identification No. | Current Calibration Date                      | Next Calibration Date                         |
| SAM Phantom                     | Satimo               | SN-20/09-SAM71     | Validated. No cal required.                   | Validated. No cal required.                   |
| COMOSAR Test Bench              | Version 3            | NA                 | Validated. No cal required.                   | Validated. No cal required.                   |
| Network Analyzer                | Rhode & Schwarz ZVA  | SN100132           | 02/2013                                       | 02/2016                                       |
| Calipers                        | Carrera              | CALIPER-01         | 12/2013                                       | 12/2016                                       |
| Reference Probe                 | Satimo               | EPG122 SN 18/11    | Characterized prior to test. No cal required. | Characterized prior to test. No cal required. |
| Multimeter                      | Keithley 2000        | 1188656            | 12/2013                                       | 12/2016                                       |
| Signal Generator                | Agilent E4438C       | MY49070581         | 12/2013                                       | 12/2016                                       |
| Amplifier                       | Aethercomm           | SN 046             | Characterized prior to test. No cal required. | Characterized prior to test. No cal required. |
| Power Meter                     | HP E4418A            | US38261498         | 12/2013                                       | 12/2016                                       |
| Power Sensor                    | HP ECP-E26A          | US37181460         | 12/2013                                       | 12/2016                                       |
| Directional Coupler             | Narda 4216-20        | 01386              | Characterized prior to test. No cal required. | Characterized prior to test. No cal required. |
| Temperature and Humidity Sensor | Control Company      | 11-661-9           | 8/2012                                        | 8/2015                                        |





## SAR Reference Dipole Calibration Report

Ref : ACR.170.4.14.SATU.A

### SIEMIC TESTING AND CERTIFICATION SERVICES

ZONE A,FLOOR 1,BUILDING 2,WAN YE LONG  
TECHNOLOGY PARK,SOUTH SIDE OF ZHOUSHI ROAD,  
SHIYAN STREET,BAO'AN DISTRICT, SHENZHEN 518108 ,  
GUANGDONG , P.R.C.

#### SATIMO COMOSAR REFERENCE DIPOLE

FREQUENCY: 1900 MHZ

SERIAL NO.: SN 18/11 DIPG153

Calibrated at SATIMO US

2105 Barrett Park Dr. - Kennesaw, GA 30144



06/18/2014

#### *Summary:*

This document presents the method and results from an accredited SAR reference dipole calibration performed in SATIMO USA using the COMOSAR test bench. All calibration results are traceable to national metrology institutions.

|             |                |
|-------------|----------------|
| Test Report | 17070028-FCC-H |
| Page        | 74 of 86       |



SAR REFERENCE DIPOLE CALIBRATION REPORT

Ref: ACR.170.4.14.SATU.A

|                      | <i>Name</i>   | <i>Function</i> | <i>Date</i> | <i>Signature</i>     |
|----------------------|---------------|-----------------|-------------|----------------------|
| <i>Prepared by :</i> | Jérôme LUC    | Product Manager | 6/19/2014   | <i>JS</i>            |
| <i>Checked by :</i>  | Jérôme LUC    | Product Manager | 6/19/2014   | <i>JS</i>            |
| <i>Approved by :</i> | Kim RUTKOWSKI | Quality Manager | 6/19/2014   | <i>Kim Rutkowski</i> |

|                       |                                           |
|-----------------------|-------------------------------------------|
|                       | <i>Customer Name</i>                      |
| <i>Distribution :</i> | SIEMIC Testing and Certification Services |

| <i>Issue</i> | <i>Date</i> | <i>Modifications</i> |
|--------------|-------------|----------------------|
| A            | 6/19/2014   | Initial release      |
|              |             |                      |
|              |             |                      |

**TABLE OF CONTENTS**

|     |                                       |    |
|-----|---------------------------------------|----|
| 1   | Introduction.....                     | 4  |
| 2   | Device Under Test .....               | 4  |
| 3   | Product Description .....             | 4  |
| 3.1 | General Information .....             | 4  |
| 4   | Measurement Method .....              | 5  |
| 4.1 | Return Loss Requirements .....        | 5  |
| 4.2 | Mechanical Requirements .....         | 5  |
| 5   | Measurement Uncertainty.....          | 5  |
| 5.1 | Return Loss .....                     | 5  |
| 5.2 | Dimension Measurement .....           | 5  |
| 5.3 | Validation Measurement .....          | 5  |
| 6   | Calibration Measurement Results ..... | 6  |
| 6.1 | Return Loss and Impedance .....       | 6  |
| 6.2 | Mechanical Dimensions .....           | 6  |
| 7   | Validation measurement .....          | 7  |
| 7.1 | Measurement Condition .....           | 7  |
| 7.2 | Head Liquid Measurement .....         | 7  |
| 7.3 | Measurement Result .....              | 8  |
| 7.4 | Body Measurement Result .....         | 9  |
| 8   | List of Equipment .....               | 10 |

## 1 INTRODUCTION

This document contains a summary of the requirements set forth by the IEEE 1528, OET 65 Bulletin C and CEI/IEC 62209 standards for reference dipoles used for SAR measurement system validations and the measurements that were performed to verify that the product complies with the fore mentioned standards.

## 2 DEVICE UNDER TEST

| Device Under Test              |                                   |
|--------------------------------|-----------------------------------|
| Device Type                    | COMOSAR 1900 MHz REFERENCE DIPOLE |
| Manufacturer                   | Satimo                            |
| Model                          | SID1900                           |
| Serial Number                  | SN 18/11 DIPG153                  |
| Product Condition (new / used) | used                              |

A yearly calibration interval is recommended.

## 3 PRODUCT DESCRIPTION

### 3.1 GENERAL INFORMATION

Satimo's COMOSAR Validation Dipoles are built in accordance to the IEEE 1528, OET 65 Bulletin C and CEI/IEC 62209 standards. The product is designed for use with the COMOSAR test bench only.



**Figure 1 – Satimo COMOSAR Validation Dipole**

#### 4 MEASUREMENT METHOD

The IEEE 1528, OET 65 Bulletin C and CEI/IEC 62209 standards provide requirements for reference dipoles used for system validation measurements. The following measurements were performed to verify that the product complies with the fore mentioned standards.

##### 4.1 RETURN LOSS REQUIREMENTS

The dipole used for SAR system validation measurements and checks must have a return loss of -20 dB or better. The return loss measurement shall be performed against a liquid filled flat phantom, with the phantom constructed as outlined in the fore mentioned standards.

##### 4.2 MECHANICAL REQUIREMENTS

The IEEE Std. 1528 and CEI/IEC 62209 standards specify the mechanical components and dimensions of the validation dipoles, with the dimensions frequency and phantom shell thickness dependent. The COMOSAR test bench employs a 2 mm phantom shell thickness therefore the dipoles sold for use with the COMOSAR test bench comply with the requirements set forth for a 2 mm phantom shell thickness.

#### 5 MEASUREMENT UNCERTAINTY

All uncertainties listed below represent an expanded uncertainty expressed at approximately the 95% confidence level using a coverage factor of  $k=2$ , traceable to the Internationally Accepted Guides to Measurement Uncertainty.

##### 5.1 RETURN LOSS

The following uncertainties apply to the return loss measurement:

| Frequency band | Expanded Uncertainty on Return Loss |
|----------------|-------------------------------------|
| 400-6000MHz    | 0.1 dB                              |

##### 5.2 DIMENSION MEASUREMENT

The following uncertainties apply to the dimension measurements:

| Length (mm) | Expanded Uncertainty on Length |
|-------------|--------------------------------|
| 3 - 300     | 0.05 mm                        |

##### 5.3 VALIDATION MEASUREMENT

The guidelines outlined in the IEEE 1528, OET 65 Bulletin C, CENELEC EN50361 and CEI/IEC 62209 standards were followed to generate the measurement uncertainty for validation measurements.

| Scan Volume | Expanded Uncertainty |
|-------------|----------------------|
| 1 g         | 20.3 %               |
| 10 g        | 20.1 %               |

## 6 CALIBRATION MEASUREMENT RESULTS

### 6.1 RETURN LOSS AND IMPEDANCE

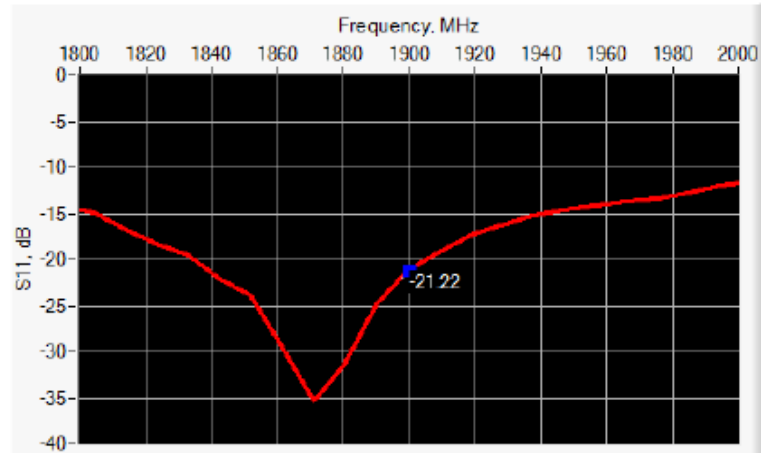

| Frequency (MHz) | Return Loss (dB) | Requirement (dB) | Impedance       |
|-----------------|------------------|------------------|-----------------|
| 1900            | -21.22           | -20              | 52.7 Ω + 8.6 jΩ |

### 6.2 MECHANICAL DIMENSIONS

| Frequency MHz | L mm        |          | h mm        |          | d mm       |          |
|---------------|-------------|----------|-------------|----------|------------|----------|
|               | required    | measured | required    | measured | required   | measured |
| 300           | 420.0 ±1 %. |          | 250.0 ±1 %. |          | 6.35 ±1 %. |          |
| 450           | 290.0 ±1 %. |          | 166.7 ±1 %. |          | 6.35 ±1 %. |          |
| 750           | 176.0 ±1 %. |          | 100.0 ±1 %. |          | 6.35 ±1 %. |          |
| 835           | 161.0 ±1 %. |          | 89.8 ±1 %.  |          | 3.6 ±1 %.  |          |
| 900           | 149.0 ±1 %. |          | 83.3 ±1 %.  |          | 3.6 ±1 %.  |          |
| 1450          | 89.1 ±1 %.  |          | 51.7 ±1 %.  |          | 3.6 ±1 %.  |          |
| 1500          | 80.5 ±1 %.  |          | 50.0 ±1 %.  |          | 3.6 ±1 %.  |          |
| 1640          | 79.0 ±1 %.  |          | 45.7 ±1 %.  |          | 3.6 ±1 %.  |          |
| 1750          | 75.2 ±1 %.  |          | 42.9 ±1 %.  |          | 3.6 ±1 %.  |          |
| 1800          | 72.0 ±1 %.  |          | 41.7 ±1 %.  |          | 3.6 ±1 %.  |          |
| 1900          | 68.0 ±1 %.  | PASS     | 39.5 ±1 %.  | PASS     | 3.6 ±1 %.  | PASS     |
| 1950          | 66.3 ±1 %.  |          | 38.5 ±1 %.  |          | 3.6 ±1 %.  |          |
| 2000          | 64.5 ±1 %.  |          | 37.5 ±1 %.  |          | 3.6 ±1 %.  |          |
| 2100          | 61.0 ±1 %.  |          | 35.7 ±1 %.  |          | 3.6 ±1 %.  |          |
| 2300          | 55.5 ±1 %.  |          | 32.6 ±1 %.  |          | 3.6 ±1 %.  |          |
| 2450          | 51.5 ±1 %.  |          | 30.4 ±1 %.  |          | 3.6 ±1 %.  |          |
| 2600          | 48.5 ±1 %.  |          | 28.8 ±1 %.  |          | 3.6 ±1 %.  |          |
| 3000          | 41.5 ±1 %.  |          | 25.0 ±1 %.  |          | 3.6 ±1 %.  |          |
| 3500          | 37.0 ±1 %.  |          | 26.4 ±1 %.  |          | 3.6 ±1 %.  |          |
| 3700          | 34.7 ±1 %.  |          | 26.4 ±1 %.  |          | 3.6 ±1 %.  |          |

## 7 VALIDATION MEASUREMENT

The IEEE Std. 1528, OET 65 Bulletin C and CEI/IEC 62209 standards state that the system validation measurements must be performed using a reference dipole meeting the fore mentioned return loss and mechanical dimension requirements. The validation measurement must be performed against a liquid filled flat phantom, with the phantom constructed as outlined in the fore mentioned standards. Per the standards, the dipole shall be positioned below the bottom of the phantom, with the dipole length centered and parallel to the longest dimension of the flat phantom, with the top surface of the dipole at the described distance from the bottom surface of the phantom.

### 7.1 MEASUREMENT CONDITION

|                                           |                                                          |
|-------------------------------------------|----------------------------------------------------------|
| Software                                  | OPENSAR V4                                               |
| Phantom                                   | SN 20/09 SAM71                                           |
| Probe                                     | SN 18/11 EPG122                                          |
| Liquid                                    | Head Liquid Values: $\epsilon_r'$ : 40.9 $\sigma$ : 1.45 |
| Distance between dipole center and liquid | 10.0 mm                                                  |
| Area scan resolution                      | $dx=8mm/dy=8mm$                                          |
| Zoon Scan Resolution                      | $dx=8mm/dy=8m/dz=5mm$                                    |
| Frequency                                 | 1900 MHz                                                 |
| Input power                               | 20 dBm                                                   |
| Liquid Temperature                        | 21 °C                                                    |
| Lab Temperature                           | 21 °C                                                    |
| Lab Humidity                              | 45 %                                                     |

### 7.2 HEAD LIQUID MEASUREMENT

| Frequency<br>MHz | Relative permittivity ( $\epsilon_r'$ ) |          | Conductivity ( $\sigma$ ) S/m |          |
|------------------|-----------------------------------------|----------|-------------------------------|----------|
|                  | required                                | measured | required                      | measured |
| 300              | 45.3 ±5 %                               |          | 0.87 ±5 %                     |          |
| 450              | 43.5 ±5 %                               |          | 0.87 ±5 %                     |          |
| 750              | 41.9 ±5 %                               |          | 0.89 ±5 %                     |          |
| 835              | 41.5 ±5 %                               |          | 0.90 ±5 %                     |          |
| 900              | 41.5 ±5 %                               |          | 0.97 ±5 %                     |          |
| 1450             | 40.5 ±5 %                               |          | 1.20 ±5 %                     |          |
| 1500             | 40.4 ±5 %                               |          | 1.23 ±5 %                     |          |
| 1640             | 40.2 ±5 %                               |          | 1.31 ±5 %                     |          |
| 1750             | 40.1 ±5 %                               |          | 1.37 ±5 %                     |          |
| 1800             | 40.0 ±5 %                               |          | 1.40 ±5 %                     |          |
| 1900             | 40.0 ±5 %                               | PASS     | 1.40 ±5 %                     | PASS     |
| 1950             | 40.0 ±5 %                               |          | 1.40 ±5 %                     |          |
| 2000             | 40.0 ±5 %                               |          | 1.40 ±5 %                     |          |
| 2100             | 39.8 ±5 %                               |          | 1.49 ±5 %                     |          |
| 2300             | 39.5 ±5 %                               |          | 1.67 ±5 %                     |          |
| 2450             | 39.2 ±5 %                               |          | 1.80 ±5 %                     |          |
| 2600             | 39.0 ±5 %                               |          | 1.96 ±5 %                     |          |
| 3000             | 38.5 ±5 %                               |          | 2.40 ±5 %                     |          |
| 3500             | 37.9 ±5 %                               |          | 2.91 ±5 %                     |          |

7.3 MEASUREMENT RESULT

The IEEE Std. 1528 and CEI/IEC 62209 standards state that the system validation measurements should produce the SAR values shown below (for phantom thickness of 2 mm), within the uncertainty for the system validation. All SAR values are normalized to 1 W forward power. In bracket, the measured SAR is given with the used input power.

| Frequency<br>MHz | 1 g SAR (W/kg/W) |              | 10 g SAR (W/kg/W) |              |
|------------------|------------------|--------------|-------------------|--------------|
|                  | required         | measured     | required          | measured     |
| 300              | 2.85             |              | 1.94              |              |
| 450              | 4.58             |              | 3.06              |              |
| 750              | 8.49             |              | 5.55              |              |
| 835              | 9.56             |              | 6.22              |              |
| 900              | 10.9             |              | 6.99              |              |
| 1450             | 29               |              | 16                |              |
| 1500             | 30.5             |              | 16.8              |              |
| 1640             | 34.2             |              | 18.4              |              |
| 1750             | 36.4             |              | 19.3              |              |
| 1800             | 38.4             |              | 20.1              |              |
| 1900             | 39.7             | 39.52 (3.95) | 20.5              | 20.03 (2.00) |
| 1950             | 40.5             |              | 20.9              |              |
| 2000             | 41.1             |              | 21.1              |              |
| 2100             | 43.6             |              | 21.9              |              |
| 2300             | 48.7             |              | 23.3              |              |
| 2450             | 52.4             |              | 24                |              |
| 2600             | 55.3             |              | 24.6              |              |
| 3000             | 63.8             |              | 25.7              |              |
| 3500             | 67.1             |              | 25                |              |

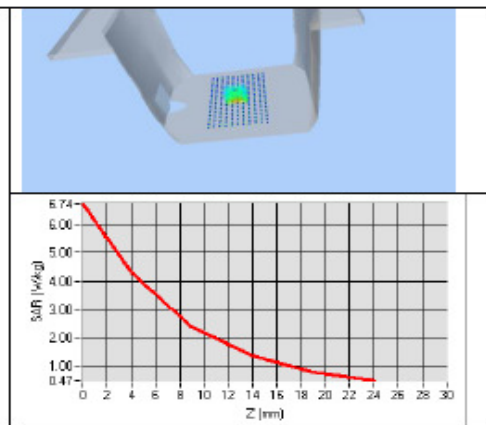
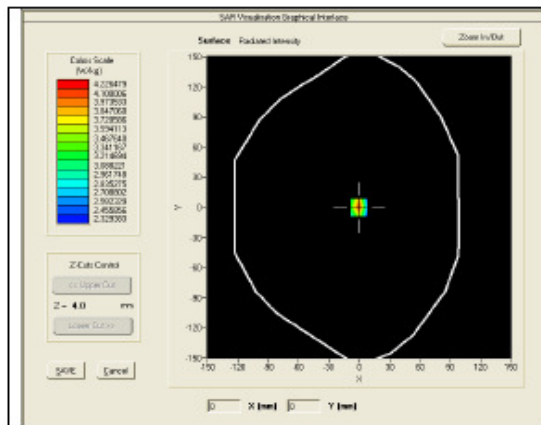



7.4 BODY MEASUREMENT RESULT

|                                           |                                                             |
|-------------------------------------------|-------------------------------------------------------------|
| Software                                  | OPENSAR V4                                                  |
| Phantom                                   | SN 20/09 SAM71                                              |
| Probe                                     | SN 18/11 EPG122                                             |
| Liquid                                    | Body Liquid Values: $\epsilon_{ps}' : 53.6$ $\sigma : 1.52$ |
| Distance between dipole center and liquid | 10.0 mm                                                     |
| Area scan resolution                      | $dx=8mm/dy=8mm$                                             |
| Zoon Scan Resolution                      | $dx=8mm/dy=8m/dz=5mm$                                       |
| Frequency                                 | 1900 MHz                                                    |
| Input power                               | 20 dBm                                                      |
| Liquid Temperature                        | 21 °C                                                       |
| Lab Temperature                           | 21 °C                                                       |
| Lab Humidity                              | 45 %                                                        |

| Frequency MHz | 1 g SAR (W/kg/W) | 10 g SAR (W/kg/W) |
|---------------|------------------|-------------------|
|               | measured         | measured          |
| 1900          | 42.88 (4.29)     | 21.39 (2.14)      |

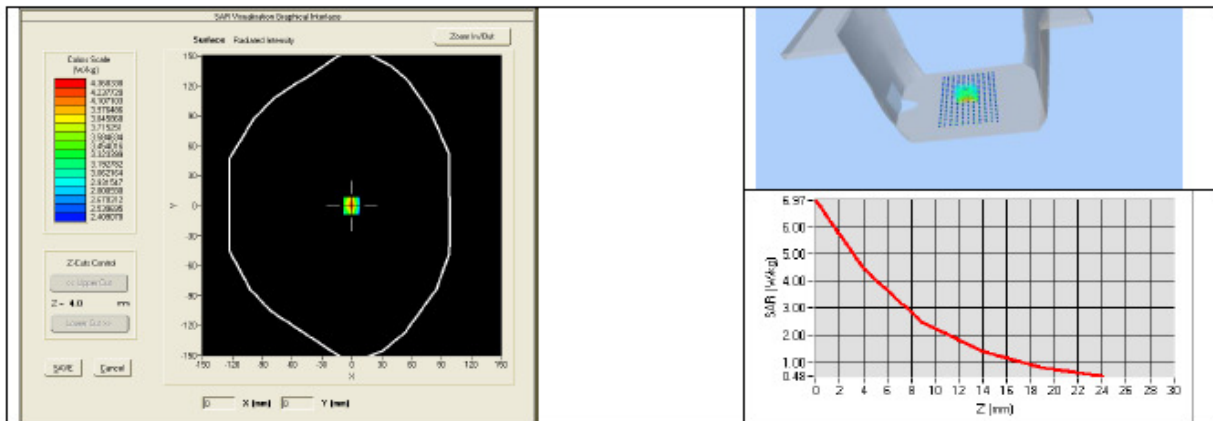

## 8 LIST OF EQUIPMENT

| Equipment Summary Sheet         |                      |                    |                                               |                                               |
|---------------------------------|----------------------|--------------------|-----------------------------------------------|-----------------------------------------------|
| Equipment Description           | Manufacturer / Model | Identification No. | Current Calibration Date                      | Next Calibration Date                         |
| SAM Phantom                     | Satimo               | SN-20/09-SAM71     | Validated. No cal required.                   | Validated. No cal required.                   |
| COMOSAR Test Bench              | Version 3            | NA                 | Validated. No cal required.                   | Validated. No cal required.                   |
| Network Analyzer                | Rhode & Schwarz ZVA  | SN100132           | 02/2013                                       | 02/2016                                       |
| Calipers                        | Carrera              | CALIPER-01         | 12/2013                                       | 12/2016                                       |
| Reference Probe                 | Satimo               | EPG122 SN 18/11    | Characterized prior to test. No cal required. | Characterized prior to test. No cal required. |
| Multimeter                      | Keithley 2000        | 1188656            | 12/2013                                       | 12/2016                                       |
| Signal Generator                | Agilent E4438C       | MY49070581         | 12/2013                                       | 12/2016                                       |
| Amplifier                       | Aethercomm           | SN 046             | Characterized prior to test. No cal required. | Characterized prior to test. No cal required. |
| Power Meter                     | HP E4418A            | US38261498         | 12/2013                                       | 12/2016                                       |
| Power Sensor                    | HP ECP-E26A          | US37181460         | 12/2013                                       | 12/2016                                       |
| Directional Coupler             | Narda 4216-20        | 01386              | Characterized prior to test. No cal required. | Characterized prior to test. No cal required. |
| Temperature and Humidity Sensor | Control Company      | 11-661-9           | 8/2012                                        | 8/2015                                        |

**Annex B SAR System PHOTOGRAPHS**



Liquid depth  $\geq 15\text{cm}$



**Annex C SETUP PHOTOGRAPHS**

**Right Head Touch View**

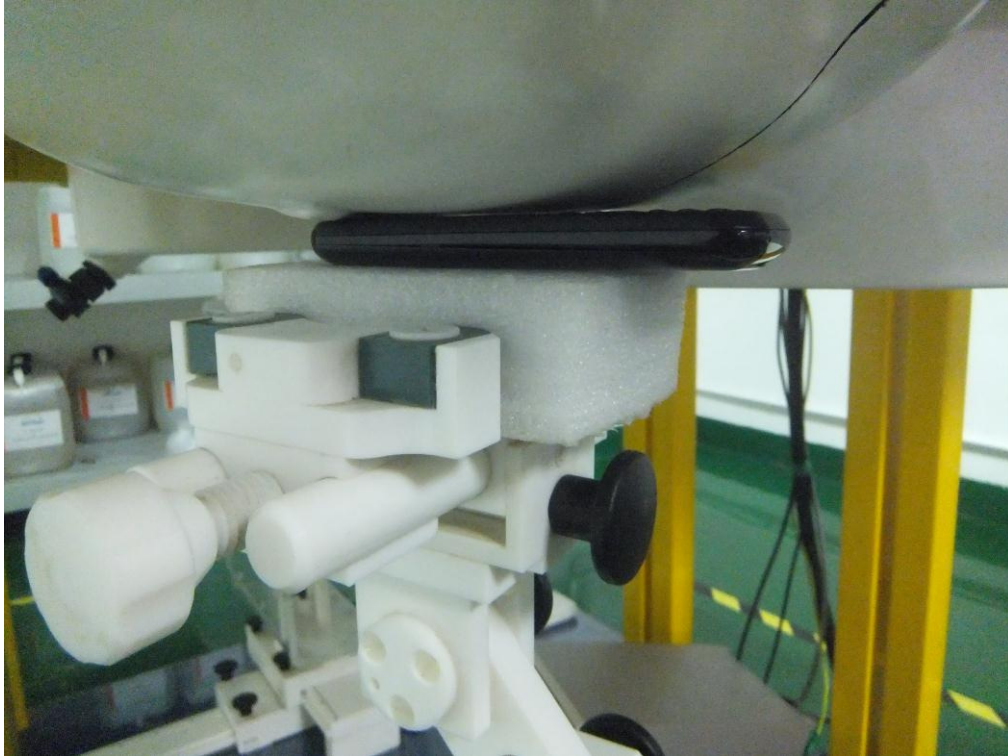

**Right Head Tilt View**

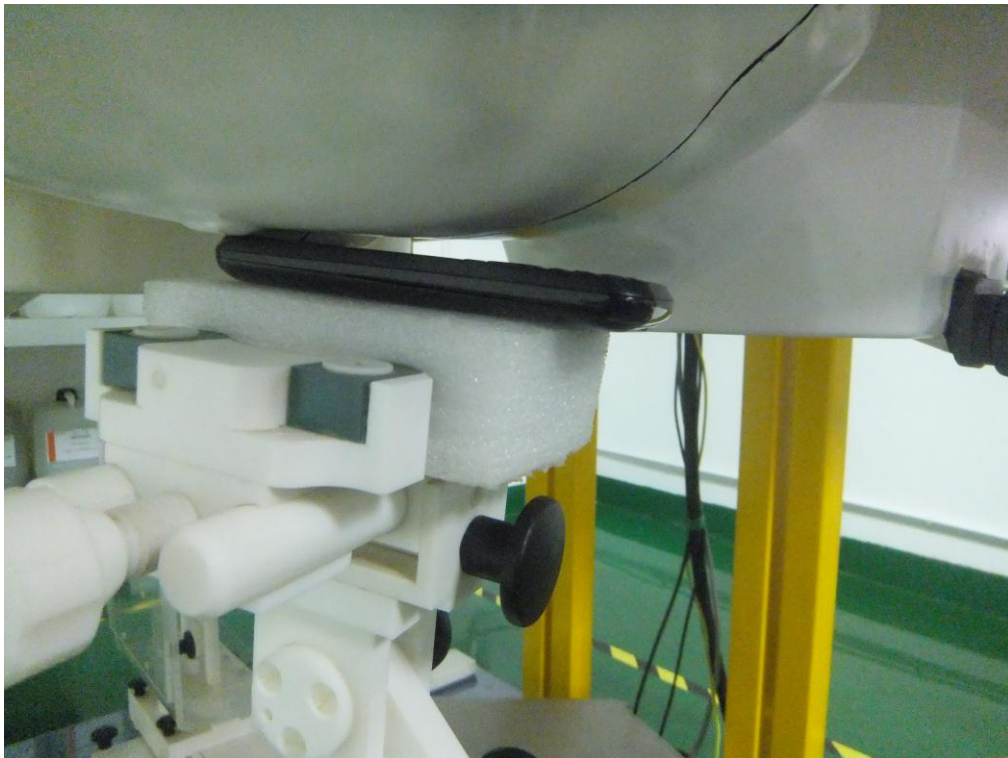

**Left Head Touch View**



**Left Head Tilt View**



**Body Setup Photo (LCD UP)**

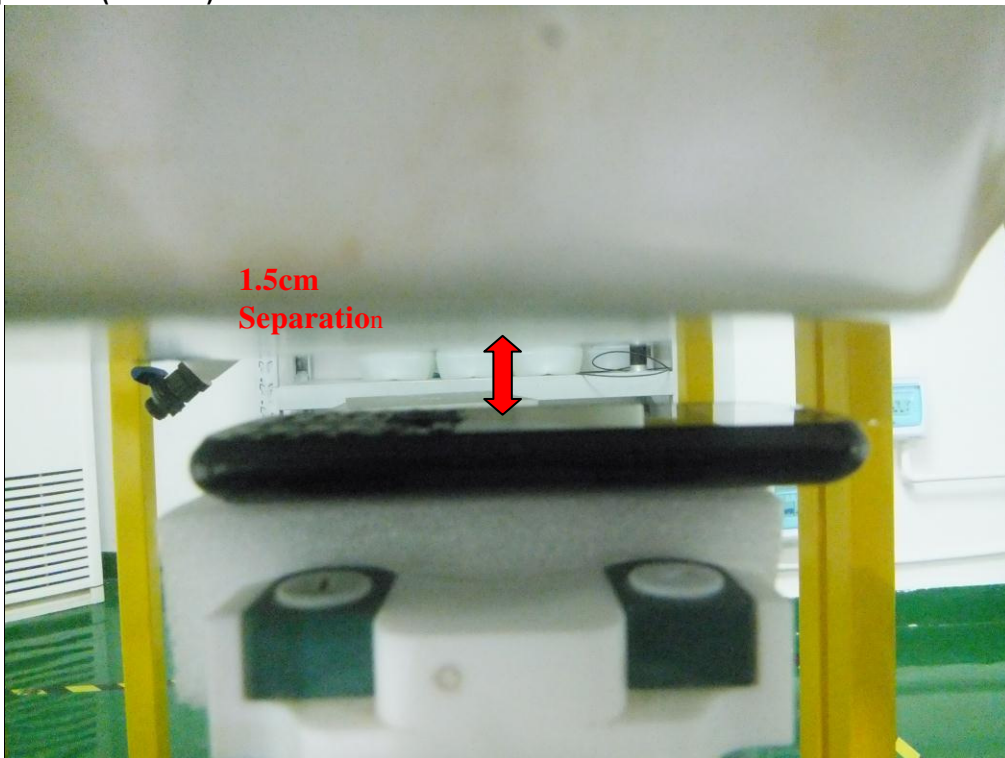

**Body Setup Photo (LCD DOWN)**

