

FCC CERTIFICATION TEST REPORT

FOR

| | | |
|-----------------------------|---|--|
| Applicant | : | Shenzhen Jiayinking Technology Holding Company Limited |
| Address | : | No.11, 11-1, Anye Road, Anliang village, Henggang Town, Longgang District, Shenzhen, China |
| Equipment under Test | : | The Hampton Bluetooth Turntable |
| Model No. | : | VM-130 |
| Trade Mark | : | VICTROLA, Innovative Technology |
| FCC ID | : | 2ADA2-VM-130 |
| Manufacturer | : | Shenzhen Jiayinking Technology Holding Company Limited |
| Address | : | No.11, 11-1, Anye Road, Anliang village, Henggang Town, Longgang District, Shenzhen, China |

Issued By: Dongguan Dongdian Testing Service Co., Ltd.

Add: No. 17, Zongbu Road 2, Songshan Lake Sci&Tech, Industry Park, Dongguan City,
Guangdong Province, China, 523808

Tel: +86-0769-22891499 [Http://www.dgddt.com](http://www.dgddt.com)

REPORT

TABLE OF CONTENTS

- Test report declares.....4
- 1. Summary of test results 5
- 2. General test information..... 6
 - 2.1. Description of EUT 6
 - 2.2. Accessories of EUT..... 6
 - 2.3. Assistant equipment used for test..... 6
 - 2.4. Block diagram of EUT configuration for test 6
 - 2.5. Deviations of test standard 7
 - 2.6. Test environment conditions 7
 - 2.7. Test laboratory..... 7
 - 2.8. Measurement uncertainty 7
- 3. Equipment used during test..... 9
- 4. Maximum Peak Output Power 10
 - 4.1. Block diagram of test setup 10
 - 4.2. Limits 10
 - 4.3. Test Procedure..... 10
 - 4.4. Test Result..... 10
- 5. 20dB Bandwidth and 99% Bandwidth..... 11
 - 5.1. Block diagram of test setup 11
 - 5.2. Limits 11
 - 5.3. Test Procedure..... 11
 - 5.4. Test Result..... 11
 - 5.5. Original test data 12
- 6. Carrier Frequency Separation..... 14
 - 6.1. Block diagram of test setup 14
 - 6.2. Limits 14
 - 6.3. Test Procedure..... 14
 - 6.4. Test Result..... 14
 - 6.5. Original test data 14
- 7. Number Of Hopping Channel 15
 - 7.1. Block diagram of test setup 15
 - 7.2. Limits 15
 - 7.3. Test Procedure..... 15
 - 7.4. Test Result..... 15
 - 7.5. Original test data 15
- 8. Dwell Time..... 16
 - 8.1. Block diagram of test setup 16

| | | |
|-------|--|----|
| 8.2. | Limits | 16 |
| 8.3. | Test Procedure..... | 16 |
| 8.4. | Test Result..... | 17 |
| 8.5. | Original test data | 17 |
| 9. | Radiated emission | 20 |
| 9.1. | Block diagram of test setup | 20 |
| 9.2. | Limit | 21 |
| 9.3. | Test Procedure..... | 22 |
| 9.4. | Test result | 23 |
| 10. | Band Edge Compliance (radiated method) | 27 |
| 10.1. | Block diagram of test setup | 27 |
| 10.2. | Limit | 27 |
| 10.3. | Test Procedure..... | 27 |
| 10.4. | Test result | 27 |
| 11. | Band Edge Compliance (conducted method)..... | 36 |
| 11.1. | Block diagram of test setup | 36 |
| 11.2. | Limit | 36 |
| 11.3. | Test result | 36 |
| 11.4. | Original test data | 36 |
| 12. | Power Line Conducted Emission | 40 |
| 12.1. | Block diagram of test setup | 40 |
| 12.2. | Power Line Conducted Emission Limits | 40 |
| 12.3. | Test Procedure..... | 40 |
| 12.4. | Test Result..... | 41 |
| 13. | Antenna Requirements | 44 |
| 13.1. | Limit | 44 |
| 13.2. | Result..... | 44 |
| 14. | Test setup photograph | 45 |
| 15. | Photos of the EUT | 47 |

TEST REPORT DECLARE

| | | |
|-----------------------------|---|--|
| Applicant | : | Shenzhen Jiayinking Technology Holding Company Limited |
| Address | : | No.11, 11-1, Anye Road, Anliang village, Henggang Town, Longgang District, Shenzhen, China |
| Equipment under Test | : | The Hampton Bluetooth Turntable |
| Model No. | : | VM-130 |
| Trade Mark | : | VICTROLA, Innovative Technology |
| Manufacturer | : | Shenzhen Jiayinking Technology Holding Company Limited |
| Address | : | No.11, 11-1, Anye Road, Anliang village, Henggang Town, Longgang District, Shenzhen, China |

Test Standard Used:

CFR47 FCC Part 15: Subpart C Section 15.247; CFR47 FCC Part 15: Subpart C Section 15.207;

CFR47 FCC Part 15: Subpart C Section 15.209;

RSS-247 Issue 2 February 2017; RSS-Gen Issue 4, Nov. 2014; RSS-102 Issue 5, Mar. 2015.

Test procedure used:

ANSI C63.10:2013, ANSI C63.4:2014, FCC KDB Publication 447498 D01 v06.

We Declare:

The equipment described above is tested by Dongguan Dongdian Testing Service Co., Ltd. and in the configuration tested the equipment complied with the standards specified above. The test results are contained in this test report and Dongguan Dongdian Testing Service Co., Ltd. is assumed of full responsibility for the accuracy and completeness of these tests.

After test and evaluation, our opinion is that the equipment provided for test compliance with the requirement of the above FCC standards.

| | | | |
|-------------------------|------------------|----------------------|-----------------------------|
| Report No: | DDT-R17Q0412-1E3 | | |
| Date of Receipt: | Apr. 18, 2017 | Date of Test: | Apr. 18, 2017~Apr. 21, 2017 |

Prepared By:



Leo Liu/Engineer

Approved By:



Kevin Feng/EMC Manager

Note: This report applies to above tested sample only. This report shall not be reproduced in parts without written approval of Dongguan Dongdian Testing Service Co., Ltd.

1. Summary of test results

| Description of Test Item | Standard | Results |
|----------------------------------|---|---------|
| Maximum Peak Output Power | FCC Part 15: 15.247(b)(1) ANSI C63.10:2013 RSS-247 Issue 2 clause 5.1 | PASS |
| 20dB Bandwidth and 99% Bandwidth | FCC Part 15: 15.215 ANSI C63.10:2013 RSS-247 Issue 2 clause 5.1 | PASS |
| Carrier Frequency Separation | FCC Part 15: 15.247(a)(1) ANSI C63.10:2013 RSS-247 Issue 2 clause 5.1 | PASS |
| Number Of Hopping Channel | FCC Part 15: 15.247(a)(1)(iii) ANSI C63.10:2013 RSS-247 Issue 2 clause 5.1 | PASS |
| Dwell Time | FCC Part 15: 15.247(a)(1)(iii) ANSI C63.10:2013 RSS-247 Issue 2 clause 5.1 | PASS |
| Radiated Emission | FCC Part 15: 15.209 FCC Part 15: 15.247(d) ANSI C63.10:2013 RSS-247 Issue 2 clause 5.1 RSS-Gen Issue 4 clause 7.2.2 RSS-Gen Issue 4 clause 7.2.5 | PASS |
| Band Edge Compliance | FCC Part 15: 15.247(d) ANSI C63.10:2013 RSS-247 Issue 2 clause 5.1 RSS-Gen Issue 4 clause 7.2.2 RSS-Gen Issue 4 clause 7.2.5 | PASS |
| Power Line Conducted Emissions | FCC Part 15: 15.207 ANSI C63.10:2013 RSS-Gen Issue 4 clause 7.2.4 | PASS |
| Antenna requirement | FCC Part 15: 15.203 RSS-Gen Issue 4 clause 7.1.2 | PASS |

2. General test information

2.1. Description of EUT

| | |
|--------------------------|---|
| EUT* Name | : The Hampton Bluetooth Turntable |
| Model Number | : VM-130 |
| EUT function description | : Please reference user manual of this device |
| Power supply | : DC 12V from power supply input AC 120V/60Hz |
| Radio Specification | : Bluetooth V4.1 (BDR/EDR) |
| Operation frequency | : 2402MHz -2480MHz |
| Modulation | : GFSK, $\pi/4$ QPSK, 8-DPSK |
| Data rate | : 1Mbps, 2Mbps, 3Mbps |
| Antenna Type | : Integrated Antenna, maximum PK gain: 0 dBi |
| Sample Type | : Series production |

Note: EUT is the ab. of equipment under test.

2.2. Accessories of EUT

| Description of Accessories | Brand | Model number | Serial No. | Other |
|----------------------------|-------|----------------|------------|-----------------|
| SWITCHING POWER SUPPLY | GKY | GKYPB0200120US | N/A | Output: 12V, 2A |

2.3. Assistant equipment used for test

| Assistant equipment | Brand | Model number | Serial No. | Other |
|---------------------|-------|--------------|------------|-------|
| N/A | N/A | N/A | N/A | N/A |

2.4. Block diagram of EUT configuration for test



Test software: Bluesuite 2.6.0

The test software was used to control EUT work in Continuous TX mode, and select test channel, wireless mode as blow table.

| Tested mode, channel, information | | |
|-----------------------------------|-------------|-----------------|
| Mode | Channel | Frequency (MHz) |
| GFSK hopping on Tx Mode | CH0 to CH78 | 2402 to 2480 |
| $\pi/4$ QPSK Hopping on TX mode | CH0 to CH78 | 2402 to 2480 |
| 8-DPSK hopping on Tx Mode | CH0 to CH78 | 2402 to 2480 |
| GFSK hopping off Tx Mode | CH0 | 2402 |
| | CH39 | 2441 |
| | CH78 | 2480 |
| $\pi/4$ QPSK hopping off Tx Mode | CH0 | 2402 |
| | CH39 | 2441 |
| | CH78 | 2480 |
| 8-DPSK hopping off Tx Mode | CH0 | 2402 |
| | CH39 | 2441 |
| | CH78 | 2480 |

Note: For $\pi/4$ QPSK its same modulation type with 8-DPSK, and based exploratory test, there is no significant difference of that two types test result, so except output power, all other items final test were only performed with the worse case 8-DPSK and GFSK.

2.5. Deviations of test standard

No Deviation.

2.6. Test environment conditions

During the measurement the environmental conditions were within the listed ranges:

| | |
|--------------------|-----------|
| Temperature range: | 21-25°C |
| Humidity range: | 40-75% |
| Pressure range: | 86-106kPa |

2.7. Test laboratory

Dongguan Dongdian Testing Service Co., Ltd

Add: No. 17, Zongbu Road 2, Songshan Lake Sci&Tech, Industry Park, Dongguan City, Guangdong

Province, China, 523808 Tel: +86-0769-22891499 <http://www.dgddt.com>

FCC Registration Number: 270092 Industry Canada site registration number: 10288A-1

2.8. Measurement uncertainty

| Test Item | Uncertainty |
|--|-----------------------------------|
| Bandwidth | 1.1% |
| Peak Output Power(Conducted)(Spectrum analyzer) | 0.86dB(10 MHz \leq f < 3.6GHz); |
| | 1.38dB(3.6GHz \leq f < 8GHz) |
| Peak Output Power(Conducted)(Power Sensor) | 0.74dB |

| | |
|---|-------------------------------|
| Dwell Time | 0.6% |
| Conducted spurious emissions | 0.86dB(10 MHz ≤ f < 3.6GHz); |
| | 1.40dB(3.6GHz ≤ f < 8GHz) |
| | 1.66dB(8GHz ≤ f < 22GHz) |
| Uncertainty for radio frequency (RBW<20KHz) | 3×10^{-8} |
| Temperature | 0.4°C |
| Humidity | 2% |
| Uncertainty for Radiation Emission test (30MHz-1GHz) | 4.70 dB (Antenna Polarize: V) |
| | 4.84 dB (Antenna Polarize: H) |
| Uncertainty for Radiation Emission test (1GHz-18GHz) | 4.10dB(1-6GHz) |
| | 4.40dB (6GHz-18Gz) |
| Uncertainty for Power line conduction emission test | 3.32dB (150KHz-30MHz) |
| Note: This uncertainty represents an expanded uncertainty expressed at approximately the 95% confidence level using a coverage factor of k=2. | |

3. Equipment used during test

| Equipment | Manufacturer | Model No. | Serial No. | Last Cal. | Cal. Interval |
|--|------------------------------------|--------------|--------------|------------|---------------|
| RF Connected test | | | | | |
| Spectrum analyzer | R&S | FSU26 | 1166.1660.26 | 2016/10/16 | 1Year |
| Vertor Signal Generator | Agilent | E8267D | MY52098743 | 2016/10/20 | 1Year |
| Vector Signal Generator | Agilent | N5182A | MY48180737 | 2016/07/05 | 1Year |
| Power Sensor | Agilent | U2021XA | MY55150010 | 2017/04/17 | 1Year |
| Power Sensor | Agilent | U2021XA | MY55150011 | 2017/04/17 | 1Year |
| DC Power Source | MATRIS | MPS-3005L-3 | D813058W | 2016/10/24 | 1Year |
| Attenuator | Mini-Circuits | BW-S10W2 | 101109 | 2016/08/18 | 1Year |
| RF Cable | Micable | C10-01-01-1 | 100309 | 2016/08/18 | 1Year |
| Temp&Humi Programmable Chamber | Dongguan Bell | BE-TH-150M3 | 201208153364 | 2016/09/23 | 1Year |
| Test Software | JS Tonscend | JS1120-2 | Ver.2.5 | N/A | N/A |
| USB Data acquisition | Agilent | U2531A | TW55043503 | N/A | N/A |
| Auto control Unit | JS Tonscend | JS0806-2 | 158060010 | N/A | N/A |
| RE/RF in chamber | | | | | |
| EMI Test Receiver | R&S | ESU8 | 100316 | 2016/10/16 | 1Year |
| Spectrum analyzer | R&S | FSU26 | 1166.1660.26 | 2016/10/16 | 1Year |
| Trilog Broadband Antenna | Schwarzbeck | VULB9163 | 9163-462 | 2016/10/27 | 1 Year |
| Active Loop antenna | Schwarzbeck | FMZB-1519 | 1519-038 | 2016/10/27 | 1 Year |
| Double Ridged Horn Antenna | R&S | HF907 | 100276 | 2016/10/12 | 1 Year |
| Horn Antenna | ETS-LINDGERN | 3160 | SEL0076 | 2016/10/16 | 1 Year |
| Pre-amplifier | A.H. | PAM-0118 | 360 | 2016/10/16 | 1 Year |
| Pre-amplifier | Compliance Directions Systems Inc. | PAP-0126 | SEL0168 | 2016/10/16 | 1 Year |
| RF Cable | HUBSER | CP-X2 | W11.03 | 2016/10/16 | 1Year |
| RF Cable | HUBSER | CP-X1 | W12.02 | 2016/10/16 | 1 Year |
| MI Cable | HUBSER | C10-01-01-1M | 1091629 | 2016/10/16 | 1 Year |
| Test software | Audix | E3 | V 6.11111b | / | / |
| Conducted disturbance at mains terminals/Telecommunication port | | | | | |
| Test Receiver | R&S | ESU8 | 100316 | 2016/10/16 | 1 Year |
| LISN 1 | R&S | ENV216 | 101109 | 2016/10/16 | 1 Year |
| LISN 2 | R&S | ESH2-Z5 | 100309 | 2016/10/16 | 1 Year |
| 8 Line ISN | R&S | ENY81 | 100063 | 2016/10/16 | 1Year |
| Pulse Limiter | R&S | ESH3-Z2 | 101242 | 2016/10/16 | 1 Year |
| CE Cable 1 | HUBSER | ESU8/RF2 | W10.01 | 2016/10/16 | 1 Year |
| Test software | Audix | E3 | V 6.11111b | / | / |

4. Maximum Peak Output Power

4.1. Block diagram of test setup

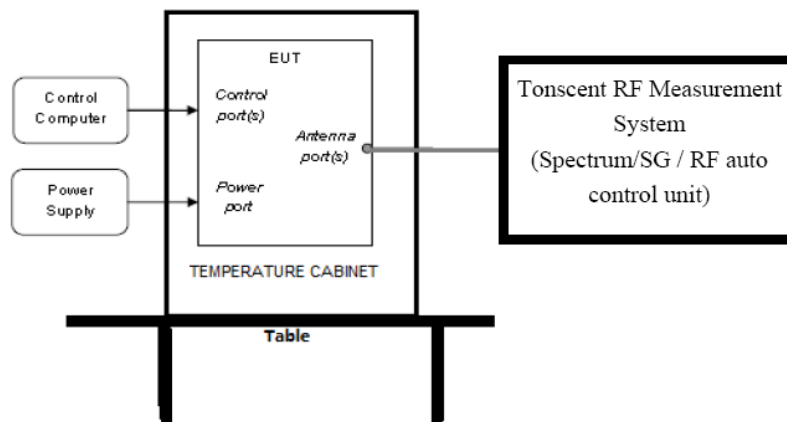

4.2. Limits

For frequency hopping systems operating in the 2400-2483.5 MHz band employing at least 75 non-overlapping hopping channels, and all frequency hopping systems in the 5725-5850 MHz band: 1 watt. For all other frequency hopping systems in the 2400-2483.5 MHz band: 0.125 watts, the e.i.r.p shall not exceed 4W.

4.3. Test Procedure

- (1) Connect EUT's antenna output to spectrum analyzer by RF cable.
- (2) Measure the maximum output power of EUT by spectrum analyzer with PK detector and RBW=2MHz(above 20dB bandwidth of measured signal), VBW=3MHz

Note: The attenuator loss was inputted into spectrum analyzer as amplitude offset.

4.4. Test Result

| Mode | Freq (MHz) | Result (dBm) | Limit (dBm) | Conclusion |
|--------|------------|--------------|-------------|------------|
| GFSK | 2402 | 1.440 | 21 | PASS |
| | 2441 | 3.560 | 21 | PASS |
| | 2480 | 3.400 | 21 | PASS |
| 8-DPSK | 2402 | -0.530 | 21 | PASS |
| | 2441 | 2.240 | 21 | PASS |
| | 2480 | 2.010 | 21 | PASS |

5. 20dB Bandwidth and 99% Bandwidth

5.1. Block diagram of test setup

Same as section 4.1

5.2. Limits

Intentional radiators operating under the alternative provisions to the general emission limits, as contained in § 15.217 through 15.257 and in Subpart E of this part, must be designed to ensure that the 20 dB bandwidth of the emission, or whatever bandwidth may otherwise be specified in the specific rule section under which the equipment operates, is contained within the frequency band designated in the rule section under which the equipment is operated.

5.3. Test Procedure

- (1) Connect EUT's antenna output to spectrum analyzer by RF cable.
- (2) The bandwidth of the fundamental frequency was measured by spectrum analyzer with 30 kHz RBW and 100 kHz VBW. The 20dB bandwidth is defined as the total spectrum the power of which is higher than peak power minus 20dB.

5.4. Test Result

| Mode | Freq (MHz) | 20dB bandwidth Result (MHz) | 99% bandwidth Result (MHz) | Conclusion |
|--------|------------|-----------------------------|----------------------------|------------|
| GFSK | 2402 | 1.112 | 0.954 | PASS |
| | 2441 | 1.114 | 0.950 | PASS |
| | 2480 | 1.112 | 0.950 | PASS |
| 8-DPSK | 2402 | 1.378 | 1.212 | PASS |
| | 2441 | 1.372 | 1.208 | PASS |
| | 2480 | 1.374 | 1.208 | PASS |

5.5. Original test data

| Graphs | |
|----------|---|
| GFSK/LCH | <p>Ref 20 dBm -Att 20 dB -RBW 100 kHz MaxKer 4 (T1) -16.73 dBm -VBM 300 kHz 2.402350000 GHz SWT 5 ms</p> <p>OSW#0.000000000 kHz MaxKer 1 (T1) 1.43 dBm 2.402180000 GHz MaxKer 3 (T1) -1.26 dBm 2.401430000 GHz Temp 1 (T1 OSW) -16.73 dBm 2.401300000 GHz 2 (T1 OSW) -17.01 dBm 2.402470000 GHz</p> <p>Center: 2.402 GHz 200 kHz/ Span: 2 MHz</p> <p>Date: 19.APR.2017 20:47:53</p> |
| GFSK/MCH | <p>Ref 20 dBm -Att 20 dB -RBW 100 kHz MaxKer 4 (T1) -16.69 dBm -VBM 300 kHz 2.441544000 GHz SWT 5 ms</p> <p>OSW#0.000000000 kHz MaxKer 1 (T1) 1.57 dBm 2.441190000 GHz MaxKer 3 (T1) -1.44 dBm 2.440430000 GHz Temp 1 (T1 OSW) -16.69 dBm 2.440500000 GHz 2 (T1 OSW) -17.08 dBm 2.441480000 GHz</p> <p>Center: 2.441 GHz 200 kHz/ Span: 2 MHz</p> <p>Date: 19.APR.2017 20:49:00</p> |
| GFSK/HCH | <p>Ref 20 dBm -Att 20 dB -RBW 100 kHz MaxKer 4 (T1) -16.69 dBm -VBM 300 kHz 2.480540000 GHz SWT 5 ms</p> <p>OSW#0.000000000 kHz MaxKer 1 (T1) 1.58 dBm 2.479990000 GHz MaxKer 3 (T1) -1.53 dBm 2.479420000 GHz Temp 1 (T1 OSW) -16.69 dBm 2.479500000 GHz 2 (T1 OSW) -17.09 dBm 2.480480000 GHz</p> <p>Center: 2.48 GHz 200 kHz/ Span: 2 MHz</p> <p>Date: 19.APR.2017 20:50:05</p> |

| | |
|------------------|---|
| <p>8DPSK/LCH</p> | <p>Ref 20 dBm -Att 20 dB -RBW 100 KHz -VBW 300 KHz SWT 5 ms</p> <p>OSW 1.212000000 MHz -19.36 dBm Marker 1 (T1) 2.401500000 GHz -22.61 dBm Marker 3 (T1) 2.401380000 GHz -22.61 dBm Temp 1 (T1) 2.401380000 GHz -22.61 dBm Temp 2 (T1) 2.401380000 GHz -22.61 dBm</p> <p>Center 2.402 GHz 200 kHz/ Span 2 MHz</p> <p>Date: 19.APR.2017 20:51:22</p> |
| <p>8DPSK/MCH</p> | <p>Ref 20 dBm -Att 20 dB -RBW 100 KHz -VBW 300 KHz SWT 5 ms</p> <p>OSW 1.208000000 MHz -19.36 dBm Marker 1 (T1) 2.440820000 GHz -19.36 dBm Marker 3 (T1) 2.440740000 GHz -19.36 dBm Temp 1 (T1) 2.440740000 GHz -19.36 dBm Temp 2 (T1) 2.440740000 GHz -19.36 dBm</p> <p>Center 2.441 GHz 200 kHz/ Span 2 MHz</p> <p>Date: 19.APR.2017 20:52:23</p> |
| <p>8DPSK/HCH</p> | <p>Ref 20 dBm -Att 20 dB -RBW 100 KHz -VBW 300 KHz SWT 5 ms</p> <p>OSW 1.208000000 MHz -19.61 dBm Marker 1 (T1) 2.479820000 GHz -19.61 dBm Marker 3 (T1) 2.479300000 GHz -19.61 dBm Temp 1 (T1) 2.479370000 GHz -19.61 dBm Temp 2 (T1) 2.479370000 GHz -19.61 dBm</p> <p>Center 2.48 GHz 200 kHz/ Span 2 MHz</p> <p>Date: 19.APR.2017 20:53:59</p> |

6. Carrier Frequency Separation

6.1. Block diagram of test setup

Same as section 4.1

6.2. Limits

Frequency hopping systems shall have hopping channel carrier frequencies separated by a minimum of 25 kHz or the 20 dB bandwidth of the hopping channel, whichever is greater. Alternatively, frequency hopping systems operating in the 2400-2483.5 MHz band may have hopping channel carrier frequencies that are separated by 25 kHz or two-thirds of the 20 dB bandwidth of the hopping channel, whichever is greater, provided the systems operate with an output power no greater than 125 mW.

6.3. Test Procedure

- (1) Connect EUT's antenna output to spectrum analyzer by RF cable.
- (2) The carrier frequency was measured by spectrum analyzer with 100 KHz RBW and 300 KHz VBW.

6.4. Test Result

| Mode | Channel separation (MHz) | Limit (MHz) 2/3 of 20dB bandwidth | Conclusion |
|--------|--------------------------|--|------------|
| GFSK | 1.002 | ≥ two-thirds of the 20 dB Bandwidth Of The Hopping Channel | PASS |
| 8-DPSK | 1.014 | ≥ two-thirds of the 20 dB Bandwidth Of The Hopping Channel | PASS |

6.5. Original test data

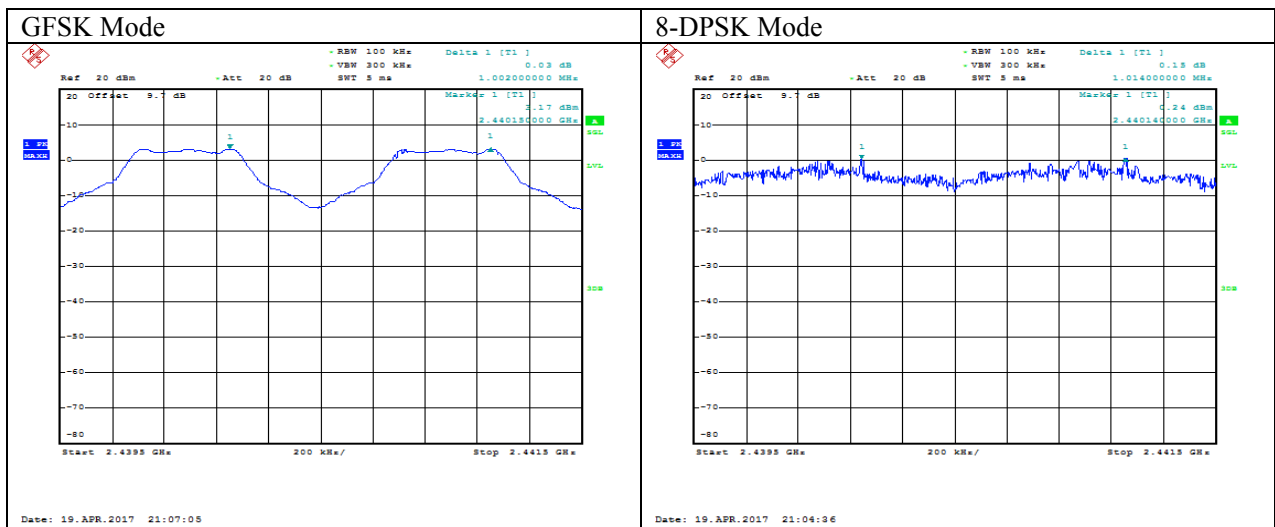

7. Number Of Hopping Channel

7.1. Block diagram of test setup

Same as section 4.1

7.2. Limits

Frequency hopping systems in the 2400-2483.5 MHz band shall use at least 15 channels.

7.3. Test Procedure

- (1) Connect EUT's antenna output to spectrum analyzer by RF cable.
- (2) The number of hopping channel was measured by spectrum analyzer with 100 kHz RBW and 300KHz VBW.

7.4. Test Result

| Mode | Number of hopping channel | Limit | Conclusion |
|--------|---------------------------|-------|------------|
| GFSK | 79 | >15 | PASS |
| 8-DPSK | 79 | >15 | PASS |

7.5. Original test data

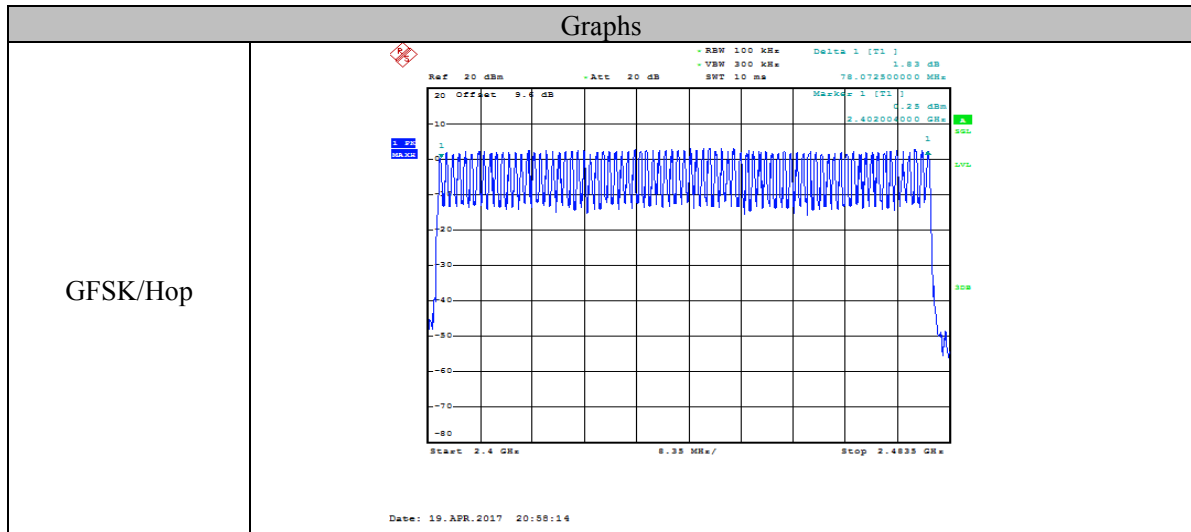

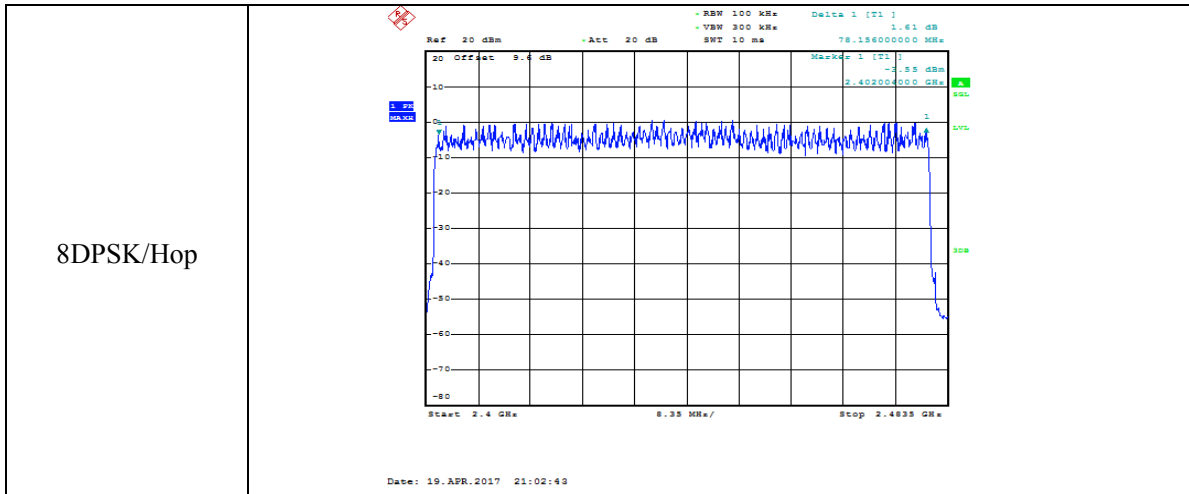

8. Dwell Time

8.1. Block diagram of test setup

Same as section 4.1

8.2. Limits

The average time of occupancy on any channel shall not be greater than 0.4 seconds within a period of 0.4 seconds multiplied by the number of hopping channels employed.

8.3. Test Procedure

- (1) Connect EUT's antenna output to spectrum analyzer by RF cable.
- (2) Measure the hopping number and on time of each pulse with spectrum analyzer in zero span set, and calculate dwell time with formula Dwell time = total hops *pulse's on time.

DH1 Packet permit maximum $1600 / 79 / 2 = 10.12$ hops per second in each channel (1 time slot RX, 1 time slot TX). So, total hops is $10.12 \times 31.6 = 320$.

DH3 Packet permit maximum $1600 / 79 / 4 = 5.06$ hops per second in each channel (3 time slots RX, 1 time slot TX). So, total hops is $5.06 \times 31.6 = 160$.

DH5 Packet permit maximum $1600 / 79 / 6 = 3.37$ hops per second in each channel (5 time slots RX, 1 time slot TX). So, total hops is $3.37 \times 31.6 = 106.6$.

3DH1 Packet permit maximum $1600 / 79 / 2 = 10.12$ hops per second in each channel (1 time slot RX, 1 time slot TX). So, total hops is $10.12 \times 31.6 = 320$.

3DH3 Packet permit maximum $1600 / 79 / 4 = 5.06$ hops per second in each channel (3 time slots RX, 1 time slot TX). So, total hops is $5.06 \times 31.6 = 160$.

3DH5 Packet permit maximum $1600 / 79 / 6 = 3.37$ hops per second in each channel (5 time slots RX, 1 time slot TX). So, total hops is $3.37 \times 31.6 = 106.6$.

8.4. Test Result

| Mode | Dwell time (s) | Pulse's on time (ms) | Total hops | Limit | Conclusion |
|-------|----------------|----------------------|------------|--------|------------|
| DH1 | 0.122 | 0.38 | 320 | <400ms | PASS |
| DH3 | 0.264 | 1.65 | 160 | <400ms | PASS |
| DH5 | 0.307 | 2.88 | 106.6 | <400ms | PASS |
| 3-DH1 | 0.128 | 0.4 | 320 | <400ms | PASS |
| 3-DH3 | 0.266 | 1.66 | 160 | <400ms | PASS |
| 3-DH5 | 0.309 | 2.9 | 106.6 | <400ms | PASS |

Note: Dwell time = total hops *pulse's on time.

8.5. Original test data

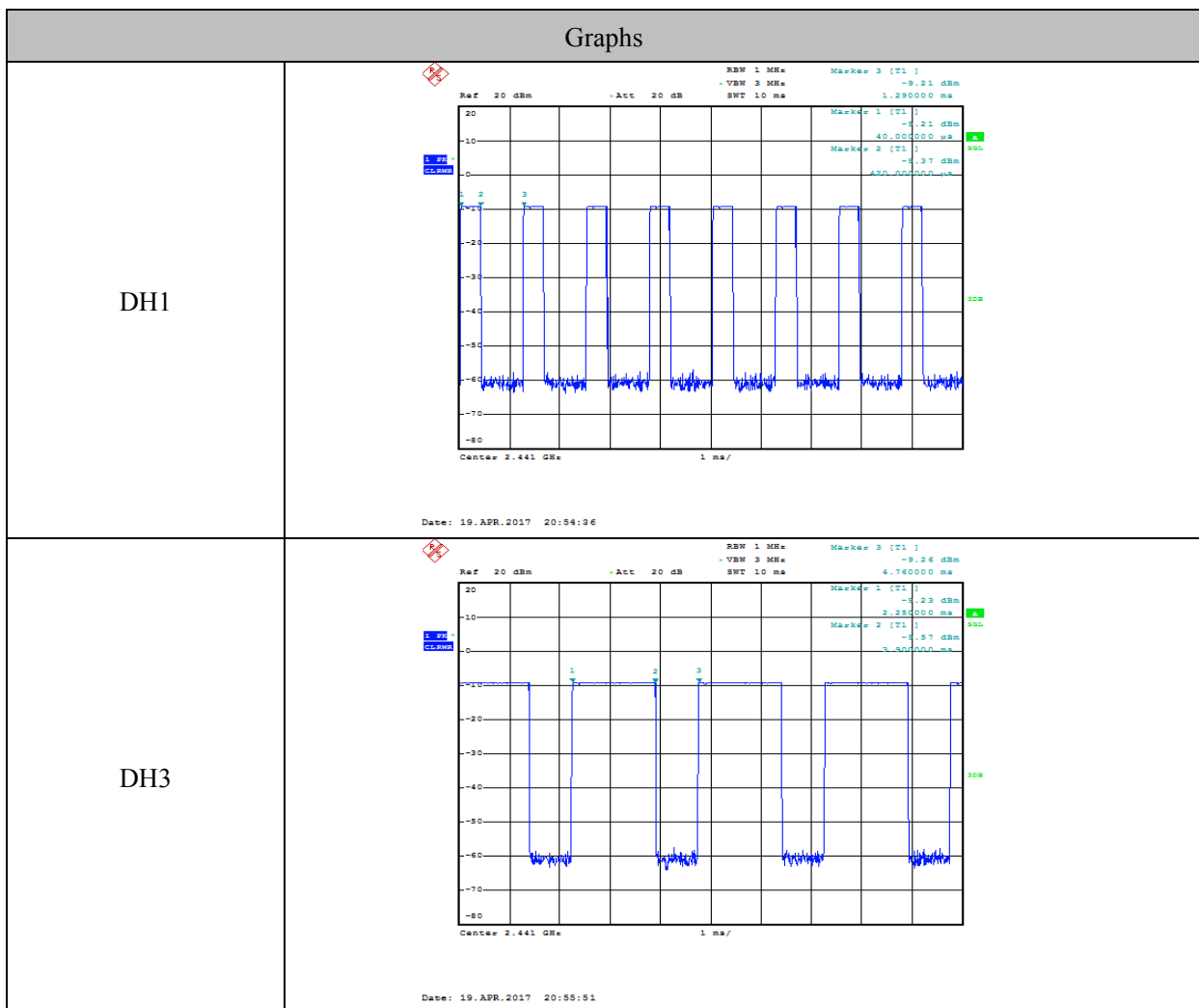

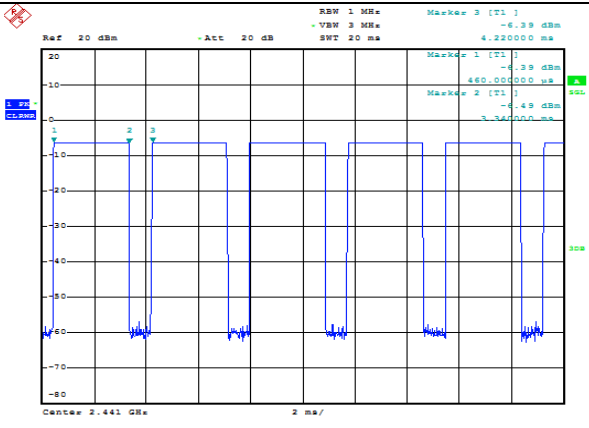
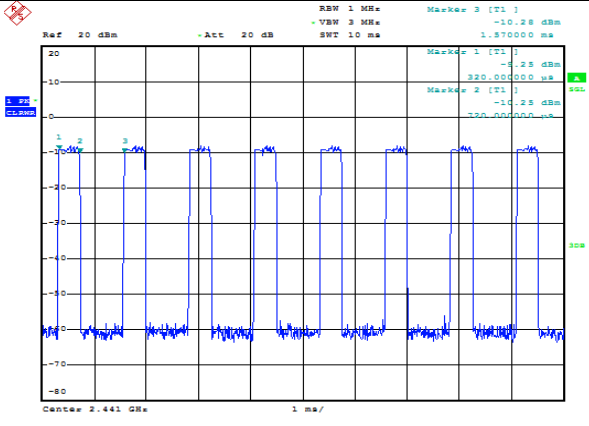
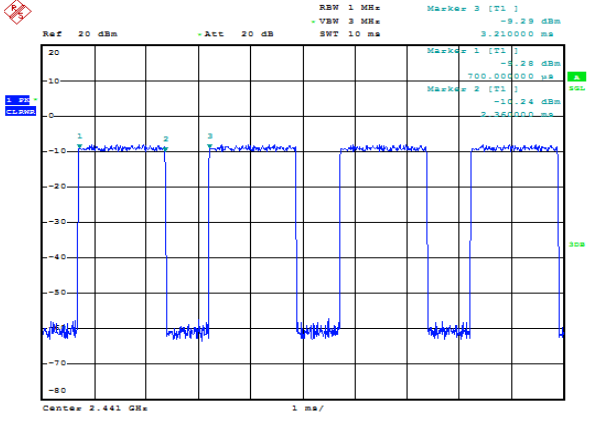
| | |
|-------------|--|
| <p>DH5</p> |  <p>Ref 20 dBm -Att 20 dB RBW 1 MHz VBW 3 MHz SWT 20 ms</p> <p>Marker 1 [T1] -4.39 dBm Marker 2 [T1] -6.49 dBm Marker 3 [T1] -8.39 dBm</p> <p>Center 2.441 GHz 2 ms/</p> <p>Date: 19.APR.2017 20:49:18</p> |
| <p>3DH1</p> |  <p>Ref 20 dBm -Att 20 dB RBW 1 MHz VBW 3 MHz SWT 10 ms</p> <p>Marker 1 [T1] -10.28 dBm Marker 2 [T1] -11.25 dBm Marker 3 [T1] -12.25 dBm</p> <p>Center 2.441 GHz 1 ms/</p> <p>Date: 19.APR.2017 20:56:11</p> |
| <p>3DH3</p> |  <p>Ref 20 dBm -Att 20 dB RBW 1 MHz VBW 3 MHz SWT 10 ms</p> <p>Marker 1 [T1] -9.39 dBm Marker 2 [T1] -11.24 dBm Marker 3 [T1] -12.24 dBm</p> <p>Center 2.441 GHz 1 ms/</p> <p>Date: 19.APR.2017 20:56:30</p> |

3DH5

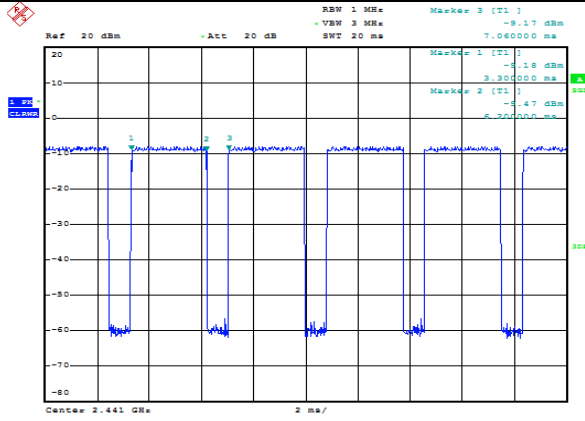

Date: 19.APR.2017 20:52:41

9. Radiated emission

9.1. Block diagram of test setup

In 3m Anechoic Chamber Test Setup Diagram for 9KHz-30MHz

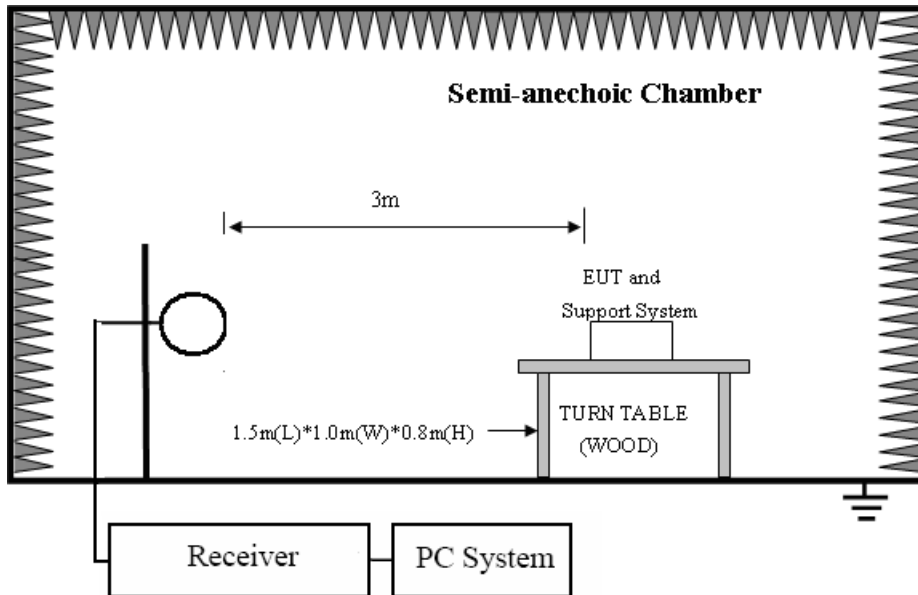

In 3m Anechoic Chamber Test Setup Diagram for below 1GHz

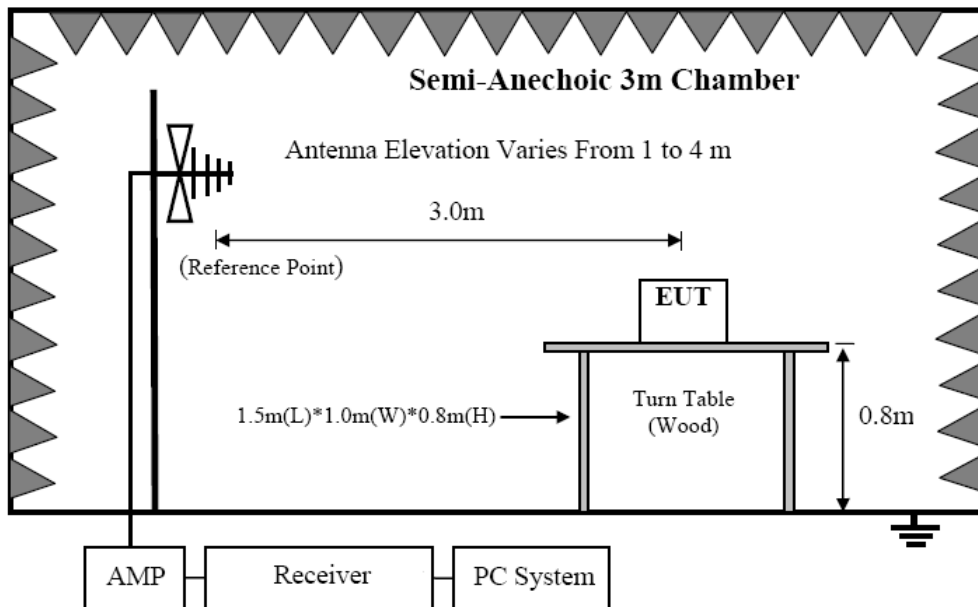

In 3m Anechoic Chamber Test Setup Diagram for frequency above 1GHz

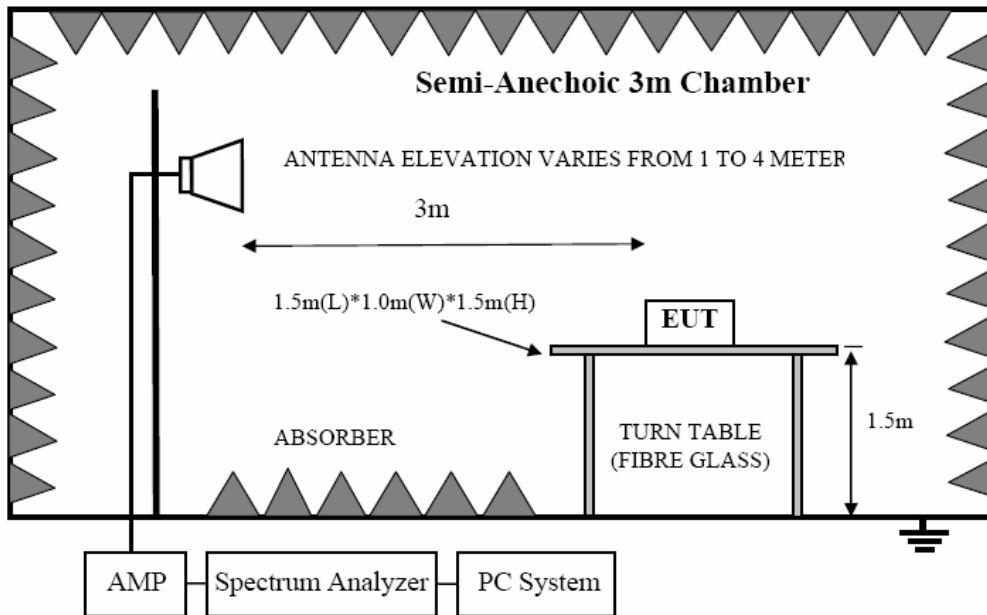

Note: For harmonic emissions test a appropriate high pass filter was inserted in the input port of AMP.

9.2. Limit

9.2.1 FCC 15.205 Restricted frequency band

| MHz | MHz | MHz | GHz |
|----------------------------|-----------------------|-----------------|------------------|
| 0.090 - 0.110 | 16.42 - 16.423 | 399.9 - 410 | 4.5 - 5.15 |
| ¹ 0.495 - 0.505 | 16.69475 - 16.69525 | 608 - 614 | 5.35 - 5.46 |
| 2.1735 - 2.1905 | 16.80425 - 16.80475 | 960 - 1240 | 7.25 - 7.75 |
| 4.125 - 4.128 | 25.5 - 25.67 | 1300 - 1427 | 8.025 - 8.5 |
| 4.17725 - 4.17775 | 37.5 - 38.25 | 1435 - 1626.5 | 9.0 - 9.2 |
| 4.20725 - 4.20775 | 73 - 74.6 | 1645.5 - 1646.5 | 9.3 - 9.5 |
| 6.215 - 6.218 | 74.8 - 75.2 | 1660 - 1710 | 10.6 - 12.7 |
| 6.26775 - 6.26825 | 108 - 121.94 | 1718.8 - 1722.2 | 13.25 - 13.4 |
| 6.31175 - 6.31225 | 123 - 138 | 2200 - 2300 | 14.47 - 14.5 |
| 8.291 - 8.294 | 149.9 - 150.05 | 2310 - 2390 | 15.35 - 16.2 |
| 8.362 - 8.366 | 156.52475 - 156.52525 | 2483.5 - 2500 | 17.7 - 21.4 |
| 8.37625 - 8.38675 | 156.7 - 156.9 | 2690 - 2900 | 22.01 - 23.12 |
| 8.41425 - 8.41475 | 162.0125 - 167.17 | 3260 - 3267 | 23.6 - 24.0 |
| 12.29 - 12.293 | 167.72 - 173.2 | 3332 - 3339 | 31.2 - 31.8 |
| 12.51975 - 12.52025 | 240 - 285 | 3345.8 - 3358 | 36.43 - 36.5 |
| 12.57675 - 12.57725 | 322 - 335.4 | 3600 - 4400 | (²) |

9.2.2 FCC 15.209 Limit.

| FREQUENCY MHz | DISTANCE Meters | FIELD STRENGTHS LIMIT | |
|------------------|--------------------|-----------------------|---------------|
| | | μV/m | dB(μV)/m |
| 0.009 ~ 0.490 | 300 | 2400/F(KHz) | 67.6-20log(F) |
| 0.490 ~ 1.705 | 30 | 24000/F(KHz) | 87.6-20log(F) |
| 1.705 ~ 30.0 | 30 | 30 | 29.54 |
| 30 ~ 88 | 3 | 100 | 40.0 |
| 88 ~ 216 | 3 | 150 | 43.5 |
| 216 ~ 960 | 3 | 200 | 46.0 |
| 960 ~ 1000 | 3 | 500 | 54.0 |

| | | |
|------------|---|---|
| Above 1000 | 3 | 74.0 dB(μ V)/m (Peak) 54.0 dB(μ V)/m (Average) |
|------------|---|---|

Note: (1) The emission limits shown in the above table are based on measurements employing a CISPR QP detector except for the frequency bands 9-90KHz, 110-490KHz and above 1000MHz. Radiated emissions limits in these three bands are based on measurements employing an average detector.

(2) At frequencies below 30MHz, measurement may be performed at a distance closer than that specified, and the limit at closer measurement distance can be extrapolated by below formula:

$$\text{Limit}_{3m}(\text{dBuV/m}) = \text{Limit}_{30m}(\text{dBuV/m}) + 40\text{Log}(30m/3m)$$

9.2.3 Limit for this EUT

All the emissions appearing within 15.205 restricted frequency bands shall not exceed the limits shown in 15.209, all the other emissions shall be at least 20dB below the fundamental emissions, or comply with 15.209 limits.

9.3. Test Procedure

- (1) EUT was placed on a non-metallic table, 150 cm above the ground plane inside a semi-anechoic chamber.
- (2) Test antenna was located 3m from the EUT on an adjustable mast, and the antenna used as below table.

| Test frequency range | Test antenna used |
|----------------------|--|
| 9KHz-30MHz | Active Loop antenna |
| 30MHz-1GHz | Trilog Broadband Antenna |
| 1GHz-18GHz | Double Ridged Horn Antenna(1GHz-18GHz) |
| 18GHz-40GHz | Horn Antenna(18GHz-40GHz) |

According ANSI C63.10:2013 clause 6.4.4.2 and 6.5.3, for measurements below 30 MHz, the loop antenna was positioned with its plane vertical from the EUT and rotated about its vertical axis for maximum response at each azimuth position around the EUT. And the loop antenna also be positioned with its plane horizontal at the specified distance from the EUT. The center of the loop is 1 m above the ground. for measurement above 30MHz, the Trilog Broadband Antenna or Horn Antenna was located 3m from EUT, Measurements were made with the antenna positioned in both the horizontal and vertical planes of Polarization, and the measurement antenna was varied from 1 m to 4 m. in height above the reference ground plane to obtain the maximum signal strength.

(3) Below pre-scan procedure was first performed in order to find prominent frequency spectrum radiated emissions from 9KHz to 25GHz:

- (a) Scanning the peak frequency spectrum with the antenna specified in step (3), and the EUT was rotated 360 degree, the antenna height was varied from 1m to 4m(Except loop antenna, it's fixed 1m above ground.)
- (b) Change work frequency or channel of device if practicable.
- (c) Change modulation type of device if practicable.
- (d) Change power supply range from 85% to 115% of the rated supply voltage
- (e) Rotated EUT though three orthogonal axes to determine the attitude of EUT arrangement produces

highest emissions.

Spectrum frequency from 9KHz to 25GHz (tenth harmonic of fundamental frequency) was investigated, and no any obvious emission were detected from 18GHz to 25GHz, so below final test was performed with frequency range from 9KHz to 18GHz.

- (4) For final emissions measurements at each frequency of interest, the EUT was rotated and the antenna height was varied between 1m and 4m in order to maximize the emission. Measurements in both horizontal and vertical polarities were made and the data was recorded. In order to find the maximum emission, the relative positions of equipments and all of the interface cables were changed according to ANSI C63.10 2013 on Radiated Emission test.
- (5) The emissions from 9KHz to 1GHz were measured based on CISPR QP detector except for the frequency bands 9-90KHz, 110-490KHz, for emissions from 9KHz-90KHz,110KHz-490KHz and above 1GHz were measured based on average detector, for emissions above 1GHz, peak emissions also be measured and need comply with Peak limit.
- (6) The emissions from 9KHz to 1GHz, QP or average values were measured with EMI receiver with below RBW.

| Frequency band | RBW |
|----------------|--------|
| 9KHz-150KHz | 200Hz |
| 150KHz-30MHz | 9KHz |
| 30MHz-1GHz | 120KHz |

- (7) For emissions above 1GHz, both Peak and Average level were measured with Spectrum Analyzer, and the RBW is set at 1MHz, VBW is set at 3MHz for Peak measure; RMS detector RBW 1MHz VBW 3MHz for Average measure(according ANSI C63.10:2013 clause 4.2.3.2.3 procedure for average measure).
- (8) X axis, Y axis, Z axis are tested, and worse setup X axis is reported.

9.4. Test result

PASS. (See below detailed test result)

All the emissions except fundamental emission from 9 KHz to 25GHz were comply with 15.209 limits.

Note1: According exploratory test no any obvious emission were detected from 9KHz to 30MHz and 18GHz to 25GHz, so the final test was performed with frequency range from 30MHz to 18GHz and recorded in below.

Note2: For emissions below 1GHz, according exploratory explorer test, when change Tx mode and channel, have no distinct influence on emissions level, so for emissions below 1GHz, the final test was only performed with EUT working in GFSK, Tx 2441MHz mode.

Note3: For emissions above 1GHz. If peak results comply with AV limit, AV Result is deemed to comply with AV limit.

Radiated Emission test (below 1GHz)

TR-4-E-009 Radiated Emission Test Result

| | | |
|---------------------|---|--|
| Test Site | : DDT 3m Chamber 2# | E:\2017 RE2# Report Data\17Q0412-1\RE.EM6 |
| Test Date | : 2017-04-19 | Tested By : Xuemin |
| EUT | : The Hampton Bluetooth Turntable | Model Number : VM-130 |
| Power Supply | : AC 120V/60Hz | Test Mode : Tx mode |
| Condition | : Temp:24.5°C,Humi:55%, Press:100.1kPa | Antenna/Distance : 2016 VULB9163 2#/3m/HORIZONTAL |
| Memo | : | |

Data: 7

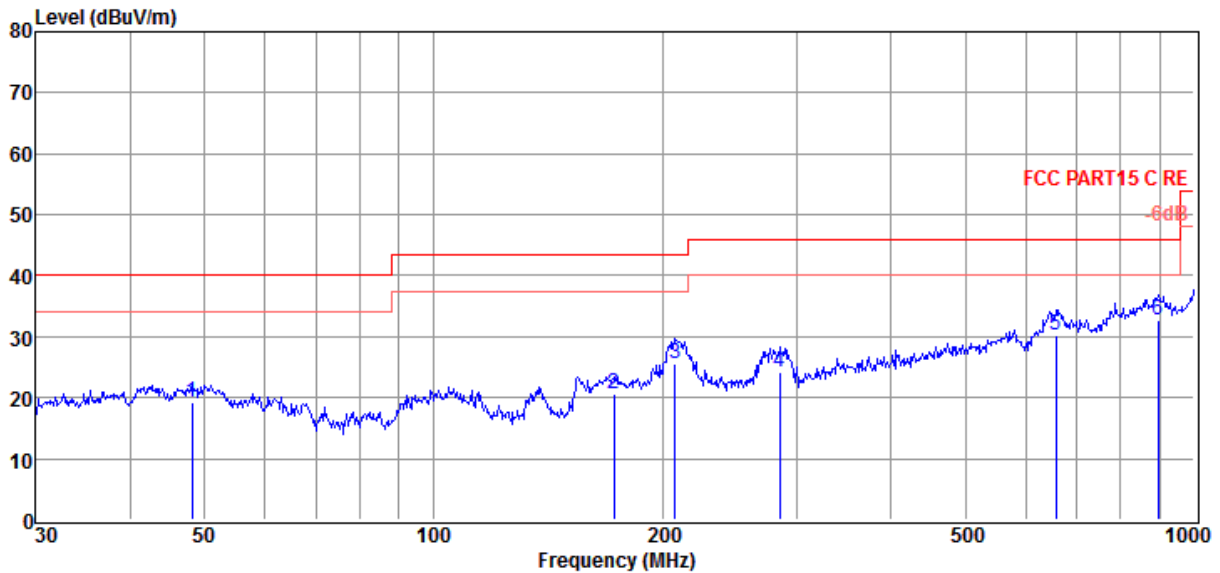

| Item (Mark) | Freq. (MHz) | Read Level (dBμV) | Antenna Factor (dB/m) | Cable Loss (dB) | Result Level (dBμV/m) | Limit Line (dBμV/m) | Over Limit (dB) | Detector | Polarization |
|-------------|-------------|-------------------|-----------------------|-----------------|-----------------------|---------------------|-----------------|----------|--------------|
| 1 | 48.16 | 2.22 | 13.29 | 3.87 | 19.38 | 40.00 | -20.62 | QP | HORIZONTAL |
| 2 | 172.60 | 7.29 | 8.46 | 4.74 | 20.49 | 43.50 | -23.01 | QP | HORIZONTAL |
| 3 | 207.85 | 10.03 | 10.63 | 4.94 | 25.60 | 43.50 | -17.90 | QP | HORIZONTAL |
| 4 | 284.98 | 5.97 | 12.91 | 5.31 | 24.19 | 46.00 | -21.81 | QP | HORIZONTAL |
| 5 | 658.84 | 2.15 | 21.48 | 6.70 | 30.33 | 46.00 | -15.67 | QP | HORIZONTAL |
| 6 | 897.00 | 2.52 | 22.89 | 7.41 | 32.82 | 46.00 | -13.18 | QP | HORIZONTAL |

- Note: 1. Result Level = Read Level + Antenna Factor + Cable loss.
 2. If Peak Result complies with QP limit, QP Result is deemed to comply with QP limit.
 3. Test setup: RBW: 120 kHz, VBW: 300 kHz, Sweep time: auto.

TR-4-E-009 Radiated Emission Test Result

| | | |
|---------------------|---|--|
| Test Site | : DDT 3m Chamber 2# | E:\2017 RE2# Report Data\17Q0412-1\RE.EM6 |
| Test Date | : 2017-04-19 | Tested By : Xuemin |
| EUT | : The Hampton Bluetooth Turntable | Model Number : VM-130 |
| Power Supply | : AC 120V/60Hz | Test Mode : Tx mode |
| Condition | : Temp:24.5°C,Humi:55%, Press:100.1kPa | Antenna/Distance : 2016 VULB9163 2#/3m/VERTICAL |
| Memo | : | |

Data: 8

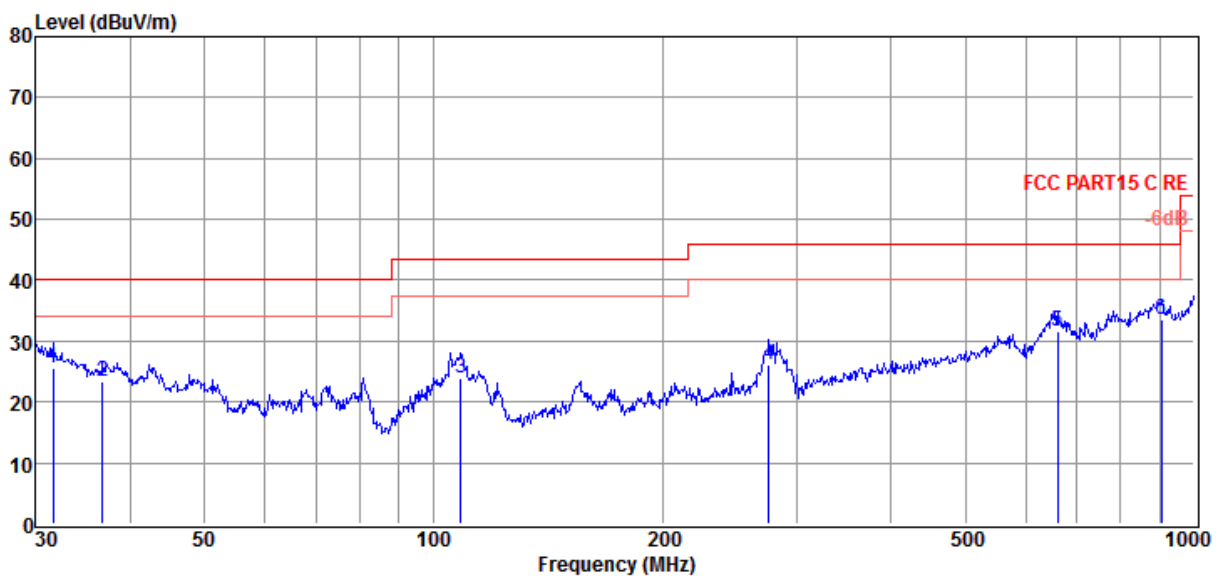

| Item (Mark) | Freq. (MHz) | Read Level (dBμV) | Antenna Factor (dB/m) | Cable Loss dB | Result Level (dBμV/m) | Limit Line (dBμV/m) | Over Limit (dB) | Detector | Polarization |
|----------------|----------------|-------------------------|-----------------------------|---------------------|-----------------------------|---------------------------|-----------------------|----------|--------------|
| 1 | 31.62 | 11.82 | 10.11 | 3.69 | 25.62 | 40.00 | -14.38 | QP | VERTICAL |
| 2 | 36.77 | 8.26 | 11.39 | 3.75 | 23.40 | 40.00 | -16.60 | QP | VERTICAL |
| 3 | 108.65 | 9.34 | 10.31 | 4.35 | 24.00 | 43.50 | -19.50 | QP | VERTICAL |
| 4 | 276.12 | 8.18 | 12.67 | 5.26 | 26.11 | 46.00 | -19.89 | QP | VERTICAL |
| 5 | 661.15 | 3.65 | 21.38 | 6.71 | 31.74 | 46.00 | -14.26 | QP | VERTICAL |
| 6 | 906.48 | 3.33 | 22.73 | 7.44 | 33.50 | 46.00 | -12.50 | QP | VERTICAL |

- Note: 1. Result Level = Read Level + Antenna Factor + Cable loss.
 2. If Peak Result complies with QP limit, QP Result is deemed to comply with QP limit.
 3. Test setup: RBW: 120 kHz, VBW: 300 kHz, Sweep time: auto.

Radiated Emission test (above 1GHz)

| Freq (MHz) | Read level (dB μ V) | Antenna Factor (dB/m) | PRM Factor (dB) | Cable Loss (dB) | Result Level (dB μ V/m) | Limit (dB μ V/m) | Margin (dB) | Detector type | Polarization |
|----------------------|-------------------------|-----------------------|-----------------|-----------------|-----------------------------|----------------------|-------------|---------------|--------------|
| GFSK Tx mode 2402MHz | | | | | | | | | |
| 3562.00 | 38.33 | 32.10 | 29.40 | 7.34 | 48.37 | 74.00 | -25.63 | Peak | VERTICAL |
| 4073.00 | 37.74 | 33.46 | 29.05 | 7.69 | 49.84 | 74.00 | -24.16 | Peak | VERTICAL |
| 4808.00 | 40.20 | 33.74 | 29.32 | 8.48 | 53.10 | 74.00 | -20.90 | Peak | VERTICAL |
| 4808.00 | 40.20 | 33.74 | 29.32 | 8.48 | 53.10 | 74.00 | -20.90 | Peak | VERTICAL |
| 5452.00 | 36.12 | 34.61 | 29.28 | 9.14 | 50.59 | 74.00 | -23.41 | Peak | VERTICAL |
| 6768.00 | 36.87 | 36.02 | 30.22 | 10.21 | 52.88 | 74.00 | -21.12 | Peak | VERTICAL |
| 3268.00 | 39.36 | 31.81 | 29.98 | 7.05 | 48.24 | 74.00 | -25.76 | Peak | HORIZONTAL |
| 3842.00 | 38.29 | 32.95 | 29.13 | 7.51 | 49.62 | 74.00 | -24.38 | Peak | HORIZONTAL |
| 4731.00 | 37.88 | 33.75 | 29.30 | 8.41 | 50.74 | 74.00 | -23.26 | Peak | HORIZONTAL |
| 4808.00 | 39.35 | 33.74 | 29.32 | 8.48 | 52.25 | 74.00 | -21.75 | Peak | HORIZONTAL |
| 6033.00 | 36.39 | 35.05 | 29.22 | 9.70 | 51.92 | 74.00 | -22.08 | Peak | HORIZONTAL |
| 7097.00 | 36.73 | 36.28 | 30.43 | 10.51 | 53.09 | 74.00 | -20.91 | Peak | HORIZONTAL |
| GFSK Tx mode 2441MHz | | | | | | | | | |
| 2568.00 | 41.92 | 30.42 | 29.87 | 6.24 | 48.71 | 74.00 | -25.29 | Peak | VERTICAL |
| 3555.00 | 38.20 | 32.08 | 29.41 | 7.33 | 48.20 | 74.00 | -25.80 | Peak | VERTICAL |
| 3926.00 | 38.07 | 33.19 | 29.08 | 7.57 | 49.75 | 74.00 | -24.25 | Peak | VERTICAL |
| 4885.00 | 40.13 | 33.72 | 29.33 | 8.56 | 53.08 | 74.00 | -20.92 | Peak | VERTICAL |
| 5697.00 | 36.36 | 34.82 | 29.22 | 9.38 | 51.34 | 74.00 | -22.66 | Peak | VERTICAL |
| 6747.00 | 37.06 | 36.00 | 30.20 | 10.19 | 53.05 | 74.00 | -20.95 | Peak | VERTICAL |
| 3198.00 | 39.55 | 31.78 | 30.05 | 6.98 | 48.26 | 74.00 | -25.74 | Peak | HORIZONTAL |
| 3912.00 | 37.98 | 33.15 | 29.09 | 7.55 | 49.59 | 74.00 | -24.41 | Peak | HORIZONTAL |
| 4416.00 | 37.82 | 33.74 | 29.16 | 8.06 | 50.46 | 74.00 | -23.54 | Peak | HORIZONTAL |
| 4885.00 | 40.33 | 33.72 | 29.33 | 8.56 | 53.28 | 74.00 | -20.72 | Peak | HORIZONTAL |
| 5774.00 | 36.48 | 34.87 | 29.21 | 9.47 | 51.61 | 74.00 | -22.39 | Peak | HORIZONTAL |
| 6516.00 | 36.94 | 35.81 | 29.87 | 9.96 | 52.84 | 74.00 | -21.16 | Peak | HORIZONTAL |
| GFSK Tx mode 2480MHz | | | | | | | | | |
| 3541.00 | 38.30 | 32.03 | 29.45 | 7.32 | 48.20 | 74.00 | -25.80 | Peak | VERTICAL |
| 4346.00 | 37.64 | 33.68 | 29.13 | 7.98 | 50.17 | 74.00 | -23.83 | Peak | VERTICAL |
| 4962.00 | 39.25 | 33.71 | 29.34 | 8.63 | 52.25 | 74.00 | -21.75 | Peak | VERTICAL |
| 5711.00 | 35.94 | 34.83 | 29.22 | 9.39 | 50.94 | 74.00 | -23.06 | Peak | VERTICAL |
| 6271.00 | 36.18 | 35.44 | 29.44 | 9.82 | 52.00 | 74.00 | -22.00 | Peak | VERTICAL |
| 6747.00 | 36.44 | 36.00 | 30.20 | 10.19 | 52.43 | 74.00 | -21.57 | Peak | VERTICAL |
| 3380.00 | 39.49 | 31.85 | 29.83 | 7.17 | 48.68 | 74.00 | -25.32 | Peak | HORIZONTAL |
| 4010.00 | 37.75 | 33.41 | 29.04 | 7.61 | 49.73 | 74.00 | -24.27 | Peak | HORIZONTAL |
| 4332.00 | 37.85 | 33.67 | 29.12 | 7.96 | 50.36 | 74.00 | -23.64 | Peak | HORIZONTAL |
| 5424.00 | 36.73 | 34.55 | 29.28 | 9.11 | 51.11 | 74.00 | -22.89 | Peak | HORIZONTAL |
| 6033.00 | 36.19 | 35.05 | 29.22 | 9.70 | 51.72 | 74.00 | -22.28 | Peak | HORIZONTAL |
| 6684.00 | 36.87 | 35.95 | 30.12 | 10.12 | 52.82 | 74.00 | -21.18 | Peak | HORIZONTAL |
| Result: Pass | | | | | | | | | |

Note: 1.30MHz~18GHz: (Scan with GFSK, $\pi/4$ QPSK, 8-DPSK, the worst case is GFSK Mode)

2. Result Level = Read Level + Antenna Factor + Cable loss - PRM Factor.

10. Band Edge Compliance (radiated method)

10.1. Block diagram of test setup

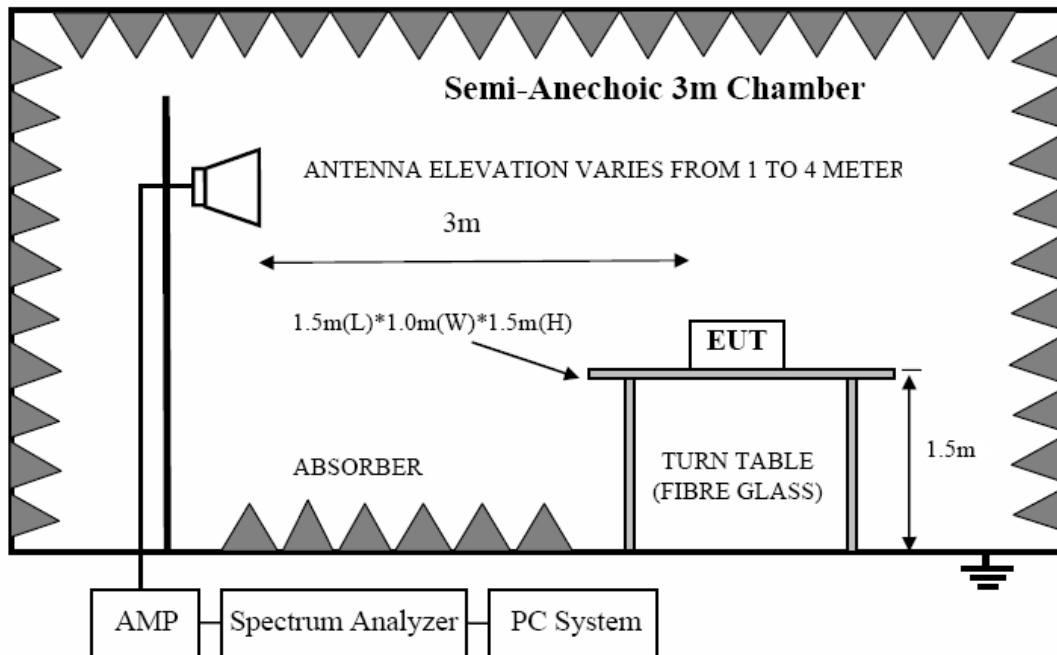

10.2. Limit

All restriction band should comply with 15.209, other emission should be at least 20dB below the fundamental.

10.3. Test Procedure

Same with clause 9.3 except change investigated frequency range from 2310MHz to 2415MHz and 2475MHz to 2500MHz.

Remark: All restriction band have been tested, and only the worse case is shown in report.

10.4. Test result

PASS. (See below detailed test result)

Remark: hopping on and hopping off mode all have been test, hopping off mode is worse and reported only.

TR-4-E-009 Radiated Emission Test Result

Test Site : DDT 3m Chamber 1# D:\2017 RE1# Report Data\17Q0412-1\RF.EM6
Test Date : 2017-04-19 **Tested By** : Aaron
EUT : The Hampton Bluetooth Turntable **Model Number** : VM-130
Power Supply : AC 120V/60Hz **Test Mode** : Tx mode GFSK CH0
Condition : Temp:24.5°C,Humi:55%,
 Press:100.1kPa **Antenna/Distance** : 2016 HF907/3m/HORIZONTAL
Memo :

Data: 15

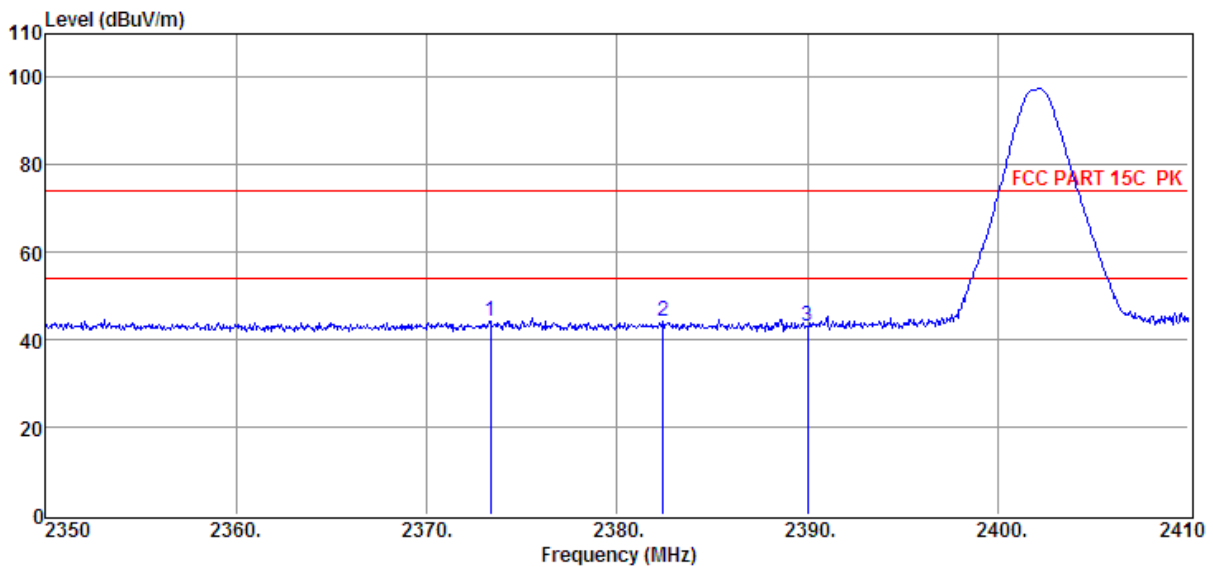

| Item (Mark) | Freq. (MHz) | Read Level (dBμV) | Antenna Factor (dB/m) | PRM Factor (dB) | Cable Loss (dB) | Result Level (dBμV/m) | Limit Line (dBμV/m) | Over Limit (dB) | Detector | Polarization |
|-------------|-------------|-------------------|-----------------------|-----------------|-----------------|-----------------------|---------------------|-----------------|----------|--------------|
| 1 | 2373.34 | 38.04 | 29.71 | 29.38 | 5.98 | 44.35 | 74.00 | -29.65 | Peak | HORIZONTAL |
| 2 | 2382.40 | 37.76 | 29.75 | 29.39 | 6.01 | 44.13 | 74.00 | -29.87 | Peak | HORIZONTAL |
| 3 | 2390.00 | 36.86 | 29.78 | 29.41 | 6.01 | 43.24 | 74.00 | -30.76 | Peak | HORIZONTAL |

Note: 1. Result Level = Read Level + Antenna Factor + Cable loss - PRM Factor.
 2. If Peak Result complies with AV limit, AV Result is deemed to comply with AV limit.
 3. Test setup: RBW: 1 MHz, VBW: 3 MHz, Sweep time: auto.

TR-4-E-009 Radiated Emission Test Result

Test Site : DDT 3m Chamber 1# **D:\2017 RE1# Report Data\17Q0412-1\RF.EM6**
Test Date : 2017-04-19 **Tested By** : Aaron
EUT : The Hampton Bluetooth Turntable **Model Number** : VM-130
Power Supply : AC 120V/60Hz **Test Mode** : Tx mode GFSK CH0
Condition : Temp:24.5°C,Humi:55%,
 Press:100.1kPa **Antenna/Distance** : 2016 HF907/3m/VERTICAL
Memo :

Data: 16

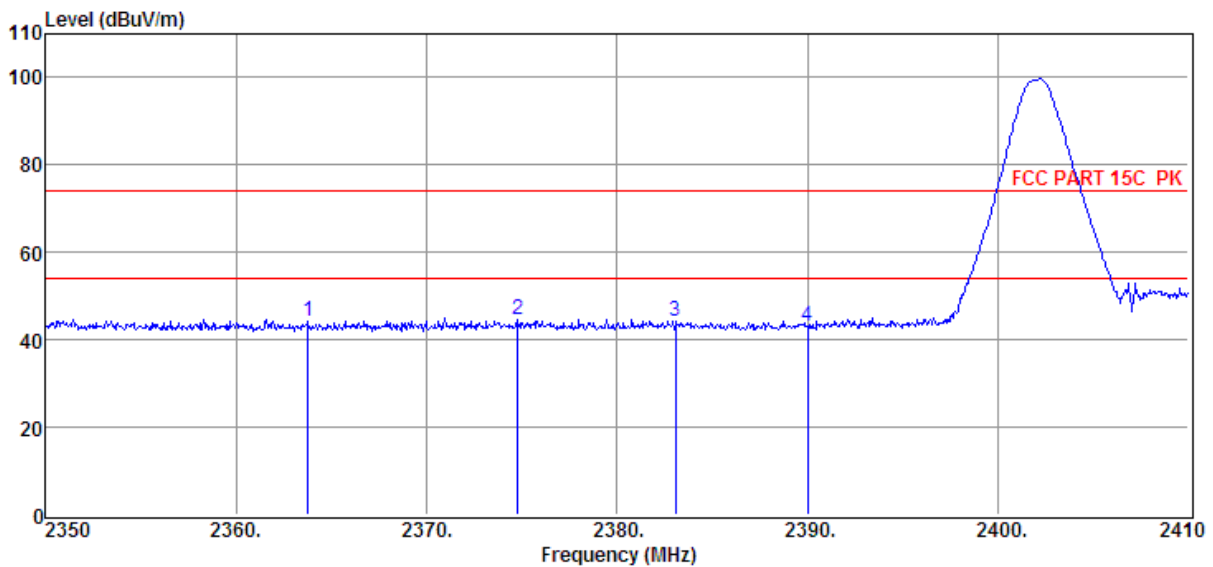

| Item (Mark) | Freq. (MHz) | Read Level (dBμV) | Antenna Factor (dB/m) | PRM Factor (dB) | Cable Loss (dB) | Result Level (dBμV/m) | Limit Line (dBμV/m) | Over Limit (dB) | Detector | Polarization |
|-------------|-------------|-------------------|-----------------------|-----------------|-----------------|-----------------------|---------------------|-----------------|----------|--------------|
| 1 | 2363.80 | 38.02 | 29.67 | 29.37 | 5.98 | 44.30 | 74.00 | -29.70 | Peak | VERTICAL |
| 2 | 2374.78 | 38.16 | 29.72 | 29.38 | 5.98 | 44.48 | 74.00 | -29.52 | Peak | VERTICAL |
| 3 | 2383.06 | 37.80 | 29.75 | 29.39 | 6.01 | 44.17 | 74.00 | -29.83 | Peak | VERTICAL |
| 4 | 2390.00 | 36.60 | 29.78 | 29.41 | 6.01 | 42.98 | 74.00 | -31.02 | Peak | VERTICAL |

- Note: 1. Result Level = Read Level + Antenna Factor + Cable loss - PRM Factor.
 2. If Peak Result complies with AV limit, AV Result is deemed to comply with AV limit.
 3. Test setup: RBW: 1 MHz, VBW: 3 MHz, Sweep time: auto.

TR-4-E-009 Radiated Emission Test Result

Test Site : DDT 3m Chamber 1# **D:\2017 RE1# Report Data\17Q0412-1\RF.EM6**
Test Date : 2017-04-19 **Tested By** : Aaron
EUT : The Hampton Bluetooth Turntable **Model Number** : VM-130
Power Supply : AC 120V/60Hz **Test Mode** : Tx mode GFSK CH78
Condition : Temp:24.5°C,Humi:55%,
 Press:100.1kPa **Antenna/Distance** : 2016 HF907/3m/VERTICAL
Memo :

Data: 9

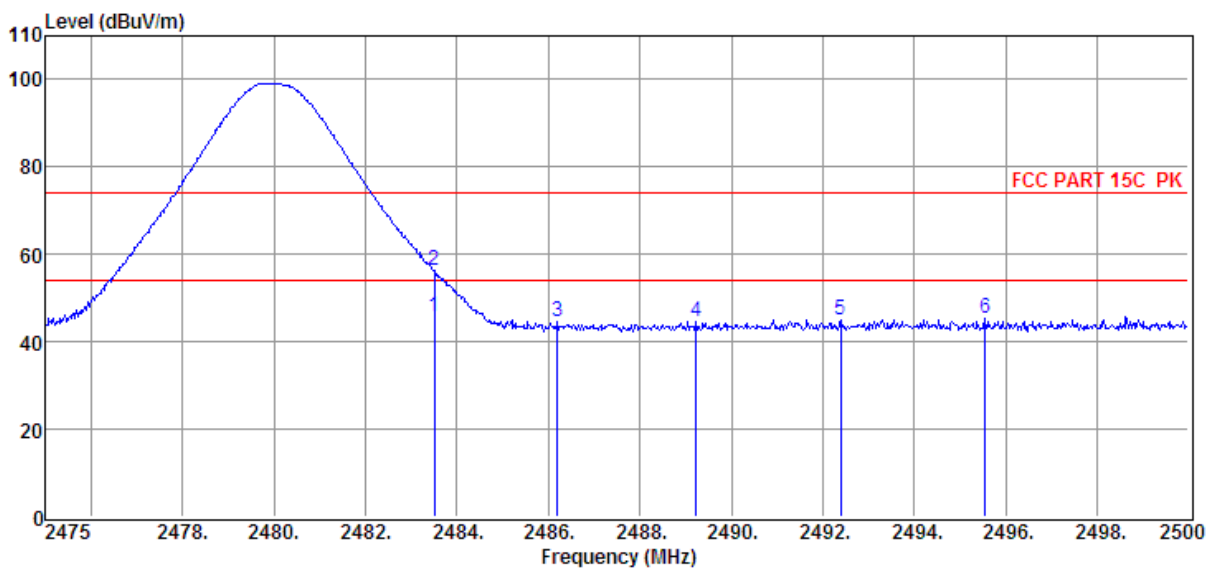

| Item (Mark) | Freq. (MHz) | Read Level (dB μ V) | Antenna Factor (dB/m) | PRM Factor dB | Cable Loss dB | Result Level (dB μ V/m) | Limit Line (dB μ V/m) | Over Limit (dB) | Detector | Polarization |
|----------------|----------------|-------------------------------|-----------------------------|---------------------|---------------------|-----------------------------------|---------------------------------|-----------------------|----------|--------------|
| 1 | 2483.50 | 38.99 | 30.14 | 29.71 | 6.15 | 45.57 | 54.00 | -8.43 | Average | VERTICAL |
| 2 | 2483.50 | 49.68 | 30.14 | 29.71 | 6.15 | 56.26 | 74.00 | -17.74 | Peak | VERTICAL |
| 3 | 2486.20 | 38.00 | 30.15 | 29.71 | 6.15 | 44.59 | 74.00 | -29.41 | Peak | VERTICAL |
| 4 | 2489.23 | 38.16 | 30.16 | 29.73 | 6.15 | 44.74 | 74.00 | -29.26 | Peak | VERTICAL |
| 5 | 2492.40 | 38.55 | 30.17 | 29.73 | 6.15 | 45.14 | 74.00 | -28.86 | Peak | VERTICAL |
| 6 | 2495.55 | 38.70 | 30.18 | 29.73 | 6.15 | 45.30 | 74.00 | -28.70 | Peak | VERTICAL |

Note: 1. Result Level = Read Level + Antenna Factor + Cable loss - PRM Factor.

2. If Peak Result complies with AV limit, AV Result is deemed to comply with AV limit.

3. Test setup: RBW: 1 MHz, VBW: 3 MHz, Sweep time: auto.

TR-4-E-009 Radiated Emission Test Result

| | |
|--|--|
| Test Site : DDT 3m Chamber 1# | D:\2017 RE1# Report Data\17Q0412-1\RF.EM6 |
| Test Date : 2017-04-19 | Tested By : Aaron |
| EUT : The Hampton Bluetooth Turntable | Model Number : VM-130 |
| Power Supply : AC 120V/60Hz | Test Mode : Tx mode GFSK CH78 |
| Condition : Temp:24.5°C,Humi:55%, Press:100.1kPa | Antenna/Distance : 2016 HF907/3m/HORIZONTAL |
| Memo : | |

Data: 10

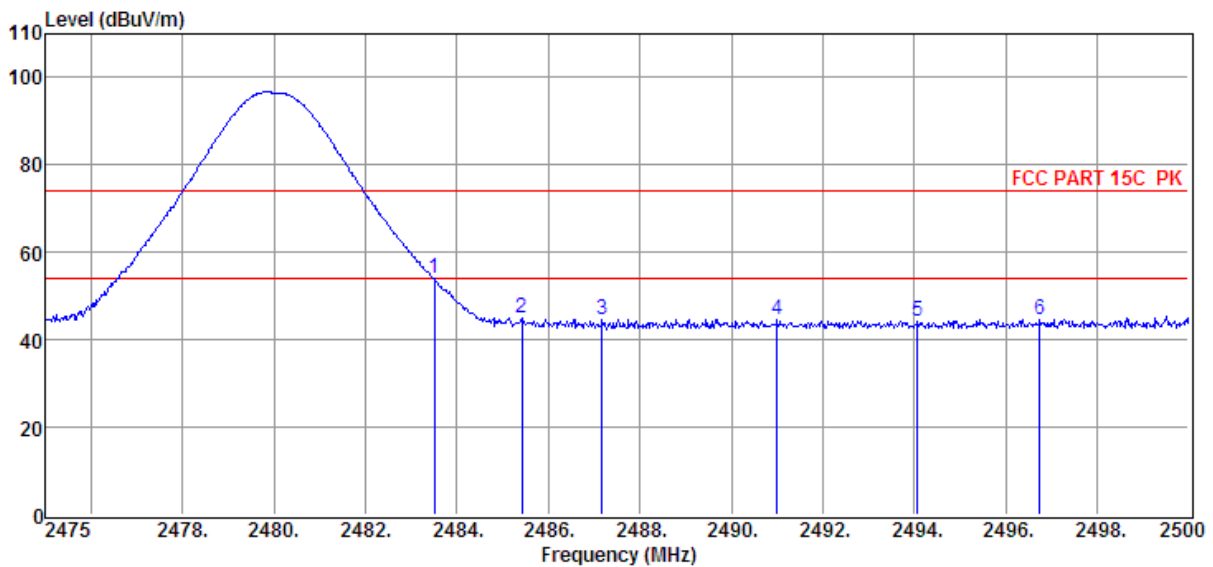

| Item (Mark) | Freq. (MHz) | Read Level (dBμV) | Antenna Factor (dB/m) | PRM Factor dB | Cable Loss dB | Result Level (dBμV/m) | Limit Line (dBμV/m) | Over Limit (dB) | Detector | Polarization |
|----------------|----------------|-------------------------|-----------------------------|---------------------|---------------------|-----------------------------|---------------------------|-----------------------|----------|--------------|
| 1 | 2483.50 | 47.39 | 30.14 | 29.71 | 6.15 | 53.97 | 74.00 | -20.03 | Peak | HORIZONTAL |
| 2 | 2485.43 | 38.33 | 30.14 | 29.71 | 6.15 | 44.91 | 74.00 | -29.09 | Peak | HORIZONTAL |
| 3 | 2487.18 | 38.04 | 30.15 | 29.71 | 6.15 | 44.63 | 74.00 | -29.37 | Peak | HORIZONTAL |
| 4 | 2491.00 | 37.90 | 30.17 | 29.73 | 6.15 | 44.49 | 74.00 | -29.51 | Peak | HORIZONTAL |
| 5 | 2494.08 | 37.58 | 30.18 | 29.73 | 6.15 | 44.18 | 74.00 | -29.82 | Peak | HORIZONTAL |
| 6 | 2496.75 | 38.13 | 30.19 | 29.75 | 6.15 | 44.72 | 74.00 | -29.28 | Peak | HORIZONTAL |

- Note: 1. Result Level = Read Level + Antenna Factor + Cable loss - PRM Factor.
 2. If Peak Result complies with AV limit, AV Result is deemed to comply with AV limit.
 3. Test setup: RBW: 1 MHz, VBW: 3 MHz, Sweep time: auto.

TR-4-E-009 Radiated Emission Test Result

| | | |
|---------------------|---|--|
| Test Site | : DDT 3m Chamber 1# | D:\2017 RE1# Report Data\17Q0412-1\RF.EM6 |
| Test Date | : 2017-04-19 | Tested By : Aaron |
| EUT | : The Hampton Bluetooth Turntable | Model Number : VM-130 |
| Power Supply | : AC 120V/60Hz | Test Mode : Tx mode 8-DPSK CH0 |
| Condition | : Temp:24.5°C,Humi:55%, Press:100.1kPa | Antenna/Distance : 2016 HF907/3m/VERTICAL |
| Memo | : | |

Data: 17

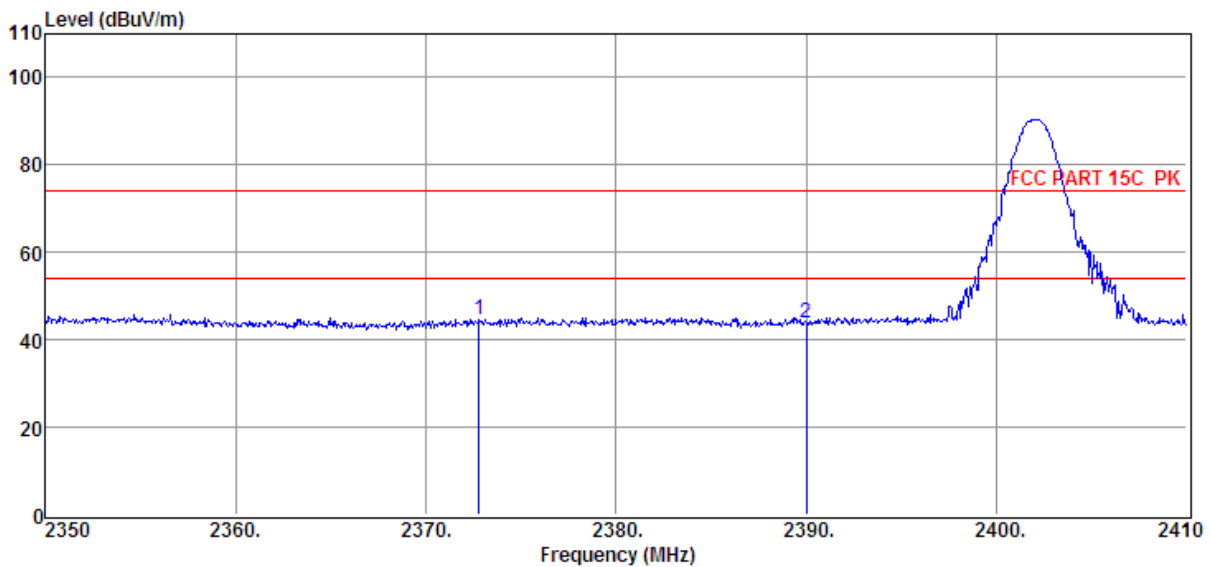

| Item (Mark) | Freq (MHz) | Read Level (dBμV) | Antenna Factor (dB/m) | PRM Factor dB | Cable Loss dB | Result Level (dBμV/m) | Limit Line (dBμV/m) | Over Limit (dB) | Detector | Polarization |
|----------------|---------------|-------------------------|-----------------------------|---------------------|---------------------|-----------------------------|---------------------------|-----------------------|----------|--------------|
| 1 | 2372.80 | 38.29 | 29.71 | 29.38 | 5.98 | 44.60 | 74.00 | -29.40 | Peak | VERTICAL |
| 2 | 2390.00 | 37.40 | 29.78 | 29.41 | 6.01 | 43.78 | 74.00 | -30.22 | Peak | VERTICAL |

Note: 1. Result Level = Read Level + Antenna Factor + Cable loss - PRM Factor.
 2. If Peak Result complies with AV limit, AV Result is deemed to comply with AV limit.
 3. Test setup: RBW: 1 MHz, VBW: 3 MHz, Sweep time: auto.

TR-4-E-009 Radiated Emission Test Result

| | | | |
|---------------------|---|-------------------------|----------------------------|
| Test Site | : DDT 3m Chamber 1# | Tested By | : Aaron |
| Test Date | : 2017-04-19 | Model Number | : VM-130 |
| EUT | : The Hampton Bluetooth Turntable | Test Mode | : Tx mode 8-DPSK CH0 |
| Power Supply | : AC 120V/60Hz | Antenna/Distance | : 2016 HF907/3m/HORIZONTAL |
| Condition | : Temp:24.5°C,Humi:55%, Press:100.1kPa | | |
| Memo | : | | |

Data: 18

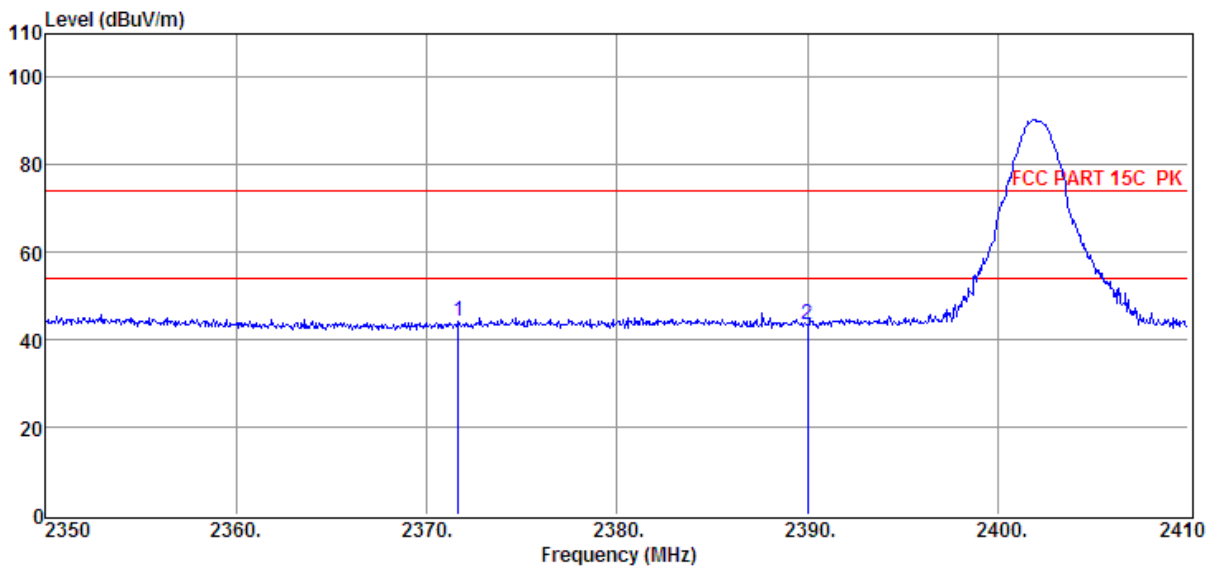

| Item (Mark) | Freq (MHz) | Read Level (dBμV) | Antenna Factor (dB/m) | PRM Factor dB | Cable Loss dB | Result Level (dBμV/m) | Limit Line (dBμV/m) | Over Limit (dB) | Detector | Polarization |
|----------------|---------------|-------------------------|-----------------------------|---------------------|---------------------|-----------------------------|---------------------------|-----------------------|----------|--------------|
| 1 | 2371.66 | 38.04 | 29.70 | 29.38 | 5.98 | 44.34 | 74.00 | -29.66 | Peak | HORIZONTAL |
| 2 | 2390.00 | 37.22 | 29.78 | 29.41 | 6.01 | 43.60 | 74.00 | -30.40 | Peak | HORIZONTAL |

Note: 1. Result Level = Read Level + Antenna Factor + Cable loss - PRM Factor.
 2. If Peak Result complies with AV limit, AV Result is deemed to comply with AV limit.
 3. Test setup: RBW: 1 MHz, VBW: 3 MHz, Sweep time: auto.

TR-4-E-009 Radiated Emission Test Result

| | | | |
|---------------------|---|-------------------------|----------------------------|
| Test Site | : DDT 3m Chamber 1# | Tested By | : Aaron |
| Test Date | : 2017-04-19 | Model Number | : VM-130 |
| EUT | : The Hampton Bluetooth Turntable | Test Mode | : Tx mode 8-DPSK CH78 |
| Power Supply | : AC 120V/60Hz | Antenna/Distance | : 2016 HF907/3m/HORIZONTAL |
| Condition | : Temp:24.5°C,Humi:55%, Press:100.1kPa | | |
| Memo | : | | |

Data: 19

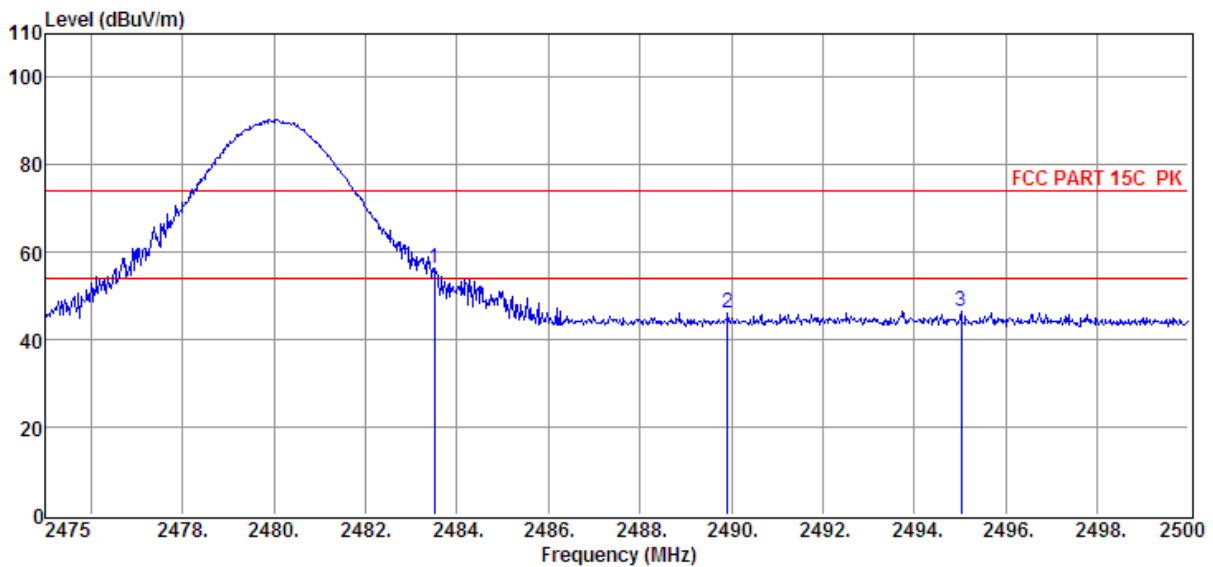

| Item (Mark) | Freq (MHz) | Read Level (dBμV) | Antenna Factor (dB/m) | PRM Factor dB | Cable Loss dB | Result Level (dBμV/m) | Limit Line (dBμV/m) | Over Limit (dB) | Detector | Polarization |
|----------------|---------------|-------------------------|-----------------------------|---------------------|---------------------|-----------------------------|---------------------------|-----------------------|----------|--------------|
| 1 | 2483.50 | 49.57 | 30.14 | 29.71 | 6.15 | 56.15 | 74.00 | -17.85 | Peak | HORIZONTAL |
| 2 | 2483.50 | 40.57 | 30.14 | 29.71 | 6.15 | 47.15 | 54.00 | -6.85 | AV | HORIZONTAL |
| 3 | 2495.03 | 40.07 | 30.18 | 29.73 | 6.15 | 46.67 | 74.00 | -27.33 | Peak | HORIZONTAL |

Note: 1. Result Level = Read Level + Antenna Factor + Cable loss - PRM Factor.
 2. If Peak Result complies with AV limit, AV Result is deemed to comply with AV limit.
 3. Test setup: RBW: 1 MHz, VBW: 3 MHz, Sweep time: auto.

TR-4-E-009 Radiated Emission Test Result

| | |
|--|--|
| Test Site : DDT 3m Chamber 1# | D:\2017 RE1# Report Data\17Q0412-1\RF.EM6 |
| Test Date : 2017-04-19 | Tested By : Aaron |
| EUT : The Hampton Bluetooth Turntable | Model Number : VM-130 |
| Power Supply : AC 120V/60Hz | Test Mode : Tx mode 8-DPSK CH78 |
| Condition : Temp:24.5°C,Humi:55%, Press:100.1kPa | Antenna/Distance : 2016 HF907/3m/VERTICAL |
| Memo : | |

Data: 20

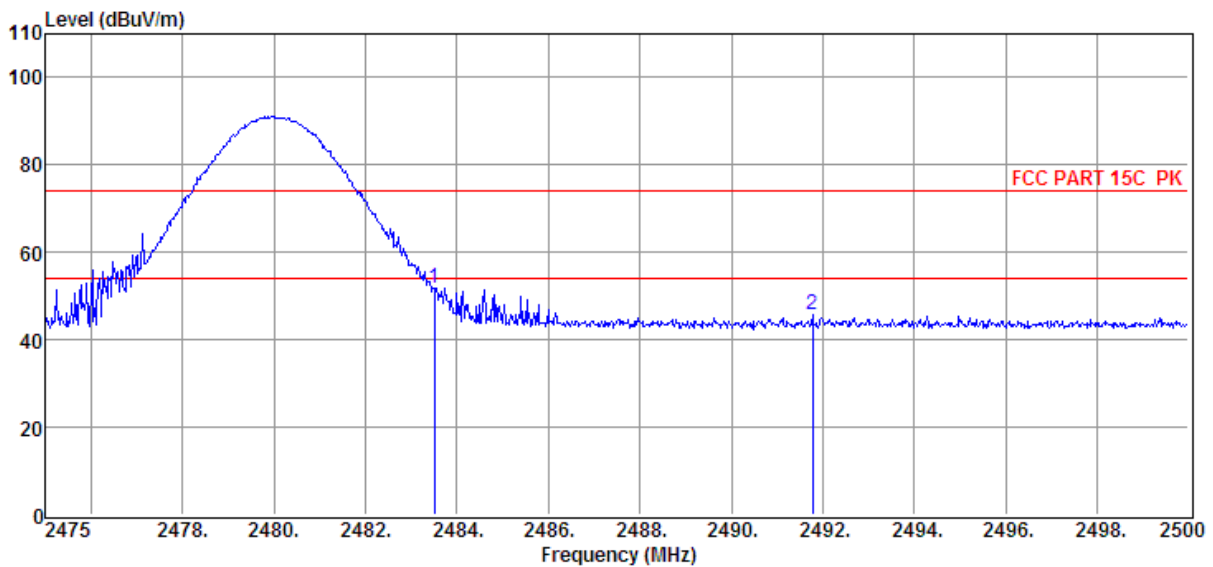

| Item (Mark) | Freq (MHz) | Read Level (dBμV) | Antenna Factor (dB/m) | PRM Factor dB | Cable Loss dB | Result Level (dBμV/m) | Limit Line (dBμV/m) | Over Limit (dB) | Detector | Polarization |
|----------------|---------------|-------------------------|-----------------------------|---------------------|---------------------|-----------------------------|---------------------------|-----------------------|----------|--------------|
| 1 | 2483.50 | 45.14 | 30.14 | 29.71 | 6.15 | 51.72 | 74.00 | -22.28 | Peak | VERTICAL |
| 2 | 2491.78 | 39.17 | 30.17 | 29.73 | 6.15 | 45.76 | 74.00 | -28.24 | Peak | VERTICAL |

Note: 1. Result Level = Read Level + Antenna Factor + Cable loss - PRM Factor.
 2. If Peak Result complies with AV limit, AV Result is deemed to comply with AV limit.
 3. Test setup: RBW: 1 MHz, VBW: 3 MHz, Sweep time: auto.

11. Band Edge Compliance (conducted method)

11.1. Block diagram of test setup

Same as section 4.1

11.2. Limit

All restriction band should comply with 15.209, other emission should be at least 20dB below the fundamental.

11.3. Test result

| Mode | Freq (MHz) | Conclusion |
|--------|------------------|------------|
| GFSK | Hopping off 2402 | PASS |
| | Hopping off 2480 | PASS |
| | Hopping on | PASS |
| 8-DPSK | Hopping off 2402 | PASS |
| | Hopping off 2480 | PASS |
| | Hopping on | PASS |

11.4. Original test data

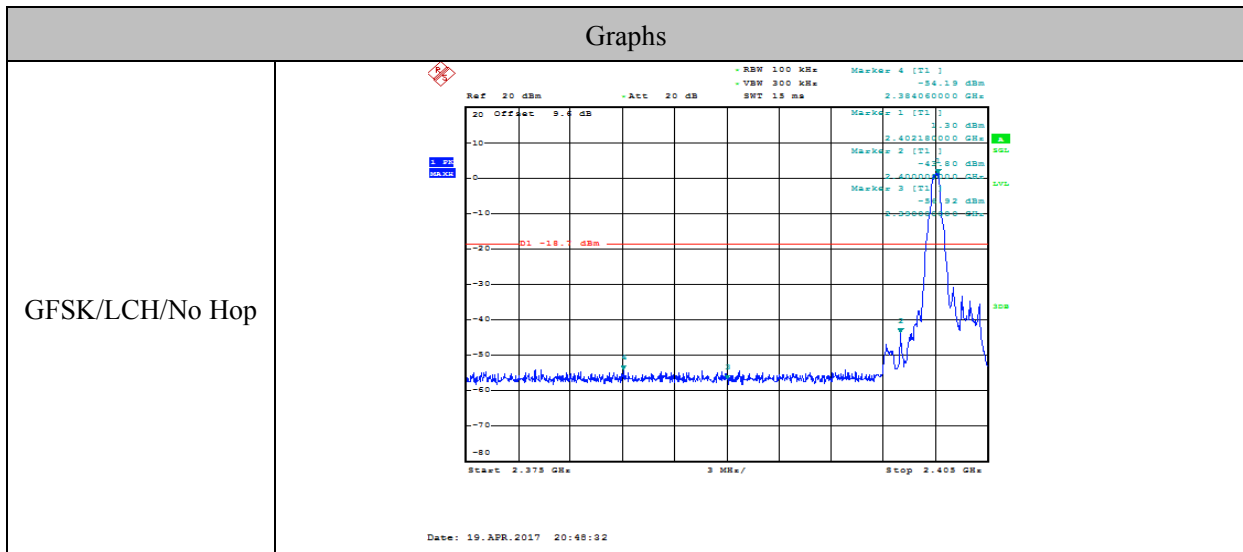

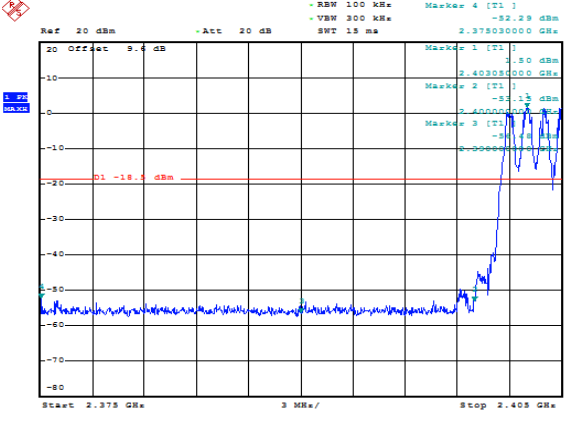
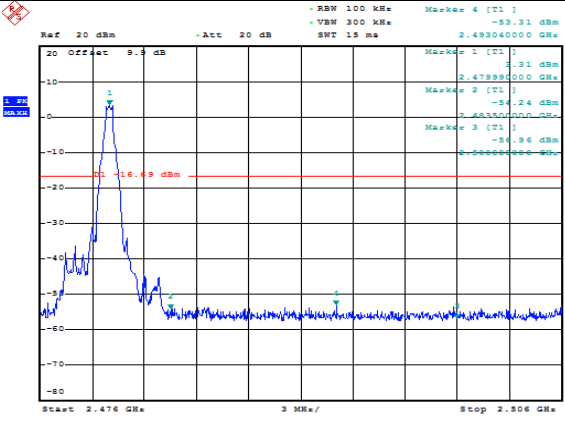
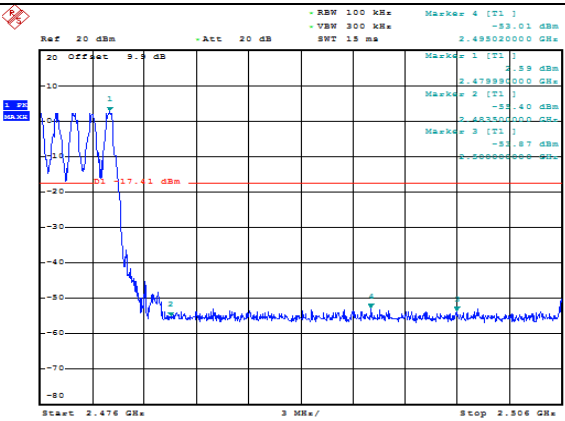
| | |
|------------------------|--|
| <p>GFSK/LCH/Hop</p> |  <p>Ref 20 dBm -Att 20 dB -RBW 100 KHz -VMW 300 KHz SWT 15 ms Marker 4 [T1] -32.29 dBm 2.3750000 GHz</p> <p>Offset 9.4 dB Marker 1 [T1] -3.80 dBm 2.4030000 GHz Marker 2 [T1] -32.15 dBm 2.4000000 GHz Marker 3 [T1] -32.11 dBm 2.4000000 GHz</p> <p>Start 2.375 GHz 3 MHz/ Stop 2.405 GHz</p> <p>Date: 19.APR.2017 20:58:56</p> |
| <p>GFSK/HCH/No Hop</p> |  <p>Ref 20 dBm -Att 20 dB -RBW 100 KHz -VMW 300 KHz SWT 15 ms Marker 4 [T1] -32.21 dBm 2.4950000 GHz</p> <p>Offset 9.4 dB Marker 1 [T1] -3.31 dBm 2.4799900 GHz Marker 2 [T1] -34.24 dBm 2.4835000 GHz Marker 3 [T1] -56.96 dBm 2.5000000 GHz</p> <p>Start 2.476 GHz 3 MHz/ Stop 2.506 GHz</p> <p>Date: 19.APR.2017 20:50:44</p> |
| <p>GFSK/HCH/Hop</p> |  <p>Ref 20 dBm -Att 20 dB -RBW 100 KHz -VMW 300 KHz SWT 15 ms Marker 4 [T1] -32.01 dBm 2.4950000 GHz</p> <p>Offset 9.4 dB Marker 1 [T1] -2.59 dBm 2.4799900 GHz Marker 2 [T1] -31.40 dBm 2.4835000 GHz Marker 3 [T1] -32.87 dBm 2.5000000 GHz</p> <p>Start 2.476 GHz 3 MHz/ Stop 2.506 GHz</p> <p>Date: 19.APR.2017 21:00:49</p> |

| | |
|-------------------------|---|
| <p>8DPSK/LCH/No Hop</p> | <p>Ref 20 dBm -Att 20 dB -RBW 100 KHz -VMW 300 KHz SWT 15 ms Marker 4 [T1] -34.00 dBm 2.389790000 GHz</p> <p>20 Offset 9.6 dB Marker 1 [T1] -1.7 dBm 2.402180000 GHz</p> <p>10 dB Marker 2 [T1] -31.46 dBm 2.400000000 GHz</p> <p>30 dB Marker 3 [T1] -36.69 dBm 2.400000000 GHz</p> <p>50 dB</p> <p>Start 2.375 GHz 3 MHz/ Stop 2.405 GHz</p> <p>Date: 19.APR.2017 20:52:00</p> |
| <p>8DPSK/LCH/Hop</p> | <p>Ref 20 dBm -Att 20 dB -RBW 100 KHz -VMW 300 KHz SWT 15 ms Marker 4 [T1] -33.43 dBm 2.386040000 GHz</p> <p>20 Offset 9.6 dB Marker 1 [T1] -1.7 dBm 2.401000000 GHz</p> <p>10 dB Marker 2 [T1] -31.28 dBm 2.400000000 GHz</p> <p>30 dB Marker 3 [T1] -36.69 dBm 2.400000000 GHz</p> <p>50 dB</p> <p>Start 2.375 GHz 3 MHz/ Stop 2.405 GHz</p> <p>Date: 19.APR.2017 21:03:25</p> |
| <p>8DPSK/HCH/No Hop</p> | <p>Ref 20 dBm -Att 20 dB -RBW 100 KHz -VMW 300 KHz SWT 15 ms Marker 4 [T1] -32.68 dBm 2.492290000 GHz</p> <p>20 Offset 9.6 dB Marker 1 [T1] -1.32 dBm 2.479990000 GHz</p> <p>10 dB Marker 2 [T1] -31.75 dBm 2.481300000 GHz</p> <p>30 dB Marker 3 [T1] -36.07 dBm 2.480000000 GHz</p> <p>50 dB</p> <p>Start 2.476 GHz 3 MHz/ Stop 2.506 GHz</p> <p>Date: 19.APR.2017 20:53:37</p> |

8DPSK/HCH/Hop

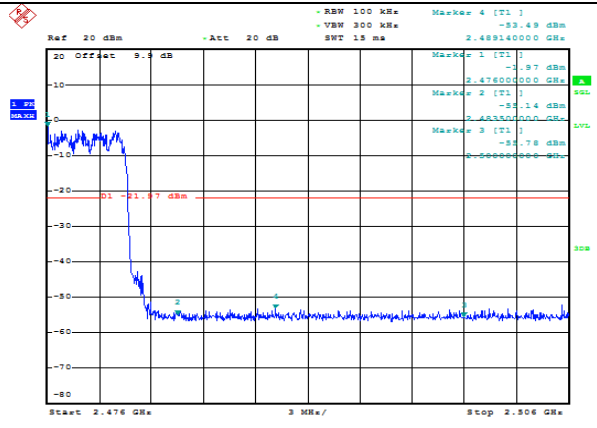

Date: 19.APR.2017 21:05:18

12. Power Line Conducted Emission

12.1. Block diagram of test setup

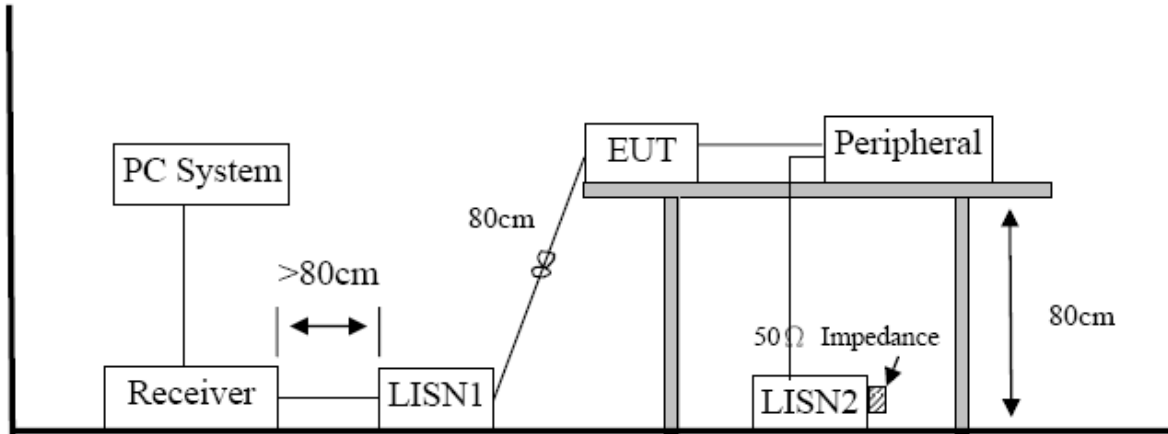

12.2. Power Line Conducted Emission Limits

| Frequency | Quasi-Peak Level dB(μ V) | Average Level dB(μ V) |
|-----------------|----------------------------------|-------------------------------|
| 150kHz ~ 500kHz | 66 ~ 56* | 56 ~ 46* |
| 500kHz ~ 5MHz | 56 | 46 |
| 5MHz ~ 30MHz | 60 | 50 |

Note 1: * Decreasing linearly with logarithm of frequency.

Note 2: The lower limit shall apply at the transition frequencies.

12.3. Test Procedure

The EUT and Support equipment, if needed, were put placed on a non-metallic table, 80cm above the ground plane.

Configuration EUT to simulate typical usage as described in clause 2.4 and test equipment as described in clause 10.2 of this report.

All I/O cables were positioned to simulate typical actual usage as per ANSI C63.10.

All support equipment power received from a second LISN.

Emissions were measured on each current carrying line of the EUT using an EMI Test Receiver connected to the LISN powering the EUT.

The Receiver scanned from 150 kHz to 30MHz for emissions in each of the test modes.

During the above scans, the emissions were maximized by cable manipulation.

The test mode(s) described in clause 2.4 were scanned during the preliminary test.

After the preliminary scan, we found the test mode producing the highest emission level.

The EUT configuration and worse cable configuration of the above highest emission levels were recorded for reference of the final test.

EUT and support equipment were set up on the test bench as per the configuration with highest emission level in the preliminary test.

A scan was taken on both power lines, Neutral and Line, recording at least the six highest emissions.

Emission frequency and amplitude were recorded into a computer in which correction factors were used to calculate the emission level and compare reading to the applicable limit.

The test data of the worst-case condition(s) was recorded.

The bandwidth of test receiver is set at 9 KHz.

12.4. Test Result

PASS. (See below detailed test result)

Note1: All emissions not reported below are too low against the prescribed limits.

Note2: “----” means Peak detection; “-----” mans Average detection

TR-4-E-010 Conducted Emission Test Result

Test Site : DDT 1# Shield Room E:\2017 CE report data\17Q0412-1\CE.EM6
Test Date : 2017-04-19 **Tested By** : Aaron
EUT : The Hampton Bluetooth Turntable **Model Number** : VM-130
Power Supply : AC 120V/60Hz **Test Mode** : BT mode
Condition : Temp:24.5°C,Humi:55%, **LISN** : 2016 ENV216/LINE
 : Press:100.1kPa

Data: 2

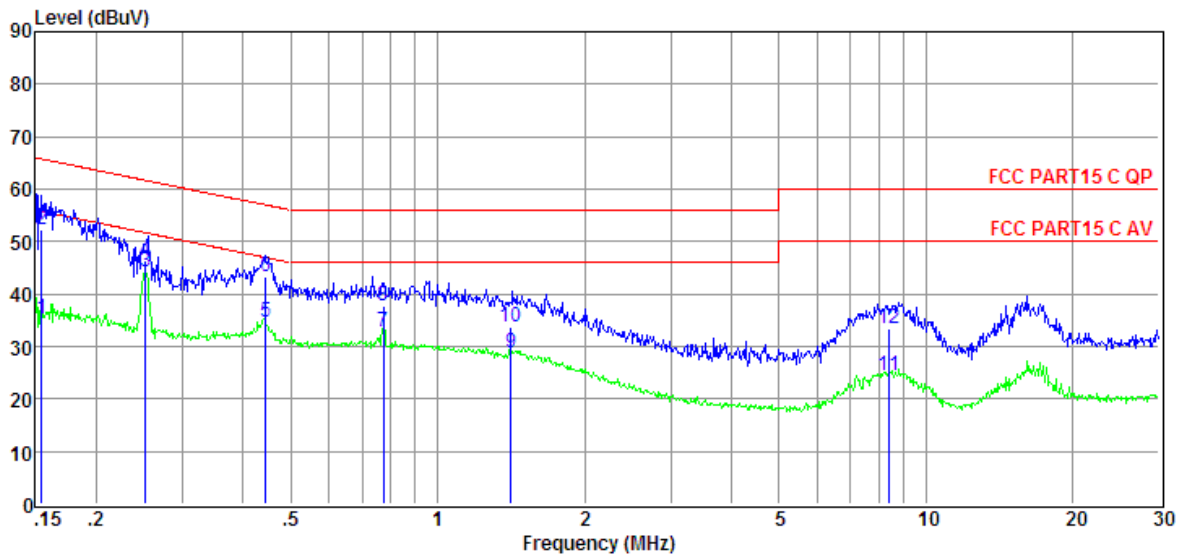

| Item (Mark) | Freq. (MHz) | Read Level (dBμV) | LISN Factor (dB) | Cable Loss (dB) | Pulse Limiter Factor (dB) | Result Level (dBμV) | Limit Line (dBμV) | Over Limit (dB) | Detector | Phase |
|----------------|----------------|-------------------------|------------------------|-----------------------|------------------------------------|---------------------------|-------------------------|-----------------------|----------|-------|
| 1 | 0.15 | 15.92 | 9.61 | 0.02 | 9.86 | 35.41 | 55.74 | -20.33 | Average | LINE |
| 2 | 0.15 | 32.82 | 9.61 | 0.02 | 9.86 | 52.31 | 65.74 | -13.43 | QP | LINE |
| 3 | 0.25 | 24.79 | 9.61 | 0.02 | 9.86 | 44.28 | 51.69 | -7.41 | Average | LINE |
| 4 | 0.25 | 26.85 | 9.61 | 0.02 | 9.86 | 46.34 | 61.69 | -15.35 | QP | LINE |
| 5 | 0.44 | 15.01 | 9.61 | 0.02 | 9.86 | 34.50 | 46.98 | -12.48 | Average | LINE |
| 6 | 0.44 | 23.85 | 9.61 | 0.02 | 9.86 | 43.34 | 56.98 | -13.64 | QP | LINE |
| 7 | 0.78 | 13.36 | 9.61 | 0.03 | 9.86 | 32.86 | 46.00 | -13.14 | Average | LINE |
| 8 | 0.78 | 18.15 | 9.61 | 0.03 | 9.86 | 37.65 | 56.00 | -18.35 | QP | LINE |
| 9 | 1.41 | 9.33 | 9.62 | 0.03 | 9.86 | 28.84 | 46.00 | -17.16 | Average | LINE |
| 10 | 1.41 | 14.29 | 9.62 | 0.03 | 9.86 | 33.80 | 56.00 | -22.20 | QP | LINE |
| 11 | 8.41 | 4.81 | 9.72 | 0.09 | 9.90 | 24.52 | 50.00 | -25.48 | Average | LINE |
| 12 | 8.41 | 13.85 | 9.72 | 0.09 | 9.90 | 33.56 | 60.00 | -26.44 | QP | LINE |

- Note: 1. Result Level = Read Level + LISN Factor + Pulse Limiter Factor + Cable loss.
 2. If QP Result complies with AV limit, AV Result is deemed to comply with AV limit.
 3. Test setup: RBW: 200 Hz (9 kHz—150 kHz), 9 kHz (150 kHz—30 MHz).
 4. Step size: 80Hz (0.009MHz-0.15MHz), 4 kHz (0.15MHz-30MHz), Scan time: auto.

TR-4-E-010 Conducted Emission Test Result

Test Site : DDT 1# Shield Room E:\2017 CE report data\17Q0412-1\CE.EM6
Test Date : 2017-04-19 **Tested By** : Aaron
EUT : The Hampton Bluetooth Turntable **Model Number** : VM-130
Power Supply : AC 120V/60Hz **Test Mode** : BT mode
Condition : Temp:24.5°C,Humi:55%, **LISN** : 2016 ENV216/NEUTRAL
 Press:100.1kPa

Data: 4

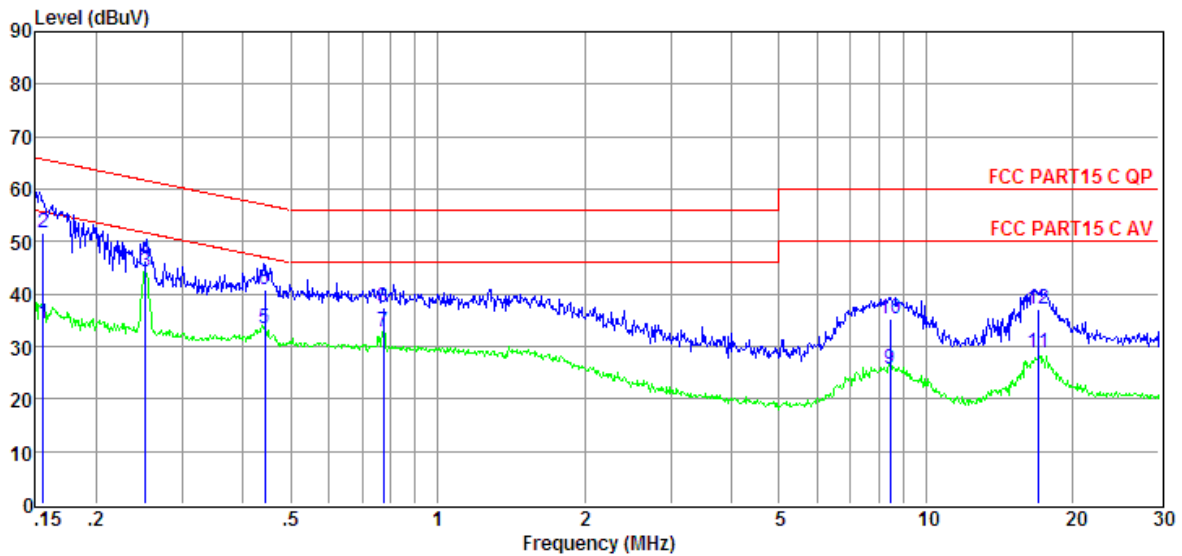

| Item (Mark) | Freq. (MHz) | Read Level (dBμV) | LISN Factor (dB) | Cable Loss (dB) | Pulse Limiter Factor (dB) | Result Level (dBμV) | Limit Line (dBμV) | Over Limit (dB) | Detector | Phase |
|----------------|----------------|-------------------------|------------------------|-----------------------|------------------------------------|---------------------------|-------------------------|-----------------------|----------|---------|
| 1 | 0.16 | 14.97 | 9.61 | 0.02 | 9.86 | 34.46 | 55.69 | -21.23 | Average | NEUTRAL |
| 2 | 0.16 | 32.13 | 9.61 | 0.02 | 9.86 | 51.62 | 65.69 | -14.07 | QP | NEUTRAL |
| 3 | 0.25 | 24.79 | 9.61 | 0.02 | 9.86 | 44.28 | 51.69 | -7.41 | Average | NEUTRAL |
| 4 | 0.25 | 26.78 | 9.61 | 0.02 | 9.86 | 46.27 | 61.69 | -15.42 | QP | NEUTRAL |
| 5 | 0.44 | 13.95 | 9.61 | 0.02 | 9.86 | 33.44 | 47.02 | -13.58 | Average | NEUTRAL |
| 6 | 0.44 | 21.28 | 9.61 | 0.02 | 9.86 | 40.77 | 57.02 | -16.25 | QP | NEUTRAL |
| 7 | 0.78 | 13.14 | 9.61 | 0.03 | 9.86 | 32.64 | 46.00 | -13.36 | Average | NEUTRAL |
| 8 | 0.78 | 17.81 | 9.61 | 0.03 | 9.86 | 37.31 | 56.00 | -18.69 | QP | NEUTRAL |
| 9 | 8.46 | 5.96 | 9.72 | 0.09 | 9.90 | 25.67 | 50.00 | -24.33 | Average | NEUTRAL |
| 10 | 8.46 | 15.44 | 9.72 | 0.09 | 9.90 | 35.15 | 60.00 | -24.85 | QP | NEUTRAL |
| 11 | 16.93 | 8.71 | 9.88 | 0.14 | 9.93 | 28.66 | 50.00 | -21.34 | Average | NEUTRAL |
| 12 | 16.93 | 17.08 | 9.88 | 0.14 | 9.93 | 37.03 | 60.00 | -22.97 | QP | NEUTRAL |

- Note: 1. Result Level = Read Level + LISN Factor + Pulse Limiter Factor + Cable loss.
 2. If QP Result complies with AV limit, AV Result is deemed to comply with AV limit.
 3. Test setup: RBW: 200 Hz (9 kHz—150 kHz), 9 kHz (150 kHz—30 MHz).
 4. Step size: 80Hz (0.009MHz-0.15MHz), 4 kHz (0.15MHz-30MHz), Scan time: auto.

13. Antenna Requirements

13.1. Limit

For intentional device, according to FCC 47 CFR Section 15.203, an intentional radiator shall be designed to ensure that no antenna other than that furnished by the responsible party shall be used with the device. And according to FCC 47 CFR Section 15.247 (b), if transmitting antennas of directional gain greater than 6dBi are used, the power shall be reduced by the amount in dB that the directional gain of the antenna exceeds 6dBi.

13.2. Result

The antennas used for this product are integrated antenna and that no antenna other than that furnished by the responsible party shall be used with the device, the maximum peak gain of the transmit antenna is only 0dBi.

14. Test setup photograph





15. Photos of the EUT



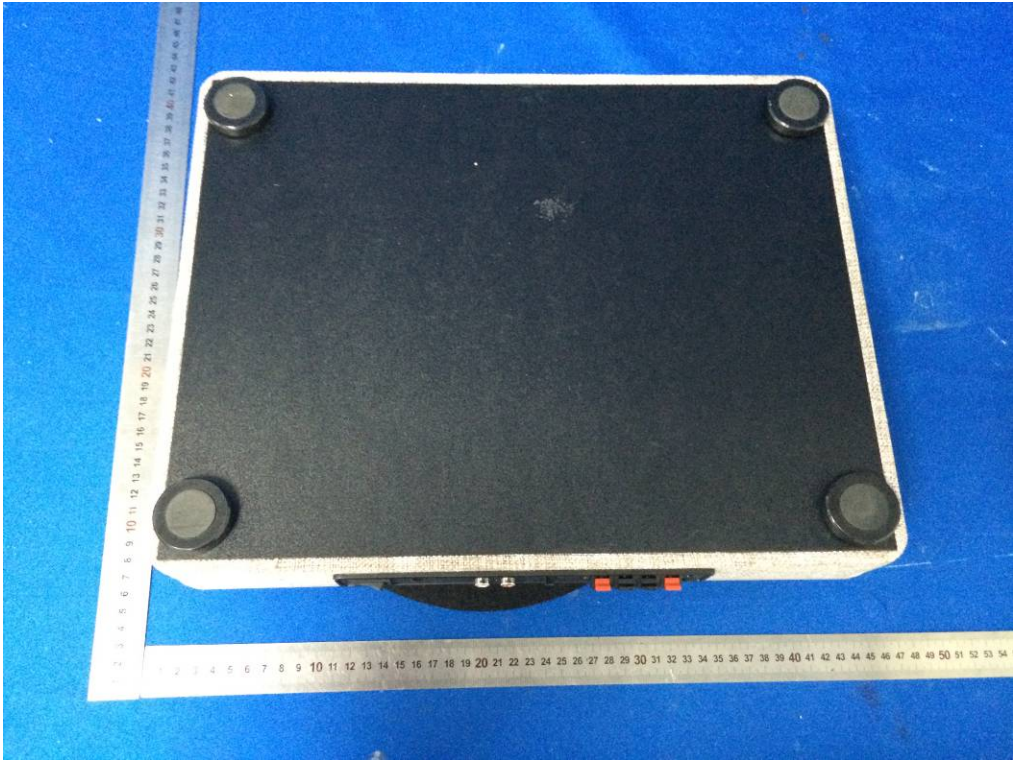





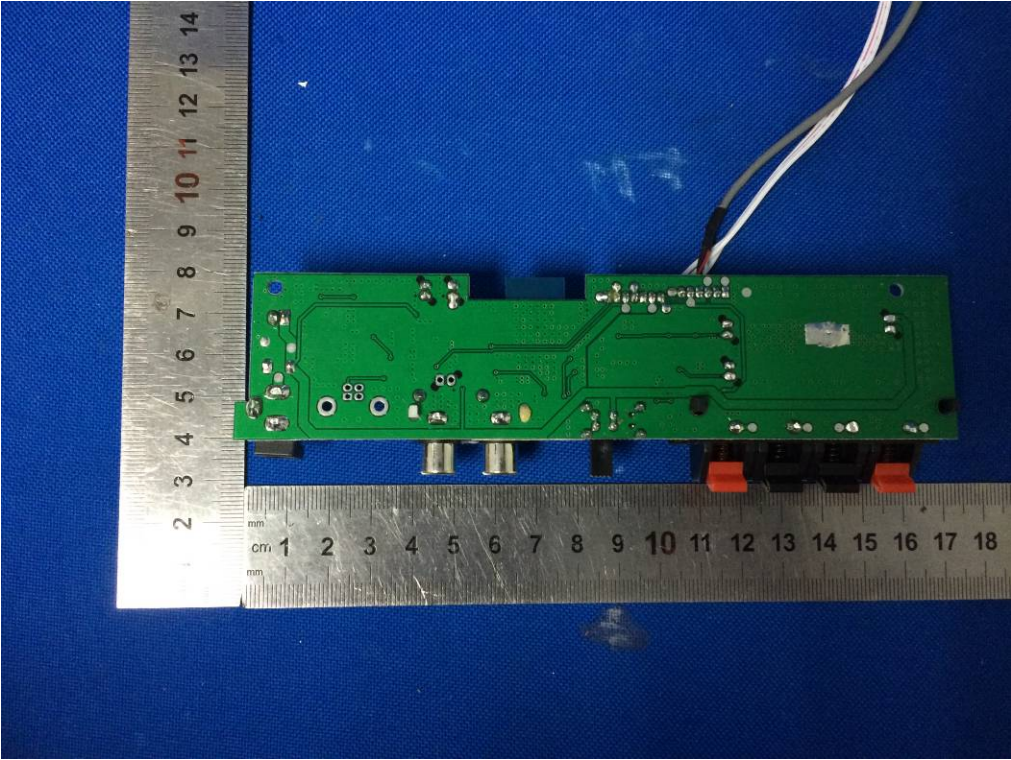

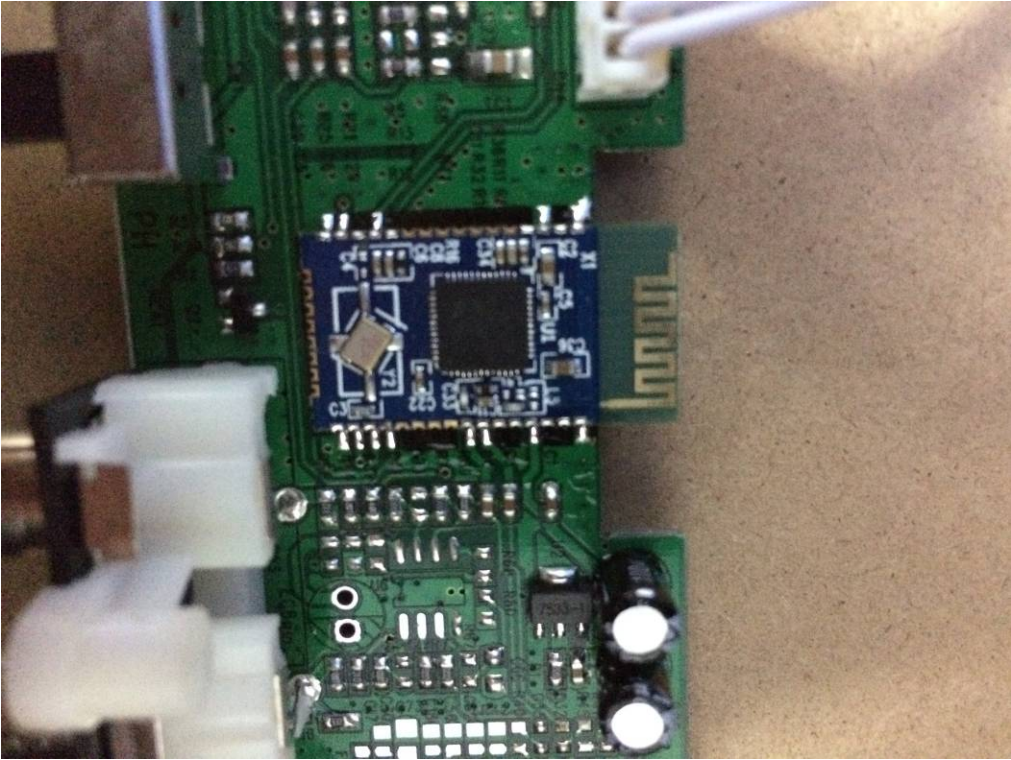
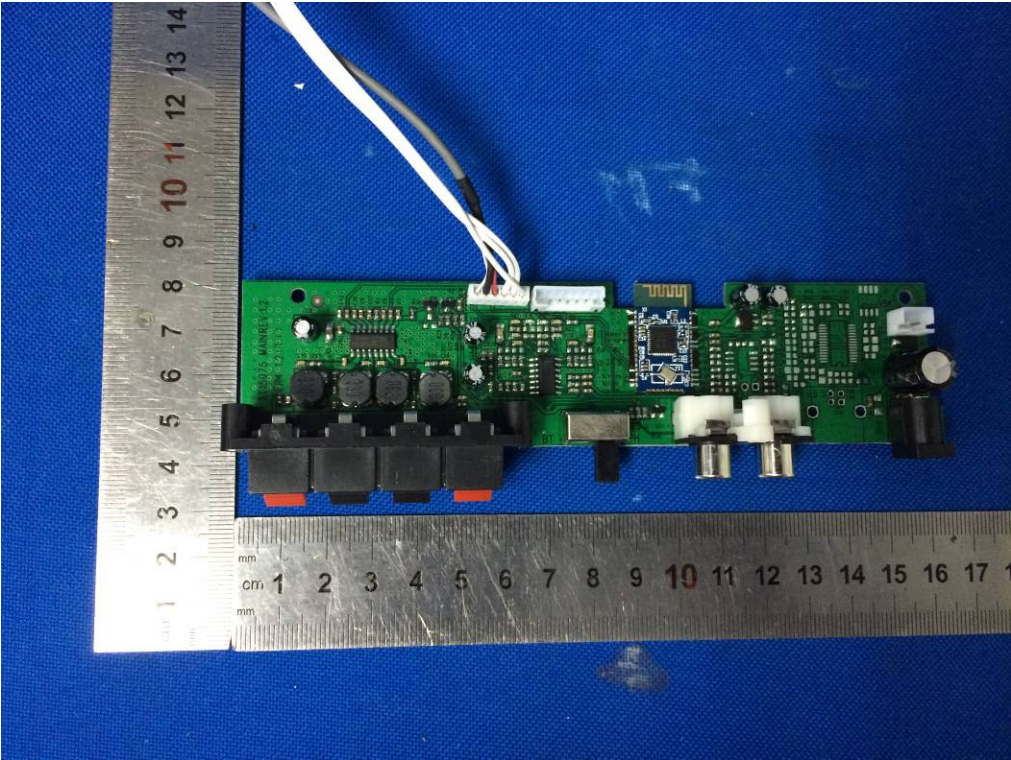

END OF REPORT