



FCC ID: 2AD9XPIRH  
Report No.: T190403N01-RP1

Page: 1 / 38  
Rev.: 01

# FCC 47 CFR PART 15 SUBPART C

## ANSI C63.10: 2013

### TEST REPORT

For

**Versa PIR**

**Model: PIR**

**Brand: **

Issued to

**Versa Wireless Inc.**

103-19292 60th Ave. Surrey, BC Canada V3S 3M2

Issued by

**Compliance Certification Services Inc.**

**Tainan Lab.**

No.8, Jiucengling, Xinhua Dist., Tainan City 712, Taiwan (R.O.C.)

**TEL: (06) 580-2201**

**FAX: (06) 580-2202**

**Issued Date: May 29, 2019**

**Note:** This report shall not be reproduced except in full, without the written approval of Compliance Certification Services Inc. This document may be altered or revised by Compliance Certification Services Inc. personnel only, and shall be noted in the revision section of the document.

Unless otherwise stated the results shown in this test report refer only to the sample(s) tested and such sample(s) are retained for 90 days only.  
除非另有說明，此報告結果僅對測試之樣品負責，同時此樣品僅保留90天。本報告未經本公司書面許可，不可部分複製。

This document is issued by the Company subject to its General Conditions of Service printed overleaf, available on request or accessible at [www.sgs.com/terms\\_and\\_conditions.htm](http://www.sgs.com/terms_and_conditions.htm) and for electronic format documents, subject to Terms and Conditions for Electronic Documents at [www.sgs.com/terms\\_e-document.htm](http://www.sgs.com/terms_e-document.htm). Attention is drawn to the limitation of liability, indemnification and jurisdiction issues defined therein. Any holder of this document is advised that information contained hereon reflects the Company's findings at the time of its intervention only and within the limits of Client's instructions, if any. The Company's sole responsibility is to its Client and this document does not exonerate parties to a transaction from exercising all their rights and obligations under the transaction documents. This document cannot be reproduced except in full, without prior written approval of the Company. Any unauthorized alteration, forgery or falsification of the content or appearance of this document is unlawful and offenders may be prosecuted to the fullest extent of the law.

**REVISION HISTORY**

Rev.	Issue Date	Revisions	Effect Page	Revised By
00	April 25, 2019	Initial Issue	ALL	Gina Lin
01	May 29, 2019	See the following note rev.01	Page5	Gina Lin

**Note:**

Rev.01 Issue Date: May 29, 2019  
Revise TEST RESULT SUMMARY.

## TABLE OF CONTENTS

<b>1. TEST RESULT CERTIFICATION .....</b>	<b>4</b>
<b>2. TEST RESULT SUMMARY .....</b>	<b>5</b>
<b>3. EUT DESCRIPTION.....</b>	<b>6</b>
<b>4. TEST METHODOLOGY .....</b>	<b>7</b>
4.1 EUT CONFIGURATION .....	7
4.2 EUT EXERCISE .....	7
4.3 GENERAL TEST PROCEDURES .....	7
4.4 FCC PART 15.205 RESTRICTED BANDS OF OPERATIONS .....	8
4.5 DESCRIPTION OF TEST MODES .....	8
<b>5. INSTRUMENT CALIBRATION .....</b>	<b>9</b>
5.1 MEASURING INSTRUMENT CALIBRATION.....	9
5.2 MEASUREMENT EQUIPMENT USED.....	9
5.3 MEASUREMENT UNCERTAINTY .....	10
<b>6. FACILITIES AND ACCREDITATIONS .....</b>	<b>11</b>
6.1 FACILITIES.....	11
6.2 EQUIPMENT .....	11
6.3 TABLE OF ACCREDITATIONS AND LISTINGS .....	11
6.4 TABLE OF ACCREDITATIONS AND LISTINGS .....	12
<b>7. SETUP OF EQUIPMENT UNDER TEST .....</b>	<b>13</b>
7.1 SETUP CONFIGURATION OF EUT.....	13
7.2 SUPPORT EQUIPMENT .....	13
7.3 EUT OPERATING CONDITION .....	13
<b>8. FCC PART 15.231 REQUIREMENTS.....</b>	<b>14</b>
8.1 99% BANDWIDTH.....	14
8.2 20dB BANDWIDTH.....	17
8.3 LIMIT OF TRANSMISSION TIME .....	19
8.4 DUTY CYCLE .....	21
8.5 RADIATED EMISSIONS.....	25
8.6 POWERLINE CONDUCTED EMISSIONS .....	34
<b>9. APPENDIX 1 PHOTOGRAPHS OF TEST SETUP .....</b>	<b>35</b>

Report No.: T190403N01-RP1

## 1. TEST RESULT CERTIFICATION

**Product:** Versa PIR

**Model:** PIR

**Brand Name:** 

**Applicant:** Versa Wireless Inc.  
103-19292 60th Ave. Surrey, BC Canada V3S 3M2

**Manufacturer:** Vision Automobile Electronics Industrial Co., Ltd.  
No.78, Gongye 3rd Rd., Technology Industrial Park, Tainan ,  
Taiwan , 70955

**Tested:** April 17, 2019

APPLICABLE STANDARDS	
STANDARD	TEST RESULT
FCC 47 CFR Part 15 Subpart C ANSI C63.10: 2013	No non-compliance noted
Statements of Conformity	
Determining compliance shall be based on the results of the compliance measurement, not taking into account measurement instrumentation uncertainty.	

### We hereby certify that:

The above equipment was tested by Compliance Certification Services Inc. The test data, data evaluation, test procedures, and equipment configurations shown in this report were made in accordance with the procedures given in ANSI C63.10: 2013 and the energy emitted by the sample EUT tested as described in this report is in compliance with conducted and radiated emission limits of FCC Rules Part 15.207, 15.209 and Part 15.231.

The test results of this report relate only to the tested sample identified in this report.

Approved by:



**Jeter Wu**  
Assistant Manager

Reviewed by:

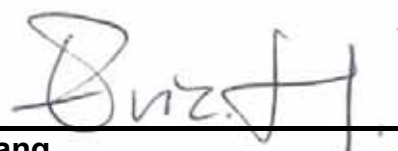

**Eric Huang**  
Section Manager

## 2. TEST RESULT SUMMARY

FCC Standard Section	Report Section	Test Item	Result
15.203	3	Antenna Requirement	Pass
-	8.1	Occupied Bandwidth (99%)	Pass
15.231(c)	8.2	20dB Bandwidth	Pass
15.231(a)(1)	8.3	Limit of Transmission Time	Pass
-	8.4	Duty Cycle	Pass
15.231(b)	8.5	Radiated Emissions	Pass
15.207(a)	8.6	Powerline Conducted Emissions	---

### 3. EUT DESCRIPTION

Product.	Versa PIR
Model Number	PIR
Brand Name	<b>versa</b>
Received Date	April 03, 2019
Operation Frequency	345MHz $\pm$ 20kHz
Transmit Peak Power	96.058 dB $\mu$ V/m
Average Power	74.460 dB $\mu$ V/m
Number of Channels	1 Channel
Type of Modulation	ASK
Power Supply	3Vdc(Powered from battery)
Antenna Type	Type: PCB Antenna Model: PIR Manufacturer: N/A Gain: -7.3dBi
RF Module Brand /Model	Princeton / PT4455
Hardware Version	Rev.0
Software Version	Rev.0
Temperature Range	-15°C~ 40°C (5°F~104°F)
Reported Date	April 25, 2019

#### Remark:

1. Client consigns only one model sample to test (Model Number: **PIR**). Therefore, the testing Lab. just guarantees the unit, which has been tested.
2. This submittal(s) (test report) is intended for FCC ID: **2AD9XPIRH** filing to comply with Section 15.207, 15.209 and 15.231 of the FCC Part 15, Subpart C Rules.

## 4. TEST METHODOLOGY

The tests documented in this report were performed in accordance with ANSI C63.10 (2013) and FCC CFR 47 2.1046, 2.1047, 2.1049, 2.1051, 2.1053, 2.1055, 2.1057, 15.207, 15.209 and 15.231

### 4.1 EUT CONFIGURATION

The EUT configuration for testing is installed on RF field strength measurement to meet the Commissions requirement and operating in a manner that intends to maximize its emission characteristics in a continuous normal application.

### 4.2 EUT EXERCISE

The EUT was operated in the engineering mode to fix the TX frequency that was for the purpose of the measurements.

### 4.3 GENERAL TEST PROCEDURES

#### Conducted Emissions

The EUT is placed on the turntable, which is 0.8 m above ground plane. According to the requirements in Section 13.1.4.1 of ANSI C63.10. Conducted emissions from the EUT measured in the frequency range between 0.15 MHz and 30MHz using CISPR Quasi-peak and average detector modes.

#### Radiated Emissions

The EUT is placed on a turn table, which is 1.5m high is for radiated emission above 1GHz and 0.8m for below 1GHz. The turntable shall rotate 360 degrees to determine the position of maximum emission level. EUT is set 3m away from the receiving antenna, which varied from 1m to 4m to find out the highest emission. And also, each emission was to be maximized by changing the polarization of receiving antenna both horizontal and vertical. In order to find out the maximum emissions, exploratory radiated emission measurements were made according to the requirements in Section 13.1.4.1 of ANSI C63.10.

Report No.: T190403N01-RP1

#### 4.4 FCC PART 15.205 RESTRICTED BANDS OF OPERATIONS

(a) Except as shown in paragraph (d) of this section, only spurious emissions are permitted in any of the frequency bands listed below:

MHz	MHz	MHz	GHz
0.090 □ 0.110	16.42 - 16.423	399.9 - 410	4.5 - 5.15
<sup>1</sup> 0.495 □ 0.505	16.69475 - 16.69525	608 - 614	5.35 - 5.46
2.1735 □ 2.1905	16.80425 - 16.80475	960 - 1240	7.25 - 7.75
4.125 - 4.128	25.5 - 25.67	1300 - 1427	8.025 - 8.5
4.17725 - 4.17775	37.5 - 38.25	1435 - 1626.5	9.0 - 9.2
4.20725 - 4.20775	73 - 74.6	1645.5 - 1646.5	9.3 - 9.5
6.215 - 6.218	74.8 - 75.2	1660 - 1710	10.6 - 12.7
6.26775 - 6.26825	108 - 121.94	1718.8 - 1722.2	13.25 - 13.4
6.31175 - 6.31225	123 - 138	2200 - 2300	14.47 - 14.5
8.291 - 8.294	149.9 - 150.05	2310 - 2390-	15.35 - 16.2
8.362 □ 8.366	156.52475 -	2483.5 - 2500	17.7 - 21.4
8.37625 - 8.38675	156.52525	2655 - 2900	22.01 - 23.12
8.41425 - 8.41475	156.7 - 156.9	3260 - 3267	23.6 - 24.0
12.29 - 12.293	162.0125 - 167.17	3332 - 3339	31.2 - 31.8
12.51975 - 12.52025	167.72 - 173.2	3345.8 - 3358	36.43 - 36.5
12.57675 - 12.57725	240 - 285	3600 - 4400	( <sup>2</sup> )
13.36 □ 13.41	322 - 335.4		

<sup>1</sup> Until February 1, 1999, this restricted band shall be 0.490-0.510 MHz.

<sup>2</sup> Above 38.6

(b) Except as provided in paragraphs (d) and (e), the field strength of emissions appearing within these frequency bands shall not exceed the limits shown in Section 15.209. At frequencies equal to or less than 1000 MHz, compliance with the limits in Section 15.209 shall be demonstrated using measurement instrumentation employing a CISPR quasi-peak detector. Above 1000 MHz, compliance with the emission limits in Section 15.209 shall be demonstrated based on the average value of the measured emissions. The provisions in Section 15.35 apply to these measurements.

#### 4.5 DESCRIPTION OF TEST MODES

The EUT (Model: **PIR**) had been tested under engineering test mode condition and the EUT staying in continuous transmitting mode.

Note :

- 1) The field strength of spurious emission was measured in the following position:  
EUT stand-up position (Y axis), lie-down position (X, Z axis). The worst emission was found lie-down position (X axis) and the worst case was recorded.



Report No.: T190403N01-RP1

## 5. INSTRUMENT CALIBRATION

### 5.1 MEASURING INSTRUMENT CALIBRATION

The measuring equipment, which was utilized in performing the tests documented herein, has been calibrated in accordance with the manufacturer's recommendations for utilizing calibration equipment, which is traceable to recognized national standards.

### 5.2 MEASUREMENT EQUIPMENT USED

Chamber Room #966				
Name of Equipment	Manufacturer	Model	Serial Number	Calibration Due
Active Loop Antenna	ETS-LINDREN	6502	8905-2356	07/19/2019
Amplifier	HP	8447F	2443A01671	01/24/2020
Bi-Log Antenna	Sunol	JB1	A070506-2	02/08/2020
Cable	Rosnol+Suhner	SUCOFLEX 104PEA	SN25737 /4PEA	01/26/2020
Double Ridged Guide Horn Antenna	ETS-LINDGREN	3116	00078900	03/28/2021
EMI Test Receiver	R&S	ESCI	100960	11/06/2019
EXA Spectrum Analyzer	KEYSIGHT	N9010A	MY54430216	07/04/2019
Horn Antenna	Com-Power	AH-118	071032	04/18/2020
Pre-Amplifier	EMCI	EMC012645	980098	01/24/2020
Pre-Amplifier	MITEQ	AMF-6F-260400-4 0-8P	985646	06/20/2019
Hi-Pass Filter	MICRO-TRONICS	BRM50702-01	018	N.C.R
Software	Excel(ccs-o6-2019 v1.2)			

**Remark:** Each piece of equipment is scheduled for calibration once a year.

Conducted Emission room #1				
Name of Equipment	Manufacturer	Model	Serial Number	Calibration Due
BNC Coaxial Cable	CCS	BNC50	11	02/24/2020
EMI Test Receiver	R&S	ESCS 30	100348	02/18/2020
LISN	SCHWARZBECK	NNLK8130	8130124	01/01/2020
LISN	FCC	FCC-LISN-50-32-2	08009	05/23/2019
Pulse Limiter	R&S	ESH3-Z2	100116	02/24/2020
Software	e3(6.101222)			

**Remark:** Each piece of equipment is scheduled for calibration once a year.

### 5.3 MEASUREMENT UNCERTAINTY

測 試 項 目	不 確 定 度 (dB)
Radiated Emission, 30 to 200 MHz Test Site : CB966	±3.1dB
Radiated Emission, 200 to 1000 MHz Test Site : CB966	±2.7dB
Radiated Emission, 1 to 6 GHz	± 2.7dB
Radiated Emission, 6 to 18 GHz	± 2.7dB
Radiated Emission, 18 to 26.5 GHz	± 2.7dB
Radiated Emission, 26 to 40 GHz	± 3.7dB
Power Line Conducted Emission	± 2.0dB

Uncertainty figures are valid to a confidence level of 95%, k=2

Report No.: T190403N01-RP1

## 6. FACILITIES AND ACCREDITATIONS

### 6.1 FACILITIES

All measurement facilities used to collect the measurement data are located at

No.8, Jiucengling, Xinhua Dist., Tainan City 712, Taiwan (R.O.C.)

The sites are constructed in conformance with the requirements of ANSI C63.7:1992, ANSI C63.10: 2013 and CISPR Publication 22.

### 6.2 EQUIPMENT

Radiated emissions are measured with one or more of the following types of linearly polarized antennas: tuned dipole, biconical, log periodic, bi-log, and/or ridged waveguide, horn. Spectrum analyzers with pre-selectors and quasi-peak detectors are used to perform radiated measurements.

Conducted emissions are measured with Line Impedance Stabilization Networks and EMI Test Receivers.

Calibrated wideband preamplifiers, coaxial cables, and coaxial attenuators are also used for making measurements.

All receiving equipment conforms to CISPR Publication 16-1, "Radio Interference Measuring Apparatus and Measurement Methods."

### 6.3 TABLE OF ACCREDITATIONS AND LISTINGS

The test facilities used to perform radiated and conducted emissions tests are accredited by Taiwan Accreditation Foundation for the specific scope of accreditation under Lab Code: 1109 to perform Electromagnetic Interference tests according to FCC PART 15 AND CISPR 22 requirements. No part of this report may be used to claim or imply product endorsement by TAF or any agency of the Government. In addition, the test facilities are listed with Federal Communications Commission (registration no: TW1109).



Report No.: T190403N01-RP1

## 6.4 TABLE OF ACCREDITATIONS AND LISTINGS

Our laboratories are accredited and approved by the following accreditation body according to ISO/IEC 17025.

<b>Taiwan</b>	TAF
---------------	-----

The measuring facility of laboratories has been authorized or registered by the following approval agencies.

<b>Canada</b>	Industry Canada
<b>Germany</b>	TUV NORD
<b>Taiwan</b>	BSMI
<b>USA</b>	FCC
<b>Japan</b>	VCCI

Copies of granted accreditation certificates are available for downloading from our web site, <http://www.ccsrf.com>

Report No.: T190403N01-RP1

## 7. SETUP OF EQUIPMENT UNDER TEST

### 7.1 SETUP CONFIGURATION OF EUT

See test photographs attached in Appendix I for the actual connections between EUT and support equipment.

### 7.2 SUPPORT EQUIPMENT

#### 【RF】

No.	Product	Manufacturer	Model No.	Certify No.	Signal cable
1	N/A	---	---	---	---

No.	Signal cable description				
A	N/A	---			

#### 【EMC】

No.	Product	Manufacturer	Model No.	Certify No.	Signal cable
1	N/A	---	---	---	---

No.	Signal cable description				
A	N/A	---			

#### Remark:

1. All the equipment/cables were placed in the worst-case configuration to maximize the emission during the test.
2. Grounding was established in accordance with the manufacturer's requirements and conditions for the intended use.
3. shd. = shielded; unshd. = unshielded

### 7.3 EUT OPERATING CONDITION

#### RF Setup

1. Set up a whole system as the setup diagram.
2. Turn on power.

## 8. FCC PART 15.231 REQUIREMENTS

### 8.1 99% BANDWIDTH

#### LIMITS

None; for reporting purposes only.

#### TEST CONFIGURATION

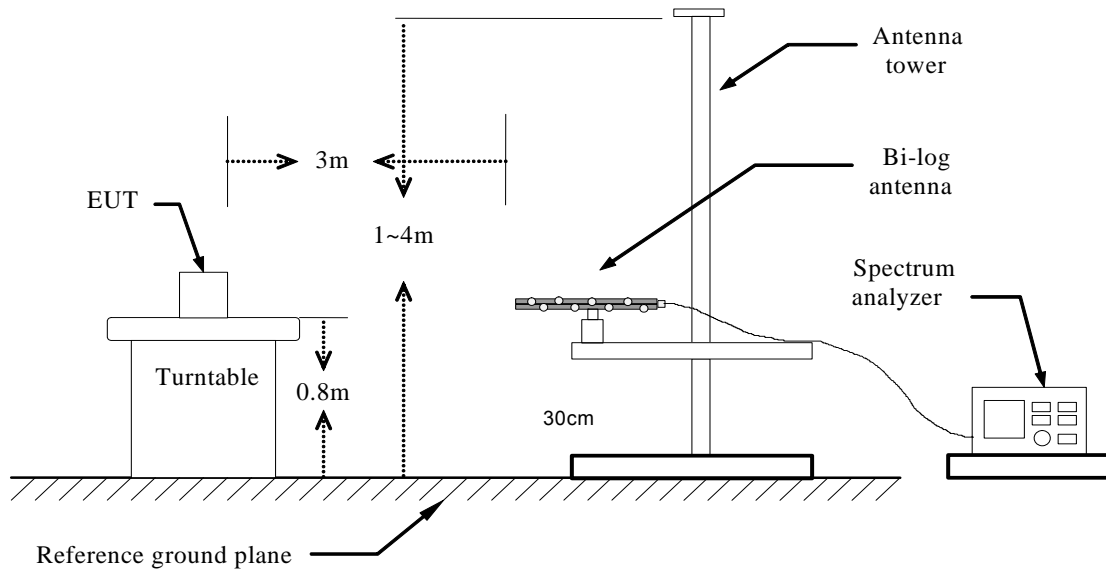



Report No.: T190403N01-RP1

Page: 15 / 38  
Rev.: 01

## **TEST PROCEDURE**

1. The spectrum shall be set as follows :
  - Span : The minimum span to fully display the emission and approximately 20dB below peak level.
  - RBW : The resolution bandwidth shall be set to as close to 1% of the selected span as is possible without being below 1%.
  - VBW: The video bandwidth shall be set to 3 times the resolution bandwidth.
  - Where practical, a sampling detector shall be used since a peak or, peak hold, may produce a wider bandwidth than actual.
2. Compute the combined power of all signal responses contained in the trace by covering all the data points.
3. For 99% occupied BW, place the markers at the frequency at which 0.5% of the power lies to the right of the right marker and 0.5% of the power lies to the left of the left marker.
4. The 99% BW is the bandwidth between the right and left markers.

Report No.: T190403N01-RP1

## TEST RESULTS

<b>Model Name</b>	PIR	<b>Test By</b>	Ted Huang
<b>Temp &amp; Humidity</b>	26.4 , 48%	<b>Test Date</b>	2019/04/17

Frequency (MHz)	99% Bandwidth (MHz)
345	1.8276

### 99% BANDWIDTH

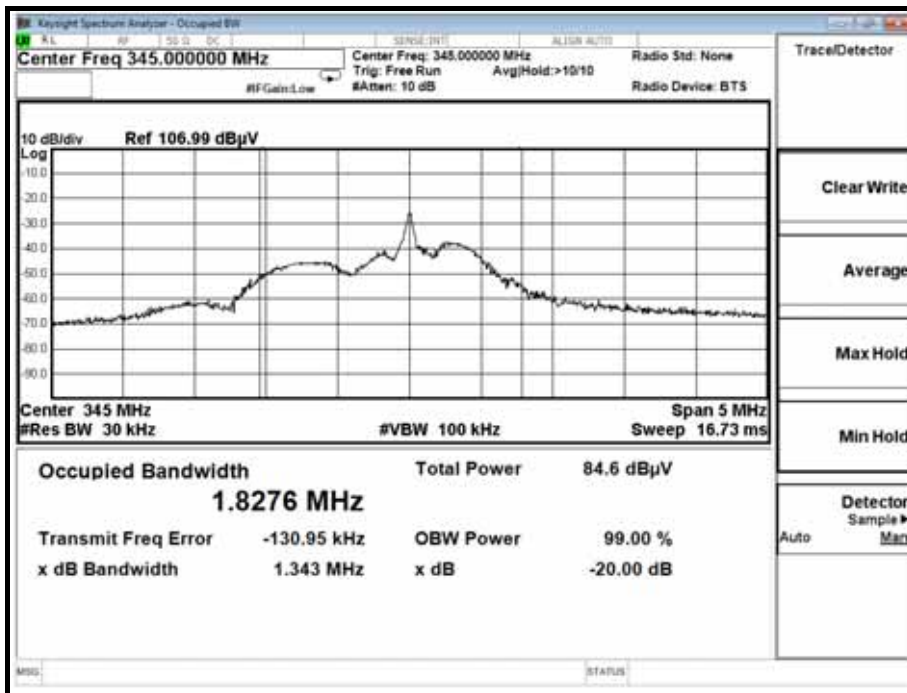



Report No.: T190403N01-RP1

## 8.2 20dB BANDWIDTH

### LIMIT

The bandwidth of the emission shall be no wider than 0.25% of the center frequency for devices operating above 70 MHz and below 900 MHz. For devices operating above 900 MHz, the emission shall be no wider than 0.5% of the center frequency. Bandwidth is determined at the points 20dB down from the modulated carrier.

### TEST CONFIGURATION

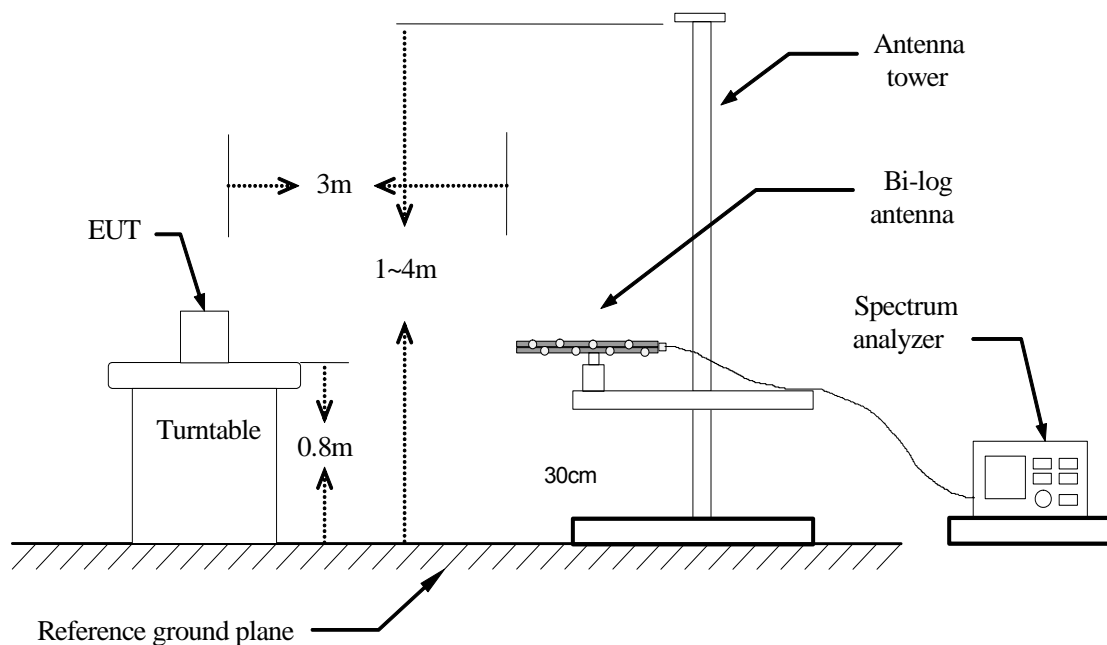

### TEST PROCEDURE

1. The EUT is placed on a turntable, which is 0.8m above ground plane.
2. The turntable shall be rotated for 360 degrees to determine the position of maximum emission level.
3. EUT is set 3m away from the receiving antenna, which is varied from 1m to 4m to find out the highest emissions.
4. And also, each emission was to be maximized by changing the polarization of receiving antenna both horizontal and vertical.
5. Set the spectrum analyzer in the following setting as:  
RBW is set to 1%~5%OBW and VBW is set 3×RBW.

Report No.: T190403N01-RP1

## TEST RESULTS

No non-compliance noted.

## TEST DATA

Frequency (MHz)	20dB Bandwidth (KHz)	Limit (KHz)	Result
345	832	862.5	PASS

## TEST PLOT

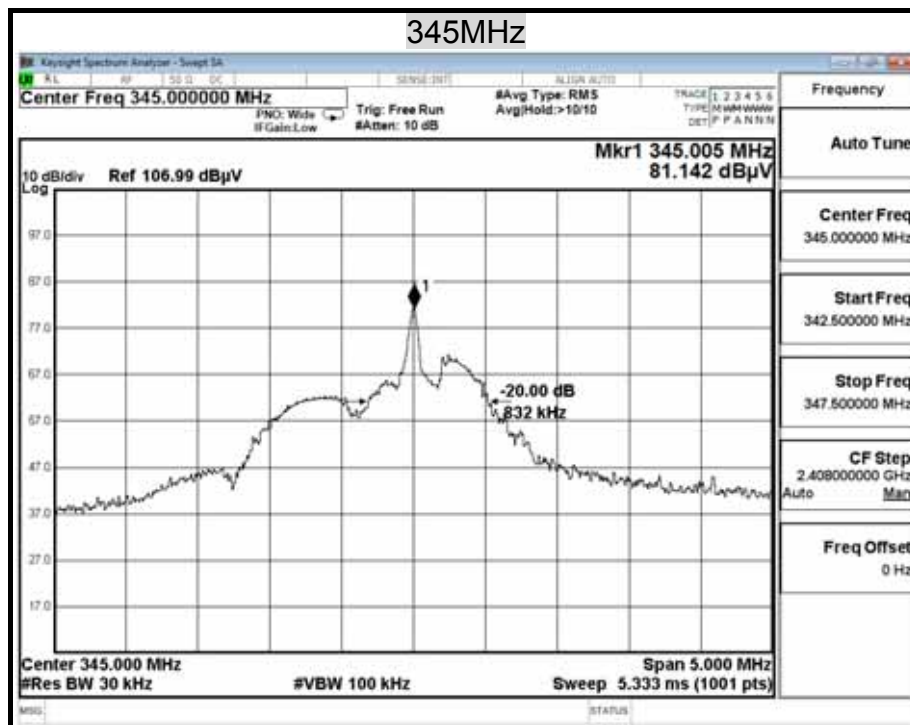

### 8.3 LIMIT OF TRANSMISSION TIME

#### LIMIT

According to 15.231, a manually operated transmitter shall employ a switch that will automatically deactivate the transmitter within not more than 5 seconds of being released.

#### TEST CONFIGURATION

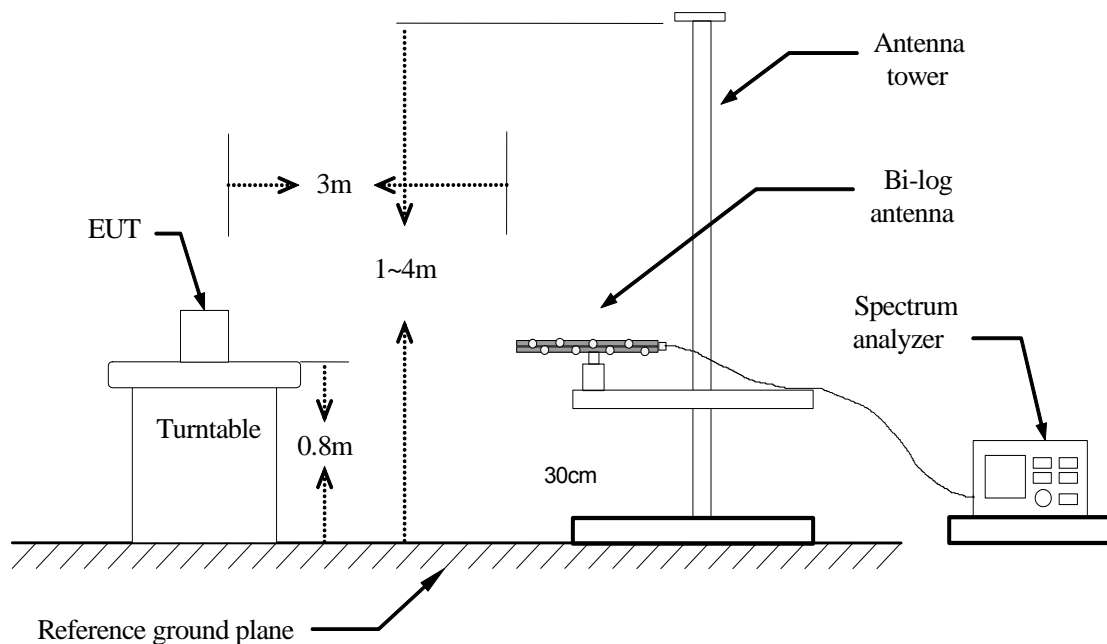

#### TEST PROCEDURE

1. Place the EUT on the table and set it in transmitting mode.
2. Set center frequency of spectrum analyzer = operating frequency.
3. Set the spectrum analyzer as RBW=1MHz, VBW=3MHz, Span = 0Hz, a suitable Sweep Time.
4. Repeat above procedures until all frequency measured were complete.

Report No.: T190403N01-RP1

## TEST RESULTS

No non-compliance noted.

## TEST DATA

Frequency (MHz)	Transmission Time (s)	Limit (Second)	Result
345	4.78	5	PASS

## TEST PLOT

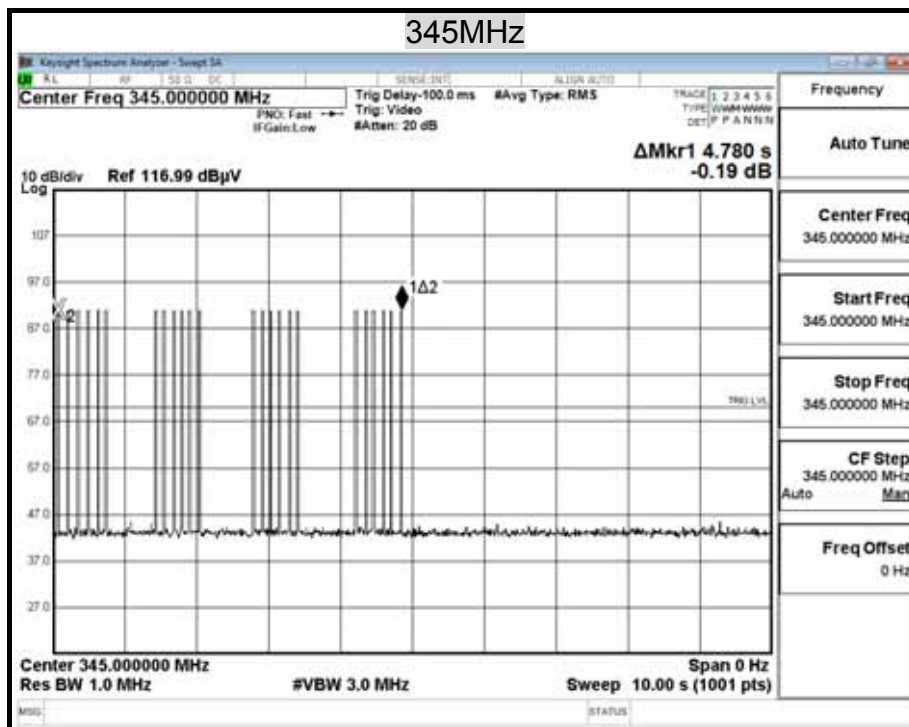

Report No.: T190403N01-RP1

## 8.4 DUTY CYCLE

### LIMIT

Nil (No dedicated limit specified in the Rules)

### TEST CONFIGURATION

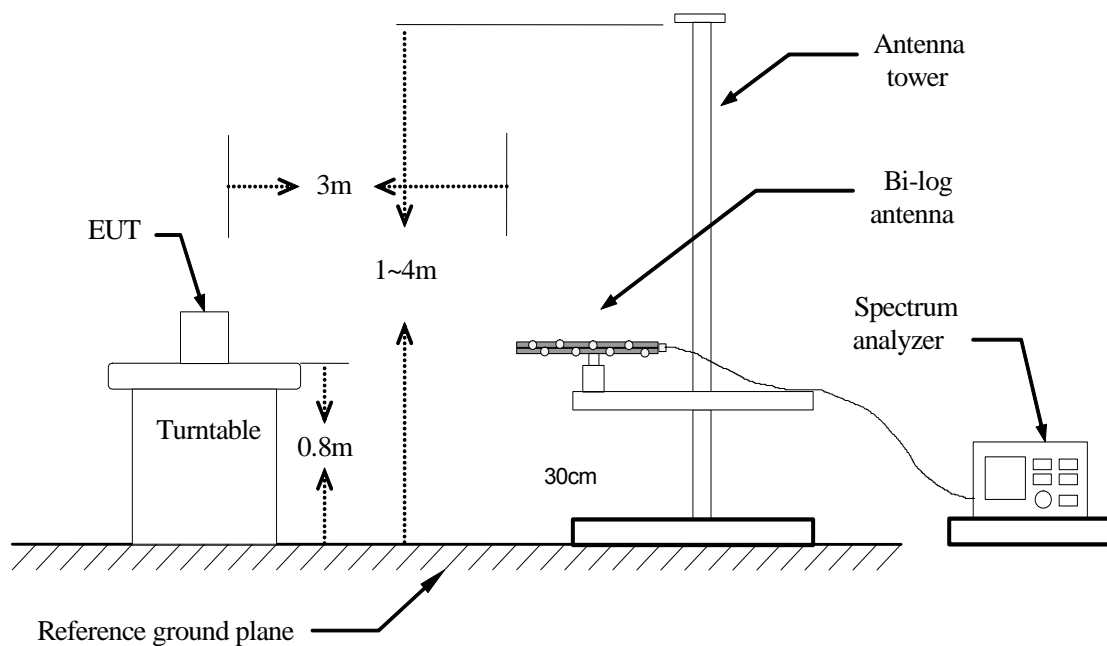

### TEST PROCEDURE

1. Place the EUT on the table and set it in transmitting mode.
2. Set center frequency of spectrum analyzer = operating frequency.
3. Set the spectrum analyzer as RBW=1MHz, VBW=3MHz, Span = 0Hz, a suitable Sweep Time.
4. Repeat above procedures until all frequency measured were complete.

Report No.: T190403N01-RP1

### **TEST RESULTS**

No non-compliance noted.

### **TEST DATA**

	us	Times	Ton	Total Ton time(ms)
Ton1	120.000	39	4680.000	8.320
Ton2	280.000	13	3640.000	
Ton3			0.000	
Tp				100.000

Ton	8.320
Tp(Ton+Toff)	100.000
Duty Cycle	0.083
Duty Factor	-21.60

8.32 %

Report No.: T190403N01-RP1

## TEST PLOT

### Ton1

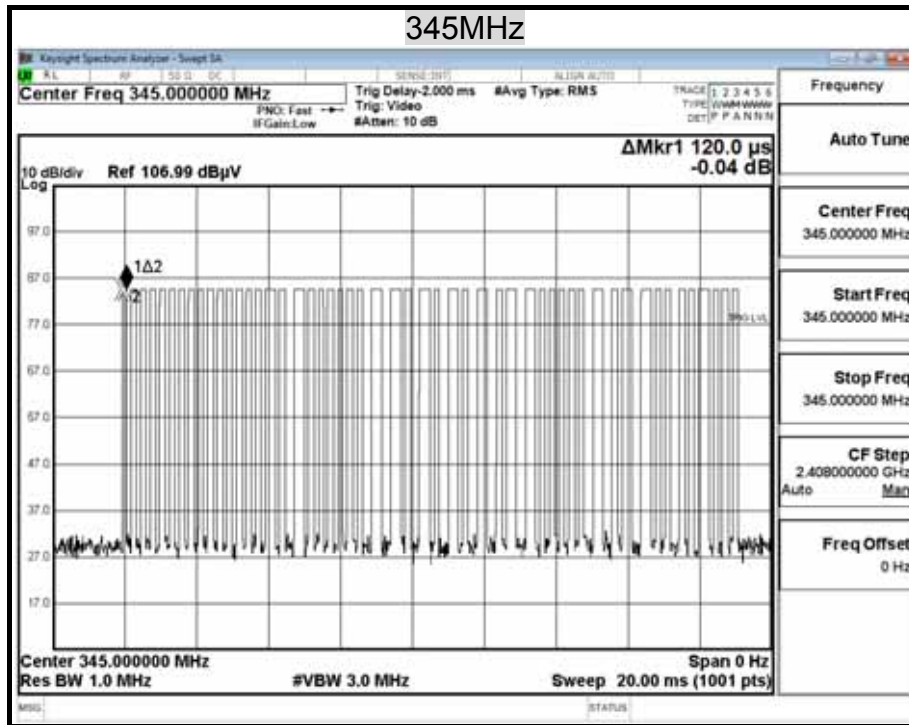

### Ton2

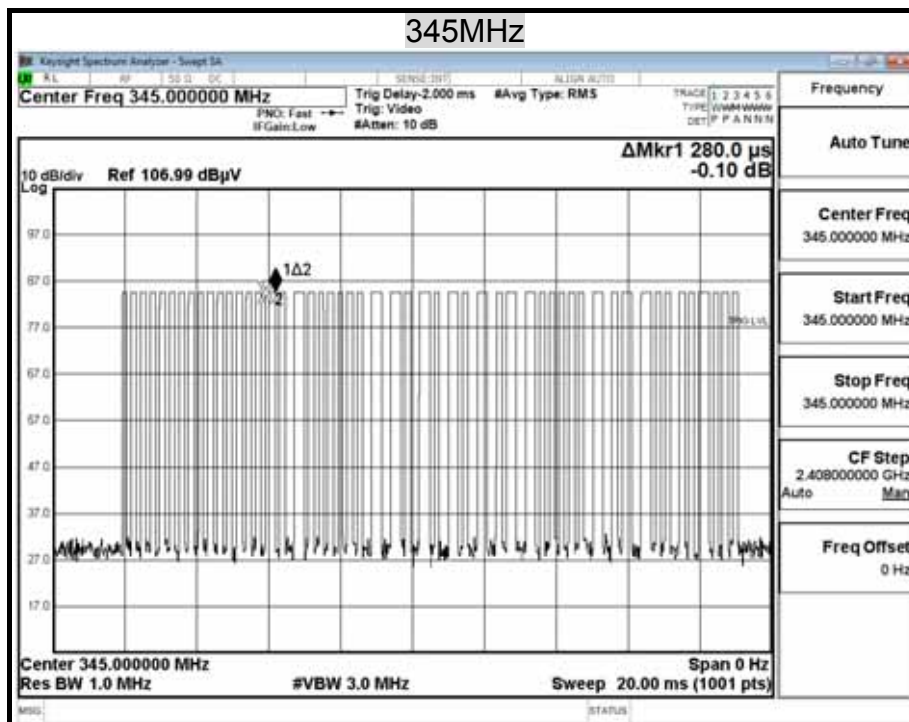

Report No.: T190403N01-RP1

Ip

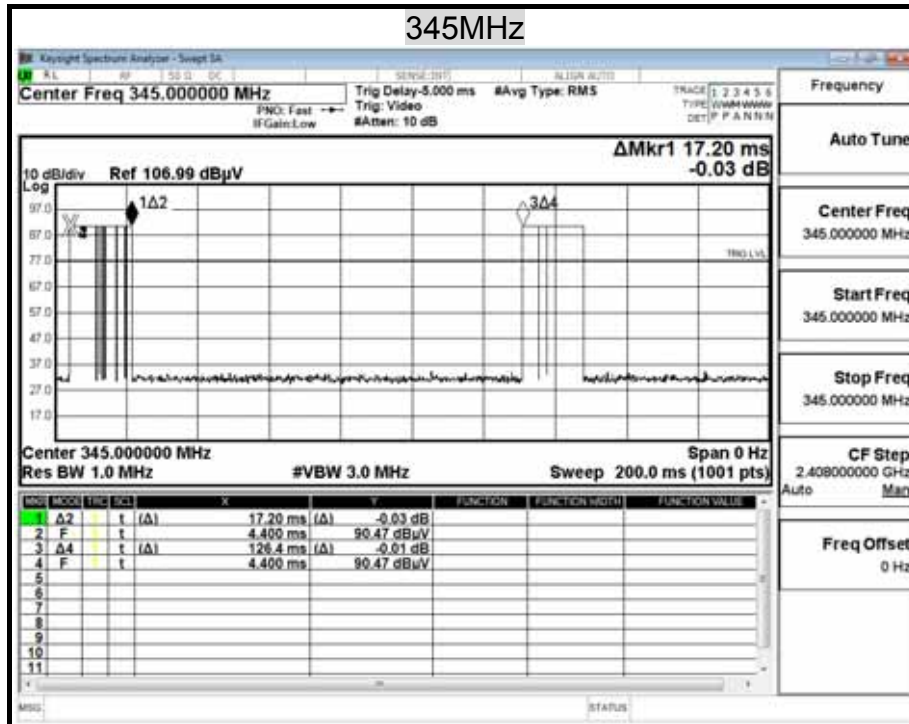



Report No.: T190403N01-RP1

## 8.5 RADIATED EMISSIONS

### LIMIT

1. Except as provided elsewhere in this Subpart, the emissions from an intentional radiator shall not exceed the field strength levels specified in the following table:

Frequency (MHz)	Field Strength (mV/m)	Field Strength (dB $\mu$ V/m at 3-meter)	Measurement Distance (m)
30-88	100*	40	3
88-216	150*	43.5	3
216-960	200*	46	3
Above 960	500	54	3

**Remark:** Except as provided in paragraph (g), fundamental emissions from intentional radiators operating under this Section shall not be located in the frequency bands 54□72 MHz, 76□88 MHz, 174□216 MHz or 470□806 MHz. However, operation within these frequency bands is permitted under other sections of this Part, e.g., Sections 15.231 and 15.241.

2. For intentional device, according to § 15.231, the general requirement of field strength of radiated emissions from intentional radiators at a distance of 3 meters shall not exceed the following table.

Fundamental Frequency (MHz)	Field Strength of Fundamental ( $\mu$ V/M)	Field Strength of Spurious Emission ( $\mu$ V/M)
40.66-40.70	2250	225
70-130	1250	125
130-174	1250 to 3750 **	125 to 375 **
174-260	3750	375
260-470	3750 to 12500 **	375 to 1250 **
Above 470	12500	1250

Note :

- “ ” linear interpolations.
- Where F is the frequency in MHz, the formulas for calculating the maximum permitted fundamental field strengths are as follows: for the band 130-174 MHz,  $\mu$ V/m at 3 meters =  $56.81818(F) - 6136.3636$ ; for the band 260-470 MHz,  $\mu$ V/m at 3 meters =  $41.6667(F) - 7083.3333$ . The maximum permitted unwanted emission level is 20dB below the maximum permitted fundamental level.

## TEST CONFIGURATION

9kHz ~ 30MHz

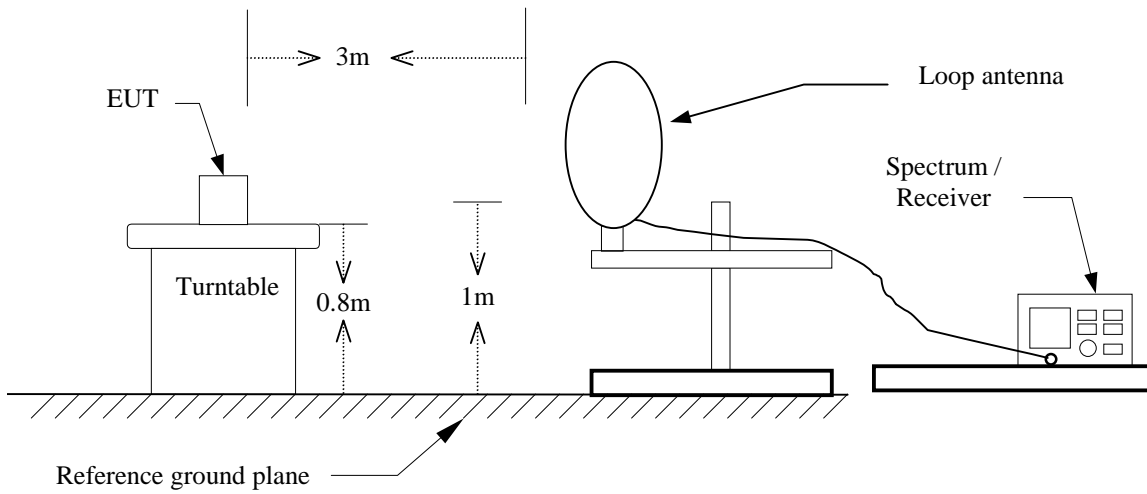

Below 1 GHz

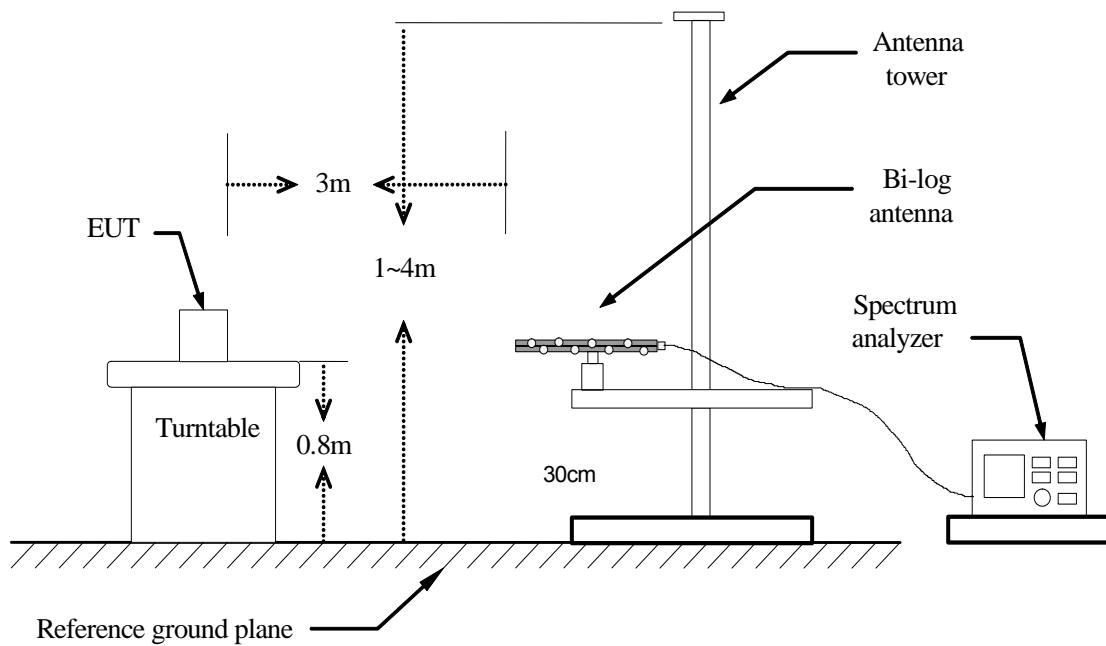

Report No.: T190403N01-RP1

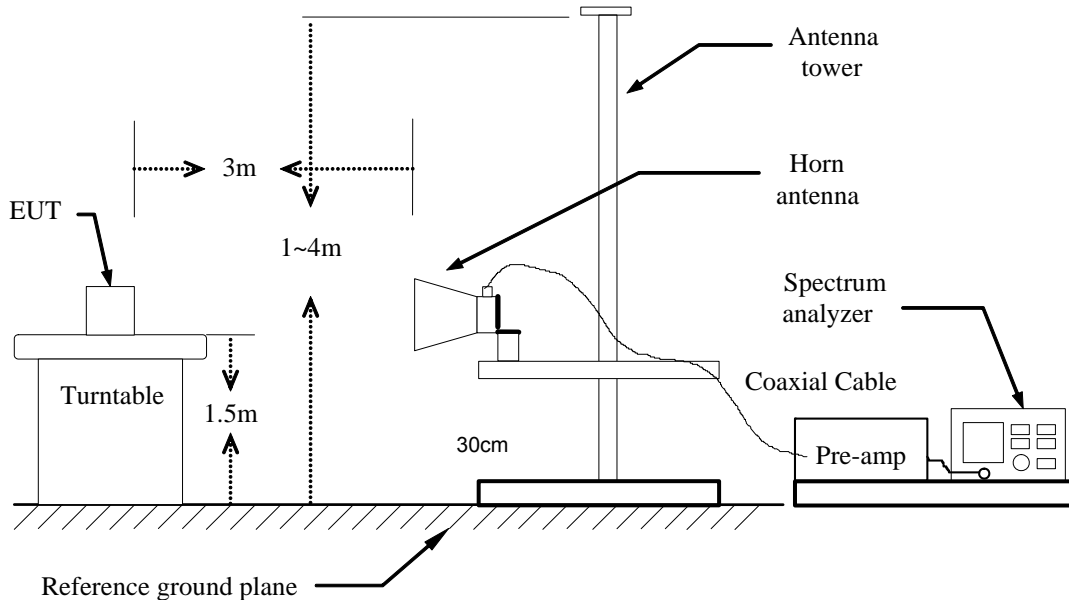
**Above 1 GHz****TEST PROCEDURE**

1. The EUT is placed on a turntable, which is 0.8m/1.5m above ground plane.
2. The turntable shall be rotated for 360 degrees to determine the position of maximum emission level.
3. EUT is set 3m away from the receiving antenna, which is varied from 1m to 4m to find out the highest emissions.
4. Maximum procedure was performed on the six highest emissions to ensure EUT compliance.
5. And also, each emission was to be maximized by changing the polarization of receiving antenna both horizontal and vertical.
6. Set the spectrum analyzer in the following setting as:  
Below 1GHz:  
RBW=100kHz / VBW=300kHz / Sweep=AUTO  
Above 1GHz:  
(a) PEAK: RBW=VBW=1MHz / Sweep=AUTO  
(b) AVERAGE: Peak Level + Duty Factor
7. Repeat above procedures until the measurements for all frequencies are complete.
8. No emission is found between lowest internal used/generated frequency to 30MHz (9kHz~30MHz)
9. Average level=Peak level + Duty factor
10. In order to comply the KDB 41477 requirement, although the test data is done in chamber, there has made the comparison with open site test area, and confirming the data is valid.

Report No.: T190403N01-RP1

## TEST RESULTS

### Below 1GHz

Operation Mode: TX

Test Date: 2019/04/17

Temperature: 24.6°C

Tested by: Ted Huang

Humidity: 58% RH

Polarity: Ver. / Hor.

### Horizontal

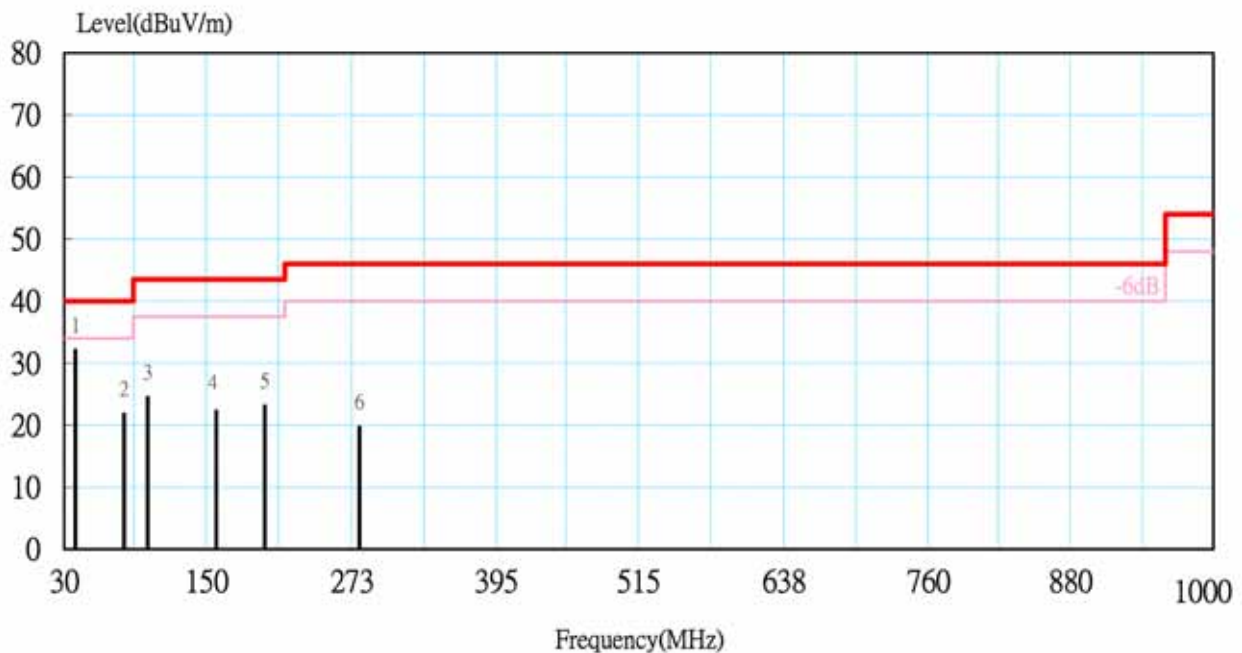

No.	Freq- uency (MHz)	Meter Reading at 3 m Level (dBμV)	Antenna Factor (dB/m)	Cable Loss (dB)	Emission at 3 m Level (dBμV/m)	Limits (dBμV/m)	Margin (dB)	Detector Mode PK/QP
1	39.70	16.54	14.74	0.84	32.12	40.00	-7.88	QP
2	80.92	12.48	8.15	1.20	21.83	40.00	-18.17	QP
3	100.32	12.67	10.48	1.37	24.53	43.50	-18.97	QP
4	158.53	7.86	12.63	1.85	22.34	43.50	-21.16	QP
5	199.75	7.68	13.27	2.22	23.17	43.50	-20.34	QP
6	279.78	3.48	13.39	2.86	19.74	46.00	-26.26	QP

### Remark:

- No emission found between lowest internal used/generated frequency to 30MHz (9kHz~30MHz).
- Radiated emissions measured in frequency range from 30 MHz to 1000MHz were made with an instrument using peak/quasi-peak detector mode.
- Quasi-peak test would be performed if the peak result were greater than the quasi-peak limit or as required by the applicant.
- Measurements above show only up to 6 maximum emissions noted, or would be lesser, with " N/A " remark, if no specific emissions from the EUT are recorded (ie: margin>20dB from the applicable limit) and considered that's already beyond the background noise floor.
- Margin (dB) = Remark result (dBuV/m) – Quasi-peak limit (dBuV/m).
- That the limit for signals below 1GHz is a QP limit and peak readings are below the QP limit.
- The fundamental signal is not shown in the test data because measurements at fundamental frequency are shown separately and were ignored during the 30 – 1000 MHz scan.

Report No.: T190403N01-RP1

Operation Mode: TX  
Temperature: 24.6°C  
Humidity: 58% RH

Test Date: 2019/04/17  
Tested by: Ted Huang  
Polarity: Ver. / Hor.

**Vertical**

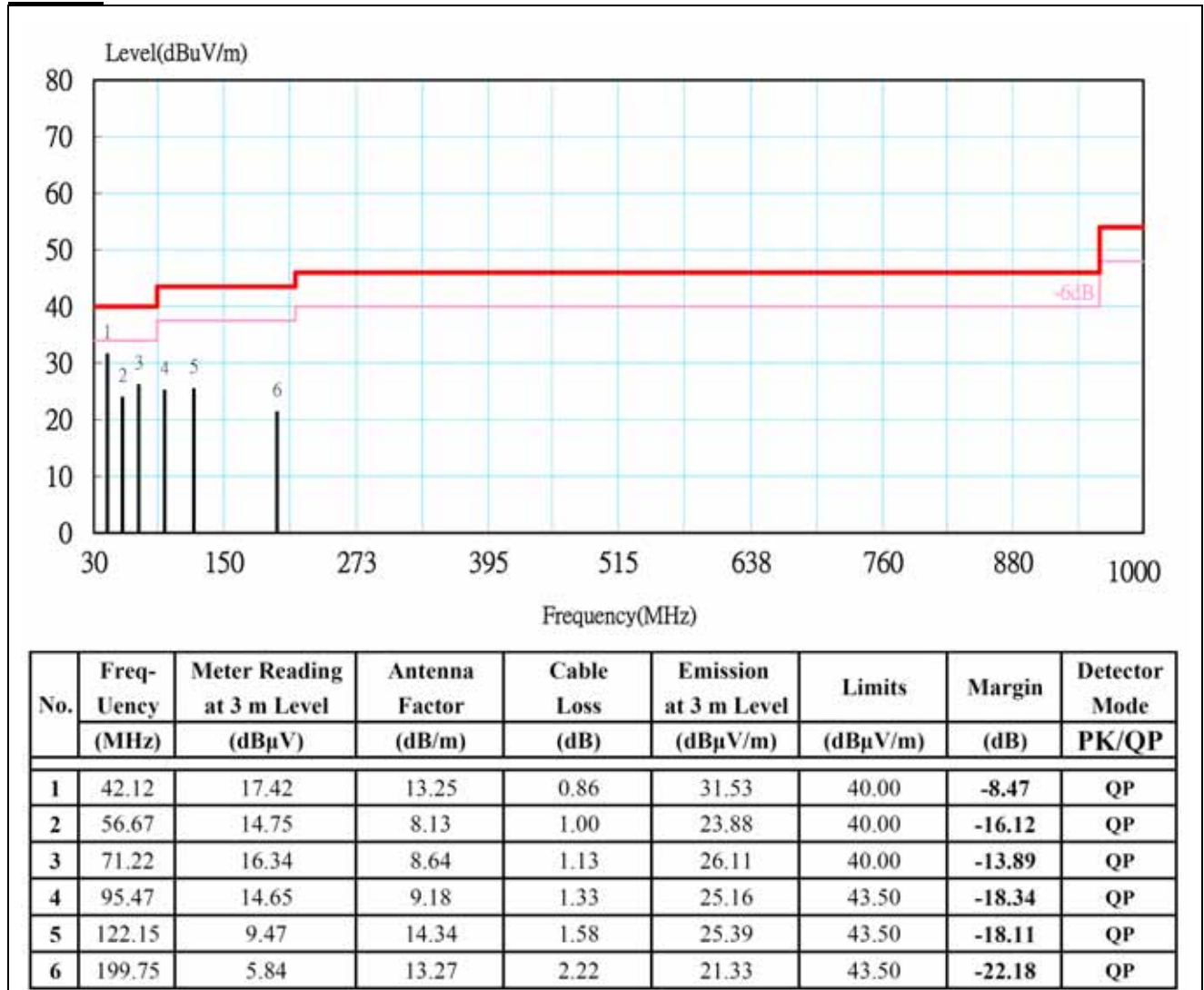

**Remark:**

- No emission found between lowest internal used/generated frequency to 30MHz (9kHz~30MHz).
- Radiated emissions measured in frequency range from 30 MHz to 1000MHz were made with an instrument using peak/quasi-peak detector mode.
- Quasi-peak test would be performed if the peak result were greater than the quasi-peak limit or as required by the applicant.
- Measurements above show only up to 6 maximum emissions noted, or would be lesser, with " N/A " remark, if no specific emissions from the EUT are recorded (ie: margin>20dB from the applicable limit) and considered that's already beyond the background noise floor.
- Margin (dB) = Remark result (dBuV/m) – Quasi-peak limit (dBuV/m).
- That the limit for signals below 1GHz is a QP limit and peak readings are below the QP limit.
- The fundamental signal is not shown in the test data because measurements at fundamental frequency are shown separately and were ignored during the 30 – 1000 MHz scan.

Report No.: T190403N01-RP1

### The fundamental signal

<b>Operation Mode:</b>	TX	<b>Test Date:</b>	2019/04/17
<b>Temperature:</b>	26.4	<b>Tested by:</b>	Ted Huang
<b>Humidity:</b>	48% RH	<b>Polarity:</b>	Ver. / Hor.

#### Horizontal

Freq.	Reading	AF	Cable Loss	Pre-amp	Filter	Level	Limit	Margin	Mark
(MHz)	(dBμV)	(dB/m)	(dB)	(dB)	(dB)	(dBμV/m)	(dBμV/m)	(dB)	(P/Q/A)
345.000	104.420	14.945	3.399	26.707	0.000	96.058	97.257	-1.199	P
345.000	-	-	-	-	-	74.460	77.257	-2.797	A

#### Vertical

Freq.	Reading	AF	Cable Loss	Pre-amp	Filter	Level	Limit	Margin	Mark
(MHz)	(dBμV)	(dB/m)	(dB)	(dB)	(dB)	(dBμV/m)	(dBμV/m)	(dB)	(P/Q/A)
345.000	90.389	14.945	3.399	26.707	0.000	82.027	97.257	-15.230	P
345.000	-	-	-	-	-	60.429	77.257	-16.828	A

#### Remark:

1.  $Margin (dB) = Remark\ result (dBuV/m) - Quasi-peak\ limit (dBuV/m).$
2.  $Average\ level = Peak\ level + Duty\ factor$

Report No.: T190403N01-RP1

### The Harmonic

**Operation Mode:** TX                      **Test Date:** 2019/04/17  
**Temperature:** 26.4                      **Tested by:** Ted Huang  
**Humidity:** 48% RH                      **Polarity:** Ver. / Hor.

### Horizontal

Freq.	Reading	AF	Cable Loss	Pre-amp	Filter	Level	Limit	Margin	Mark
(MHz)	(dBμV)	(dB/m)	(dB)	(dB)	(dB)	(dBμV/m)	(dBμV/m)	(dB)	(P/Q/A)
690.01	62.19	20.38	5.67	25.87	0.00	62.37	77.26	-14.89	P
690.01	-	-	-	-	-	40.77	57.26	-16.49	A

### Vertical

Freq.	Reading	AF	Cable Loss	Pre-amp	Filter	Level	Limit	Margin	Mark
(MHz)	(dBμV)	(dB/m)	(dB)	(dB)	(dB)	(dBμV/m)	(dBμV/m)	(dB)	(P/Q/A)
690.01	40.60	20.38	5.67	25.87	0.00	40.77	77.26	-36.48	P
690.01	-	-	-	-	-	19.17	57.26	-38.08	A

### Remark:

- Margin (dB) = Remark result (dBuV/m) – Quasi-peak limit (dBuV/m).
- Average level=Peak level + Duty factor

Report No.: T190403N01-RP1

**Above 1 GHz**

<b>Operation Mode:</b>	TX	<b>Test Date:</b>	2019/04/17
<b>Temperature:</b>	26.4	<b>Tested by:</b>	Ted Huang
<b>Humidity:</b>	48% RH	<b>Polarity:</b>	Ver. / Hor.

Horizontal

Freq.	Reading	AF	Cable Loss	Pre-amp	Filter	Level	Limit	Margin	Mark
(MHz)	(dBμV)	(dB/m)	(dB)	(dB)	(dB)	(dBμV/m)	(dBμV/m)	(dB)	(P/Q/A)
* 1034.71	60.13	24.55	1.81	45.83	1.53	42.18	74.00	-31.82	P
* 1034.71	-	-	-	-	-	20.58	54.00	-33.42	A
* 1379.71	67.81	25.99	2.11	45.48	1.01	51.43	74.00	-22.57	P
* 1379.71	-	-	-	-	-	29.84	54.00	-24.16	A
1724.88	58.06	28.25	2.27	45.11	0.64	44.12	77.26	-33.14	P
1724.88	-	-	-	-	-	22.52	57.26	-34.74	A
2070.11	62.44	30.34	2.49	44.78	0.41	50.91	77.26	-26.34	P
2070.11	-	-	-	-	-	29.31	57.26	-27.94	A
2415.00	55.65	30.07	3.18	44.61	0.40	44.69	77.26	-32.57	P
2415.00	-	-	-	-	-	23.09	57.26	-34.16	A
* 2760.07	57.47	30.10	3.56	44.44	0.34	47.04	74.00	-26.96	P
* 2760.07	-	-	-	-	-	25.44	54.00	-28.56	A
3105.03	56.23	30.20	3.77	44.31	0.27	46.16	77.26	-31.10	P
3105.03	-	-	-	-	-	24.56	57.26	-32.70	A
3449.95	55.70	30.20	3.80	44.28	0.23	45.66	77.26	-31.60	P
3449.95	-	-	-	-	-	24.06	57.26	-33.20	A

**Remark:**

1. Measuring frequencies from 1 GHz to the 10th harmonic of highest fundamental frequency.
2. Radiated emissions measured in frequency above 1000MHz were made with an instrument using peak/average detector mode.
3. Average test would be performed if the peak result were greater than the average limit or as required by the applicant.
4. Data of measurement within this frequency range shown " --- " in the table above means the reading of emissions are attenuated more than 20dB below the permissible limits or the field strength is too small to be measured.
5. Measurements above show only up to 6 maximum emissions noted, or would be lesser, with " N/A " remark, if no specific emissions from the EUT are recorded (ie: margin>20dB from the applicable limit) and considered that's already beyond the background noise floor.
6. Margin (dB) = Remark result (dBuV/m) – Average limit (dBuV/m). Peak detector mode and average detector mode of the emission shown in Result column.
7. Average level=Peak level + Duty factor
8. \*=Restricted bands of operation



Report No.: T190403N01-RP1

Operation Mode: TX                      Test Date: 2019/04/17  
 Temperature: 26.4                      Tested by: Ted Huang  
 Humidity: 48% RH                      Polarity: Ver. / Hor.

## Vertical

Freq.	Reading	AF	Cable Loss	Pre-amp	Filter	Level	Limit	Margin	Mark
(MHz)	(dB $\mu$ V)	(dB/m)	(dB)	(dB)	(dB)	(dB $\mu$ V/m)	(dB $\mu$ V/m)	(dB)	(P/Q/A)
* 1035.31	60.20	24.55	1.81	45.83	1.53	42.25	74.00	-31.75	P
* 1035.31	-	-	-	-	-	20.65	54.00	-33.35	A
* 1380.17	63.62	26.00	2.11	45.48	1.01	47.25	74.00	-26.75	P
* 1380.17	-	-	-	-	-	25.65	54.00	-28.35	A
1725.12	57.55	28.26	2.27	45.11	0.64	43.60	77.26	-33.65	P
1725.12	-	-	-	-	-	22.01	57.26	-35.25	A
2069.70	59.43	30.34	2.49	44.78	0.41	47.90	77.26	-29.36	P
2069.70	-	-	-	-	-	26.30	57.26	-30.96	A
2415.02	53.58	30.07	3.18	44.61	0.40	42.62	77.26	-34.63	P
2415.02	-	-	-	-	-	21.03	57.26	-36.23	A
* 2760.06	56.83	30.10	3.56	44.44	0.34	46.39	74.00	-27.61	P
* 2760.06	-	-	-	-	-	24.79	54.00	-29.21	A
3105.31	56.28	30.20	3.77	44.31	0.27	46.21	77.26	-31.05	P
3105.31	-	-	-	-	-	24.61	57.26	-32.65	A
3449.81	55.41	30.20	3.80	44.28	0.23	45.38	77.26	-31.88	P
3449.81	-	-	-	-	-	23.78	57.26	-33.48	A

## Remark:

- Measuring frequencies from 1 GHz to the 10th harmonic of highest fundamental frequency.
- Radiated emissions measured in frequency above 1000MHz were made with an instrument using peak/average detector mode.
- Average test would be performed if the peak result were greater than the average limit or as required by the applicant.
- Data of measurement within this frequency range shown " --- " in the table above means the reading of emissions are attenuated more than 20dB below the permissible limits or the field strength is too small to be measured.
- Measurements above show only up to 6 maximum emissions noted, or would be lesser, with " N/A " remark, if no specific emissions from the EUT are recorded (ie: margin>20dB from the applicable limit) and considered that's already beyond the background noise floor.
- Margin (dB) = Remark result (dB $\mu$ V/m) – Average limit (dB $\mu$ V/m). Peak detector mode and average detector mode of the emission shown in Result column.
- Average level=Peak level + Duty factor.
- \*=Restricted bands of operation

Report No.: T190403N01-RP1

## 8.6 POWERLINE CONDUCTED EMISSIONS

### LIMIT

For an intentional radiator which is designed to be connected to the public utility (AC) power line, the radio frequency voltage that is conducted back onto the AC power line on any frequency or frequencies within the band 150 kHz to 30 MHz shall not exceed 250 microvolts (The limit decreases linearly with the logarithm of the frequency in the range 0.15 MHz to 0.50 MHz). The limits at specific frequency range is listed as follows:

Frequency Range (MHz)	Limits (dB $\mu$ V)	
	Quasi-peak	Average
0.15 to 0.50	66 to 56	56 to 46
0.50 to 5	56	46
5 to 30	60	50

Compliance with this provision shall be based on the measurement of the radio frequency voltage between each power line (LINE and NEUTRAL) and ground at the power terminals.

### TEST RESULTS

**This EUT is not connected to AC Source directly. No applicability for this test.**

**=== END of Report ===**