

Test Report of FCC CFR 47 Part 15 Subpart C

On Behalf of

Prentke Romich Company

FCC ID: 2AD9PACN1400PRC

Product Description: Accent 1400

Model No.: ACN1400

Supplementary Model: N/A

Brand Name: 

Prepared for: Prentke Romich Company

1022 Heyl Rd. Wooster, Ohio 44691

Prepared by: Shenzhen QC Testing Laboratory Co., Ltd.

1st Floor, Building A, Huawan Industrial Park, Gushu, Xixiang
Street, Baoan, 518126, Shenzhen, China

Tel: 0755-23008269

Fax: 0755-23726780

Report No.: QCT15GR034-4

Issue Date: April 02, 2015

Test Date: February 12~ April 02, 2015

Tested by:



Kare Gao

Reviewed by:

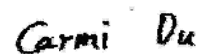

Carmi Du

Approved by:



Kendy Wang

TABLE OF CONTENTS

- 1. GENERAL INFORMATION..... 3**
 - 1.1 PRODUCT DESCRIPTION FOR EQUIPMENT UNDER TEST (EUT)..... 3
 - 1.2 TEST STANDARDS 4
 - 1.3 TEST METHODOLOGY 4
 - 1.4 TEST FACILITY 4
- 2. SYSTEM TEST CONFIGURATION 5**
 - 2.1 EUT CONFIGURATION 5
 - 2.2 EUT EXERCISE..... 5
 - 2.3 GENERAL TEST PROCEDURES 5
 - 2.4 MEASUREMENT UNCERTAINTY 5
 - 2.5 LIST OF MEASURING EQUIPMENTS USED 6
- 3. SUMMARY OF TEST RESULTS 6**
- 4. TEST OF AC POWER LINE CONDUCTED EMISSION 7**
 - 4.1 APPLICABLE STANDARD..... 7
 - 4.2 TEST SETUP DIAGRAM 7
 - 4.3 TEST RESULT 7
- 5. TEST OF MAXIMUM PEAK OUTPUT POWER 10**
 - 5.1 APPLICABLE STANDARD..... 10
 - 5.2 EUT SETUP 10
 - 5.3 TEST EQUIPMENT LIST AND DETAILS 10
 - 5.4 TEST PROCEDURE 10
 - 5.5 TEST RESULT 11
- 6. TEST OF PEAK POWER SPECTRAL DENSITY 13**
 - 6.1 APPLICABLE STANDARD..... 13
 - 6.2 EUT SETUP 13
 - 6.3 TEST EQUIPMENT LIST AND DETAILS 13
 - 6.4 TEST PROCEDURE 13
 - 6.5 TEST RESULT 13
- 7. TEST OF 6DB BANDWIDTH 21**
 - 7.1 APPLICABLE STANDARD..... 21
 - 7.2 EUT SETUP 21
 - 7.3 TEST EQUIPMENT LIST AND DETAILS 21
 - 7.4 TEST PROCEDURE 21
 - 7.5 TEST RESULT 21
- 8. TEST OF CONDUCTED SPURIOUS EMISSION..... 31**
 - 8.1 APPLICABLE STANDARD..... 31
 - 8.2 EUT SETUP 31
 - 8.3 TEST EQUIPMENT LIST AND DETAILS 31
 - 8.4 TEST PROCEDURE 31
 - 8.5 TEST RESULT 31
- 9. TEST OF RADIATED SPURIOUS EMISSION 38**
 - 9.1 RADIATED SPURIOUS EMISSION 38
 - 9.1.1 LIMITS 38
 - 9.1.2 EUT SETUP 39
 - 9.1.3 TEST PROCEDURE 40
 - 9.1.4 TEST RESULT 40
- 10. TEST OF BAND EDGES EMISSION..... 54**
 - 10.1 APPLICABLE STANDARD..... 54
 - 10.2 EUT SETUP 54
 - 10.3 TEST EQUIPMENT LIST AND DETAILS 54
 - 10.4 TEST PROCEDURE 54
 - 10.5 TEST RESULT 55
- 11. ANTENNA REQUIREMENT 61**
 - 11.1 STANDARD APPLICABLE..... 61
 - 11.2 ANTENNA CONNECTED CONSTRUCTION 61

1. GENERAL INFORMATION

1.1 Product Description for Equipment Under Test (EUT)

Client Information

Applicant:	Prentke Romich Company
Address of Applicant:	1022 Heyl Rd. Wooster, Ohio 44691
Manufacturer:	Prentke Romich Company
Address of Manufacturer:	1022 Heyl Rd. Wooster, Ohio 44691

General Description of E.U.T

Items	Description
EUT Description:	Accent 1400
Trade Name:	
Model No.:	ACN1400
Supplementary Model:	N/A
Frequency Band:	IEEE 802.11b/g, IEEE 802.11n HT20 (ISM Band) : 2412MHz~2462MHz, IEEE 802.11n HT40 (ISM Band) : 2422MHz~2452MHz
Channel Spacing:	IEEE 802.11b/g, 802.11n HT20/HT40: 5MHz
Number of Channels:	IEEE 802.11b/g, 802.11n HT20:11 Channels 802.11n HT40:7 Channels
Transmit Data Rate:	maximum of 150Mbps
Type of Modulation:	IEEE 802.11b: DSSS (CCK, DQPSK, DBPSK) IEEE 802.11g: OFDM (64QAM, 16QAM, QPSK, BPSK) IEEE 802.11n HT20/40: OFDM (64QAM, 16QAM, QPSK, BPSK)
Antenna Type:	Built-in Antenna
Antenna Gain:	0.88dBi
Power Supply:	Input: 18VDC 3.4A from AC/DC adapter;7.4VDC from battery
Adapter Information:	Model No:MENB1060A1800N02; Manufacturer: SL POWER and AULT Input: 100-240V~ 50-60Hz 1.5A Max ; Output:18.0V 3.4A

* The test data gathered are from the production sample provided by the manufacturer.

1.2 Test Standards

The tests were performed based on the Electromagnetic Interference (EMI) tests performed on the EUT. Both conducted and radiated testing were performed according to the procedures in ANSI C63.4 – 2009 Radiated testing was performed at an antenna to EUT distance 3 meters.

The tests were performed in order to determine compliance with FCC Part 15, Subpart C, and section 15.203, 15.207, 15.209 and 15.247 rules and the FCC publication KDB558074 of Guidance on Measurements for Digital Transmission Systems (47 CFR 15.247).

1.3 Test Methodology

All measurements contained in this report were conducted with CISPR 16-1-1: 2006, radio disturbance and immunity measuring apparatus, and CISPR 16-2-3: 2010, Method of measurement of disturbances and immunity. All measurement required was performed at Shenzhen CTL Testing Technology Co., Ltd. at Floor 1-A, Baisha Technology Park, No.3011, Shahexi Road, Nanshan District, Shenzhen, China 518055

1.4 Test Facility

The test facility is recognized, certified, or accredited by the following organizations:

CNAS – Registration No.: L5540

Shenzhen CTL Testing Technology Co., Ltd. To ISO/IEC 17025:25 General Requirements for the Competence of Testing and Calibration Laboratories(CNAS-CL01 Accreditation Criteria for the Competence of Testing and Calibration Laboratories) for the competence in the field of testing.The acceptance letter from the CNAS is maintained in our files: Registration: L5540, March, 2012.

FCC – Registration No.: 970318

Shenzhen CTL Testing Technology Co., Ltd. EMC Laboratory has been Registered and fully described in a report filed with the (FCC) Federal Communications Commission. The acceptance letter from the FCC is maintained in our files. Registration:970318, December 19, 2013.

2. SYSTEM TEST CONFIGURATION

2.1 EUT Configuration

The EUT configuration for testing is installed on RF field strength measurement to meet the Commissions requirement and operating in a manner that intends to maximize its emission characteristics in a continuous normal application.

2.2 EUT Exercise

The calibrated antennas used to sample the radiated field strength are mounted on a non-conductive, motorized antenna mast 3 or 10 meters from the leading edge of the turntable.

2.3 General Test Procedures

Conducted Emissions: The EUT is placed on the turntable, which is 0.8 m above ground plane. According to the requirements in Section 7.1 of ANSI C63.4-2009 Conducted emissions from the EUT measured in the frequency range between 0.15 MHz and 30MHz using CISPR Quasi-Peak detector mode.

Radiated Emissions: The EUT is a placed on as turntable, which is 0.8 m above ground plane. The turntable shall rotate 360 degrees to determine the position of maximum emission level. EUT is set 3m away from the receiving antenna, which varied from 1m to 4m to find out the highest emission. And also, each emission was to be maximized by changing the polarization of receiving antenna both horizontal and vertical. In order to find out the maximum emissions, exploratory radiated emission measurements were made according to the requirements in Section 13.1.4.1 of ANSI C63.4-2009.

2.4 Measurement Uncertainty

Where relevant, the following measurement uncertainty levels have been estimated for tests performed on the apparatus:

Parameter	Uncertainty
Power Line Conducted Emission	+/- 2.3 dB
Radiated Emission	+/- 3.4 dB

Uncertainty figures are valid to a confidence level of 95%.

2.5 List of Measuring Equipments Used

Test equipments list of Shenzhen CTL Testing Technology Co., Ltd.

Item	Test Equipment	Manufacturer	Model No.	Serial No.	Last Cal.
1	ULTRA-BROADBAND ANTENNA	Sunol Sciences Corp.	JB1 Antenna	A061713	2014.05.22
2	EMI TEST RECEIVER	ROHDE & SCHWARZ	ESCI	1166.5950.03	2014.03.19
3	Coaxial	/	/	/	2014.05.22
4	Controller	EM Electronics	Controller EM 1000	N/A	2014.05.22
5	Horn antenna	Sunol sciences corp	DRH-118	A062013	2014.07.22
6	Horn antenna	SCHWARZBECK	BBHA9710	1562	2014.07.22
7	Loop antenna	ZHINAN	ZN30900A	3548	2014.07.22
8	Amplifier	HP	8447D	1937A02492	2014.4.25
9	Broadband preamplifier	SCHWARZBECK	BBV9718	9718-182	2014.4.25
10	Spectrum Analyzer	R&S	FSP	100397	2014.05.22
11	Power Meter	Anritsu	ML2480B	100798	2014.10.25
12	Power Sensor	Anritsu	MA2411B	100258	2014.10.25

3. SUMMARY OF TEST RESULTS

FCC Rules	Description of Test	Result
FCC §15.207	AC Power Line Conducted Emission	Pass
FCC §15.247(b)	Maximum Peak Output Power	Pass
FCC §15.247(e)	Power Spectral Density	Pass
FCC §15.247(a)	6dB Bandwidth	Pass
FCC §15.247 (d)	Conducted Spurious Emission	Pass
FCC §15.205 and §15.209	Radiated Spurious Emission	Pass
FCC §15.203/15.247(b)/(c)	Antenna Requirement	Pass

4. TEST OF AC POWER LINE CONDUCTED EMISSION

4.1 Applicable Standard

Refer to FCC §15.207.

For a Low-power Radio-frequency Device is designed to be connected to the AC power line, the radio frequency voltage that is conducted back onto the AC power line on any frequency or frequencies within the band 150 kHz to 30 MHz shall not exceed below limits table.

Frequency Range (MHz)	Limits (dBuV)	
	Quasi-Peak	Average
0.150~0.500	66~56	56~46
0.500~5.000	56	46
5.000~30.00	60	50

4.2 Test Setup Diagram

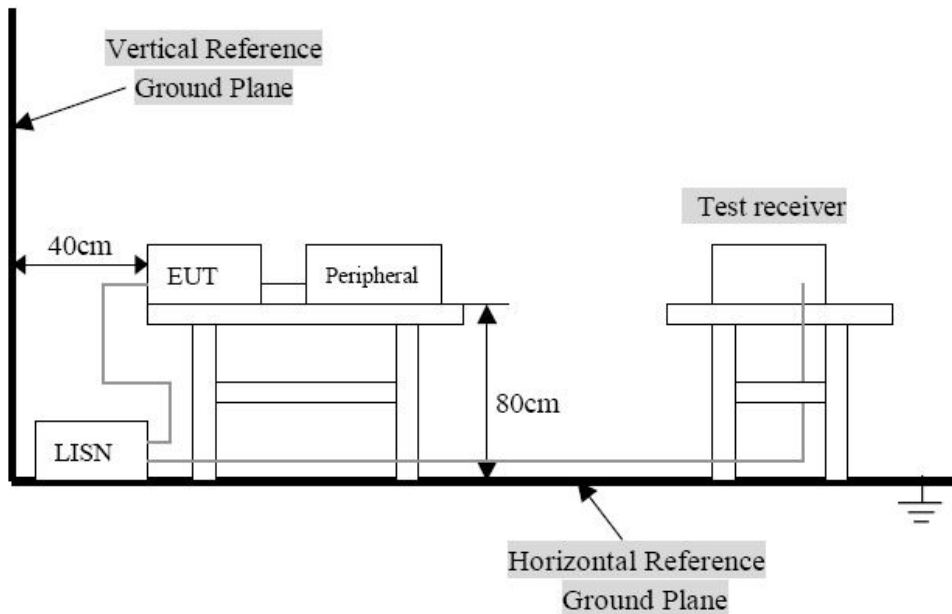

Remark: The EUT was connected to a 120 VAC/ 60Hz power source.

4.3 Test Result

Temperature (°C) : 23~25	EUT: Accent 1400
Humidity (%RH) : 45~58	M/N: ACN1400
Barometric Pressure (mbar) : 950~1000	Operation Condition: Charging with Tx Mode

Conducted Emission:

EUT: Accent 1400
M/N: ACN1400
Operating Condition: Charging with Tx Mode
Test Site: Shielded Room
Operator: Yang
Test Specification: AC 120V/60Hz for adapter
Comment: L Line

SCAN TABLE: "Voltage (9K-30M)FIN"
Short Description: 150K-30M Voltage

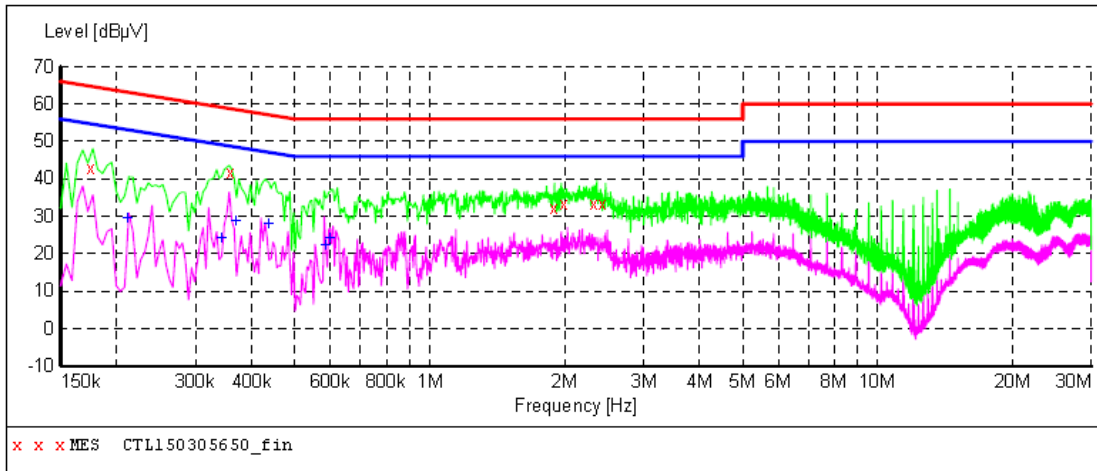

MEASUREMENT RESULT: "CTL150305650_fin"

3/5/2015 9:21AM

Frequency MHz	Level dBµV	Transd dB	Limit dBµV	Margin dB	Detector	Line	PE
0.174000	42.80	10.2	65	22.0	QP	L1	GND
0.358000	41.70	10.2	59	17.1	QP	L1	GND
1.886000	32.20	10.3	56	23.8	QP	L1	GND
1.988000	33.30	10.3	56	22.7	QP	L1	GND
2.318000	33.40	10.4	56	22.6	QP	L1	GND
2.426000	33.30	10.4	56	22.7	QP	L1	GND

MEASUREMENT RESULT: "CTL150305650_fin2"

3/5/2015 9:21AM

Frequency MHz	Level dBµV	Transd dB	Limit dBµV	Margin dB	Detector	Line	PE
0.210000	29.50	10.2	53	23.7	AV	L1	GND
0.342000	24.30	10.2	49	24.9	AV	L1	GND
0.366000	29.00	10.2	49	19.6	AV	L1	GND
0.434000	27.90	10.2	47	19.3	AV	L1	GND
0.584000	22.50	10.2	46	23.5	AV	L1	GND
0.596000	24.10	10.2	46	21.9	AV	L1	GND

Conducted Emission:

EUT: Accent 1400
M/N: ACN1400
Operating Condition: Charging with Tx Mode
Test Site: Shielded Room
Operator: Yang
Test Specification: AC 120V/60Hz for adapter
Comment: N Line

SCAN TABLE: "Voltage (9K-30M) FIN"
Short Description: 150K-30M Voltage

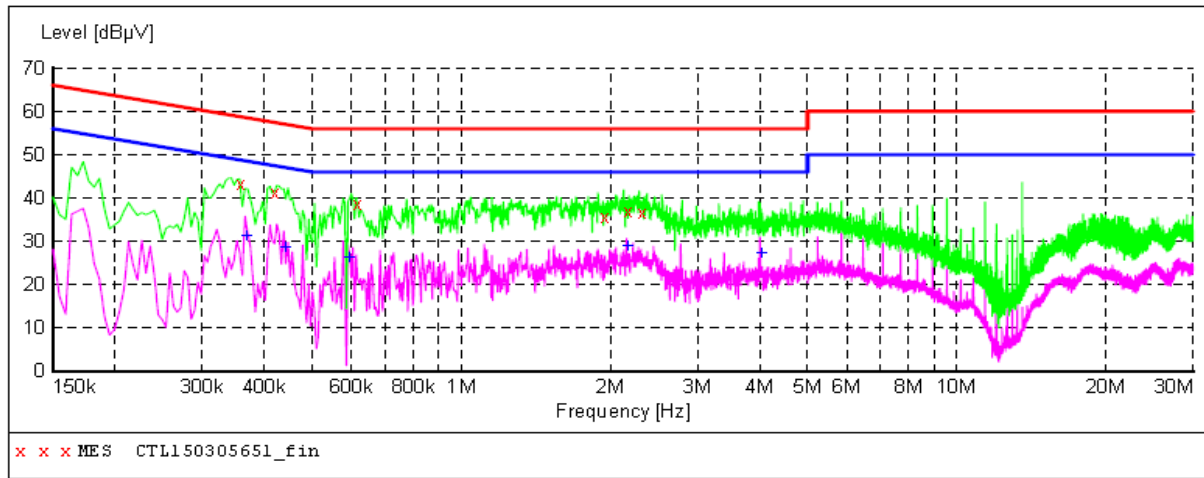

MEASUREMENT RESULT: "CTL150305651_fin"

3/5/2015 9:25AM

Frequency MHz	Level dBµV	Transd dB	Limit dBµV	Margin dB	Detector	Line	PE
0.358000	43.30	10.2	59	15.5	QP	N	GND
0.418000	41.10	10.2	58	16.4	QP	N	GND
0.614000	38.50	10.2	56	17.5	QP	N	GND
1.934000	35.50	10.3	56	20.5	QP	N	GND
2.162000	36.90	10.4	56	19.1	QP	N	GND
2.306000	36.50	10.4	56	19.5	QP	N	GND

MEASUREMENT RESULT: "CTL150305651_fin2"

3/5/2015 9:25AM

Frequency MHz	Level dBµV	Transd dB	Limit dBµV	Margin dB	Detector	Line	PE
0.366000	31.30	10.2	49	17.3	AV	N	GND
0.438000	28.80	10.2	47	18.3	AV	N	GND
0.590000	26.30	10.2	46	19.7	AV	N	GND
2.162000	29.10	10.4	46	16.9	AV	N	GND
4.010000	27.30	10.4	46	18.7	AV	N	GND

5. Test of Maximum Peak Output Power

5.1 Applicable Standard

Refer to FCC §15.247 (b), The Maximum Peak Output Power Measurement is 30dBm.

5.2 EUT Setup

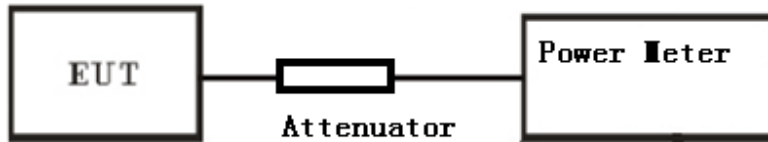

5.3 Test Equipment List and Details

See section 2.5.

5.4 Test Procedure

1. The testing follows FCC KDB Publication No.558074 v03r02(Measurement Guidance of DTS) Section 9.1.2.
2. The RF output of EUT was connected to the power meter by a low loss cable
3. Measure the power by power meter

5.5 Test Result

Temperature (°C) : 22~23	EUT: Accent 1400
Humidity (%RH) : 50~54	M/N: ACN1400
Barometric Pressure (mbar) : 950~1000	Operation Condition: Tx Mode

IEEE 802.11b mode

Channel	Channel Frequency (MHz)	Peak Power (dBm)	Peak Power Limit (dBm)	Pass / Fail
Low	2412	14.51	30	PASS
Middle	2437	14.55	30	PASS
High	2462	14.60	30	PASS

NOTE : 1. At final test to get the worst-case emission at 1Mbps.

IEEE 802.11g mode

Channel	Channel Frequency (MHz)	Peak Power (dBm)	Peak Power Limit (dBm)	Pass / Fail
Low	2412	13.36	30	PASS
Middle	2437	13.45	30	PASS
High	2462	13.76	30	PASS

NOTE : 1. At final test to get the worst-case emission at 6Mbps.

IEEE 802.11n HT20mode

Channel	Channel Frequency (MHz)	Peak Power (dBm)	Peak Power Limit (dBm)	Pass / Fail
Low	2412	11.93	30	PASS
Middle	2437	11.98	30	PASS
High	2462	12.22	30	PASS

NOTE : 1. At final test to get the worst-case emission at 13Mbps.

IEEE 802.11n HT40mode

Channel	Channel Frequency (MHz)	Peak Power (dBm)	Peak Power Limit (dBm)	Pass / Fail
Low	2422	11.04	30	PASS
Middle	2437	10.98	30	PASS
High	2452	10.96	30	PASS

NOTE : 1. At final test to get the worst-case emission at 13Mbps.

6. Test of Peak Power Spectral Density

6.1 Applicable Standard

Refer to FCC §15.247 (e).

The power spectral density conducted from the transmitter to the antenna shall not be greater than 8 dBm in any 3 kHz band during any time interval of continuous transmission.

6.2 EUT Setup

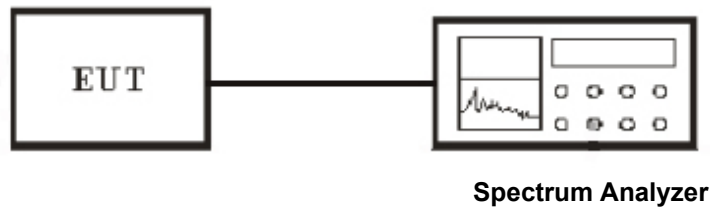

6.3 Test Equipment List and Details

See section 2.5.

6.4 Test Procedure

The transmitter output was connected to the spectrum analyzer and the parameter was set as below:

1. Set analyzer center frequency to DTS channel center frequency.
2. Set the span to 1.5 times the DTS channel bandwidth.
3. Set the RBW \geq 3 kHz.
4. Set the VBW \geq 3 x RBW.
5. Detector = peak.
6. Sweep time = auto couple.
7. Trace mode = max hold.
8. Allow trace to fully stabilize.
9. Use the peak marker function to determine the maximum amplitude level.
10. If measured value exceeds limit, reduce RBW (no less than 3 kHz) and repeat.

6.5 Test Result

Temperature (°C) : 22~23	EUT: Accent 1400
Humidity (%RH) : 50~54	M/N: ACN1400
Barometric Pressure (mbar) : 950~1000	Operation Condition: Tx Mode

IEEE 802.11b mode

Channel	Channel Frequency (MHz)	RF Power Level in 100KHz RBW (dBm)	Correct Factor 100KHz to 3KHz (dB)	Final RF Power Level in 3KHz RBW (dBm)	Maximum Limit (dBm)	Pass / Fail
Low	2412	3.30	-15.22	-11.92	8	PASS
Middle	2437	2.35	-15.22	-12.87	8	PASS
High	2462	2.70	-15.22	-12.52	8	PASS

NOTE : 1. At final test to get the worst-case emission at 1Mbps.

IEEE 802.11 g mode

Channel	Channel Frequency (MHz)	RF Power Level in 100KHz RBW (dBm)	Correct Factor 100KHz to 3KHz (dB)	Final RF Power Level in 3KHz RBW (dBm)	Maximum Limit (dBm)	Pass / Fail
Low	2412	-7.90	-15.22	-23.12	8	PASS
Middle	2437	-7.84	-15.22	-23.06	8	PASS
High	2462	-7.15	-15.22	-22.37	8	PASS

NOTE : 1. At final test to get the worst-case emission at 6Mbps.

IEEE 802.11nHT20 mode

Channel	Channel Frequency (MHz)	RF Power Level in 100KHz RBW (dBm)	Correct Factor 100KHz to 3KHz (dB)	Final RF Power Level in 3KHz RBW (dBm)	Maximum Limit (dBm)	Pass / Fail
Low	2412	-8.22	-15.22	-23.44	8	PASS
Middle	2437	-7.56	-15.22	-22.78	8	PASS
High	2462	-7.02	-15.22	-22.24	8	PASS

NOTE : 1. At final test to get the worst-case emission at 13Mbps.

IEEE 802.11nHT40 mode

Channel	Channel Frequency (MHz)	RF Power Level in 100KHz RBW (dBm)	Correct Factor 100KHz to 3KHz (dB)	Final RF Power Level in 3KHz RBW (dBm)	Maximum Limit (dBm)	Pass / Fail
Low	2422	-10.71	-15.22	-25.93	8	PASS
Middle	2437	-11.66	-15.22	-26.88	8	PASS
High	2452	-11.05	-15.22	-26.27	8	PASS

NOTE : 1. At final test to get the worst-case emission at 13Mbps.

POWER SPECTRAL DENSITY (802.11b MODE CH Low)

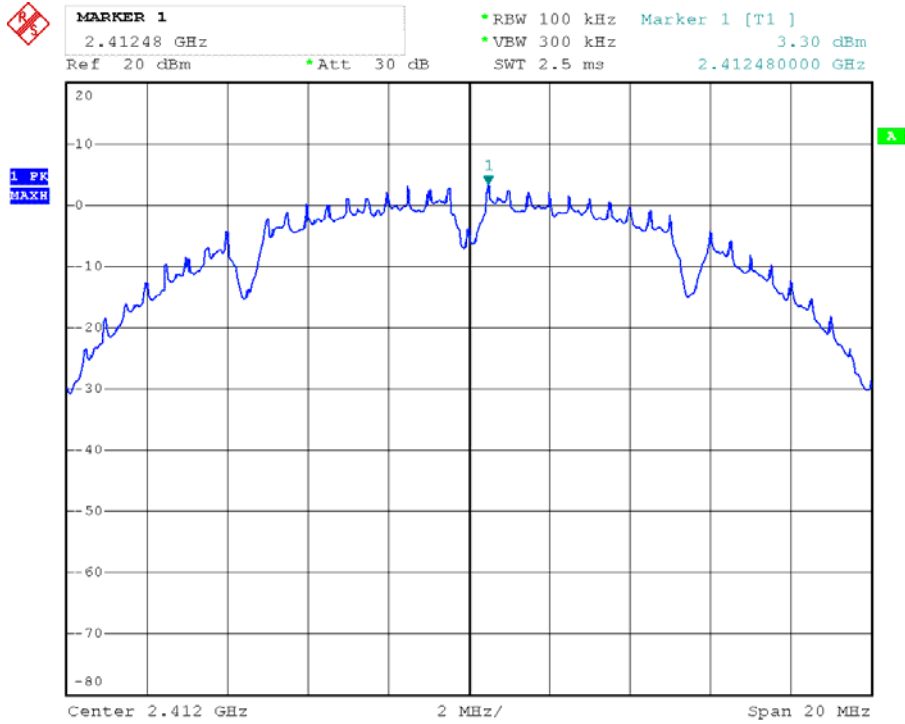

POWER SPECTRAL DENSITY (802.11b MODE CH Mid)

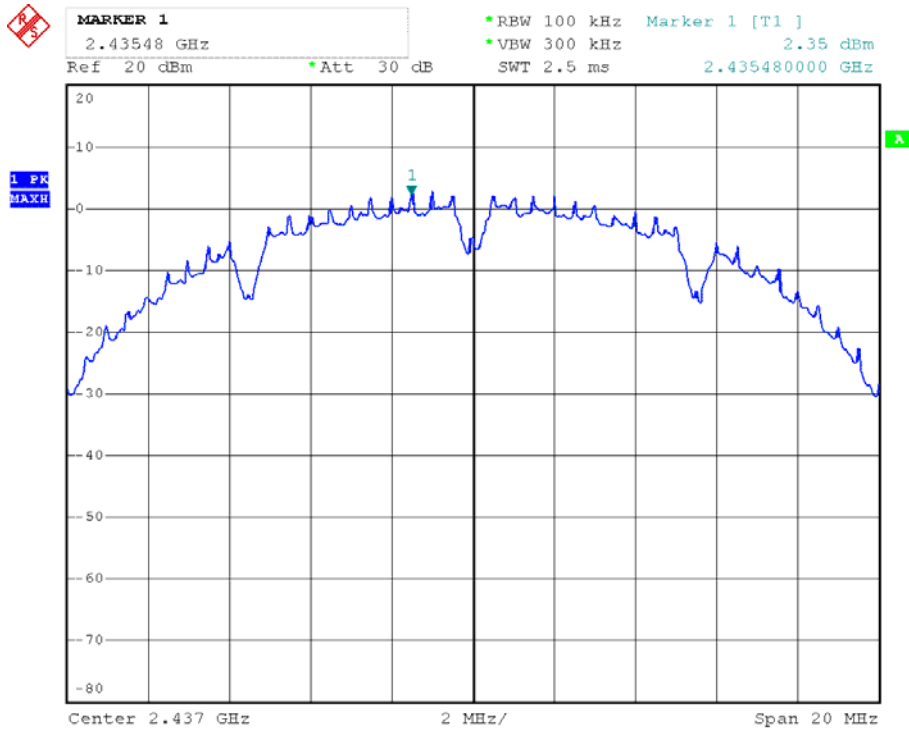

POWER SPECTRAL DENSITY (802.11b MODE CH High)

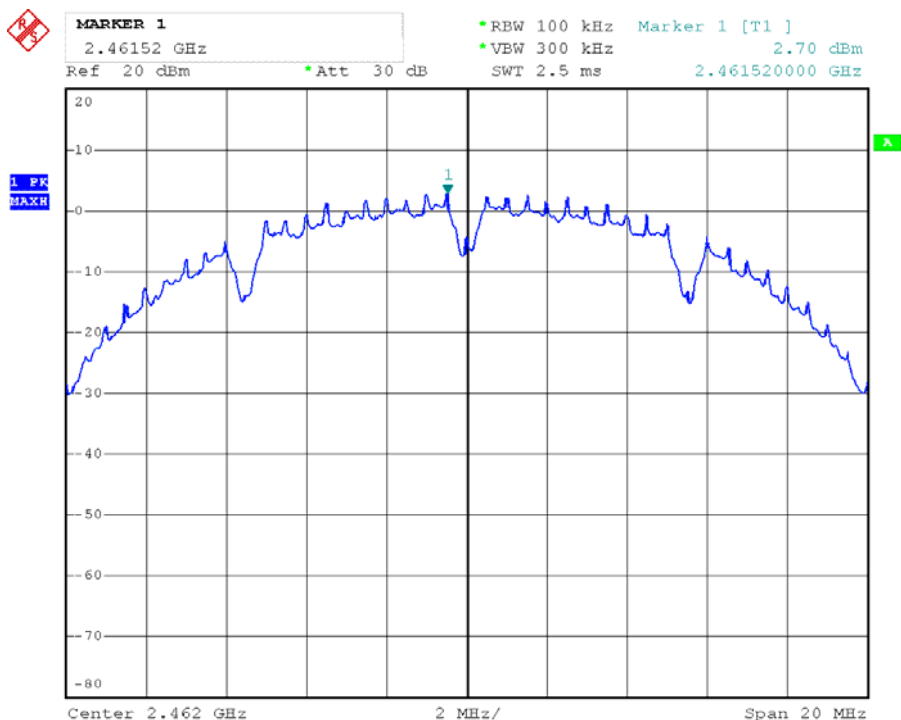

POWER SPECTRAL DENSITY (802.11g MODE CH Low)

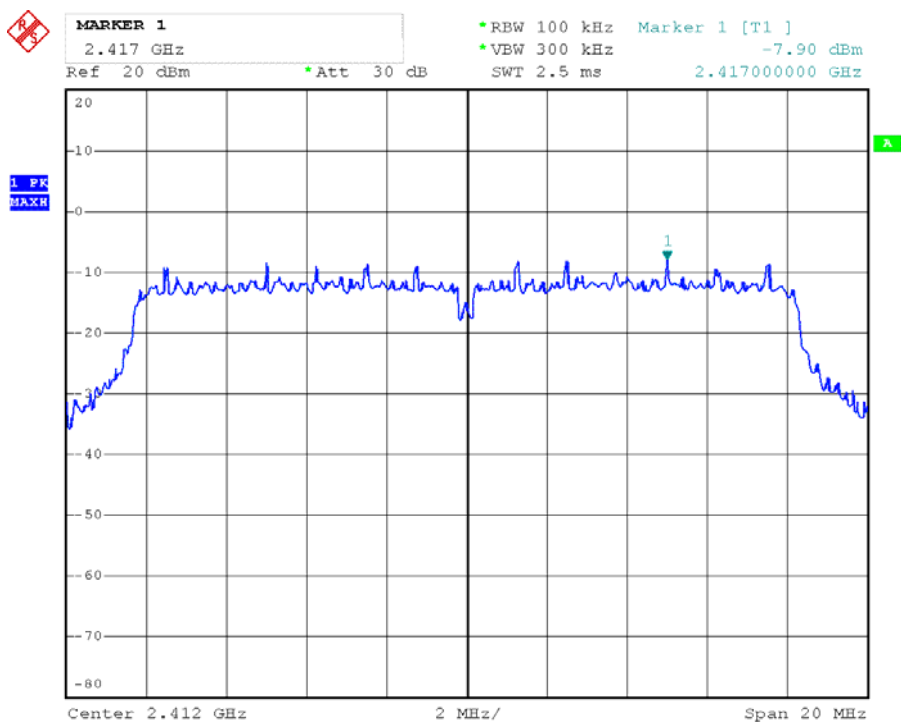

POWER SPECTRAL DENSITY (802.11g MODE CH Mid)

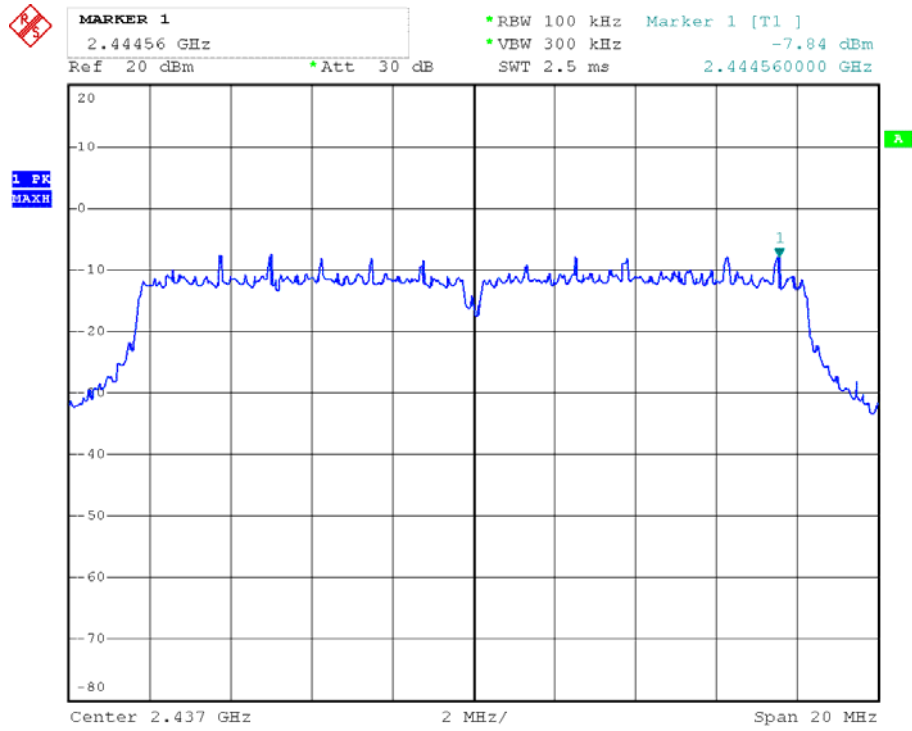

POWER SPECTRAL DENSITY (802.11g MODE CH High)

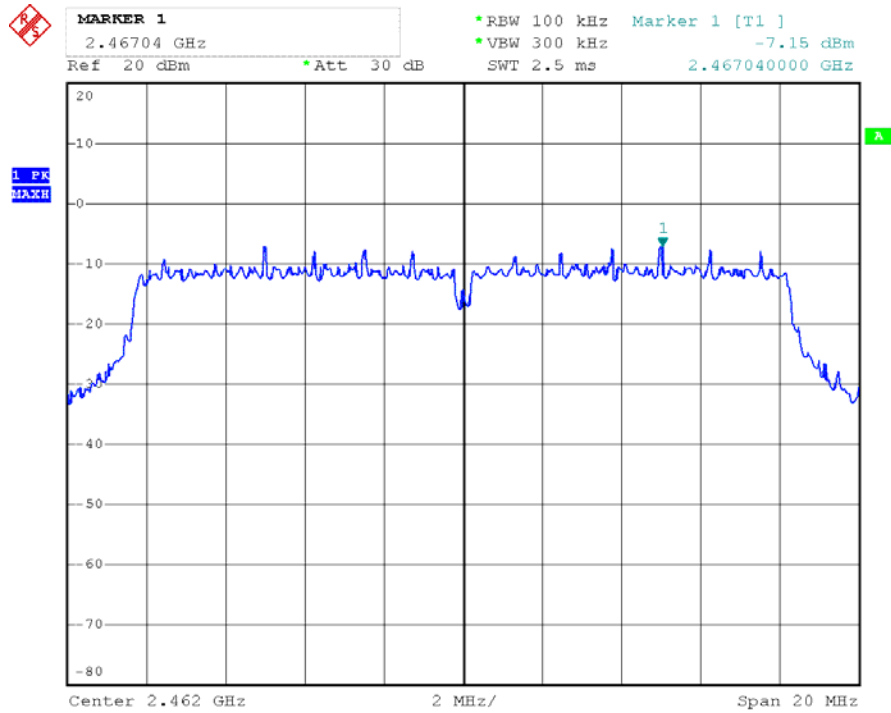

POWER SPECTRAL DENSITY (802.11nHT20 MODE CH Low)

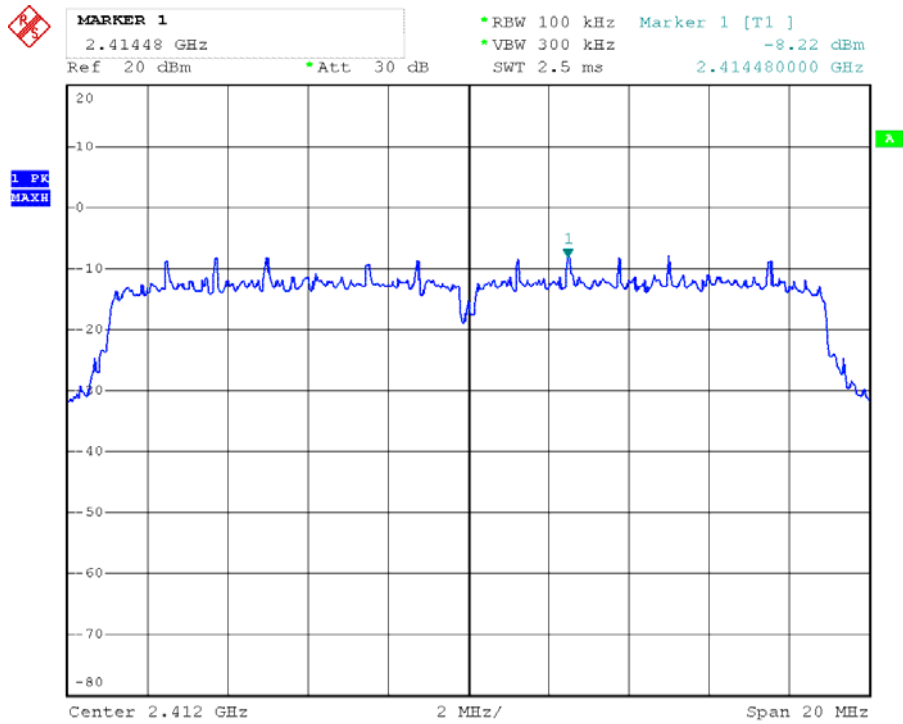

POWER SPECTRAL DENSITY (802.11nHT20 MODE CH Mid)

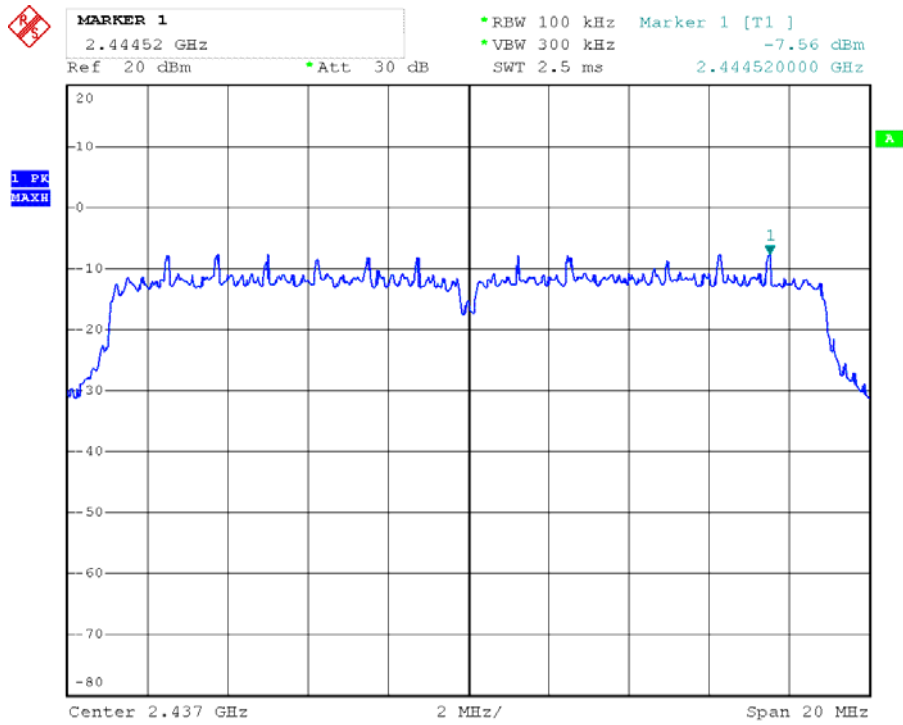

POWER SPECTRAL DENSITY (802.11nHT20 MODE CH High)

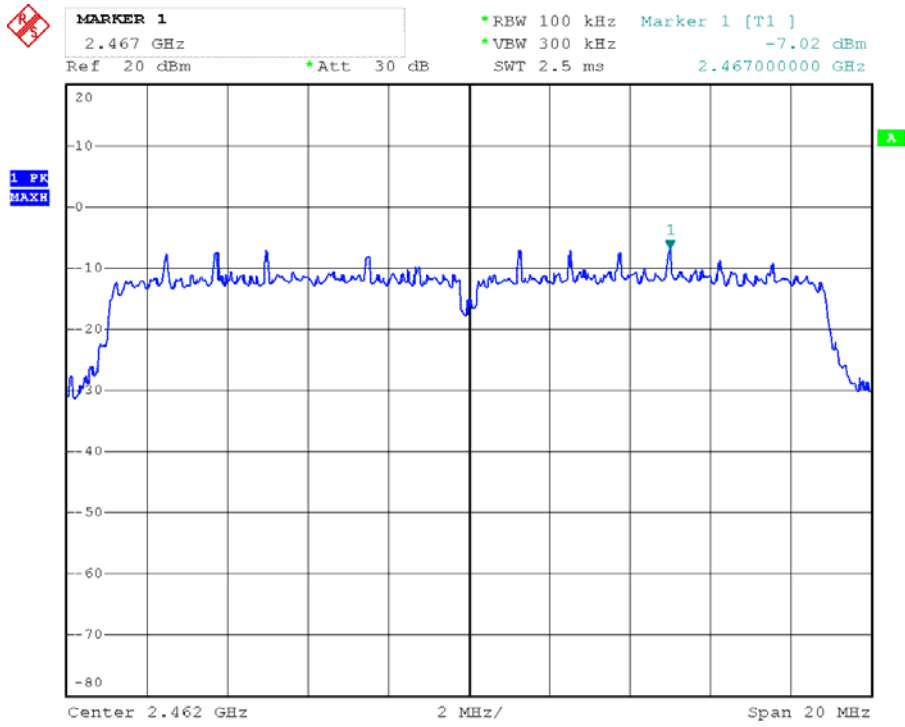

POWER SPECTRAL DENSITY (802.11nHT40 MODE CH Low)

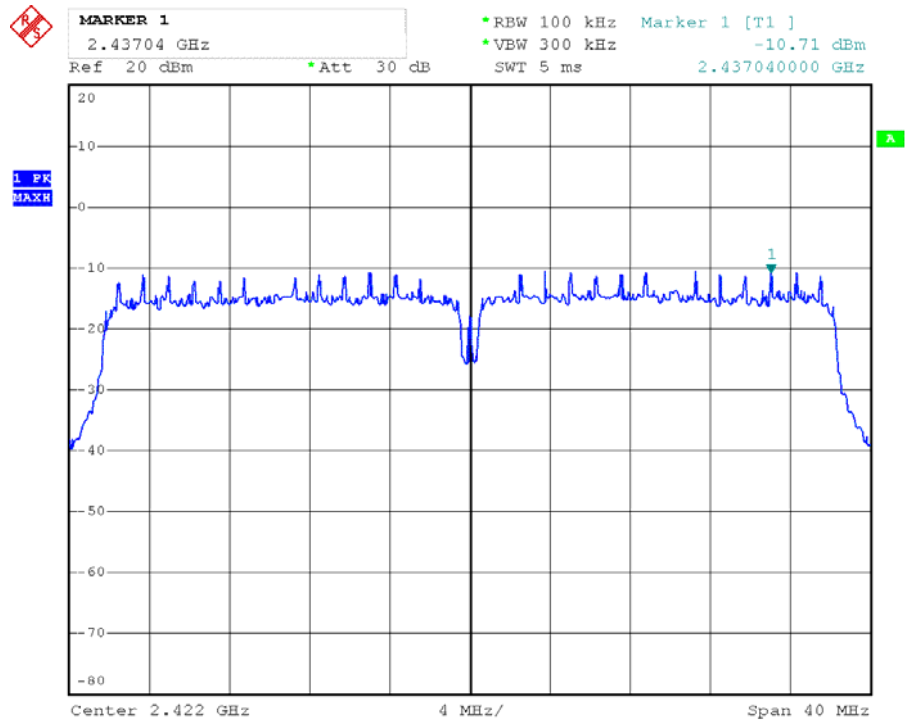

POWER SPECTRAL DENSITY (802.11nHT40 MODE CH Mid)

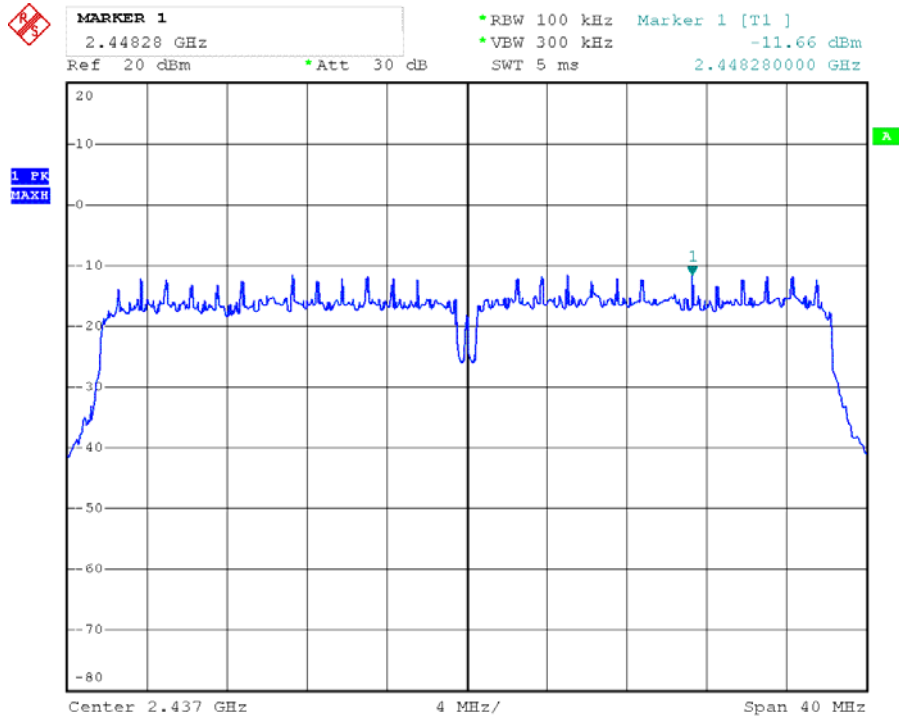

POWER SPECTRAL DENSITY (802.11nHT40 MODE CH High)

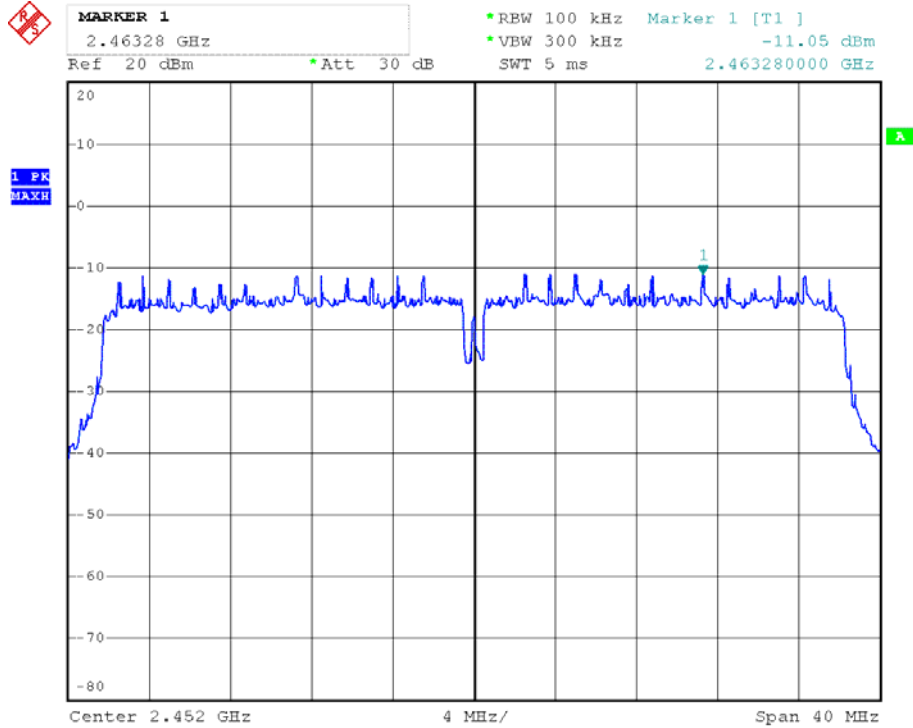

7. Test of 6dB Bandwidth

7.1 Applicable Standard

Refer to FCC §15.247 (a) (2) .

The minimum 6 dB bandwidth shall be at least 500 kHz.

7.2 EUT Setup

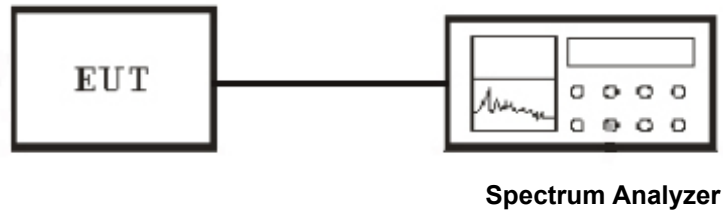

7.3 Test Equipment List and Details

See section 2.5.

7.4 Test Procedure

The 6dB bandwidth is defined as the total spectrum the power of which is higher than peak power minus 6dB. The transmitter output was connected to a spectrum analyzer and the parameter was set as below:

1. Set resolution bandwidth (RBW) = 1-5% or DTS BW, not to exceed 100 kHz.
2. Set the video bandwidth (VBW) $\geq 3 \times$ RBW.
3. Detector = Peak.
4. Trace mode = max hold.
5. Sweep = auto couple.
6. Allow the trace to stabilize.
7. Measure the maximum width of the emission that is constrained by the frequencies associated with the two outermost amplitude points (upper and lower) that are attenuated by 6 dB relative to the maximum level measured in the fundamental emission.

7.5 Test Result

Temperature (°C) : 22~23	EUT: Accent 1400
Humidity (%RH) : 50~54	M/N: ACN1400
Barometric Pressure (mbar) : 950~1000	Operation Condition: Tx Mode

IEEE 802.11b mode

Channel	Channel Frequency (MHz)	6dB Bandwidth (MHz)	Minimum Limit (kHz)	Pass / Fail
Low	2412	10.24	500	PASS
Middle	2437	10.24	500	PASS
High	2462	10.24	500	PASS

NOTE : 1. At final test to get the worst-case emission at 1Mbps.

IEEE 802.11g mode

Channel	Channel Frequency (MHz)	6dB Bandwidth (MHz)	Minimum Limit (kHz)	Pass / Fail
Low	2412	16.48	500	PASS
Middle	2437	16.48	500	PASS
High	2462	16.64	500	PASS

NOTE : 1. At final test to get the worst-case emission at 6Mbps.

IEEE 802.11n HT20 mode

Channel	Channel Frequency (MHz)	6dB Bandwidth (MHz)	Minimum Limit (kHz)	Pass / Fail
Low	2412	17.76	500	PASS
Middle	2437	17.76	500	PASS
High	2462	17.76	500	PASS

NOTE : 1. At final test to get the worst-case emission at 13Mbps.

IEEE 802.11n HT40 mode

Channel	Channel Frequency (MHz)	6dB Bandwidth (MHz)	Minimum Limit (kHz)	Pass / Fail
Low	2422	36.16	500	PASS
Middle	2437	36.48	500	PASS
High	2452	36.48	500	PASS

NOTE : 1. At final test to get the worst-case emission at 13Mbps.

6dB BANDWIDTH (802.11b MODE CH Low)

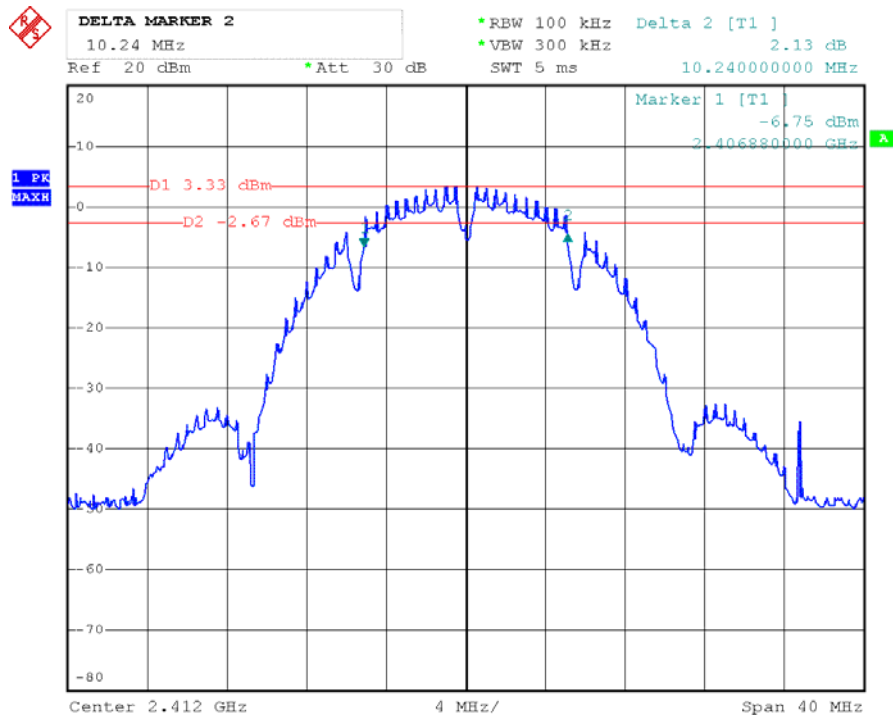

6dB BANDWIDTH (802.11b MODE CH Mid)

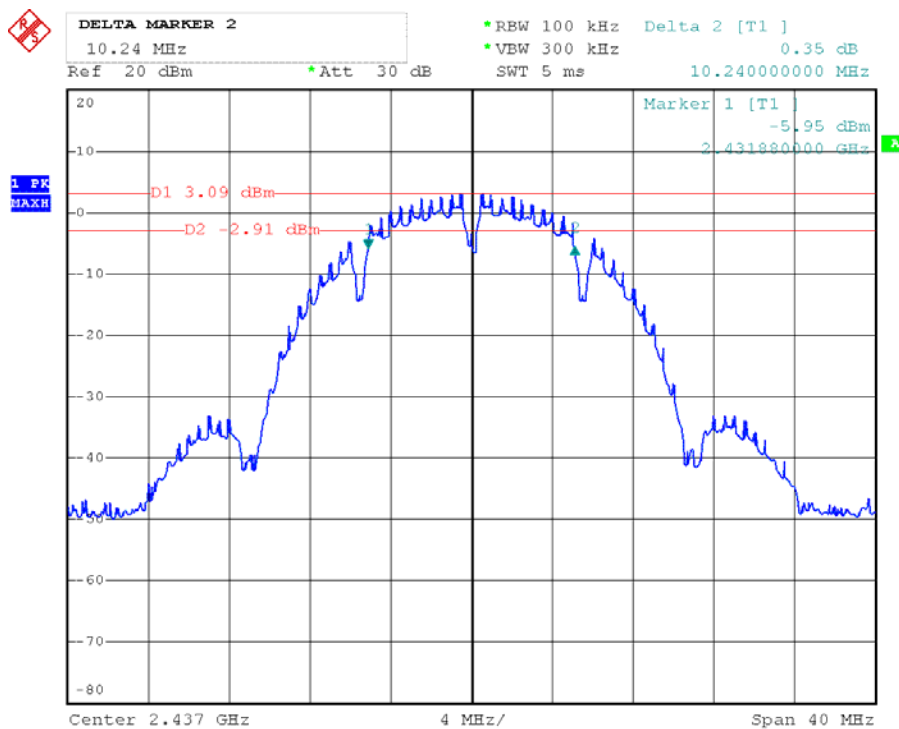

6dB BANDWIDTH (802.11b MODE CH High)

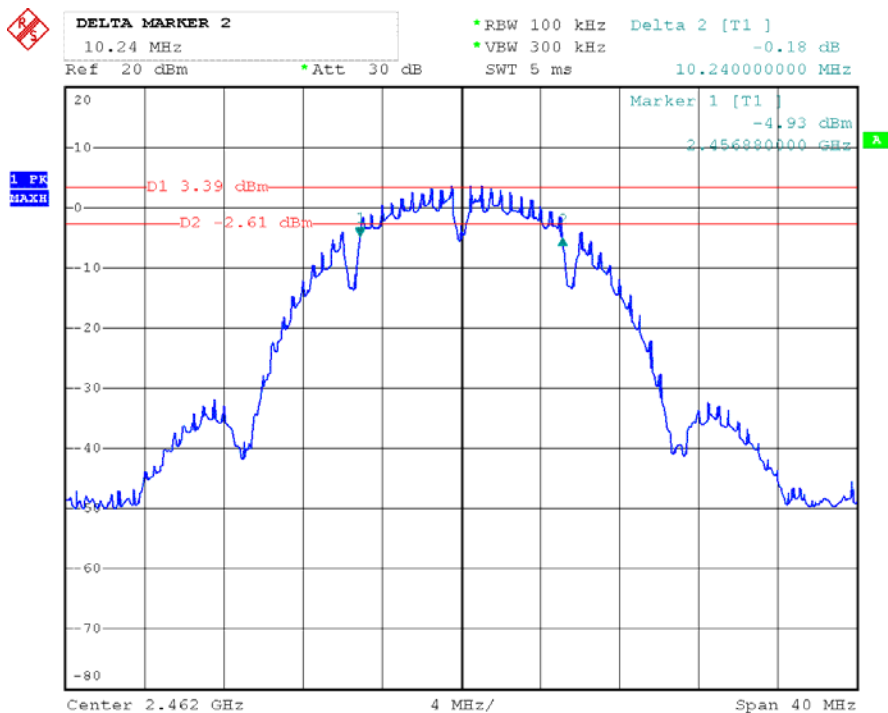

6dB BANDWIDTH (802.11g MODE CH Low)

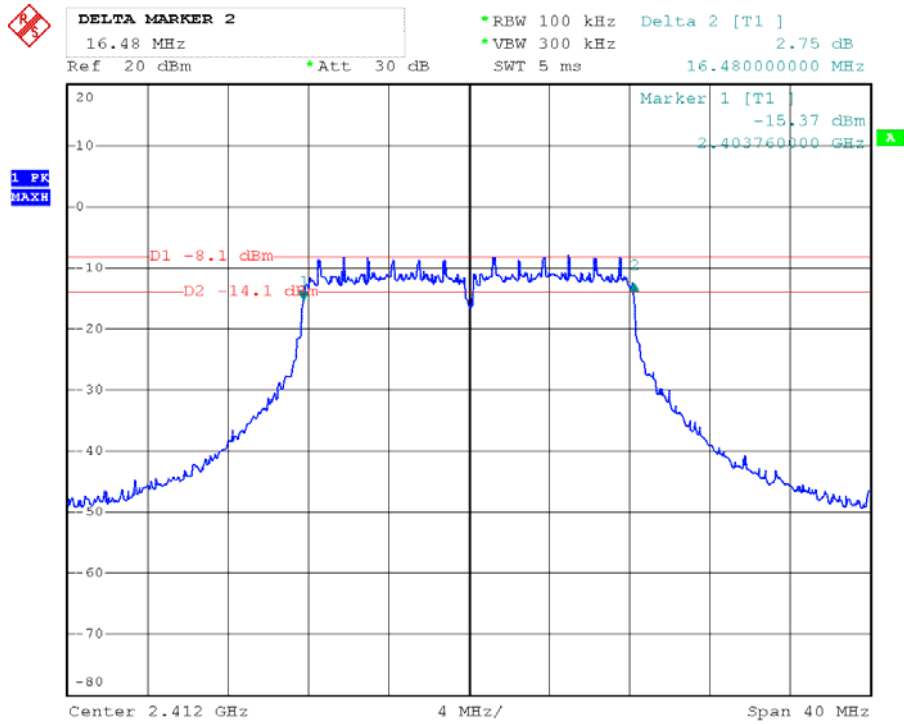

6dB BANDWIDTH (802.11g MODE CH Mid)

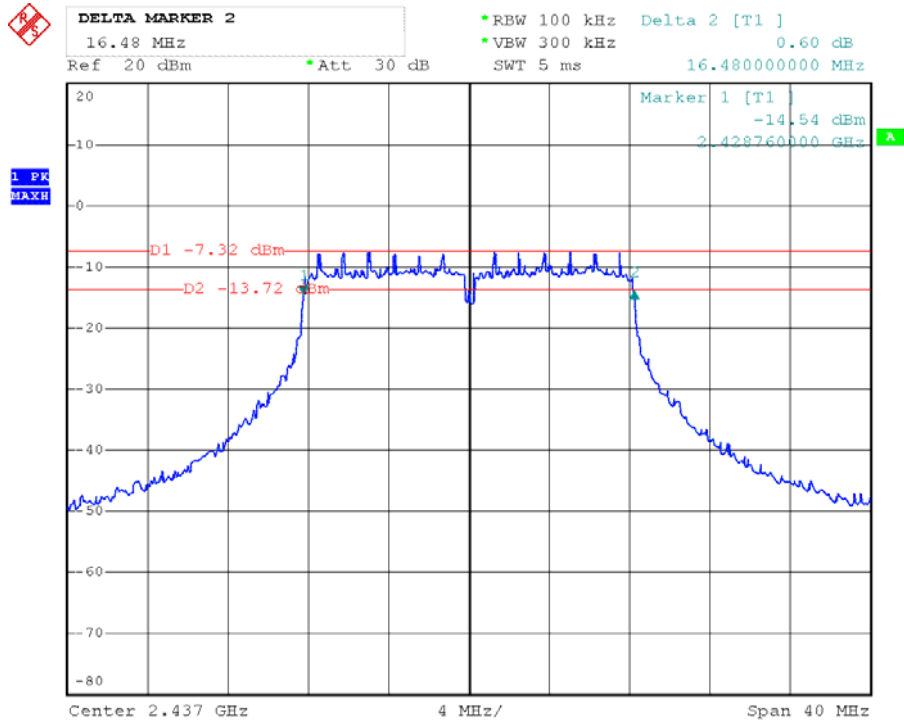

6dB BANDWIDTH (802.11g MODE CH High)

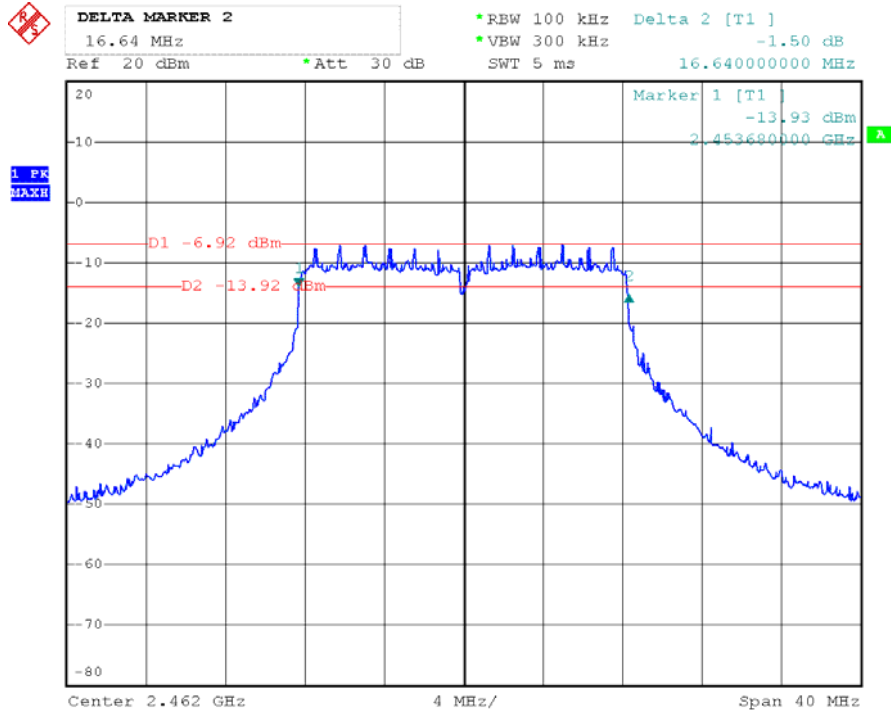

6dB BANDWIDTH (802.11n HT20 MODE CH Low)

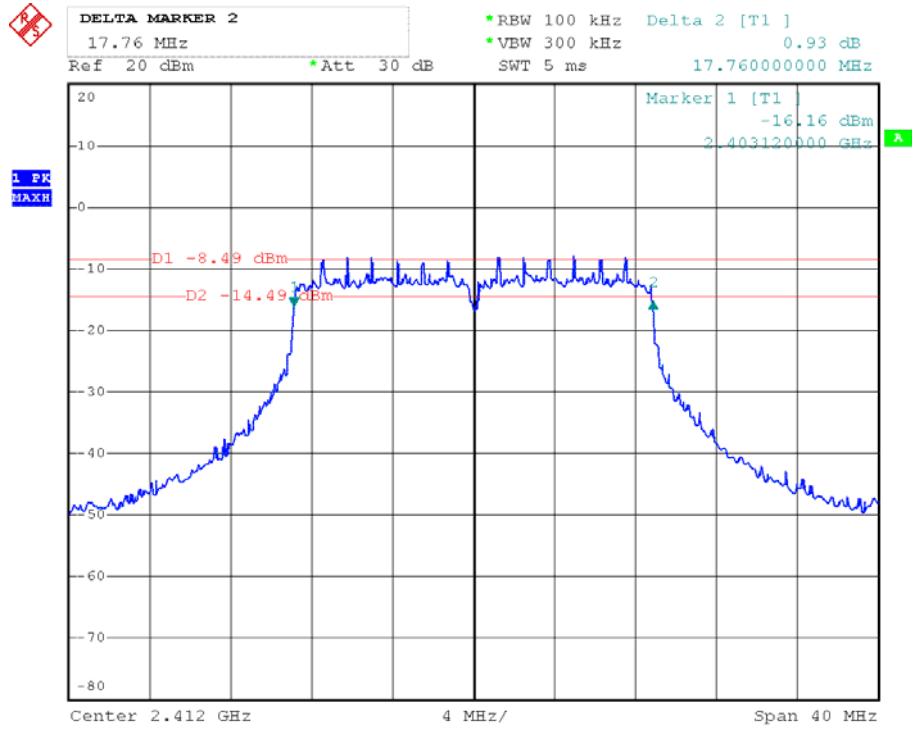

6dB BANDWIDTH (802.11n HT20 MODE CH Mid)

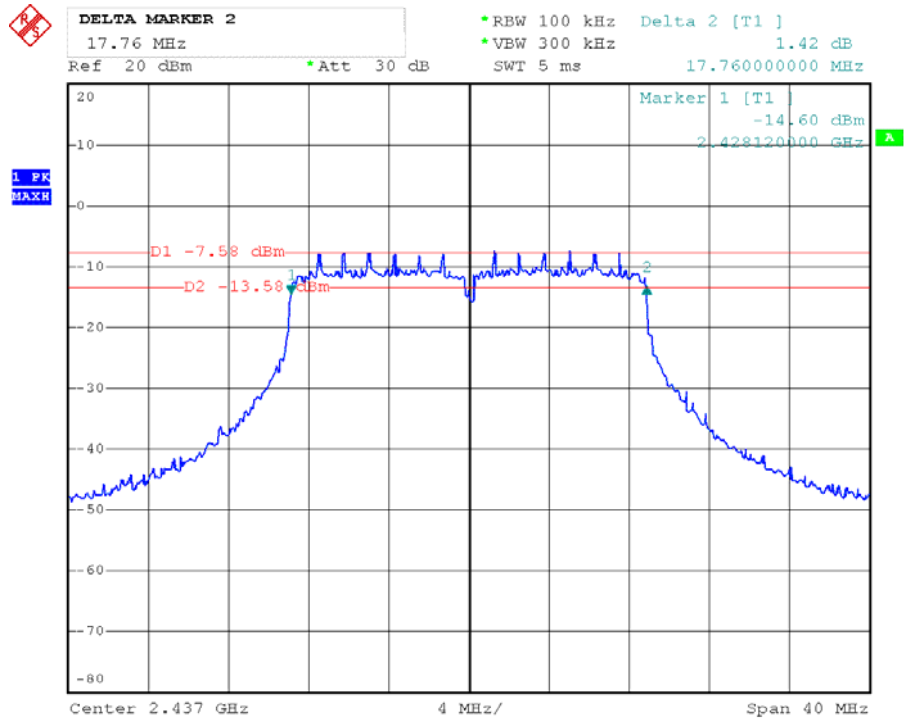

6dB BANDWIDTH (802.11n HT20 MODE CH High)

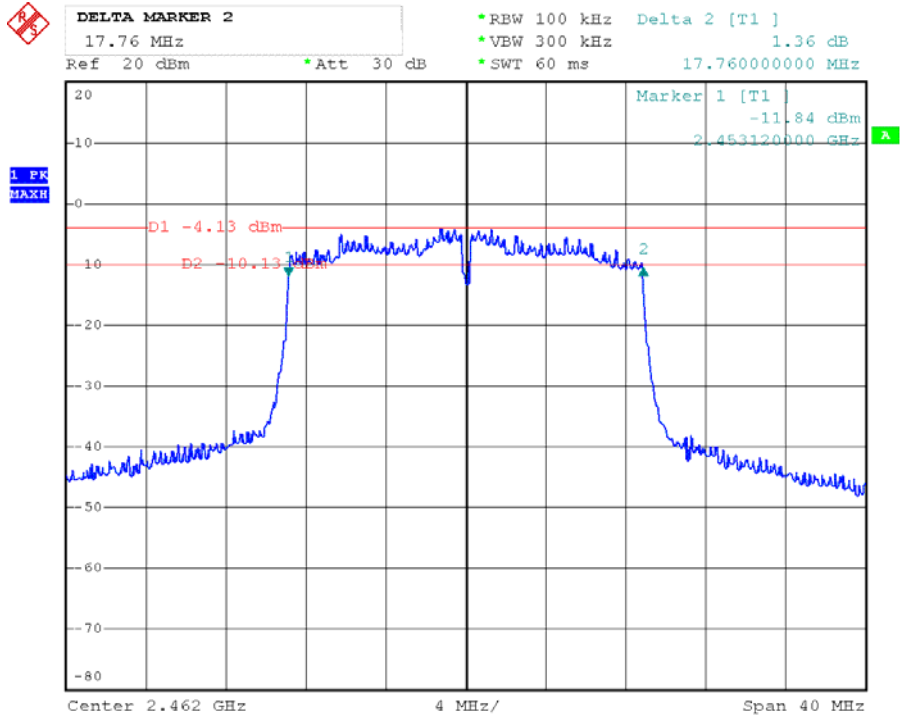

6dB BANDWIDTH (802.11n HT40 MODE CH Low)

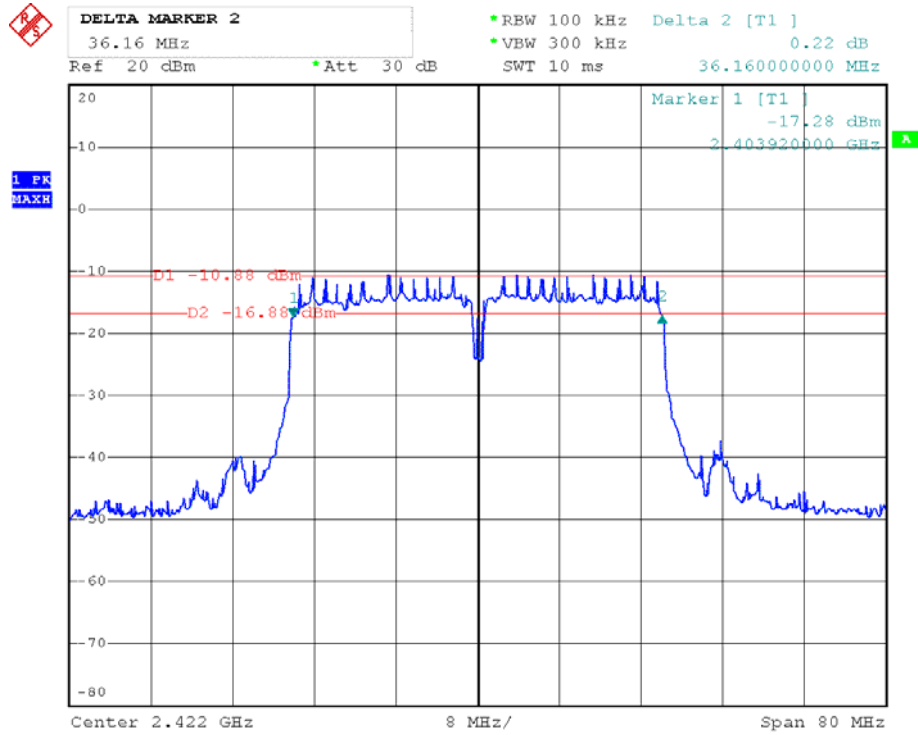

6dB BANDWIDTH (802.11n HT40 MODE CH Mid)

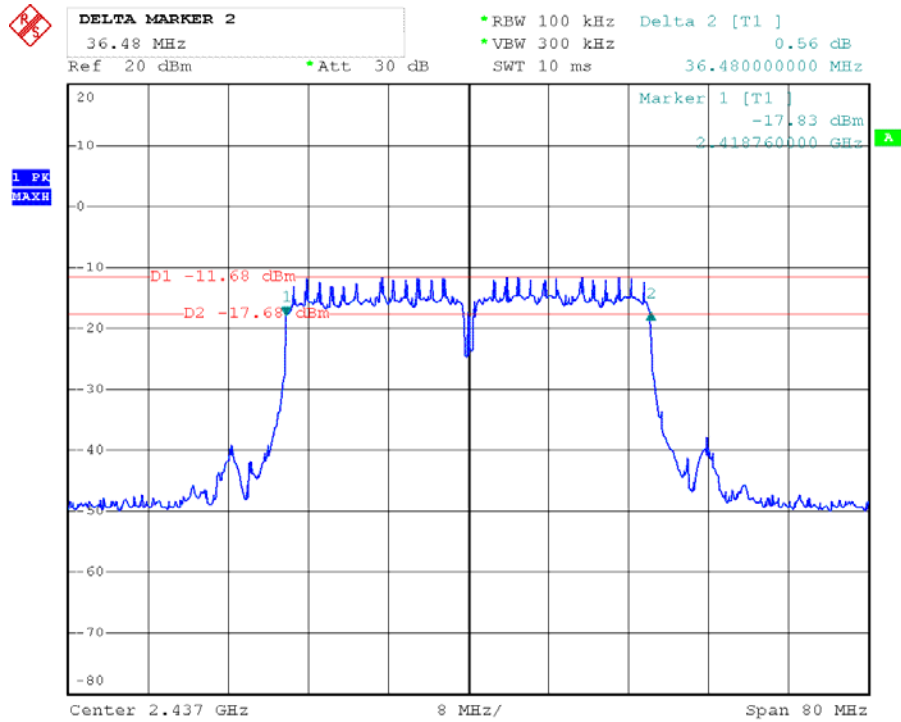

6dB BANDWIDTH (802.11n HT40 MODE CH High)

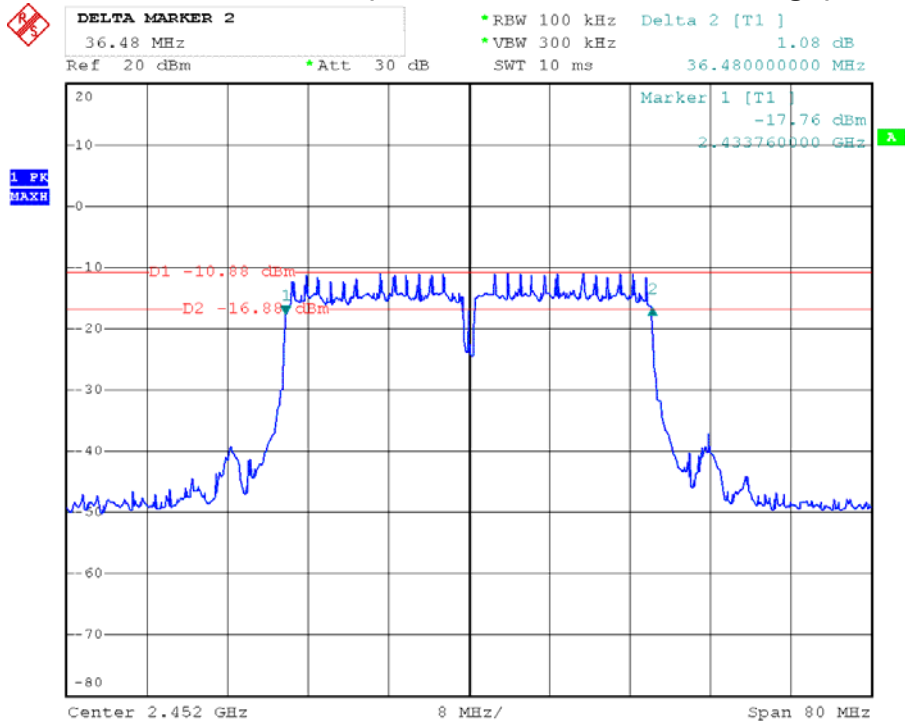

8. Test of Conducted Spurious Emission

8.1 Applicable Standard

Refer to FCC §15.247 (d)

Output power was measured based on the use of RMS averaging over a time interval, therefore the required attenuation is 30 dB.

8.2 EUT Setup

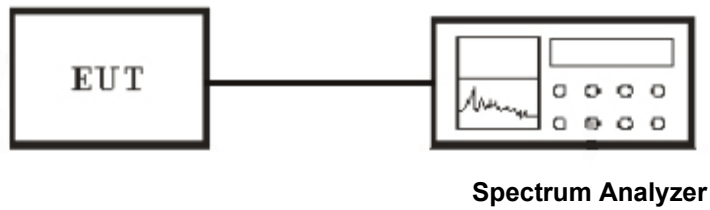

8.3 Test Equipment List and Details

See section 2.5.

8.4 Test Procedure

The transmitter output was connected to a spectrum analyzer. The spectrum from 30 MHz to 26.5 GHz is investigated with the transmitter set to the lowest, middle, and highest channels in the 2.4 GHz band. The parameter of the spectrum analyzer was set as below:

1. Set start frequency to DTS channel edge frequency.
2. Set stop frequency so as to encompass the spectrum to be examined.
3. Set RBW = 100 kHz.
4. Set VBW \geq 300 kHz.
5. Detector = peak.
6. Trace Mode = max hold.
7. Sweep = auto couple.
8. Allow the trace to stabilize (this may take some time, depending on the extent of the span).
9. Use peak marker function to determine maximum amplitude of all unwanted emissions within any 100 kHz bandwidth.

8.5 Test Result

Temperature (°C) : 22~23	EUT: Accent 1400
Humidity (%RH) : 50~54	M/N: ACN1400
Barometric Pressure (mbar) : 950~1000	Operation Condition: TX Mode

IEEE 802.11b mode

CH Low

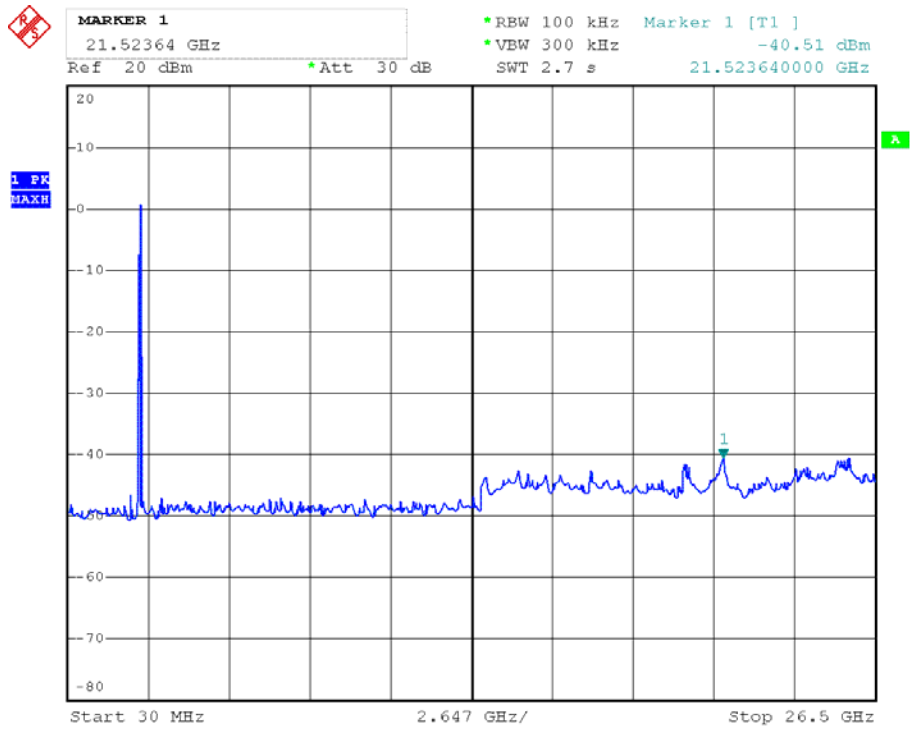

CH Mid

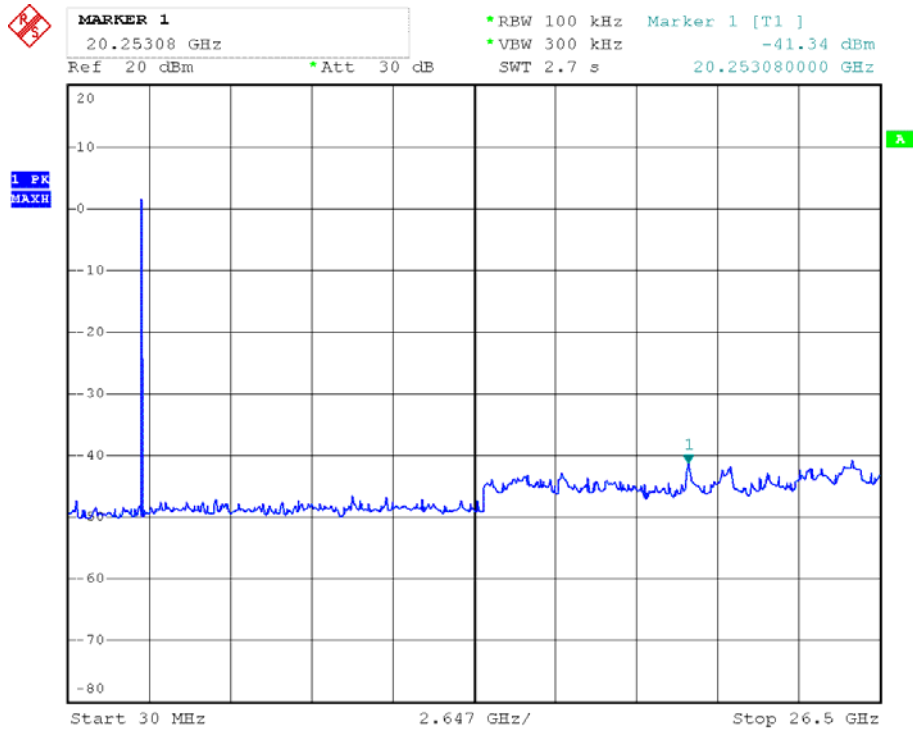

CH High

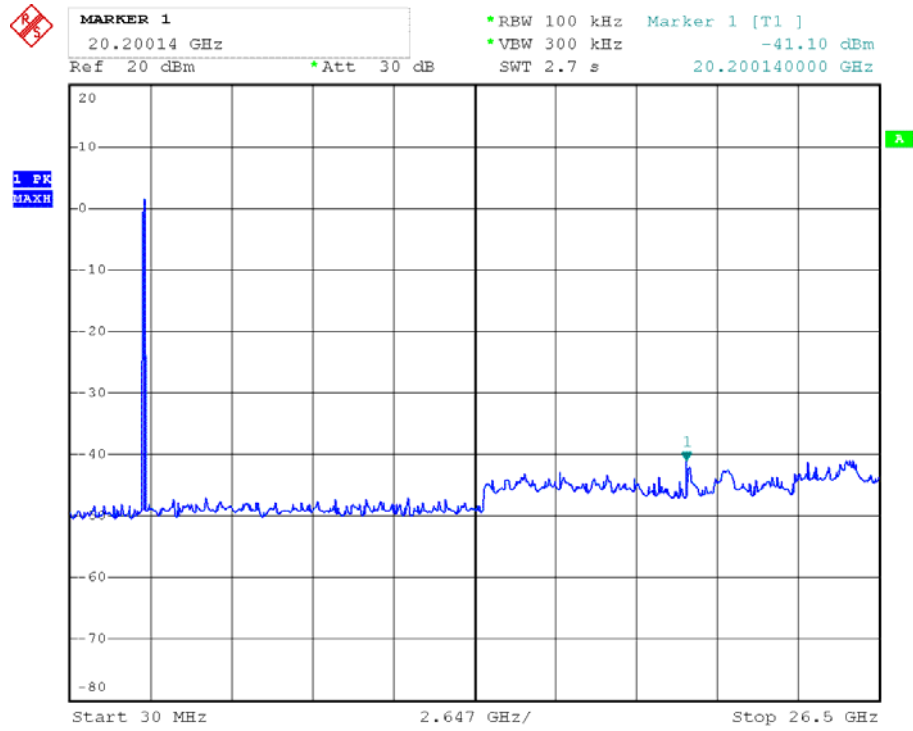

IEEE 802.11g mode
CH Low

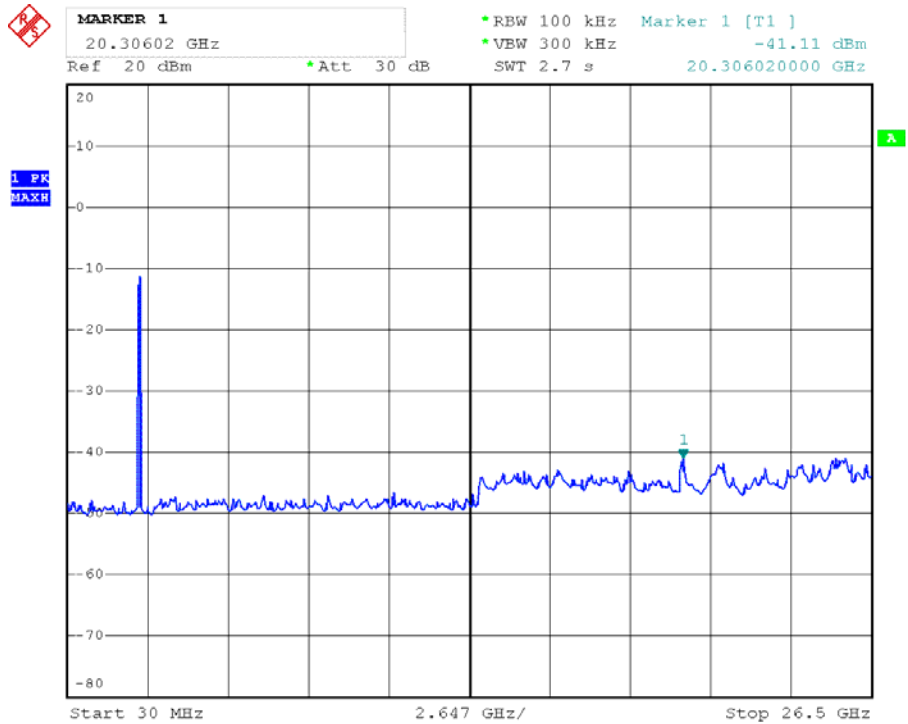

CH Mid

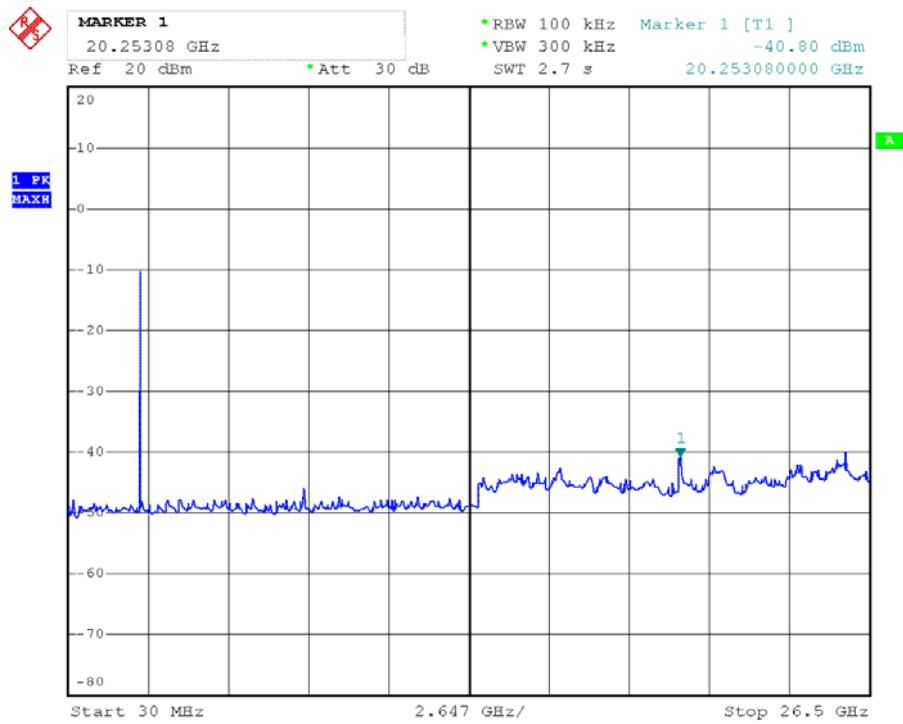

CH High

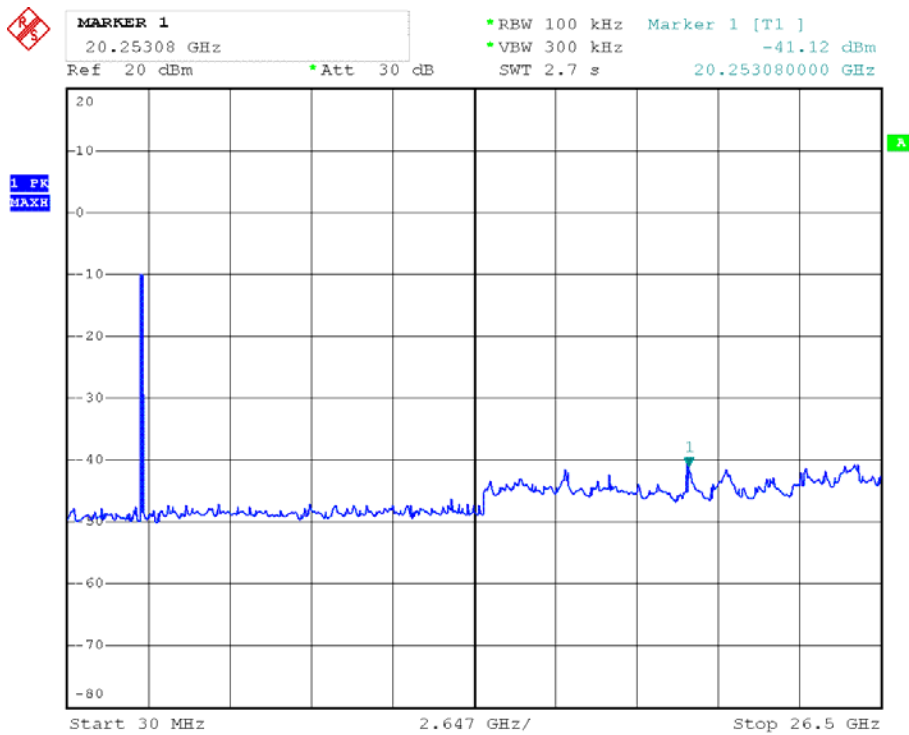

IEEE 802.11n HT20 mode
CH Low

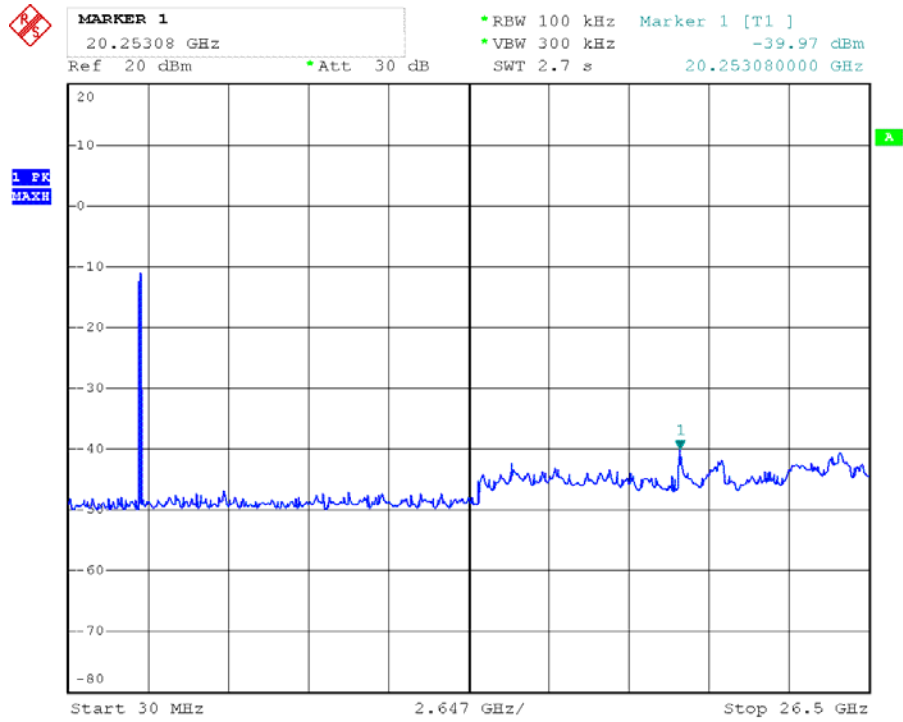

CH Mid

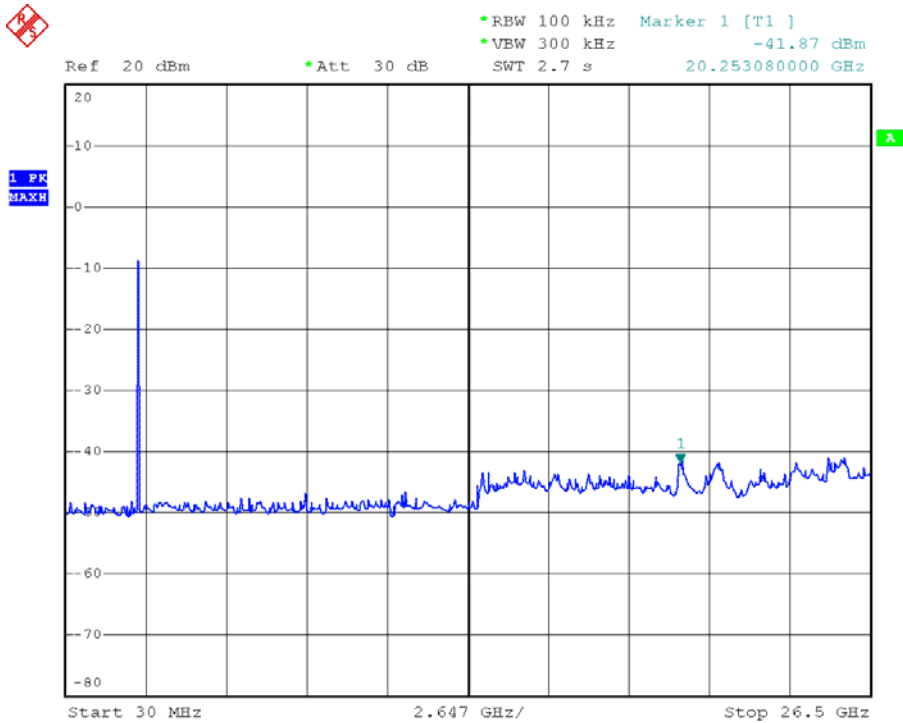

CH High

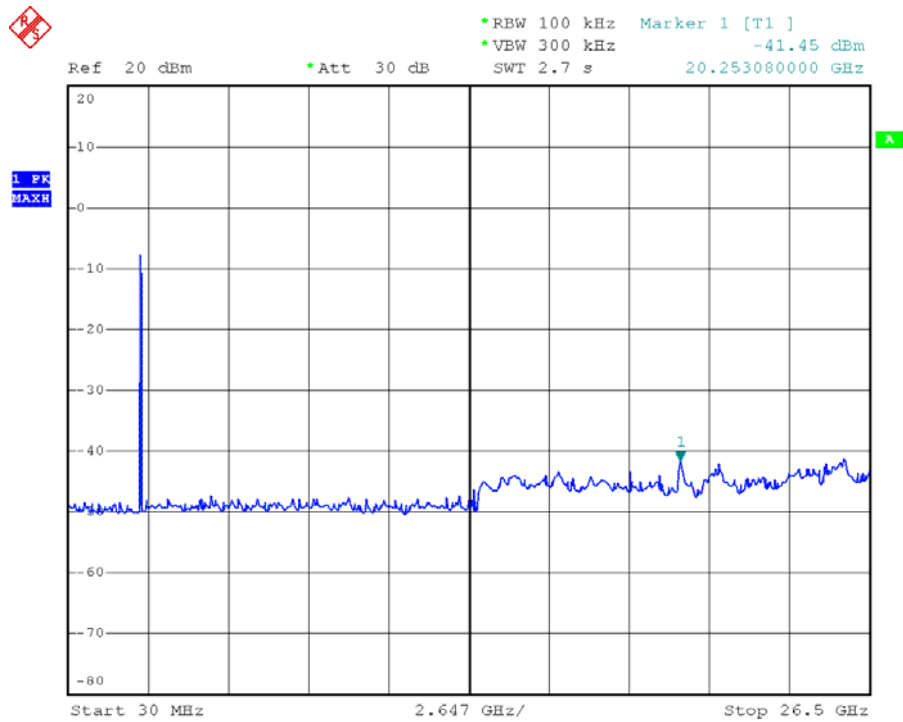

IEEE 802.11n HT40 mode
CH Low

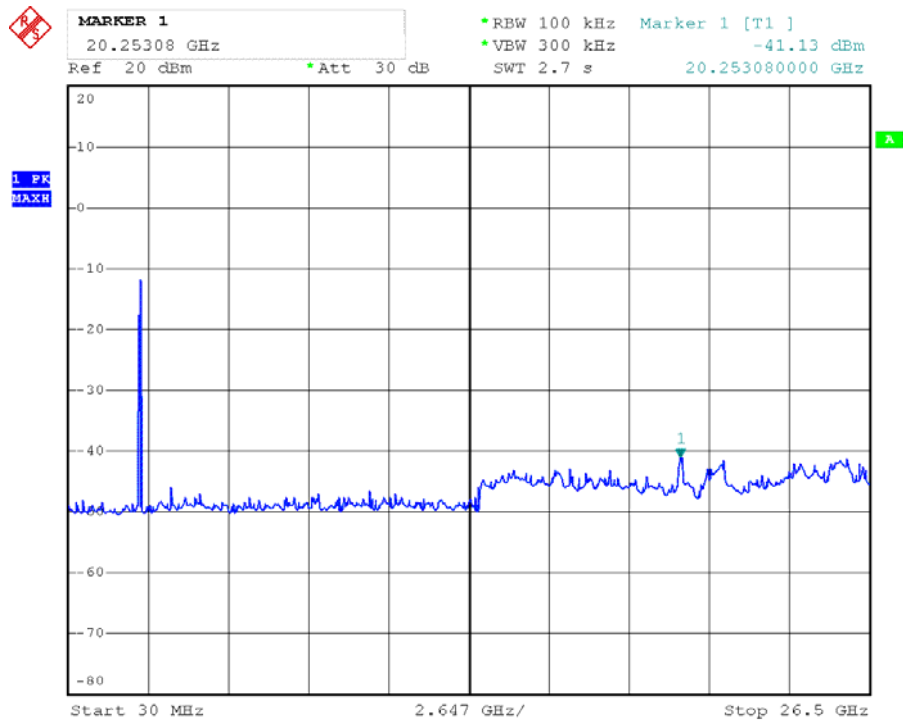

CH Mid

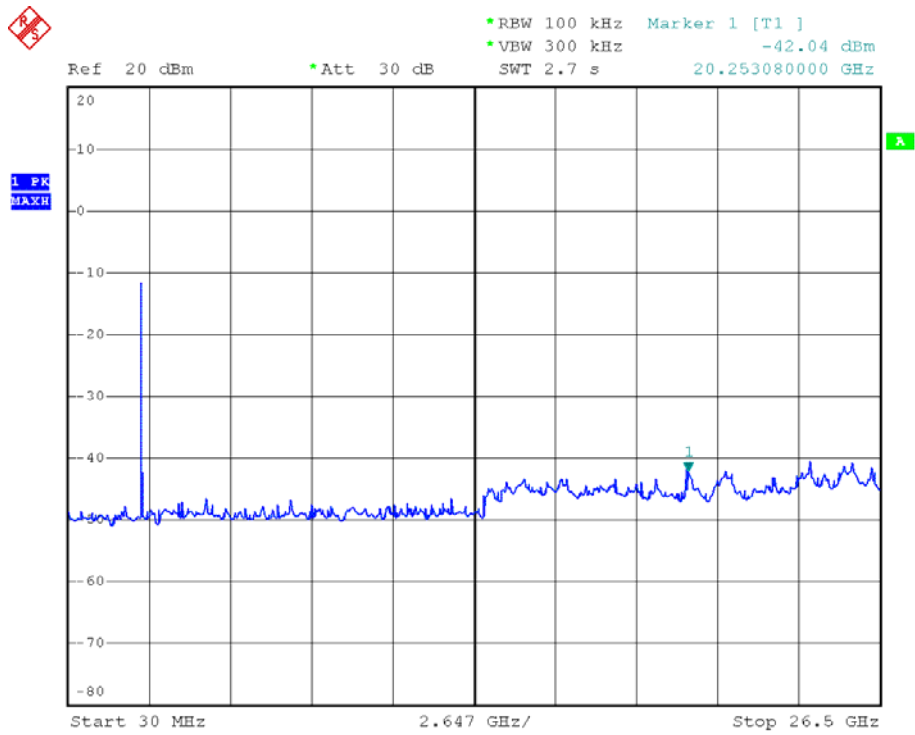

CH High

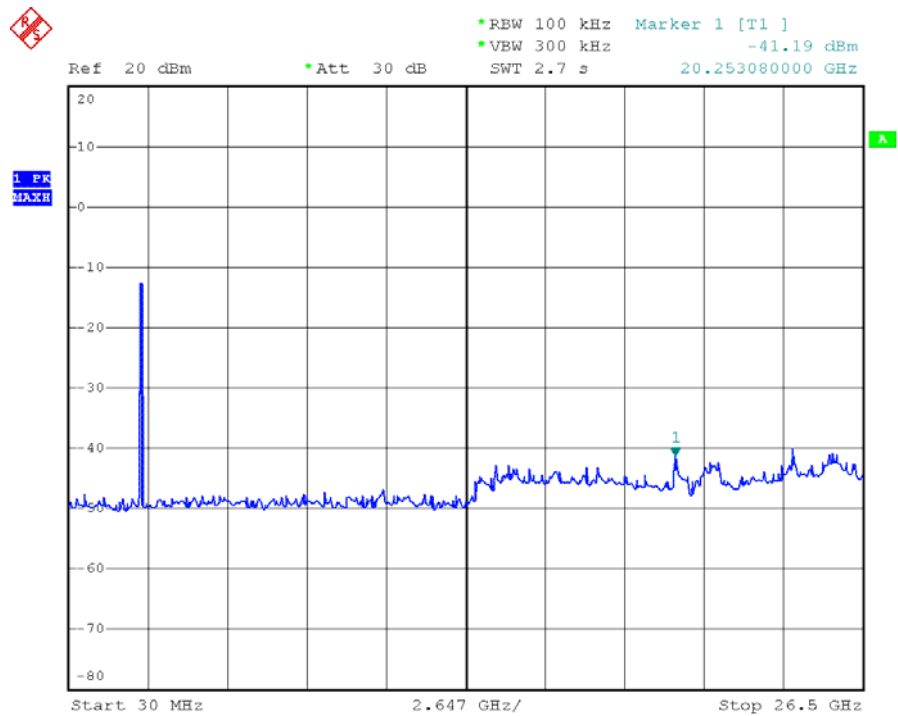

9. Test of Radiated Spurious Emission

9.1 Radiated Spurious Emission

9.1.1 Limits

15.205 (a) Except as shown in paragraph (d) of this section, only spurious emissions are permitted in any of the frequency bands listed below:

MHz	MHz	MHz	GHz
0.090 - 0.110	16.42 - 16.423	399.9 - 410	4.5 - 5.15
¹ 0.495 - 0.505	16.69475 - 16.69525	608 - 614	5.35 - 5.46
2.1735 - 2.1905	16.80425 - 16.80475	960 - 1240	7.25 - 7.75
4.125 - 4.128	25.5 - 25.67	1300 - 1427	8.025 - 8.5
4.17725 - 4.17775	37.5 - 38.25	1435 - 1626.5	9.0 - 9.2
4.20725 - 4.20775	73 - 74.6	1645.5 - 1646.5	9.3 - 9.5
6.215 - 6.218	74.8 - 75.2	1660 - 1710	10.6 - 12.7
6.26775 - 6.26825	108 - 121.94	1718.8 - 1722.2	13.25 - 13.4
6.31175 - 6.31225	123 - 138	2200 - 2300	14.47 - 14.5
8.291 - 8.294	149.9 - 150.05	2310 - 2390	15.35 - 16.2
8.362 - 8.366	156.52475 - 156.52525	2483.5 - 2500	17.7 - 21.4
8.37625 - 8.38675	156.7 - 156.9	2655 - 2900	22.01 - 23.12
8.41425 - 8.41475	162.0125 - 167.17	3260 - 3267	23.6 - 24.0
12.29 - 12.293	167.72 - 173.2	3332 - 3339	31.2 - 31.8
12.51975 - 12.52025	240 - 285	3345.8 - 3338	36.43 - 36.5
12.57675 - 12.57725	322 - 335.4	3600 - 4400	(²)
13.36 - 13.41			

15.205 (b) Except as provided in paragraphs (d) and (e), the field strength of emissions appearing within these frequency bands shall not exceed the limits shown in Section 15.209. At frequencies equal to or less than 1000 MHz, compliance with the limits in Section 15.209 shall be demonstrated using measurement instrumentation employing a CISPR quasi-peak detector. Above 1000 MHz, compliance with the emission limits in Section 15.209 shall be demonstrated based on the average value of the measured emissions. The provisions in Section 15.35 apply to these measurements.

15.209 (a) Except as provided elsewhere in this Subpart, the emissions from an intentional radiator shall not exceed the field strength levels specified in the following table :

Frequency (MHz)	Field Strength (microvolts/meter)	Measurement Distance (meters)
30 - 88	100 **	3
88 - 216	150 **	3
216 - 960	200 **	3
Above 960	500	3

** Except as provided in paragraph (g), fundamental emissions from intentional radiators operating under this Section shall not be located in the frequency bands 54-72 MHz, 76-88 MHz, 174-216 MHz

or 470-806 MHz, However, operation within these frequency bands is permitted under other sections of this Part, e-g, Sections 15.231 and 15.241.
 15.209 (b) In the emission table above, the tighter limit applies at the band edges.

9.1.2 EUT Setup

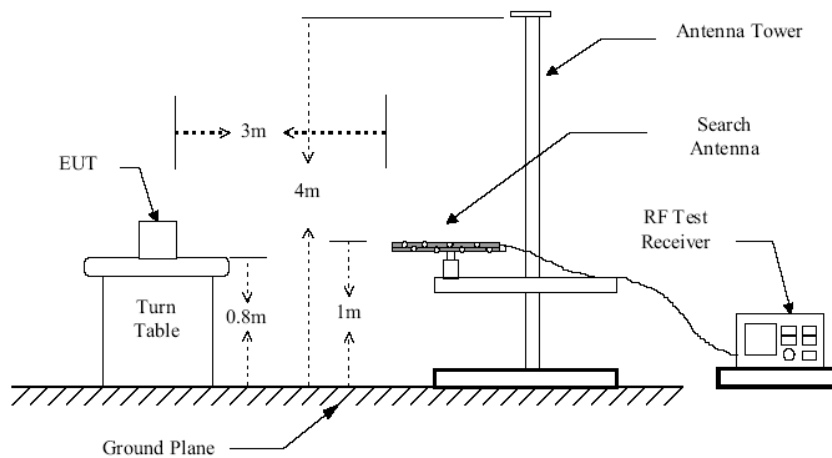
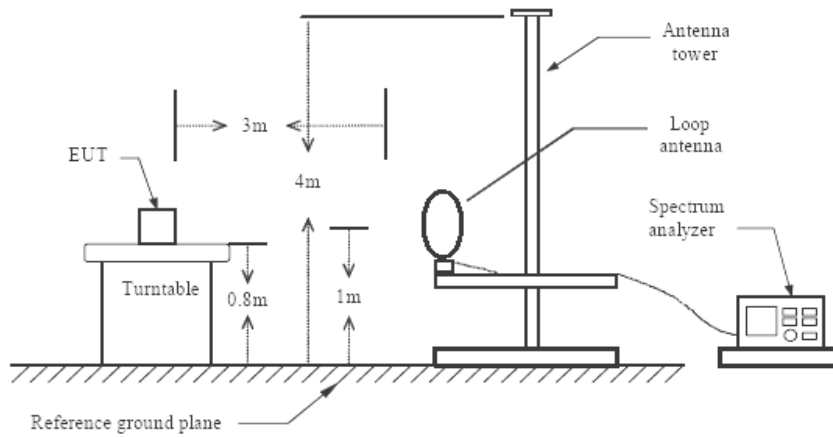

Figure 1 : Frequencies measured below 1 GHz configuration

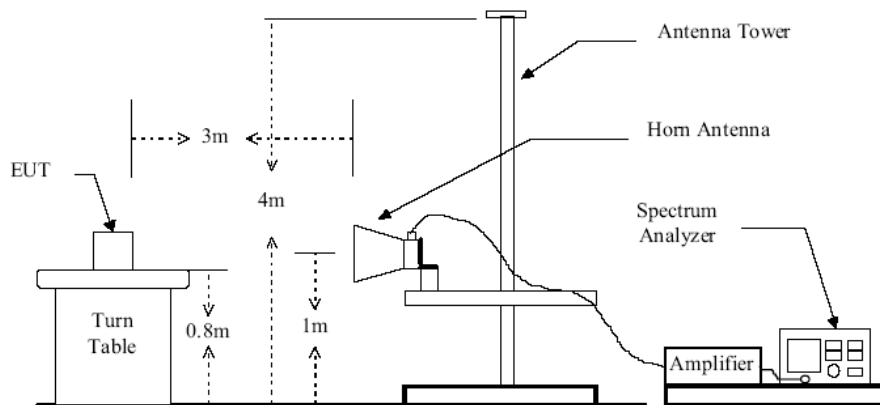

Figure 2 : Frequencies measured above 1 GHz configuration

9.1.3 Test Procedure

1. Configure the EUT according to ANSI C63.4-2009
2. The EUT was placed on the top of the turntable 0.8 meter above ground.
3. The turntable was rotated by 360 degrees to determine the position of the highest radiation.
4. For each suspected emission, the antenna tower was scanned (from 1 M to 4 M) and then the turntable was rotated (from 0 degree to 360 degrees) to find the maximum reading.
5. According to the characteristic of the EUT crystals, the range of frequencies was investigated from 9KHz to 30MHz, 30MHz to 1GHz and 1GHz to 24.8GHz.
6. Any testing performed below 30 MHz was performed using a magnetic loop antenna in accordance with ANSI C63.10: section 4.5, Table 1
7. In accordance with 15.35(b), above 1 GHz, emissions measured using a peak detector shall not exceed a level 20 dB above the average limit.
8. Measurements at 2400 & 2483.5 MHz were made to ensure band edge compliance.
9. Testing was performed with the EUT orientated in three orthogonal planes and the maximum emissions level recorded. In addition, the EUT antenna was varied within its range of motion in order to maximise emissions.
10. For Frequencies below 1 GHz, RBW= 100 kHz, testing was performed with CISPR16 compliant test receiver with QP detector. Above 1 GHz tests were performed using a spectrum analyser using the following settings:
Peak RBW=VBW= 1MHz
Average RBW=VBW= 1MHz

These settings as per ANSI C63.10

9.1.4 Test Result

Temperature (°C) : 22~23	EUT: Accent 1400
Humidity (%RH) : 50~54	M/N: ACN1400
Barometric Pressure (mbar) : 950~1000	Operation Condition: Normal operation & TX Mode

Note: In this testing, the EUT was respectively tested in three different orientations. That is:

1. EUT was lie vertically, and then its Antenna oriented upward
2. EUT was lie vertically, and then its Antenna oriented downward
3. EUT was lie flatwise, and then its Antenna oriented to the receiving antenna

The worst test data see following pages

When the EUT was lie flatwise, and its Antenna oriented to the receiving antenna, the worst test data was got as following table.

WORST-CASE RADIATED EMISSION BELOW 30 MHz

Normal operating Mode:

Frequency	Meter Reading	Antenna Factor	Cable Loss	Emission Levels	Limits	Margin	Detector Mode
(MHz)	(dBμV)	(dB/M)	(dB)	(dBμV/M)	(dB μ V/M)	(dB)	PK/QP
5.87	22.56	8.23	1.03	29.76	67	-37.24	QP
14.78	21.38	9.07	1.19	29.26	49.5	-20.24	QP
21.56	21.59	9.25	1.08	29.76	49.5	-19.74	QP
24.69	21.45	8.43	1.66	28.22	49.5	-21.28	QP

WORST-CASE RADIATED EMISSION BELOW 1 GHz

Normal operating Mode:

Horizontal

Frequency	Meter Reading	Tansd	Limits	Margin	Detector Mode
(MHz)	(dBμV)	(dB)	(dB μ V/M)	(dB)	PK/QP
45.68	33.25	15.9	40	-6.75	QP
76.58	36.78	12	40	-3.22	QP
173.56	27.25	13.4	43.5	-16.25	QP
295.85	33.34	18.6	46	-12.66	QP
470.84	35.38	22.7	46	-10.62	QP
575.48	36.45	25.5	46	-9.55	QP
N/A	----	----	----	----	----

Vertical

Frequency	Meter Reading	Tansd	Limits	Margin	Detector Mode
(MHz)	(dBμV)	(dB)	(dB μ V/M)	(dB)	PK/QP
42.35	30.1	15.9	40	-9.9	QP
88.74	36.82	14.8	40	-3.18	QP
165.78	32.35	13	46	-13.65	QP
258.35	35.08	17.3	46	-10.92	QP
432.54	37.63	22	46	-8.37	QP
928.36	36.35	29.4	46	-9.65	QP
N/A	----	----	----	----	----

Note: 1. Transd.=Antenna Factor+Cable Loss-Pre-amplifier
Margin = Level-Limit

**WORST-CASE RADIATED EMISSION ABOVE 1 GHz
IEEE 802.11b TX (CH Low)**

Channel Low (2412MHz)								
Maximum Frequency (MHz)	Polarity and Level					Limit (dBµV/m)	Margin (dBµV/m)	Mark (P/Q/A)
	Polarity	Height (m)	Reading dBµV	Transd	Result dBµV/m			
1385.21	H	1	48.38	-7.97	40.41	74	-33.59	P
			35.47	-7.97	27.5	54	-26.5	A
1368.33	V	1	48.47	-7.97	40.5	74	-33.5	P
			34.85	-7.97	26.88	54	-27.12	A
2412	H	1	108.35	-6.47	101.88	----	----	P
			101.65	-6.47	95.18	----	----	A
2412	V	1	112.35	-6.47	105.88	----	----	P
			102.36	-6.47	95.89	----	----	A
4824	H	1	43.4	0.52	43.92	74	-30.08	P
			32.38	0.52	32.9	54	-21.1	A
4824	V	1	44.82	0.52	45.34	74	-28.66	P
			32.33	0.52	32.85	54	-21.15	A
7236	H	1	42.26	7.41	49.67	74	-24.33	P
			32.74	7.41	40.15	54	-13.85	A
7236	V	1	42.26	7.41	49.67	74	-24.33	P
			32.57	7.41	39.98	54	-14.02	A
11145.34	H	1	----	----	----	----	----	----
16327.65	----	----	----	----	----	----	----	----
25376.32	----	----	----	----	----	----	----	----

Remark: 1. Transd.=Antenna Factor+Cable Loss-Pre-amplifier
Margin = Level-Limit
Mark: P means Peak Value, Q means Quasi Peak Value, A means Average Value
2. Data of measurement within this frequency range shown “-” in the table above means the reading of emissions are attenuated more than 20dB below the permissible limits or the field strength is too small to be measured.
3. Spectrum analyzer setting P(Peak): RBW=1MHz, VBW=1MHz, A(Average): RBW=1MHz, VBW=10Hz.
4. The test limit distance is 3m limit

IEEE 802.11b TX (CH Middle)

Channel Middle (2437MHz)								
Maximum Frequency (MHz)	Polarity and Level					Limit (dBµV/m)	Margin (dBµV/m)	Mark (P/Q/A)
	Polarity	Height (m)	Reading dBµV	Transd	Result dBµV/m			
1311.67	H	1	47.54	-8.23	39.31	74	-34.69	P
			36.15	-8.23	27.92	54	-26.08	A
1311.67	V	1	48.12	-8.23	39.89	74	-34.11	P
			36.85	-8.23	28.62	54	-25.38	A
2437	H	1	108.3	-6.37	101.93	----	----	P
			97.23	-6.37	90.86	----	----	A
2437	V	1	112.34	-6.37	105.97	----	----	P
			101.38	-6.37	95.01	----	----	A
4874	H	1	42.88	0.75	43.63	74	-30.37	P
			32.75	0.75	33.5	54	-20.5	A
4874	V	1	44.36	0.75	45.11	74	-28.89	P
			33.75	0.75	34.5	54	-19.5	A
7311	H	1	41.52	7.48	49	74	-25	P
			32.95	7.48	40.43	54	-13.57	A
7311	V	1	42.19	7.48	49.67	74	-24.33	P
			32.84	7.48	40.32	54	-13.68	A
11238.52	H	1	----	----	----	----	----	----
16327.71	----	----	----	----	----	----	----	----
25376.58	----	----	----	----	----	----	----	----

Remark: 1. Transd.=Antenna Factor+Cable Loss-Pre-amplifier
 Margin = Level-Limit
 Mark: P means Peak Value, Q means Quasi Peak Value, A means Average Value
 2. Data of measurement within this frequency range shown “-” in the table above means the reading of emissions are attenuated more than 20dB below the permissible limits or the field strength is too small to be measured.
 3. Spectrum analyzer setting P(Peak): RBW=1MHz, VBW=1MHz, A(Average): RBW=1MHz, VBW=10Hz.
 4. The test limit distance is 3m limit

IEEE 802.11b TX (CH High)

Channel High (2462MHz)								
Maximum Frequency (MHz)	Polarity and Level					Limit (dBµV/m)	Margin (dBµV/m)	Mark (P/Q/A)
	Polarity	Height (m)	Reading dBµV	Transd	Result dBµV/m			
1311.67	H	1	47.88	-8.23	39.65	74	-34.35	P
			35.78	-8.23	27.55	54	-26.45	A
1311.67	V	1	48.38	-8.23	40.15	74	-33.85	P
			35.89	-8.23	27.66	54	-26.34	A
2462	H	1	110.85	-6.28	104.57	----	----	P
			97.85	-6.28	91.57	----	----	A
2462	V	1	112.38	-6.28	106.1	----	----	P
			101.59	-6.28	95.31	----	----	A
4924	H	1	43.18	0.97	44.15	74	-29.85	P
			32.85	0.97	33.82	54	-20.18	A
4924	V	1	46.7	0.97	47.67	74	-26.33	P
			33.84	0.97	34.81	54	-19.19	A
7386	H	1	42.59	7.56	50.15	74	-23.85	P
			32.35	7.56	39.91	54	-14.09	A
7386	V	1	41.95	7.56	49.51	74	-24.49	P
			31.86	7.56	39.42	54	-14.58	A
11243.58	H	1	----	----	----	----	----	----
16327.45	----	----	----	----	----	----	----	----
25376.26	----	----	----	----	----	----	----	----

Remark: 1. Transd.=Antenna Factor+Cable Loss-Pre-amplifier
Margin = Level-Limit
Mark: P means Peak Value, Q means Quasi Peak Value, A means Average Value
2. Data of measurement within this frequency range shown “-” in the table above means the reading of emissions are attenuated more than 20dB below the permissible limits or the field strength is too small to be measured.
3. Spectrum analyzer setting P(Peak): RBW=1MHz, VBW=1MHz, A(Average): RBW=1MHz, VBW=10Hz.
4. The test limit distance is 3m limit

IEEE 802.11g TX (CH Low)

Channel Low (2412MHz)								
Maximum Frequency (MHz)	Polarity and Level					Limit (dBµV/m)	Margin (dBµV/m)	Mark (P/Q/A)
	Polarity	Height (m)	Reading dBµV	Transd	Result dBµV/m			
1383.65	H	1	48.23	-7.97	40.26	74	-33.74	P
			35.47	-7.97	27.5	54	-26.5	A
1383.65	V	1	47.65	-7.97	39.68	74	-34.32	P
			35.08	-7.97	27.11	54	-26.89	A
2412	H	1	105.39	-6.47	98.92	----	----	P
			94.78	-6.47	88.31	----	----	A
2412	V	1	107.38	-6.47	100.91	----	----	P
			96.58	-6.47	90.11	----	----	A
4824	H	1	42.85	0.52	43.37	74	-30.63	P
			32.47	0.52	32.99	54	-21.01	A
4824	V	1	43.67	0.52	44.19	74	-29.81	P
			32.38	0.52	32.9	54	-21.1	A
7236	H	1	42.75	7.41	50.16	74	-23.84	P
			32.84	7.41	40.25	54	-13.75	A
7236	V	1	43.54	7.41	50.95	74	-23.05	P
			32.95	7.41	40.36	54	-13.64	A
11145.34	H	1	----	----	----	----	----	----
16327.65	----	----	----	----	----	----	----	----
25376.32	----	----	----	----	----	----	----	----

Remark: 1. Transd.=Antenna Factor+Cable Loss-Pre-amplifier
 Margin = Level-Limit
 Mark: P means Peak Value, Q means Quasi Peak Value, A means Average Value
 2. Data of measurement within this frequency range shown “-” in the table above means the reading of emissions are attenuated more than 20dB below the permissible limits or the field strength is too small to be measured.
 3. Spectrum analyzer setting P(Peak): RBW=1MHz, VBW=1MHz, A(Average): RBW=1MHz, VBW=10Hz.
 4. The test limit distance is 3m limit

IEEE 802.11g TX (CH Middle)

Channel Middle (2437MHz)								
Maximum Frequency (MHz)	Polarity and Level					Limit (dBµV/m)	Margin (dBµV/m)	Mark (P/Q/A)
	Polarity	Height (m)	Reading dBµV	Transd	Result dBµV/m			
1323.78	H	1	47.36	-8.23	39.13	74	-34.87	P
			35.47	-8.23	27.24	54	-26.76	A
1323.78	V	1	48.38	-8.23	40.15	74	-33.85	P
			35.69	-8.23	27.46	54	-26.54	A
2437	H	1	104.35	-6.37	97.98	----	----	P
			94.87	-6.37	88.5	----	----	A
2437	V	1	107.85	-6.37	101.48	----	----	P
			96.38	-6.37	90.01	----	----	A
4874	H	1	43.54	0.75	44.29	74	-29.71	P
			32.85	0.75	33.6	54	-20.4	A
4874	V	1	43.67	0.75	44.42	74	-29.58	P
			32.87	0.75	33.62	54	-20.38	A
7311	H	1	42.74	7.48	50.22	74	-23.78	P
			32.38	7.48	39.86	54	-14.14	A
7311	V	1	42.85	7.48	50.33	74	-23.67	P
			32.76	7.48	40.24	54	-13.76	A
11238.52	H	1	----	----	----	----	----	----
16327.71	----	----	----	----	----	----	----	----
25376.58	----	----	----	----	----	----	----	----

Remark: 1. Transd.=Antenna Factor+Cable Loss-Pre-amplifier
 Margin = Level-Limit
 Mark: P means Peak Value, Q means Quasi Peak Value, A means Average Value
 2. Data of measurement within this frequency range shown “-” in the table above means the reading of emissions are attenuated more than 20dB below the permissible limits or the field strength is too small to be measured.
 3. Spectrum analyzer setting P(Peak): RBW=1MHz, VBW=1MHz, A(Average): RBW=1MHz, VBW=10Hz.
 4. The test limit distance is 3m limit

IEEE 802.11g TX (CH High)

Channel High (2462MHz)								
Maximum Frequency (MHz)	Polarity and Level					Limit (dBµV/m)	Margin (dBµV/m)	Mark (P/Q/A)
	Polarity	Height (m)	Reading dBµV	Transd	Result dBµV/m			
1311.67	H	1	47.63	-8.23	39.4	74	-34.6	P
			35.85	-8.23	27.62	54	-26.38	A
1311.67	V	1	48.34	-8.23	40.11	74	-33.89	P
			36.43	-8.23	28.2	54	-25.8	A
2462	H	1	103.54	-6.28	97.26	----	----	P
			93.65	-6.28	87.37	----	----	A
2462	V	1	106.54	-6.28	100.26	----	----	P
			94.58	-6.28	88.3	----	----	A
4924	H	1	42.57	0.97	43.54	74	-30.46	P
			32.38	0.97	33.35	54	-20.65	A
4924	V	1	45.37	0.97	46.34	74	-27.66	P
			33.69	0.97	34.66	54	-19.34	A
7386	H	1	43.58	7.56	51.14	74	-22.86	P
			32.65	7.56	40.21	54	-13.79	A
7386	V	1	42.43	7.56	49.99	74	-24.01	P
			32.38	7.56	39.94	54	-14.06	A
11243.58	H	1	----	----	----	----	----	----
16327.45	----	----	----	----	----	----	----	----
25376.26	----	----	----	----	----	----	----	----

Remark: 1. Transd.=Antenna Factor+Cable Loss-Pre-amplifier
Margin = Level-Limit
Mark: P means Peak Value, Q means Quasi Peak Value, A means Average Value
2. Data of measurement within this frequency range shown “-” in the table above means the reading of emissions are attenuated more than 20dB below the permissible limits or the field strength is too small to be measured.
3. Spectrum analyzer setting P(Peak): RBW=1MHz, VBW=1MHz, A(Average): RBW=1MHz, VBW=10Hz.
4. The test limit distance is 3m limit

IEEE 802.11n HT20 TX (CH Low)

Channel Low (2412MHz)								
Maximum Frequency (MHz)	Polarity and Level					Limit (dBµV/m)	Margin (dBµV/m)	Mark (P/Q/A)
	Polarity	Height (m)	Reading dBµV	Transd	Result dBµV/m			
1396.67	H	1	47.97	-7.84	40.13	74	-33.87	P
			35.63	-7.84	27.79	54	-26.21	A
1396.67	V	1	47.41	-7.84	39.57	74	-34.43	P
			35.38	-7.84	27.54	54	-26.46	A
2412	H	1	102.38	-6.47	95.91	----	----	P
			90.59	-6.47	84.12	----	----	A
2412	V	1	103.85	-6.47	97.38	----	----	P
			91.84	-6.47	85.37	----	----	A
4824	H	1	43.92	0.52	44.44	74	-29.56	P
			32.38	0.52	32.9	54	-21.1	A
4824	V	1	43.48	0.52	44	74	-30	P
			32.38	0.52	32.9	54	-21.1	A
7236	H	1	42.09	7.41	49.5	74	-24.5	P
			32.8	7.41	40.21	54	-13.79	A
7236	V	1	42.28	7.41	49.69	74	-24.31	P
			32.15	7.41	39.56	54	-14.44	A
11145.34	H	1	----	----	----	----	----	----
16327.65	----	----	----	----	----	----	----	----
25376.32	----	----	----	----	----	----	----	----

Remark: 1. Transd.=Antenna Factor+Cable Loss-Pre-amplifier
Margin = Level-Limit
Mark: P means Peak Value, Q means Quasi Peak Value, A means Average Value
2. Data of measurement within this frequency range shown “-” in the table above means the reading of emissions are attenuated more than 20dB below the permissible limits or the field strength is too small to be measured.
3. Spectrum analyzer setting P(Peak): RBW=1MHz, VBW=1MHz, A(Average): RBW=1MHz, VBW=10Hz.
4. The test limit distance is 3m limit

IEEE 802.11n HT20 TX (CH Middle)

Channel Middle (2437MHz)								
Maximum Frequency (MHz)	Polarity and Level					Limit (dBµV/m)	Margin (dBµV/m)	Mark (P/Q/A)
	Polarity	Height (m)	Reading dBµV	Transd	Result dBµV/m			
1719.35	H	1	51.34	-9.09	42.25	74	-31.75	P
			39.45	-9.09	30.36	54	-23.64	A
1719.35	V	1	48.11	-9.09	39.02	74	-34.98	P
			35.33	-9.09	26.24	54	-27.76	A
2437	H	1	103.45	-6.37	97.08	----	----	P
			94.38	-6.37	88.01	----	----	A
2437	V	1	105.38	-6.37	99.01	----	----	P
			95.85	-6.37	89.48	----	----	A
4874	H	1	43.17	0.75	43.92	74	-30.08	P
			32.54	0.75	33.29	54	-20.71	A
4874	V	1	43.16	0.75	43.91	74	-30.09	P
			32.58	0.75	33.33	54	-20.67	A
7311	H	1	42.89	7.48	50.37	74	-23.63	P
			32.38	7.48	39.86	54	-14.14	A
7311	V	1	42.16	7.48	49.64	74	-24.36	P
			32.58	7.48	40.06	54	-13.94	A
11238.52	H	1	----	----	----	----	----	----
16327.71	----	----	----	----	----	----	----	----
25376.58	----	----	----	----	----	----	----	----

Remark: 1. Transd.=Antenna Factor+Cable Loss-Pre-amplifier
Margin = Level-Limit
Mark: P means Peak Value, Q means Quasi Peak Value, A means Average Value
2. Data of measurement within this frequency range shown “-” in the table above means the reading of emissions are attenuated more than 20dB below the permissible limits or the field strength is too small to be measured.
3. Spectrum analyzer setting P(Peak): RBW=1MHz, VBW=1MHz, A(Average): RBW=1MHz, VBW=10Hz.
4. The test limit distance is 3m limit

IEEE 802.11n HT20 TX (CH High)

Channel High (2462MHz)								
Maximum Frequency (MHz)	Polarity and Level					Limit (dBµV/m)	Margin (dBµV/m)	Mark (P/Q/A)
	Polarity	Height (m)	Reading dBµV	Transd	Result dBµV/m			
1321.85	H	1	48.87	-8.23	40.64	74	-33.36	P
			35.46	-8.23	27.23	54	-26.77	A
1321.85	V	1	48.09	-8.23	39.86	74	-34.14	P
			35.74	-8.23	27.51	54	-26.49	A
2462	H	1	102.54	-6.28	96.26	----	----	P
			92.89	-6.28	86.61	----	----	A
2462	V	1	104.67	-6.28	98.39	----	----	P
			92.59	-6.28	86.31	----	----	A
4924	H	1	43.33	0.97	44.3	74	-29.7	P
			32.84	0.97	33.81	54	-20.19	A
4924	V	1	43.27	0.97	44.24	74	-29.76	P
			32.58	0.97	33.55	54	-20.45	A
7386	H	1	42.55	7.56	50.11	74	-23.89	P
			32.84	7.56	40.4	54	-13.6	A
7386	V	1	41.76	7.56	49.32	74	-24.68	P
			31.85	7.56	39.41	54	-14.59	A
11243.58	H	1	----	----	----	----	----	----
16327.45	----	----	----	----	----	----	----	----
25376.26	----	----	----	----	----	----	----	----

Remark: 1. Transd.=Antenna Factor+Cable Loss-Pre-amplifier
 Margin = Level-Limit
 Mark: P means Peak Value, Q means Quasi Peak Value, A means Average Value
 2. Data of measurement within this frequency range shown “-” in the table above means the reading of emissions are attenuated more than 20dB below the permissible limits or the field strength is too small to be measured.
 3. Spectrum analyzer setting P(Peak): RBW=1MHz, VBW=1MHz, A(Average): RBW=1MHz, VBW=10Hz.
 4. The test limit distance is 3m limit

IEEE 802.11n HT40 TX (CH Low)

Channel Low (2422MHz)								
Maximum Frequency (MHz)	Polarity and Level					Limit (dBµV/m)	Margin (dBµV/m)	Mark (P/Q/A)
	Polarity	Height (m)	Reading dBµV	Transd	Result dBµV/m			
1338.67	H	1	47.38	-7.84	39.54	74	-34.46	P
			35.45	-7.84	27.61	54	-26.39	A
1338.67	V	1	48.64	-7.84	40.8	74	-33.2	P
			35.33	-7.84	27.49	54	-26.51	A
2422	H	1	98.75	-6.47	92.28	----	----	P
			89.36	-6.47	82.89	----	----	A
2422	V	1	101.36	-6.47	94.89	----	----	P
			90.58	-6.47	84.11	----	----	A
4844	H	1	42.86	0.52	43.38	74	-30.62	P
			32.37	0.52	32.89	54	-21.11	A
4844	V	1	43.65	0.52	44.17	74	-29.83	P
			32.33	0.52	32.85	54	-21.15	A
7266	H	1	42.54	7.41	49.95	74	-24.05	P
			32.65	7.41	40.06	54	-13.94	A
7266	V	1	42.85	7.41	50.26	74	-23.74	P
			32.63	7.41	40.04	54	-13.96	A
11145.34	H	1	----	----	----	----	----	----
16327.65	----	----	----	----	----	----	----	----
25376.32	----	----	----	----	----	----	----	----

Remark: 1. Transd.=Antenna Factor+Cable Loss-Pre-amplifier
 Margin = Level-Limit
 Mark: P means Peak Value, Q means Quasi Peak Value, A means Average Value
 2. Data of measurement within this frequency range shown “-” in the table above means the reading of emissions are attenuated more than 20dB below the permissible limits or the field strength is too small to be measured.
 3. Spectrum analyzer setting P(Peak): RBW=1MHz, VBW=1MHz, A(Average): RBW=1MHz, VBW=10Hz.
 4. The test limit distance is 3m limit

IEEE 802.11n HT40 TX (CH Mid)

Channel Middle (2437MHz)								
Maximum Frequency (MHz)	Polarity and Level					Limit (dBµV/m)	Margin (dBµV/m)	Mark (P/Q/A)
	Polarity	Height (m)	Reading dBµV	Transd	Result dBµV/m			
1326.35	H	1	48.75	-7.84	40.91	74	-33.09	P
			35.63	-7.84	27.79	54	-26.21	A
1326.35	V	1	47.84	-7.84	40	74	-34	P
			35.65	-7.84	27.81	54	-26.19	A
2437	H	1	99.54	-6.37	93.17	----	----	P
			89.75	-6.37	83.38	----	----	A
2437	V	1	103.4	-6.37	97.03	----	----	P
			92.85	-6.37	86.48	----	----	A
4874	H	1	42.37	0.75	43.12	74	-30.88	P
			32.54	0.75	33.29	54	-20.71	A
4874	V	1	43.62	0.75	44.37	74	-29.63	P
			32.54	0.75	33.29	54	-20.71	A
7311	H	1	41.58	7.48	49.06	74	-24.94	P
			32.33	7.48	39.81	54	-14.19	A
7311	V	1	41.85	7.48	49.33	74	-24.67	P
			32.63	7.48	40.11	54	-13.89	A
11238.52	H	1	----	----	----	----	----	----
16327.71	----	----	----	----	----	----	----	----
25376.58	----	----	----	----	----	----	----	----

Remark: 1. Transd.=Antenna Factor+Cable Loss-Pre-amplifier
 Margin = Level-Limit
 Mark: P means Peak Value, Q means Quasi Peak Value, A means Average Value
 2. Data of measurement within this frequency range shown “-” in the table above means the reading of emissions are attenuated more than 20dB below the permissible limits or the field strength is too small to be measured.
 3. Spectrum analyzer setting P(Peak): RBW=1MHz, VBW=1MHz, A(Average): RBW=1MHz, VBW=10Hz.
 4. The test limit distance is 3m limit

IEEE 802.11n HT40 TX (CH High)

Channel High (2452MHz)								
Maximum Frequency (MHz)	Polarity and Level					Limit (dBµV/m)	Margin (dBµV/m)	Mark (P/Q/A)
	Polarity	Height (m)	Reading dBµV	Transd	Result dBµV/m			
1337.63	H	1	47.69	-8.23	39.46	74	-34.54	P
			35.38	-8.23	27.15	54	-26.85	A
1337.63	V	1	48.08	-8.23	39.85	74	-34.15	P
			35.36	-8.23	27.13	54	-26.87	A
2452	H	1	98.75	-6.28	92.47	----	----	P
			89.35	-6.28	83.07	----	----	A
2452	V	1	102.54	-6.28	96.26	----	----	P
			91.85	-6.28	85.57	----	----	A
4904	H	1	42.38	0.97	43.35	74	-30.65	P
			32.33	0.97	33.3	54	-20.7	A
4904	V	1	43.54	0.97	44.51	74	-29.49	P
			32.33	0.97	33.3	54	-20.7	A
7356	H	1	41.58	7.56	49.14	74	-24.86	P
			32.36	7.56	39.92	54	-14.08	A
7356	V	1	42.38	7.56	49.94	74	-24.06	P
			32.59	7.56	40.15	54	-13.85	A
11243.58	H	1	----	----	----	----	----	----
16327.45	----	----	----	----	----	----	----	----
25376.26	----	----	----	----	----	----	----	----

Remark: 1. Transd.=Antenna Factor+Cable Loss-Pre-amplifier
Margin = Level-Limit
Mark: P means Peak Value, Q means Quasi Peak Value, A means Average Value
2. Data of measurement within this frequency range shown “-” in the table above means the reading of emissions are attenuated more than 20dB below the permissible limits or the field strength is too small to be measured.
3. Spectrum analyzer setting P(Peak): RBW=1MHz, VBW=1MHz, A(Average): RBW=1MHz, VBW=10Hz.
4. The test limit distance is 3m limit

10. Test of Band Edges Emission

10.1 Applicable Standard

Section 15.247(d): In any 100 kHz bandwidth outside the frequency band in which the spread spectrum or digitally modulated intentional radiator is operating, the radio frequency power that is produced by the intentional radiator shall be at least 20 dB below that in the 100 kHz bandwidth within the band that contains the highest level of the desired power, based on either an RF conducted or a radiated measurement. In addition, radiated emissions that fall in the restricted bands, as defined in Section 15.205, must also comply with the radiated emission limits specified in Section 15.209.

10.2 EUT Setup

Radiated Measurement Setup

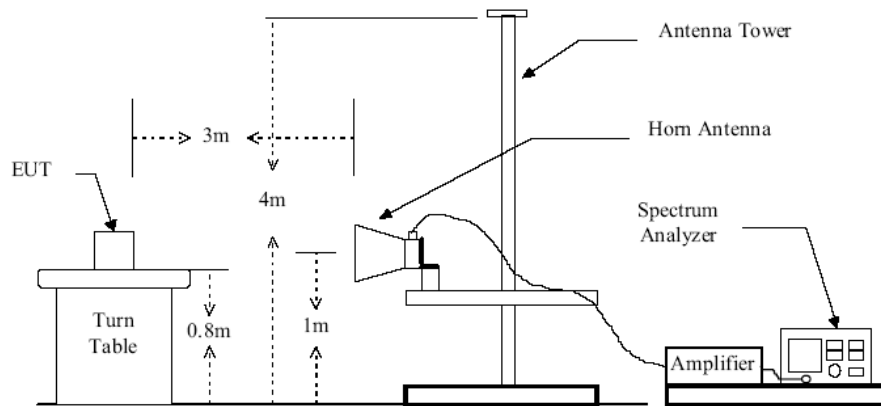
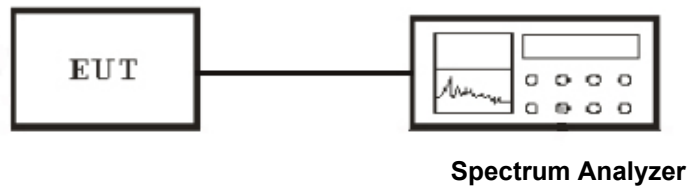

Figure 2 : Frequencies measured above 1 GHz configuration

Conducted Measurement Setup



10.3 Test Equipment List and Details

See section 2.5.

10.4 Test Procedure

Conducted Measurement

1. The transmitter is set to the lowest channel.
2. The transmitter output was connected to the spectrum analyzer via a cable and cable loss is used as the offset of the spectrum analyzer.

3. Set both RBW and VBW of spectrum analyzer to 100KHz with convenient frequency span including 100MHz bandwidth from lower band edge. Then detector set to peak and max hold this trace.
4. The lowest band edges emission was measured and recorded.
5. The transmitter set to the highest channel and repeated 2~4.

Radiated Measurement

1. Configure the EUT according to ANSI C63.4-2009
2. The turntable was rotated by 360 degrees to determine the position of the highest radiation.
3. The height of the broadband receiving antenna was varied between one meter and four meters above ground to find the maximum emission field strength of both horizontal and vertical polarization.
4. For band edge emission, the antenna tower was scan (from 1 M to 4 M) and then the turn table was rotated (from 0 degree to 360 degrees) to find the maximum reading.
5. For band edge emission, use 1MHz VBW and 1MHz RBW for reading under AV and use 1MHz VBW and 1MHz RBW for reading under PK.

10.5 Test Result

Temperature (°C) : 22~23	EUT: Accent 1400
Humidity (%RH) : 50~54	M/N: ACN1400
Barometric Pressure (mbar) : 950~1000	Operation Condition: Tx Mode

Radiated Test Result

TEST RESULT

IEEE 802.11b mode

Channel	Freq.(MHz)	Level(dBuV)	Limit(dBuV)	Margin(dB)	Detector
	2390	47.54	74	-26.46	Peak
LOW	2390	35.35	54	-18.65	Average
	2483.73	46.58	74	-27.42	Peak
HIGH	2483.73	35.15	54	-18.85	Average

IEEE 802.11g mode

Channel	Freq.(MHz)	Level(dBuV)	Limit(dBuV)	Margin(dB)	Detector
	2390	46.52	74	-27.48	Peak
LOW	2390	34.37	54	-19.63	Average
	2483.6	47.38	74	-26.62	Peak
HIGH	2483.6	35.16	54	-18.84	Average

IEEE 802.11n HT20 mode

Channel	Freq.(MHz)	Level(dBuV)	Limit(dBuV)	Margin(dB)	Detector
	2390	46.58	74	-27.42	Peak
LOW	2390	34.85	54	-19.15	Average
	2483.6	47.38	74	-26.62	Peak
HIGH	2483.6	35.37	54	-18.63	Average

EEE 802.11n HT40 mode

Channel	Freq.(MHz)	Level(dBuV)	Limit(dBuV)	Margin(dB)	Detector
	2390	46.59	74	-27.41	Peak
LOW	2390	34.38	54	-19.62	Average
	2483.6	45.34	74	-28.66	Peak
HIGH	2483.6	33.53	54	-20.47	Average

Test of Conducted band edges

CH Low (802.11b MODE)

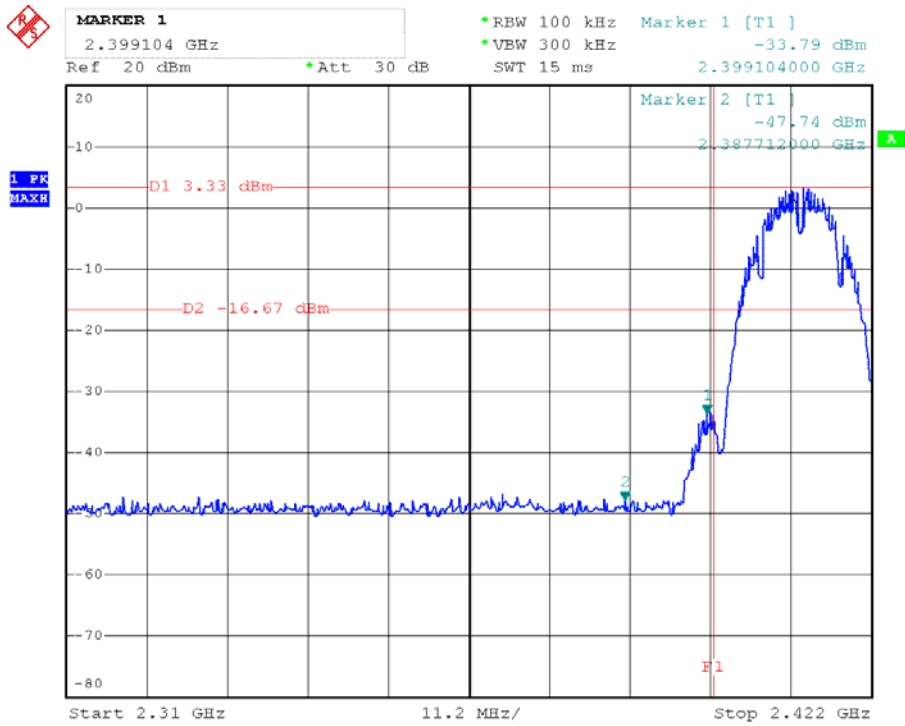

CH High (802.11b MODE)

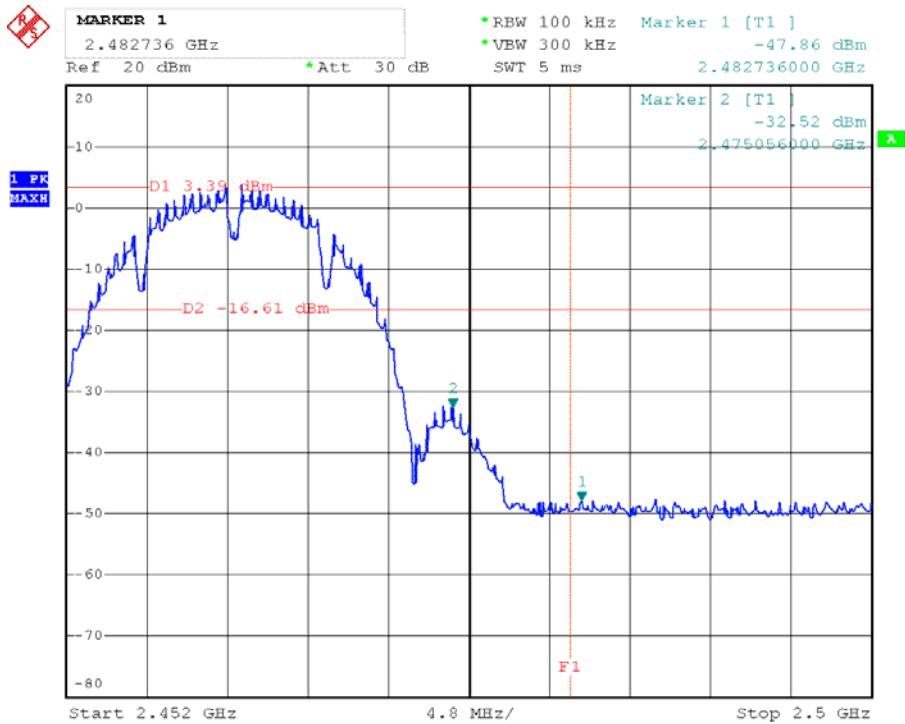

CH Low (802.11g MODE)

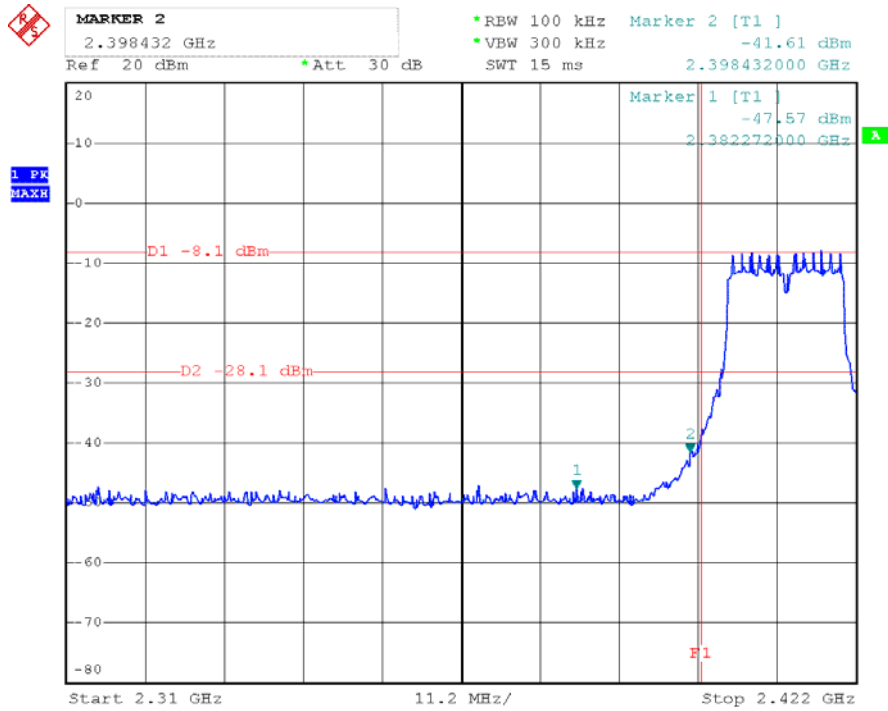

CH High (802.11g MODE)

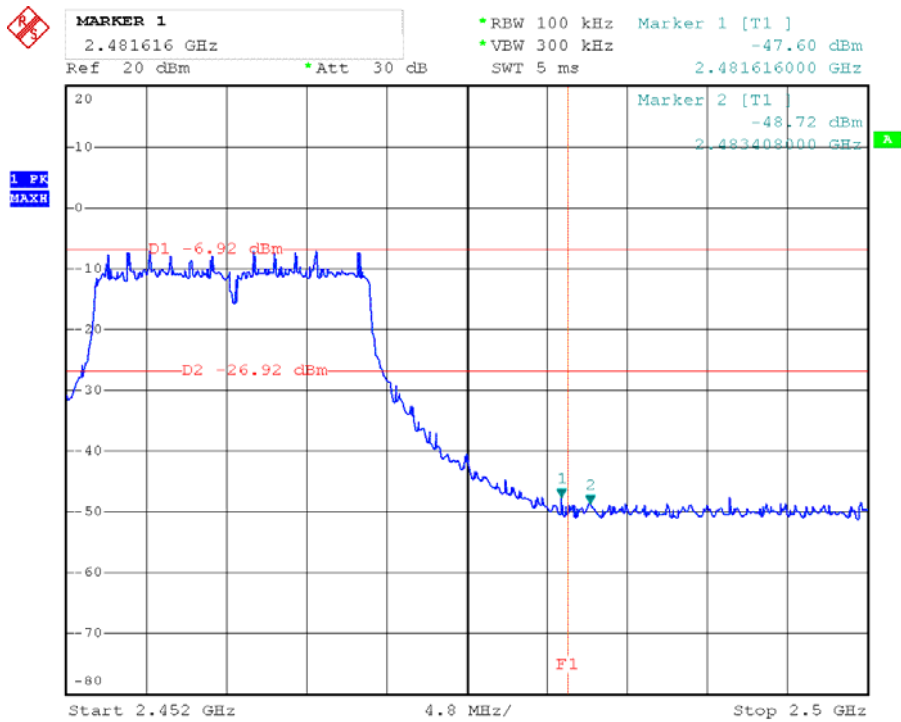

CH Low (802.11n HT20 MODE)

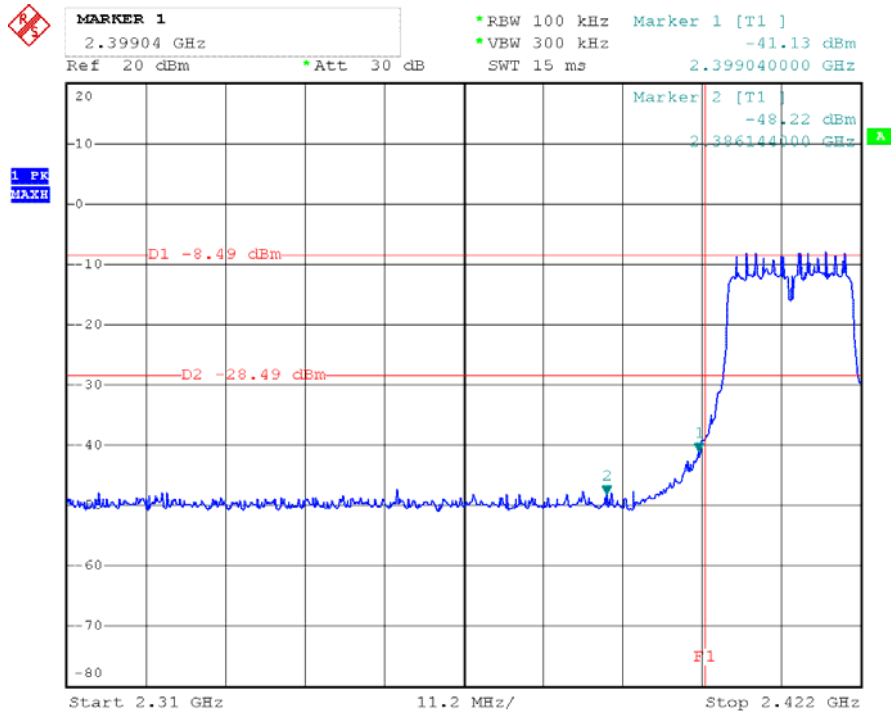

CH Low (802.11n HT20 MODE)

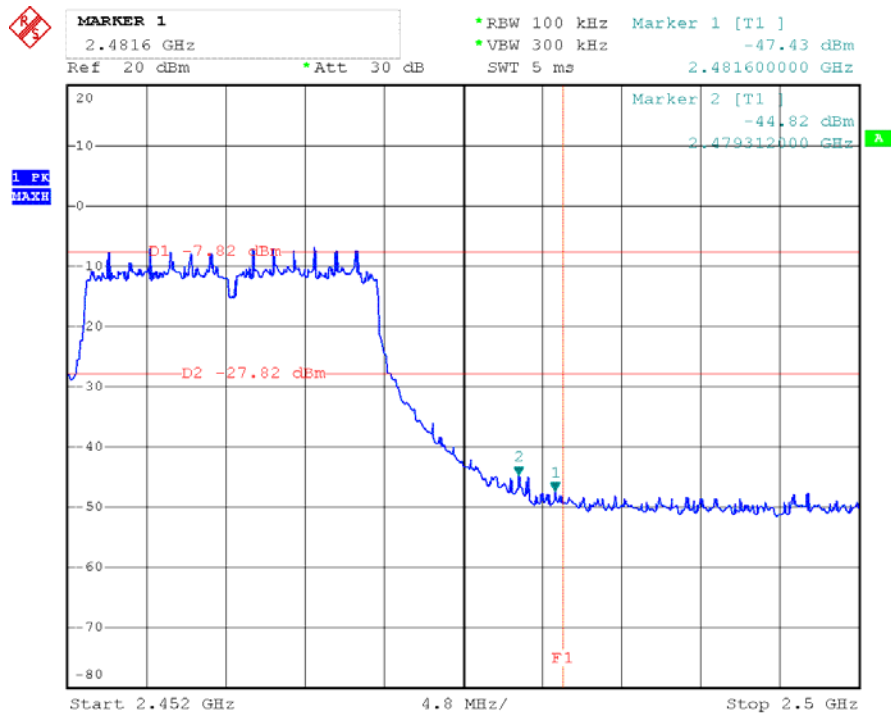

CH Low (802.11n HT40 MODE)

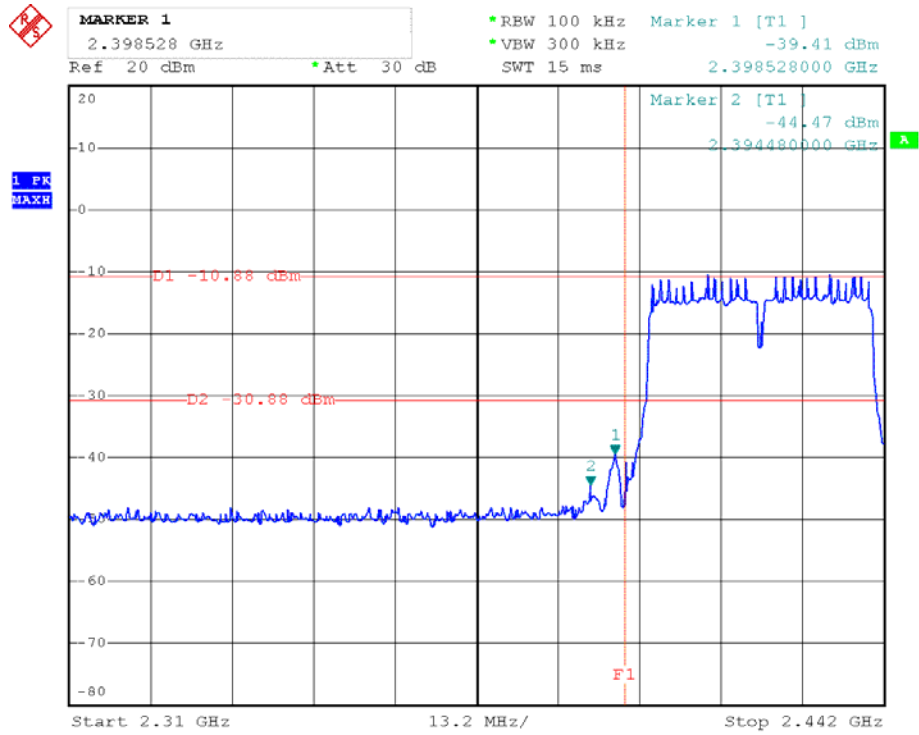

CH Low (802.11n HT40 MODE)

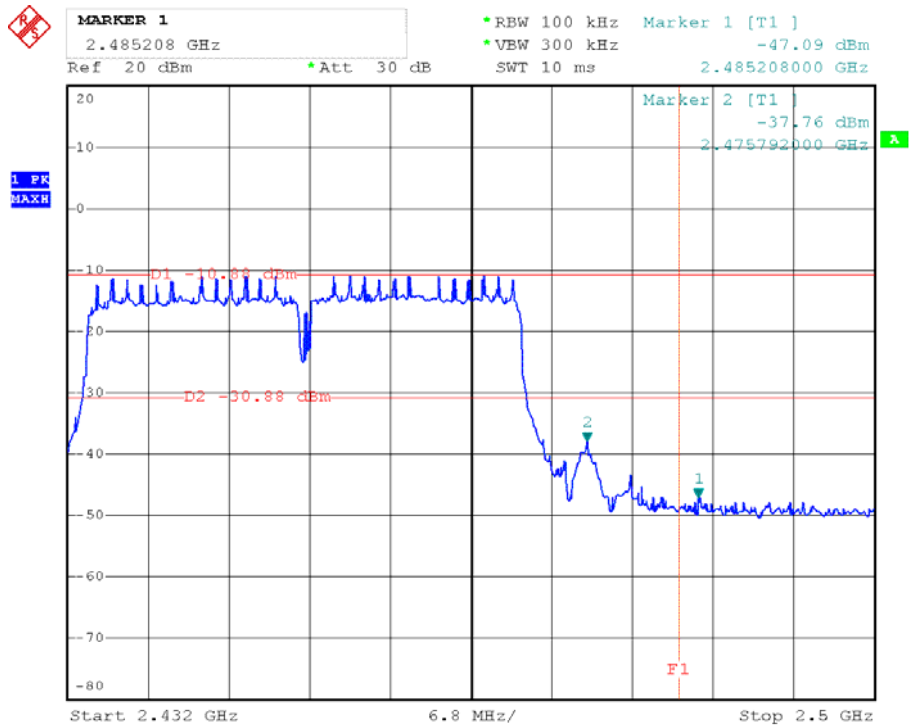

11. ANTENNA REQUIREMENT

11.1 Standard Applicable

Section 15.203:

An intentional radiator shall be designed to ensure that no antenna other than that furnished by the responsible party shall be used with the device. The use of a permanently attached antenna or of an antenna that uses a unique coupling to the intentional radiator shall be considered sufficient to comply with the provisions of this Section. The manufacturer may design the unit so that a broken antenna can be replaced by the user, but the use of a standard antenna jack or electrical connector is prohibited.

Section 15.247(b)/(c):

If transmitting antennas of directional gain greater than 6 dBi are used, the peak output power from the intentional radiator shall be reduced by the amount in dB that the directional gain of the antenna exceeds 6 dBi.

If the intentional radiator is used exclusively for fixed, point-to-point operations may employ transmitting antennas with directional gain greater than 6 dBi provided the maximum peak output power of the intentional radiator is reduced by 1 dB for every 3 dB that the directional gain of the antenna exceeds 6 dBi.

11.2 Antenna Connected Construction

The antenna is designed with permanent attachment and no consideration of replacement. The antenna used in this product is complied with Standard. The maximum Gain of the antenna lower than 6.0dBi and have the definite antenna Specification.