

Test Report of FCC CFR 47 Part 15 Subpart C

On Behalf of

Prentke Romich Company, LLC

FCC ID: 2AD9PACN1400

Product Description: Accent 1400

Model No.: ACN1400

Supplementary Model: N/A

Prepared for: Prentke Romich Company, LLC

1022 Heyl Rd. Wooster, Ohio 44691

Prepared by: Shenzhen QC Testing Laboratory Co., Ltd.

1st Floor, Building A, Huawan Industrial Park, Gushu, Xixiang
Street, Baoan, 518126, Shenzhen, China

Tel: 0755-23008269

Fax: 0755-23726780

Report No.: QCT15BR-1201E-5

Issue Date: March 06, 2015

Test Date: February 12~ March 06, 2015

Tested by:

Kare Gao

Kare Gao

Reviewed by:

Carmi Du

Carmi Du

Approved by:

Kendy Wang

Kendy Wang

TABLE OF CONTENTS

- 1. GENERAL INFORMATION4**
 - 1.1 PRODUCT DESCRIPTION FOR EQUIPMENT UNDER TEST (EUT)4
 - 1.2 RELATED SUBMITTAL(S) / GRANT (S) AND TEST METHODOLOGY5
 - 1.3 TEST FACILITY5
- 2. SYSTEM TEST CONFIGURATION6**
 - 2.1 EUT CONFIGURATION6
 - 2.2 EUT EXERCISE6
 - 2.3 GENERAL TEST PROCEDURES6
 - 2.4 MEASUREMENT UNCERTAINTY6
 - 2.5 SUPPORT EQUIPMENTS6
 - 2.6 TEST EQUIPMENT LIST AND DETAILS7
- 3. SUMMARY OF TEST RESULTS7**
- 4. TEST OF AC POWER LINE CONDUCTED EMISSION8**
 - 4.1 APPLICABLE STANDARD8
 - 4.2 TEST SETUP DIAGRAM8
 - 4.3 TEST RESULT8
- 5. TEST OF HOPPING CHANNEL BANDWIDTH11**
 - 5.1 APPLICABLE STANDARD11
 - 5.2 EUT SETUP11
 - 5.3 TEST EQUIPMENT LIST AND DETAILS11
 - 5.4 TEST PROCEDURE11
 - 5.5 TEST RESULT11
- 6. TEST OF HOPPING CHANNEL SEPARATION17**
 - 6.1 APPLICABLE STANDARD17
 - 6.2 EUT SETUP17
 - 6.3 TEST EQUIPMENT LIST AND DETAILS17
 - 6.4 TEST PROCEDURE17
 - 6.5 TEST RESULT17
- 7. TEST OF NUMBER OF HOPPING FREQUENCY24**
 - 7.1 APPLICABLE STANDARD24
 - 7.2 EUT SETUP24
 - 7.3 TEST EQUIPMENT LIST AND DETAILS24
 - 7.4 TEST PROCEDURE24
 - 7.5 TEST RESULT24
- 8. TEST OF DWELL TIME OF EACH FREQUENCY27**
 - 8.1 APPLICABLE STANDARD27
 - 8.2 EUT SETUP27
 - 8.3 TEST EQUIPMENT LIST AND DETAILS27
 - 8.4 TEST PROCEDURE27
 - 8.5 TEST RESULT27
- 9. TEST OF MAXIMUM PEAK OUTPUT POWER44**
 - 9.1 APPLICABLE STANDARD44
 - 9.2 EUT SETUP44
 - 9.3 TEST EQUIPMENT LIST AND DETAILS44
 - 9.4 TEST PROCEDURE44
 - 9.5 TEST RESULT44
- 10. TEST OF BAND EDGES EMISSION50**
 - 10.1 APPLICABLE STANDARD50
 - 10.2 EUT SETUP50
 - 10.3 TEST EQUIPMENT LIST AND DETAILS50
 - 10.4 TEST PROCEDURE50
 - 10.5 TEST RESULT51

11. TEST OF SPURIOUS RADIATED EMISSION57

- 11.1 APPLICABLE STANDARD 57
- 11.2 EUT SETUP 57
- 11.3 TEST EQUIPMENT LIST AND DETAILS..... 58
- 11.4 TEST PROCEDURE 58
- 11.5 TEST RESULT 59

12. ANTENNA REQUIREMENT 74

- 12.1 STANDARD APPLICABLE 74
- 12.2 ANTENNA CONNECTED CONSTRUCTION 74

1. GENERAL INFORMATION

1.1 Product Description for Equipment Under Test (EUT)

Client Information

Applicant:	Prentke Romich Company, LLC
Address of applicant:	1022 Heyl Rd. Wooster, Ohio 44691
Manufacturer :	Prentke Romich Company, LLC
Address of manufacturer:	1022 Heyl Rd. Wooster, Ohio 44691

General Description of E.U.T

Items	Description
EUT Description:	Accent 1400
Model No.:	ACN1400
Trade Name:	
Supplementary Model:	N/A
BT Module	CSR 4.0
Frequency Band:	2402~2480MHz
Number of Channels:	79
Type of Modulation:	GFSK, Pi/4 DQPSK, 8-DPSK
Antenna Gain	0.88 dBi
Antenna Type:	Input: 12VDC 3.0A from AC/DC adapter;7.4VDC from battery
Rated Voltage:	Model No:MENB1060A1800N02; Manufacturer: SL POWER and AULT Input: 100-240V~ 50-60Hz 1.5A Max ; Output:18.0V 3.4A

Remark: * The test data gathered are from the production sample provided by the manufacturer.

1.2 Related Submittal(s) / Grant (s) and Test Methodology

The tests were performed based on the Electromagnetic Interference (EMI) tests performed on the EUT. Both conducted and radiated testing were performed according to the procedures in ANSI C63.4 - 2003 Radiated testing was performed at an antenna to EUT distance 3 meters.

The tests were performed in order to determine compliance with FCC Part 15, Subpart C, and section 15.203, 15.207, 15.209 and 15.247 rules. Test was carried out according to the above mentioned FCC rules and the FCC publication notice DA 00-705: Filing and Measurement Guidelines for Frequency Hopping Spread Spectrum Systems

1.3 Test Facility

All measurement required was performed at laboratory of Shenzhen CTL Testing Technology Co., Ltd. at Floor 1-A, Baisha Technology Park, No.3011, Shahehexi Road, Nanshan District, Shenzhen, China 518055.

The test facility is recognized, certified, or accredited by the following organizations:

CNAS – Registration No.: L5540

Shenzhen CTL Testing Technology Co., Ltd. To ISO/IEC 17025:25 General Requirements for the Competence of Testing and Calibration Laboratories (CNAS-CL01 Accreditation Criteria for the Competence of Testing and Calibration Laboratories) for the competence in the field of testing. The acceptance letter from the CNAS is maintained in our files: Registration: L5540, March, 2012.

FCC – Registration No.: 970318

Shenzhen CTL Testing Technology Co., Ltd. EMC Laboratory has been Registered and fully described in a report filed with the (FCC) Federal Communications Commission. The acceptance letter from the FCC is maintained in our files. Registration: 970318, December 19, 2013.

2. SYSTEM TEST CONFIGURATION

2.1 EUT Configuration

The EUT configuration for testing is installed on RF field strength measurement to meet the Commissions requirement and operating in a manner that intends to maximize its emission characteristics in a continuous normal application.

2.2 EUT Exercise

The calibrated antennas used to sample the radiated field strength are mounted on a non-conductive, motorized antenna mast 3 or 10 meters from the leading edge of the turntable.

2.3 General Test Procedures

Conducted Emissions: The EUT is placed on the turntable, which is 0.8 m above ground plane. According to the requirements in Section 7.1 of ANSI C63.4-2003 Conducted emissions from the EUT measured in the frequency range between 0.15 MHz and 30MHz using CISPR Quasi-Peak detector mode.

Radiated Emissions: The EUT is a placed on as turntable, which is 0.8 m above ground plane. The turntable shall rotate 360 degrees to determine the position of maximum emission level. EUT is set 3m away from the receiving antenna, which varied from 1m to 4m to find out the highest emission. And also, each emission was to be maximized by changing the polarization of receiving antenna both horizontal and vertical. In order to find out the maximum emissions, exploratory radiated emission measurements were made according to the requirements in Section 13.1.4.1 of ANSI C63.4-2003.

2.4 Measurement Uncertainty

Where relevant, the following measurement uncertainty levels have been estimated for tests performed on the apparatus:

Parameter	Uncertainty
Power Line Conducted Emission	+/- 2.3 dB
Radiated Emission	+/- 3.4 dB

Uncertainty figures are valid to a confidence level of 95%.

2.5Support Equipments

The calibrated antennas used to sample the radiated field strength are mounted on a non-conductive, motorized antenna mast 3 or 10 meters from the leading edge of the turntable.

Support equipments or special accessories in test configuration:

2.6 Test Equipment List and Details

Test equipments list of Shenzhen CTL Testing Technology Co., Ltd.

Item	Test Equipment	Manufacturer	Model No.	Serial No.	Last Cal.
1	ULTRA-BROADBAND ANTENNA	Sunol Sciences Corp.	JB1 Antenna	A061713	2014.05.22
2	EMI TEST RECEIVER	ROHDE & SCHWARZ	ESCI	1166.5950.03	2014.03.19
3	Coaxial	/	/	/	2014.05.22
4	Controller	EM Electronics	Controller EM 1000	N/A	2014.05.22
5	Horn antenna	Sunol sciences corp	DRH-118	A062013	2014.07.22
6	Horn antenna	SCHWARZBECK	BBHA9710	1562	2014.07.22
7	Loop antenna	ZHINAN	ZN30900A	3548	2014.07.22
8	Amplifier	HP	8447D	1937A02492	2014.4.25
9	Broadband preamplifier	SCHWARZBECK	BBV9718	9718-182	2014.4.25
10	Spectrum Analyzer	R&S	FSP	100397	2014.05.22

3. SUMMARY OF TEST RESULTS

FCC Rules	Description of Test	Result
FCC §15.207	AC Power Line Conducted Emission	Pass
FCC §15.247(a)(1)	Hopping Channel Bandwidth	Pass
FCC §15.247(a)(1)	Hopping Channel Separation	Pass
FCC §15.247(a)(1)	Number of Hopping Frequency Used	Pass
FCC §15.247(a)(1)(iii)	Dwell Time of Each Frequency	Pass
FCC §15.247(b)(1)	Maximum Peak Output Power	Pass
FCC §15.247(d)	Band Edges Emission	Pass
FCC §15.247(d)	Spurious Radiated Emission	Pass
FCC §15.203/15.247(b)/(c)	Antenna Requirement	Pass

4. TEST OF AC POWER LINE CONDUCTED EMISSION

4.1 Applicable Standard

Refer to FCC §15.207.

For a Low-power Radio-frequency Device is designed to be connected to the AC power line, the radio frequency voltage that is conducted back onto the AC power line on any frequency or frequencies within the band 150 kHz to 30 MHz shall not exceed below limits table.

Frequency Range (MHz)	Limits (dBuV)	
	Quasi-Peak	Average
0.150~0.500	66~56	56~46
0.500~5.000	56	46
5.000~30.00	60	50

4.2 Test Setup Diagram

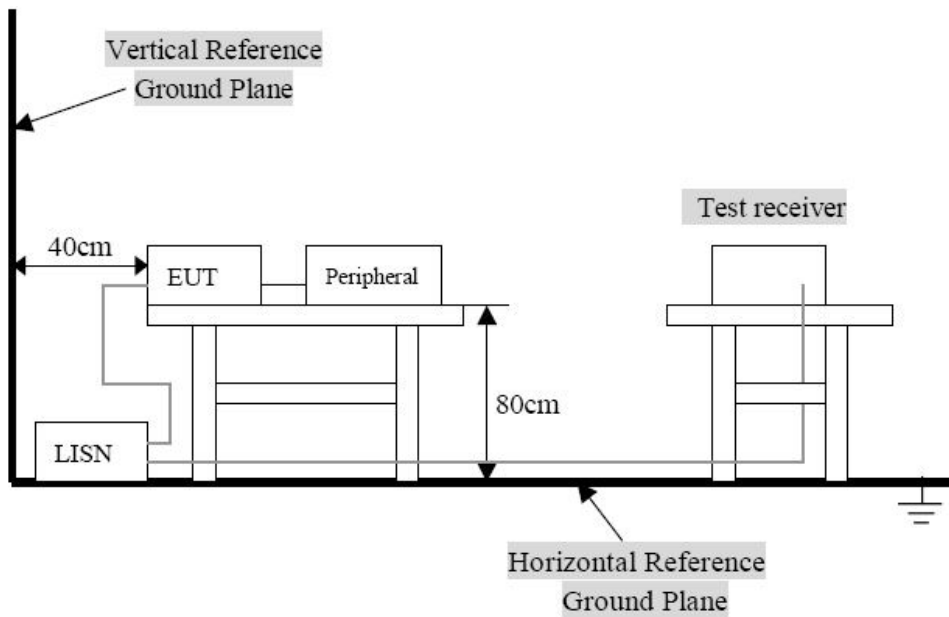

Remark: The EUT was connected to a 120 VAC/ 60Hz power source.

4.3 Test Result

Temperature (°C) : 23~25	EUT: Accent 1400
Humidity (%RH) : 45~58	M/N: ACN1400
Barometric Pressure (mbar) : 950~1000	Operation Condition: Tx Mode

Conducted Emission:

EUT: Accent 1400
M/N: ACN1400
Operating Condition: Tx Mode
Test Site: Shielded Room
Operator: Yang
Test Specification: AC 120V/60Hz for adapter
Comment: L Line

SCAN TABLE: "Voltage (9K-30M) FIN"
Short Description: 150K-30M Voltage

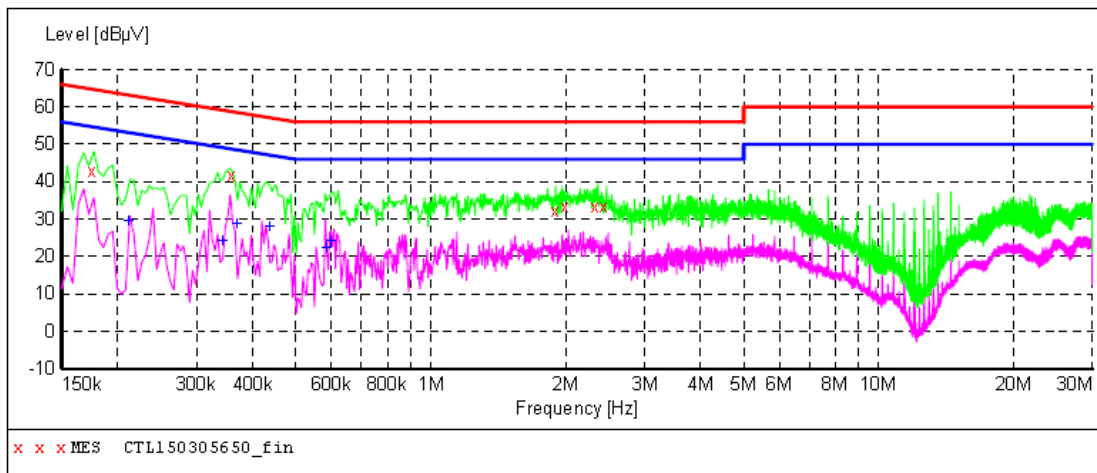

MEASUREMENT RESULT: "CTL150305650_fin"

3/5/2015 9:21AM

Frequency MHz	Level dBµV	Transd dB	Limit dBµV	Margin dB	Detector	Line	PE
0.174000	42.80	10.2	65	22.0	QP	L1	GND
0.358000	41.70	10.2	59	17.1	QP	L1	GND
1.886000	32.20	10.3	56	23.8	QP	L1	GND
1.988000	33.30	10.3	56	22.7	QP	L1	GND
2.318000	33.40	10.4	56	22.6	QP	L1	GND
2.426000	33.30	10.4	56	22.7	QP	L1	GND

MEASUREMENT RESULT: "CTL150305650_fin2"

3/5/2015 9:21AM

Frequency MHz	Level dBµV	Transd dB	Limit dBµV	Margin dB	Detector	Line	PE
0.210000	29.50	10.2	53	23.7	AV	L1	GND
0.342000	24.30	10.2	49	24.9	AV	L1	GND
0.366000	29.00	10.2	49	19.6	AV	L1	GND
0.434000	27.90	10.2	47	19.3	AV	L1	GND
0.584000	22.50	10.2	46	23.5	AV	L1	GND
0.596000	24.10	10.2	46	21.9	AV	L1	GND

Conducted Emission:

EUT: Accent 1400
M/N: ACN1400
Operating Condition: Tx Mode
Test Site: Shielded Room
Operator: Yang
Test Specification: AC 120V/60Hz for adapter
Comment: N Line

SCAN TABLE: "Voltage (9K-30M)FIN"
Short Description: 150K-30M Voltage

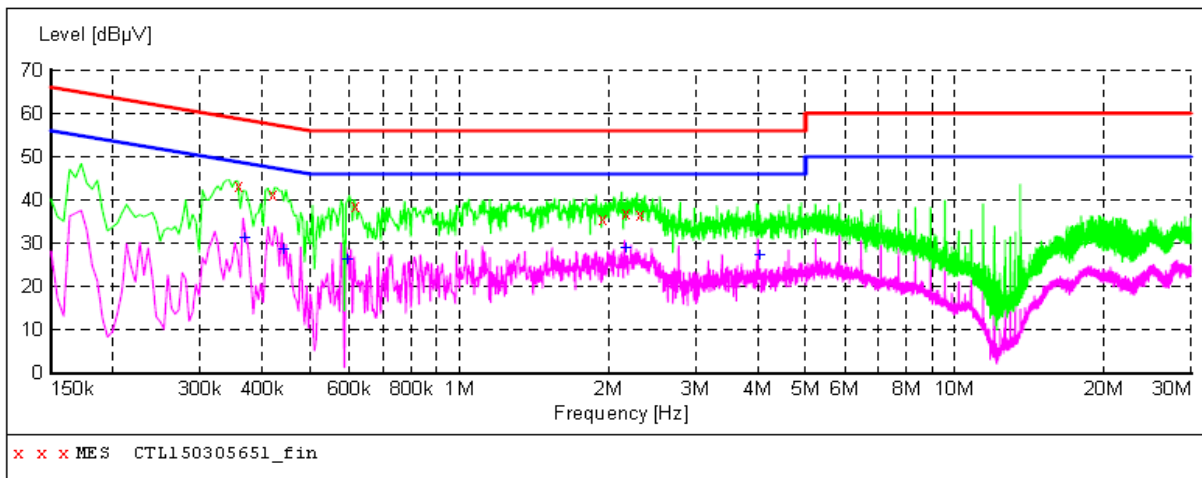

MEASUREMENT RESULT: "CTL150305651_fin"

3/5/2015 9:25AM

Frequency MHz	Level dBµV	Transd dB	Limit dBµV	Margin dB	Detector	Line	PE
0.358000	43.30	10.2	59	15.5	QP	N	GND
0.418000	41.10	10.2	58	16.4	QP	N	GND
0.614000	38.50	10.2	56	17.5	QP	N	GND
1.934000	35.50	10.3	56	20.5	QP	N	GND
2.162000	36.90	10.4	56	19.1	QP	N	GND
2.306000	36.50	10.4	56	19.5	QP	N	GND

MEASUREMENT RESULT: "CTL150305651_fin2"

3/5/2015 9:25AM

Frequency MHz	Level dBµV	Transd dB	Limit dBµV	Margin dB	Detector	Line	PE
0.366000	31.30	10.2	49	17.3	AV	N	GND
0.438000	28.80	10.2	47	18.3	AV	N	GND
0.590000	26.30	10.2	46	19.7	AV	N	GND
2.162000	29.10	10.4	46	16.9	AV	N	GND
4.010000	27.30	10.4	46	18.7	AV	N	GND

5. Test of Hopping Channel Bandwidth

5.1 Applicable Standard

Section 15.247(a)(1): Frequency hopping systems shall have hopping channel carrier frequencies separated by a minimum of 25 kHz or the 20 dB bandwidth of the hopping channel, whichever is greater.

5.2 EUT Setup

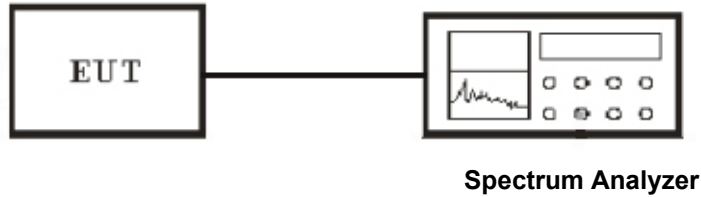

5.3 Test Equipment List and Details

See section 2.5.

5.4 Test Procedure

1. The transmitter output was connected to the spectrum analyzer through an attenuator.
2. Use the following spectrum analyzer settings:
Span = approximately 2 to 3 times the 20 dB bandwidth, centered on a hopping channel
RBW \geq 1% of the 20 dB bandwidth, VBW \geq RBW
Sweep = auto
Detector function = peak
Trace = max hold
3. The spectrum width with level higher than 20dB below the peak level.
4. Repeat above 1~3 points for the middle and highest channel of the EUT.

5.5 Test Result

Temperature (°C) : 22~23	EUT: Accent 1400
Humidity (%RH) : 50~54	M/N: ACN1400
Barometric Pressure (mbar) : 950~1000	Operation Condition: Tx Mode

BDR 1M

Modulation Type	Channel No.	Frequency (MHz)	20dB Bandwidth (kHz)
GFSK	Low	2402.00	920
GFSK	Middle	2441.00	924
GFSK	High	2480.00	944

EDR 2M

Modulation Type	Channel No.	Frequency (MHz)	20dB Bandwidth (kHz)
Pi/4 DQPSK	Low	2402.00	1212
Pi/4 DQPSK	Middle	2441.00	1228
Pi/4 DQPSK	High	2480.00	1228

EDR 3M

Modulation Type	Channel No.	Frequency (MHz)	20dB Bandwidth (kHz)
8-DPSK	Low	2402.00	1212
8-DPSK	Middle	2441.00	1216
8-DPSK	High	2480.00	1216

**BDR 1M
Channel Low**



Channel Middle

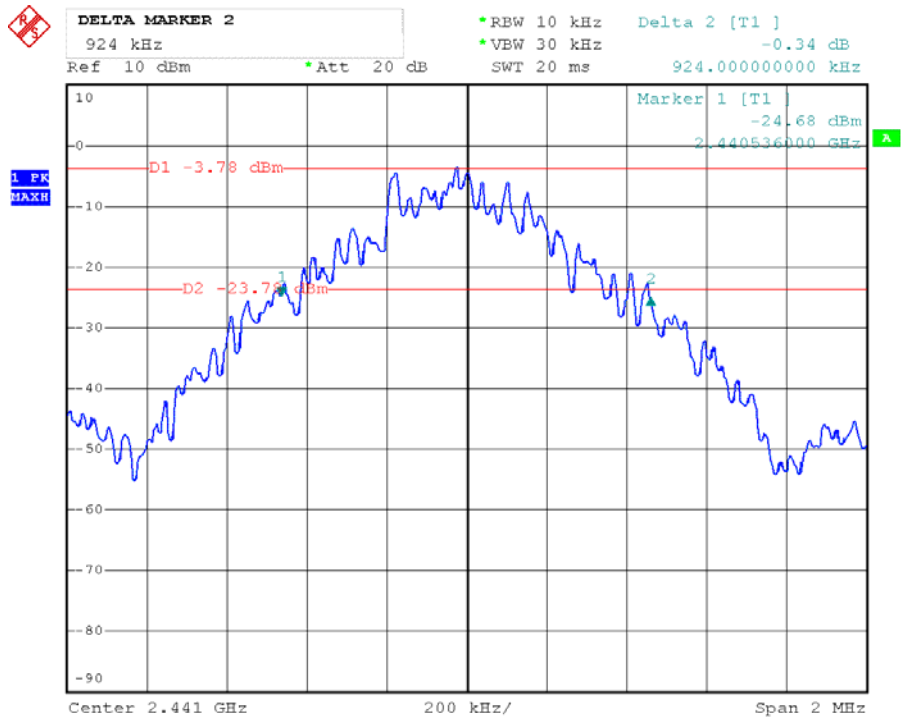

Channel High

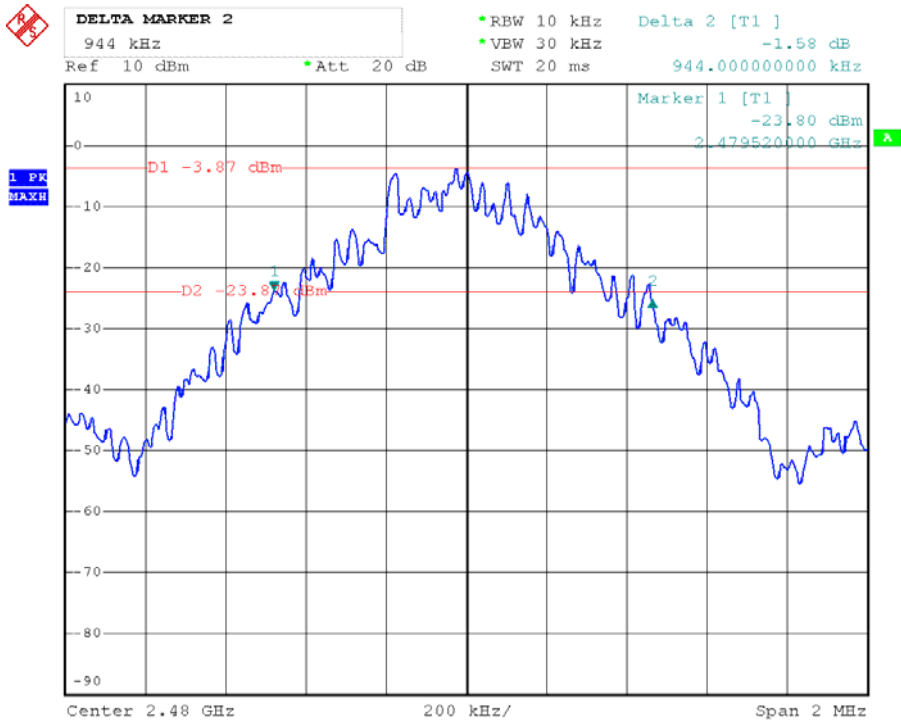

**EDR 2M
Channel Low**

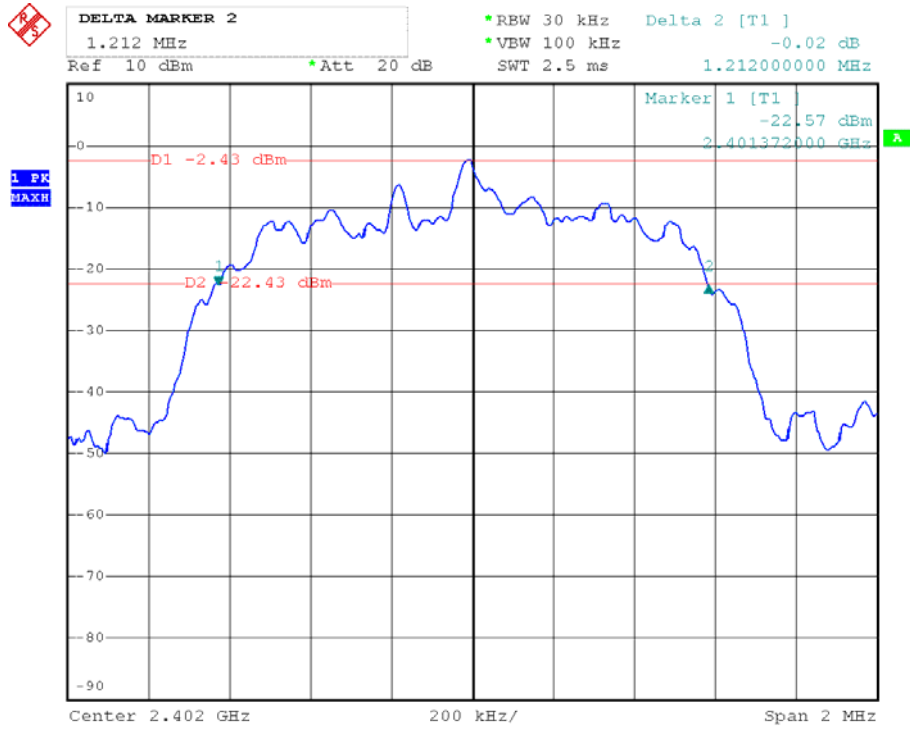

Channel Middle

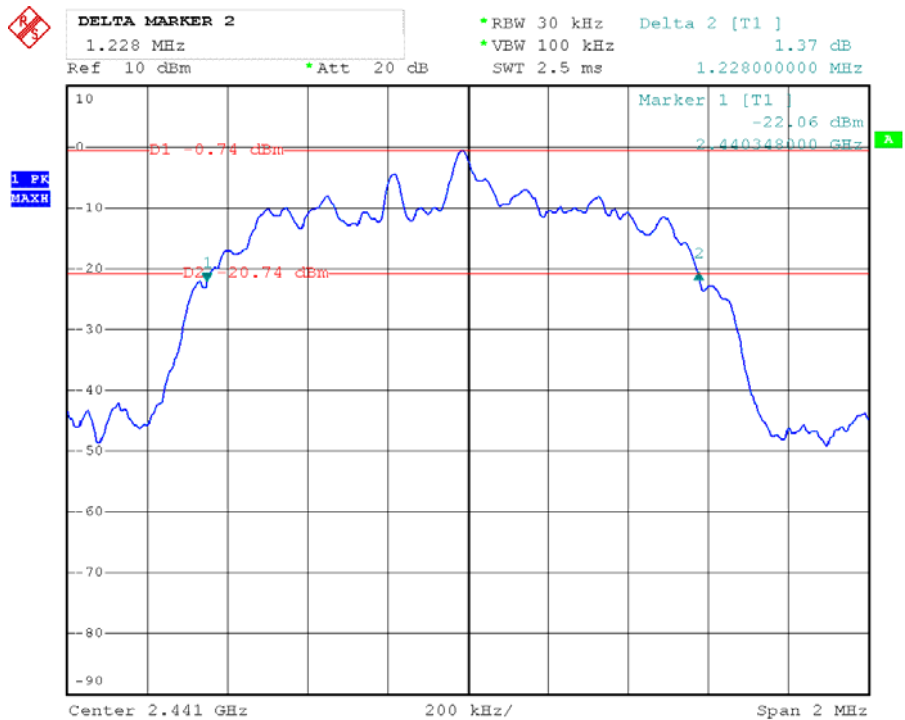

Channel High

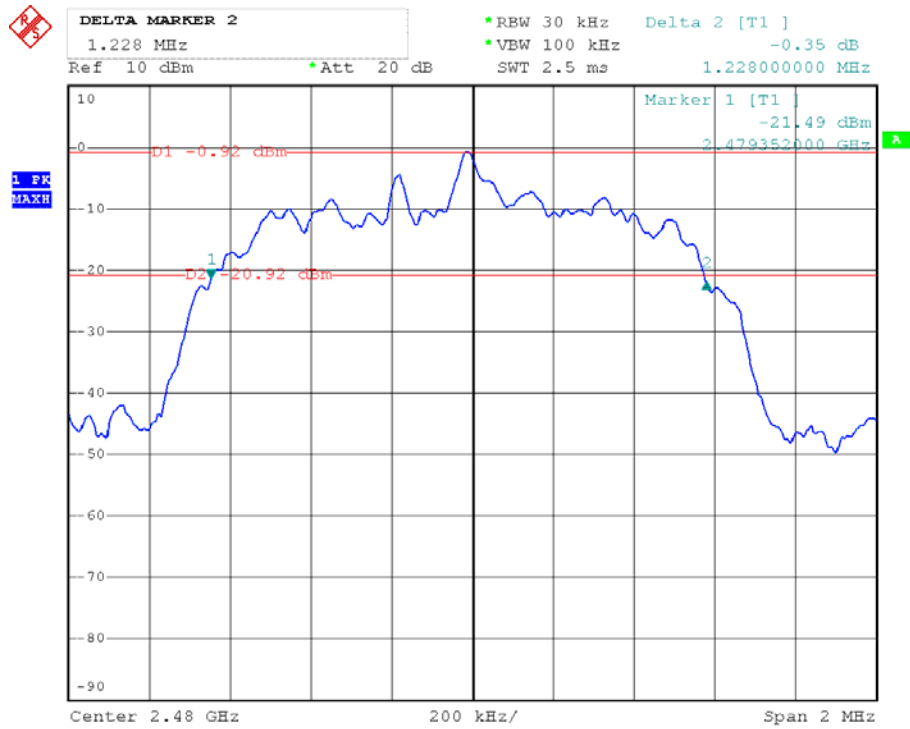

EDR 3M Channel Low

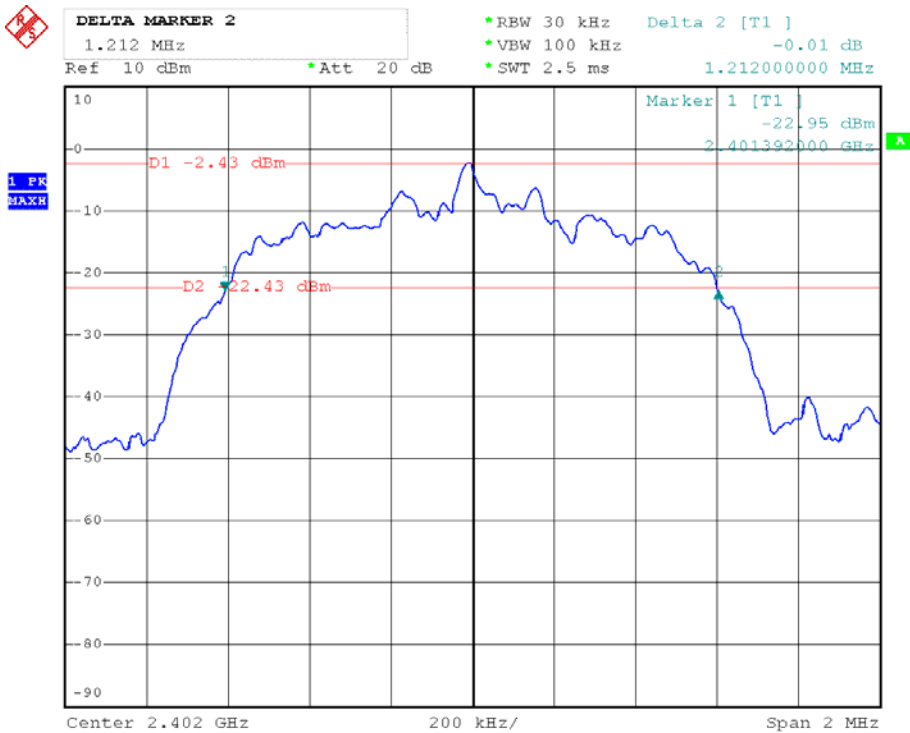

Channel Middle

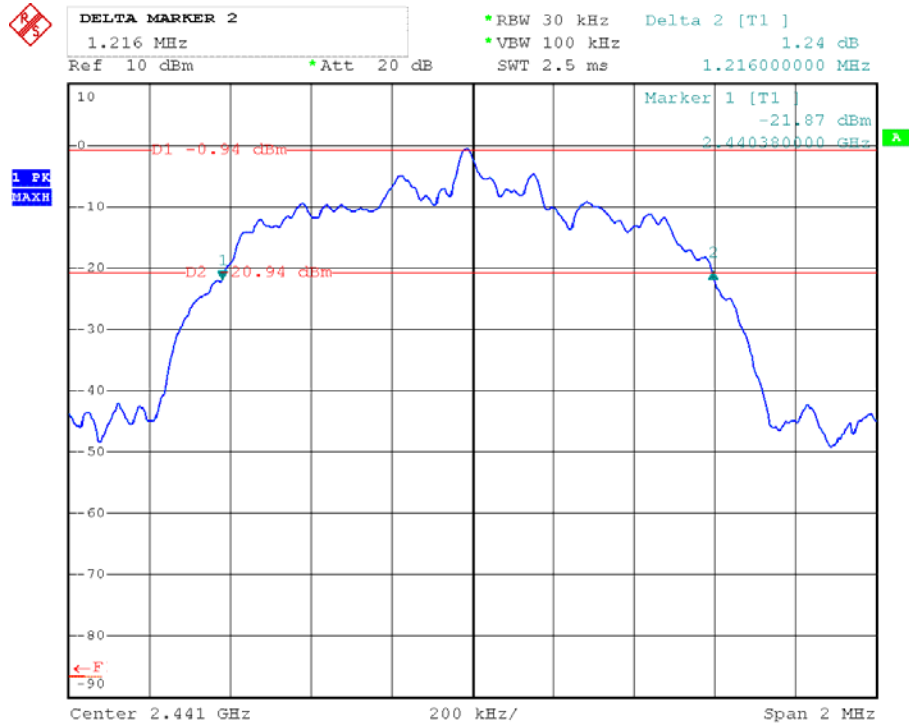

Channel High

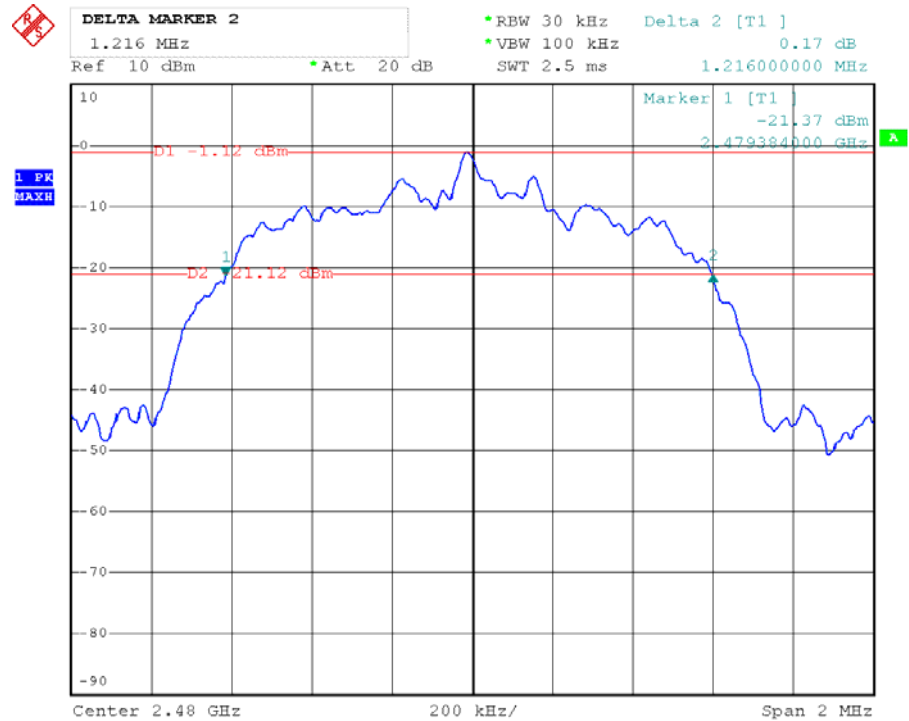

6. Test of Hopping Channel Separation

6.1 Applicable Standard

Section 15.247(a)(1): Frequency hopping systems shall have hopping channel carrier frequencies separated by a minimum of 25 kHz or the 20 dB bandwidth of the hopping channel, whichever is greater.

6.2 EUT Setup

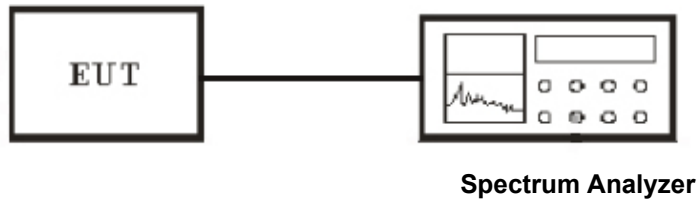

6.3 Test Equipment List and Details

See section 2.5.

6.4 Test Procedure

1. The transmitter output was connected to the spectrum analyzer through an attenuator.
2. Set RBW of spectrum analyzer to 30KHz and VBW to 100KHz.
3. Set Detector to Peak, Trace to Max Hold and Sweep Time is Auto.
4. The Hopping Channel Separation is defined as the separation between 2 neighboring hopping frequencies.
5. Repeat above 1~3 points for the middle and highest channel of the EUT.

6.5 Test Result

Temperature (°C) : 22~23	EUT: Accent 1400
Humidity (%RH) : 50~54	M/N: ACN1400
Barometric Pressure (mbar) : 950~1000	Operation Condition: Tx Mode

BDR 1M

Modulation Type	Frequency (MHz)	Channel Separation (MHz)	Min. Limit (kHz)
GFSK	2402~2403	1.008	>25
GFSK	2441~2442	1.000	>25
GFSK	2479~2480	1.004	>25

EDR 2M

Modulation Type	Frequency (MHz)	Channel Separation (MHz)	Min. Limit (kHz)
Pi/4 DQPSK	2402~2403	1.004	>25
Pi/4 DQPSK	2441~2442	1.008	>25
Pi/4 DQPSK	2479~2480	1.000	>25

EDR 3M

Modulation Type	Frequency (MHz)	Channel Separation (MHz)	Min. Limit (kHz)
8-DPSK	2402~2403	1.000	>25
8-DPSK	2441~2442	1.000	>25
8-DPSK	2479~2480	1.000	>25

**BDR 1M
Channel Low**

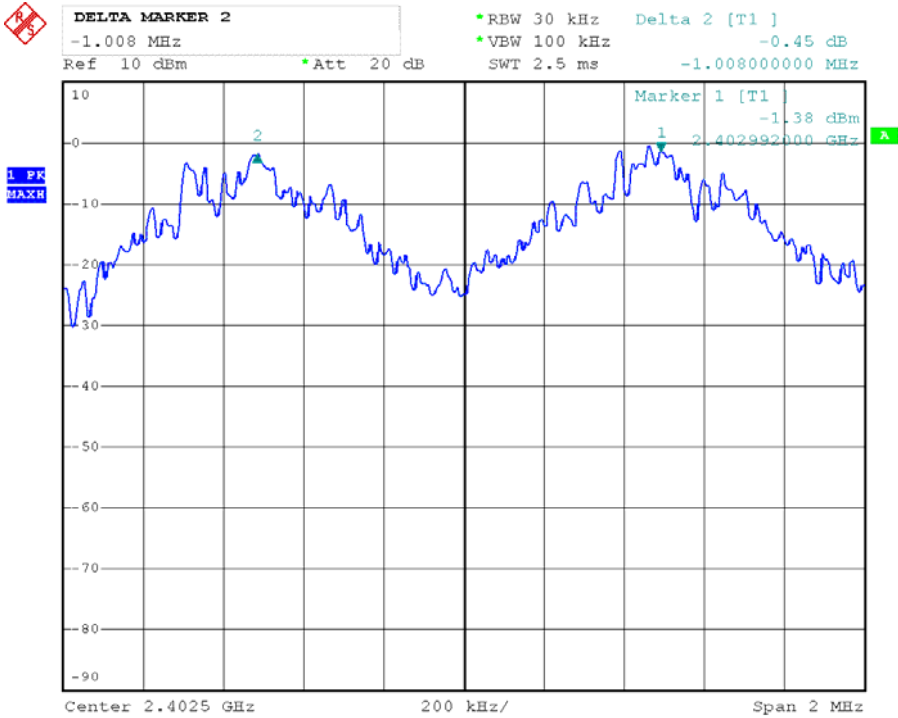

Channel Middle

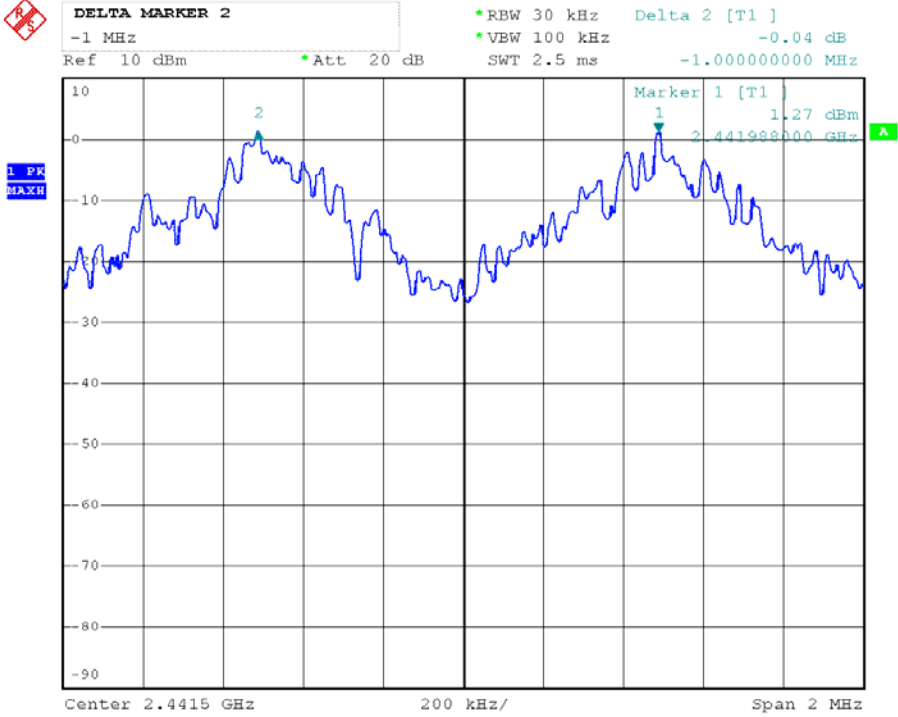

Channel High

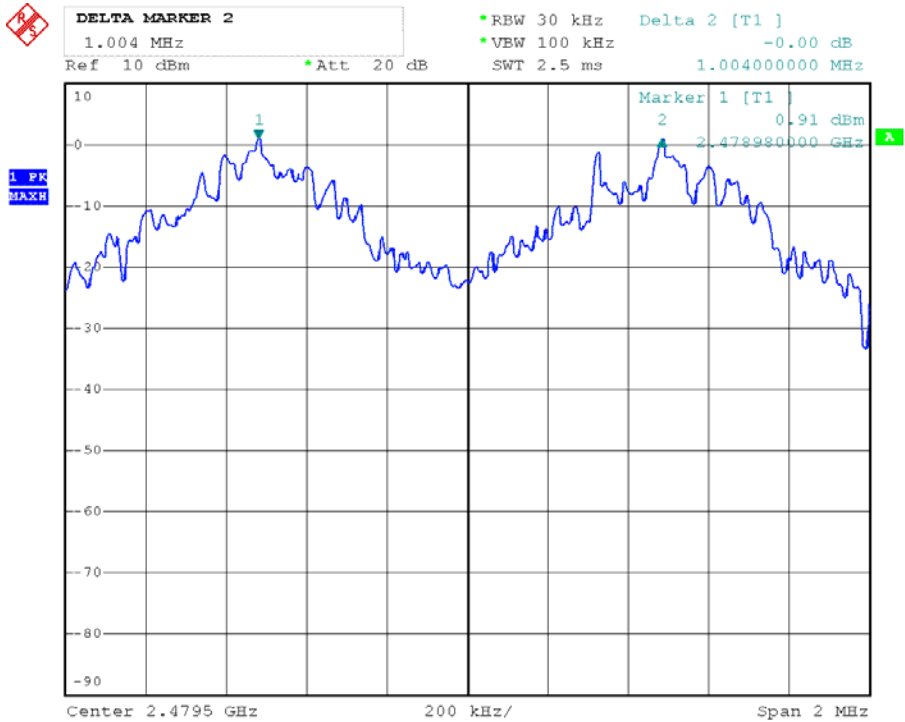

EDR 2M Channel Low

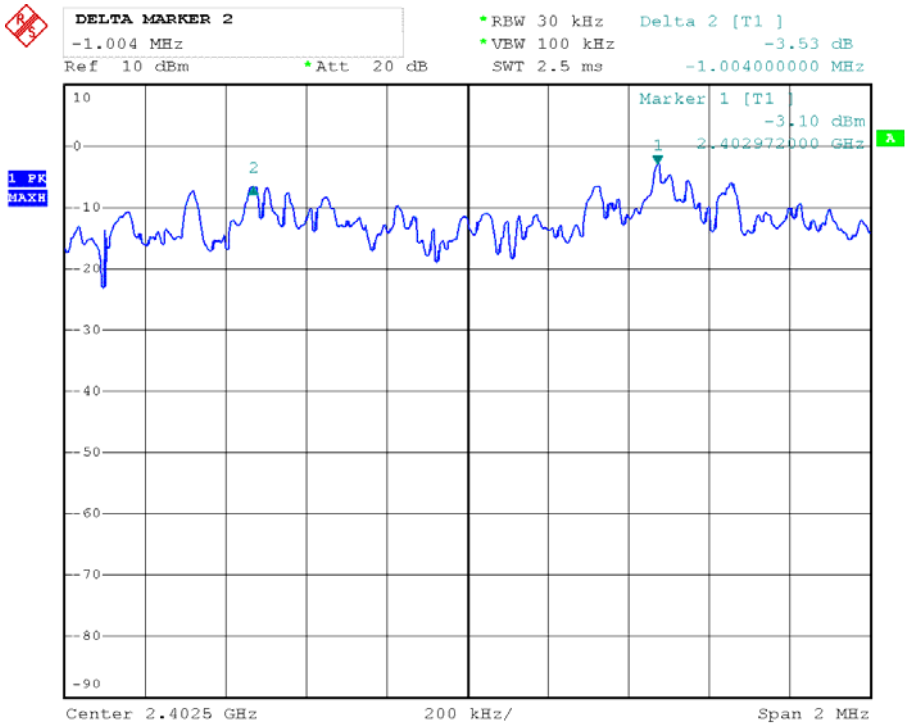

Channel Middle

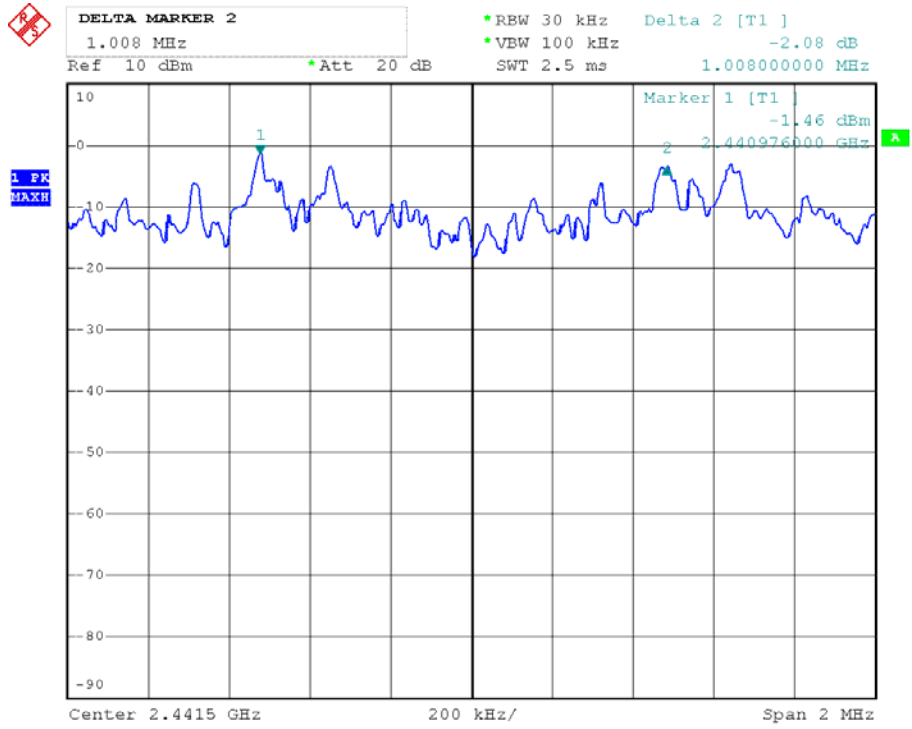

Channel High

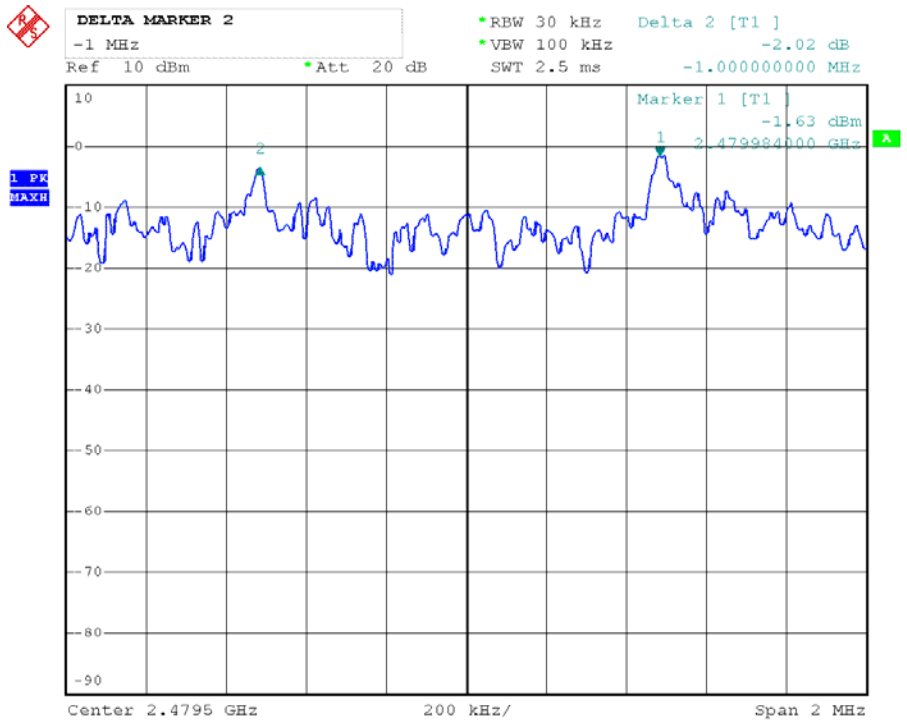

**EDR 3M
Channel Low**

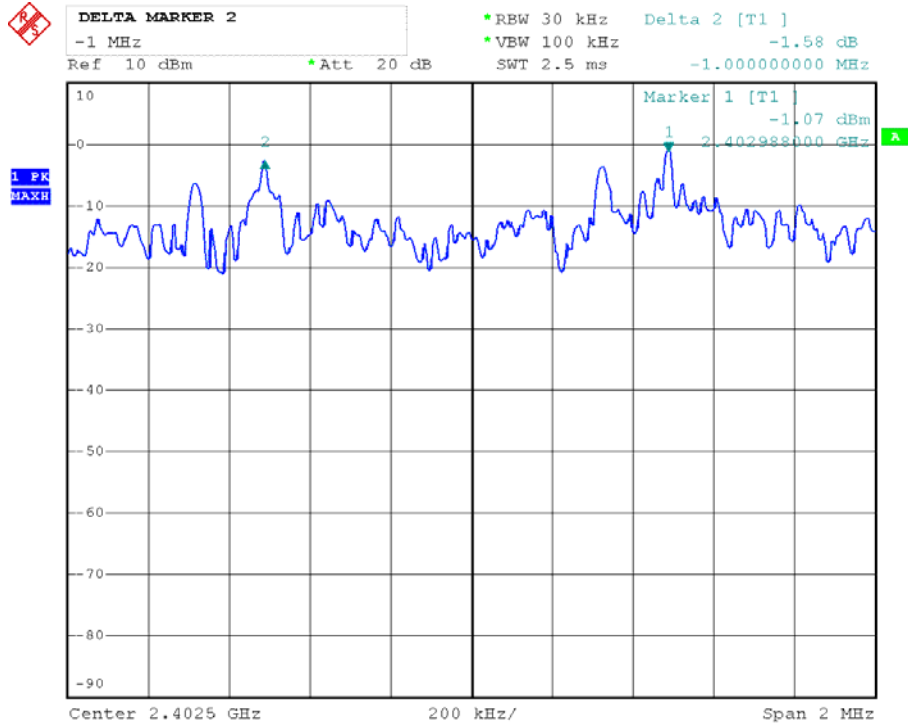

Channel Middle

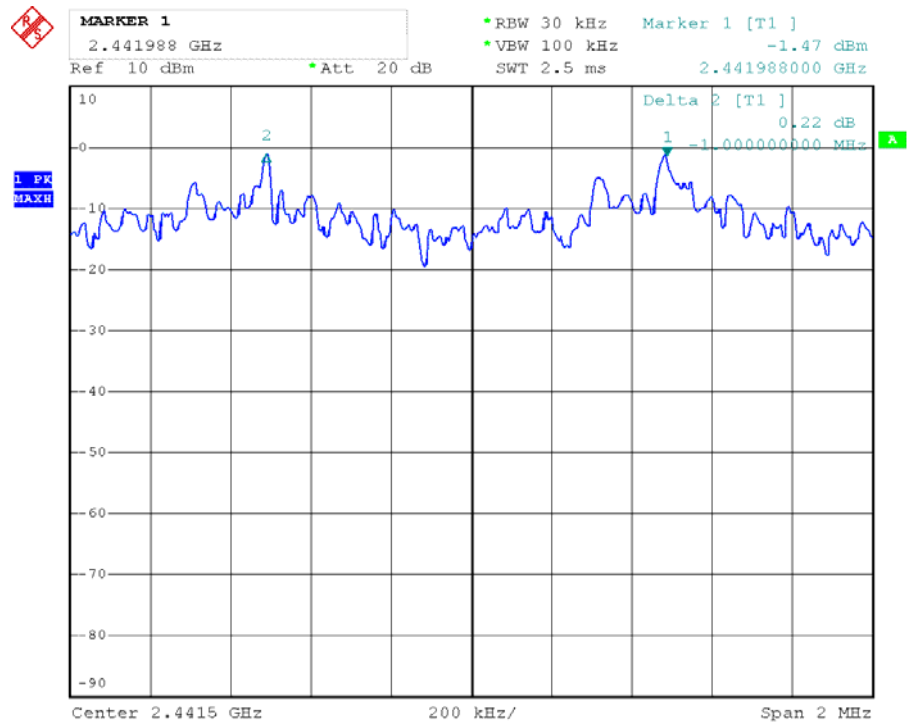

Channel High

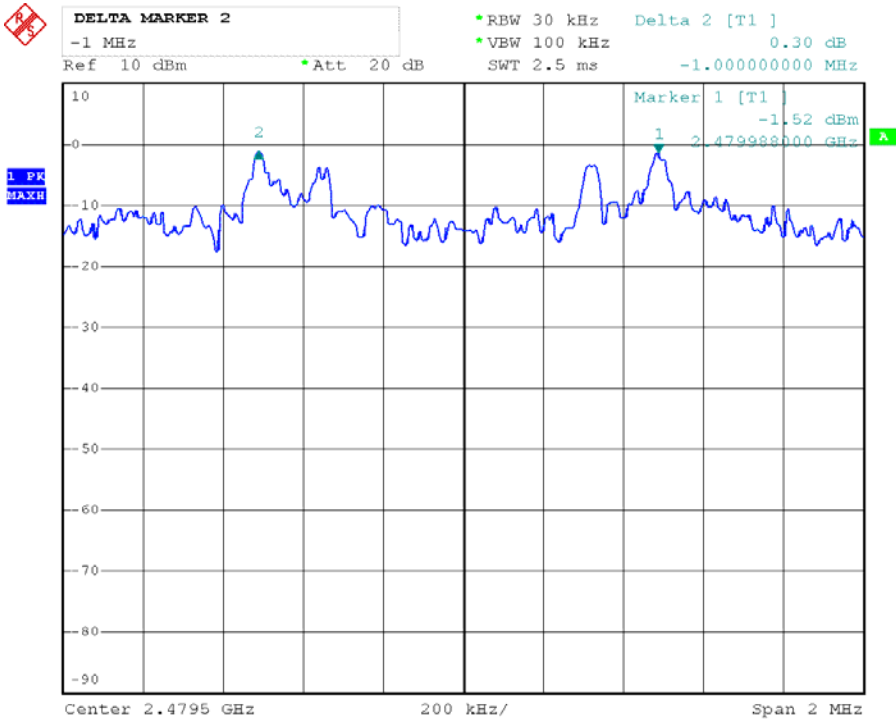

7. Test of Number of Hopping Frequency

7.1 Applicable Standard

Section 15.247(a)(1)(iii): For frequency hopping systems operating in the 2400-2483.5 MHz band employing at least 15 non-overlapping hopping channels. Frequency hopping system which use fewer than 75 hopping frequencies may employ intelligent hopping techniques to avoid interference to other transmissions. Frequency hopping system may avoid or suppress transmissions on a particular hopping frequency provided that a minimum of 15 non-overlapping channels are used.

7.2 EUT Setup

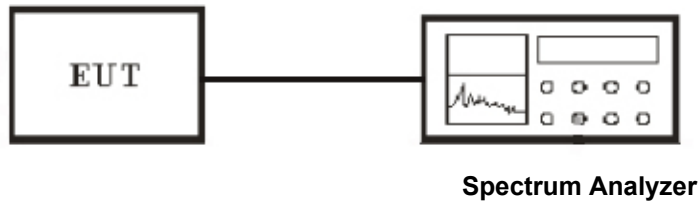

7.3 Test Equipment List and Details

See section 2.5.

7.4 Test Procedure

1. The transmitter output was connected to the spectrum analyzer through an attenuator.
2. Set RBW of spectrum analyzer to 100KHz and VBW to 100KHz.
3. Set Detector to Peak, Trace to Max Hold and Sweep Time is Auto.
4. Observe frequency hopping in 2400MHz~2483.5MHz, there are at least 32 non-overlapping channels.
5. Repeat above 1~3 points for the middle and highest channel of the EUT.

7.5 Test Result

Temperature (°C) : 22~23	EUT: Accent 1400
Humidity (%RH) : 50~54	M/N: ACN1400
Barometric Pressure (mbar) : 950~1000	Operation Condition: Tx Mode

Modulation Type	Frequency (MHz)	Number of Hopping Channels	Min. Limit
GFSK	2402~2480	79	≥ 15
Pi/4 DQPSK	2402~2480	79	≥ 15
8-DPSK	2402~2480	79	≥ 15

BDR-1M

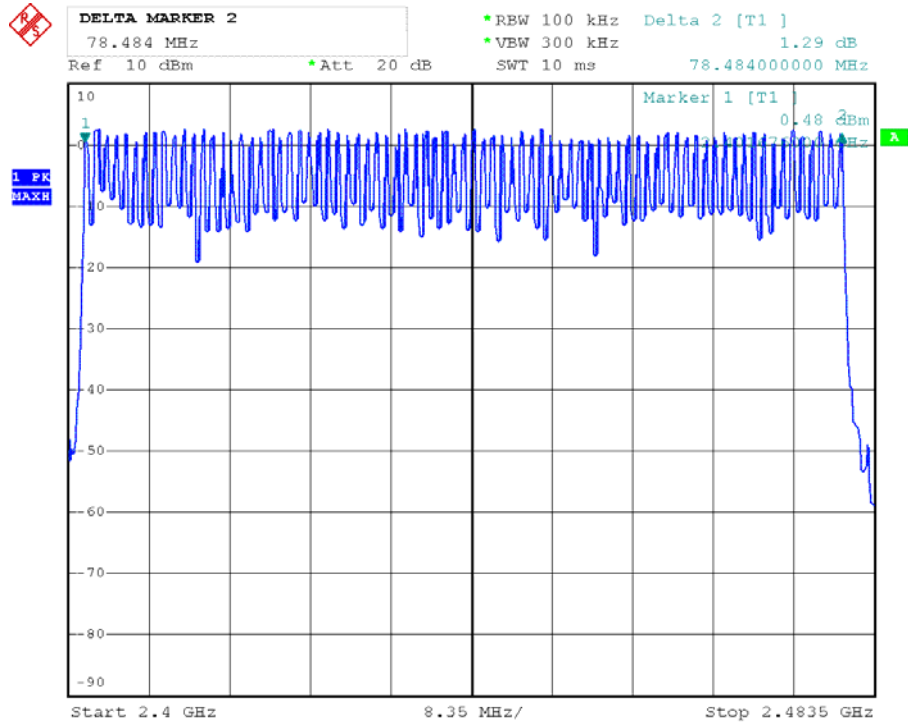

EDR-2M

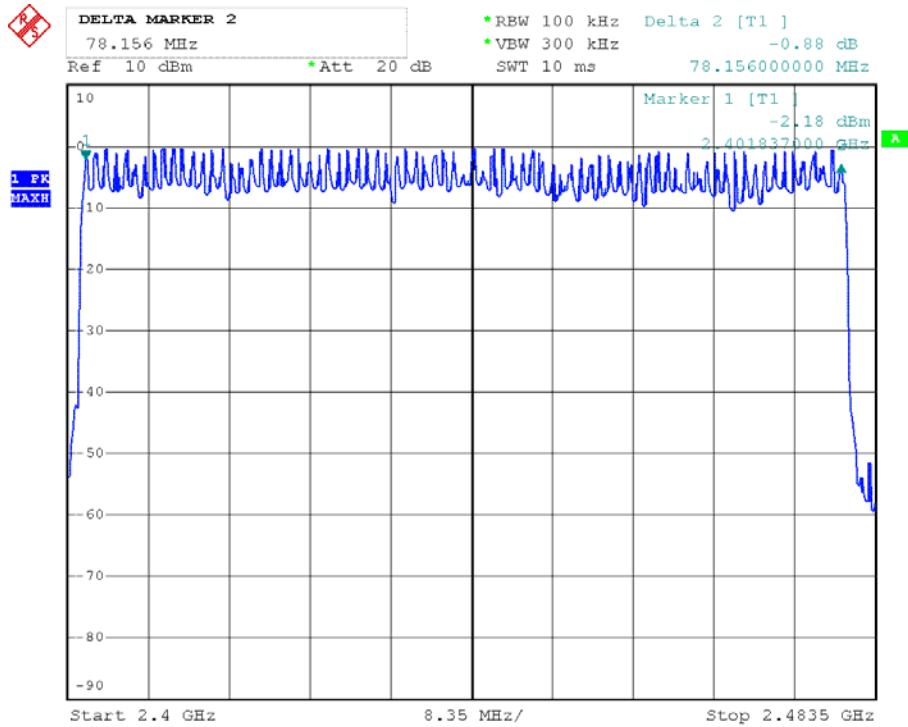

EDR-3M

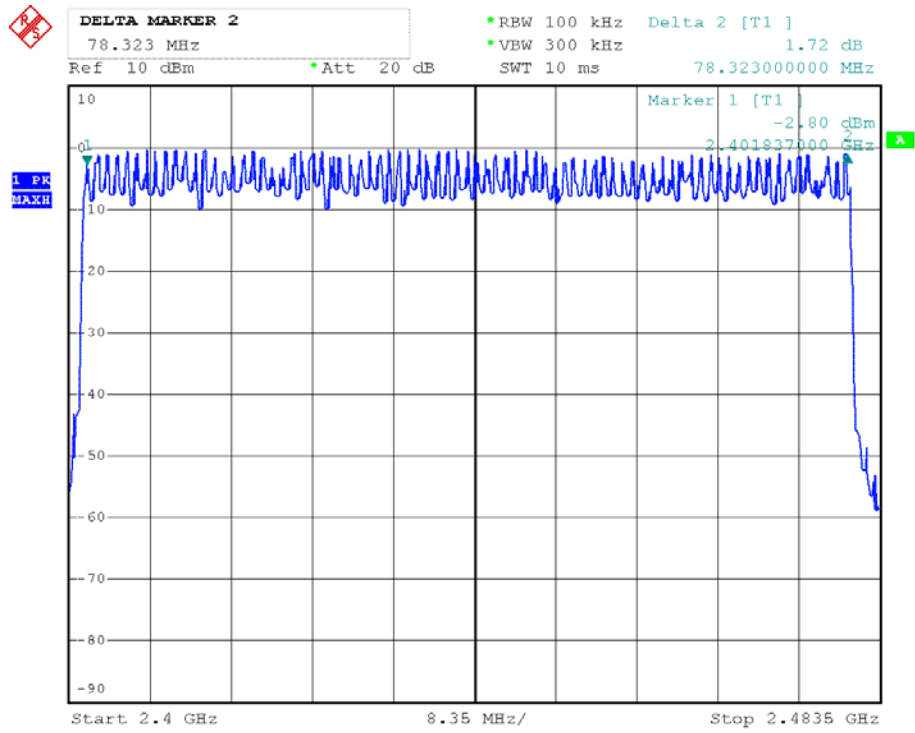

8. Test of Dwell Time of Each Frequency

8.1 Applicable Standard

Section 15.247(a)(1)(iii): For frequency hopping systems operating in the 2400-2483.5 MHz band The average time of occupancy on any channel shall not be greater than 0.4 seconds within a period of 0.4seconds multiplied by the number of hopping channels employed.

8.2 EUT Setup

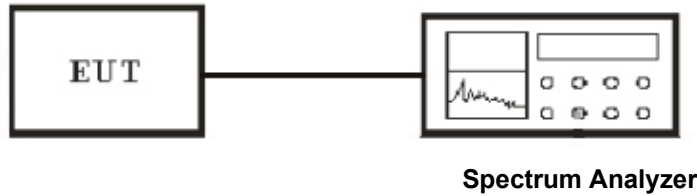

8.3 Test Equipment List and Details

See section 2.5.

8.4 Test Procedure

1. The transmitter output was connected to the spectrum analyzer through an attenuator.
2. Set RBW of spectrum analyzer to 1000kHz and VBW to 1000kHz.
3. Set Detector to Peak, Trace to Max Hold and Sweep Time is more than once pulse time.
4. Set the center frequency on any frequency would be measure and set the frequency span to zero span.
5. Measure the maximum time duration of one single pulse.

8.5 Test Result

Temperature (°C) : 22~23	EUT: Accent 1400
Humidity (%RH) : 50~54	M/N: ACN1400
Barometric Pressure (mbar) : 950~1000	Operation Condition: Tx Mode

DH1

Dwell time= $t \cdot (1.6/2/79) \cdot 31.6$

DH3

Dwell time= $t \cdot (1.6/4/79) \cdot 31.6$

DH5

Dwell time= $t \cdot (1.6/6/79) \cdot 31.6$

BDR 1M
Low Channel

Modulation Type		Reading (ms)	Dwell Time (ms)	Limit (ms)
GFSK	DH1	0.384	122.88	400
GFSK	DH3	1.640	262.40	400
GFSK	DH5	2.888	309.02	400

Middle Channel

Modulation Type		Reading (ms)	Dwell Time (ms)	Limit (ms)
GFSK	DH1	0.385	123.20	400
GFSK	DH3	1.620	259.20	400
GFSK	DH5	2.888	309.02	400

High Channel

Modulation Type		Reading (ms)	Dwell Time (ms)	Limit (ms)
GFSK	DH1	0.385	123.20	400
GFSK	DH3	1.620	259.20	400
GFSK	DH5	2.888	309.02	400

EDR 2M
Low Channel

Modulation Type		Reading (ms)	Dwell Time (ms)	Limit (ms)
Pi/4 DQPSK	2DH1	0.395	126.40	400
Pi/4 DQPSK	2DH3	1.645	263.20	400
Pi/4 DQPSK	2DH5	2.909	311.26	400

Middle Channel

Modulation Type		Reading (ms)	Dwell Time (ms)	Limit (ms)
Pi/4 DQPSK	2DH1	0.395	126.40	400
Pi/4 DQPSK	2DH3	1.645	263.20	400
Pi/4 DQPSK	2DH5	2.877	307.84	400

High Channel

Modulation Type		Reading (ms)	Dwell Time (ms)	Limit (ms)
Pi/4 DQPSK	2DH1	0.395	126.40	400
Pi/4 DQPSK	2DH3	1.645	263.20	400
Pi/4 DQPSK	2DH5	2.877	307.84	400

**EDR 3M
Low Channel**

Modulation Type		Reading (ms)	Dwell Time (ms)	Limit (ms)
8-DPSK	3DH1	0.400	128.00	400
8-DPSK	3DH3	1.640	262.40	400
8-DPSK	3DH5	2.896	308.97	400

Middle Channel

Modulation Type		Reading (ms)	Dwell Time (ms)	Limit (ms)
8-DPSK	3DH1	0.400	128.00	400
8-DPSK	3DH3	1.640	262.40	400
8-DPSK	3DH5	2.896	308.97	400

High Channel

Modulation Type		Reading (ms)	Dwell Time (ms)	Limit (ms)
8-DPSK	3DH1	0.405	129.60	400
8-DPSK	3DH3	1.640	262.40	400
8-DPSK	3DH5	2.896	308.97	400

**BDR-DH1
Channel Low**

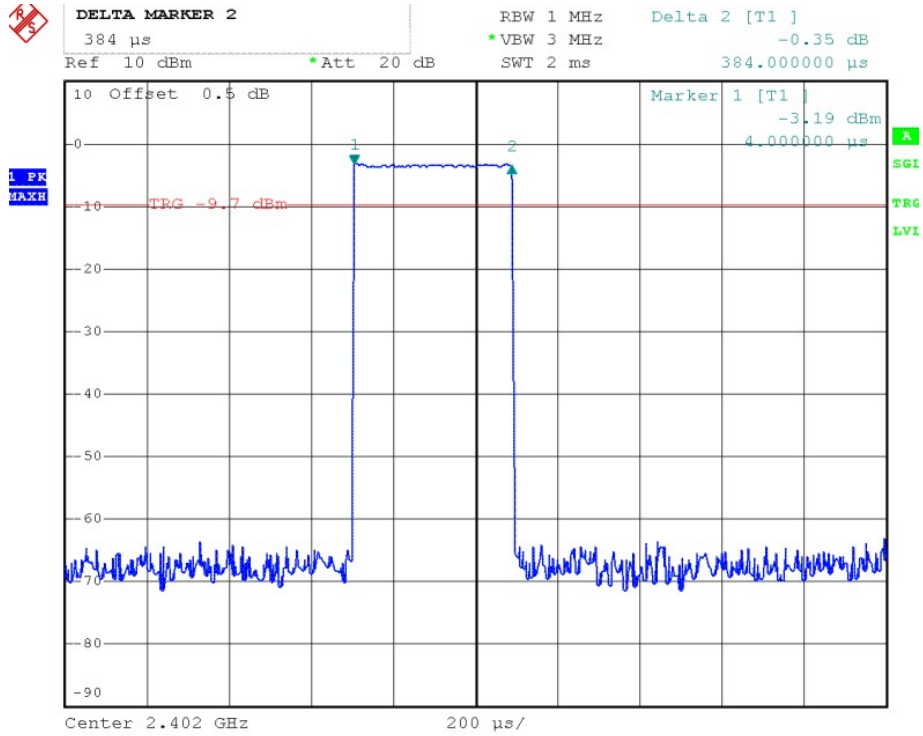

Channel Middle

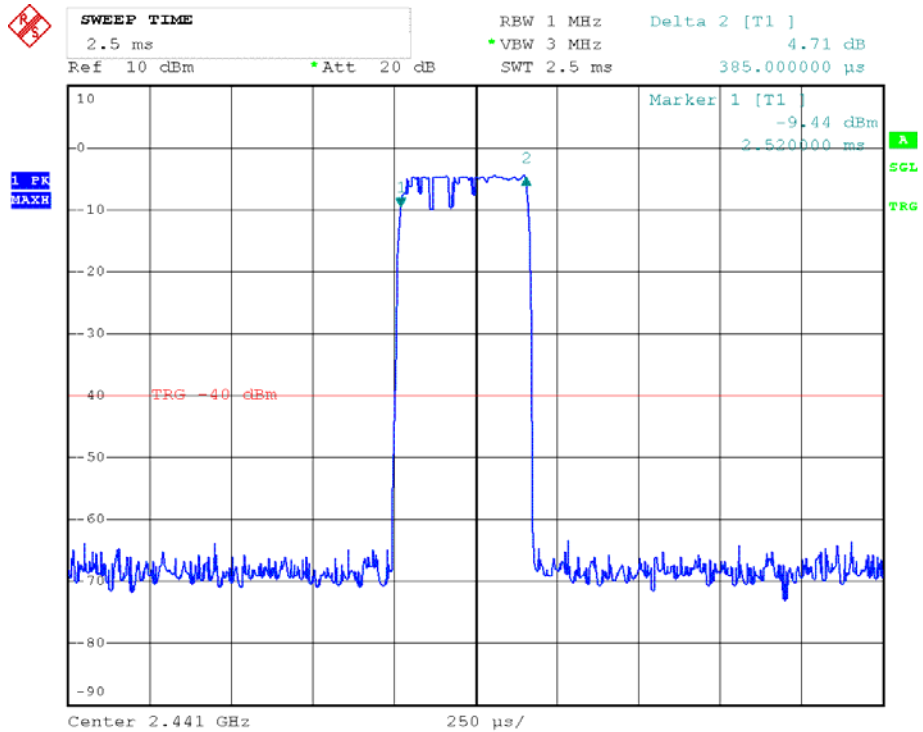

Channel High

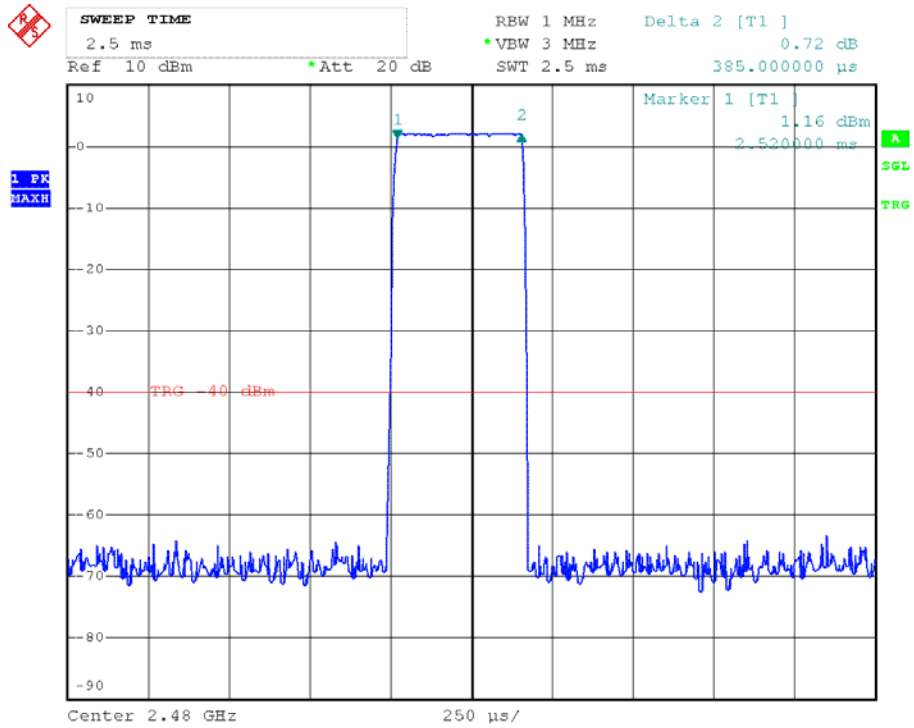

DH3 Channel Low

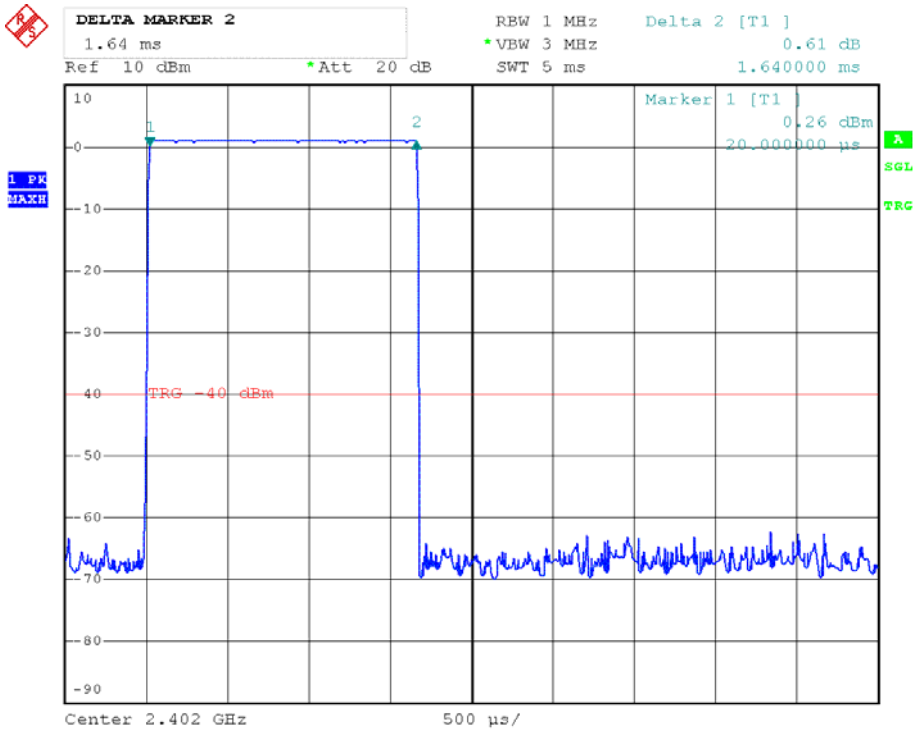

Channel Middle

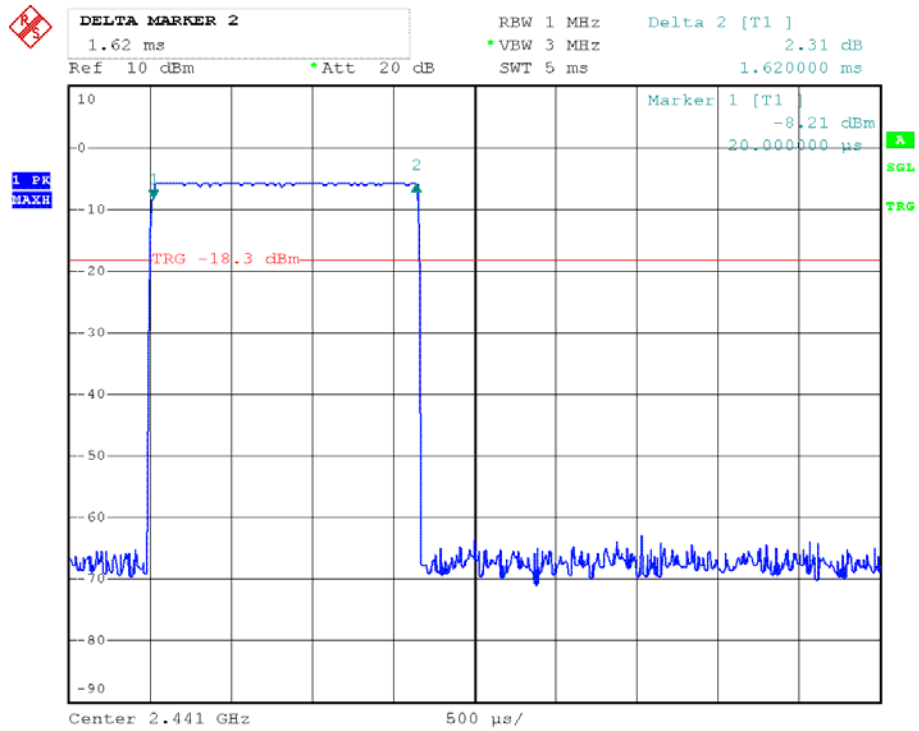

Channel High

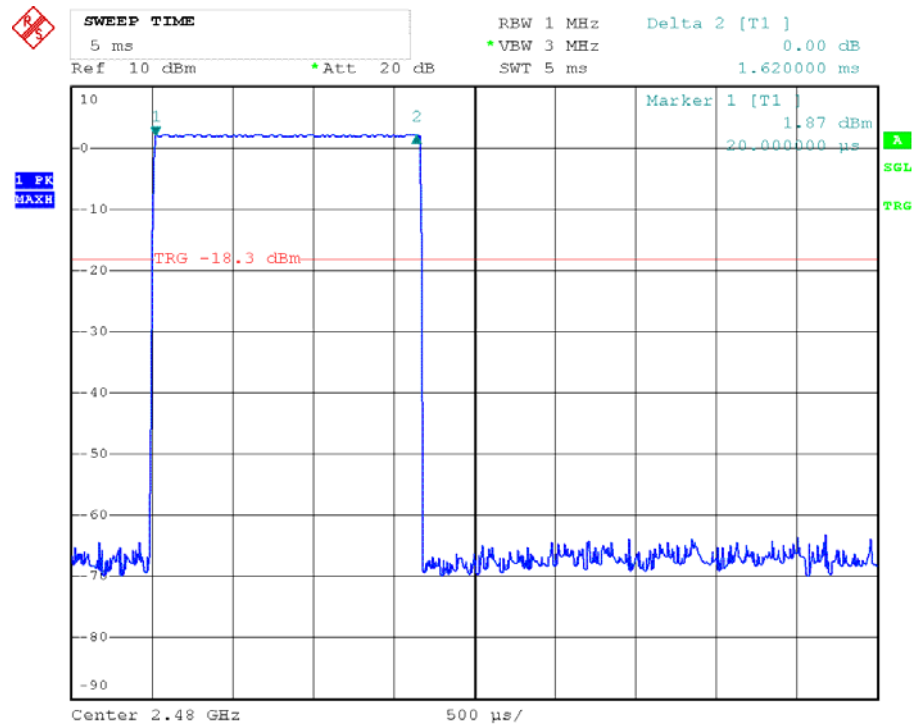

DH5 Channel Low

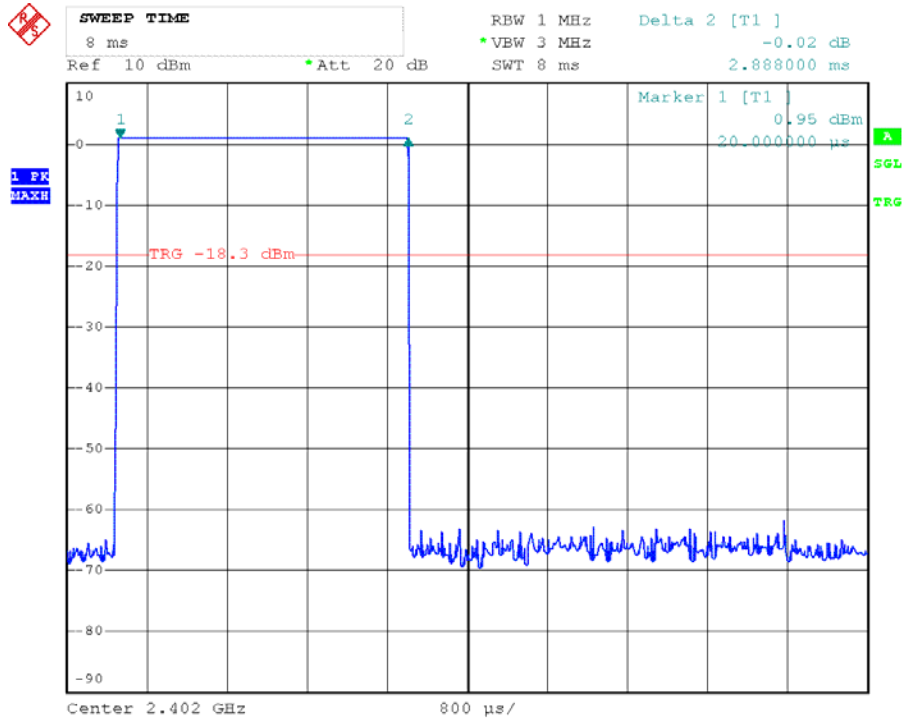

Channel Middle

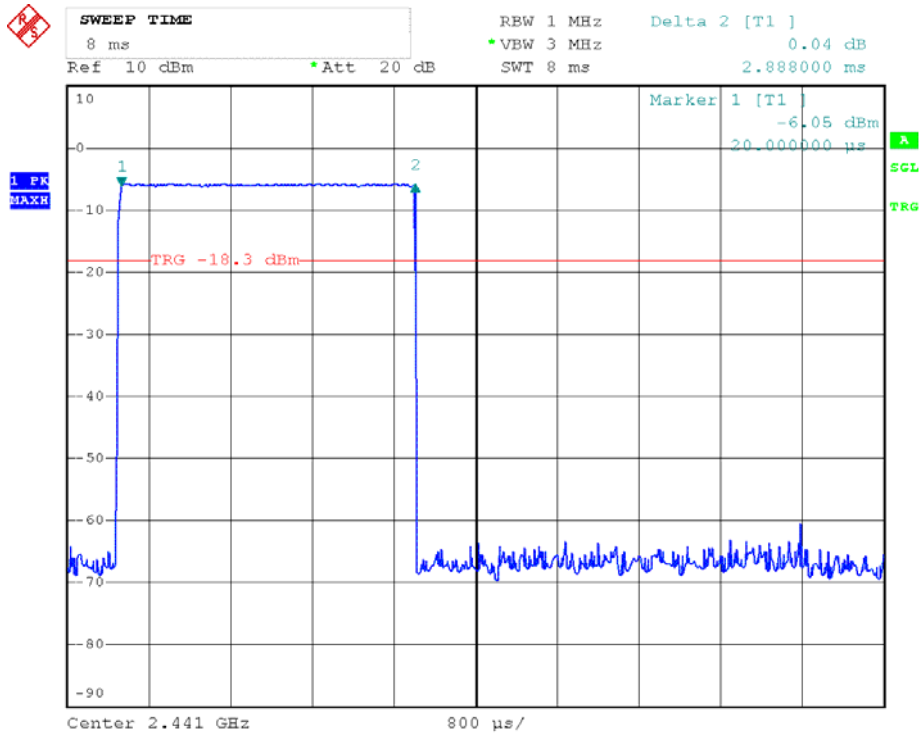

Channel High

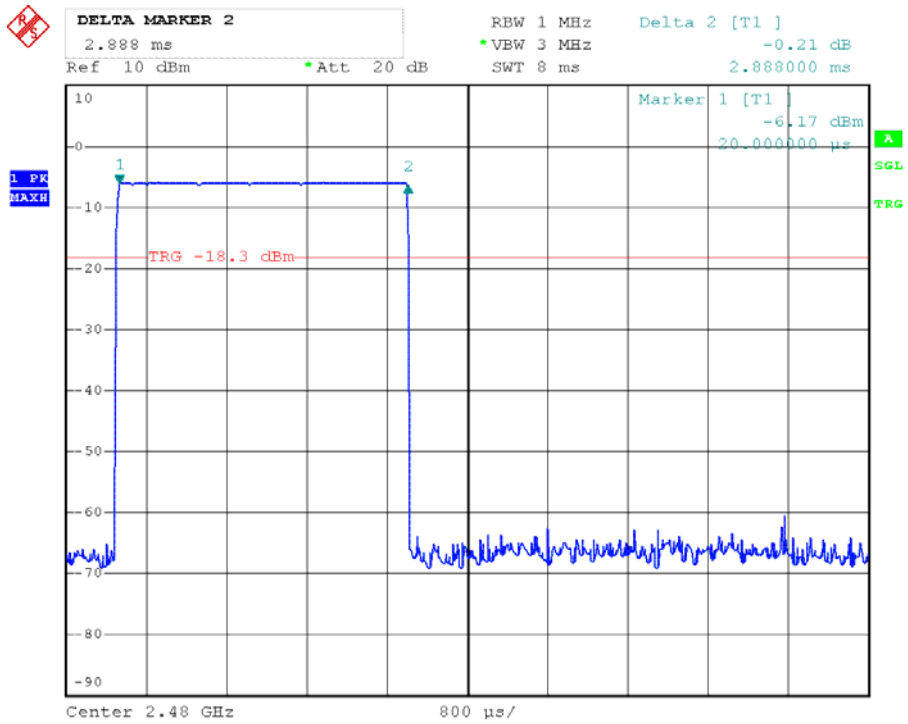

EDR 2M 2DH1 Channel Low

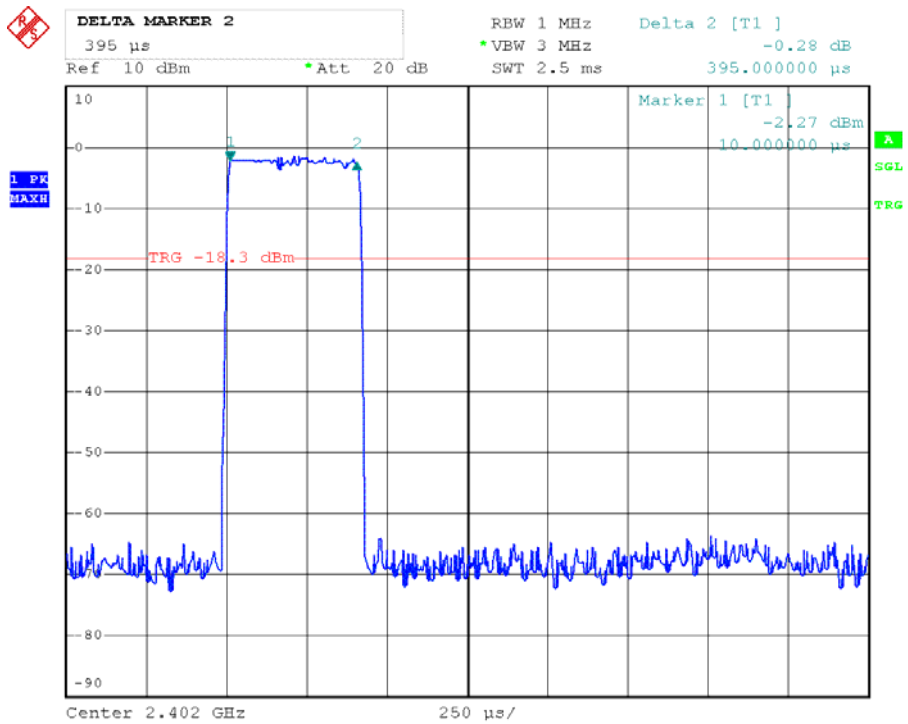

Channel Middle

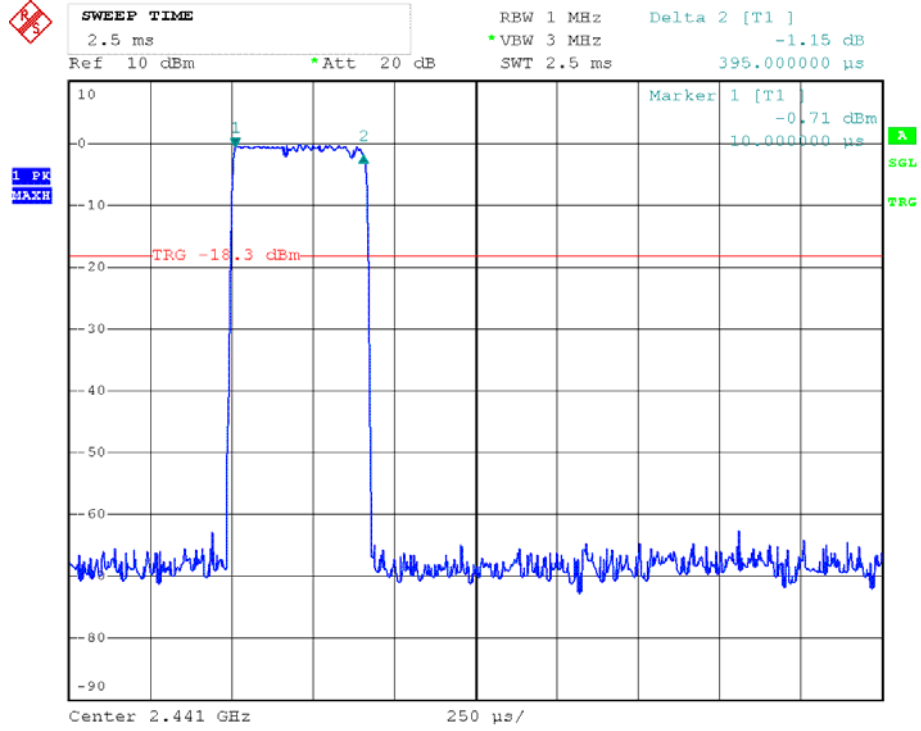

Channel High

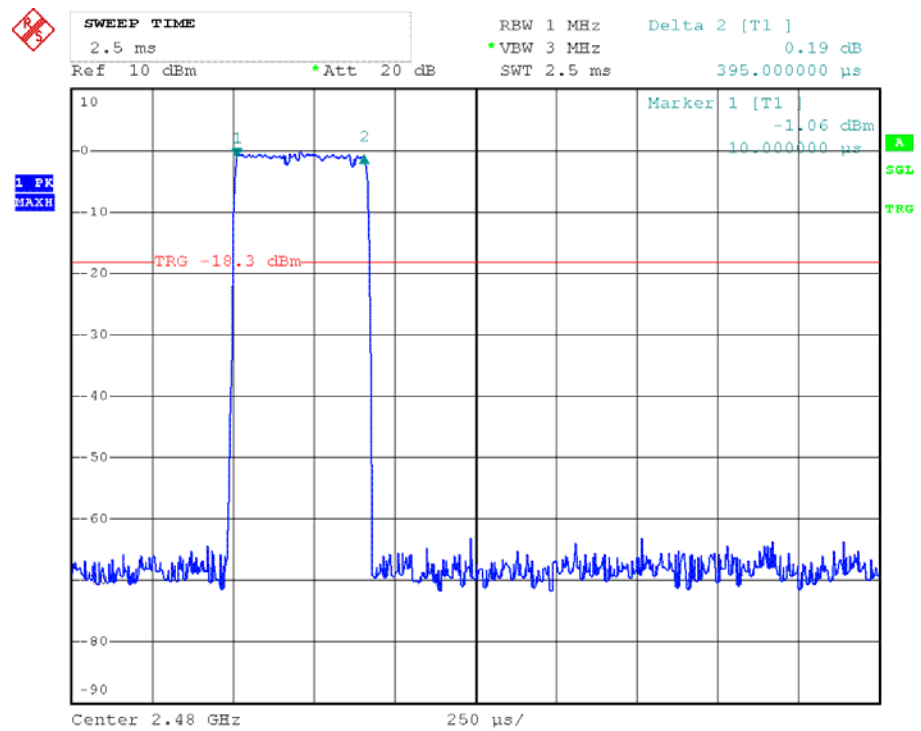

**EDR 2M 2DH3
Channel Low**

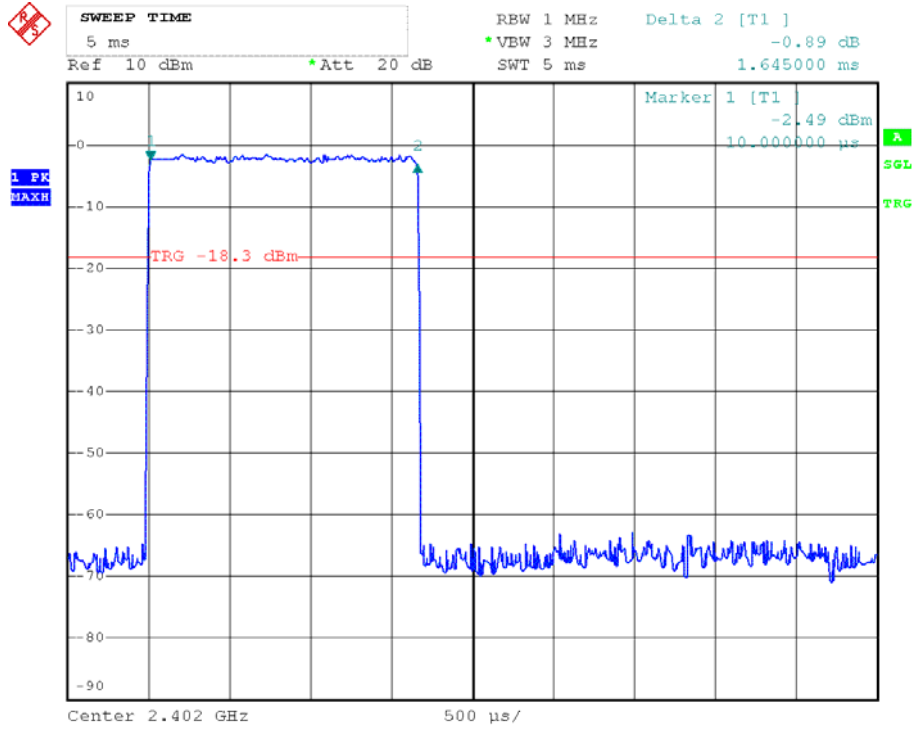

Channel Middle

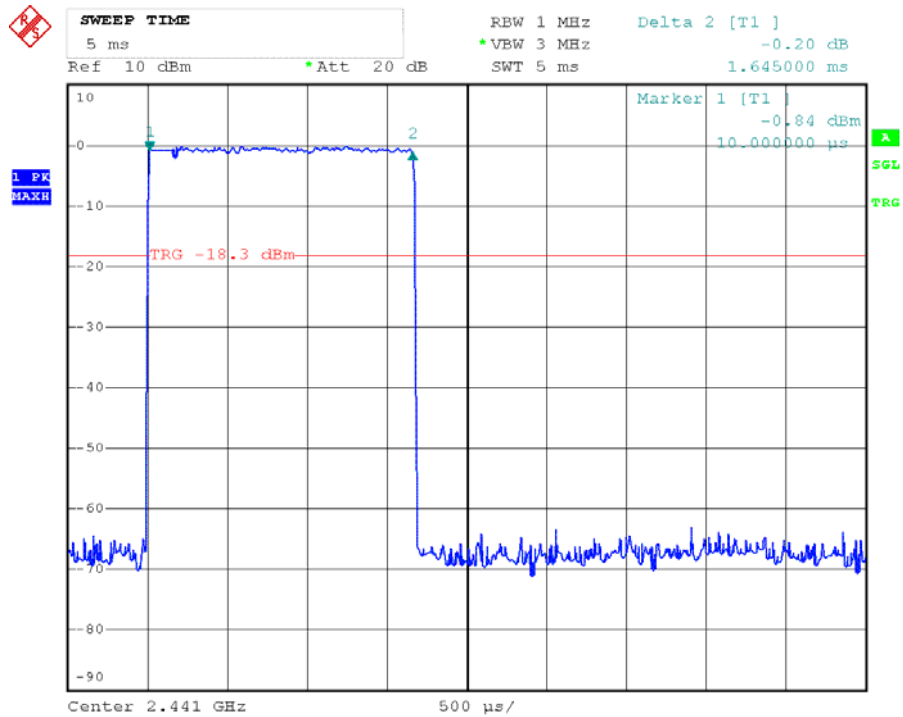

Channel High

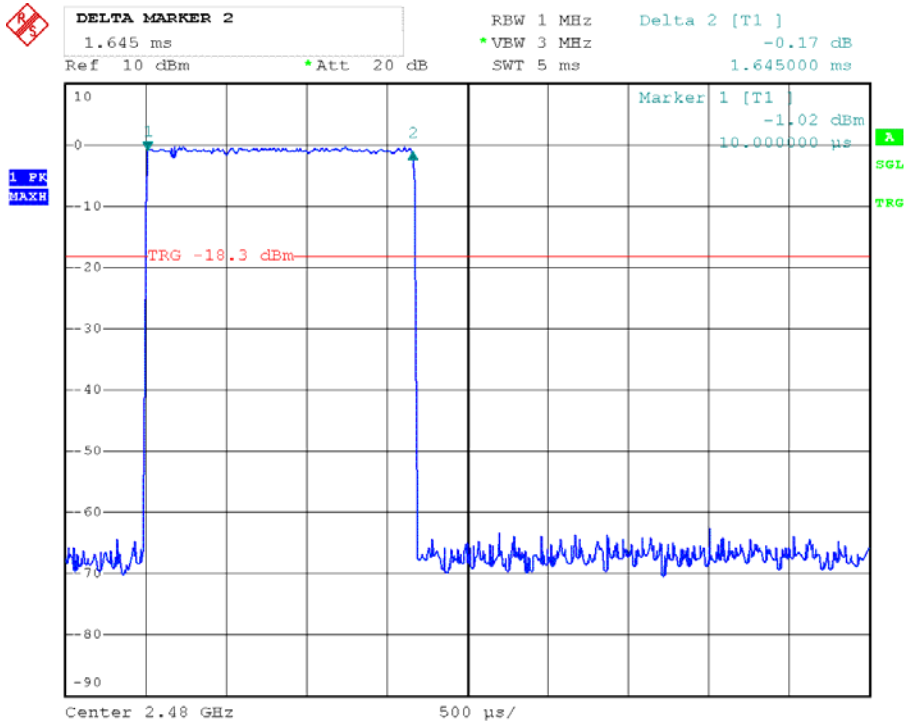

EDR 2M 2DH5 Channel Low

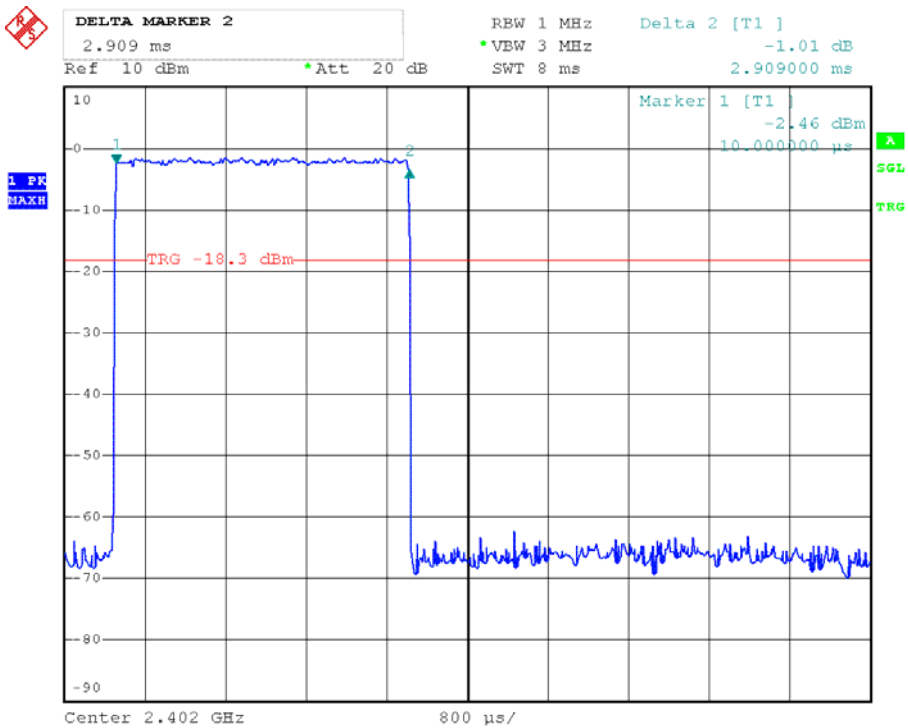

Channel Middle

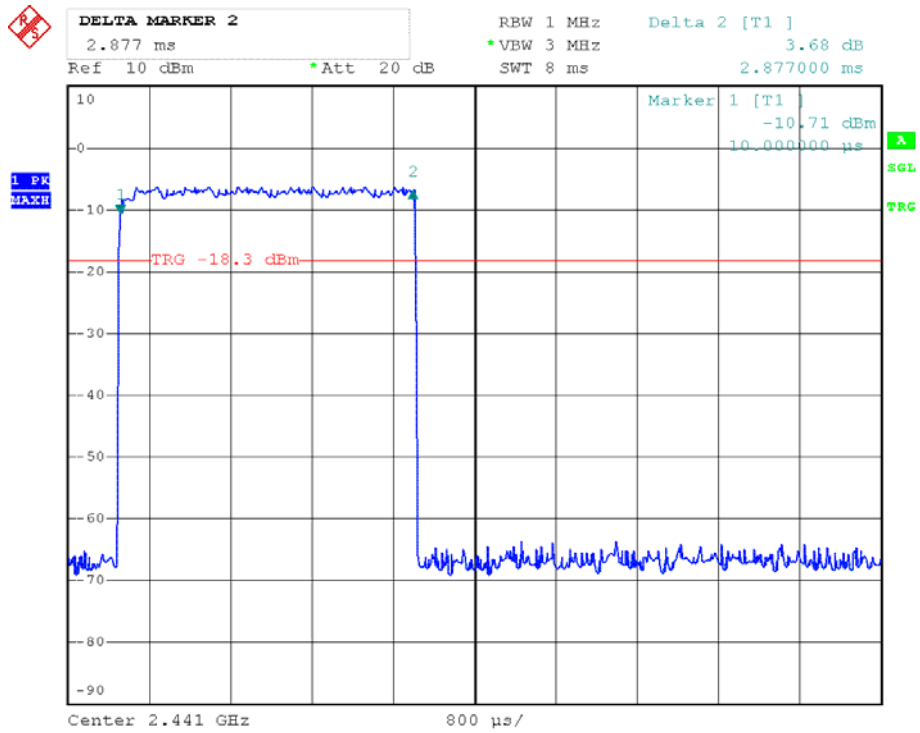

Channel High

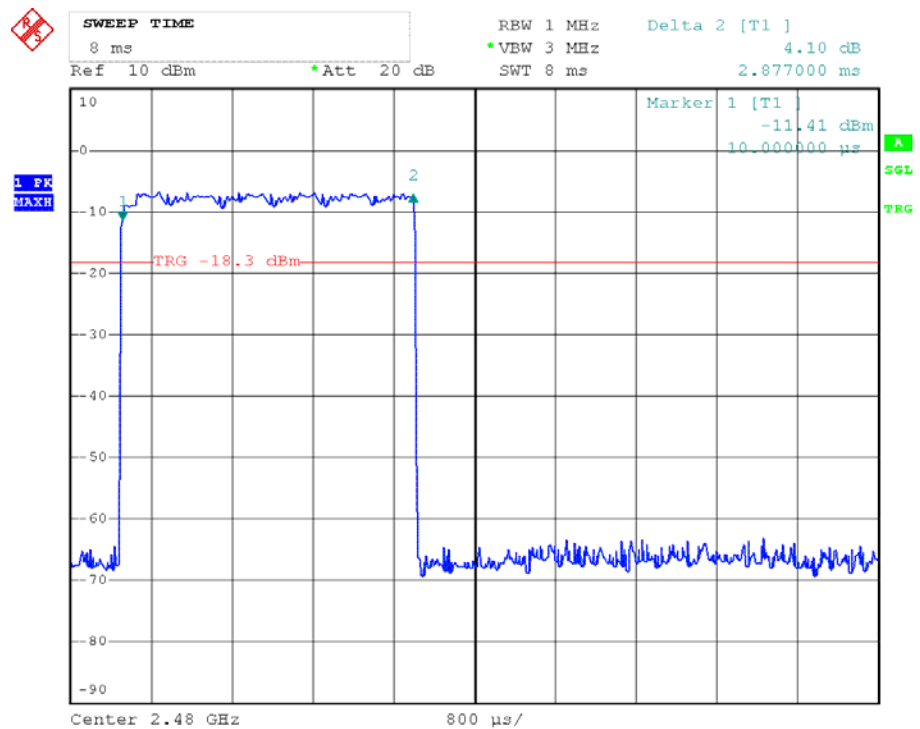

**EDR 3M 3DH1
Channel Low**

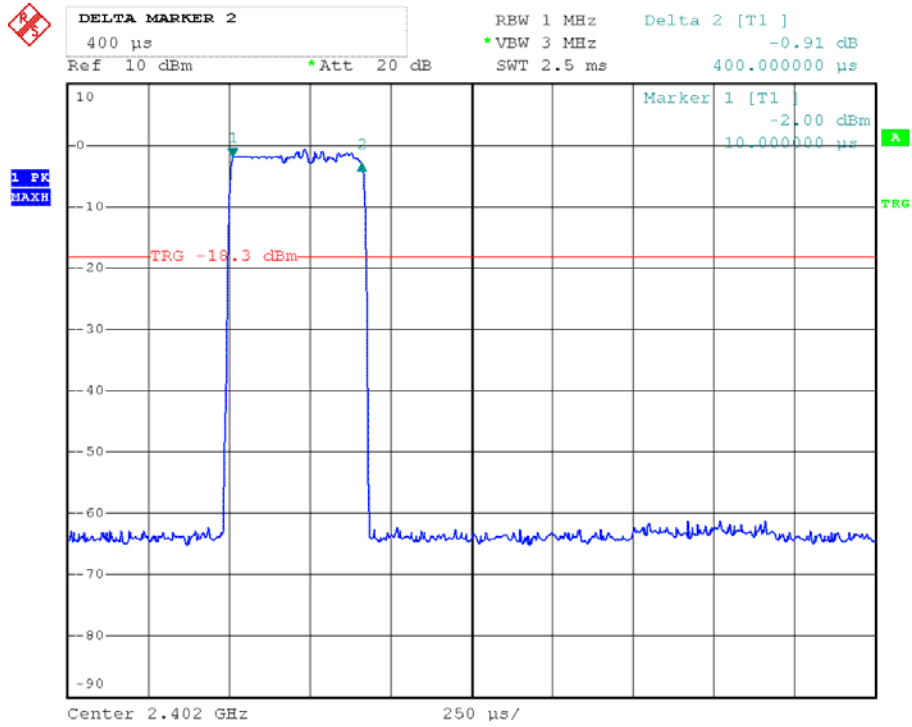

Channel Middle

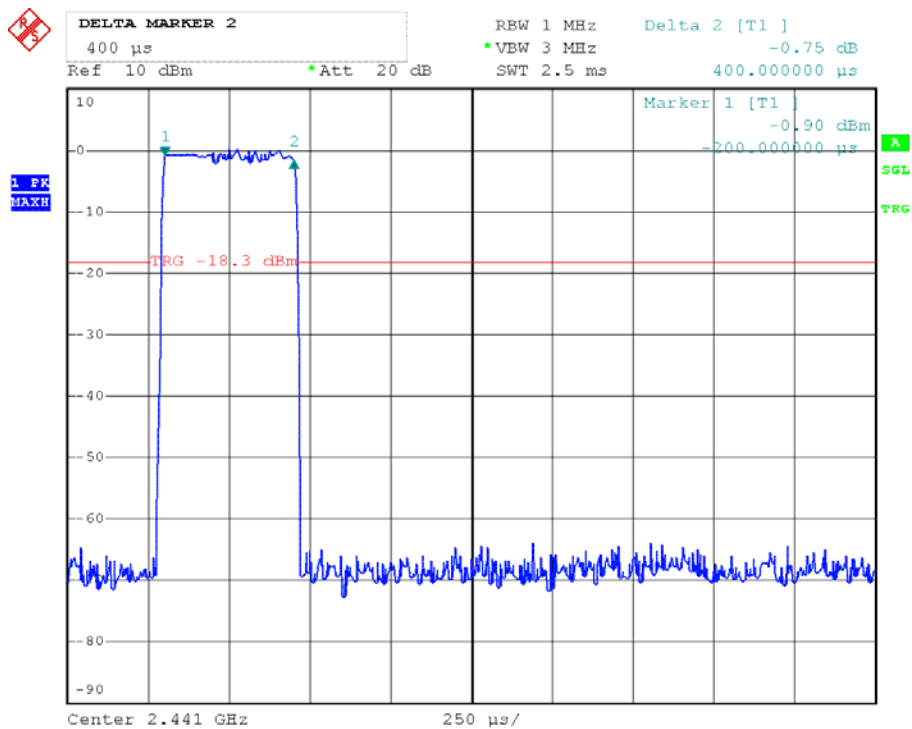

Channel High

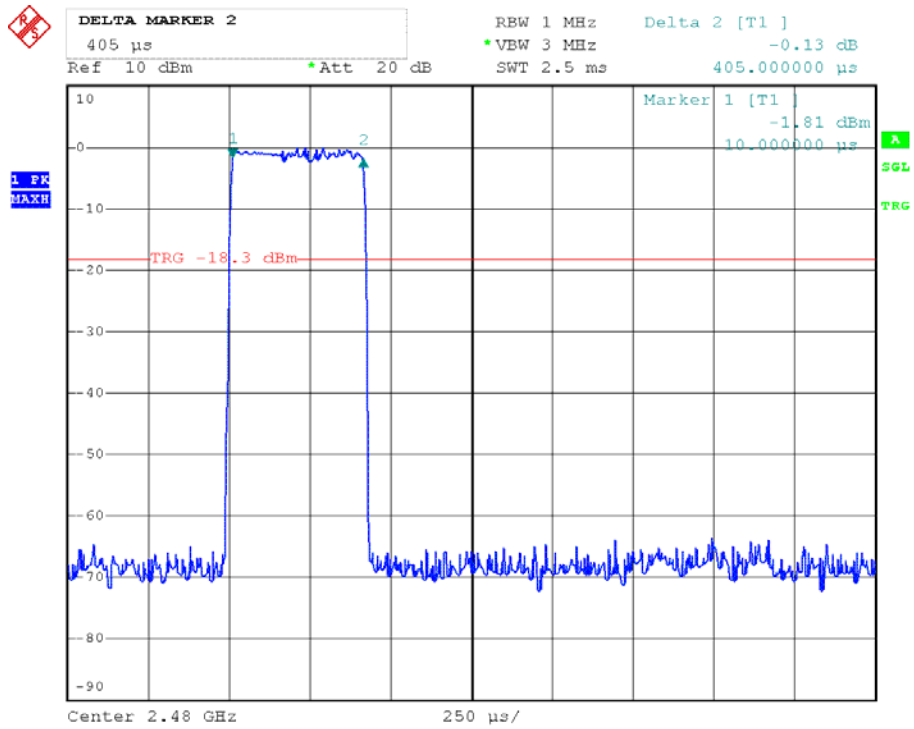

EDR 3M 3DH3 Channel Low

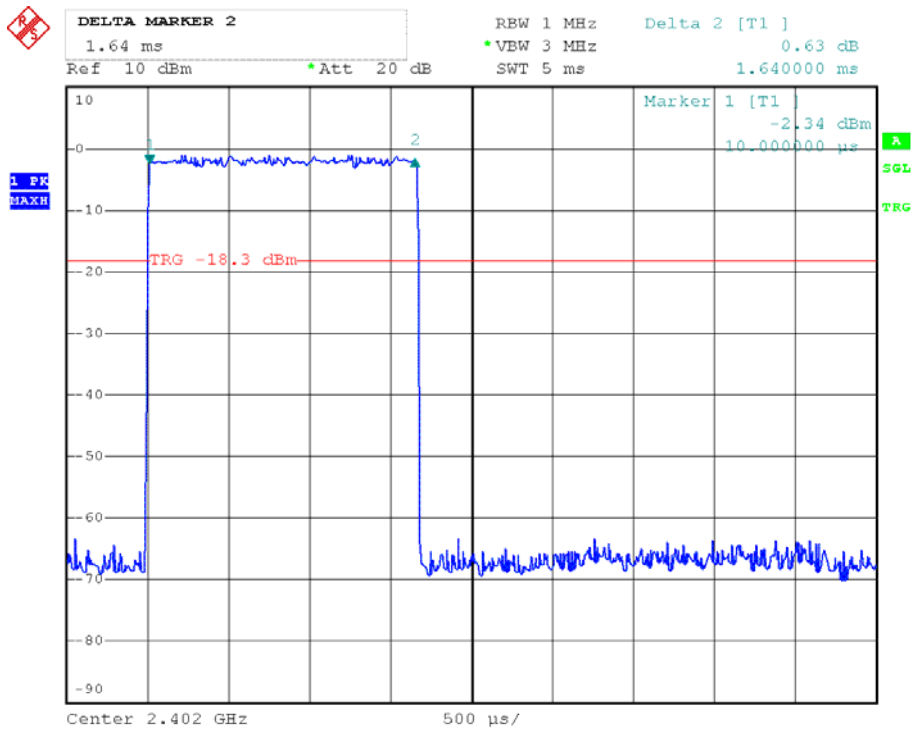

Channel Middle

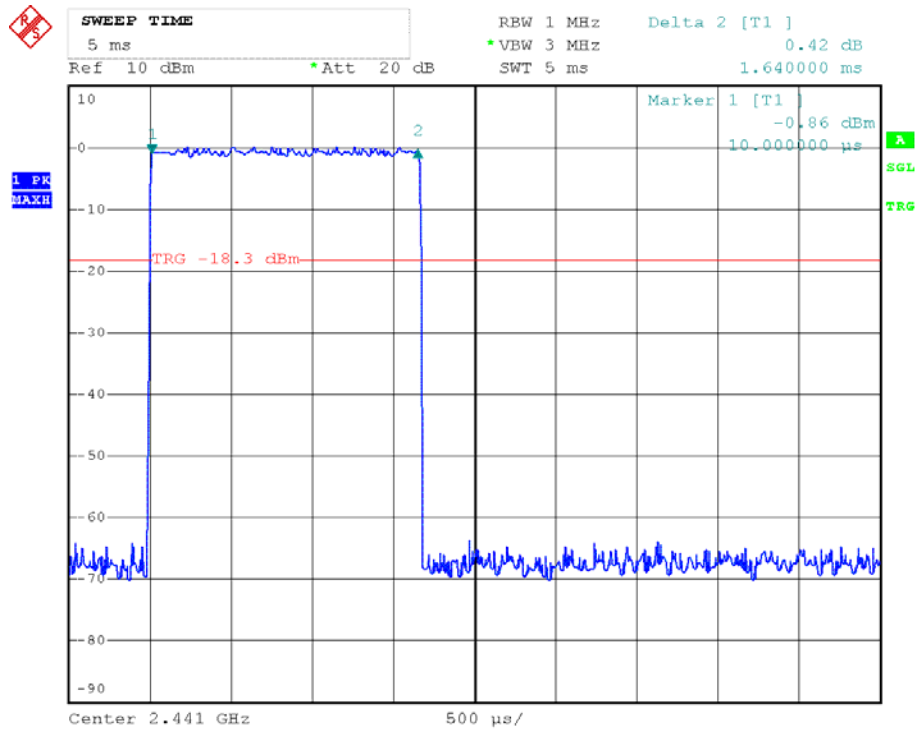

Channel High

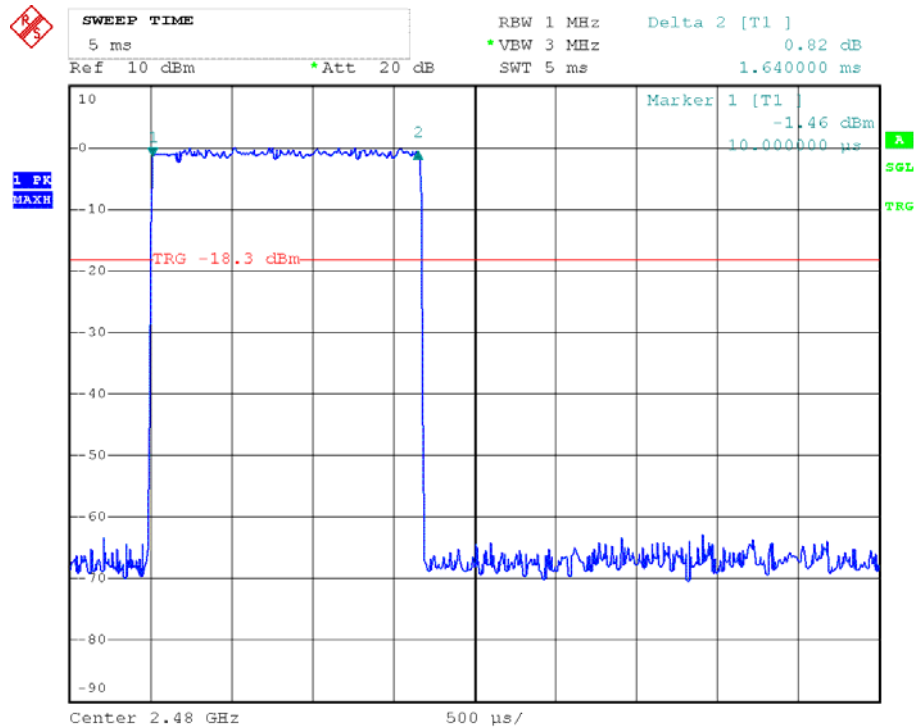

**EDR 3M 3DH5
Channel Low**

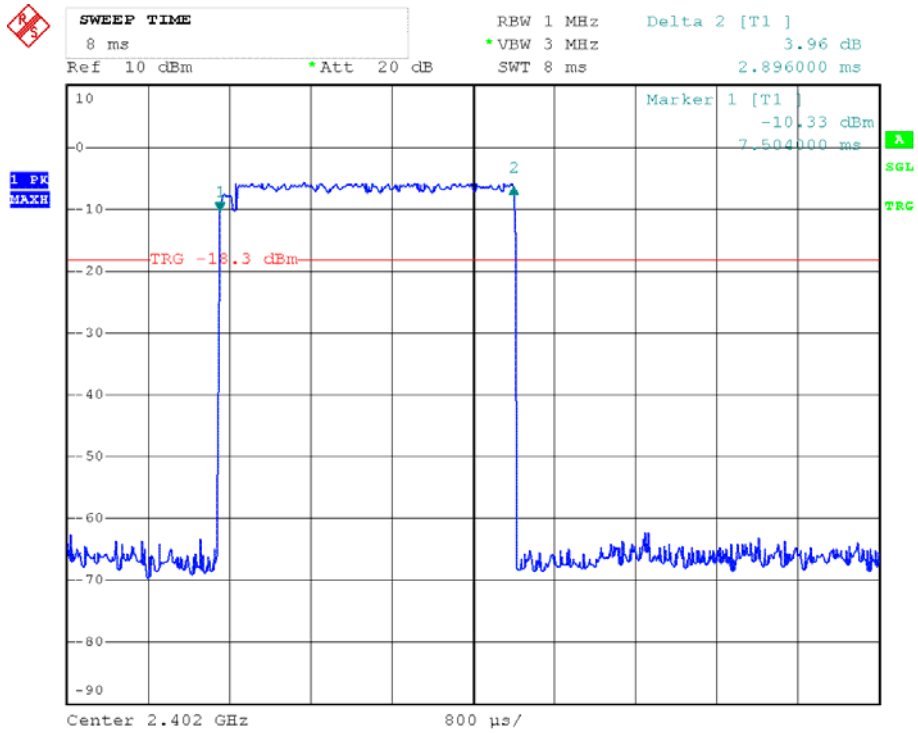

Channel Middle

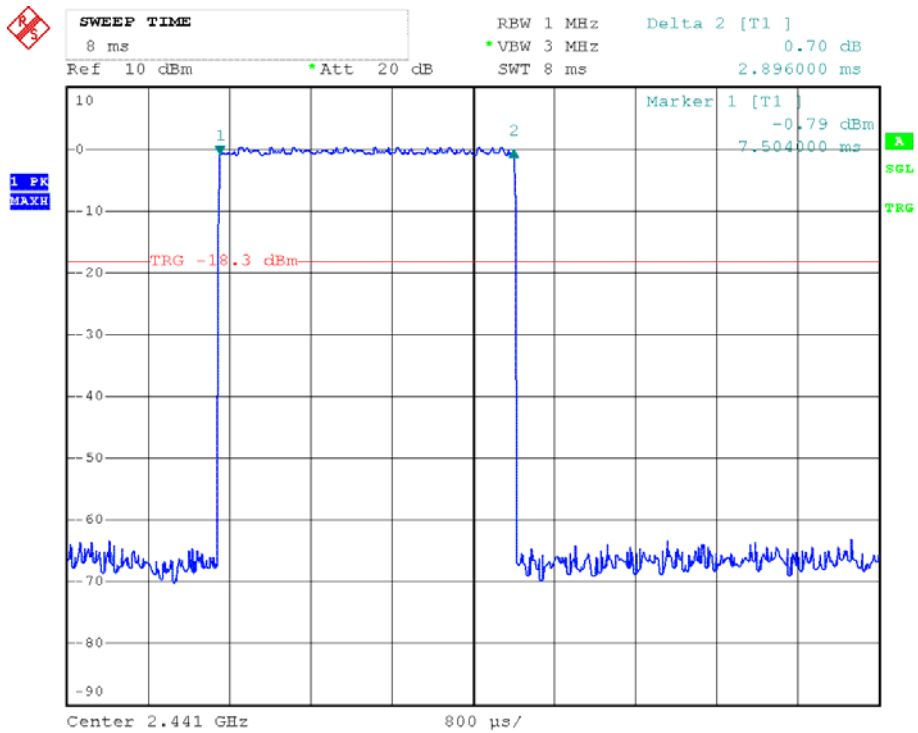

Channel High

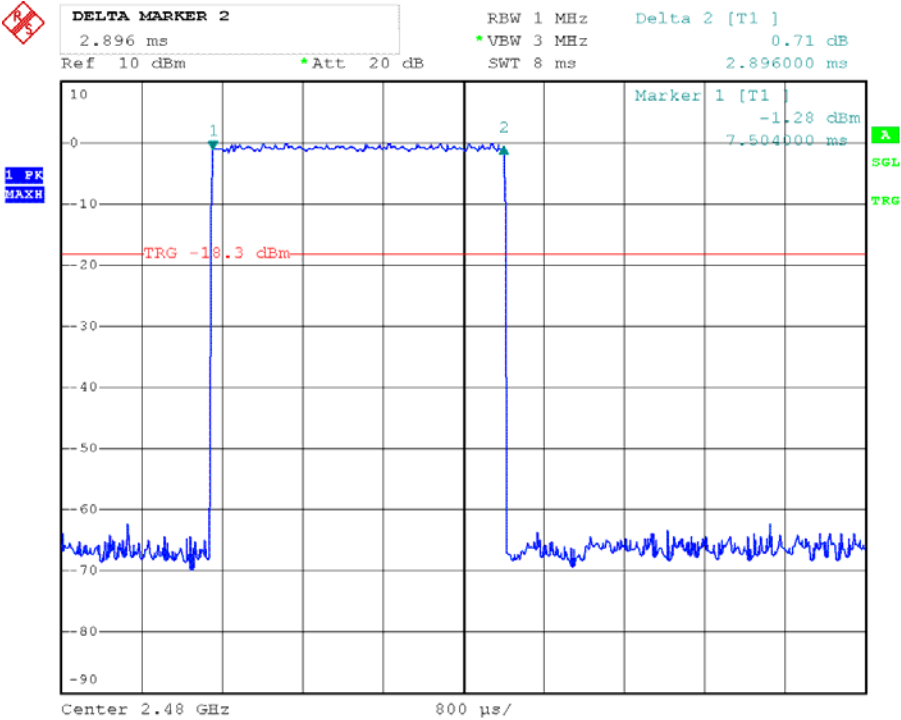

9. Test of Maximum Peak Output Power

9.1 Applicable Standard

Section 15.247(b)(1): For frequency hopping systems operating in the 2400-2483.5 MHz band employing at least 75 non-overlapping hopping channels and The maximum peak output power shall not exceed 1 watt. For all other frequency hopping systems in this frequency band, The maximum peak output power shall not exceed 0.125 watt.

9.2 EUT Setup

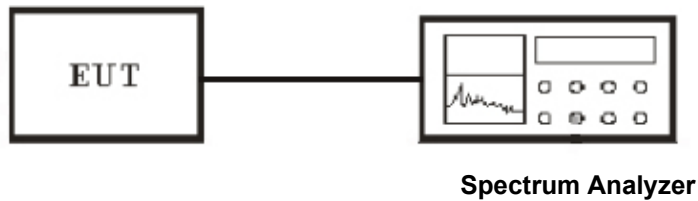

9.3 Test Equipment List and Details

See section 2.5.

9.4 Test Procedure

1. The transmitter output was connected to the peak power meter and recorded the peak value.
2. Peak power meter parameter set to auto attenuator and filter is the same as.
3. Repeated the 1 for the middle and highest channel of the EUT.

9.5 Test Result

Temperature (°C) : 22~23	EUT: Accent 1400
Humidity (%RH) : 50~54	M/N: ACN1400
Barometric Pressure (mbar) : 950~1000	Operation Condition: Tx Mode

BDR 1M

Modulation Type	Channel No.	Frequency (MHz)	Output Power (dBm)	Limits (dBm)	Margin (dB)
GFSK	Low	2402.00	1.13	21	-24.65
GFSK	Middle	2441.00	2.15	21	-25.43
GFSK	High	2480.00	2.09	21	-26.72

EDR 2M

Modulation Type	Channel No.	Frequency (MHz)	Output Power (dBm)	Limits (dBm)	Margin (dB)
Pi/4 DQPSK	Low	2402.00	-1.25	21	-24.87
Pi/4 DQPSK	Middle	2441.00	0.24	21	-25.32
Pi/4 DQPSK	High	2480.00	0.04	21	-26.75

EDR 3M

Modulation Type	Channel No.	Frequency (MHz)	Output Power (dBm)	Limits (dBm)	Margin (dB)
8-DPSK	Low	2402.00	-0.98	21	-24.82
8-DPSK	Middle	2441.00	0.24	21	-25.25
8-DPSK	High	2480.00	0.27	21	-26.74

**BDR 1M
Channel Low**

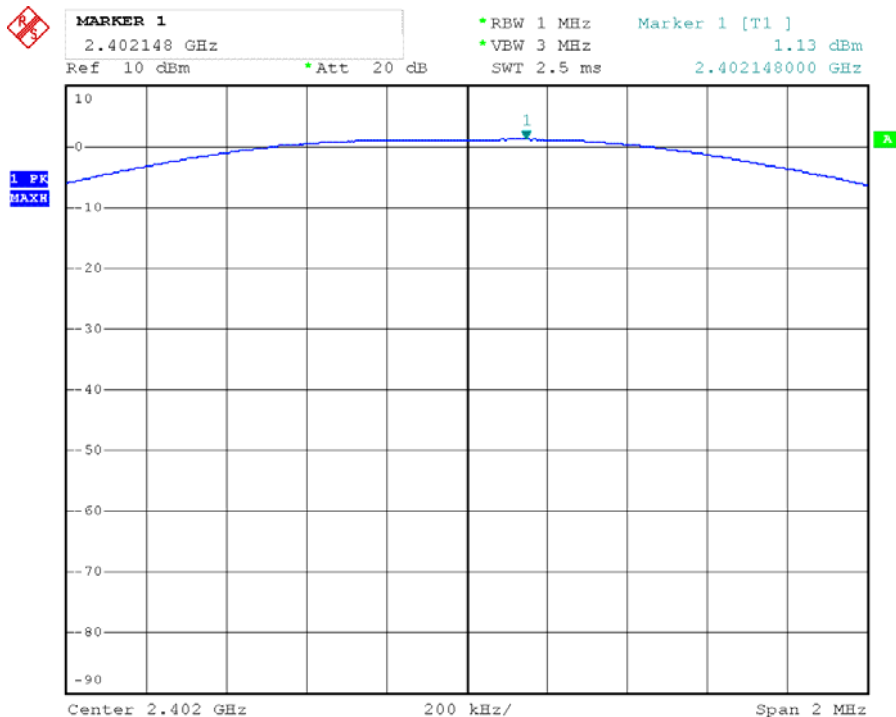

Channel Middle

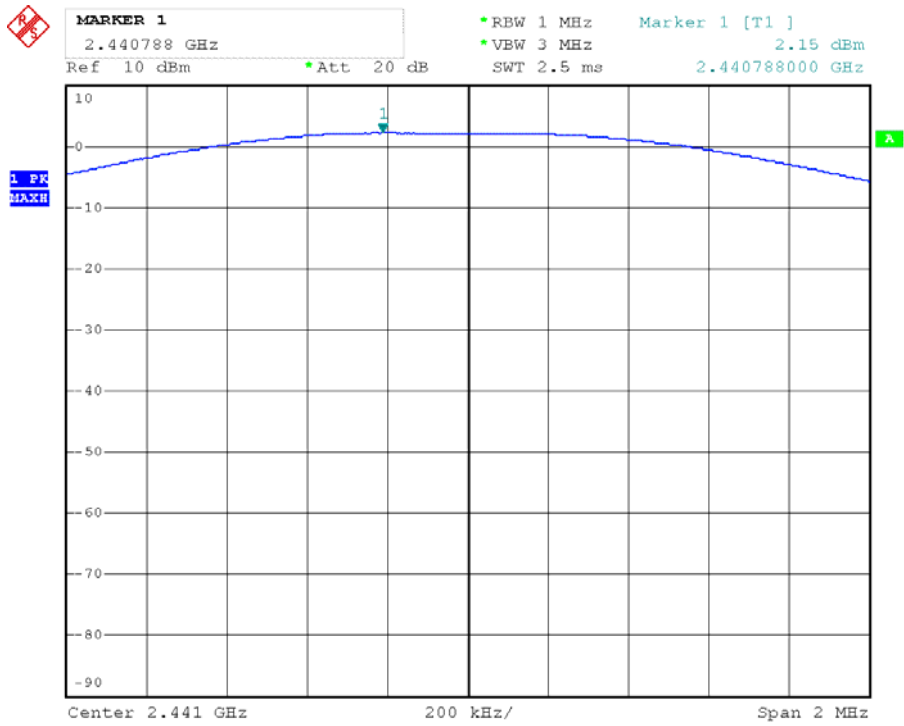

Channel High

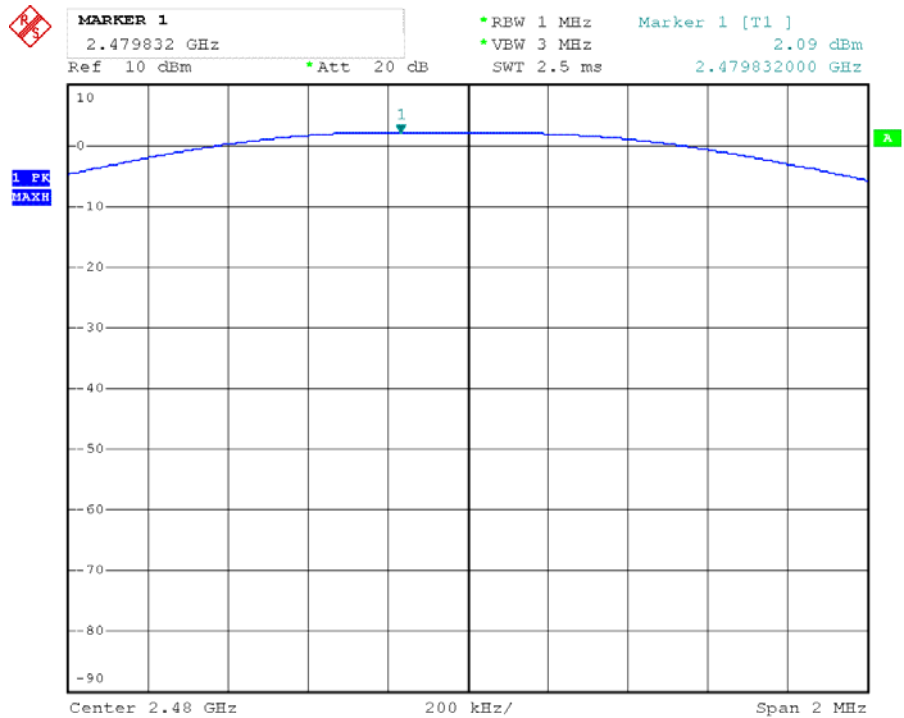

**EDR 2M
Channel Low**

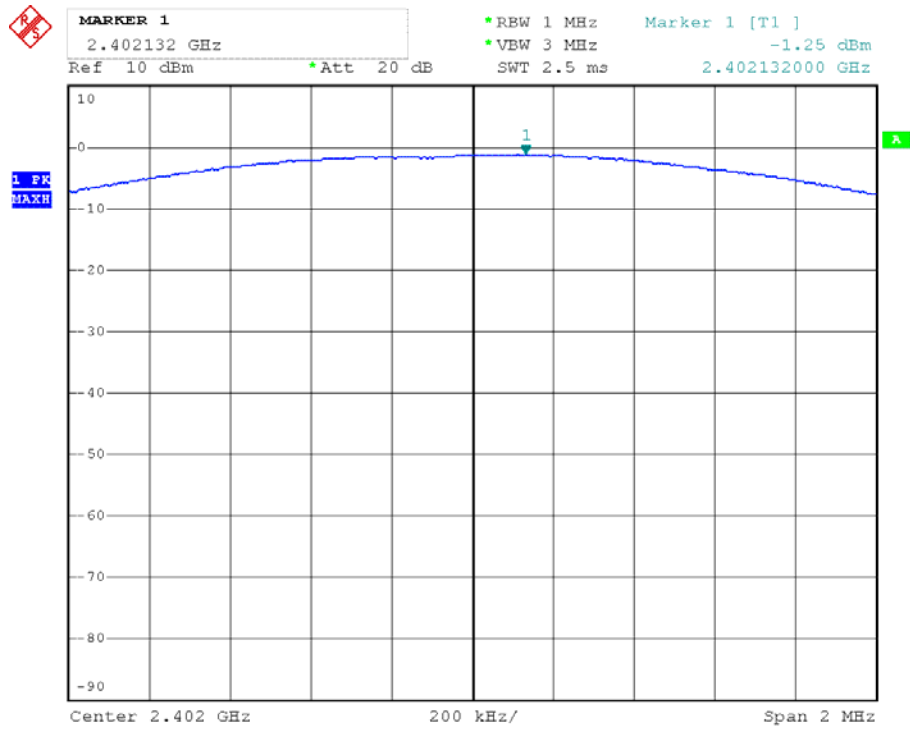

Channel Middle

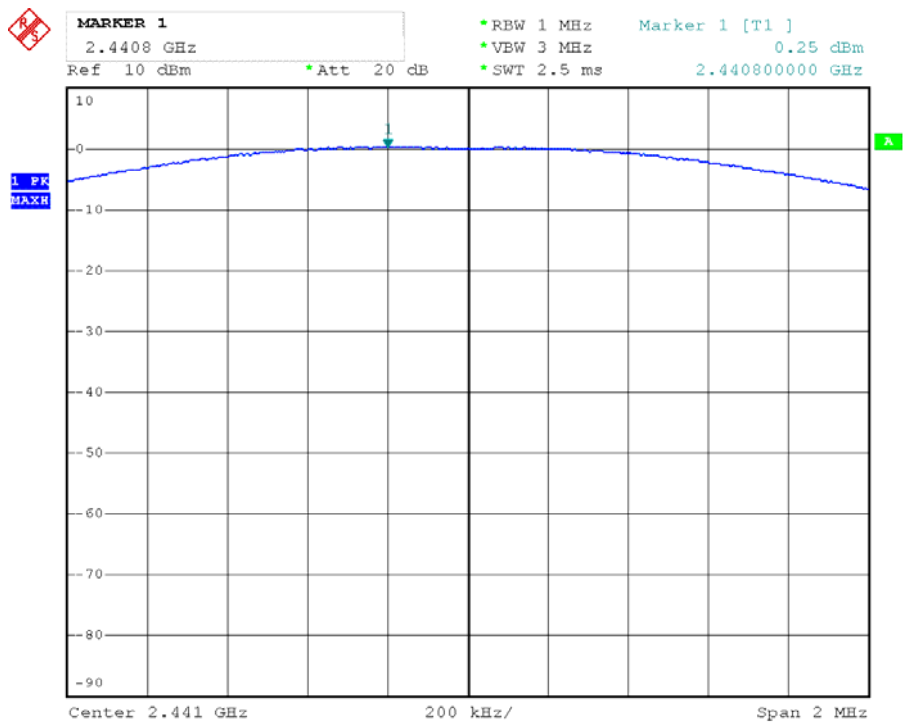

Channel High

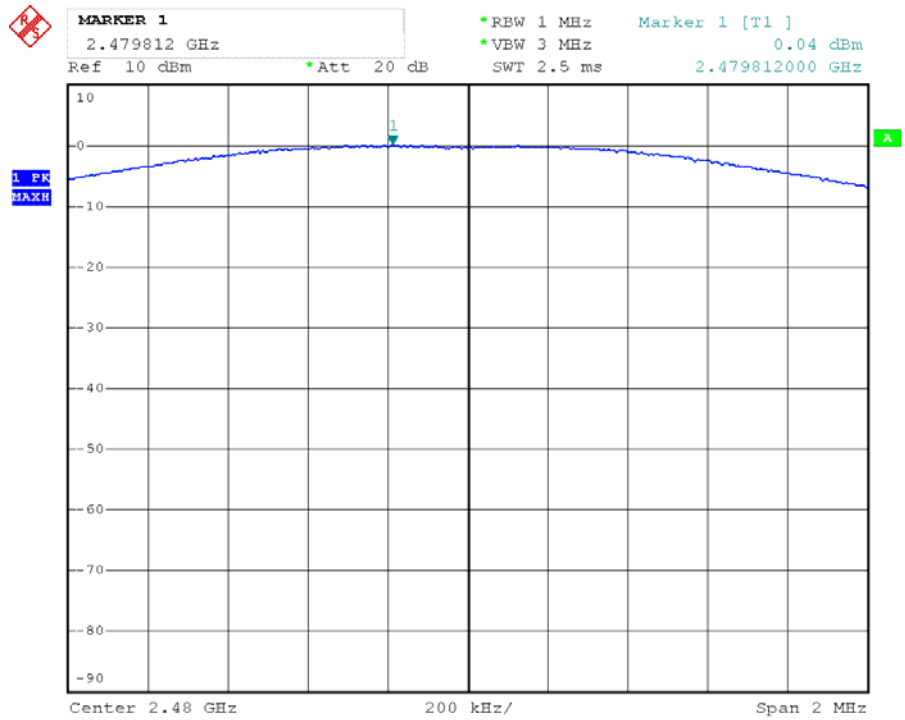

EDR 3M Channel Low

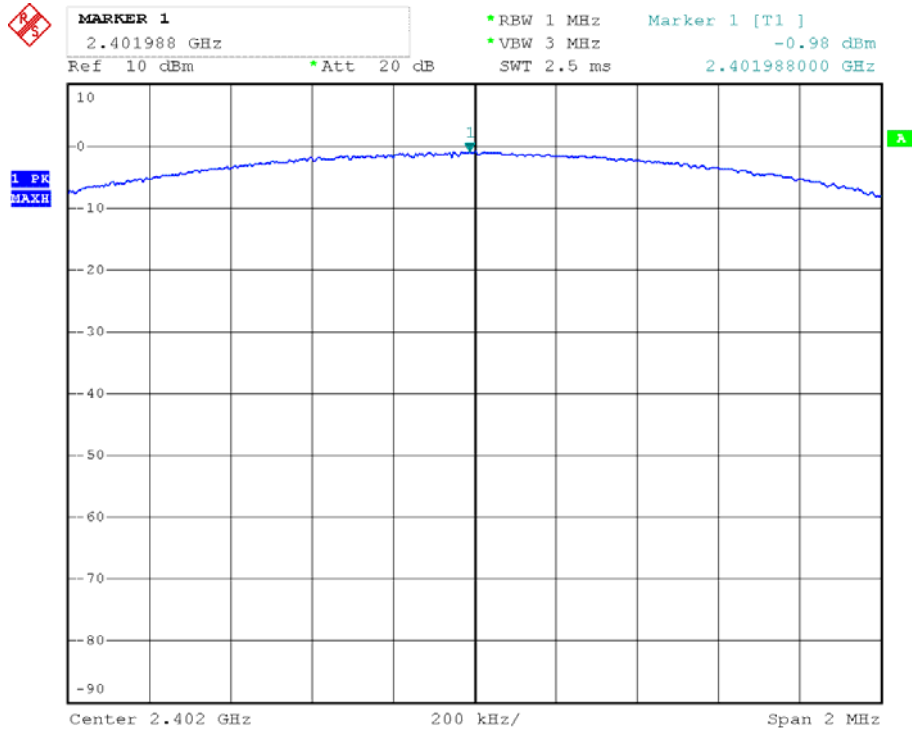

Channel Middle

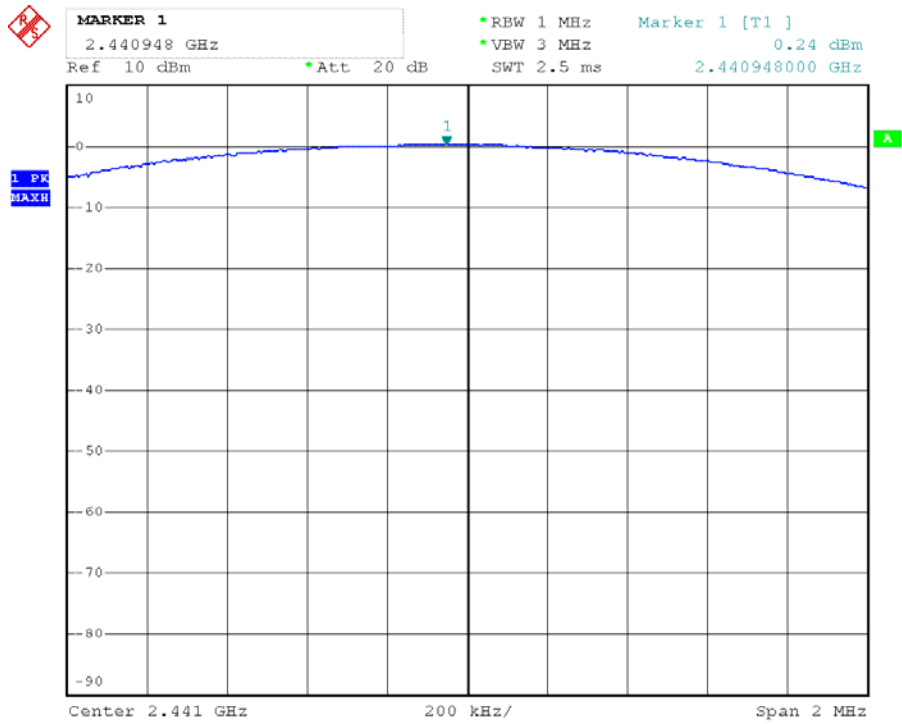

Channel High

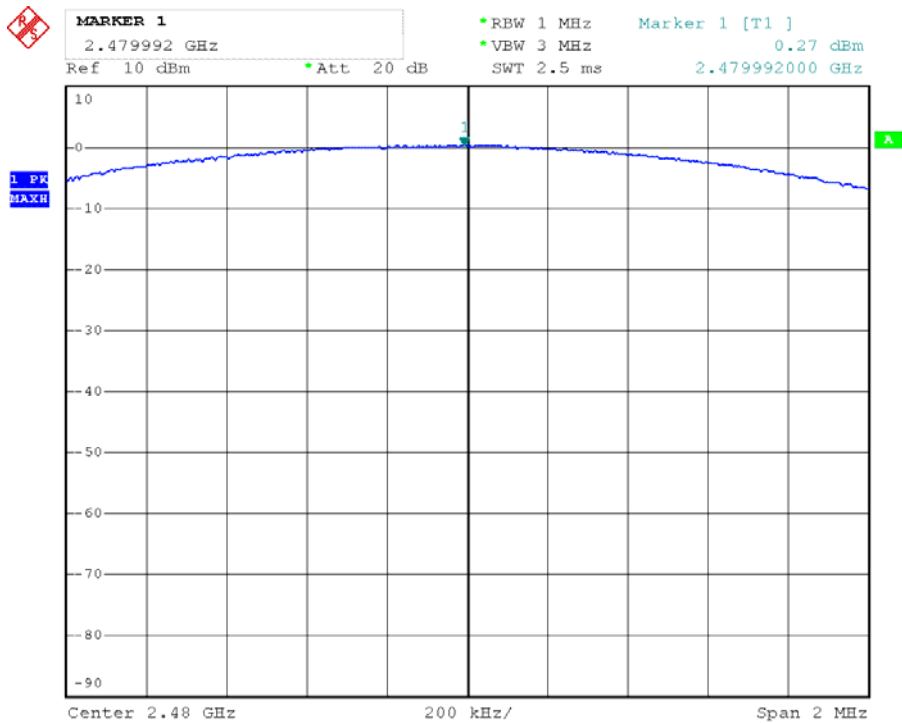

10. Test of Band Edges Emission

10.1 Applicable Standard

Section 15.247(d): In any 100 kHz bandwidth outside the frequency band in which the spread spectrum or digitally modulated intentional radiator is operating, the radio frequency power that is produced by the intentional radiator shall be at least 20 dB below that in the 100 kHz bandwidth within the band that contains the highest level of the desired power, based on either an RF conducted or a radiated measurement. In addition, radiated emissions that fall in the restricted bands, as defined in Section 15.205, must also comply with the radiated emission limits specified in Section 15.209.

10.2 EUT Setup

Radiated Measurement Setup

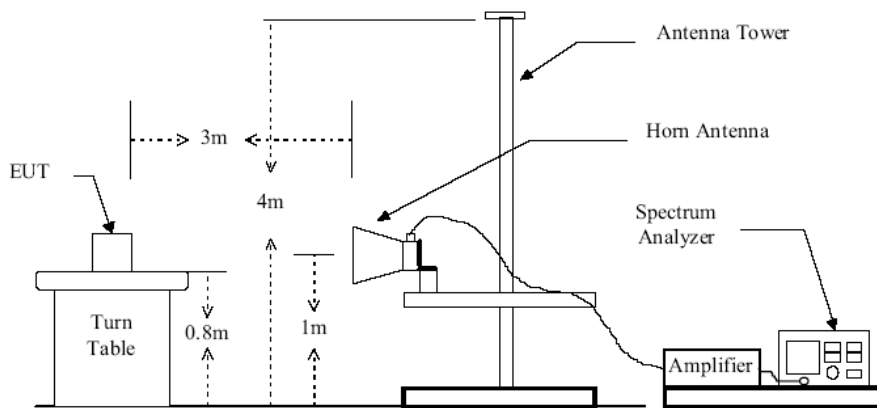
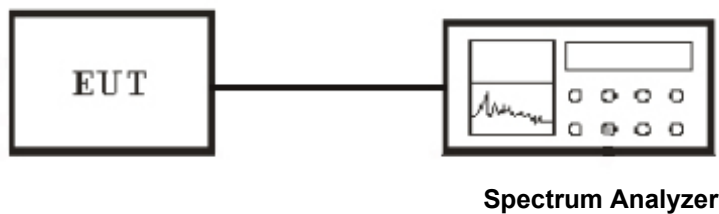

Figure 2 : Frequencies measured above 1 GHz configuration

Conducted Measurement Setup



10.3 Test Equipment List and Details

See section 2.5.

10.4 Test Procedure

Conducted Measurement

1. The transmitter is set to the lowest channel.
2. The transmitter output was connected to the spectrum analyzer via a cable .

3. Set both RBW and VBW of spectrum analyzer to 100KHz with convenient frequency span including 100MHz bandwidth from lower band edge. Then detector set to peak and max hold this trace.
4. The lowest band edges emission was measured and recorded.
5. The transmitter set to the highest channel and repeated 2~4.

Radiated Measurement

1. Configure the EUT according to ANSI C63.4-2003
2. The turntable was rotated by 360 degrees to determine the position of the highest radiation.
3. The height of the broadband receiving antenna was varied between one meter and four meters above ground to find the maximum emission field strength of both horizontal and vertical polarization.
4. For band edge emission, the antenna tower was scan (from 1 M to 4 M) and then the turn table was rotated (from 0 degree to 360 degrees) to find the maximum reading.
5. For band edge emission, use 1MHz VBW and 1MHz RBW for reading under AV and use 1MHz VBW and 1MHz RBW for reading under PK.

10.5 Test Result

Temperature (°C) : 22~23	EUT: Accent 1400
Humidity (%RH) : 50~54	M/N: ACN1400
Barometric Pressure (mbar) : 950~1000	Operation Condition: Tx Mode

Radiated Test Result

Worst Case BDR 1M

Frequency (MHz)	Antenna Polarization	Emission Read Value (dBµV/m)	Limits (dBµV/m)
2389.5	H	30.23	54
2389.5	V	32.49	54
2483.7	H	31.66	54
2483.7	V	32.58	54

Worst Case EDR 2M

Frequency (MHz)	Antenna Polarization	Emission Read Value (dBµV/m)	Limits (dBµV/m)
2389.4	H	31.32	54
2389.4	V	32.68	54
2483.7	H	31.54	54
2483.7	V	33.85	54

Worst Case EDR 3M

Frequency (MHz)	Antenna Polarization	Emission Read Value (dB μ V/m)	Limits (dB μ V/m)
2389.5	H	31.52	54
2389.5	V	33.69	54
2483.6	H	31.78	54
2483.6	V	33.38	54

Conducted Test Result
BDR 1M
Low Channel

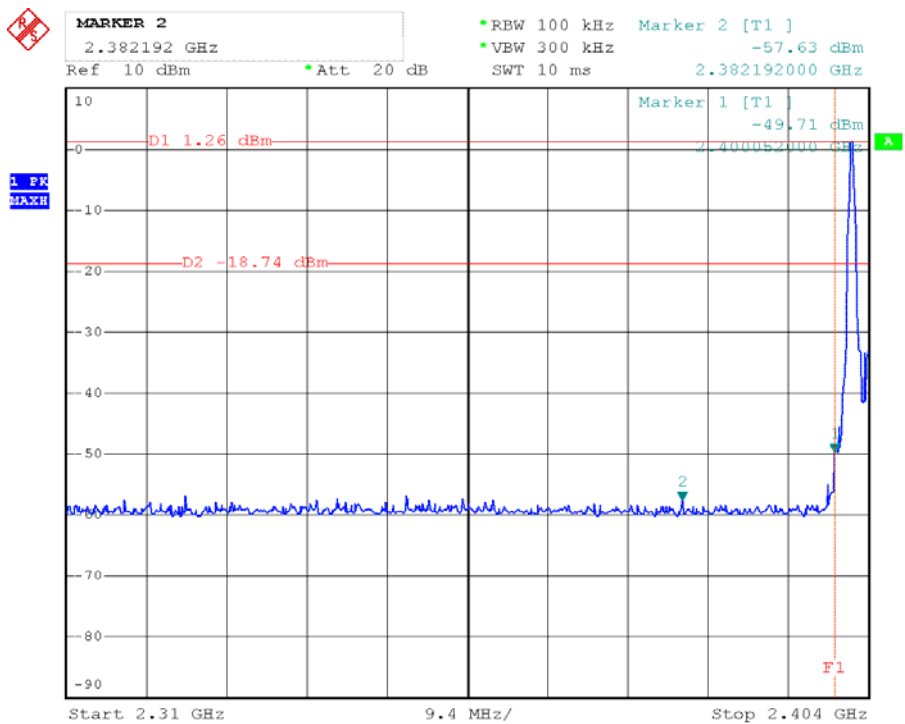

High Channel

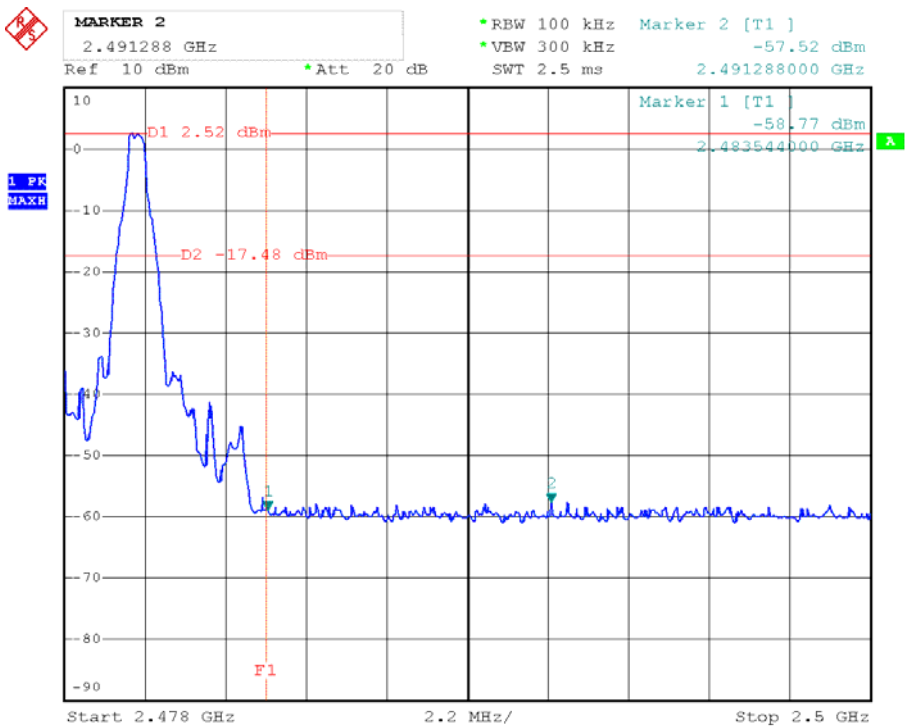

**EDR 2M
Low Channel**

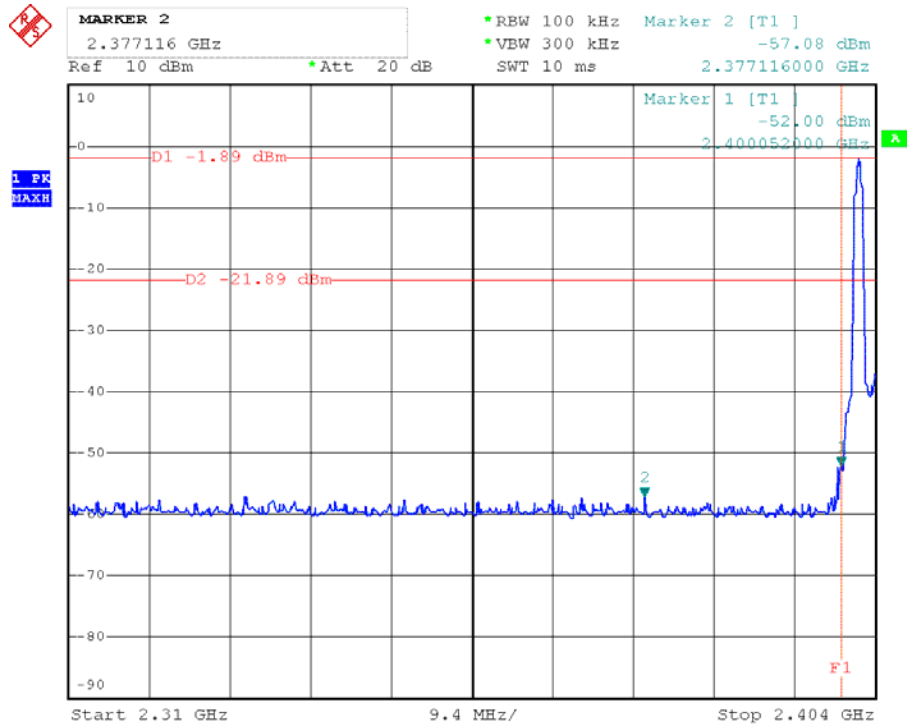

High Channel

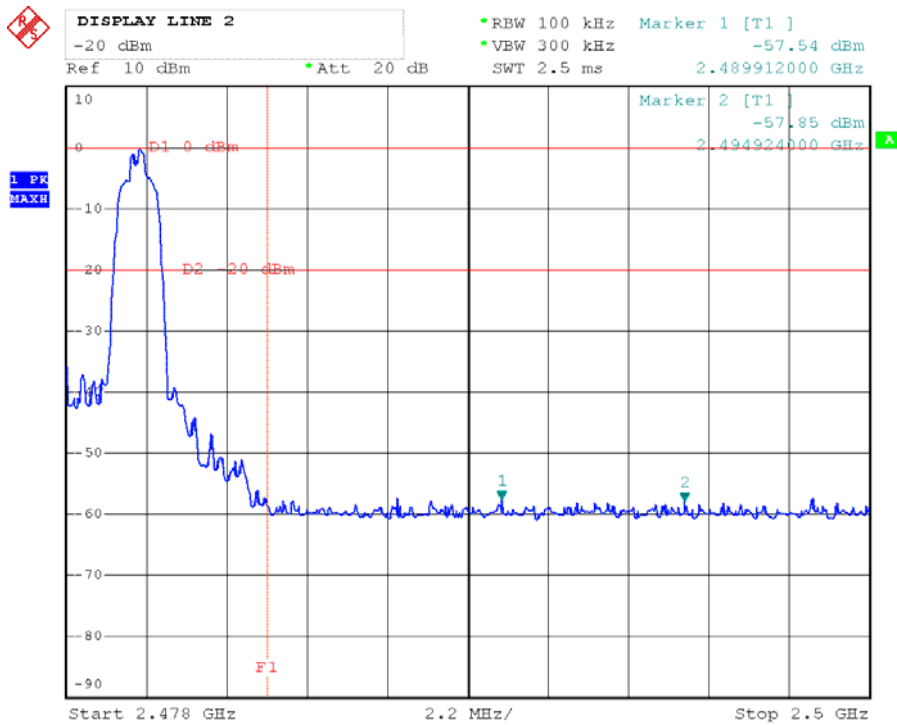

EDR 3M Low Channel

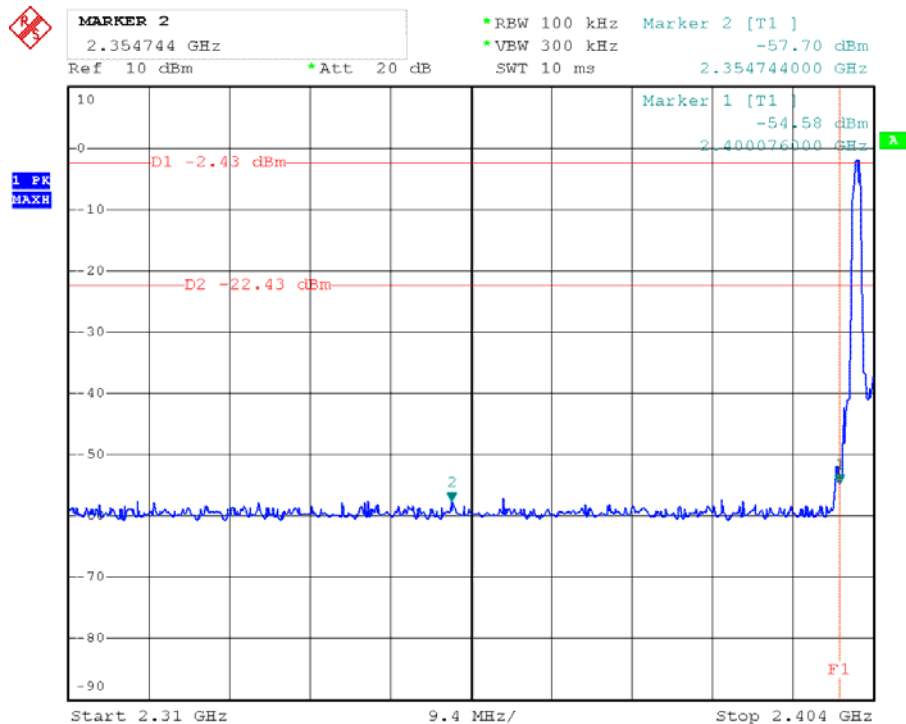

High Channel

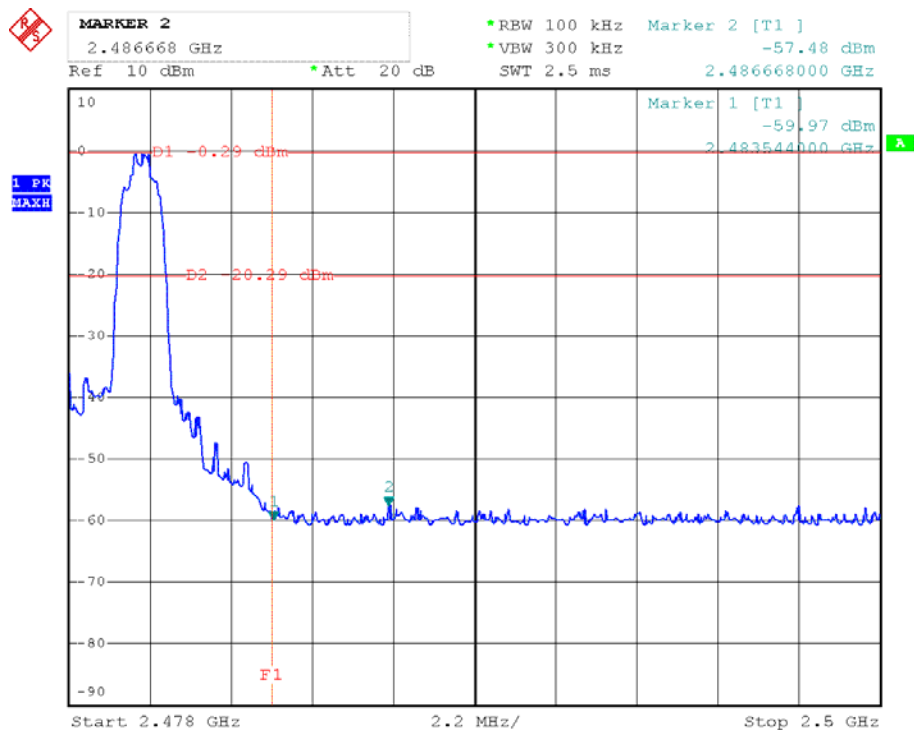

Hopping Mode Worst case EDR 2M Low

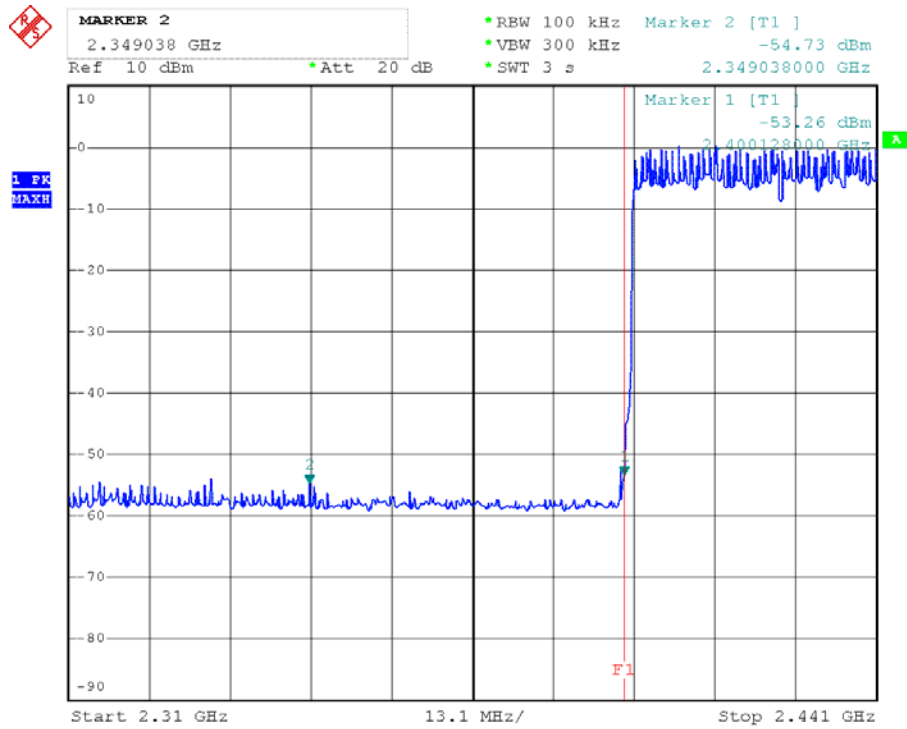

High

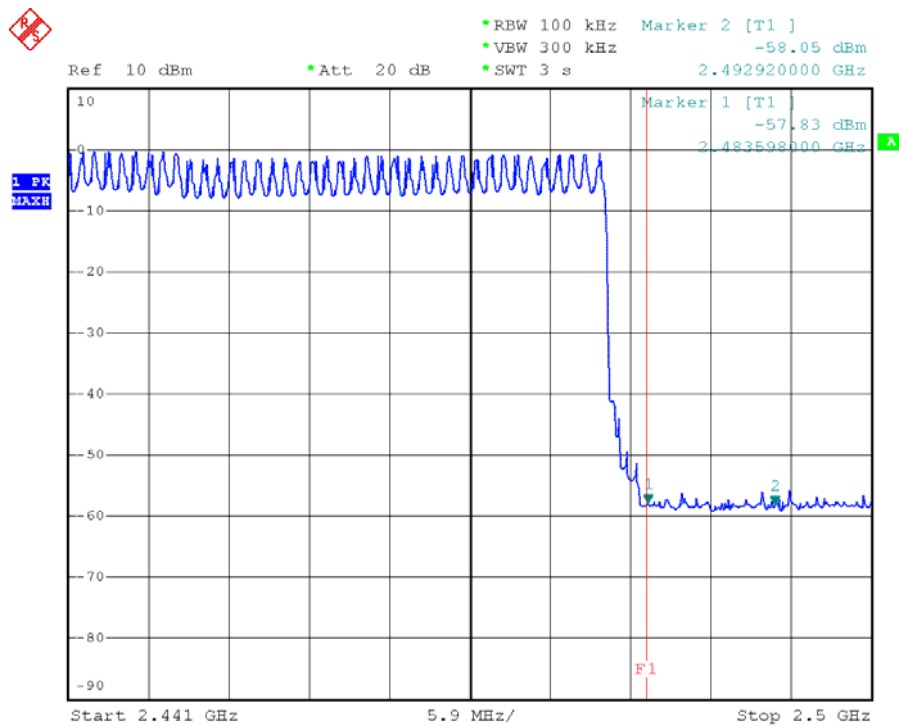

11. Test of Spurious Radiated Emission

11.1 Applicable Standard

Section 15.247(d): In any 100 kHz bandwidth outside the frequency band in which the spread spectrum or digitally modulated intentional radiator is operating, the radio frequency power that is produced by the intentional radiator shall be at least 20 dB below that in the 100 kHz bandwidth within the band that contains the highest level of the desired power, based on either an RF conducted or a radiated measurement. In addition, radiated emissions that fall in the restricted bands, as defined in Section 15.205, must also comply with the radiated emission limits specified in Section 15.209.

11.2 EUT Setup

Conducted Measurement Setup

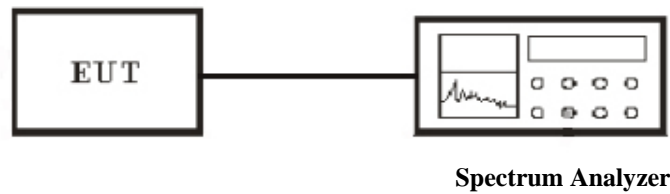

Radiated Measurement Setup

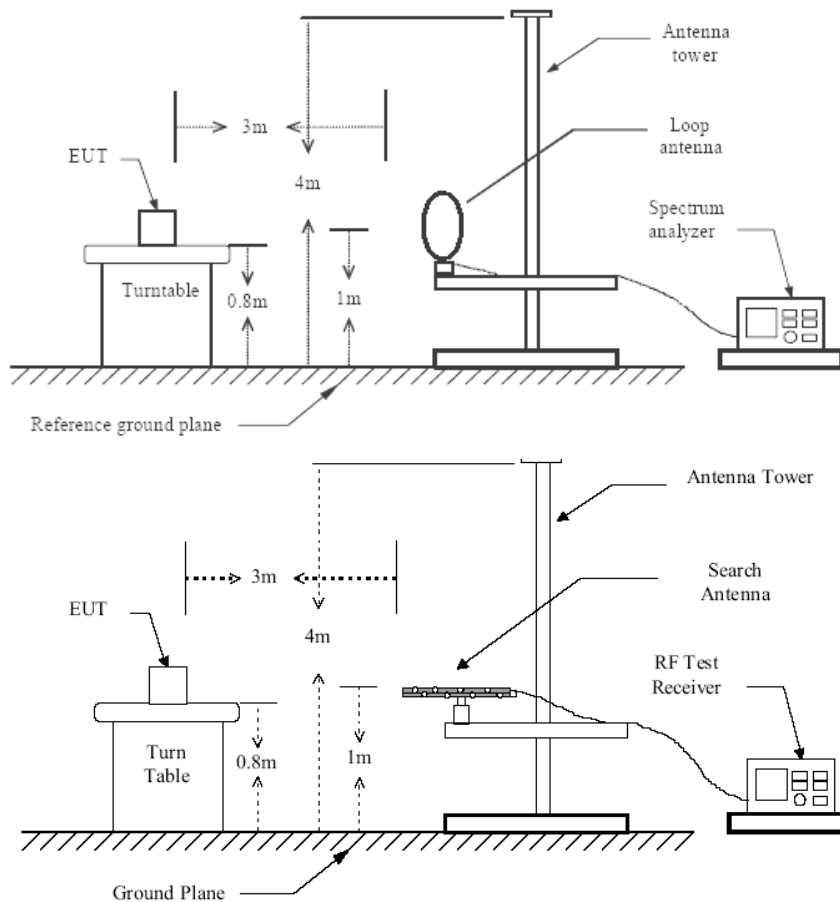

Figure 1 : Frequencies measured below 1 GHz configuration

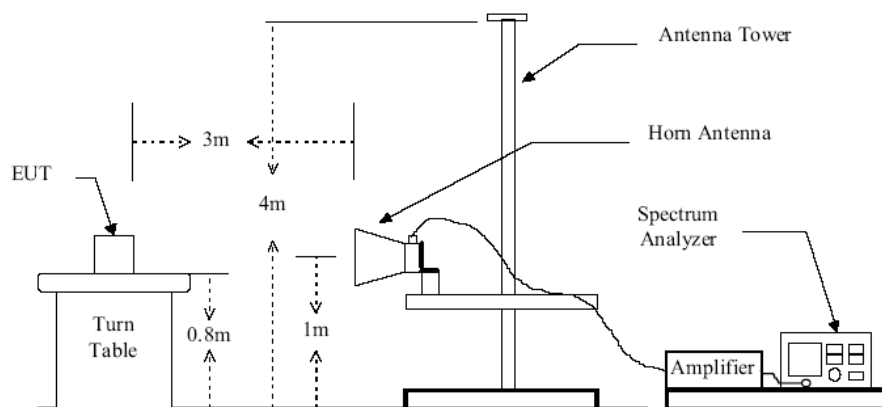

Figure 2 : Frequencies measured above 1 GHz configuration

11.3 Test Equipment List and Details

See section 2.5.

11.4 Test Procedure

Conducted Measurement

1. For emission above 1GHz to 26G,conducted measurement method is used.
2. The transmitter is set to the lowest channel.
3. The transmitter output was connected to the spectrum analyzer via a cable and cable loss is used as the offset of the spectrum analyzer.
4. Set RBW to 1 MHz and VBW to 3 MHz, Then detector set to peak and max hold this trace.
5. The lowest band edges emission was measured and recorded.
6. The transmitter set to the highest channel and repeated 2~4.

Radiated Measurement

1. Configure the EUT according to ANSI C63.4-2003
2. The EUT was placed on the top of the turntable 0.8 meter above ground.
3. Receiving antenna mounted on the top of a height-variable antenna tower was placed 3 meters far away from the turntable. When the frequency spectrum measured started from 9 kHz to 30 MHz, a loop antenna is used. When the frequency spectrum measured started from 30 MHz to 1000 MHz and above 1000 MHz, a broadband receiving antenna and the horn antenna are used.
4. Power on the EUT and all the supporting units.
5. The turntable was rotated by 360 degrees to determine the position of the highest radiation.
6. The height of the broadband receiving antenna was varied between one meter and four meters above ground to find the maximum emission field strength of both horizontal and vertical polarization.
7. For each suspected emission, the antenna tower was scanned (from 1 M to 4 M) and then the turntable was rotated (from 0 degree to 360 degrees) to find the maximum reading.

8. According to the characteristic of the EUT crystals, the range of frequencies was investigated from 9KHz to 30MHz, 30MHz to 1GHz and 1GHz to 26GHz.

9. For emission below 1GHz, Set the test-receiver system to Peak or CISPR quasi-peak Detect Function with specified bandwidth under Maximum Hold Mode.

10. For emission above 1GHz, Set the RBW=1MHz,VBW=3MHz for Peak Detector while the RBW=1MHz, VBW=10Hz for Average Detector, Readings are both peak and average values.

11. The pre-test have done for the EUT in three axes and found the worst emission at position shown in test setup photos. The worst case data is recorded in the report. All emission not reported are much lower than the prescribed limits.

11.5 Test Result

Temperature (°C) : 22~23	EUT: Accent 1400
Humidity (%RH) : 50~54	M/N: ACN1400
Barometric Pressure (mbar) : 950~1000	Operation Condition: TX Mode

The worst Spurious Emission Data BDR Mode Below 1GHz Channel Low:

EUT: Accent 1400
M/N: ACN1400
Operating Condition: TX Mode
Test Site: 3m CHAMBER
Operator: Chen
Test Specification: DC 7.4V from battery
Comment: Polarization: Horizontal

SWEEP TABLE: "test (30M-1G)"

Short Description:		Field Strength			
Start	Stop	Detector	Meas. Time	IF Bandw.	Transducer
Frequency	Frequency				
30.0 MHz	1.0 GHz	MaxPeak	Coupled	100 kHz	VULB9163 NEW

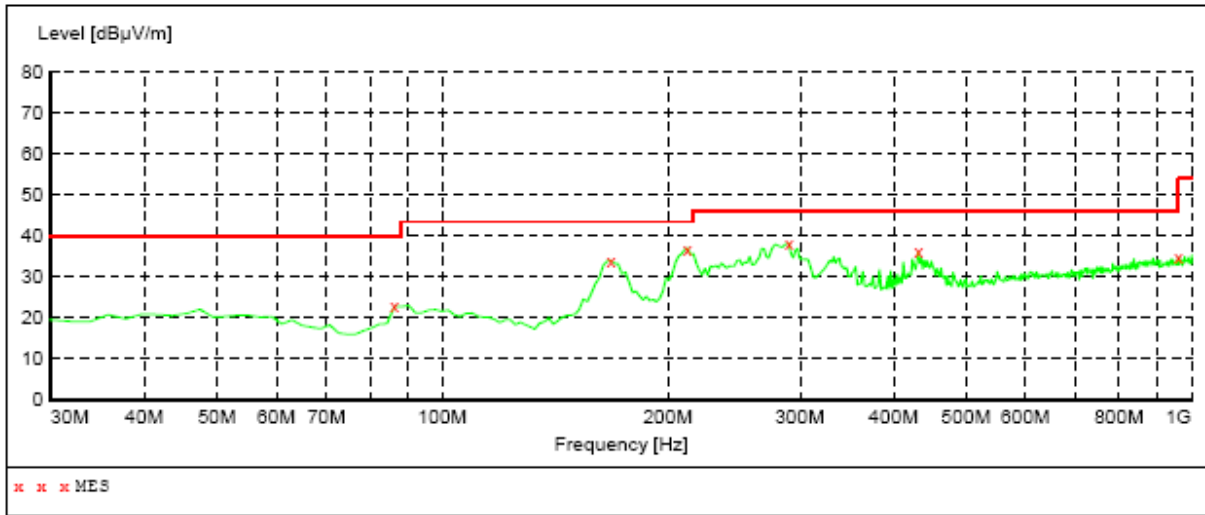

MEASUREMENT RESULT:

Frequency MHz	Level dBuV/m	Transd dB	Limit dBuV/m	Margin dB	Det.	Height cm	Azimuth deg	Polarization
86.260000	22.80	14.8	40.0	17.2	QP	100.0	0.00	HORIZONTAL
167.740000	34.00	13.0	43.5	9.5	QP	100.0	0.00	HORIZONTAL
212.360000	37.00	15.1	43.5	6.5	QP	100.0	0.00	HORIZONTAL
289.960000	38.20	18.4	46.0	7.8	QP	100.0	0.00	HORIZONTAL
431.580000	36.10	22.0	46.0	9.9	QP	100.0	0.00	HORIZONTAL
959.260000	34.70	29.6	46.0	11.3	QP	100.0	0.00	HORIZONTAL

The worst Spurious Emission Data BDR Mode Below 1GHz Channel Low:

EUT: Accent 1400
M/N: ACN1400
Operating Condition: TX Mode
Test Site: 3m CHAMBER
Operator: Chen
Test Specification: DC 7.4V from battery
Comment: Polarization: Vertical

SWEEP TABLE: "test (30M-1G)"

Short Description:		Field Strength			
Start	Stop	Detector	Meas. Time	IF Bandw.	Transducer
Frequency	Frequency				
30.0 MHz	1.0 GHz	MaxPeak	Coupled	100 kHz	VULB9163 NEW

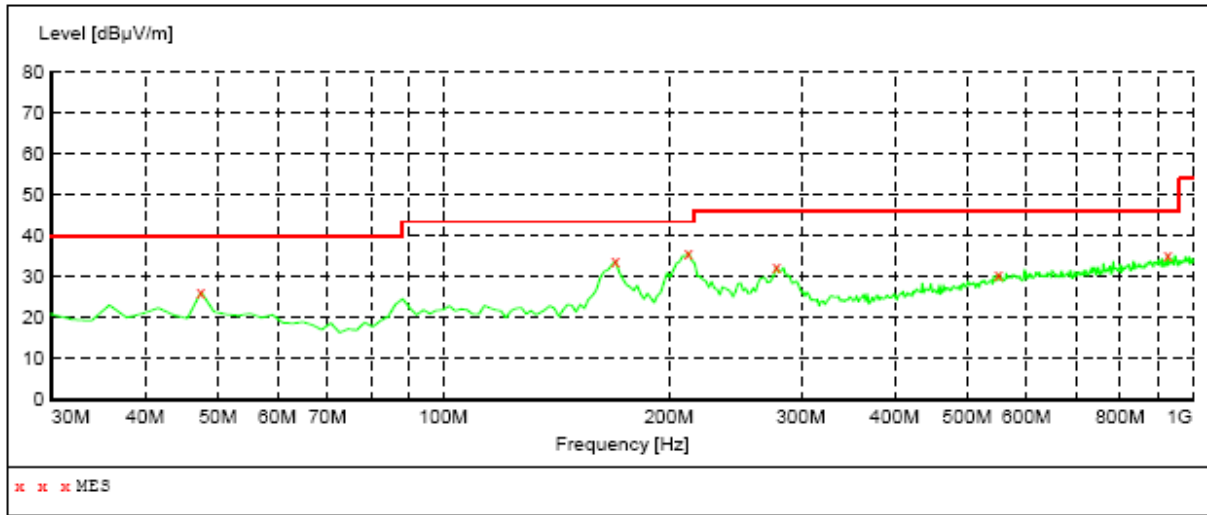

MEASUREMENT RESULT:

Frequency MHz	Level dBµV/m	Transd dB	Limit dBµV/m	Margin dB	Det.	Height cm	Azimuth deg	Polarization
47.460000	26.30	15.8	40.0	13.7	QP	100.0	0.00	VERTICAL
169.680000	33.80	13.1	43.5	9.7	QP	100.0	0.00	VERTICAL
212.360000	36.00	15.1	43.5	7.5	QP	100.0	0.00	VERTICAL
278.320000	32.40	18.1	46.0	13.6	QP	100.0	0.00	VERTICAL
549.920000	30.70	25.0	46.0	15.3	QP	100.0	0.00	VERTICAL
926.280000	35.40	29.4	46.0	10.6	QP	100.0	0.00	VERTICAL

The worst Spurious Emission Data BDR Mode Below 1GHz Channel Middle:

EUT: Accent 1400
M/N: ACN1400
Operating Condition: TX Mode
Test Site: 3m CHAMBER
Operator: Chen
Test Specification: DC 7.4V from battery
Comment: Polarization: Horizontal

SWEEP TABLE: "test (30M-1G)"

Short Description:		Field Strength			
Start	Stop	Detector	Meas. Time	IF Bandw.	Transducer
30.0 MHz	1.0 GHz	MaxPeak	Coupled	100 kHz	VULB9163 NEW

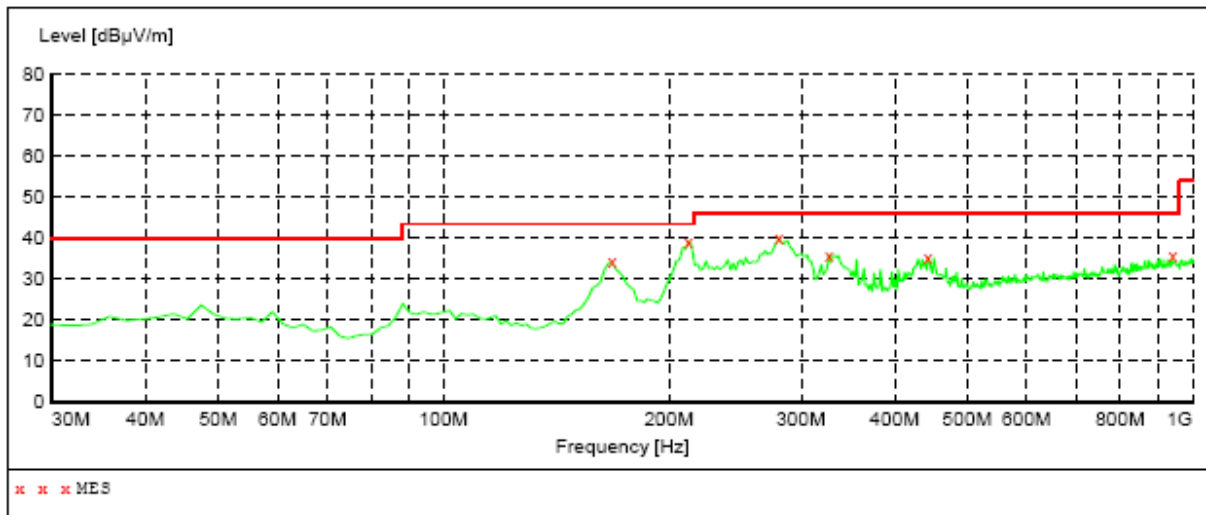

MEASUREMENT RESULT:

Frequency MHz	Level dBuV/m	Transd dB	Limit dBuV/m	Margin dB	Det.	Height cm	Azimuth deg	Polarization
167.740000	34.30	13.0	43.5	9.2	QP	100.0	0.00	HORIZONTAL
212.360000	39.30	15.1	43.5	4.2	QP	100.0	0.00	HORIZONTAL
280.260000	39.90	18.2	46.0	6.1	QP	100.0	0.00	HORIZONTAL
326.820000	36.00	19.5	46.0	10.0	QP	100.0	0.00	HORIZONTAL
443.220000	35.40	22.1	46.0	10.6	QP	100.0	0.00	HORIZONTAL
939.860000	35.80	29.5	46.0	10.2	QP	100.0	0.00	HORIZONTAL

The worst Spurious Emission Data BDR Mode Below 1GHz Channel Middle:

EUT: Accent 1400
M/N: ACN1400
Operating Condition: TX Mode
Test Site: 3m CHAMBER
Operator: Chen
Test Specification: DC 7.4V from battery
Comment: Polarization: Vertical

SWEEP TABLE: "test (30M-1G)"

Short Description:		Field Strength			
Start	Stop	Detector	Meas. Time	IF Bandw.	Transducer
Frequency	Frequency				
30.0 MHz	1.0 GHz	MaxPeak	Coupled	100 kHz	VULB9163 NEW

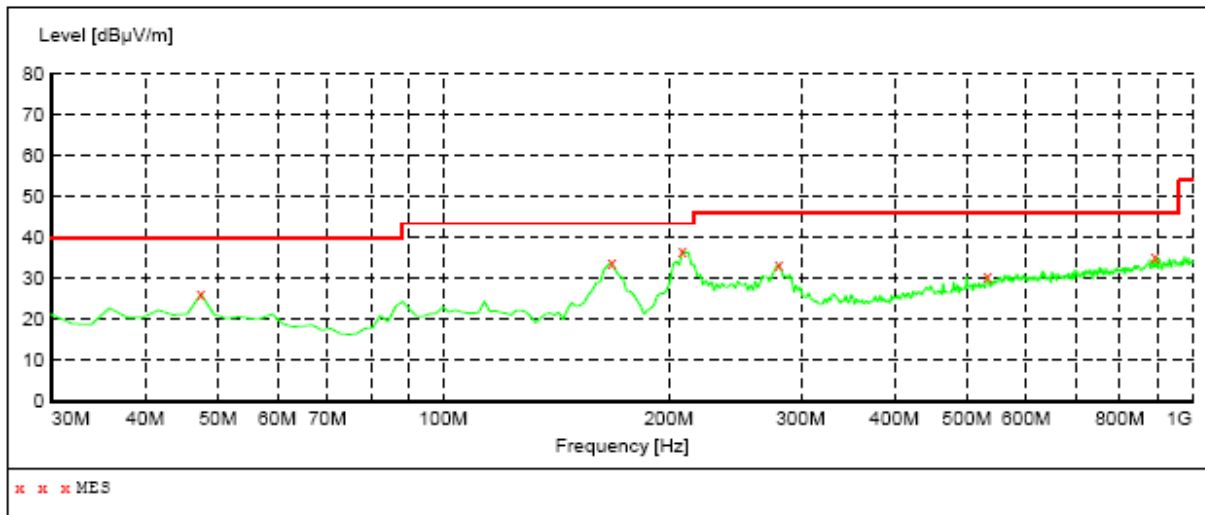

MEASUREMENT RESULT:

Frequency MHz	Level dBµV/m	Transd dB	Limit dBµV/m	Margin dB	Det.	Height cm	Azimuth deg	Polarization
47.460000	26.20	15.8	40.0	13.8	QP	100.0	0.00	VERTICAL
167.740000	33.90	13.0	43.5	9.6	QP	100.0	0.00	VERTICAL
208.480000	36.80	15.1	43.5	6.7	QP	100.0	0.00	VERTICAL
280.260000	33.20	18.2	46.0	12.8	QP	100.0	0.00	VERTICAL
532.460000	30.70	24.6	46.0	15.3	QP	100.0	0.00	VERTICAL
891.360000	35.30	29.1	46.0	10.7	QP	100.0	0.00	VERTICAL

The worst Spurious Emission Data BDR Mode Below 1GHz Channel High:

EUT: Accent 1400
M/N: ACN1400
Operating Condition: TX Mode
Test Site: 3m CHAMBER
Operator: Chen
Test Specification: DC 7.4V from battery
Comment: Polarization: Horizontal

SWEEP TABLE: "test (30M-1G)"

Short Description:		Field Strength			
Start	Stop	Detector	Meas. Time	IF Bandw.	Transducer
Frequency	Frequency	MaxPeak	Coupled	100 kHz	VULB9163 NEW
30.0 MHz	1.0 GHz				

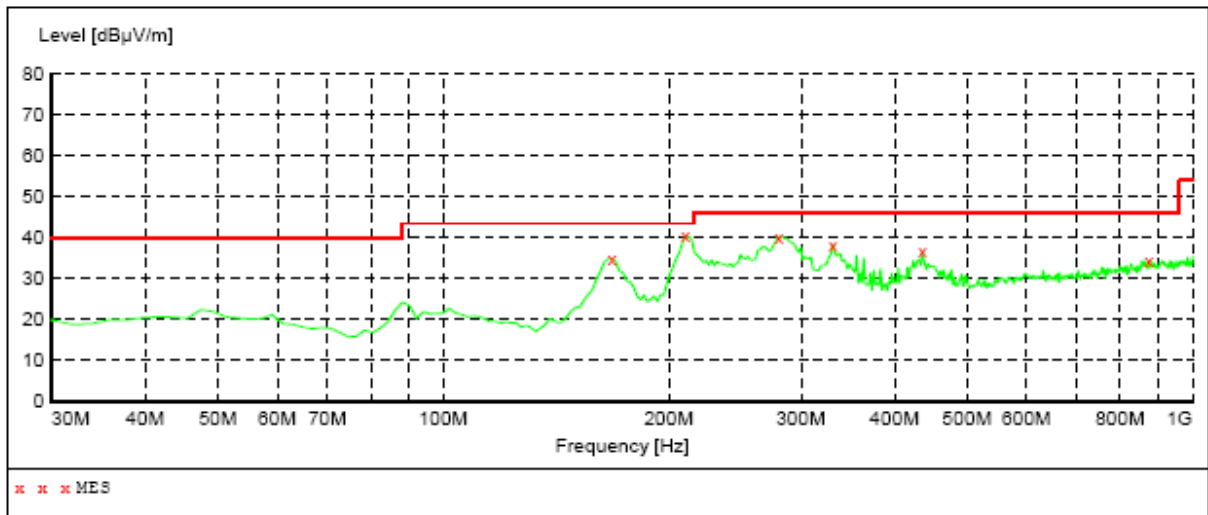

MEASUREMENT RESULT:

Frequency MHz	Level dBµV/m	Transd dB	Limit dBµV/m	Margin dB	Det.	Height cm	Azimuth deg	Polarization
167.740000	34.90	13.0	43.5	8.6	QP	100.0	0.00	HORIZONTAL
210.420000	40.40	15.1	43.5	3.1	QP	100.0	0.00	HORIZONTAL
280.260000	40.30	18.2	46.0	5.7	QP	100.0	0.00	HORIZONTAL
330.700000	38.30	19.7	46.0	7.7	QP	100.0	0.00	HORIZONTAL
435.460000	36.60	22.1	46.0	9.4	QP	100.0	0.00	HORIZONTAL
873.900000	34.40	28.9	46.0	11.6	QP	100.0	0.00	HORIZONTAL

The worst Spurious Emission Data BDR Mode Below 1GHz Channel High:

EUT: Accent 1400
M/N: ACN1400
Operating Condition: TX Mode
Test Site: 3m CHAMBER
Operator: Chen
Test Specification: DC 7.4V from battery
Comment: Polarization: Vertical

SWEEP TABLE: "test (30M-1G)"

Short Description:		Field Strength			
Start	Stop	Detector	Meas. Time	IF Bandw.	Transducer
Frequency	Frequency				
30.0 MHz	1.0 GHz	MaxPeak	Coupled	100 kHz	VULB9163 NEW

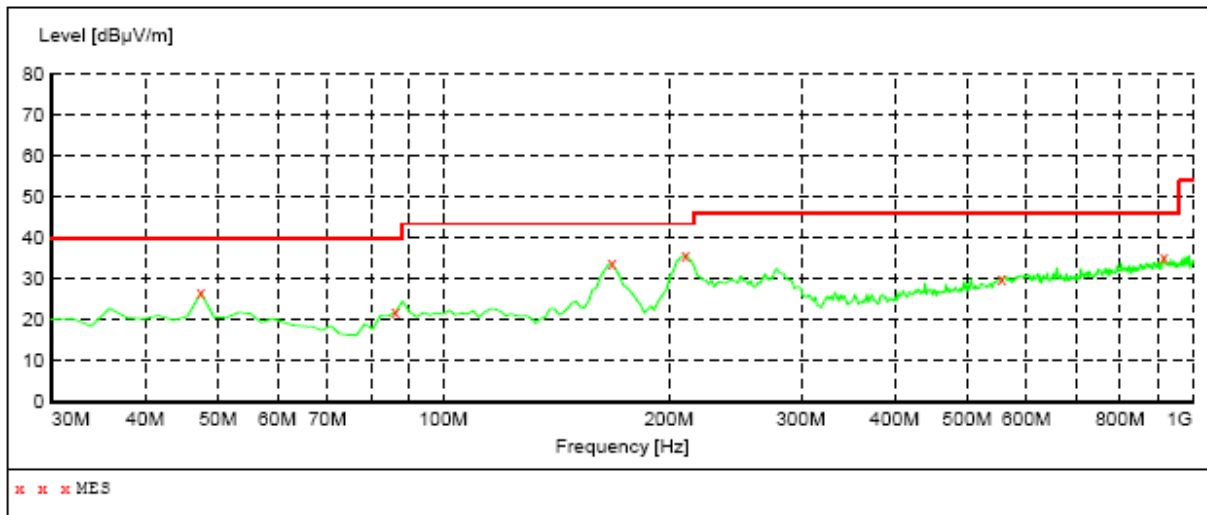

MEASUREMENT RESULT:

Frequency MHz	Level dBµV/m	Transd dB	Limit dBµV/m	Margin dB	Det.	Height cm	Azimuth deg	Polarization
47.460000	26.60	15.8	40.0	13.4	QP	100.0	0.00	VERTICAL
86.260000	21.90	14.8	40.0	18.1	QP	100.0	0.00	VERTICAL
167.740000	33.80	13.0	43.5	9.7	QP	100.0	0.00	VERTICAL
210.420000	35.90	15.1	43.5	7.6	QP	100.0	0.00	VERTICAL
555.740000	30.10	25.1	46.0	15.9	QP	100.0	0.00	VERTICAL
914.640000	35.50	29.3	46.0	10.5	QP	100.0	0.00	VERTICAL

The worst Spurious Emission Data BDR Mode Above 1GHz

Channel Low

Channel Low (2402MHz)								
Maximum Frequency (MHz)	Polarity and Level					Limit (dBµV/m)	Margin (dBµV/m)	Mark (P/Q/A)
	Polarity	Height (m)	Reading dBµV	Transd	Result dBµV/m			
2402	H	1	98.52	-7.15	91.37	N/A	N/A	P
			90.36	-7.15	83.21	N/A	N/A	A
2402	V	1	105.33	-7.15	98.18	N/A	N/A	P
			96.37	-7.15	89.22	N/A	N/A	A
4804	H	1	41.38	1.07	42.45	74	-31.55	P
			31.25	1.07	32.32	54	-21.68	A
4804	V	1	42.83	1.07	43.9	74	-30.1	P
			32.45	1.07	33.52	54	-20.48	A
7206	H	1	40.59	7.38	47.97	74	-26.03	P
			31.85	7.38	39.23	54	-14.77	A
7206	V	1	43.58	7.38	50.96	74	-23.04	P
			32.33	7.38	39.71	54	-14.29	A
9608	H	1	40.89	10.29	51.18	74	-22.82	P
			30.67	10.29	40.96	54	-13.04	A
9608	V	1	42.59	7.38	49.97	74	-24.03	P
			32.85	7.38	40.23	54	-13.77	A
12023.31	H	1	41.58	14.01	55.59	74	-18.41	P
			31.33	14.01	45.34	54	-8.66	A
12023.33	V	1	42.85	14.01	56.86	74	-17.14	P
			32.58	14.01	46.59	54	-7.41	A
25220.37	----	----	----	----	----	----	----	----

Remark: 1. Transd.=Antenna Factor+Cable Loss-Pre-amplifier
 Margin = Level-Limit
 Mark: P means Peak Value, Q means Quasi Peak Value, A means Average Value
 2. Data of measurement within this frequency range shown “-” in the table above means the reading of emissions are attenuated more than 20dB below the permissible limits or the field strength is too small to be measured.
 3. Spectrum analyzer setting P(Peak): RBW=1MHz, VBW=1MHz, A(Average): RBW=1MHz, VBW=10Hz.
 4. The test limit distance is 3m limit

Channel Mid

Channel Middle (2441MHz)								
Maximum Frequency (MHz)	Polarity and Level					Limit (dBµV/m)	Margin (dBµV/m)	Mark (P/Q/A)
	Polarity	Height (m)	Reading dBµV	Transd	Result dBµV/m			
2441	H	1	99.54	-6.37	93.17	N/A	N/A	P
			91.37	-6.37	85	N/A	N/A	A
2441	V	1	104.35	-6.37	97.98	N/A	N/A	P
			95.88	-6.37	89.51	N/A	N/A	A
4882	H	1	40.25	1.07	41.32	74	-32.68	P
			30.84	1.07	31.91	54	-22.09	A
4882	V	1	42.54	1.07	43.61	74	-30.39	P
			32.33	1.07	33.4	54	-20.6	A
7323	H	1	41.39	7.49	48.88	74	-25.12	P
			31.54	7.49	39.03	54	-14.97	A
7323	V	1	43.58	7.49	51.07	74	-22.93	P
			32.28	7.49	39.77	54	-14.23	A
9764	H	1	41.24	10.47	51.71	74	-22.29	P
			30.36	10.47	40.83	54	-13.17	A
9764	V	1	42.78	10.47	53.25	74	-20.75	P
			32.84	10.47	43.31	54	-10.69	A
12168.22	H	1	41.15	14.1	55.25	74	-18.75	P
			30.75	14.1	44.85	54	-9.15	A
12168.22	V	1	43.64	14.1	57.74	74	-16.26	P
			31.38	14.1	45.48	54	-8.52	A
25380.37	----	----	----	----	----	----	----	----

Remark: 1. Transd.=Antenna Factor+Cable Loss-Pre-amplifier
 Margin = Level-Limit
 Mark: P means Peak Value, Q means Quasi Peak Value, A means Average Value
 2. Data of measurement within this frequency range shown “-” in the table above means the reading of emissions are attenuated more than 20dB below the permissible limits or the field strength is too small to be measured.
 3. Spectrum analyzer setting P(Peak): RBW=1MHz, VBW=1MHz, A(Average): RBW=1MHz, VBW=10Hz.
 4. The test limit distance is 3m limit

Channel High

Channel High (2480MHz)								
Maximum Frequency (MHz)	Polarity and Level					Limit (dBµV/m)	Margin (dBµV/m)	Mark (P/Q/A)
	Polarity	Height (m)	Reading dBµV	Transd	Result dBµV/m			
2480	H	1	98.54	-6.05	92.49	N/A	N/A	P
			90.75	-6.05	84.7	N/A	N/A	A
2480	V	1	102.88	-6.05	96.83	N/A	N/A	P
			93.45	-6.05	87.4	N/A	N/A	A
4960	H	1	40.59	1.07	41.66	74	-32.34	P
			31.25	1.07	32.32	54	-21.68	A
4960	V	1	43.45	1.07	44.52	74	-29.48	P
			32.57	1.07	33.64	54	-20.36	A
7440	H	1	40.85	7.61	48.46	74	-25.54	P
			30.84	7.61	38.45	54	-15.55	A
7440	V	1	42.58	7.61	50.19	74	-23.81	P
			32.79	7.61	40.4	54	-13.6	A
9920	H	1	41.38	10.65	52.03	74	-21.97	P
			31.94	10.65	42.59	54	-11.41	A
9920	V	1	43.85	10.65	54.5	74	-19.5	P
			32.97	10.65	43.62	54	-10.38	A
12361.67	H	1	41.58	14.19	55.77	74	-18.23	P
			31.78	14.19	45.97	54	-8.03	A
12361.67	V	1	42.89	14.19	57.08	74	-16.92	P
			32.74	14.19	46.93	54	-7.07	A
25380.37	----	----	----	----	----	----	----	----

Remark: 1. Transd.=Antenna Factor+Cable Loss-Pre-amplifier
 Margin = Level-Limit
 Mark: P means Peak Value, Q means Quasi Peak Value, A means Average Value
 2. Data of measurement within this frequency range shown “-” in the table above means the reading of emissions are attenuated more than 20dB below the permissible limits or the field strength is too small to be measured.
 3. Spectrum analyzer setting P(Peak): RBW=1MHz, VBW=1MHz, A(Average): RBW=1MHz, VBW=10Hz.
 4. The test limit distance is 3m limit

The worst Spurious Emission Data BDR Mode Below 30 MHz

Frequency (MHz)	Read Level (dBuV)	Antenna Factor (dB/m)	Cable Loss (dB)	Emission Levels (dBuV/m)	Limit (dBµV/m)	Margin (dB)	Detector Mode
5.45	21.68	8.23	1.03	28.88	67	-38.12	QP
14.78	21.54	9.07	1.19	29.42	49.5	-20.08	QP
22.31	22.37	9.25	1.08	30.54	49.5	-18.96	QP
23.34	22.23	8.43	1.66	29	49.5	-20.5	QP

Note:

1. The pre-test have done for the EUT in three axes and found the worst emission at position shown in test setup photos. The worst case data is recorded in the report.
2. Emission level (dBuV/m) = Raw Value (dBuV) + Correction Factor (dB/m)
3. Correction Factor (dB/m) = Antenna Factor (dB/m) + Cable Factor (dB)
4. The other emission levels were very low against the limit.
5. Margin value = Emission level.- Limit value

**Conducted Spurious Emission
BDR 1M
Channel Low**

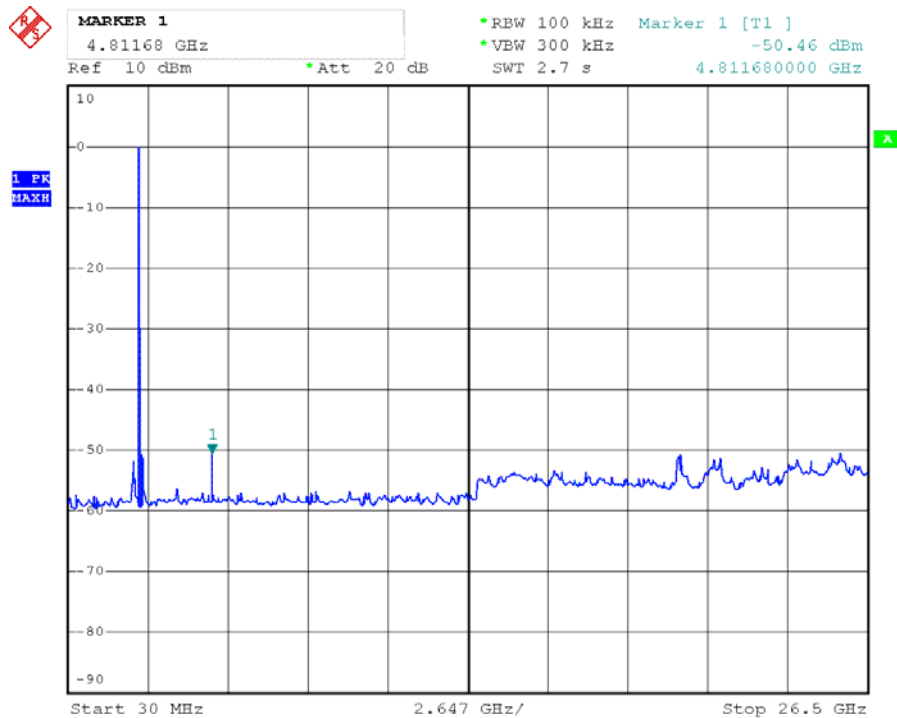

Channel Mid

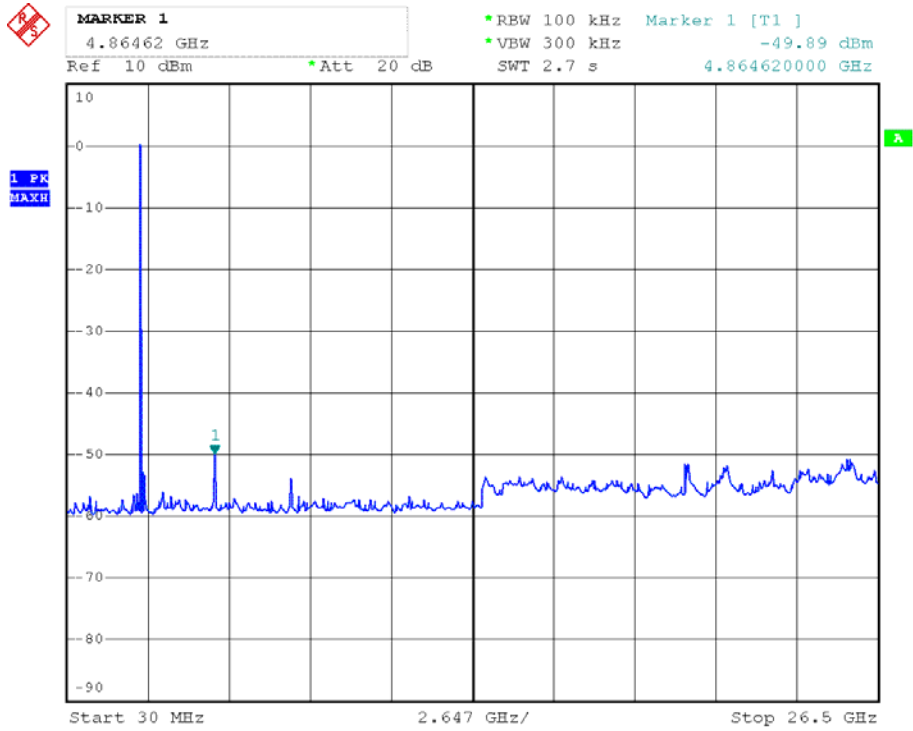

Channel High

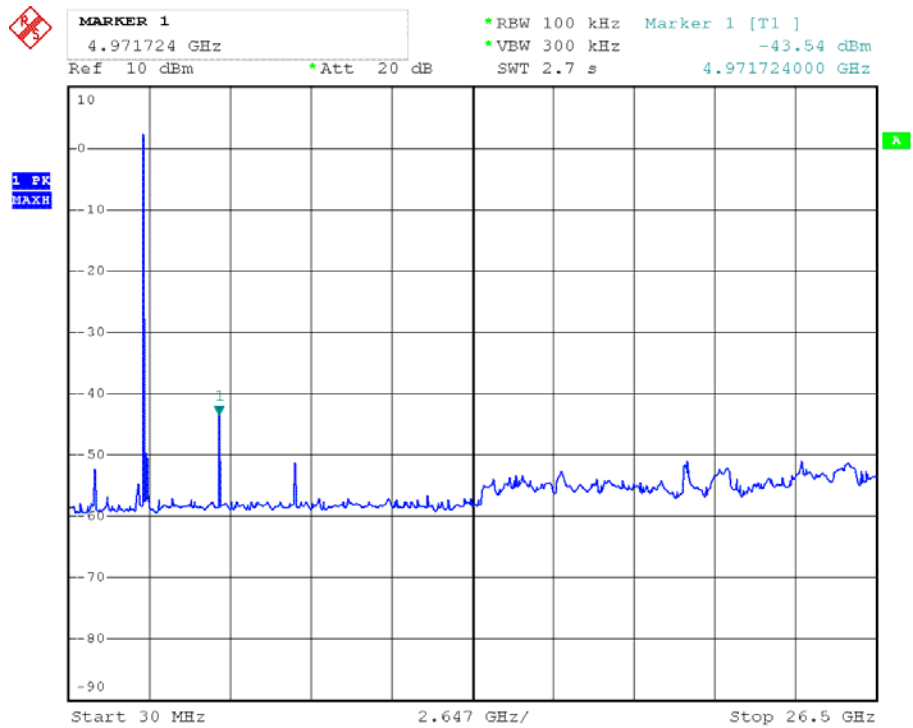

**BDR 2M
Channel Low**

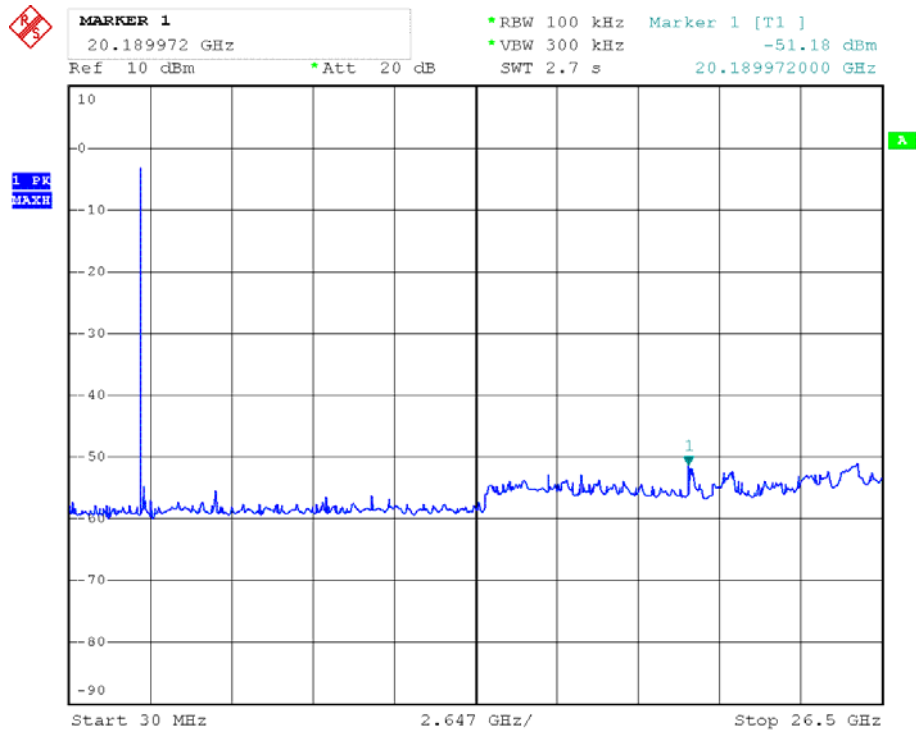

Channel Middle

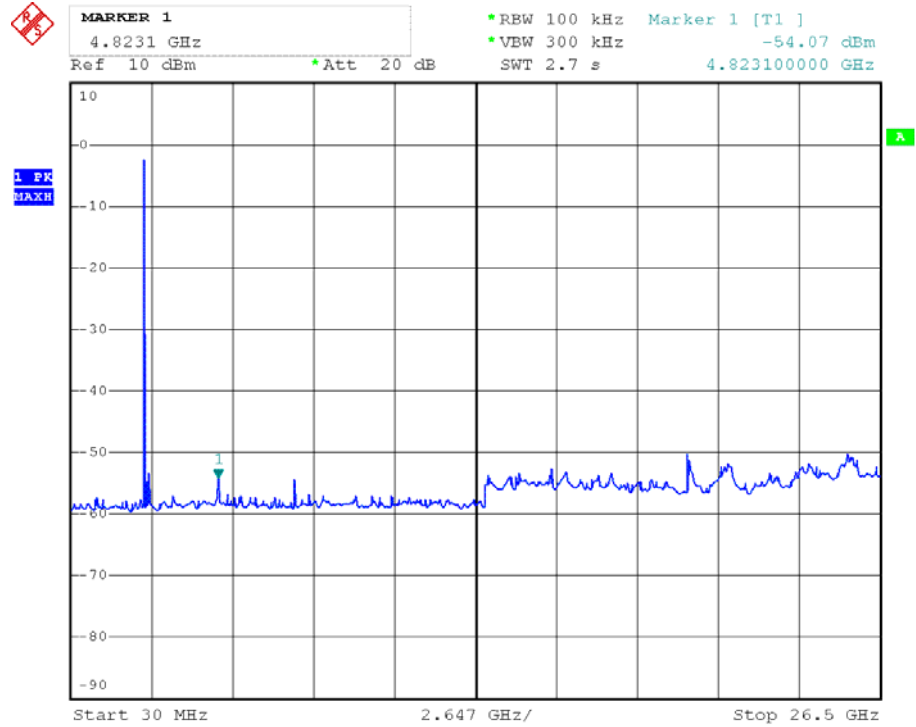

Channel High

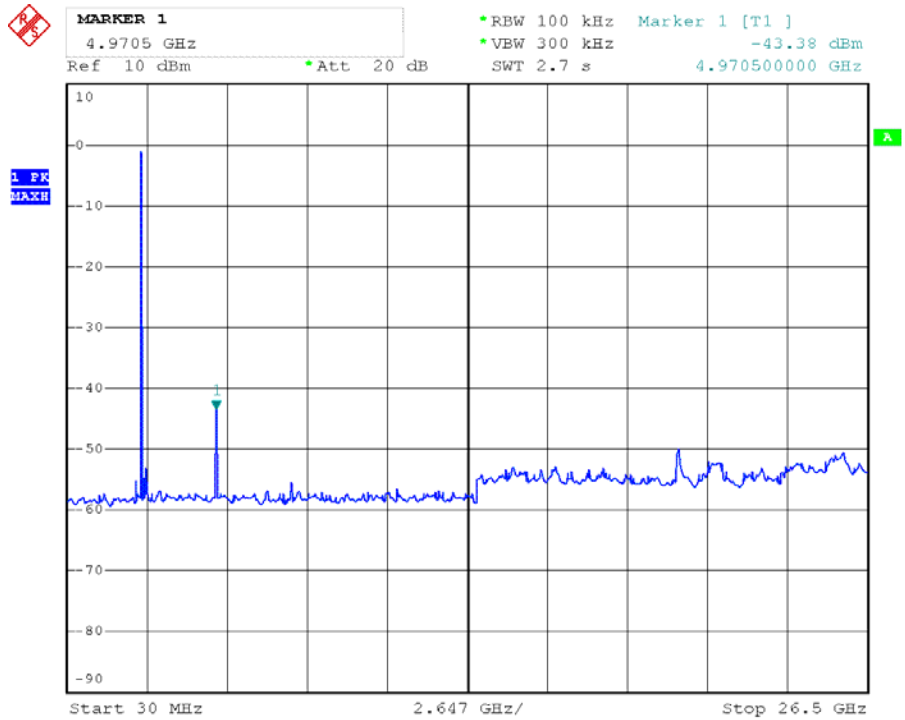

BDR 3M Channel Low

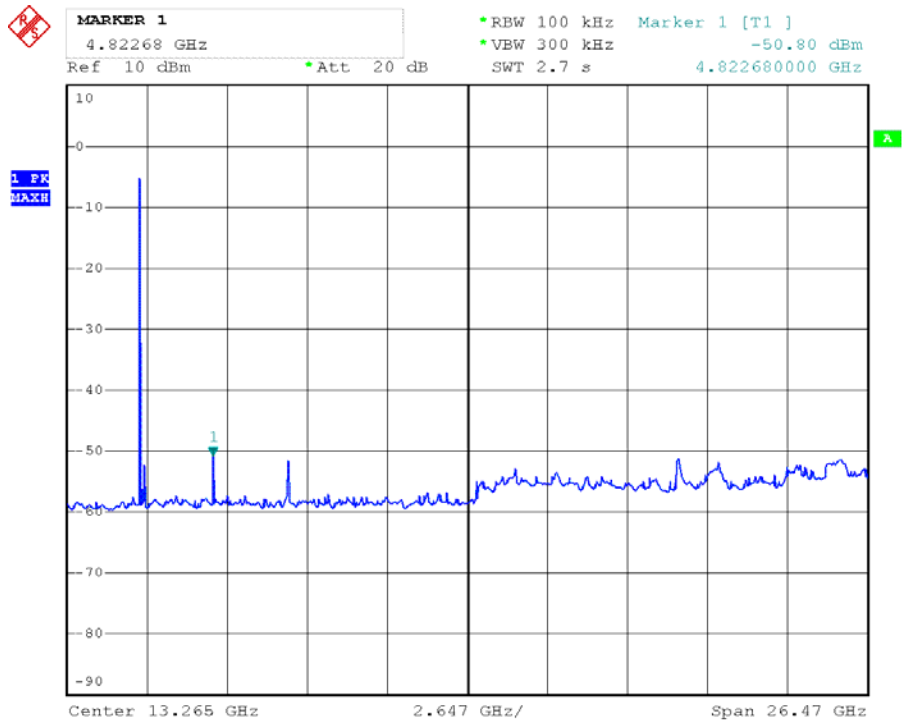

Channel Middle

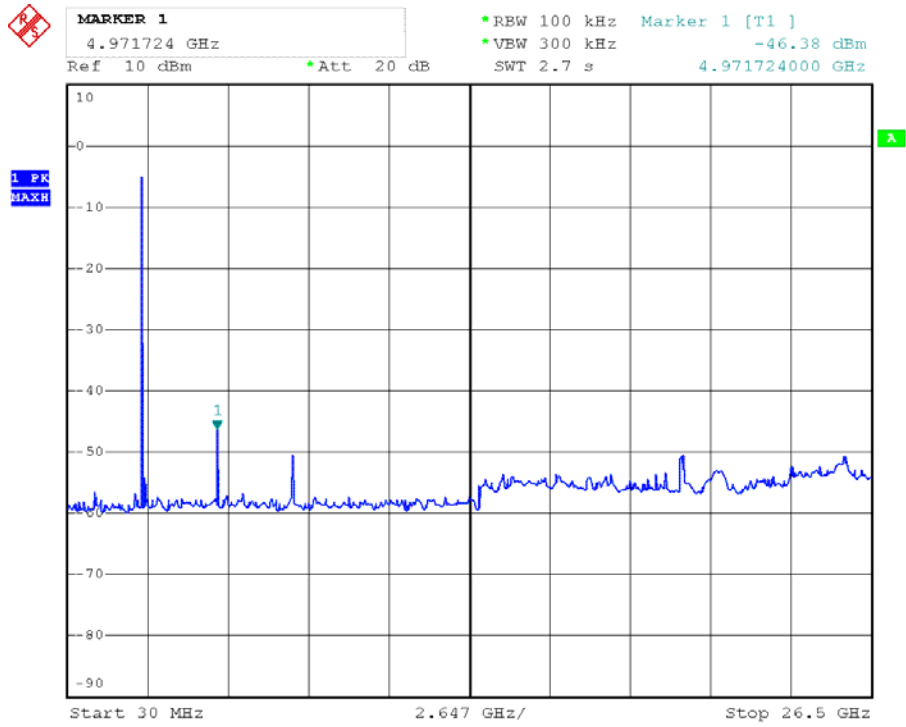

Channel High

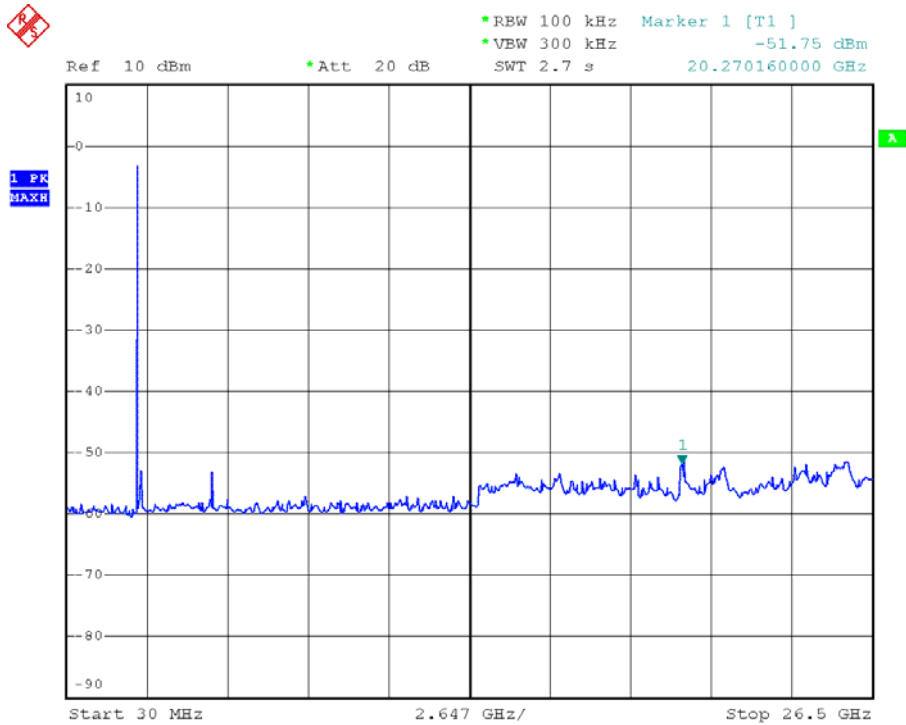

12. ANTENNA REQUIREMENT

12.1 Standard Applicable

Section 15.203:

An intentional radiator shall be designed to ensure that no antenna other than that furnished by the responsible party shall be used with the device. The use of a permanently attached antenna or of an antenna that uses a unique coupling to the intentional radiator shall be considered sufficient to comply with the provisions of this Section. The manufacturer may design the unit so that a broken antenna can be replaced by the user, but the use of a standard antenna jack or electrical connector is prohibited.

Section 15.247(b)/(c):

If transmitting antennas of directional gain greater than 6 dBi are used, the peak output power from the intentional radiator shall be reduced by the amount in dB that the directional gain of the antenna exceeds 6 dBi.

If the intentional radiator is used exclusively for fixed, point-to-point operations may employ transmitting antennas with directional gain greater than 6 dBi provided the maximum peak output power of the intentional radiator is reduced by 1 dB for every 3 dB that the directional gain of the antenna exceeds 6 dBi.

12.2 Antenna Connected Construction

The antenna is designed with permanent attachment and no consideration of replacement. The antenna used in this product is complied with Standard. The maximum Gain of the antenna lower than 6.0dBi and have the definite antenna Specification.