

EMC Test Report

regarding

USA: Part 90M + Waivers DA 23-343, 23-586 (Emissions)

for



Dual RSU

Category: C-V2X Transceiver

Judgments:

Aligns with Part 90M + DA 23-343, 23-586

Testing Completed: October 30, 2023



Prepared for:

Danlaw Inc.

41131 Vincenti Court, Novi Michigan 48375 USA

Phone: (248) 987-7384, Fax: (248) 471-4485

Contact: Scott Morell, scottm@danlawinc.com

Data Rec./Rev. by:

John Nantz
John Nantz

Rpt. Auth. by:

Joseph Brunett
Dr. Joseph Brunett, EMC-002790-NE

Rpt. Prep./Rev. by:

Joseph Brunett
Dr. Joseph Brunett, EMC-002790-NE

Date of Issue:

November 12, 2023

Revision History

Rev. No.	Date	Details	Revised By
r0	November 12, 2023	Initial Release.	J. Nantz
r1	December 15, 2023	Clarify modes.	J. Brunett
r2	January 18, 2024	Minor corrections, added Freq. Stab.	J. Nantz

Contents

Revision History	2
Table of Contents	2
1 Test Report Scope and Limitations	4
1.1 Laboratory Authorization	4
1.2 Report Retention	4
1.3 Subcontracted Testing	4
1.4 Test Data	4
1.5 Limitation of Results	4
1.6 Copyright	4
1.7 Endorsements	4
1.8 Test Location	5
1.9 Traceability and Equipment Used	5
2 Test Specifications and Procedures	6
2.1 Test Specification and General Procedures	6
3 Configuration and Identification of the Equipment Under Test	7
3.1 Description and Declarations	7
3.1.1 EUT Configuration	8
3.1.2 Modes of Operation	8
3.1.3 Variants	8
3.1.4 Test Samples	8
3.1.5 Functional Exerciser	8
3.1.6 Modifications Made	8
3.1.7 Production Intent	8
3.1.8 Declared Exemptions and Additional Product Notes	8
4 Emissions	9
4.1 General Test Procedures	9
4.1.1 Radiated Test Setup and Procedures	9
4.1.2 Conducted Emissions Test Setup and Procedures	11
4.1.3 Power Supply Variation	11
4.2 Intentional Emissions	12
4.2.1 Fundamental Emission Pulsed Operation	12
4.2.2 Fundamental Emission Bandwidth	13
4.2.3 Effective Isotropic Radiated Power	15
4.3 Unintentional Emissions	16
4.3.1 Transmit Chain Spurious Emissions	16
4.3.2 Transmit Emissions Mask (OOBE)	17
5 Measurement Uncertainty and Accreditation Documents	20

List of Tables

1.8.0 Test Site List.	5
1.9.0 Equipment List.	5
3.1.0 EUT Declarations.	7
4.2.1 Pulsed Emission Characteristics (Duty Cycle).	12
4.2.2 (i) Intentional Emission Bandwidth.	13
4.2.2 (ii) Intentional Emission Bandwidth.	14
4.2.3 Radiated Power Results.	15
4.3.1 Transmit Chain Spurious Emissions.	16
5.0.0 Measurement Uncertainty.	20

List of Figures

3.1.0 Photos of EUT.	7
3.1.1 EUT Test Configuration Diagram.	8
4.1.1 Radiated Emissions Diagram of the EUT.	9
4.1.1 Radiated Emissions Test Setup Photograph(s).	10
4.1.2 Conducted RF Test Setup Photograph(s).	11
4.2.1 Example Pulsed Emission Characteristics (Duty Cycle).	12
4.2.2 Example Intentional Emission Bandwidth.	13
4.2.3 Power Measurement Plots.	15
4.3.2 (i) Worst Case Transmitter OOB Emissions Measured.	17
4.3.2 (ii) Worst Case Transmitter OOB Emissions Measured.	18
4.3.2 (iii) Worst Case Transmitter OOB Emissions Measured.	19
5.0.0 Accreditation Documents	20

1 Test Report Scope and Limitations

1.1 Laboratory Authorization

Test Facility description and attenuation characteristics are on file with the FCC Laboratory, Columbia, Maryland (FCC Reg. No: US5348 and US5356) and with ISED Canada, Ottawa, ON (File Ref. No: 3161A and 24249). Amber Helm Development L.C. holds accreditation under NVLAP Lab Code 200129-0.

1.2 Report Retention

For equipment verified to comply with the regulations herein, the manufacturer is obliged to retain this report with the product records for the life of the product, and no less than ten years. A copy of this Report will remain on file with this laboratory until December 2033.

1.3 Subcontracted Testing

This report does not contain data produced under subcontract.

1.4 Test Data

This test report contains data included within the laboratory's scope of accreditation. Any data in this report that is not covered under the laboratory's scope is clearly identified.

1.5 Limitation of Results

The test results contained in this report relate only to the item(s) tested. Any electrical or mechanical modification made to the test item subsequent to the test date shall invalidate the data presented in this report. Any electrical or mechanical modification made to the test item subsequent to this test date shall require reevaluation.

1.6 Copyright

This report shall not be reproduced, except in full, without the written approval of Amber Helm Development L.C.

1.7 Endorsements

This report shall not be used to claim product endorsement by any accrediting, regulatory, or governmental agency.

1.8 Test Location

The EUT was fully tested by **Amber Helm Development L.C.**, headquartered at 92723 Michigan Hwy-152, Sister Lakes, Michigan 49047 USA. Table 1.8.0 lists all sites employed herein. Specific test sites utilized are also listed in the test results sections of this report where needed.

Table 1.8.0 Test Site List.

Description	Location	Quality Num.
OATS (3 meter)	3615 E Grand River Rd., Williamston, Michigan 48895	OATSC

1.9 Traceability and Equipment Used

Pertinent test equipment used for measurements at this facility is listed in Table 1.9.0 . The quality system employed at Amber Helm Development L.C. has been established to ensure all equipment has a clearly identifiable classification, calibration expiry date, and that all calibrations are traceable to the SI through NIST, other recognized national laboratories, accepted fundamental or natural physical constants, ratio type of calibration, or by comparison to consensus standards. All equipment is evaluated on a cycle no greater than 12 months following laboratory validation procedures and is calibrated following manufacturer recommended intervals.

Table 1.9.0 Equipment List.

Description	Manufacturer/Model	SN	Quality Num.	Cal/Ver By / Date Due
Spectrum Analyzer	R & S / FSW67	103233	RSFSW67	RS / Aug-2024
Quad Ridge Horn	Singer / A6100	C35200	HQR1TO18S01	Keysight / Aug-2024
Biconical	EMCO / 93110B	9802-3039	BICEMCO01	Keysight / Aug-2025
Log Periodic Antenna	EMCO / 3146	9305-3614	LOGEMCO01	Keysight / Aug-2025
K-Band Horn	JEF / NRL Std.	001	HRNK01	AHD / Jul-2024
BNC-BNC Coax	WRTL / RG58/U	001	CAB001-BLACK	AHD / July-2024
3.5-3.5MM Coax	PhaseFlex / PhaseFlex	001	CAB015-PURP	AHD / July-2024

2 Test Specifications and Procedures

2.1 Test Specification and General Procedures

The goal of Danlaw Inc. is to demonstrate that the Equipment Under Test (EUT) complies with the Rules and/or Directives below. Detailed in this report are the results of testing the Danlaw Inc. Dual RSU for compliance to:

Country/Region/Manu.	Rules or Directive	Referenced Section(s)
United States	Code of Federal Regulations	Part 90M + Waivers DA 23-343, 23-586

It has been determined that the equipment under test is subject to the rules and directives above at the date of this testing. In conjunction with these rules and directives, the following specifications and procedures are followed herein to demonstrate compliance (in whole or in part) with these regulations.

ANSI C63.4:2014	"Methods of Measurement of Radio-Noise Emissions from Low-Voltage Electrical and Electronic Equipment in the Range of 9 kHz to 40 GHz"
ANSI C63.10:2013	"American National Standard of Procedures for Compliance Testing of Unlicensed Wireless Devices"
ANSI C63.26:2015	"American National Standard for Compliance Testing of Transmitters Used in Licensed Radio Services"
KDB 511808 D01 v01	"Equipment Authorization for Cellular Vehicle-to-Everything Devices for Operation Pursuant to Waiver of Certain Part 90 and Part 95 Rules"
Waiver: DA-23-343	"Request for Waiver of 5.9 GHz Band Rules to Permit Initial Deployment of Cellular Vehicle-to-Everything Technology"
Waiver: DA-23-586	"Request to Modify April 24, 2023 Waiver Order of the 5.9 GHz Band Rules to Permit Initial Deployment of Cellular Vehicle-to-Everything Technology"
WR-ITP0102RA	"AHD Internal Document - Radiated Emissions Test Method"
WR-ITP0101LC	"AHD Internal Document - Conducted Emissions Test Method"

3 Configuration and Identification of the Equipment Under Test

3.1 Description and Declarations

The EUT is a Roadside Unit (RSU) in an Intelligent Transportation Services (ITS) architecture as defined in 47 CFR 90.350 employing 2 radios for DSRC and C-V2X services. The EUT is approximately 27 x 18 x 9 cm in dimension, and is depicted in Figure 3.1.0 . It is powered by 48 VDC PoE. This product is used as a Roadside mounted transceiver within an ITS architecture. Table 3.1.0 outlines provider declared EUT specifications.



Figure 3.1.0 Photos of EUT.

Table 3.1.0 EUT Declarations.

General Declarations	
Equipment Type:	C-V2X Transceiver
Country of Origin:	USA
Nominal Supply:	48 VDC
Oper. Temp Range:	-34C to 74C
Frequency Range:	5905 - 5925 MHz
Antenna Dimension:	17.8 x 2.2 cm
Antenna Type:	GTT Wireless Monopole (See datasheet.)
Antenna Gain:	7.6 dBi max.
Number of Channels:	1
Channel Spacing:	Not applicable
Alignment Range:	Not Declared
Type of Modulation:	GFSK
United States	
FCC ID Number:	2AD9I9310047DUALRSU
Classification:	ITR

3.1.1 EUT Configuration

The EUT is configured for testing as depicted in Figure 3.1.1 .

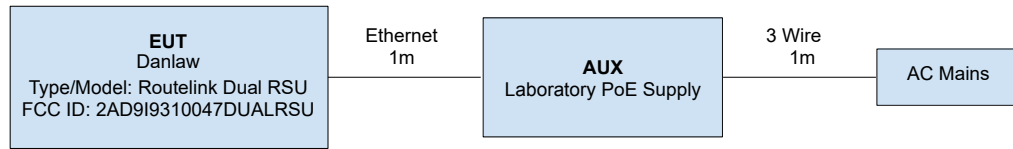

Figure 3.1.1 EUT Test Configuration Diagram.

3.1.2 Modes of Operation

The EUT employs two radios for the purpose of supporting an ITS architecture: A DSRC radio not addressed in this report, and a C-V2X radio. The C-V2X radio herein employs 26 Mbps data rate on a single channel centered at 5915 MHz. The product operates only in spatially differentiated SISO mode, alternating transmissions between two antenna ports. The manufacturer has provided commands to configure forced transmissions during testing.

3.1.3 Variants

There is only a single variant of the EUT.

3.1.4 Test Samples

One normal operating sample (SN: 23370021) of the EUT was provided for testing.

3.1.5 Functional Exerciser

Normal operating EUT functionality was verified by observation of the transmitted signal.

3.1.6 Modifications Made

There were no modifications made by this lab.

3.1.7 Production Intent

The EUT appears to be a production ready sample.

3.1.8 Declared Exemptions and Additional Product Notes

The EUT employs two radios for the purpose of supporting an ITS architecture: A DSRC radio according to FCC Part 90, Subpart M implemented via a pre-certified module (FCC ID: XPYVERAP174) and the C-V2X radio which is tested herein. The manufacturer declares these two radios can not operate at the same time and are firmware selected by the manufacturer. The DSRC radio in this product is utilized following manufacturer SDoC procedures documented separately. The C-V2X radio as tested herein operates under FCC Order Waiver's according to FCC Docket No. 19-138: DA 23-343 and DA 23-586. The manufacturer declares that they will comply with all the provisions as stated within the C-V2X waivers listed herein. This product is professionally installed. The digital device portion of the EUT will be handled via SDoC.

4 Emissions

4.1 General Test Procedures

4.1.1 Radiated Test Setup and Procedures

Radiated electromagnetic emissions from the EUT are first pre-scanned in our screen room. Spectrum and modulation characteristics of all emissions are recorded. Instrumentation, including spectrum analyzers and other test equipment as detailed in Section 1.8 are employed. After pre-scan, emission measurements are made on the test site of record. If the EUT connects to auxiliary equipment and is table or floor standing, the configurations prescribed in relevant test standards are followed. Alternatively, a layout closest to normal use (as declared by the provider) is employed if the resulting emissions appear to be worst-case in such a configuration. See Figure 4.1.1 . All intentionally radiating elements that are not fixed-mounted in use are placed on the test table lying flat, on their side, and on their end (3-axes) and the resulting worst case emissions are recorded. If the EUT is fixed-mounted in use, measurements are made with the device oriented in the manner consistent with installation and then emissions are recorded. If the EUT exhibits spurious emissions due to internal receiver circuitry, such emissions are measured with an appropriate carrier signal applied.

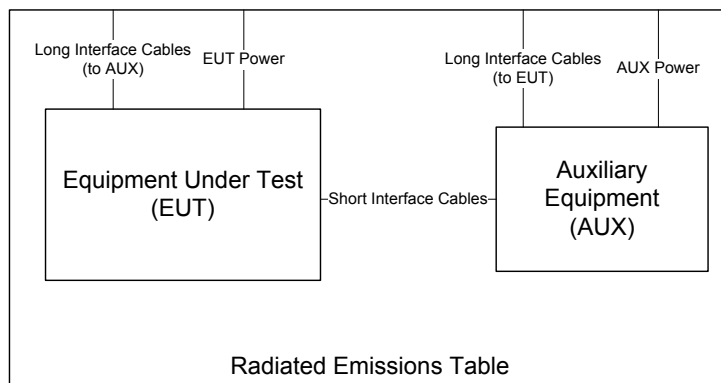

Figure 4.1.1 Radiated Emissions Diagram of the EUT.

For devices with intentional emissions below 30 MHz, a shielded loop antenna and/or E-field and H-Field broadband probes are used depending on the regulation. Shielded loops are placed at a 1 meter receive height at the desired measurement distance. For exposure in this band, 10cm diameter single-axis broadband probes meeting the requirements of ISED SPR-002 section 5.2 are employed. Measurements are repeated and summed over three axes, and the entire frequency range is measured with and without the EUT transmitting.

Emissions between 30 MHz and 1 GHz are measured using calibrated broadband antennas. For both horizontal and vertical polarizations, the test antenna is raised and lowered from 1 to 4 m in height until a maximum emission level is detected. The EUT is then rotated through 360° in azimuth until the highest emission is detected. The test antenna is then raised and lowered one last time from 1 to 4 m and the worst case value is recorded. Emissions above 1 GHz are characterized using standard gain or broadband ridge-horn antennas on our OATS with a 4×5 m rectangle of ECCOSORB absorber covering the OATS ground screen and a 1.5m table height. Care is taken to ensure that test receiver resolution and video bandwidths meet the regulatory requirements, and that the emission bandwidth of the EUT is not reduced. Photographs of the test setup employed are depicted in Figure 4.1.1 .

Where regulations allow for direct measurement of field strength, power values (dBm) measured on the test receiver / analyzer are converted to $\text{dB}\mu\text{V}/\text{m}$ at the regulatory distance, using

$$E_{dist} = 107 + P_R + K_A - K_G + K_E - C_F$$

where P_R is the power recorded on spectrum analyzer, in dBm, K_A is the test antenna factor in dB/m, K_G is the combined pre-amplifier gain and cable loss in dB, K_E is duty correction factor (when applicable) in dB, and C_F is a distance conversion (employed only if limits are specified at alternate distance) in dB. This field strength value is then compared with the regulatory limit. If effective isotropic radiated power (EIRP) is computed, it is computed as

$$EIRP(\text{dBm}) = E_{3m}(\text{dB}\mu\text{V}/\text{m}) - 95.2.$$

When presenting data at each frequency, the highest measured emission under all possible EUT orientations (3-axes) is reported.



Figure 4.1.1 Radiated Emissions Test Setup Photograph(s).

4.1.2 Conducted Emissions Test Setup and Procedures

Transmit Antenna Port Conducted Emissions At least one sample EUT supplied for testing was provided with a 50 Ω antenna port. Conducted transmit chain emissions measurements (where applicable) are made by connecting the EUT antenna port directly to the test receiver port. Photographs of the test setup employed are depicted in Figure 4.1.2 .

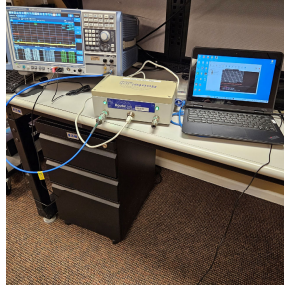

Figure 4.1.2 Conducted RF Test Setup Photograph(s).

4.1.3 Power Supply Variation

Tests at extreme supply voltages are made if required by the procedures specified in the test standard, and results of this testing are detailed in this report.

4.2 Intentional Emissions

4.2.1 Fundamental Emission Pulsed Operation

The details and results of testing the EUT for pulsed operation are summarized in Table 4.2.1 . Plots showing the measurements made to obtain these values are provided in Figure 4.2.1 .

Table 4.2.1 Pulsed Emission Characteristics (Duty Cycle).

Frequency Range f > 1 000 MHz	Det Pk	IFBW 10 MHz	VBW 10 MHz	Test Date: 3-Oct-23
				Test Engineer: J. Nantz
				EUT Danlaw Dual RSU
				Meas. Distance: Conducted

Pulsed Operation / Duty Cycle									
R0	Transmit Mode	Symbol Rate (Msym/s)	Data Rate (Mbps)	Voltage (V)	Oper. Freq (MHz)	Tx Cycle Time (ms)	On-Time (ms)	Duty Cycle (%)	Power Duty Correction (dB)
R1	C-V2X (Cont Modulated)	-	26.0	55.0	5915.0	100.000	0.929	0.9	-20.0
#	C1	C2	C3	C4	C5	C6	C7	C8	C9

(ROW) R0 (COLUMN) C9 NOTE Duty factor is shown as a data point only and is not considered in the calculation of fundamental power.

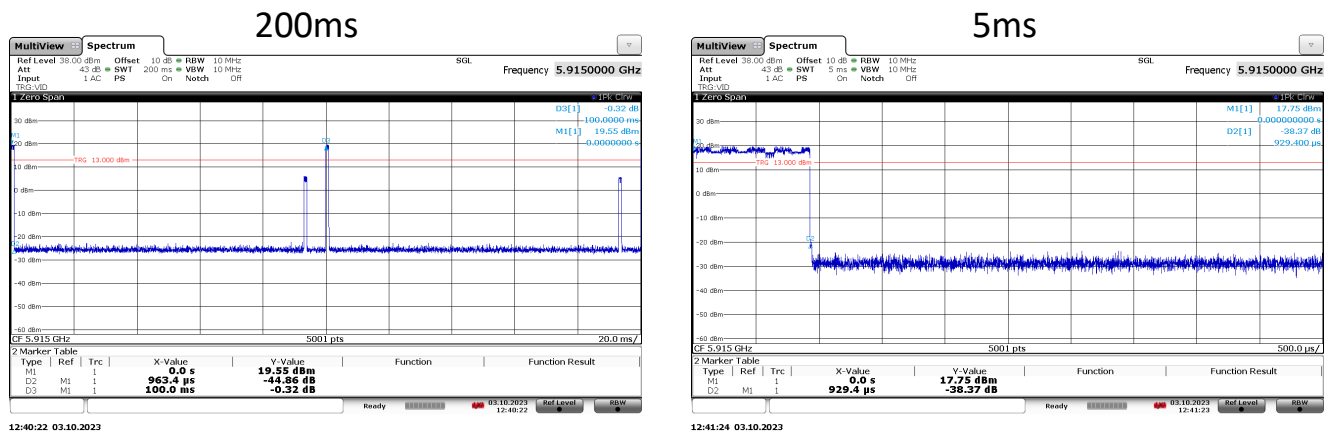

Figure 4.2.1 Example Pulsed Emission Characteristics (Duty Cycle).

4.2.2 Fundamental Emission Bandwidth

Emission bandwidth (EBW) of the EUT is measured with the device placed in the worst case test mode. Radiated emissions are recorded following the test procedures listed in Section 2.1. The 26 dBc and 99% EBW is measured as the max-held peak-detected signal when the IF bandwidth is greater than or equal to 1% of the receiver span. The results of EBW testing are summarized in Table 4.2.2 . Plots showing measurements employed to obtain the emission bandwidth reported are provided in Figure 4.2.2 .

Table 4.2.2 (i) Intentional Emission Bandwidth.

Frequency Range f > 1 000 MHz	Det Pk	IFBW 300 kHz	VBW 10 MHz	Test Date: 10/03/23
				Test Engineer: J. Nantz
				EUT Danlaw Dual RSU
				Meas. Distance: Conducted

Occupied Bandwidth												
R0	EUT Port	Transmit Mode	Data Rate (Mbps)	Voltage (V)	Oper. Freq (MHz)	26 dB BW (MHz)	fL Measured (MHz)	fL Limit (MHz)	fH Measured (MHz)	fH Limit (MHz)	99% OBW (MHz)	Pass/Fail
R1	ANT 1	C-V2X (Cont Modulated)	26.0	55.0	5915.0	18.610	5.90547	5905.000	5.92408	5925.000	17.598	Pass
R2	ANT 2	C-V2X (Cont Modulated)	26.0	55.0	5915.0	18.580	5.90553	5905.000	5.92411	5925.000	17.569	Pass
#	C1	C2	C3	C4	C5	C6	C7	C8	C9	C10	C11	C12
	(ROW)	(COLUMN)	NOTE									
	R0	C5/C11	ref. KDB Guidance 511808 D01 C-V2X Waiver v01, section 3.1 Both 26dB and 99% OBW is to be measured.									
	R0	C8/C10	ref. FCC DA-23-343, section III(B)(19) C-V2X Joint Waiver, OBW must stay within the channel.									

Antenna Port 1

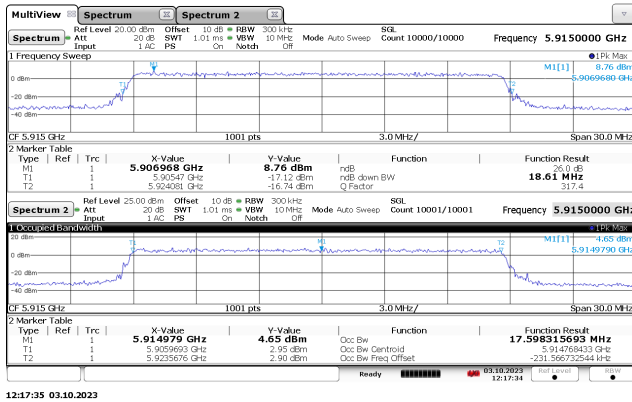

Antenna Port 2

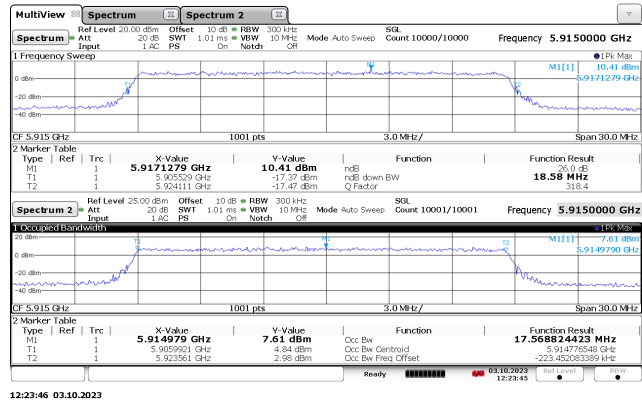

Figure 4.2.2 Example Intentional Emission Bandwidth.

4.2.3 Effective Isotropic Radiated Power

EUT transmit power is measured via antenna port conducted power measurements and added to antenna gain to compute EIRP. Where the EUT is not sold with an antenna connector, a modified product may be provided for conducted measurements. The results of this testing are summarized in Table 4.2.3 . Example plots showing the measurements made to obtain these values are provided in Figure 4.2.3 .

Table 4.2.3 Radiated Power Results.

Test Date: 3-Oct-23
Test Engineer: J. Nantz
EUT: Danlaw Dual RSU
Meas. Distance: Conducted

FCC/IC

R0	Mode	Ant Elevation (deg.)	Freq. (MHz)	EUT Height (m)	Ant. Height (m)	Pout (Pk) (dBm)	Pout (RMS) (dBm)	Ant Gain (dBi)	EIRP (RMS) (dBm)	EIRP Limit (dBm)	Pass (dB)
R1	TX - ANT1	0	5915.0				15.6	7.6	23.2	33.0	9.8
R2	TX - ANT2	0	5915.0				16.7	7.6	24.3	33.0	8.7
#	C1	C2	C3	C4	C5	C6	C7	C8	C9	C11	C12

(ROW) (COLUMN) NOTE
 R0 C7 EIRP is calculated using conducted measurements and antenna data sheet per KDB Guidance 511808 D01 C-V2X Waiver v01, section 3.2.1 (a).
 R0 C11 ref. FCC DA-23-586, section III(9) and (10) C-V2X Joint Waiver.

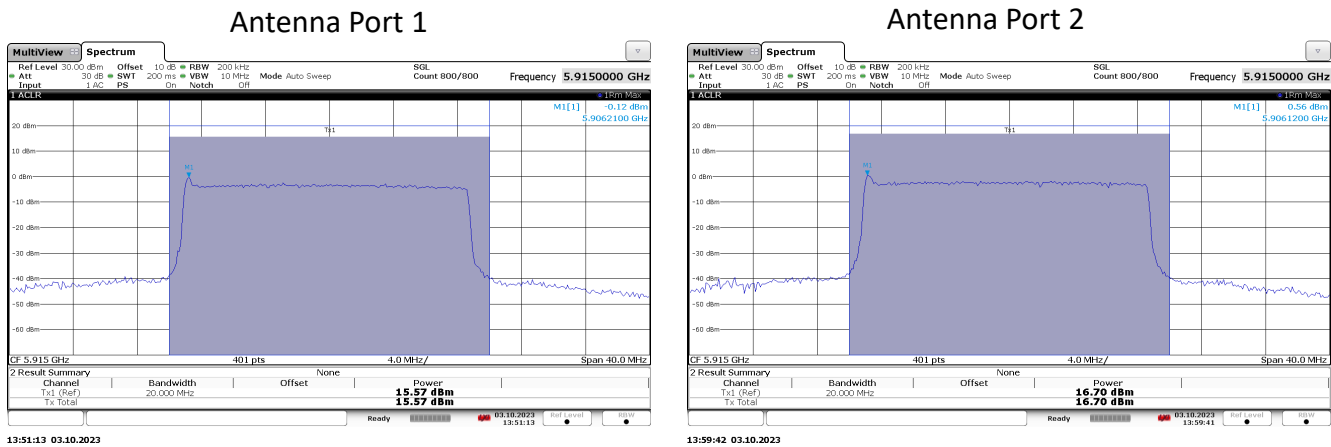

Figure 4.2.3 Power Measurement Plots.

4.3 Unintentional Emissions

4.3.1 Transmit Chain Spurious Emissions

The results for the measurement of transmit chain spurious emissions at the nominal voltage and temperature are provided in Table 4.3.1 .

Table 4.3.1 Transmit Chain Spurious Emissions.

EUT Modes: a1 Continuous Modulated a5
 EUT: Danlaw Dual RSU a2 a6
 Test Date(s): 12/12/23 a3 a7
 Test Engineer: J. Nantz a4 a8

R0	Frequency		Temp. Hum	Table Angle	Site			CF	EUT			Test Antenna				Cable Mixer CL/Kg dB	Receiver Bandwidth RBW/VBW MHz	Field Strength @ DR				EIRP				Pass/Fail dB	Comments	
	Start MHz	Stop MHz			MR	DR	N/F		Mode	Volt. (V)	Dim cm	Pol. H/V	Ant. Height m	Dim. cm	Ka dB/m			Pk Meas.	QPk/Avg Lim.	Pk Meas.	QPk/Avg Lim.	Calc.	Lim.	Calc.	Lim.			
R1	SETUP				OATSC				DUAL RSU			BICEMCO01				CBL01	FSW67											
R2	30.0	88.0	2 64	0.0	3.0	3.0	0.0	0.0	a1	13.5	5.0	H/V	1-4			0.10	0.03	33.7					-61.5	-40.0			21.5	
R3	88.0	216.0	2 64	0.0	3.0	3.0	0.0	0.0	a1	13.5	5.0	H/V	1-4			0.10	0.03	30.3					-64.9	-40.0			24.9	
R4	SETUP				OATSC				DUAL RSU			LOGEMCO01				CBL01	FSW67											
R5	216.0	1000.0	2 64	0.0	3.0	3.0	0.0	0.0	a1	13.5	5.0	H/V	1-4			0.10	0.03	36.9					-58.3	-40.0			18.3	
R8	SETUP				OATSC				DUAL RSU			HQRI1018S01				CBL018WHT	FSW67											
R9	1000.0	5885.0	2 64	0.0	3.0	3.0	0.9	0.0	a1	13.5	5.0	H/V	1.5	15.0		0.10	0.03	43.1					-52.1	-40.0			12.1	
R10	5945.0	18000.0	2 64	0.0	3.0	3.0	2.7	0.0	a1	13.5	5.0	H/V	1.5	15.0		0.10	0.03	50.3					-44.9	-40.0			4.9	
R11	11830.0	11830.0	2 64	0.0	3.0	3.0	1.8	0.0	a1	13.5	5.0	H/V	1.5	15.0		0.10	0.03	44.9					-50.3	-40.0			10.3	
R12	17745.0	17745.0	2 64	0.0	3.0	3.0	2.7	0.0	a1	13.5	5.0	H/V	1.5	15.0		0.10	0.03	48.2					-47.0	-40.0			7.0	
R13	SETUP				OATSC				DUAL RSU			HRNK01				CBL04	FSW67											
R14	18000.0	26500.0	2 64	0.0	3.0	3.0	1.8	0.0	a1	13.5	5.0	H/V	1.5	10.2		0.10	0.03	46.5					-48.7	-40.0			8.7	
R15	23660.0	23660.0	2 64	0.0	3.0	3.0	1.6	0.0	a1	13.5	5.0	H/V	1.5	10.2		0.10	0.03	44.6					-50.6	-40.0			10.6	
R16	SETUP				OATSC				DUAL RSU			HRNKA01				CBL05/LNA01	FSW67											
R17	26500.0	40000.0	2 64	0.0	3.0	3.0	2.3	0.0	a1	13.5	5.0	H/V	1.5	9.2		0.10	0.03	30.3					-64.9	-40.0			24.9	
R18	29575.0	29575.0	2 64	0.0	3.0	3.0	1.7	0.0	a1	13.5	5.0	H/V	1.5	9.2		0.10	0.03	18.6					-76.6	-40.0			36.6	
R19	35490.0	35490.0	2 64	0.0	3.0	3.0	2.0	0.0	a1	13.5	5.0	H/V	1.5	9.2		0.10	0.03	22.7					-72.5	-40.0			32.5	
#	C1	C2	C3	C4	C5	C6	C7	C8	C9	C10	C11	C12	C13	C14	C15	C16	C17	C18	C19	C20	C21	C22	C23	C24	C25	C26	C27	C28

- (ROW) (COLUMN) NOTE:
- R0 C5 MR is Measurement Range, which may be reduced from DR to achieve necessary SNR.
 - R0 C6 DR is the regulatory Desired Range measurement distance.
 - R0 C7 N/F is Near-Field / Far-Field distance computed for max of Antenna Dimension (C11 or C14) computed above 1 GHz.
 - R0 C8 CF is computed using a 20 dB/decade Decay Rate.
 - R0 C19 When E-field is reported directly from Spectrum Analyzer, Antenna Factors and Cable losses are included directly in SA settings. Max of background noise or EUT emissions recorded.
 - R0 C23 EIRP is computed from Field strength as follows: EIRP = Efield(3m) - 95.2
 - R0 C24 Limit according to ref. KDB Guidance 511808 D01 C-V2X Waiver v01, figure 2.

4.3.2 Transmit Emissions Mask (OOBE)

The results for the measurement of transmit chain Out-of-Band-Emissions (OOBE) spurious emissions in a 100 kHz receiver bandwidth (at the nominal voltage and temperature) in the worst cases are provided in Figure 4.3.2 below.

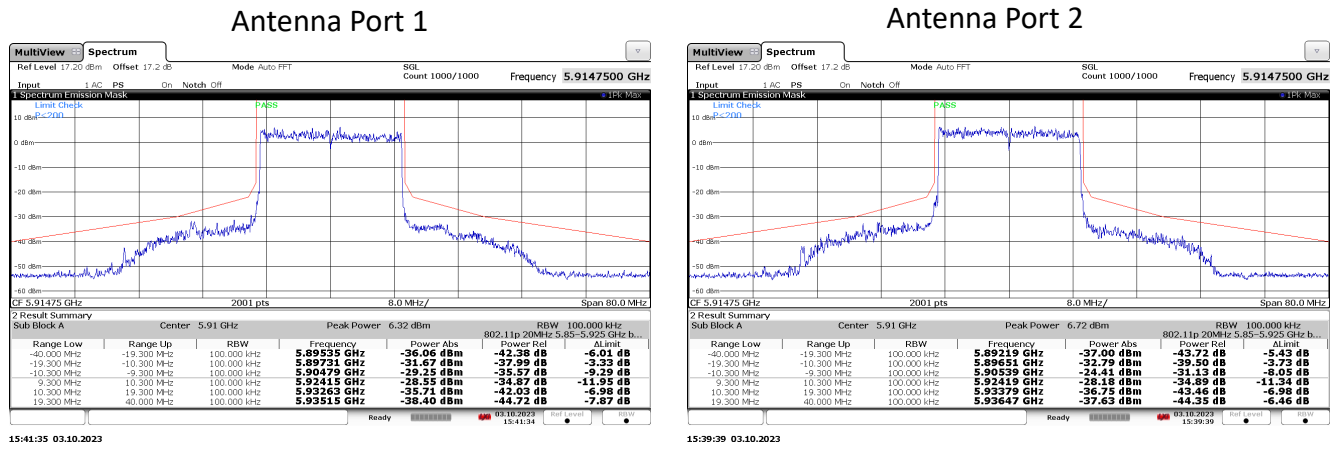

Figure 4.3.2 (i) Worst Case Transmitter OOBE Emissions Measured.

Antenna Port 1

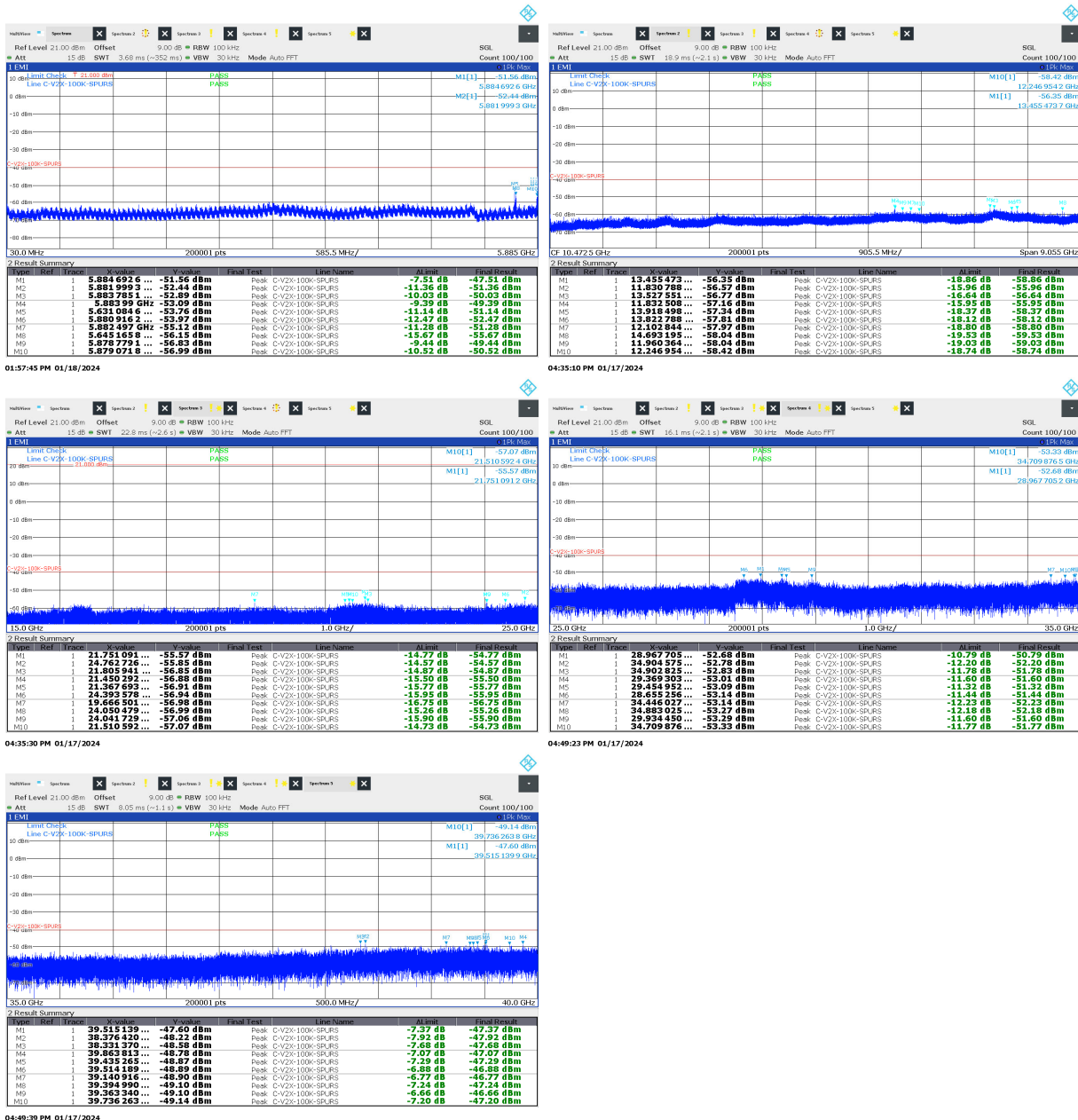

Figure 4.3.2 (ii) Worst Case Transmitter OOB Emissions Measured.

Antenna Port 2

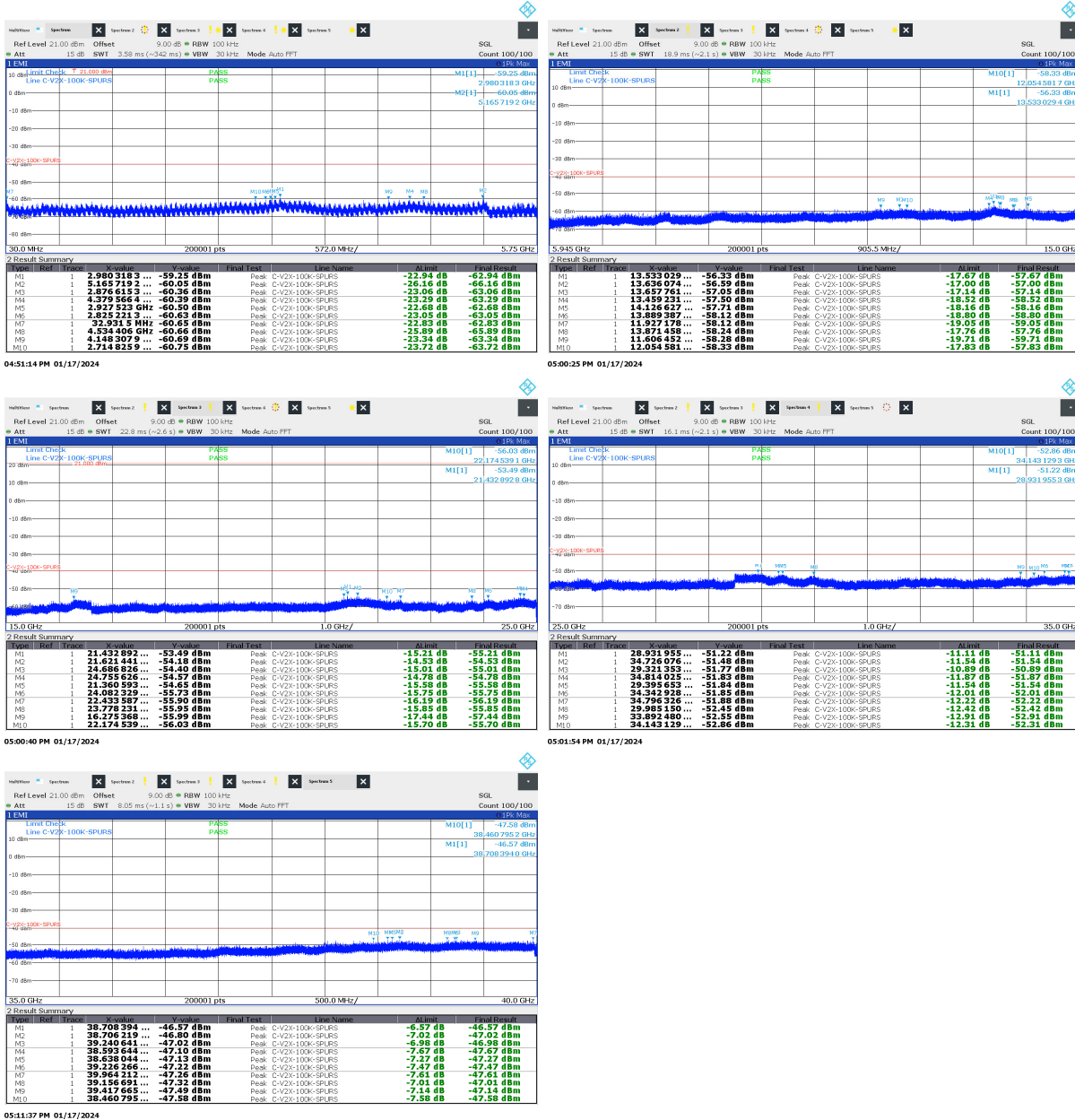

Figure 4.3.2 (iii) Worst Case Transmitter OOB Emissions Measured.

5 Measurement Uncertainty and Accreditation Documents

The maximum values of measurement uncertainty for the laboratory test equipment and facilities associated with each test are given in the table below. This uncertainty is computed for a 95.45% confidence level based on a coverage factor of $k = 2$.

Table 5.0.0 Measurement Uncertainty.

Measured Parameter	Measurement Uncertainty [†]
Radio Frequency	$\pm(f_{Mkr}/10^7 + RBW/10 + (SPN/(PTS - 1))/2 + 1 \text{ Hz})$
Conducted Emm. Amplitude	$\pm 1.9 \text{ dB}$
Radiated Emm. Amplitude ($f < 30 \text{ MHz}$)	$\pm 3.1 \text{ dB}$
Radiated Emm. Amplitude (30 – 200 MHz)	$\pm 4.0 \text{ dB}$
Radiated Emm. Amplitude (200 – 1000 MHz)	$\pm 5.2 \text{ dB}$
Radiated Emm. Amplitude ($f > 1000 \text{ MHz}$)	$\pm 3.7 \text{ dB}$

[†]Ref: CISPR 16-4-2:2011+A1:2014

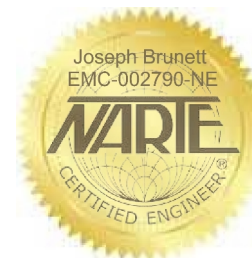

Figure 5.0.0 Accreditation Documents