



Test report No:
 NIE: 61457RRF.004A2

Test report

Reference Standard:
 USA FCC Part 27
 CANADA RSS-139

| | |
|---|--|
| (*) Identification of item tested | Data Logger |
| (*) Trademark | Danlaw |
| (*) Model and /or type reference | DL970 |
| Other identification of the product | HW Version: 2.0 SW Version: 1.4.0.0 FCC ID: 2AD9I-DL970 IC: 20087-DL970 |
| (*) Features | LTE, 3G, GPS, WLAN, Bluetooth (BLE) |
| Applicant | DANLAW INC 41211 Vincenti Court, Novi, Michigan 48375, USA |
| Test method requested, standard | USA FCC Part 27 (10-1-18 Edition). CANADA RSS-139 Issue 3, Jul. 2015. ANSI C63.26-2015. ANSI/TIA-603-E: 2016. KDB 971168 D01 Power Meas License Digital Systems v03r01, April. 2018. |
| Summary | IN COMPLIANCE |
| Approved by (name / position & signature) | Rafael López Martín EMC Consumer & RF Lab. Manager |
| Date of issue | 2020-01-22 |
| Report template No | FDT08_22 (*) "Data provided by the client" |

Index

| | |
|--|---|
| Competences and guarantees | 3 |
| General conditions | 3 |
| Uncertainty..... | 3 |
| Data provided by the client | 3 |
| Usage of samples | 4 |
| Test sample description..... | 5 |
| Identification of the client | 6 |
| Testing period and place | 6 |
| Document history..... | 6 |
| Environmental conditions | 6 |
| Remarks and comments..... | 7 |
| Testing verdicts..... | 8 |
| Summary | 8 |
| Appendix A: Test results for FCC PART 27 / RSS-139 | 9 |

Competences and guarantees

DEKRA Testing and Certification S.A.U. is a testing laboratory accredited by the National Accreditation Body (ENAC -Entidad Nacional de Acreditación), to perform the tests indicated in the Certificate No. 51/LE 147.

DEKRA Testing and Certification is a FCC-recognized accredited testing laboratory with appropriate scope of accreditation that include testing performed in this test report.

DEKRA Testing and Certification is an ISED-recognized accredited testing laboratory with appropriate scope of accreditation that include testing performed in this test report.

In order to assure the traceability to other national and international laboratories, DEKRA Testing and Certification S.A.U. has a calibration and maintenance program for its measurement equipment.

DEKRA Testing and Certification S.A.U. guarantees the reliability of the data presented in this report, which is the result of the measurements and the tests performed to the item under test on the date and under the conditions stated on the report and, it is based on the knowledge and technical facilities available at DEKRA Testing and Certification S.A.U. at the time of performance of the test.

DEKRA Testing and Certification S.A.U. is liable to the client for the maintenance of the confidentiality of all information related to the item under test and the results of the test.

The results presented in this Test Report apply only to the particular item under test established in this document. **IMPORTANT:** No parts of this report may be reproduced or quoted out of context, in any form or by any means, except in full, without the previous written permission of DEKRA Testing and Certification S.A.U.

General conditions

1. This report is only referred to the item that has undergone the test.
2. This report does not constitute or imply on its own an approval of the product by the Certification Bodies or competent Authorities.
3. This document is only valid if complete; no partial reproduction can be made without previous written permission of DEKRA Testing and Certification S.A.U.
4. This test report cannot be used partially or in full for publicity and/or promotional purposes without previous written permission of DEKRA Testing and Certification S.A.U. and the Accreditation Bodies.

Uncertainty

Uncertainty (factor $k=2$) was calculated according to the DEKRA Testing and Certification S.A.U. internal document PODT000.

Data provided by the client

The following data has been provided by the client:

1. Information relating to the description of the sample ("Identification of the item tested", "Trademark", "Model and/or type reference tested").
2. The sample of DL970 consists of a Data Logger developed to provide companies with an easy to install, wireless communication device for monitoring and logging vehicle network message data.

The Danlaw Data Logger provides:

- Support for all major passenger car & light truck protocols.
- Simple plug-n-go via the vehicle's OBDII connector.
- OBD Vehicle Data logging with real-time data stamp.
- LTE & 3G communication.
- Support for FTP, TCP/IP data transfer.
- Firmware Over-The-Air (FOTA) Re-flash.
- Rugged, compact field-hardened design.
- No external antenna connections needed.
- Completely self-contained.

DEKRA Testing and Certification S.A.U. declines any responsibility with respect to the information provided by the client and that may affect the validity of results.

Usage of samples

Samples undergoing test have been selected by: The client.

- Sample S/01 is composed of the following elements:

| Control N° | Description | Model | Serial N° | Date of reception |
|------------|-------------|-------|-----------|-------------------|
| 61457C/003 | Data Logger | DL970 | 5337 | 2019/07/23 |

Sample S/01 has undergone the following test(s): All radiated tests indicated in Appendix A.

- Sample S/02 is composed of the following elements:

| Control N° | Description | Model | Serial N° | Date of reception |
|------------|-------------|-------|-----------|-------------------|
| 61457C/001 | Data Logger | DL970 | -- | 2019/06/20 |

Sample S/02 has undergone the following test(s): All conducted tests indicated in Appendix A.

Test sample description

| | | | | | | | |
|---|---|--------------------------|-------------------------------------|--------------------------|-----------------------------------|--------------------------|--------------------------|
| Ports..... ..: | Port name and description | Cable | | | | | |
| | | Specified max length [m] | Attached during test | Shielded | Coupled to patient ⁽³⁾ | | |
| | USB connector; access virtual COM port | 1.70 | <input checked="" type="checkbox"/> | <input type="checkbox"/> | <input type="checkbox"/> | | |
| Supplementary information to the ports..... : | - | | | | | | |
| Rated power supply | Voltage and Frequency | | Reference poles | | | | |
| | | | L1 | L2 | L3 | N | PE |
| | <input type="checkbox"/> | AC: | <input type="checkbox"/> | <input type="checkbox"/> | <input type="checkbox"/> | <input type="checkbox"/> | <input type="checkbox"/> |
| <input checked="" type="checkbox"/> | DC: $V_{nom} = 12\text{ V}$; $V_{low} = 9\text{ V}$; $V_{high} = 15\text{ V}$ | | | | | | |
| Rated Power | - | | | | | | |
| Clock frequencies.....: | - | | | | | | |
| Other parameters | - | | | | | | |
| Software version | 1.4.0.0 | | | | | | |
| Hardware version | 2.0 | | | | | | |
| Dimensions in cm (W x H x D) | 4.75 x 4.4 x 2.3 | | | | | | |
| Mounting position | <input checked="" type="checkbox"/> | Other: Vehicle | | | | | |
| Modules/parts.....: | Module/parts of test item | | Type | Manufacturer | | | |
| | WLAN/BLT module | | QCA9377 | Qualcomm | | | |
| | 3G/LTE/GPS module | | MDM9207 | Qualcomm | | | |
| Accessories (not part of the test item) | Description | | Type | Manufacturer | | | |
| | - | | | | | | |
| Documents as provided by the applicant.....: | Description | | File name | Issue date | | | |
| | PICS | | | | | | |
| | User Manual | | | | | | |
| | Instruction for testing | | | | | | |

Identification of the client

DANLAW INC
 41211 Vincenti Court, Novi, Michigan 48375, USA

Testing period and place

| | |
|---------------|--|
| Test Location | DEKRA Testing and Certification S.A.U. |
| Date (start) | 2019-08-12 |
| Date (finish) | 2019-09-27 |

Document history

| Report number | Date | Description |
|----------------|------------|---|
| 61457RRF.004 | 2019-10-08 | First release |
| 61457RRF.004A1 | 2019-10-28 | Second release. RF Output Power measurements added on the modulation 16QAM. All results for the RSS-139 Issue 3 standard added. All the results of the LTE band 12 were removed and they were included on the 61457.RRF005 report. This modification test report cancels and replaces the test report 61457RRF.004 |
| 61457RRF.004A2 | 2020-01-22 | Third release. Correction on measurement method on page 33. This modification test report cancels and replaces the test report 61457RRF.004A1 |

Environmental conditions

In the control chamber, the following limits were not exceeded during the test:

| | |
|-------------------|------------------------------|
| Temperature | Min. = 15 °C Max. = 35 °C |
| Relative humidity | Min. = 20 % Max. = 75 % |

In the semianechoic chamber, the following limits were not exceeded during the test.

| | |
|-------------------|-------------------------------------|
| Temperature | Min. = 15 °C Max. = 35 °C |
| Relative humidity | Min. = 20 % Max. = 75 % |
| Air pressure | Min. = 860 mbar Max. = 1060 mbar |

In the chamber for conducted measurements, the following limits were not exceeded during the test:

| | |
|-------------------|-------------------------------------|
| Temperature | Min. = 15 °C Max. = 35 °C |
| Relative humidity | Min. = 20 % Max. = 35 % |
| Air pressure | Min. = 860 mbar Max. = 1060 mbar |

Remarks and comments

The tests have been performed by the technical personnel: José Alberto Aranda, Miguel Ángel Torres, Verónica García, Ignacio Cabra, Jaime Barranquero, Jesús García, Cristina Calle, José Manuel Jiménez.

Used instrumentation:

Conducted Measurements

| | Last Calibration | Due Calibration |
|--|------------------|-----------------|
| 1. Chamber HERAEUS VMT 04/35 | 2018/06 | 2020/06 |
| 2. Wideband Radio Communication Tester ROHDE AND SCHWARZ CMW500 | 2019/05 | 2020/05 |
| 3. Signal Analyzer 20 Hz to 8 GHz ROHDE AND SCHWARZ FSQ8 | 2018/08 | 2020/08 |
| 4. DC Power Supply 40V/40A Rohde & Schwarz NGPE40 | 2018/02 | 2021/02 |
| 5. Signal and Spectrum Analyzer ROHDE AND SCHWARZ FSV40 | 2019/09 | 2021/09 |
| 6. EMI Test Receiver 7 GHz ROHDE AND SCHWARZ ESR7 | 2018/10 | 2020/10 |
| 7. Spectrum analyser Agilent PSA E4440A | 2017/10 | 2019/10 |

Radiated Measurements

| | Last Calibration | Due Calibration |
|--|------------------|-----------------|
| 1. Semianechoic Absorber Lined Chamber ETS LINDGREN FACT 3 200 STP | N.A. | N.A. |
| 2. Wideband Radio Communication Tester ROHDE AND SCHWARZ CMW500 | 2019/05 | 2020/05 |
| 3. EMI Test Receiver ROHDE AND SCHWARZ ESR7 | 2018/10 | 2020/10 |
| 4. Biconical/Log Antenna ETS LINDGREN 3142E | 2017/04 | 2020/04 |
| 5. Signal and Spectrum Analyzer ROHDE AND SCHWARZ FSW50 | 2018/02 | 2020/02 |
| 6. RF pre-amplifier 1-18 GHz Bonn Elektronik BLMA 0118-1M | 2019/04 | 2020/04 |
| 7. Broadband Horn antenna 1-18 GHz SCHWARZBECK MESS-ELEKTRONIK BBHA 9120 D | 2016/11 | 2019/11 |
| 8. DC Power Supply Keysight Technologies U8002A | --- | --- |
| 9. Digital multimeter FLUKE 179 | 2019/06 | 2020/06 |

Testing verdicts

| | |
|-----------------|-----|
| Not applicable: | N/A |
| Pass: | P |
| Fail: | F |
| Not measured: | N/M |

Summary

| FCC PART 27 / RSS-139 PARAGRAPH | | |
|--|---------|--------|
| Requirement – Test case | Verdict | Remark |
| Clause 27.50 / RSS-139 Clause 6.5: RF output power | P | |
| Clause 2.1047 / RSS-139 Clause 6.2: Modulation characteristics | P | |
| Clause 27.54 / RSS-139 Clause 6.4: Frequency stability | P | |
| Clause 2.1049: Occupied Bandwidth | P | |
| Clause 27.53 / RSS-139 Clause 6.6: Spurious emissions at antenna terminals | P | |
| Clause 27.53 / RSS-139 Clause 6.6: Radiated emissions | P | |
| <u>Supplementary information and remarks:</u> None. | | |

Appendix A: Test results for FCC PART 27 / RSS-139

INDEX

| | |
|---|----|
| TEST CONDITIONS | 11 |
| RF Output Power | 12 |
| Frequency Stability | 30 |
| Modulation Characteristics | 30 |
| Occupied Bandwidth | 37 |
| Spurious emissions at antenna terminals | 57 |
| Spurious emissions at antenna terminals at Block Edges..... | 74 |
| Radiated emissions | 91 |

TEST CONDITIONS

POWER SUPPLY (V):

Vn: 12 Vdc
 Vmin: 9 Vdc (*)
 Vmax: 15 Vdc (*)

Type of Power Supply: External power supply (car battery).

The subscripts 'n', 'min' and 'max' indicate voltage test conditions (nominal, minimum and maximum respectively), as declared by the applicant.

ANTENNA:

| MIDDLE Bands | | ANTENNA TYPE |
|--------------|----------|---|
| 3G Band IV | +2.5 dBi | Internal (embedded in the plastics of the device) |

| HIGH Bands | | ANTENNA TYPE |
|------------|----------|---|
| LTE Band 4 | +2.5 dBi | Internal (embedded in the plastics of the device) |

TEST FREQUENCIES:

WCDMA and HSUPA MODULATION:

Lowest Channel (1312): 1712.4 MHz
 Middle Channel (1762): 1732.5 MHz
 Highest Channel (1513): 1752.6 MHz

LTE Band 4. QPSK AND 16QAM MODULATION:

| | Channel (Frequency) | | | | | |
|---------|-----------------------|-----------------------|-----------------------|-----------------------|-----------------------|-----------------------|
| | BW = 1.4 MHz | BW = 3 MHz | BW = 5 MHz | BW = 10 MHz | BW = 15 MHz | BW = 20 MHz |
| Lowest | 19957 (1710.7 MHz) | 19965 (1711.5 MHz) | 19975 (1712.5 MHz) | 20000 (1715.0 MHz) | 20025 (1717.5 MHz) | 20050 (1720.0 MHz) |
| Middle | 20175 (1732.5 MHz) | 20175 (1732.5 MHz) | 20175 (1732.5 MHz) | 20175 (1732.5 MHz) | 20175 (1732.5 MHz) | 20175 (1732.5 MHz) |
| Highest | 20393 (1754.3 MHz) | 20385 (1753.5 MHz) | 20375 (1752.5 MHz) | 20350 (1750.0 MHz) | 20325 (1747.5 MHz) | 20300 (1745.0 MHz) |

Note: LTE Category 1 device, so for BW=10 MHz, 15 MHz and 20 MHz the 16QAM modulation does not support transmission in RB=All.

RF Output Power

SPECIFICATION:

FCC §27.50 (d) (4):

(4) Fixed, mobile, and portable (hand-held) stations operating in the 1710-1755 MHz band and mobile and portable stations operating in the 1695-1710 MHz and 1755-1780 MHz bands are limited to 1 watt EIRP. Fixed stations operating in the 1710-1755 MHz band are limited to a maximum antenna height of 10 meters above ground. Mobile and portable stations operating in these bands must employ a means for limiting power to the minimum necessary for successful communications.

RSS-139 Clause 6.5:

The equivalent isotropically radiated power (e.i.r.p.) for mobile and portable transmitters shall not exceed one watt. The e.i.r.p. for fixed and base stations in the band 1710-1780 MHz shall not exceed one watt.

Consult SRSP-513 for e.i.r.p. limits on fixed and base stations operating in the band 2110-2180 MHz.

In addition, the peak to average power ratio (PAPR) of the equipment shall not exceed 13 dB for more than 0.1% of the time, using a signal that corresponds to the highest PAPR during periods of continuous transmission.

METHOD:

The conducted RF output power measurements were made at the RF output terminals of the EUT using the power meter of the Universal Radio Communication tester R&S CMW500, selecting maximum transmission power of the EUT and different modes of modulation.

The maximum equivalent isotropically radiated power (e.i.r.p.) is calculated by adding the declared maximum antenna gain (dBi).

The maximum effective radiated power e.r.p. is calculated from the maximum equivalent isotropically radiated power (e.i.r.p.) by subtracting 2.15 dB:

$$E.R.P. = E.I.R.P. - 2.15 \text{ dB}$$

TEST SETUP:

1. CONDUCTED AVERAGE POWER:

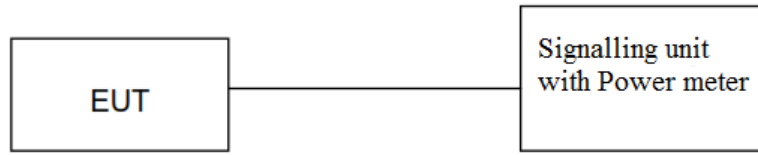

2. PEAK-TO-AVERAGE POWER RATIO (PAPR) and Conducted Average power:

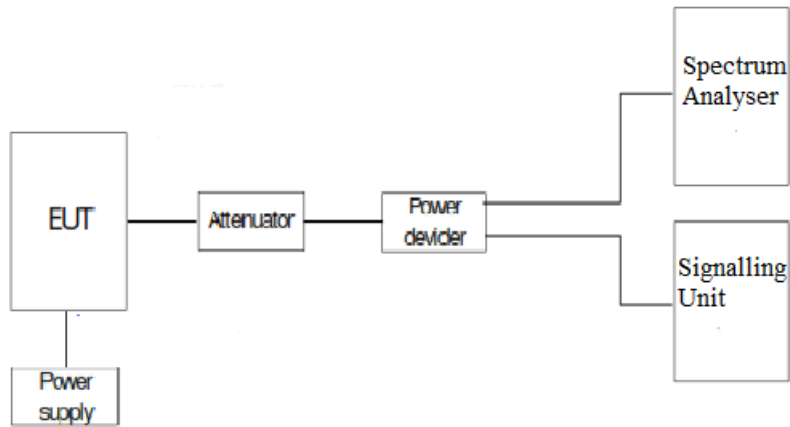

RESULTS:

1. AVERAGE POWER:

3G Band IV:

WCDMA MODULATION:

| Channel | Lowest | Middle | Highest |
|---|--------|--------|---------|
| Maximum declared antenna gain (dBi) | 2.5 | 2.5 | 2.5 |
| Measured maximum average power (dBm) at antenna port | 22.14 | 22.14 | 22.17 |
| Maximum effective isotropically radiated average power E.I.R.P. (dBm) | 24.64 | 24.64 | 24.67 |
| PAPR (dB) | 3.29 | 2.97 | 3.15 |
| Measurement uncertainty (dB) | <±0.66 | | |

HSUPA MODULATION:

| Channel | Lowest | Middle | Highest |
|---|--------|--------|---------|
| Maximum declared antenna gain (dBi) | 2.5 | 2.5 | 2.5 |
| Measured maximum average power (dBm) at antenna port | 20.49 | 20.64 | 20.58 |
| Maximum effective isotropically radiated average power E.I.R.P. (dBm) | 22.99 | 23.14 | 23.08 |
| PAPR (dB) | 3.50 | 3.10 | 3.26 |
| Measurement uncertainty (dB) | <±0.66 | | |

LTE Band 4:

LTE Band 4. QPSK MODULATION. Bandwidth = 1.4 MHz.

| Channel | Lowest | Middle | Highest |
|--|--------|--------|---------|
| Maximum declared antenna gain (dBi) | 2.50 | 2.50 | 2.50 |
| Measured maximum average power (dBm) at antenna port | 22.06 | 23.80 | 22.57 |
| Maximum equivalent isotropically radiated power (E.I.R.P.) (dBm) | 24.56 | 26.30 | 25.07 |
| PAPR (dB) | (*) | (*) | (*) |
| Measurement uncertainty (dB) | <±0.66 | | |

Worst case AVERAGE POWER: Modulation QPSK. RB Size: 1. RB Offset: 0.

(*): Preliminary measurements determined PAPR of 16QAM as the worst case.

LTE Band 4. 16QAM MODULATION. Bandwidth = 1.4 MHz.

| Channel | Lowest | Middle | Highest |
|--|--------|--------|---------|
| Maximum declared antenna gain (dBi) | 2.50 | 2.50 | 2.50 |
| Measured maximum average power (dBm) at antenna port | 21.81 | 22.97 | 22.46 |
| Maximum equivalent isotropically radiated power (E.I.R.P.) (dBm) | 24.31 | 25.47 | 24.96 |
| PAPR (dB) | 5.99 | 5.82 | 5.77 |
| Measurement uncertainty (dB) | <±0.66 | | |

Worst case AVERAGE POWER: Modulation 16QAM. RB Size: 1. RB Offset: 2.
 Worst case PAPR: Modulation 16QAM. RB Size: 6. RB Offset: 0.

LTE Band 4. QPSK MODULATION. Bandwidth = 3 MHz.

| Channel | Lowest | Middle | Highest |
|--|--------|--------|---------|
| Maximum declared antenna gain (dBi) | 2.50 | 2.50 | 2.50 |
| Measured maximum average power (dBm) at antenna port | 22.30 | 23.78 | 22.70 |
| Maximum equivalent isotropically radiated power (E.I.R.P.) (dBm) | 24.80 | 26.28 | 25.20 |
| PAPR (dB) | (*) | (*) | (*) |
| Measurement uncertainty (dB) | <±0.66 | | |

Worst case AVERAGE POWER: Modulation QPSK. RB Size: 1. RB Offset: 7.

(*): Preliminary measurements determined PAPR of 16QAM as the worst case.

LTE Band 4. 16QAM MODULATION. Bandwidth = 3 MHz.

| Channel | Lowest | Middle | Highest |
|--|--------|--------|---------|
| Maximum declared antenna gain (dBi) | 2.50 | 2.50 | 2.50 |
| Measured maximum average power (dBm) at antenna port | 22.12 | 22.32 | 22.68 |
| Maximum equivalent isotropically radiated power (E.I.R.P.) (dBm) | 24.62 | 24.82 | 25.18 |
| PAPR (dB) | 5.99 | 5.93 | 5.88 |
| Measurement uncertainty (dB) | <±0.66 | | |

Worst case AVERAGE POWER: Modulation 16QAM. RB Size: 1. RB Offset: 7.
 Worst case PAPR: Modulation 16QAM. RB Size: 15. RB Offset: 0.

LTE Band 4. QPSK MODULATION. Bandwidth = 5 MHz.

| Channel | Lowest | Middle | Highest |
|--|--------|--------|---------|
| Maximum declared antenna gain (dBi) | 2.50 | 2.50 | 2.50 |
| Measured maximum average power (dBm) at antenna port | 22.21 | 23.58 | 22.66 |
| Maximum equivalent isotropically radiated power (E.I.R.P.) (dBm) | 24.71 | 26.08 | 25.16 |
| PAPR (dB) | (*) | (*) | (*) |
| Measurement uncertainty (dB) | <±0.66 | | |

Worst case AVERAGE POWER: Modulation QPSK. RB Size: 1. RB Offset: 24.

(*): Preliminary measurements determined PAPR of 16QAM as the worst case.

LTE Band 4. 16QAM MODULATION. Bandwidth = 5 MHz.

| Channel | Lowest | Middle | Highest |
|--|--------|--------|---------|
| Maximum declared antenna gain (dBi) | 2.50 | 2.50 | 2.50 |
| Measured maximum average power (dBm) at antenna port | 21.82 | 22.15 | 22.03 |
| Maximum equivalent isotropically radiated power (E.I.R.P.) (dBm) | 24.32 | 24.65 | 24.53 |
| PAPR (dB) | 5.99 | 5.82 | 5.8 |
| Measurement uncertainty (dB) | <±0.66 | | |

Worst case AVERAGE POWER: Modulation 16QAM. RB Size: 1. RB Offset: 12.

Worst case PAPR: Modulation 16QAM. RB Size: 25. RB Offset: 0.

LTE Band 4. QPSK MODULATION. Bandwidth = 10 MHz.

| Channel | Lowest | Middle | Highest |
|--|--------|--------|---------|
| Maximum declared antenna gain (dBi) | 2.50 | 2.50 | 2.50 |
| Measured maximum average power (dBm) at antenna port | 22.55 | 23.73 | 22.69 |
| Maximum equivalent isotropically radiated power (E.I.R.P.) (dBm) | 25.05 | 26.23 | 25.19 |
| PAPR (dB) | 5.08 | 5.00 | 5.02 |
| Measurement uncertainty (dB) | <±0.66 | | |

Worst case AVERAGE POWER: Modulation QPSK. RB Size: 1. RB Offset: 49.

Worst case PAPR: Modulation QPSK. RB Size: 50. RB Offset: 0.

(*): Not supported the modulation 16QAM.

LTE Band 4. QPSK MODULATION. Bandwidth = 15 MHz.

| Channel | Lowest | Middle | Highest |
|--|--------|--------|---------|
| Maximum declared antenna gain (dBi) | 2.50 | 2.50 | 2.50 |
| Measured maximum average power (dBm) at antenna port | 22.23 | 23.64 | 22.69 |
| Maximum equivalent isotropically radiated power (E.I.R.P.) (dBm) | 24.73 | 26.14 | 25.19 |
| PAPR (dB) | 5.13 | 5.05 | 5.00 |
| Measurement uncertainty (dB) | <±0.66 | | |

Worst case AVERAGE POWER: Modulation QPSK. RB Size: 1. RB Offset: 74.
 Worst case PAPR: Modulation QPSK. RB Size: 75. RB Offset: 0.

(*): Not supported the modulation 16QAM.

LTE Band 4. QPSK MODULATION. Bandwidth = 20 MHz.

| Channel | Lowest | Middle | Highest |
|--|--------|--------|---------|
| Maximum declared antenna gain (dBi) | 2.50 | 2.50 | 2.50 |
| Measured maximum average power (dBm) at antenna port | 22.19 | 23.36 | 22.45 |
| Maximum equivalent isotropically radiated power (E.I.R.P.) (dBm) | 24.69 | 25.86 | 24.95 |
| PAPR (dB) | 4.92 | 4.97 | 4.95 |
| Measurement uncertainty (dB) | <±0.66 | | |

Worst case AVERAGE POWER: Modulation QPSK. RB Size: 1. RB Offset: 0.
 Worst case PAPR: Modulation QPSK. RB Size: 100. RB Offset: 0.

(*): Not supported the modulation 16QAM.

Verdict: PASS

2. PEAK-TO-AVERAGE POWER RATIO (PAPR):

3G Band IV. WCDMA MODULATION.

Lowest Channel:

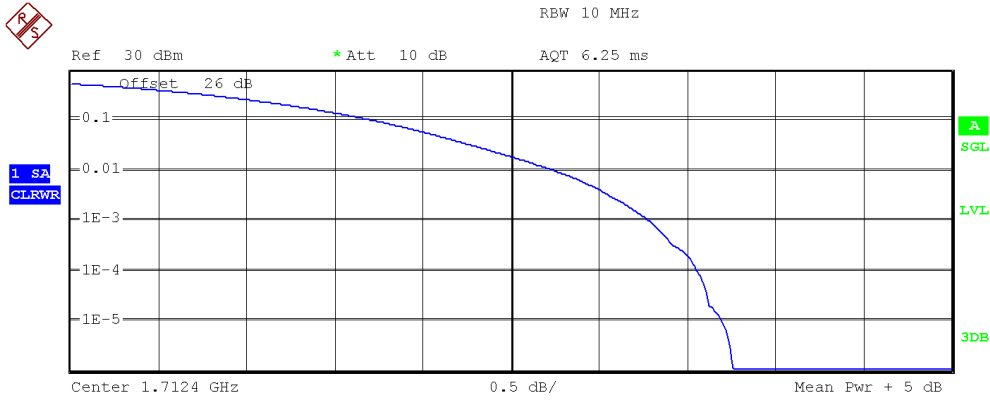

Complementary Cumulative Distribution Function
 NOF samples: 100000, Usable BW: 11.2MHz

| Trace 1 | |
|---------|-----------|
| Mean | 22.18 dBm |
| Peak | 25.94 dBm |
| Crest | 3.76 dB |
| 10 % | 1.71 dB |
| 1 % | 2.74 dB |
| .1 % | 3.29 dB |
| .01 % | 3.56 dB |

Middle Channel:

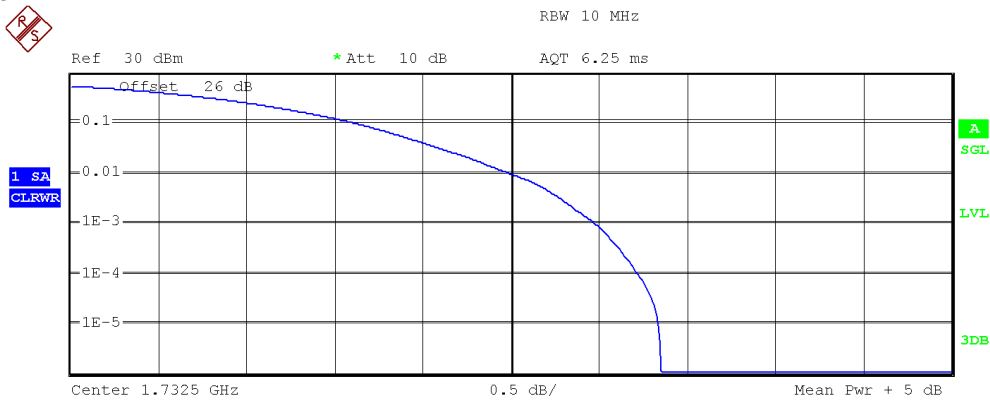

Complementary Cumulative Distribution Function
 NOF samples: 100000, Usable BW: 11.2MHz

| Trace 1 | |
|---------|-----------|
| Mean | 22.34 dBm |
| Peak | 25.69 dBm |
| Crest | 3.35 dB |
| 10 % | 1.61 dB |
| 1 % | 2.49 dB |
| .1 % | 2.97 dB |
| .01 % | 3.22 dB |

Highest Channel:

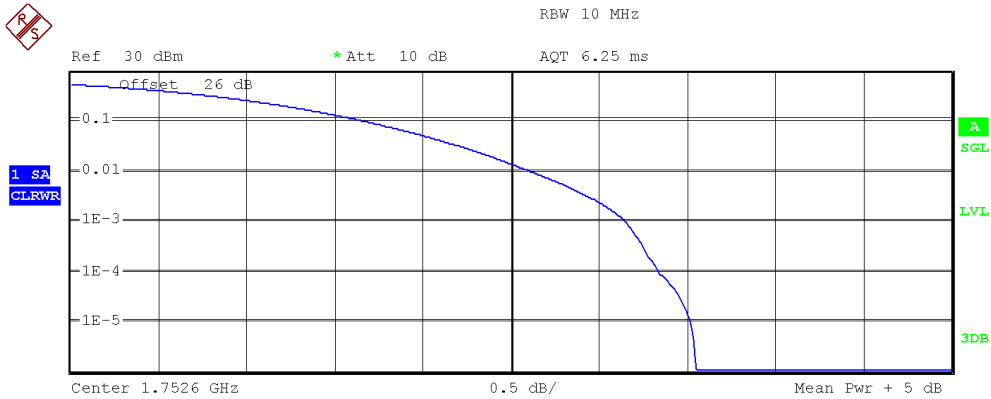

Complementary Cumulative Distribution Function
 NOF samples: 100000, Usable BW: 11.2MHz

| Trace 1 | |
|---------|-----------|
| Mean | 22.36 dBm |
| Peak | 25.91 dBm |
| Crest | 3.55 dB |
| 10 % | 1.67 dB |
| 1 % | 2.61 dB |
| .1 % | 3.15 dB |
| .01 % | 3.34 dB |

3G Band IV. HSUPA MODULATION.

Lowest Channel:

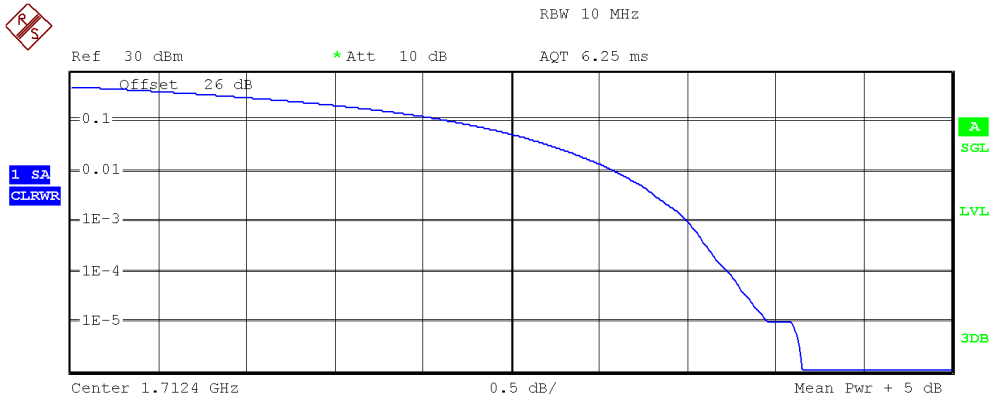

Complementary Cumulative Distribution Function
 NOF samples: 100000, Usable BW: 11.2MHz

| Trace 1 | |
|---------|-----------|
| Mean | 20.87 dBm |
| Peak | 25.03 dBm |
| Crest | 4.16 dB |
| 10 % | 2.16 dB |
| 1 % | 3.09 dB |
| .1 % | 3.50 dB |
| .01 % | 3.73 dB |

Middle Channel:

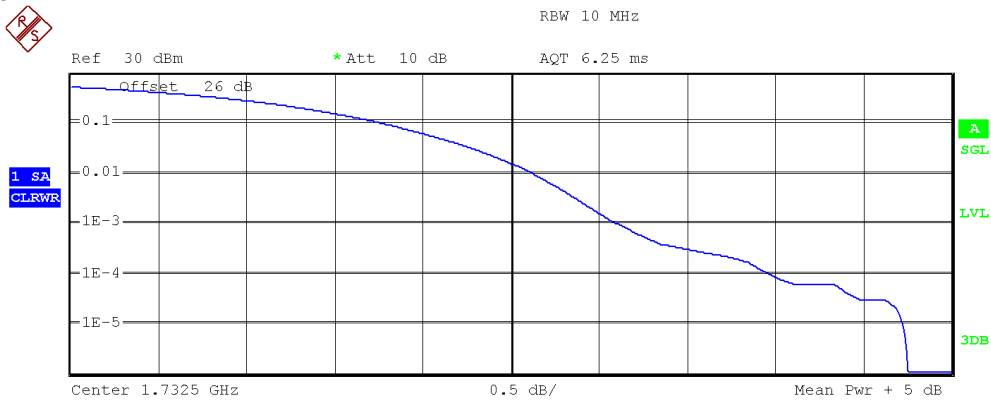

Complementary Cumulative Distribution Function
 NOF samples: 100000, Usable BW: 11.2MHz

| Trace 1 | |
|---------|-----------|
| Mean | 21.36 dBm |
| Peak | 26.11 dBm |
| Crest | 4.75 dB |
| 10 % | 1.77 dB |
| 1 % | 2.62 dB |
| .1 % | 3.10 dB |
| .01 % | 3.96 dB |

Highest Channel:

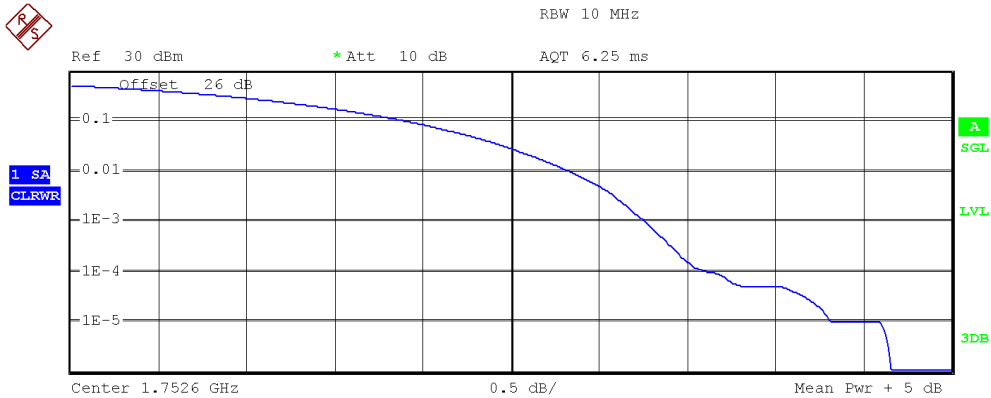

Complementary Cumulative Distribution Function
 NOF samples: 100000, Usable BW: 11.2MHz

| Trace 1 | |
|---------|-----------|
| Mean | 21.32 dBm |
| Peak | 25.98 dBm |
| Crest | 4.66 dB |
| 10 % | 1.91 dB |
| 1 % | 2.83 dB |
| .1 % | 3.26 dB |
| .01 % | 3.61 dB |

LTE Band 4.

Bandwidth = 1.4 MHz. Modulation 16 QAM. RB Size: 6. RB Offset: 0.

Lowest Channel:

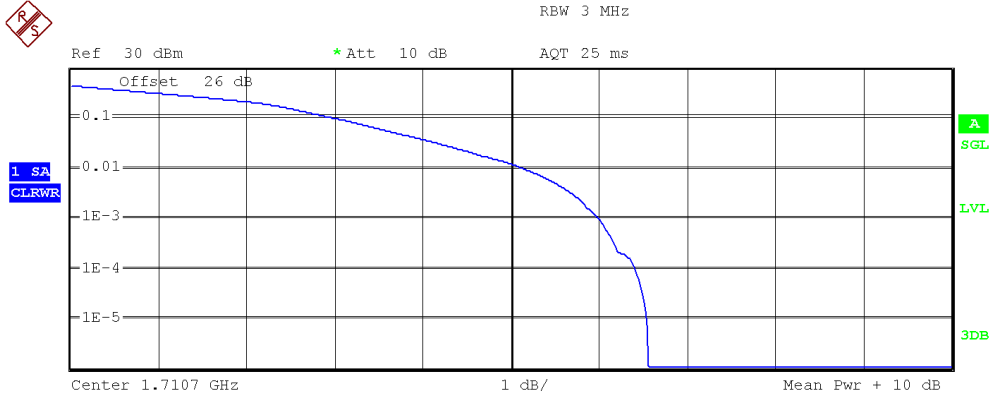

Center 1.7107 GHz 1 dB/ Mean Pwr + 10 dB
 Complementary Cumulative Distribution Function
 NOF samples: 100000, Usable BW: 3.5MHz

| Trace 1 | |
|---------|-----------|
| Mean | 20.76 dBm |
| Peak | 27.32 dBm |
| Crest | 6.56 dB |
| 10 % | 3.00 dB |
| 1 % | 5.13 dB |
| .1 % | 5.99 dB |
| .01 % | 6.41 dB |

Middle Channel:

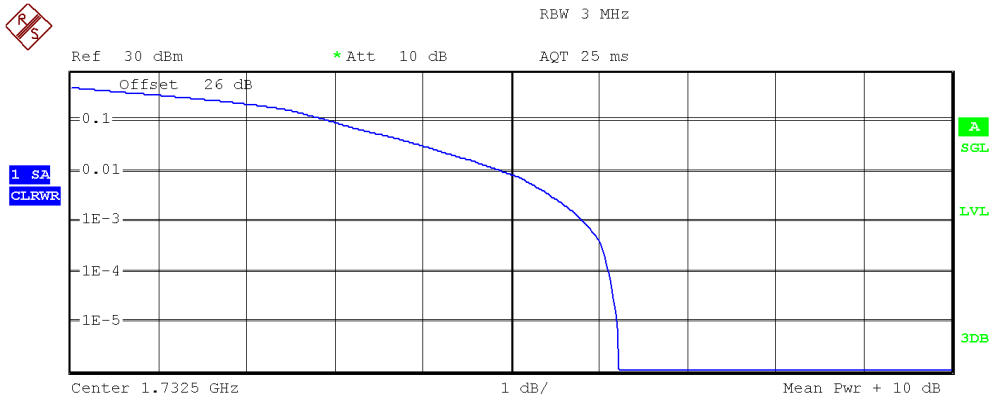

Center 1.7325 GHz 1 dB/ Mean Pwr + 10 dB
 Complementary Cumulative Distribution Function
 NOF samples: 100000, Usable BW: 3.5MHz

| Trace 1 | |
|---------|-----------|
| Mean | 20.46 dBm |
| Peak | 26.69 dBm |
| Crest | 6.22 dB |
| 10 % | 2.96 dB |
| 1 % | 4.90 dB |
| .1 % | 5.82 dB |
| .01 % | 6.12 dB |

Highest Channel:

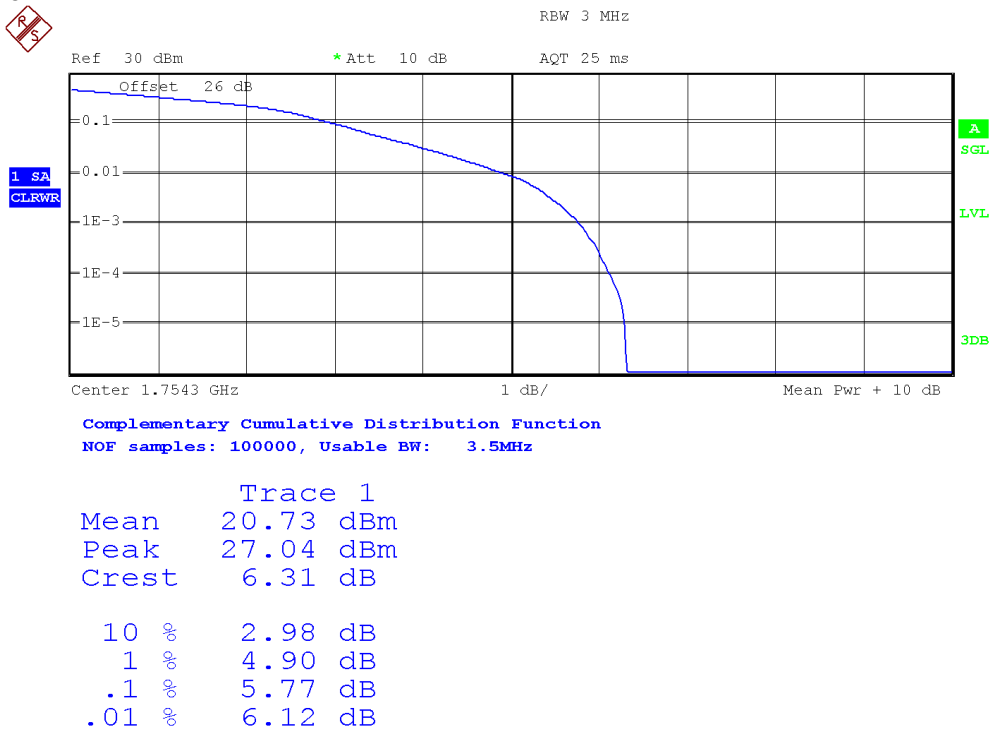

LTE Band 4.

Bandwidth = 3 MHz. Modulation 16 QAM. RB Size: 15. RB Offset: 0.

Lowest Channel:

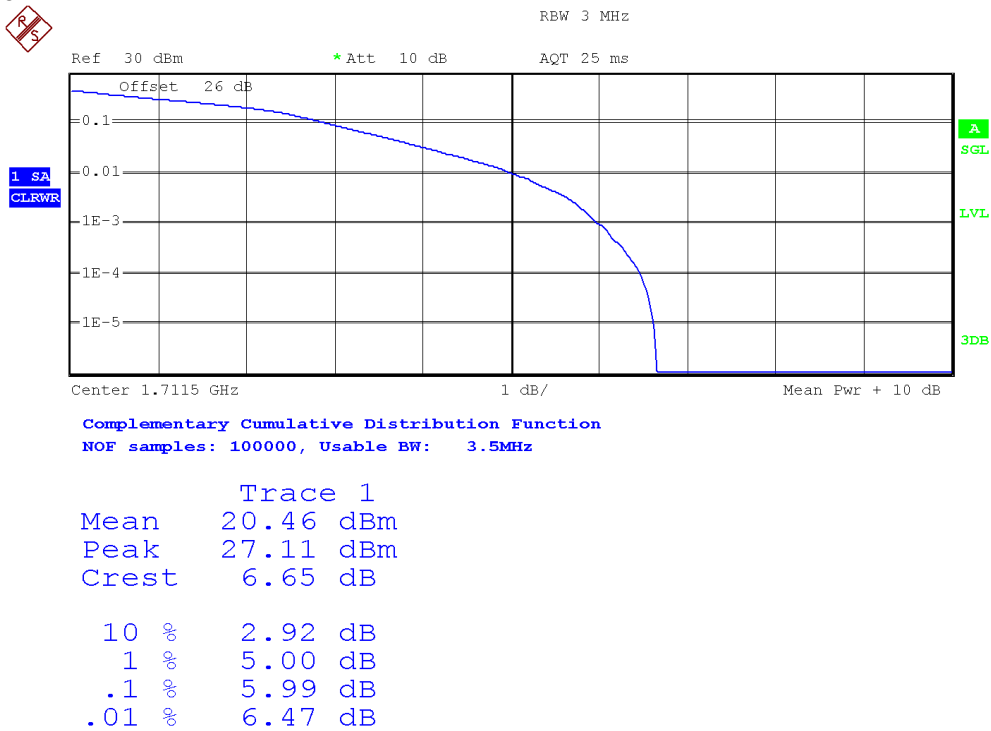

Middle Channel:

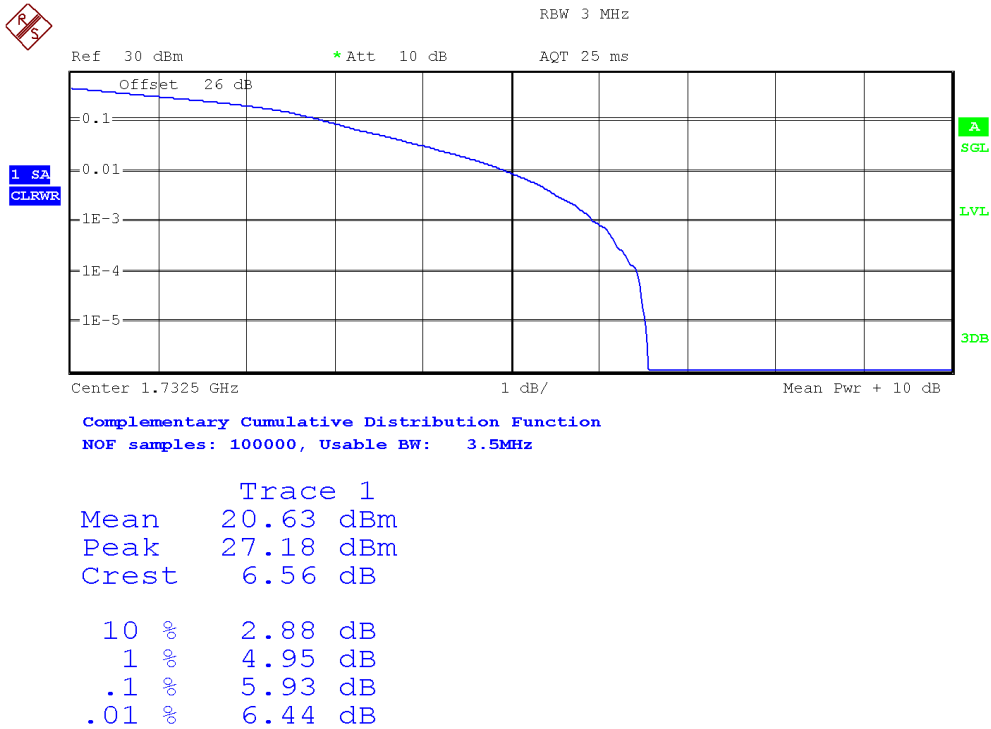

Highest Channel:

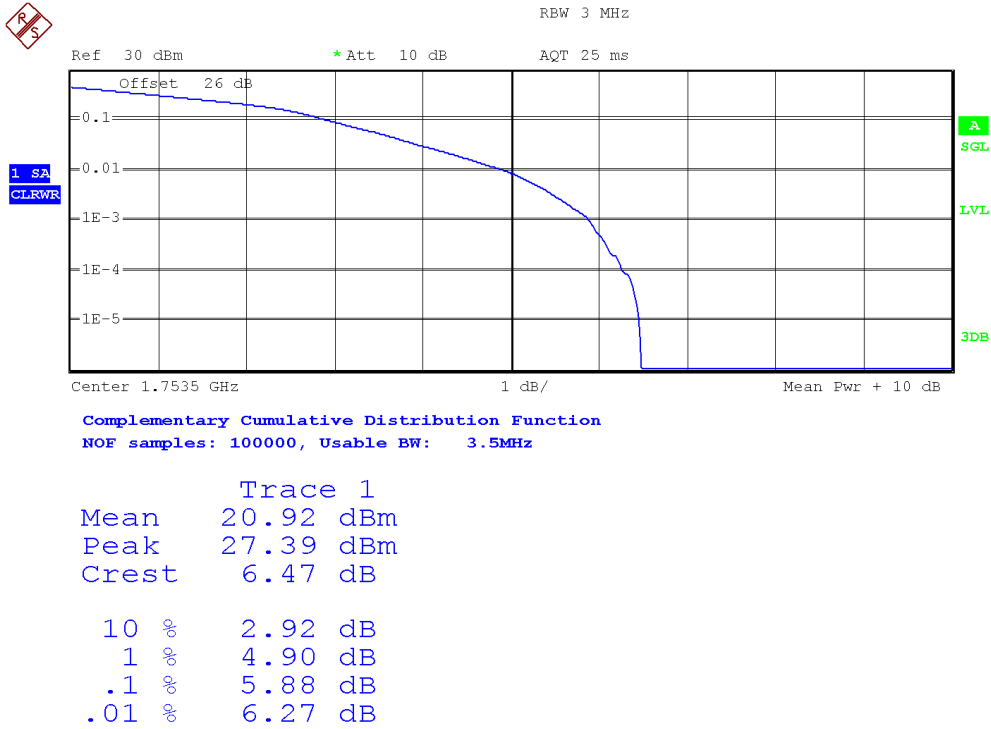

LTE Band 4.

Bandwidth = 5 MHz. Modulation 16 QAM. RB Size: 25. RB Offset: 0.

Lowest Channel:

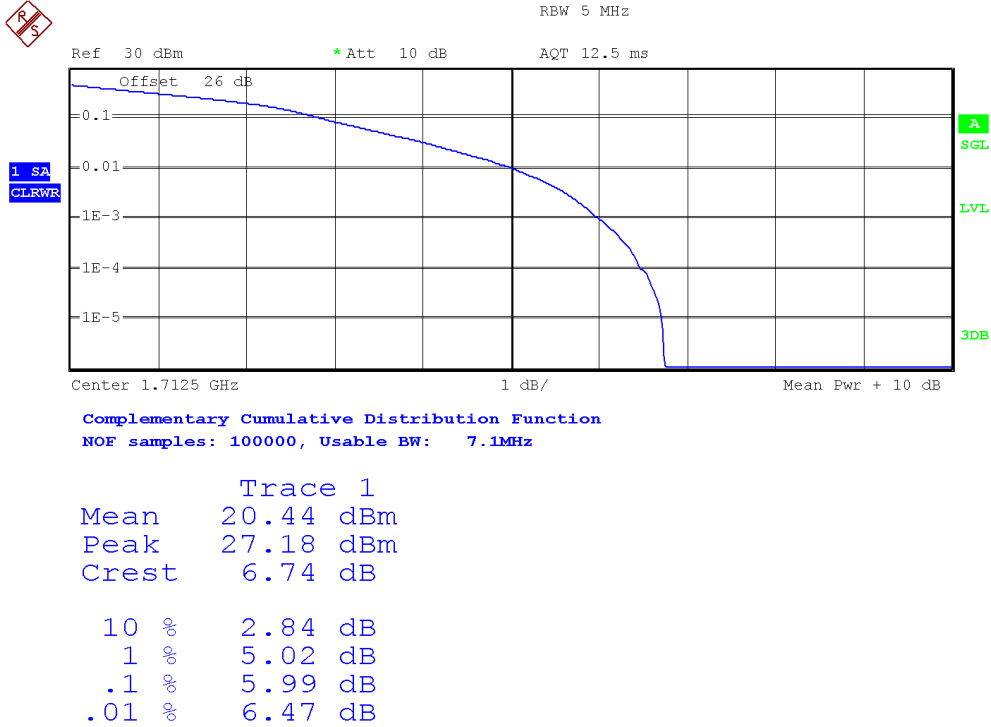

Middle Channel:

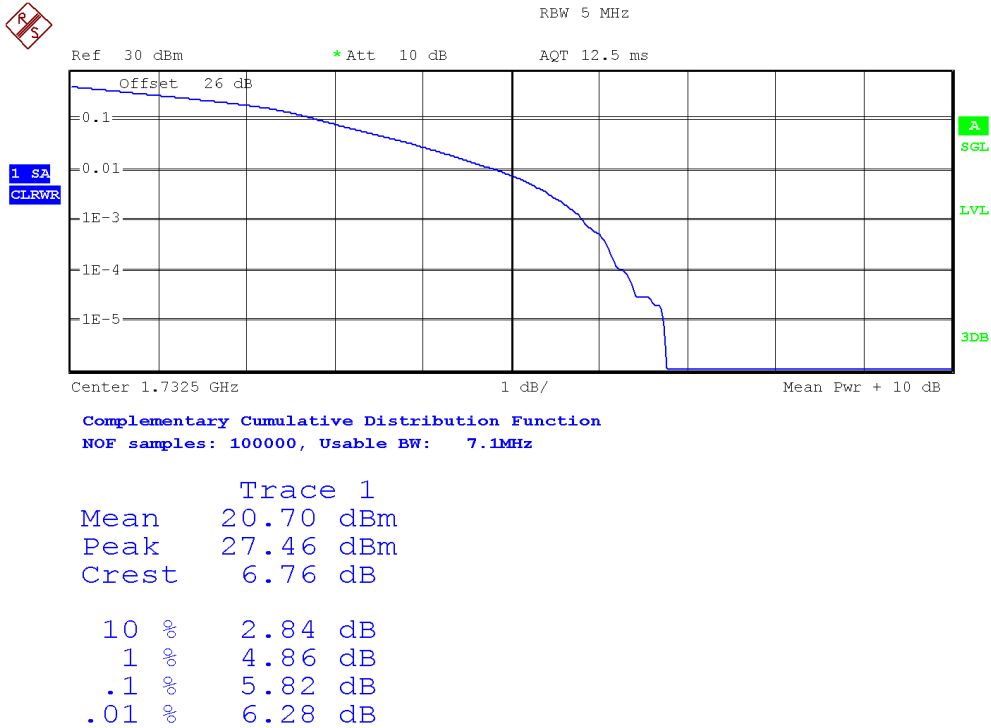

Highest Channel:

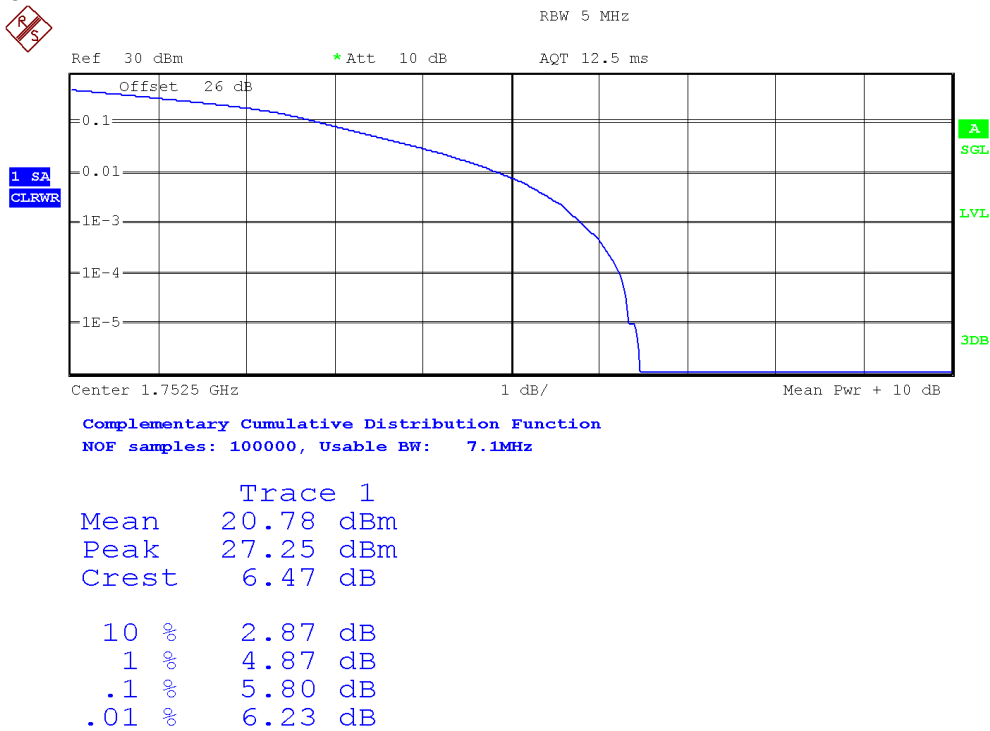

LTE Band 4.

Bandwidth = 10 MHz. Modulation QPSK. RB Size: 50. RB Offset: 0.

Lowest Channel:

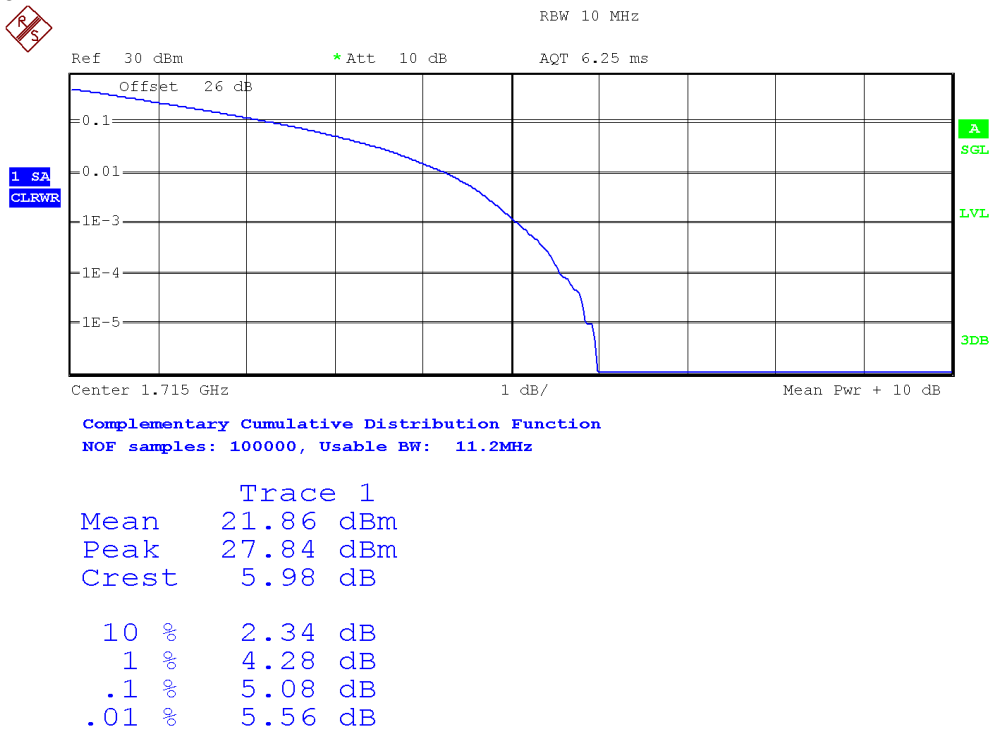

Middle Channel:

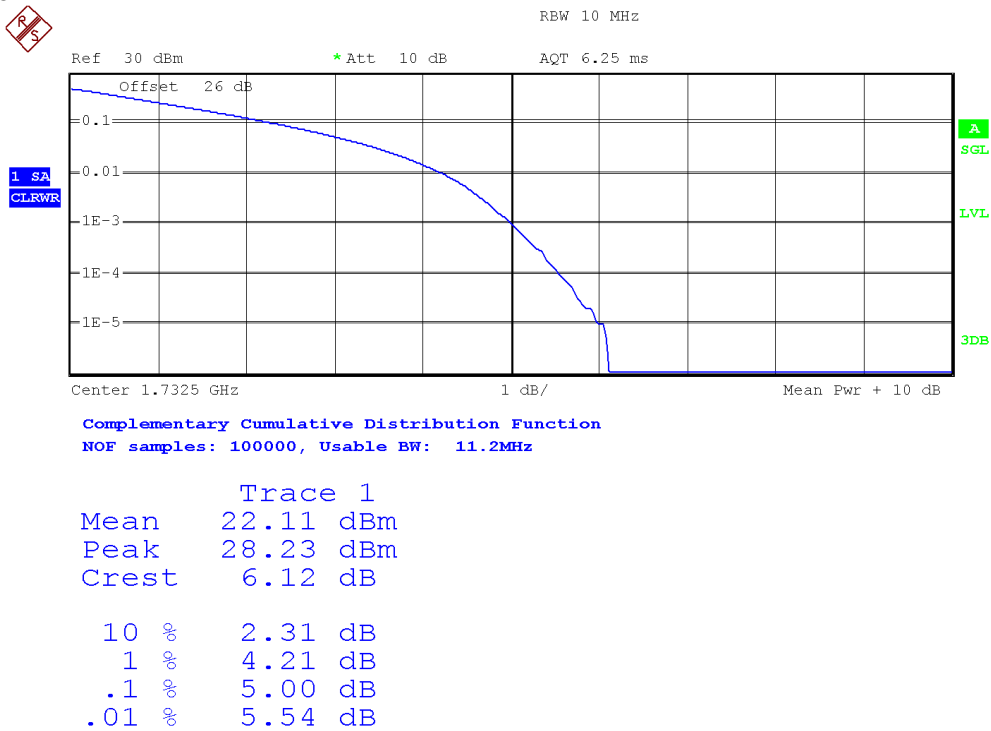

Highest Channel:

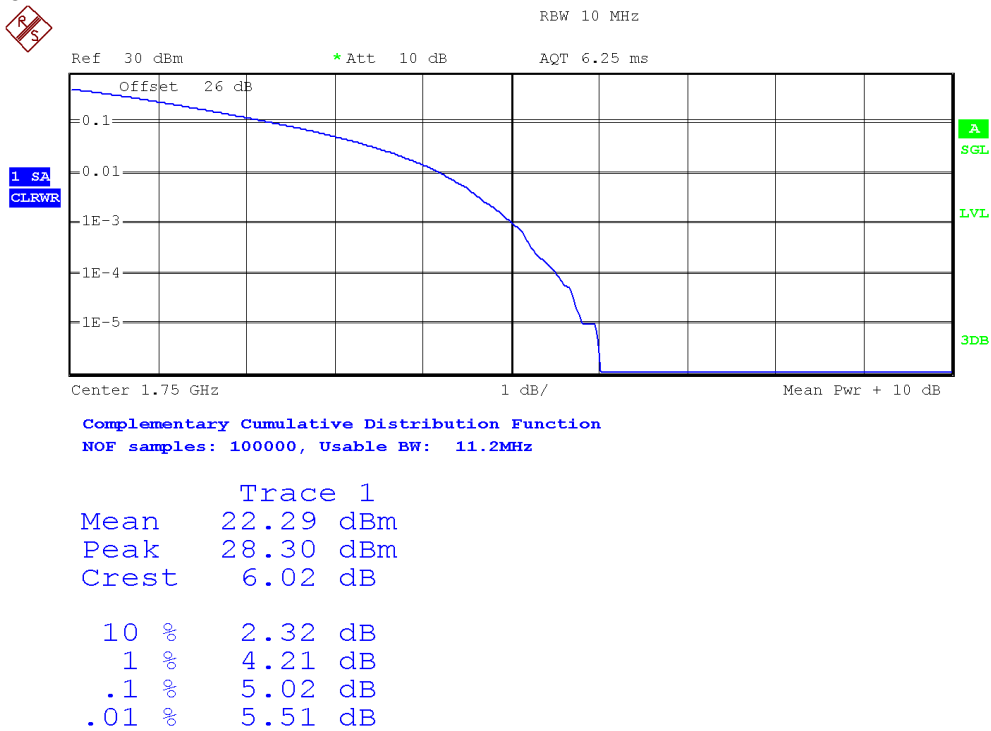

LTE Band 4.

Bandwidth = 15 MHz. Modulation QPSK. RB Size: 75. RB Offset: 0.

Lowest Channel:

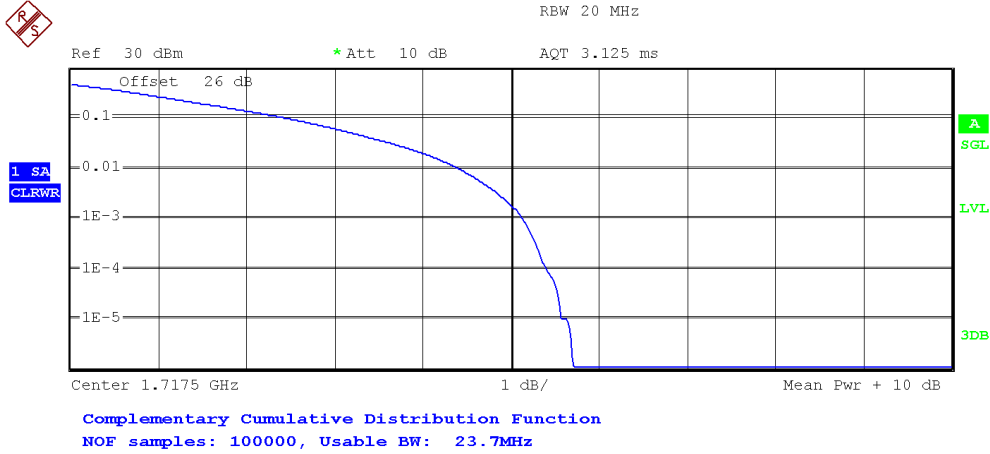

| | |
|-------|-----------|
| | Trace 1 |
| Mean | 22.07 dBm |
| Peak | 27.78 dBm |
| Crest | 5.71 dB |
| 10 % | 2.45 dB |
| 1 % | 4.39 dB |
| .1 % | 5.13 dB |
| .01 % | 5.40 dB |

Middle Channel:

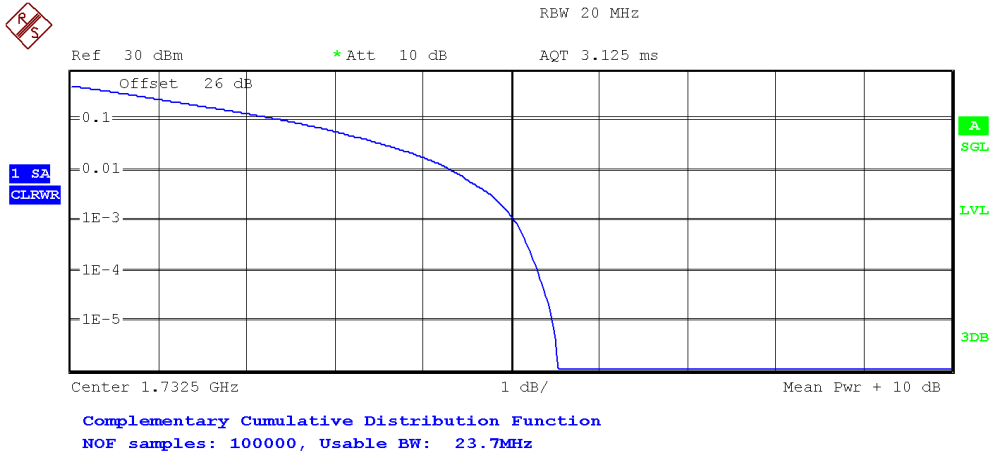

| | |
|-------|-----------|
| | Trace 1 |
| Mean | 22.14 dBm |
| Peak | 27.67 dBm |
| Crest | 5.53 dB |
| 10 % | 2.42 dB |
| 1 % | 4.33 dB |
| .1 % | 5.05 dB |
| .01 % | 5.30 dB |

Highest Channel:

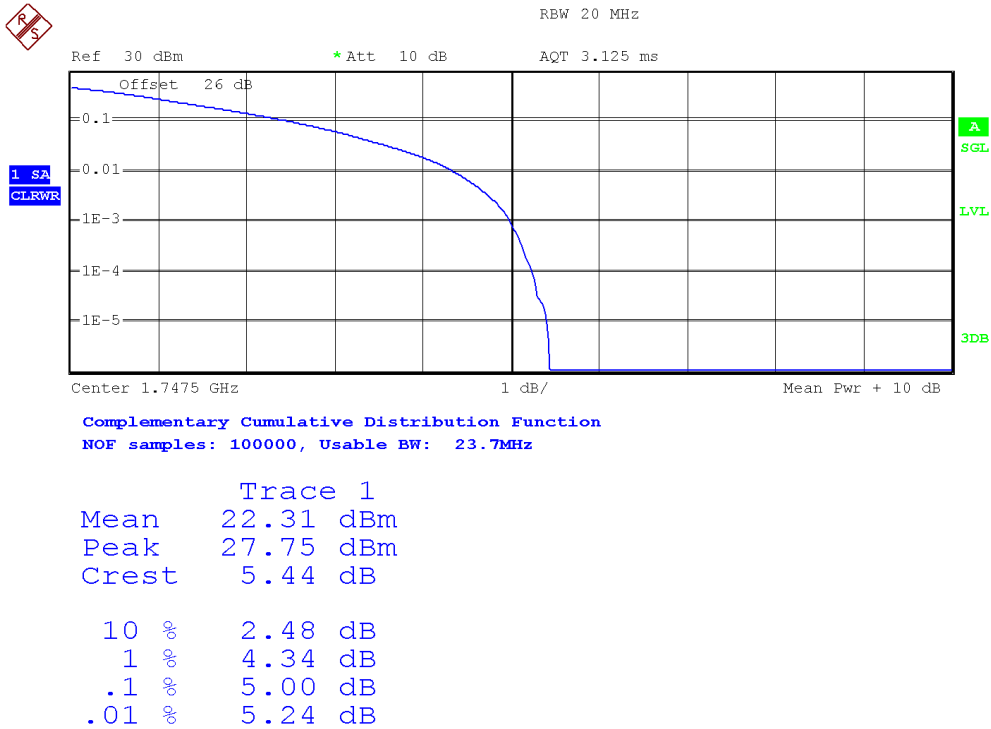

LTE Band 4.

Bandwidth = 20 MHz. Modulation QPSK. RB Size: 100. RB Offset: 0.

Lowest Channel:

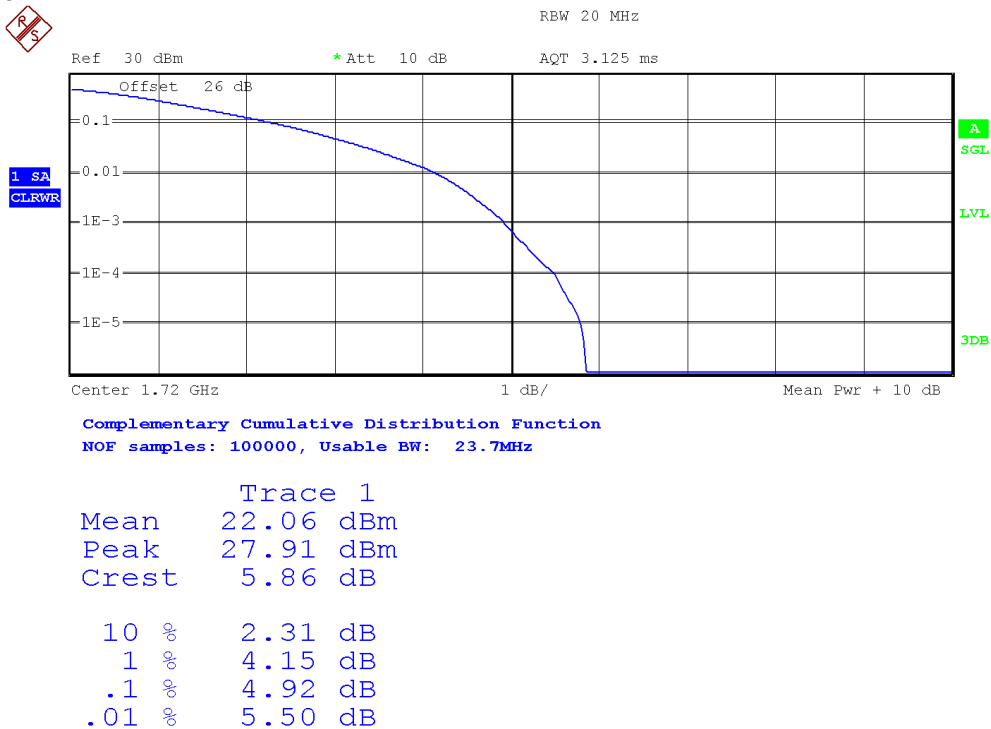

Middle Channel:

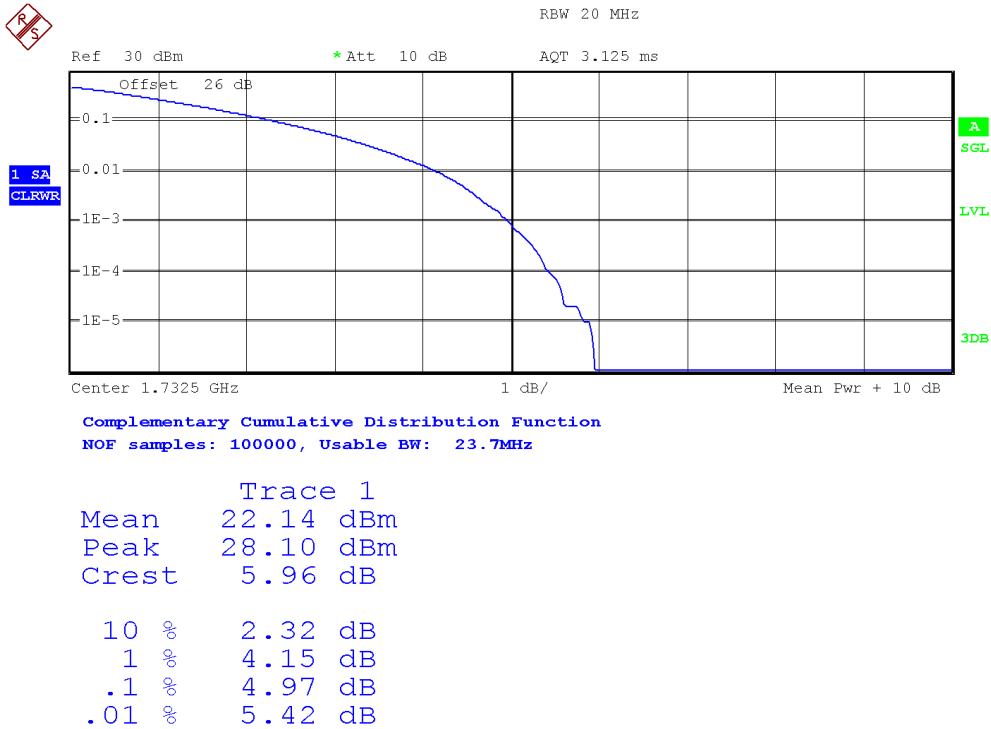

Highest Channel:

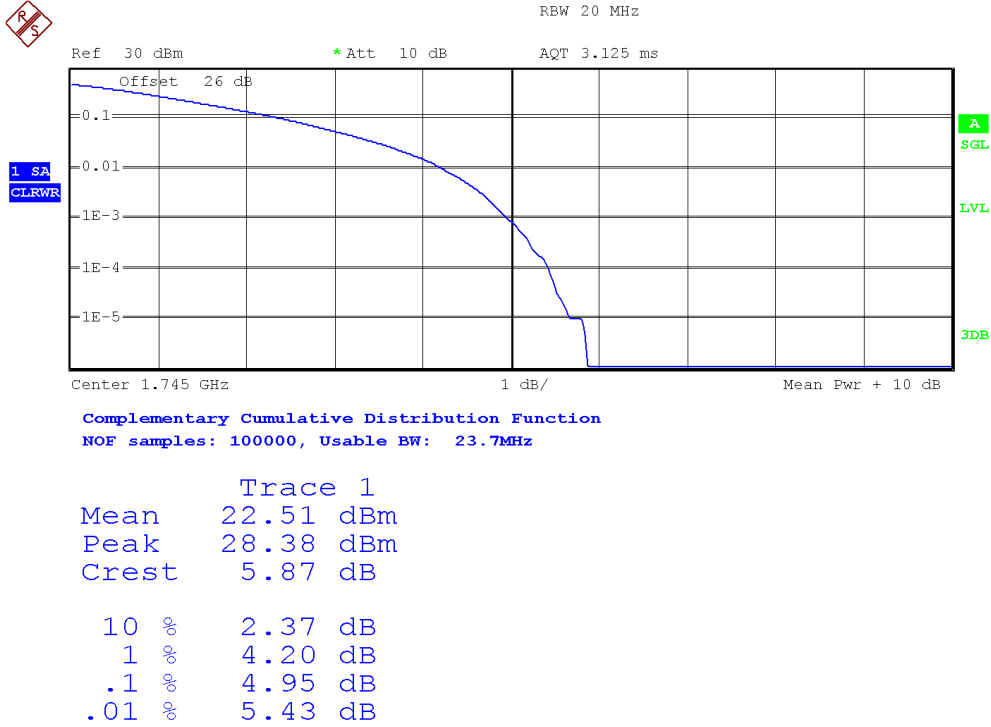

Verdict: PASS

Modulation Characteristics

SPECIFICATION:

FCC §2.1047: Measurements required: Modulation characteristics.

RSS-139 Clause 6.2:

The devices may employ any type of modulation techniques. The type of modulation used must be reported.

METHOD:

For 3G, the EUT operates with WCDMA (QPSK) and HSUPA (QPSK) modes, in which the information is digitized and coded into a bit stream.

For LTE the EUT operates with QPSK and 16QAM modulation modes in which the information is digitised and coded into a bit stream. The RF transmission is multiplexed using *Orthogonal Frequency Division Multiplexing (OFDM)* using different possible arrangement of subcarriers (Resource Blocks RB).

TEST SETUP:

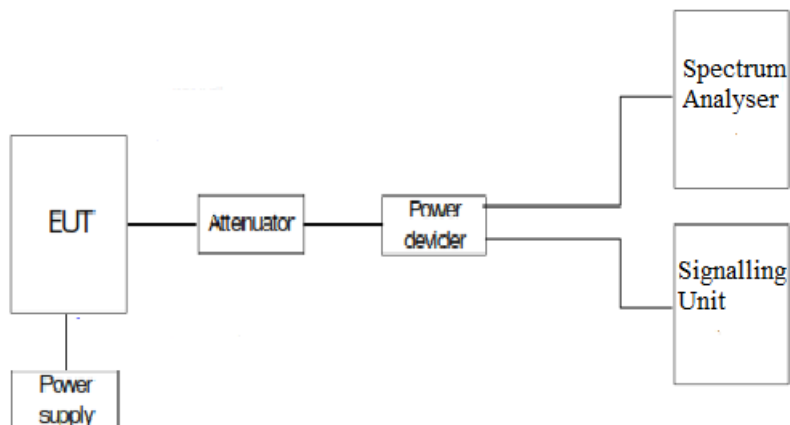

RESULTS:

The following plots show the modulation schemes in the EUT.

3G Band IV. WCDMA MODULATION.

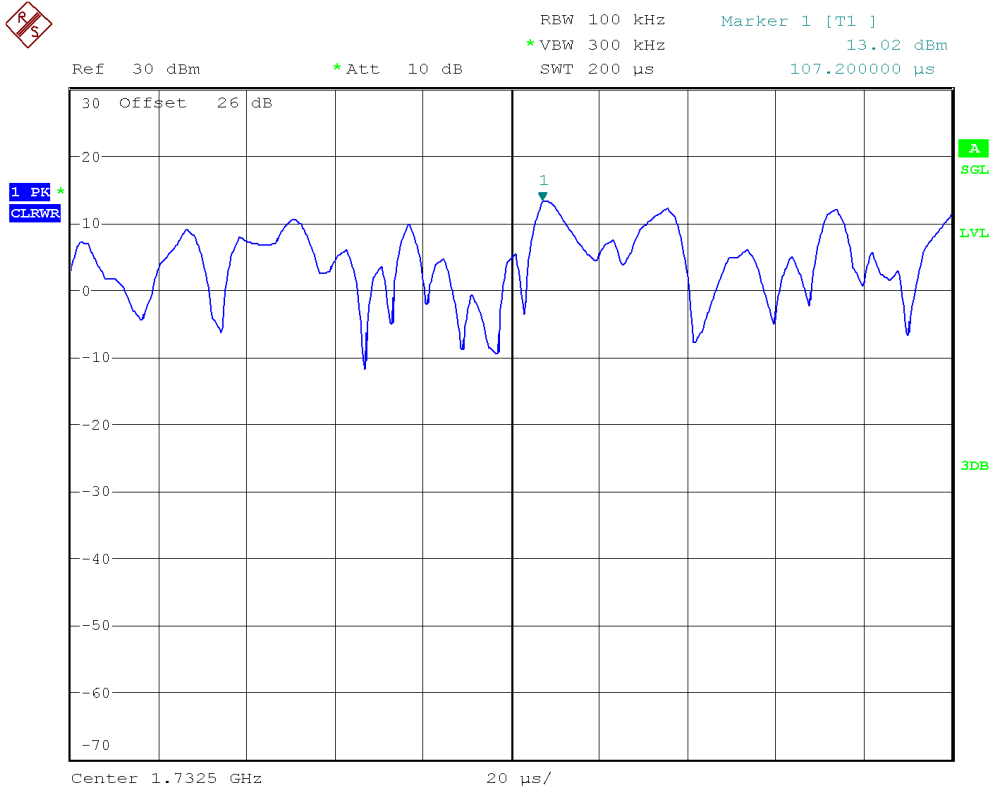

3G Band IV. HSUPA MODULATION.

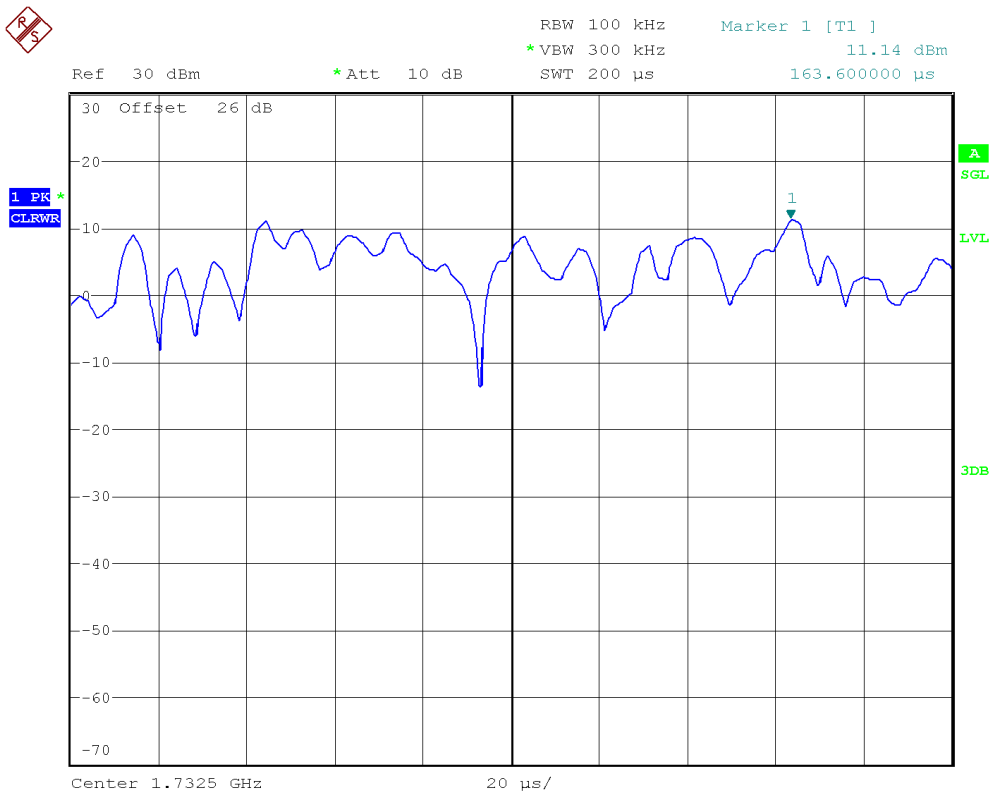

LTE Band 4. QPSK MODULATION. BW = 5 MHz.

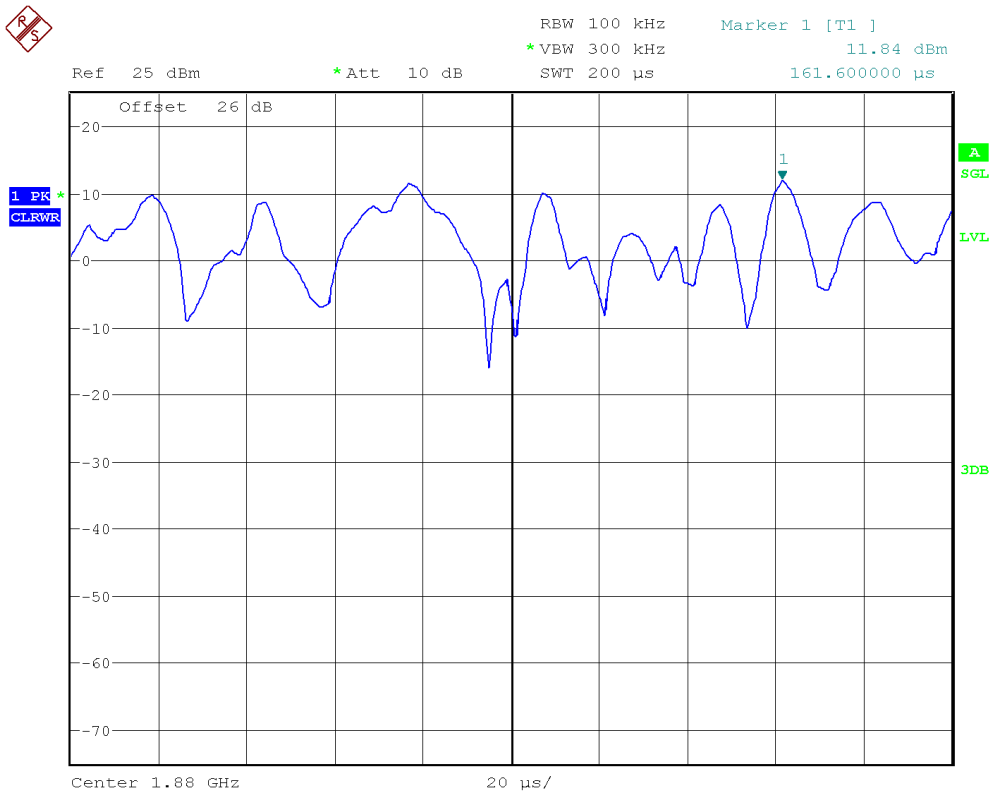

LTE Band 4. 16QAM MODULATION. BW = 5 MHz.

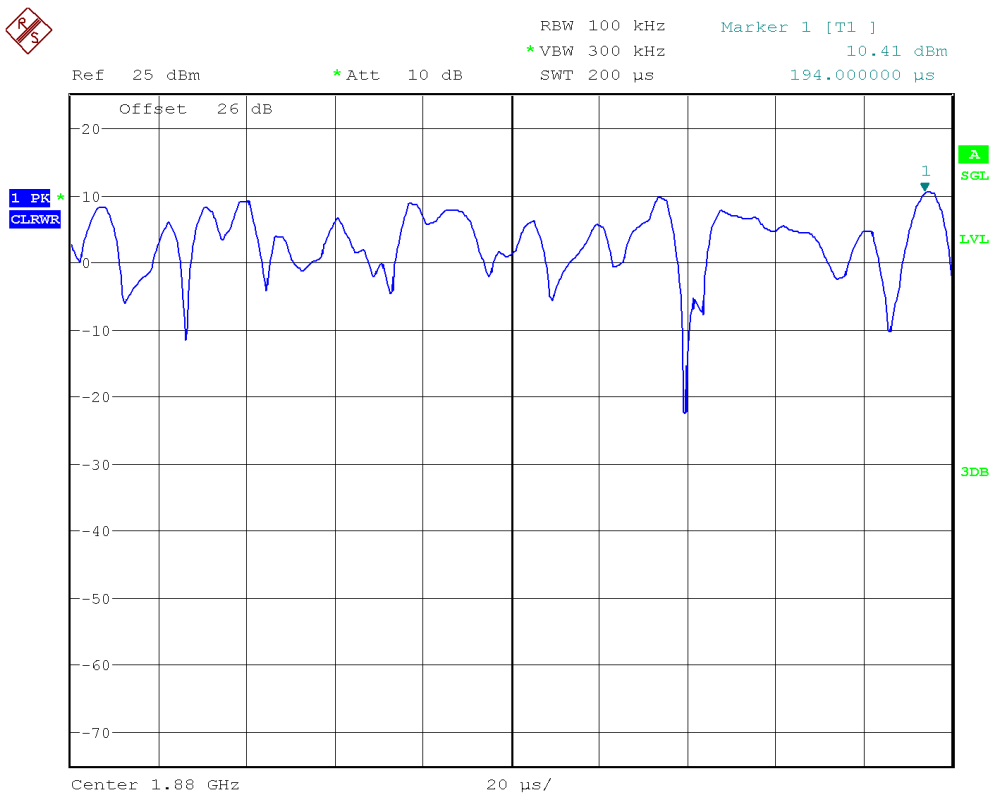

Frequency Stability

SPECIFICATION:

FCC §27.54 & §2.1055:

The frequency stability shall be sufficient to ensure that the fundamental emissions stay within the authorized bands of operation.

RSS-139 Clause 6.4:

The frequency stability shall be sufficient to ensure that the occupied bandwidth stays within the operating frequency block when tested to the temperature and supply voltage variations specified in RSS-Gen.

METHOD:

The frequency tolerance measurements over temperature variations were made over the temperature range of -30°C to $+50^{\circ}\text{C}$. The EUT was placed inside a climatic chamber and the temperature was raised hourly in 10°C steps from -30°C up to $+50^{\circ}\text{C}$.

The supply voltage was varied between 85% and 115% of nominal voltage.

The EUT was set in "Radio Resource Control (RRC) mode" in the middle channel using the Universal Radio Communication tester R&S CMW500 and the maximum frequency error was measured using the built-in calibrated frequency meter.

In order to check that the frequency stability is sufficient such that the fundamental emissions stay within the authorized bands of operation, a reference point is established at the applicable unwanted emissions limit using a RBW equal to the RBW required by the unwanted emissions specification of the applicable regulatory standard. These reference points measured using the lowest and highest channel of operation are identified as fL and fH respectively. The worst-case frequency offset determined in the above methods is added or subtracted from the values of fL and fH to check that the resulting frequencies remain within the band.

The reference point measurements were made at the RF output terminals of the EUT using an attenuator, power splitter and spectrum analyser. The EUT was controlled via the Universal Radio Communication tester R&S CMW500 selecting maximum transmission power of the EUT and different modes of modulation.

TEST SETUP:

1. Frequency Tolerance:

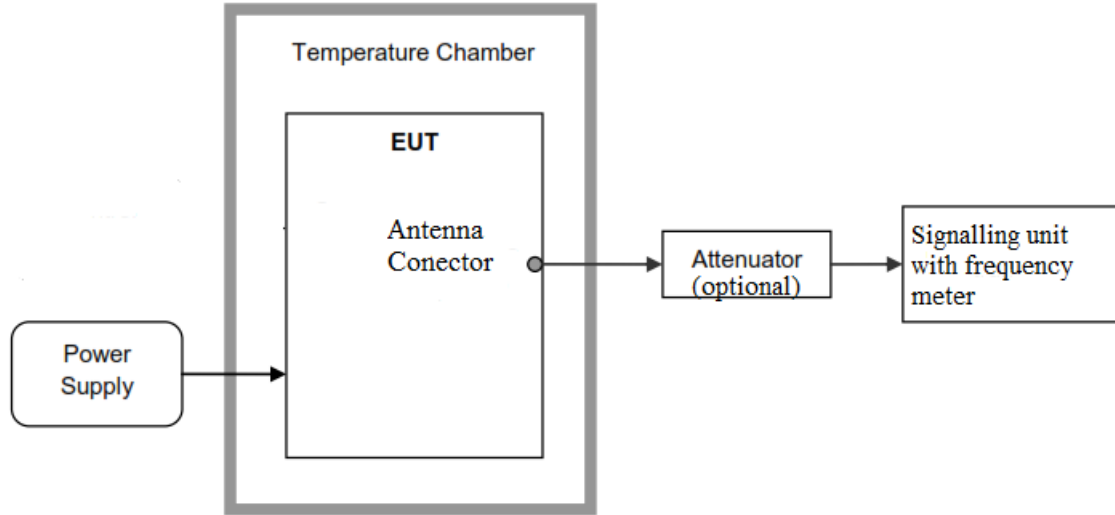

2. Reference Frequency Points f_L and f_H :

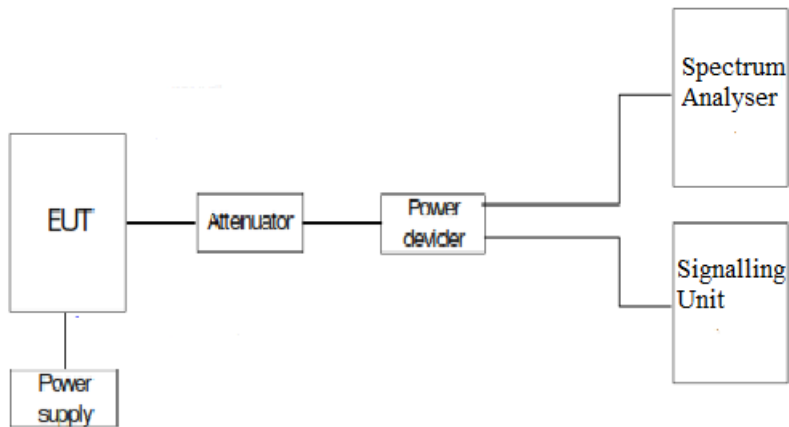

RESULTS:

1. Frequency Tolerance:

- Frequency Stability over Temperature Variations:**

3G Band IV. WCDMA AND HSUPA MODULATIONS.

| Temperature (°C) | Frequency Error (Hz) | Frequency Error (ppm) |
|------------------|----------------------|-----------------------|
| +50 | -0.74 | -0.000427128 |
| +40 | 1.02 | 0.000588745 |
| +30 | -3.68 | -0.002124098 |
| +20 | -2.76 | -0.001593074 |
| +10 | 0.79 | 0.000455988 |
| 0 | -2.24 | -0.001292929 |
| -10 | -0.7 | -0.00040404 |
| -20 | 1.08 | 0.000623377 |
| -30 | 3.76 | 0.002170274 |

LTE Band 4. QPSK MODULATION. BW = 10 MHz.

| Temperature (°C) | Frequency Error (Hz) | Frequency Error (ppm) |
|------------------|----------------------|-----------------------|
| +50 | 0.34 | 0.000196248 |
| +40 | 0.44 | 0.000253968 |
| +30 | 0.59 | 0.000340548 |
| +20 | 0.31 | 0.000178932 |
| +10 | 1.2 | 0.000692641 |
| 0 | 1.32 | 0.000761905 |
| -10 | 1.2 | 0.000692641 |
| -20 | 1.39 | 0.000802309 |
| -30 | 0.77 | 0.000444444 |

- **Frequency Stability over Voltage Variations.**

3G Band IV. WCDMA AND HSUPA MODULATION.

| Battery Supply voltage | Voltage (V) | Frequency Error (Hz) | Frequency Error (ppm) |
|------------------------|-------------|----------------------|-----------------------|
| Vmax | 15 | 0.39 | 0.000225108 |
| Vmin (*) | 9 | 0.27 | 0.000155844 |

(*): Operating end point specified by the manufacturer.

LTE Band 4. QPSK MODULATION. BW = 10 MHz.

| Battery Supply voltage | Voltage (V) | Frequency Error (Hz) | Frequency Error (ppm) |
|------------------------|-------------|----------------------|-----------------------|
| Vmax | 15 | 0.07 | 0.000040404 |
| Vmin(*) | 9 | 0.47 | 0.000271284 |

(*): Operating end point specified by the manufacturer.

2. Reference Frequency Points fL and fH:

The worst-case frequency offsets added or subtracted per band and bandwidth:

3G Band IV:

| | WCDMA MODULATION |
|----------|---------------------|
| fL (MHz) | 1710.1121753 |
| fH (MHz) | 1754.8902598 |

LTE Band 4:

| | LTE QPSK MODULATION. BW = 10 MHz |
|----------|-------------------------------------|
| fL (MHz) | 1710.026999 |
| fH (MHz) | 1754.991001 |

The reference frequency points fL and fH stay within the authorized blocks for all the bands above.

Verdict: PASS

Occupied Bandwidth

SPECIFICATION:

FCC §2.1049: Measurements required: Occupied bandwidth.

RSS-Gen Clause 6.7: Occupied bandwidth (or 99% emission bandwidth) and x dB bandwidth.

METHOD:

The occupied bandwidth measurement was performed at the output terminals of the EUT using an attenuator, power splitter and spectrum analyser. The EUT was controlled via the Universal Radio Communication tester R&S CMW500 selecting maximum transmission power of the EUT and different modes of modulation. The 99% occupied bandwidth and the -26 dBc bandwidth were measured directly using the built-in bandwidth measuring option of spectrum analyser.

TEST SETUP:

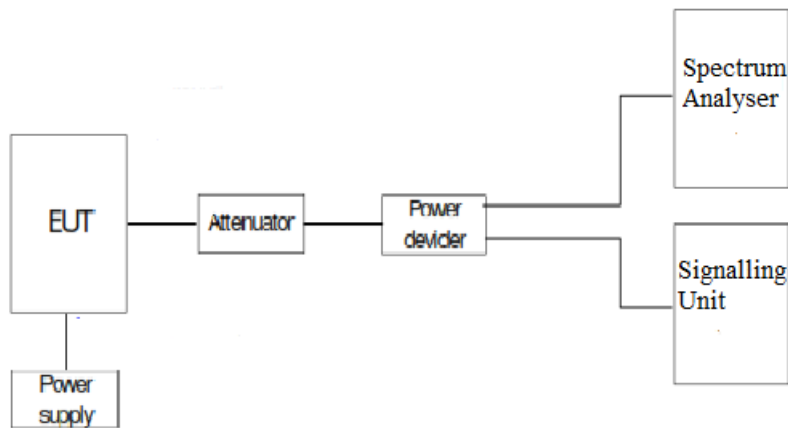

RESULTS:

3G Band IV:

3G Band IV. WCDMA MODULATION.

| | Lowest Channel | Middle Channel | Highest Channel |
|-------------------------------|----------------|----------------|-----------------|
| 99% Occupied bandwidth (kHz) | 4130.000 | 4130.000 | 4130.000 |
| -26 dBc bandwidth (kHz) | 4701.256 | 4711.538 | 4727.564 |
| Measurement uncertainty (kHz) | <±16.67 | | |

3G Band IV. HSUPA MODULATION.

| | Lowest Channel | Middle Channel | Highest Channel |
|-------------------------------|----------------|----------------|-----------------|
| 99% Occupied bandwidth (kHz) | 4130.000 | 4130.000 | 4140.000 |
| -26 dBc bandwidth (kHz) | 4727.564 | 4718.077 | 4715.513 |
| Measurement uncertainty (kHz) | <±16.67 | | |

LTE Bands: The worst case of Occupied Bandwidth corresponds to all Resource Blocks (RB) with Offset 0, regardless the nominal bandwidth selected.

LTE Band 4:

LTE Band 4. QPSK MODULATION. BW = 1.4 MHz.

| | Lowest Channel | Middle Channel | Highest Channel |
|-------------------------------|----------------|----------------|-----------------|
| 99% Occupied bandwidth (kHz) | 1106.00 | 1111.60 | 1100.40 |
| -26 dBc bandwidth (kHz) | 1330.00 | 1324.40 | 1327.60 |
| Measurement uncertainty (kHz) | <±4.67 | | |

LTE Band 4. 16QAM MODULATION. BW = 1.4 MHz.

| | Lowest Channel | Middle Channel | Highest Channel |
|-------------------------------|----------------|----------------|-----------------|
| 99% Occupied bandwidth (kHz) | 1106.00 | 1094.80 | 1097.60 |
| -26 dBc bandwidth (kHz) | 1327.20 | 1307.60 | 1313.60 |
| Measurement uncertainty (kHz) | <±4.67 | | |

LTE Band 4. QPSK MODULATION. BW = 3 MHz.

| | Lowest Channel | Middle Channel | Highest Channel |
|-------------------------------|----------------|----------------|-----------------|
| 99% Occupied bandwidth (kHz) | 2736.00 | 2748.00 | 2736.00 |
| -26 dBc bandwidth (kHz) | 3084.00 | 3060.00 | 3084.00 |
| Measurement uncertainty (kHz) | <±10 | | |

LTE Band 4. 16QAM MODULATION. BW = 3 MHz.

| | Lowest Channel | Middle Channel | Highest Channel |
|-------------------------------|----------------|----------------|-----------------|
| 99% Occupied bandwidth (kHz) | 2736.00 | 2736.00 | 2724.00 |
| -26 dBc bandwidth (kHz) | 3084.00 | 3066.00 | 3072.00 |
| Measurement uncertainty (kHz) | <±10 | | |

LTE Band 4. QPSK MODULATION. BW = 5 MHz.

| | Lowest Channel | Middle Channel | Highest Channel |
|-------------------------------|----------------|----------------|-----------------|
| 99% Occupied bandwidth (kHz) | 4520.00 | 4500.00 | 4510.00 |
| -26 dBc bandwidth (kHz) | 5070.00 | 4990.00 | 4970.00 |
| Measurement uncertainty (kHz) | <±16.67 | | |

LTE Band 4. 16QAM MODULATION. BW = 5 MHz.

| | Lowest Channel | Middle Channel | Highest Channel |
|-------------------------------|----------------|----------------|-----------------|
| 99% Occupied bandwidth (kHz) | 4510.00 | 4510.00 | 4500.00 |
| -26 dBc bandwidth (kHz) | 5040.00 | 5030.00 | 4990.00 |
| Measurement uncertainty (kHz) | <±16.67 | | |

LTE Band 4. QPSK MODULATION. BW = 10 MHz.

| | Lowest Channel | Middle Channel | Highest Channel |
|-------------------------------|----------------|----------------|-----------------|
| 99% Occupied bandwidth (kHz) | 9009.60 | 8995.30 | 9015.70 |
| -26 dBc bandwidth (kHz) | 10043.00 | 10050.00 | 10055.00 |
| Measurement uncertainty (kHz) | <±33.33 | | |

LTE Band 4. QPSK MODULATION. BW = 15 MHz.

| | Lowest Channel | Middle Channel | Highest Channel |
|-------------------------------|----------------|----------------|-----------------|
| 99% Occupied bandwidth (kHz) | 13448.50 | 13416.60 | 13457.30 |
| -26 dBc bandwidth (kHz) | 14630.00 | 14674.00 | 14840.00 |
| Measurement uncertainty (kHz) | <±50 | | |

LTE Band 4. QPSK MODULATION. BW = 20 MHz.

| | Lowest Channel | Middle Channel | Highest Channel |
|-------------------------------|----------------|----------------|-----------------|
| 99% Occupied bandwidth (kHz) | 17841.70 | 17865.70 | 17903.90 |
| -26 dBc bandwidth (kHz) | 19227.00 | 19306.00 | 19329.00 |
| Measurement uncertainty (kHz) | <±66.67 | | |

3G Band IV. WCDMA MODULATION.

Lowest Channel:

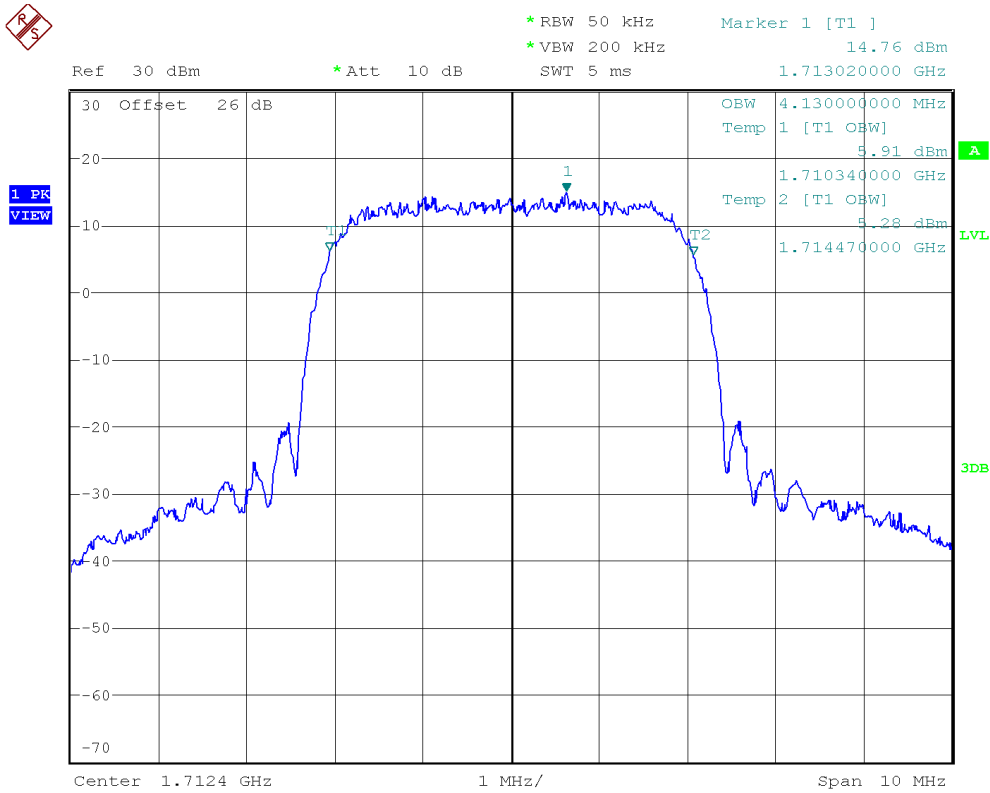

Middle Channel:

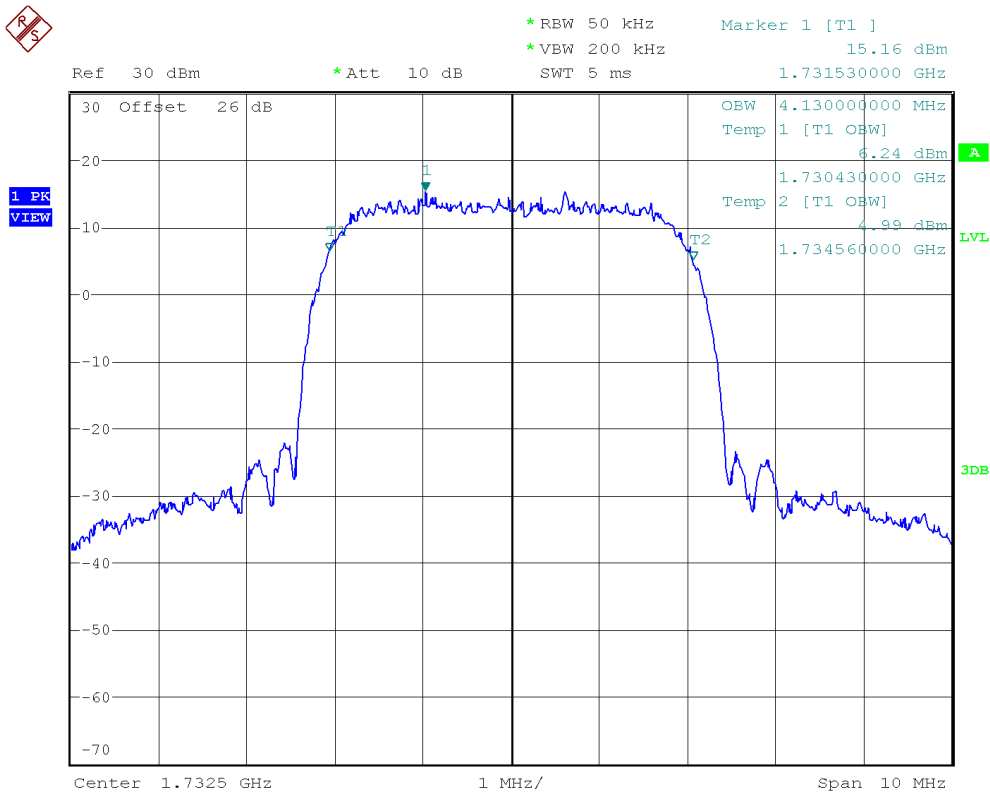

Highest Channel:

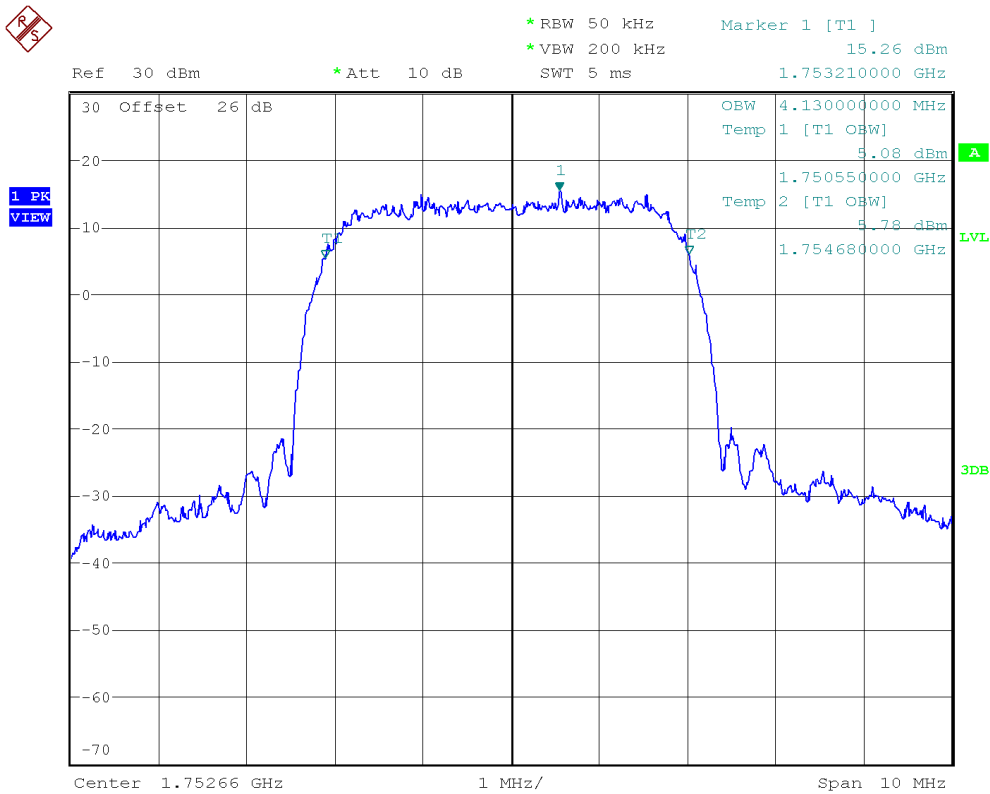

3G Band IV. HSUPA MODULATION.

Lowest Channel:

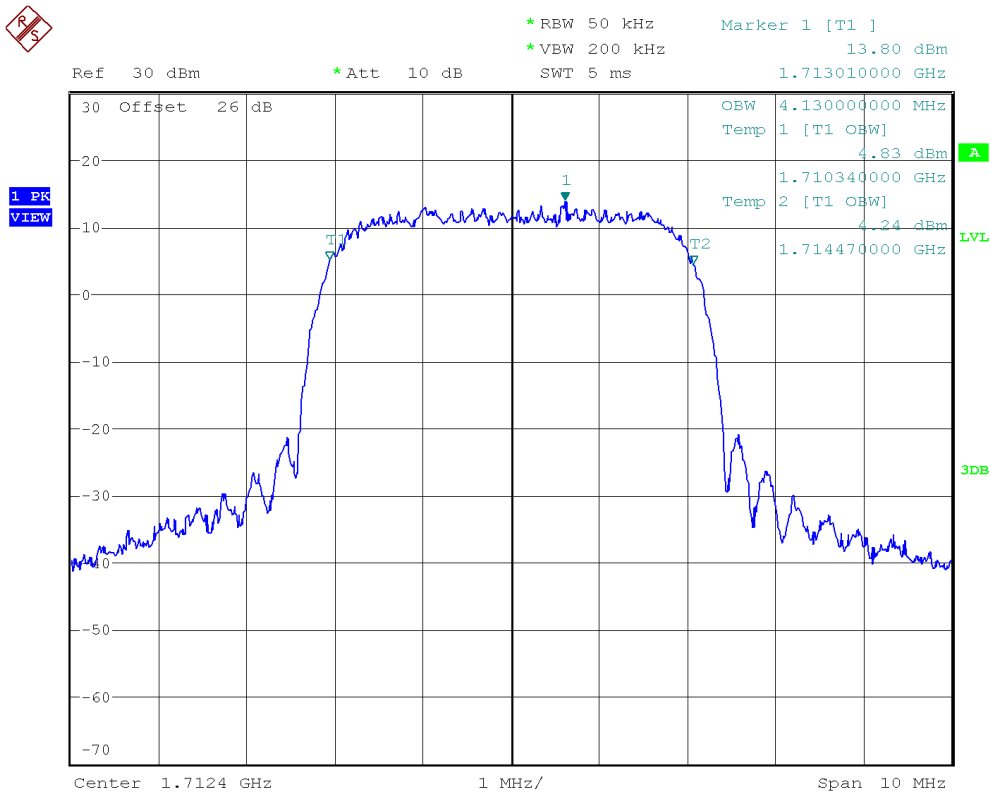

Middle Channel:

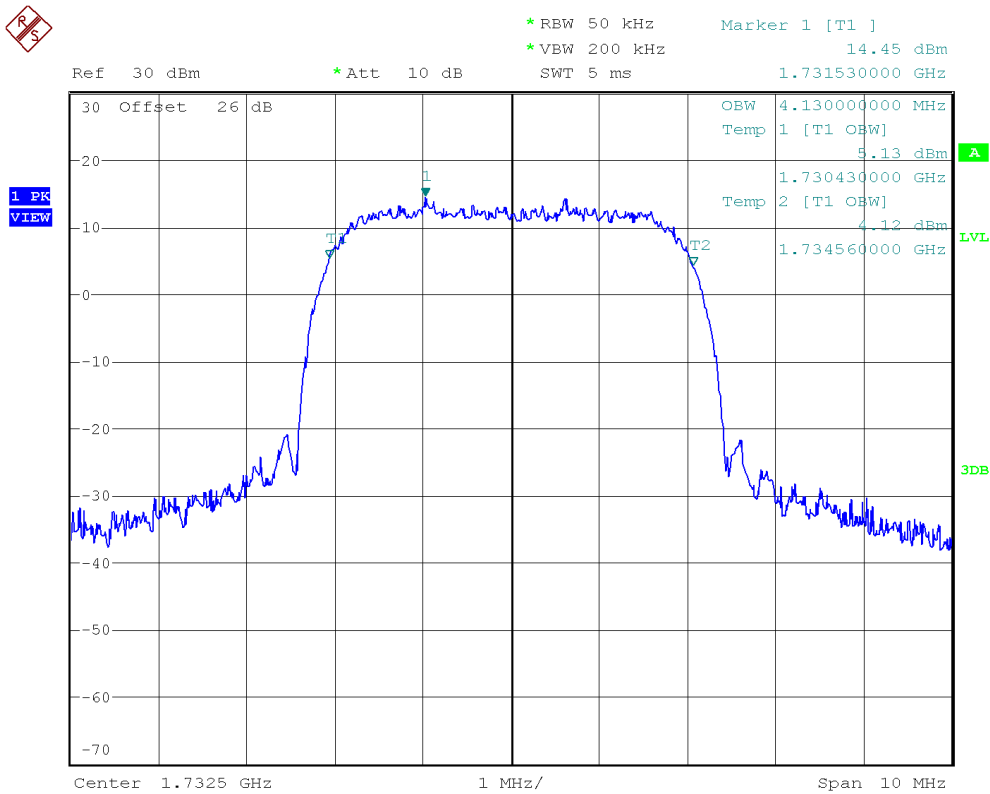

Highest Channel:

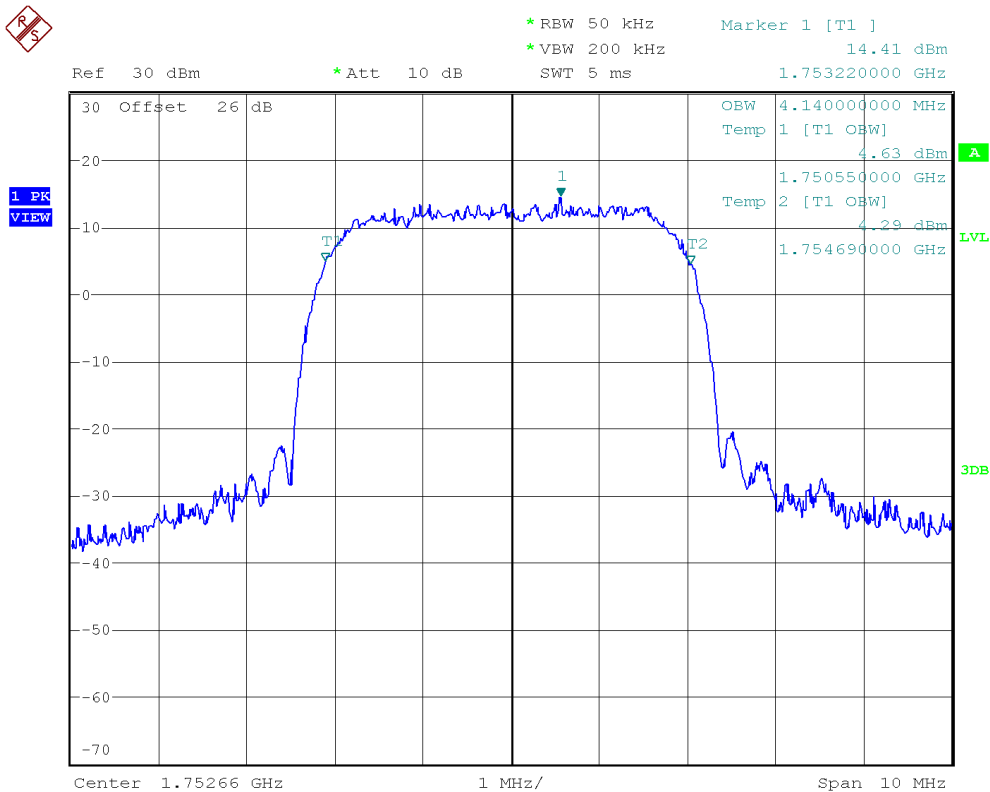

LTE Band 4. QPSK MODULATION. BW = 1.4 MHz.

Lowest Channel:

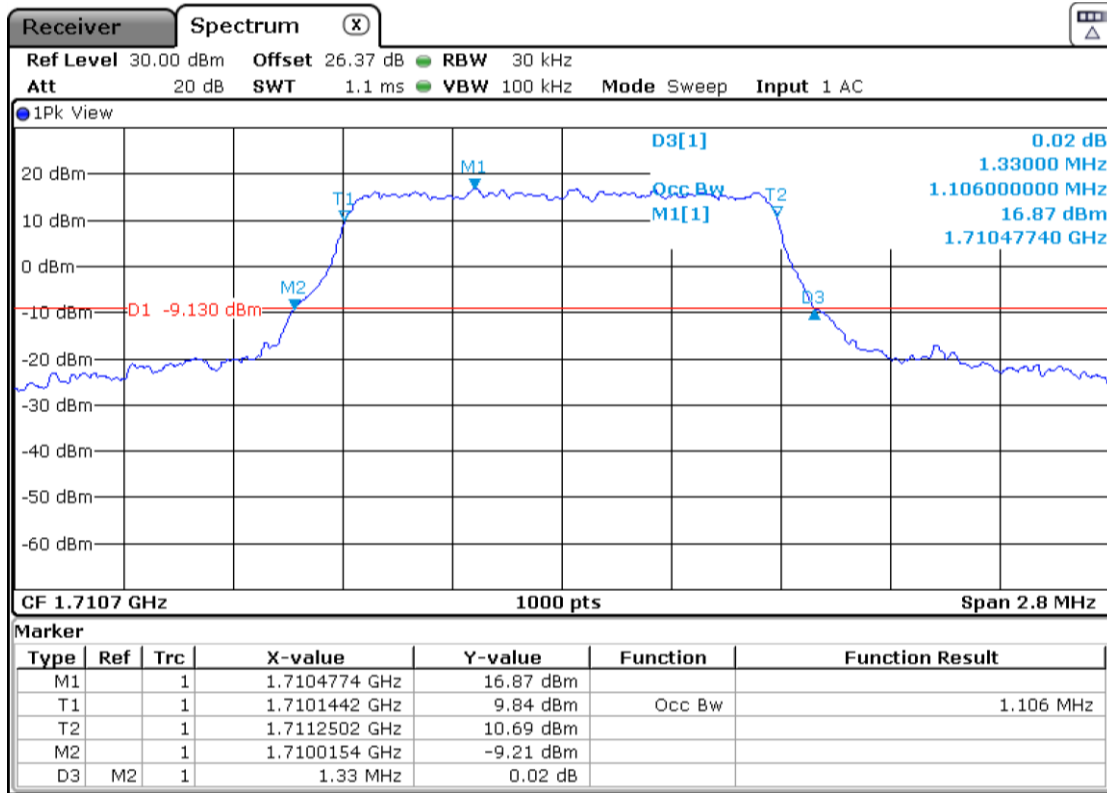

Middle Channel:

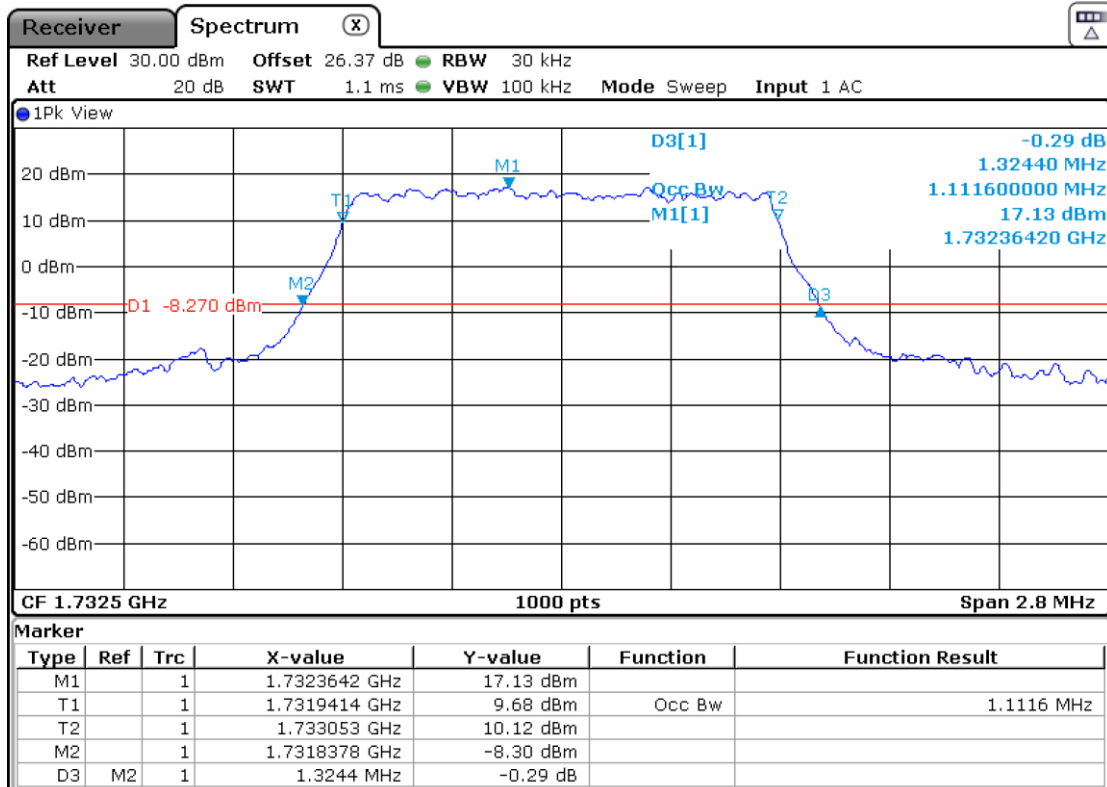

Highest Channel:

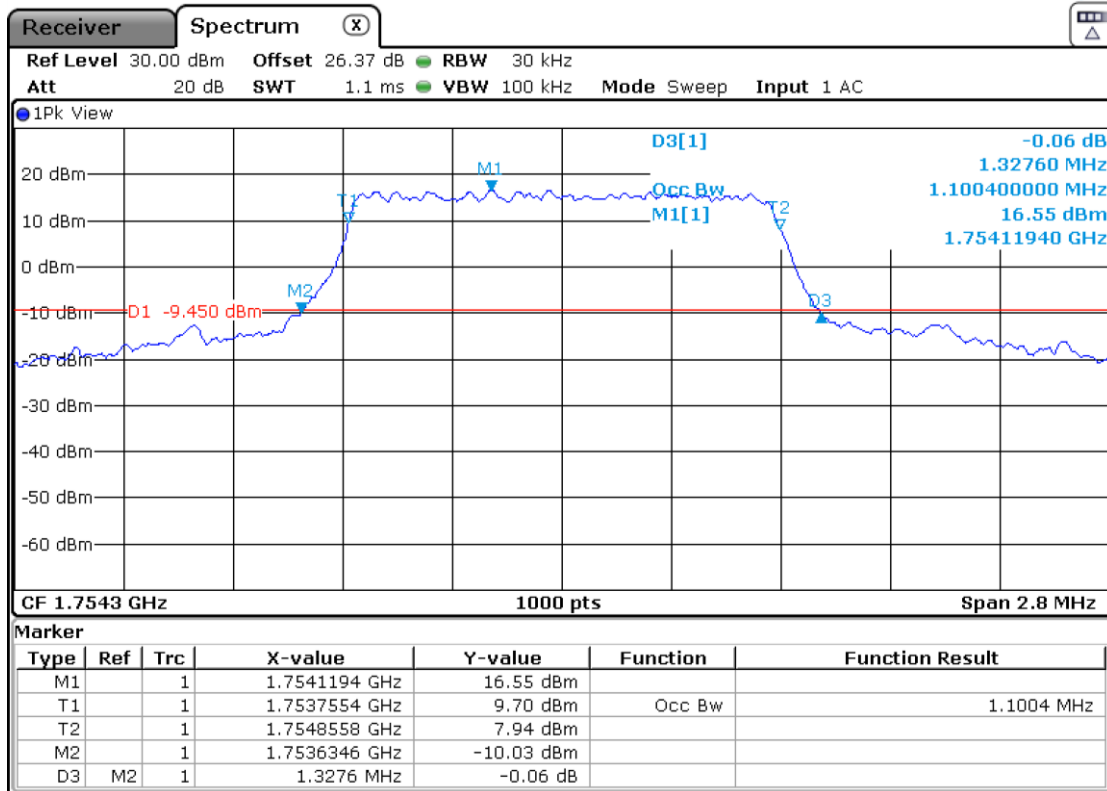

LTE Band 4. 16QAM MODULATION. BW = 1.4 MHz.

Lowest Channel:

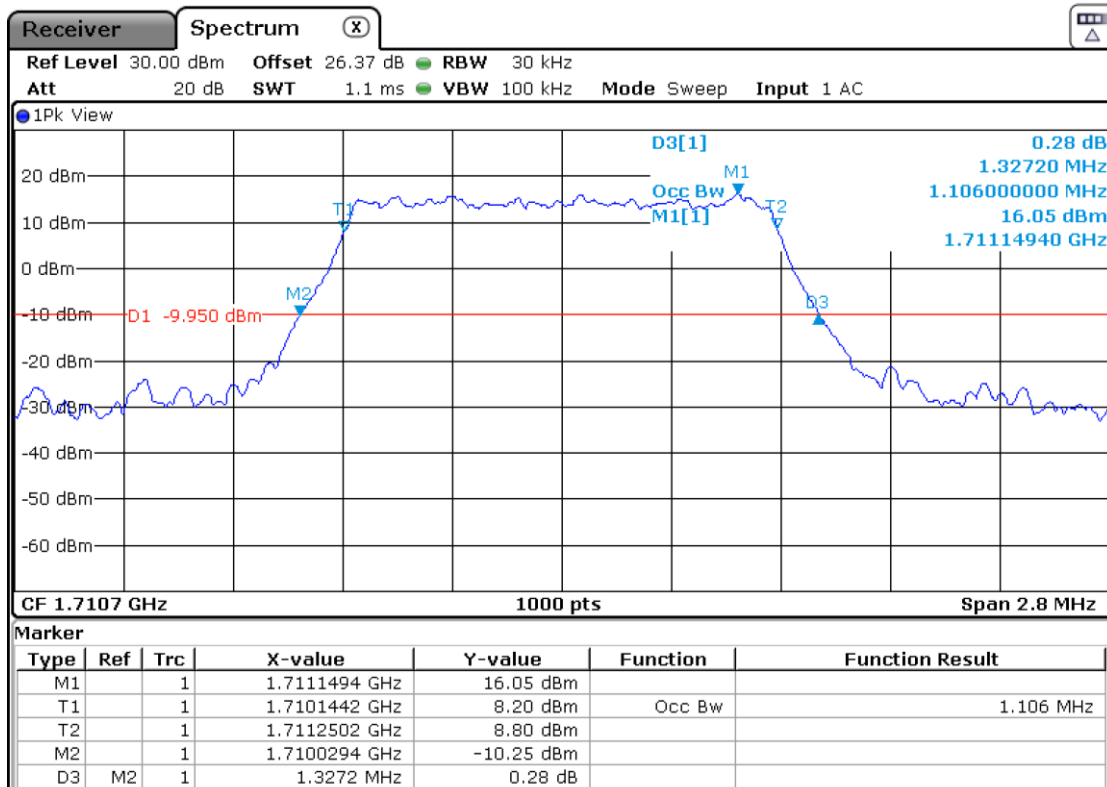

Middle Channel:

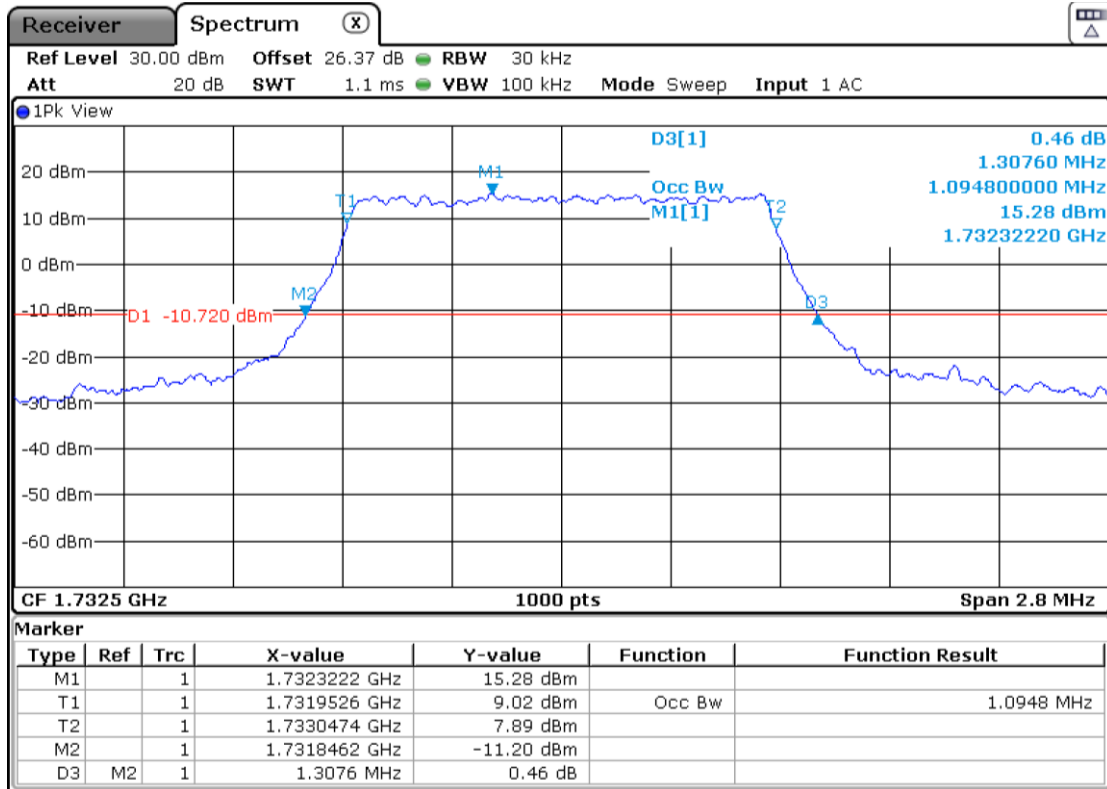

Highest Channel:

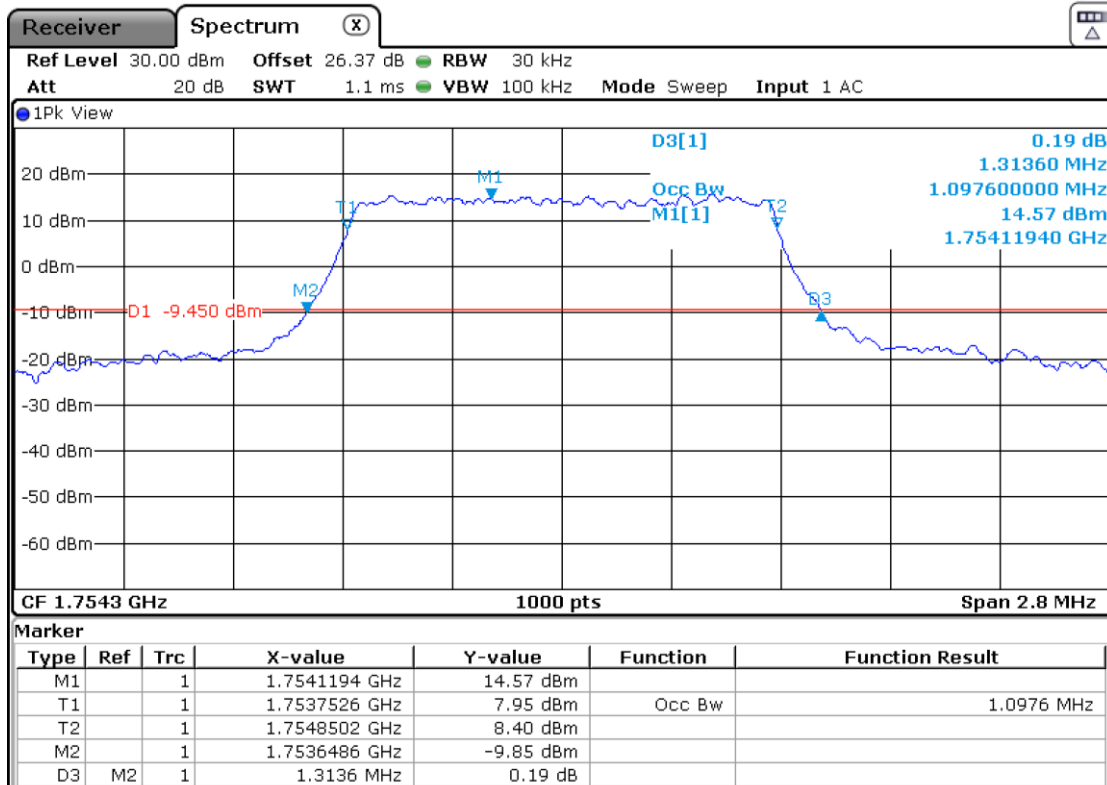

LTE Band 4. QPSK MODULATION. BW = 3 MHz.

Lowest Channel:

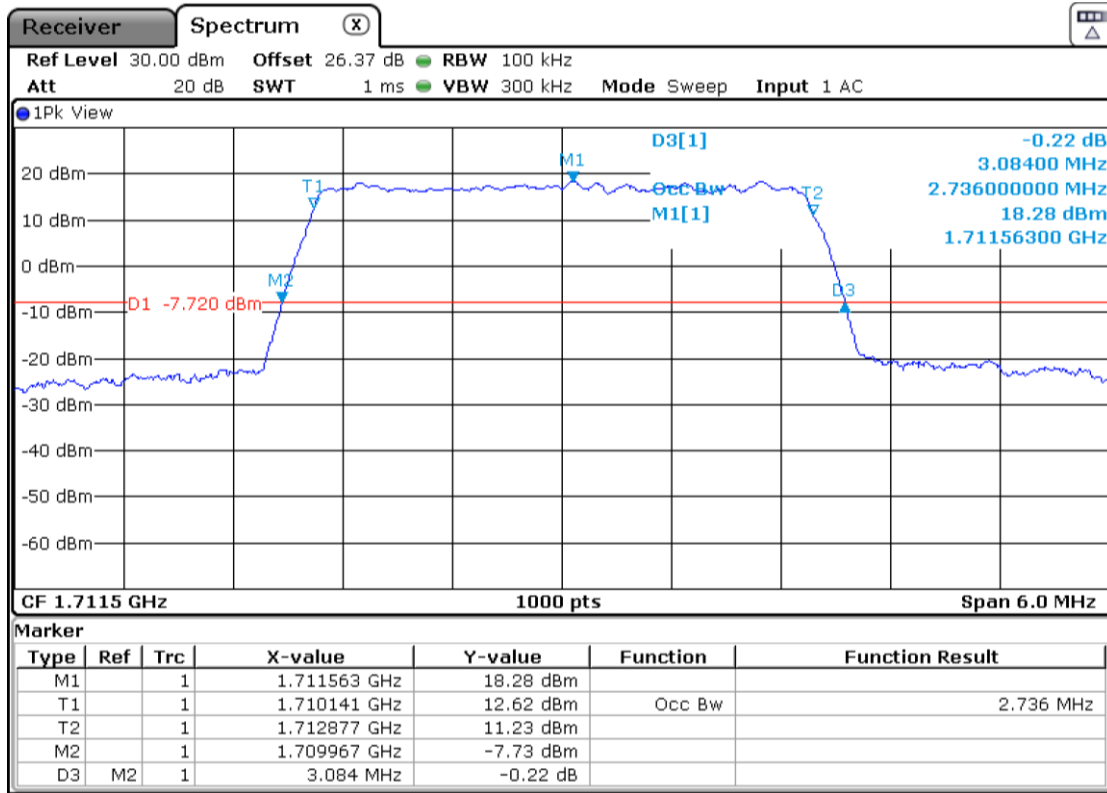

Middle Channel:

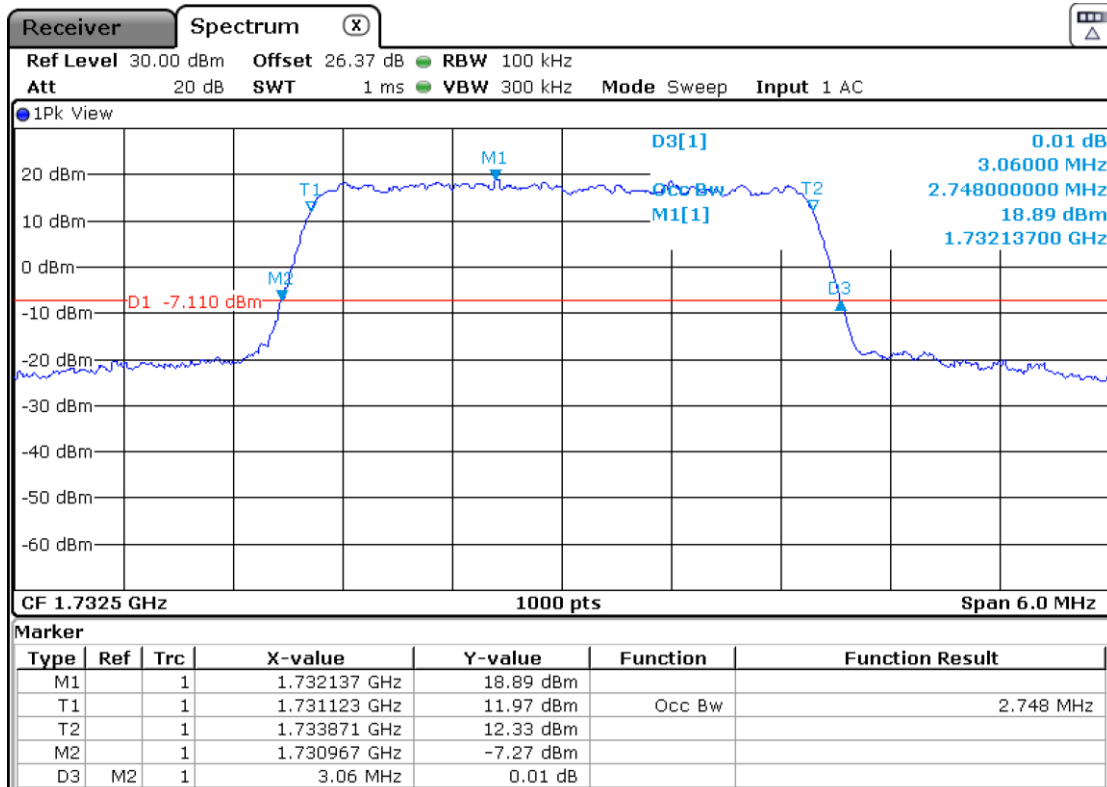

Highest Channel:

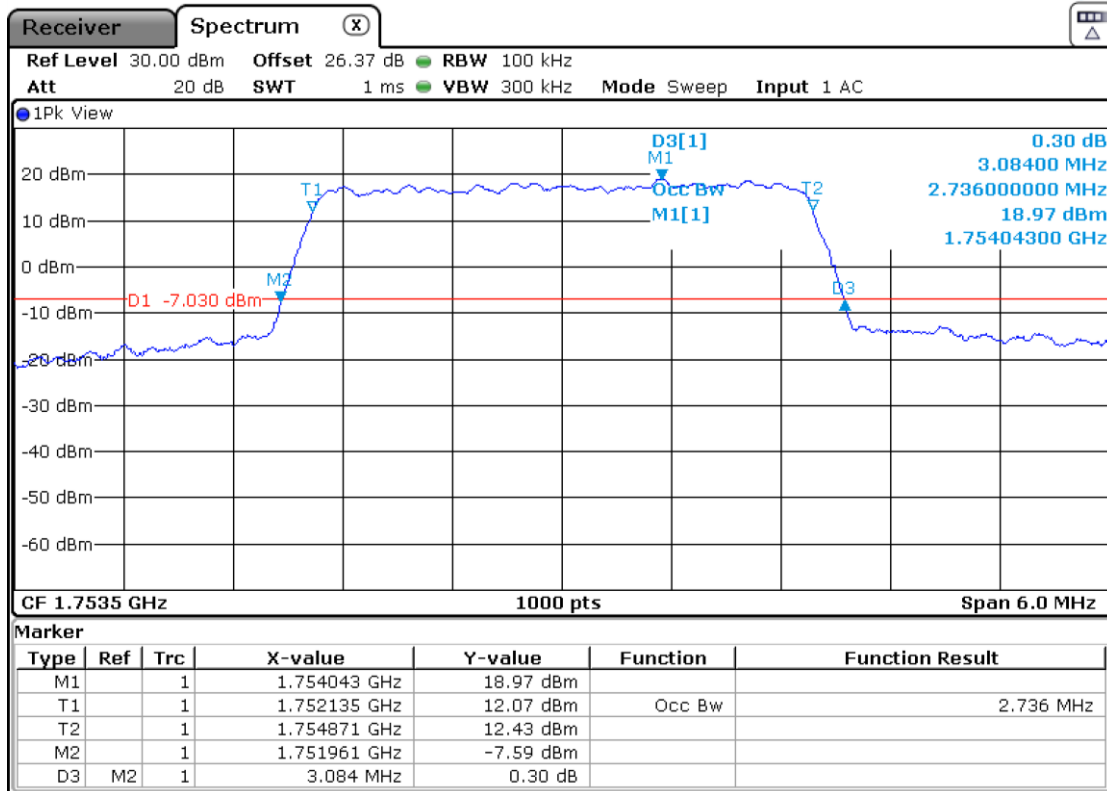

LTE Band 4. 16QAM MODULATION. BW = 3 MHz.

Lowest Channel:

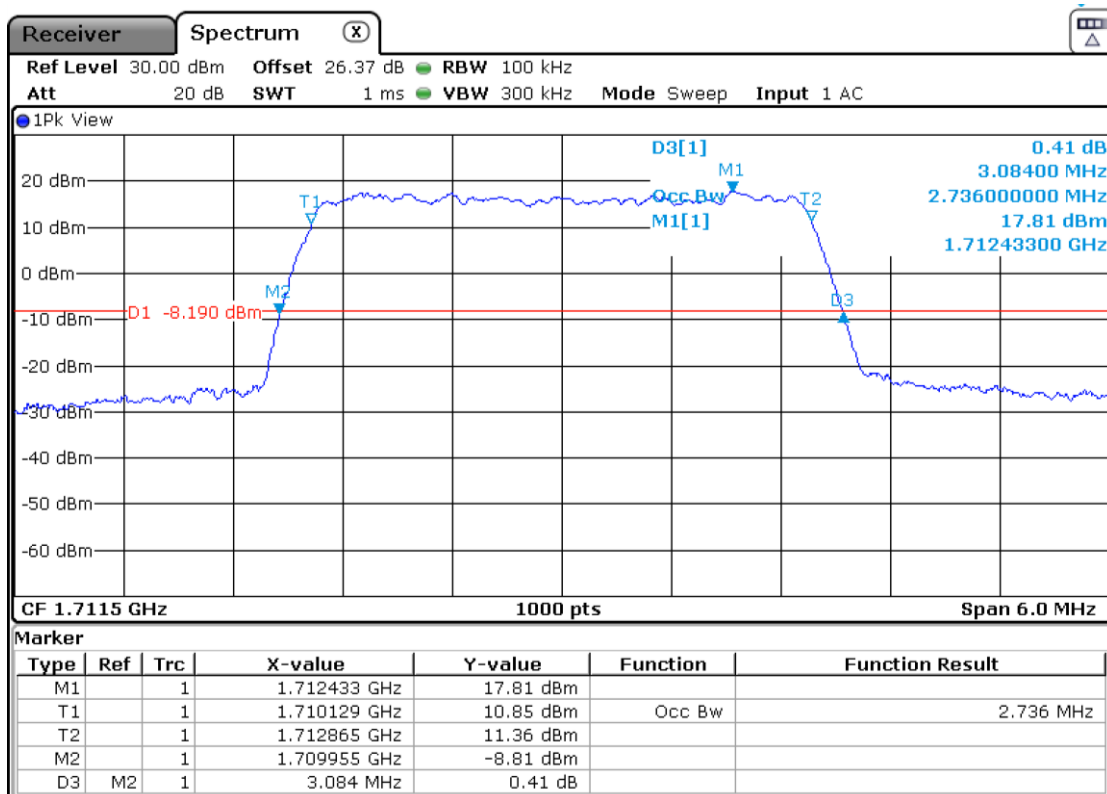

Middle Channel:

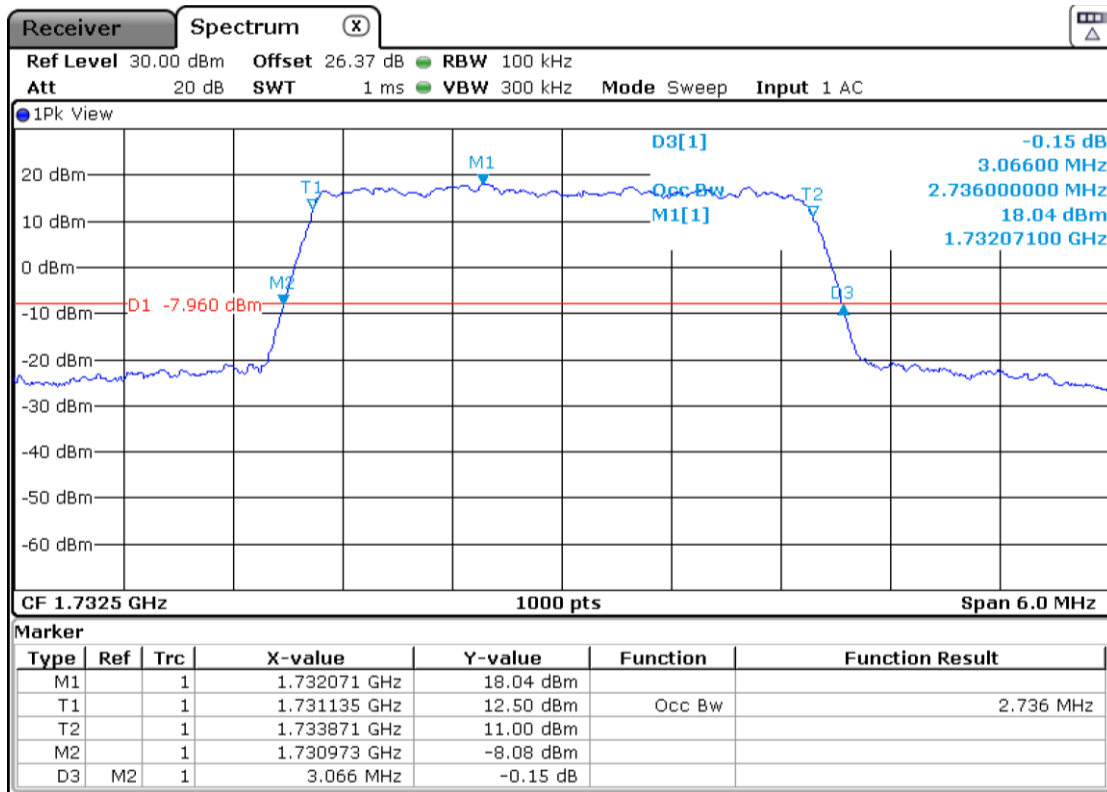

Highest Channel:

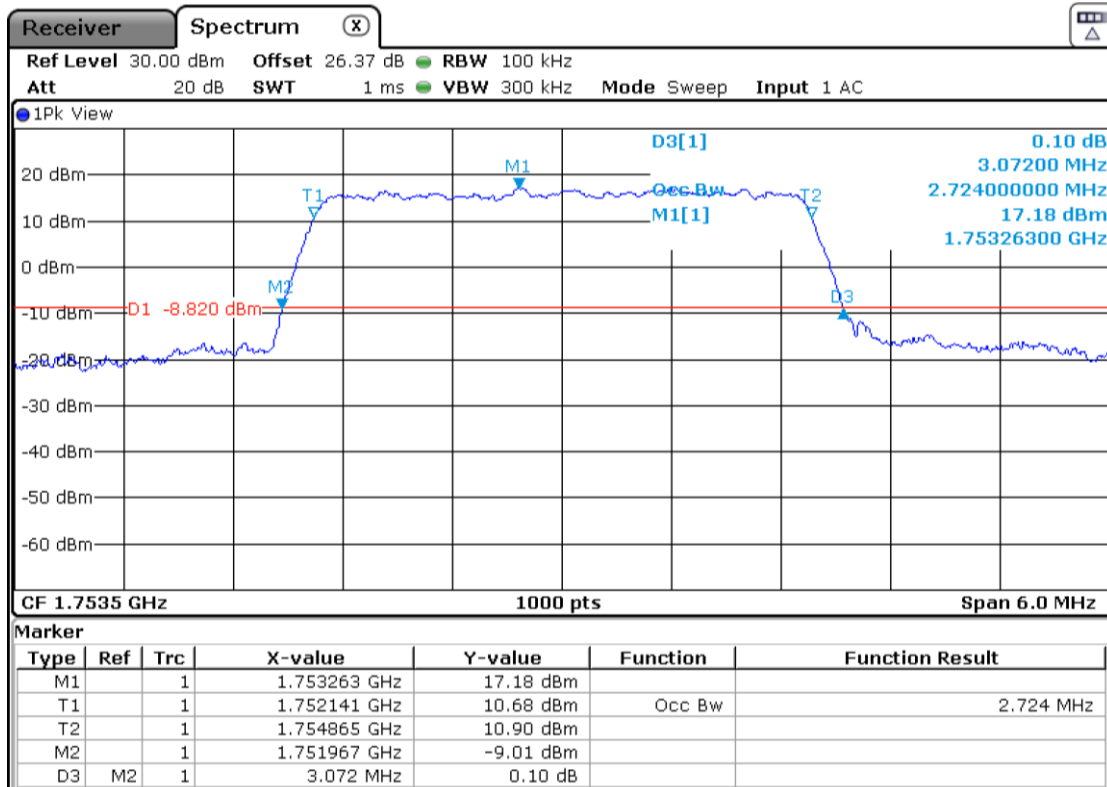

LTE Band 4. QPSK MODULATION. BW = 5 MHz.

Lowest Channel:

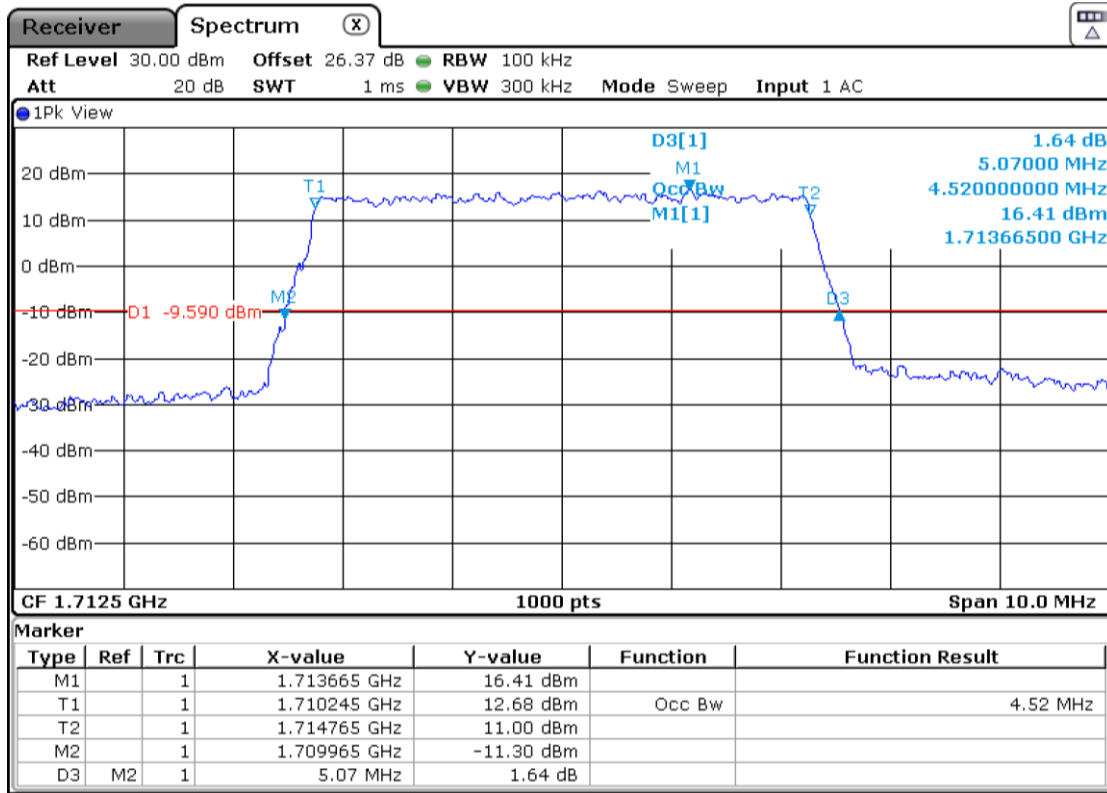

Middle Channel:

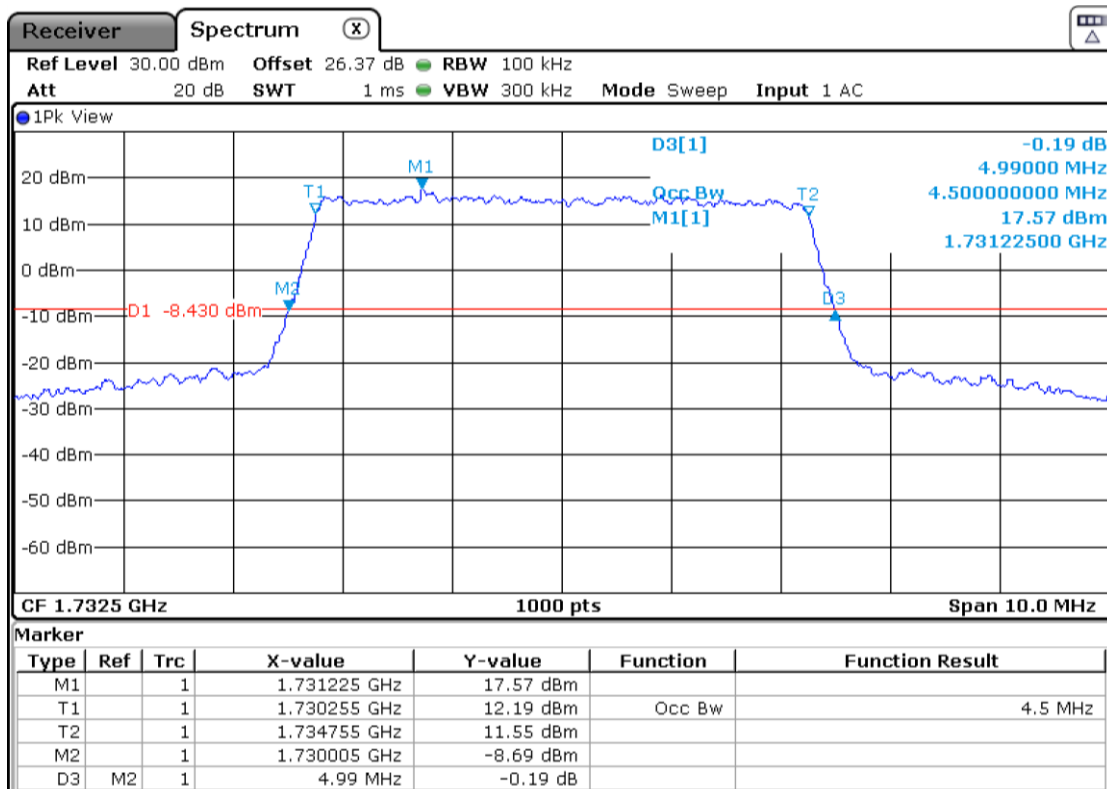

Highest Channel:

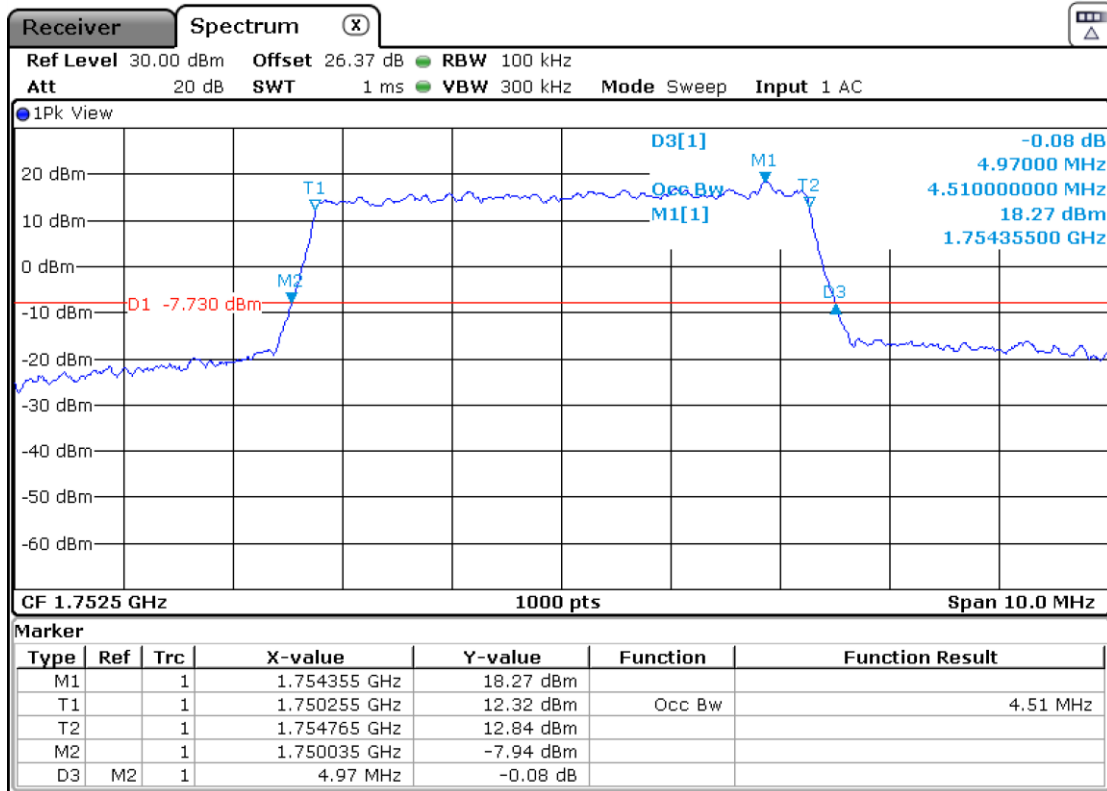

LTE Band 4. 16QAM MODULATION. BW = 5 MHz.

Lowest Channel:

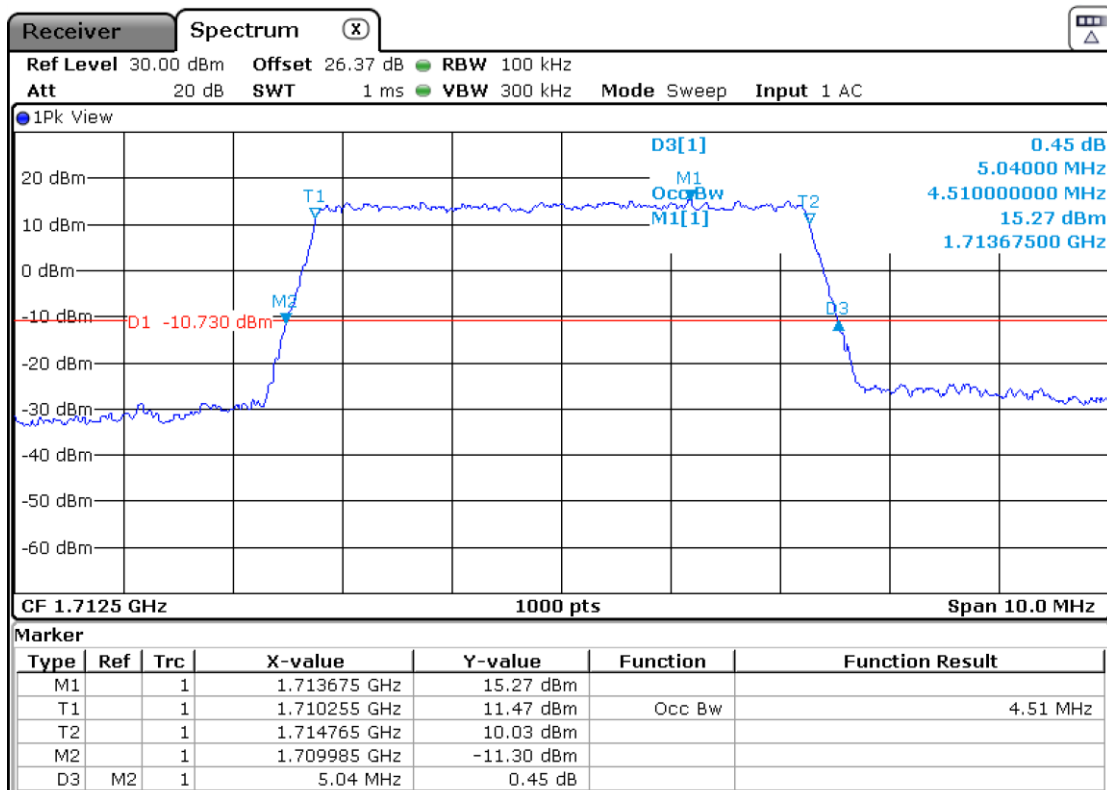

Middle Channel:

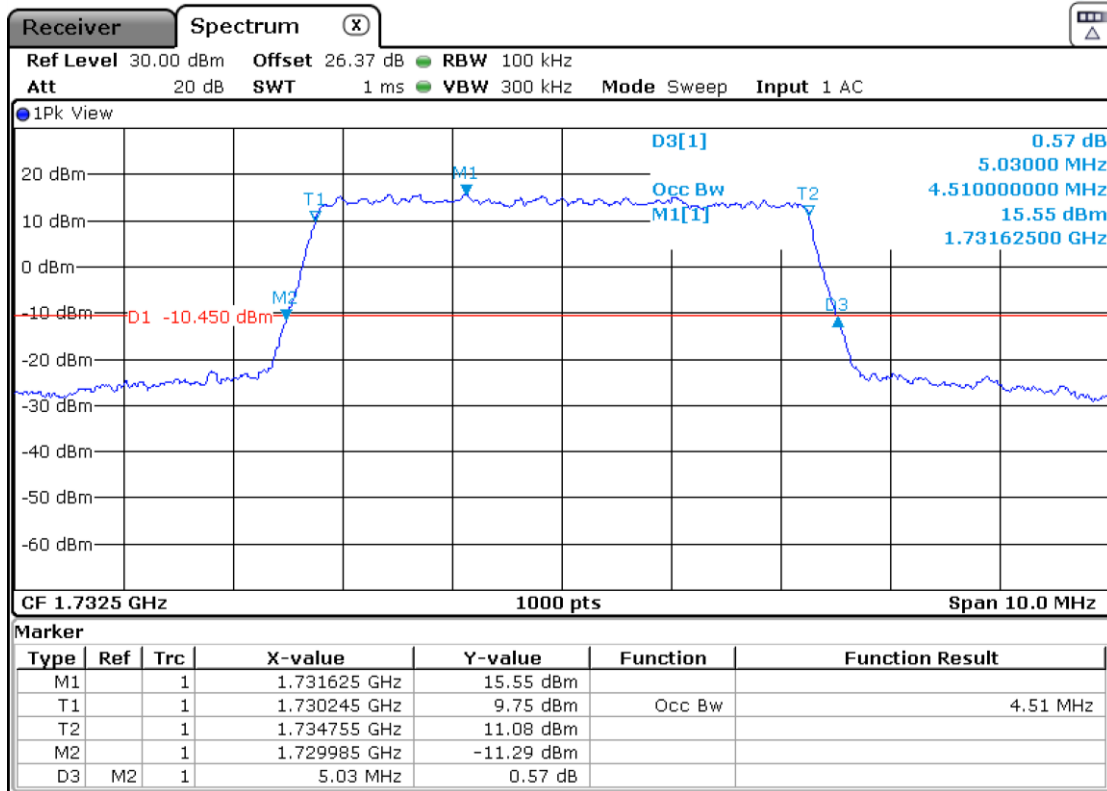

Highest Channel:

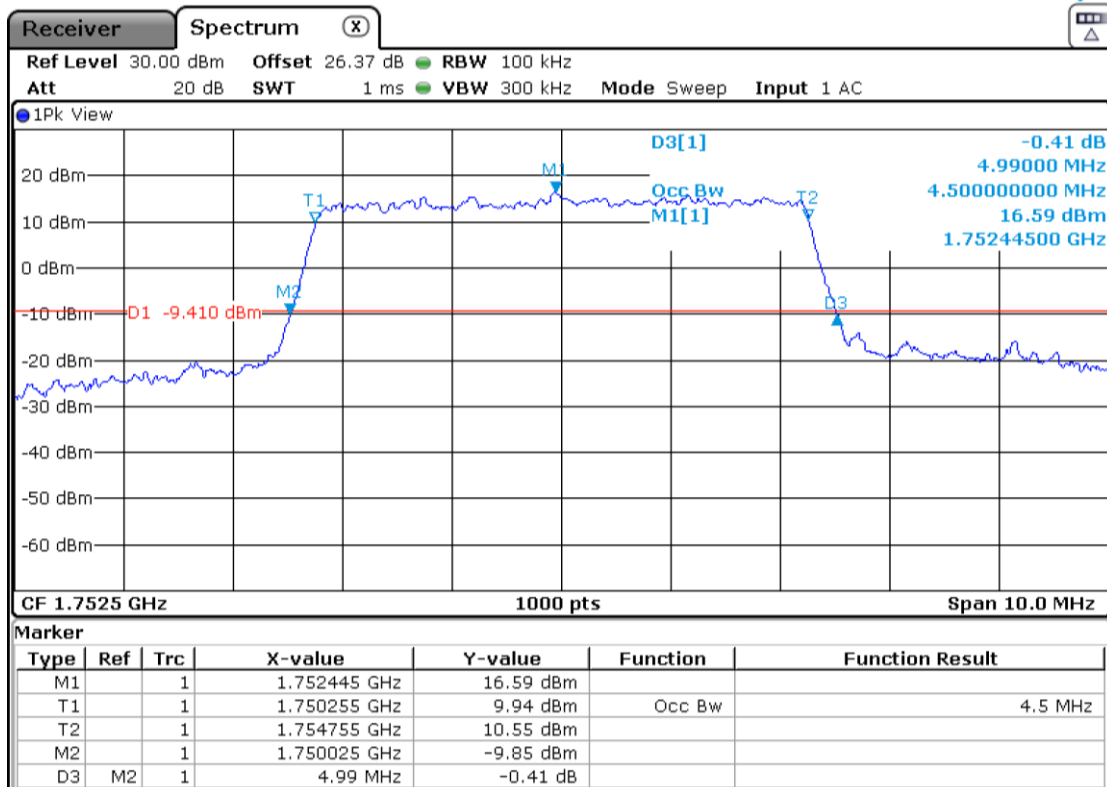

LTE Band 4. QPSK MODULATION. BW = 10 MHz.

Lowest Channel:

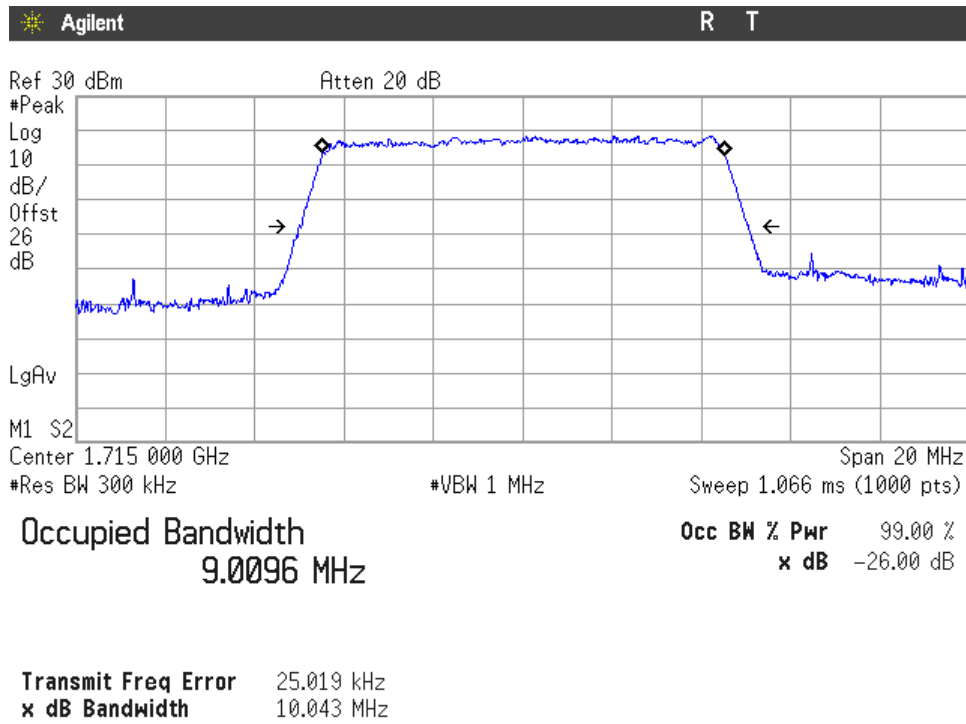

Middle Channel:

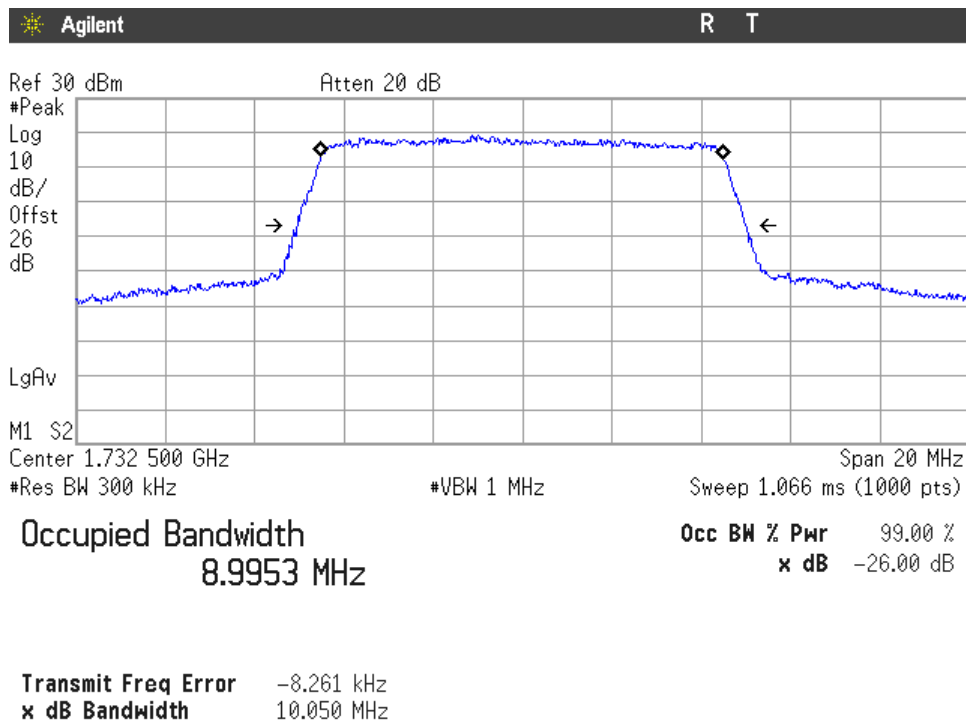

Highest Channel:

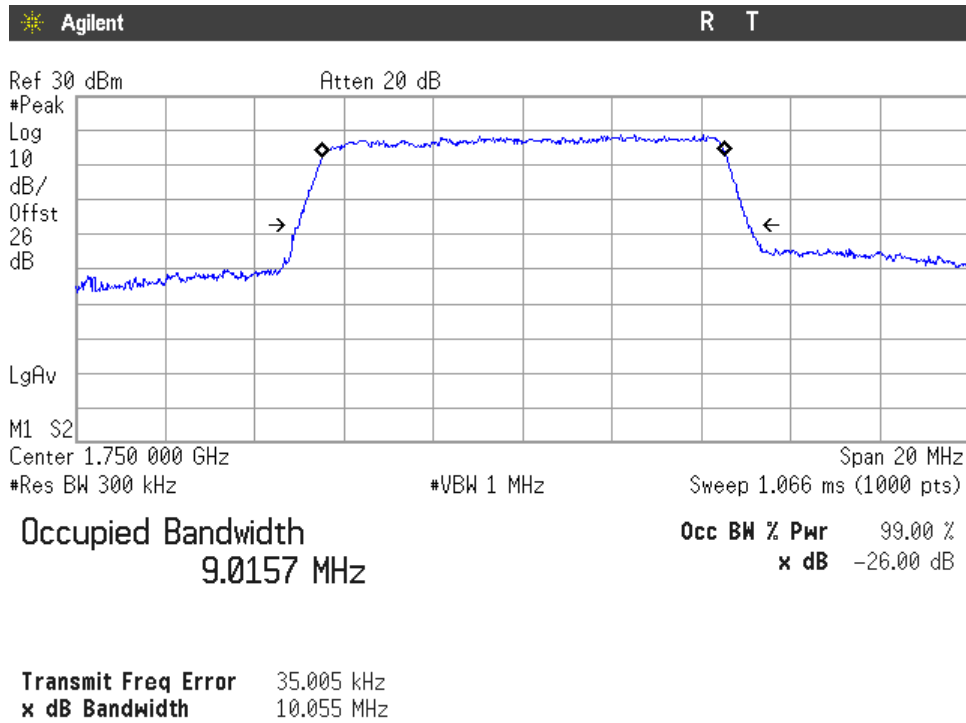

LTE Band 4. QPSK MODULATION. BW = 15 MHz.

Lowest Channel:

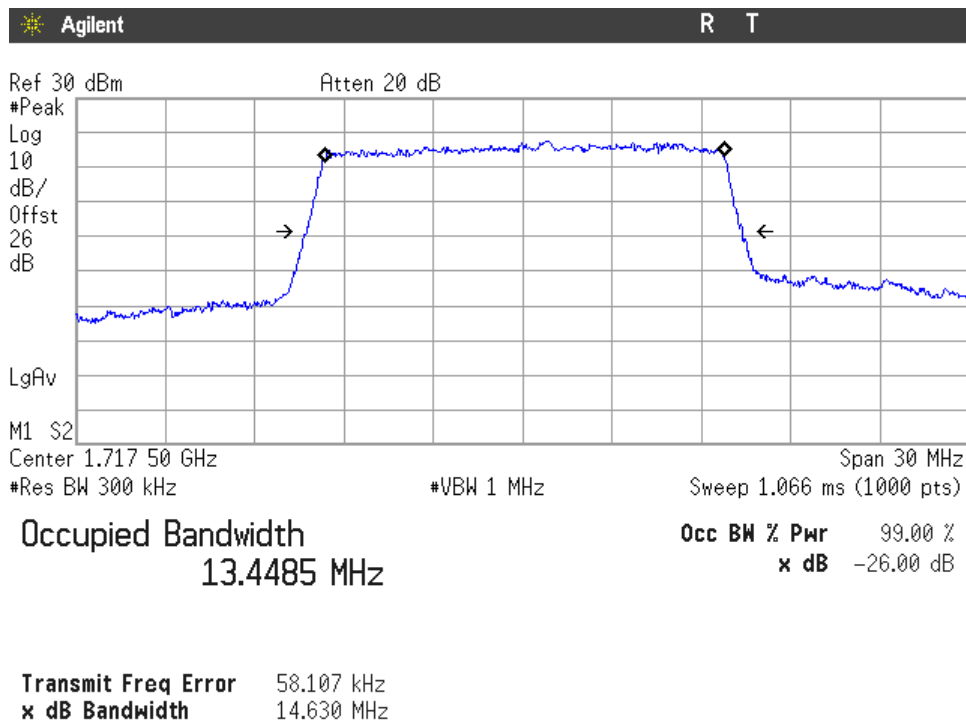

Middle Channel:

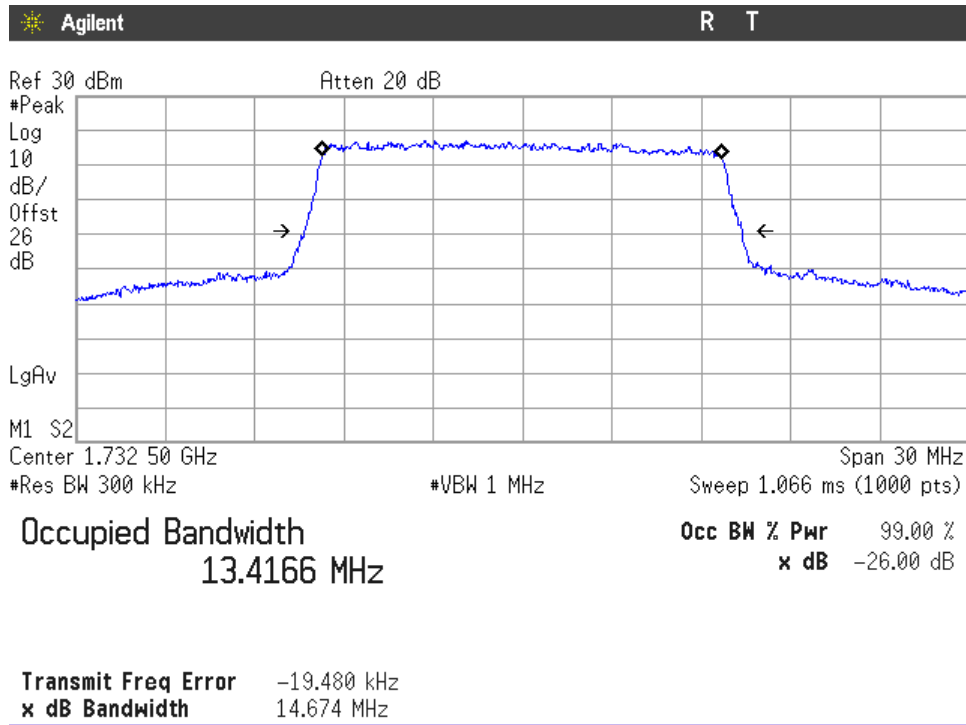

Highest Channel:

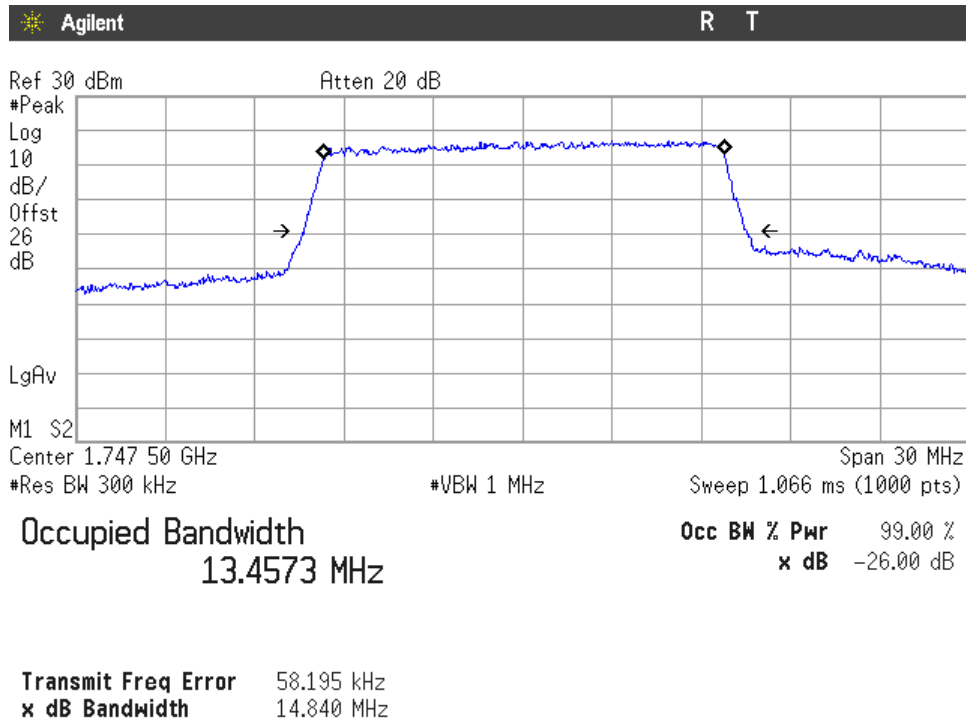

LTE Band 4. QPSK MODULATION. BW = 20 MHz.

Lowest Channel:

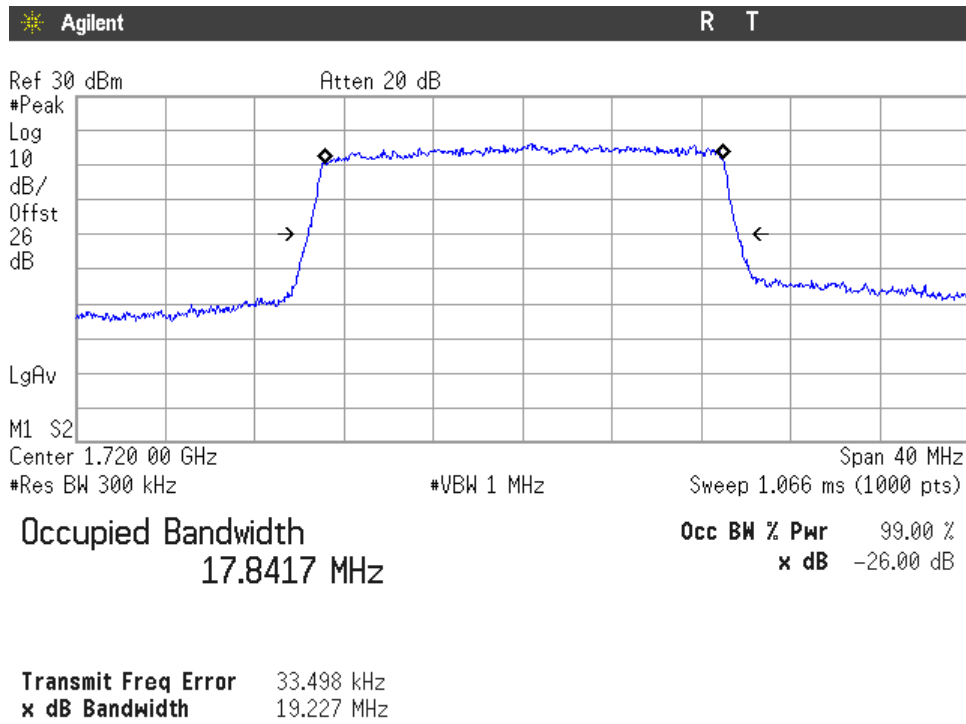

Middle Channel:

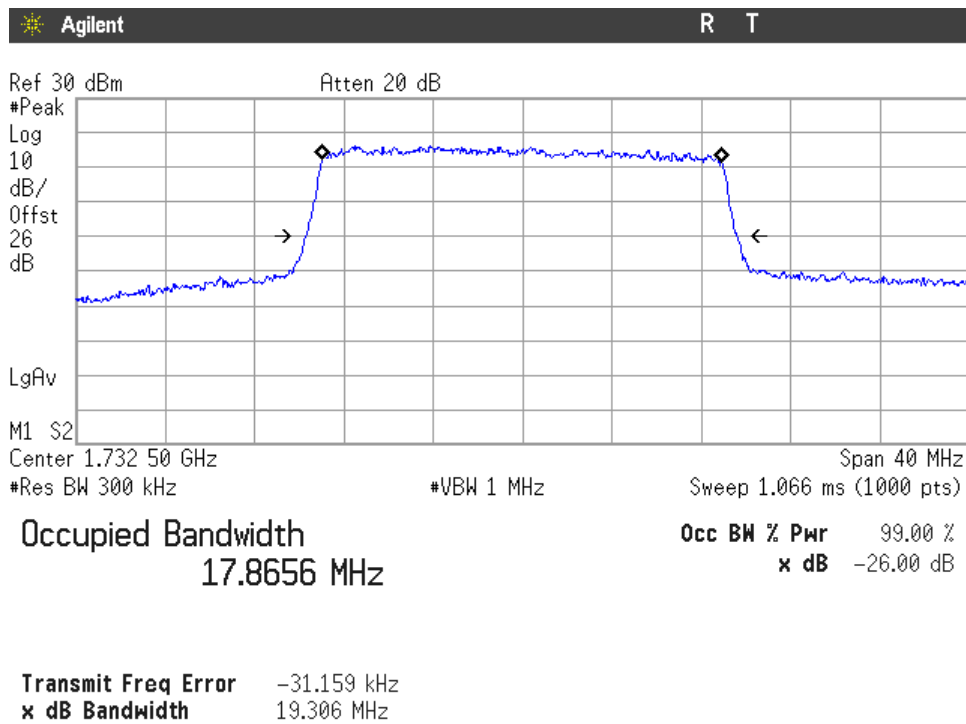

Highest Channel:

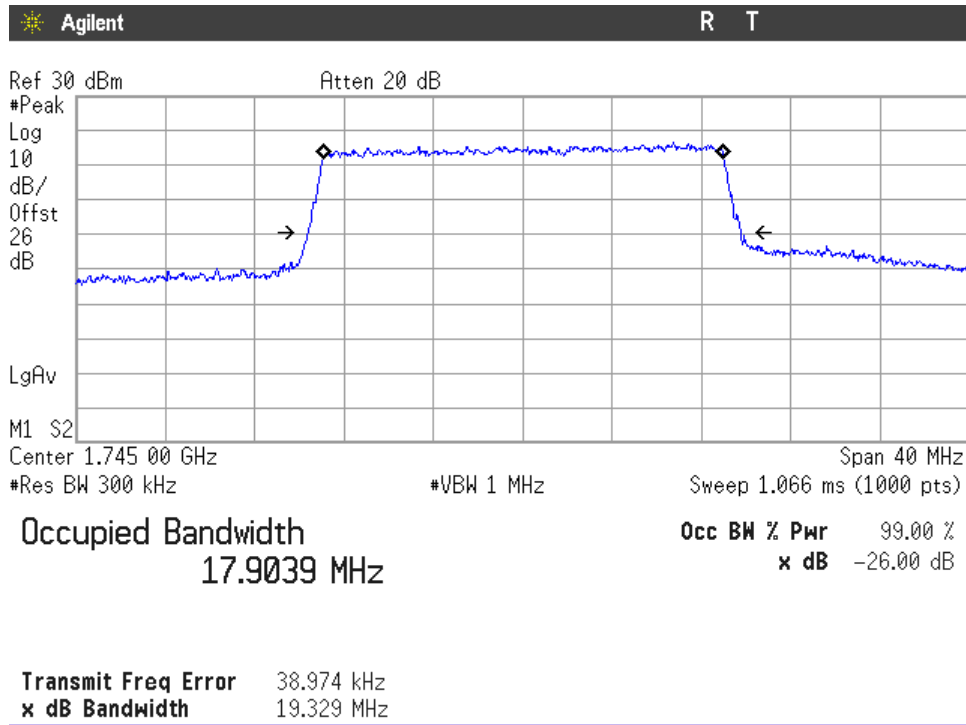

Spurious emissions at antenna terminals

SPECIFICATION:

FCC §27.53 (h):

According to specification, the power of emissions shall be attenuated below the transmitter power (P) by a factor of at least $43 + 10 \log (P)$ dB. P in watts.

RSS-139 Clause 6.6:

According to specification, the power of emissions shall be attenuated below the transmitter power (P) by a factor of at least $43 + 10 \log (P)$ dB. P in watts.

At P_o transmitting power, the specified minimum attenuation becomes $43+10 \log (P_o)$, and the level in dBm relative P_o becomes:

$$P_o \text{ (dBm)} - [43 + 10 \log (P_o \text{ in mwatts}) - 30] = -13 \text{ dBm.}$$

METHOD:

The EUT RF output connector was connected to a spectrum analyser and to the Universal Radio Communication tester R&S CMW500 (selecting maximum transmission power of the EUT and different modes of modulation) using a 50 Ohm attenuator and a power divider.

The spectrum was investigated from 9 kHz to 18 GHz for 3G Band IV and LTE Band 4. The reading of the spectrum analyser is corrected with the attenuation loss of connection between output terminal of EUT and input of the spectrum analyser.

The configuration of Resource Blocks and modulation which is the worst case for conducted power was used.

TEST SETUP:

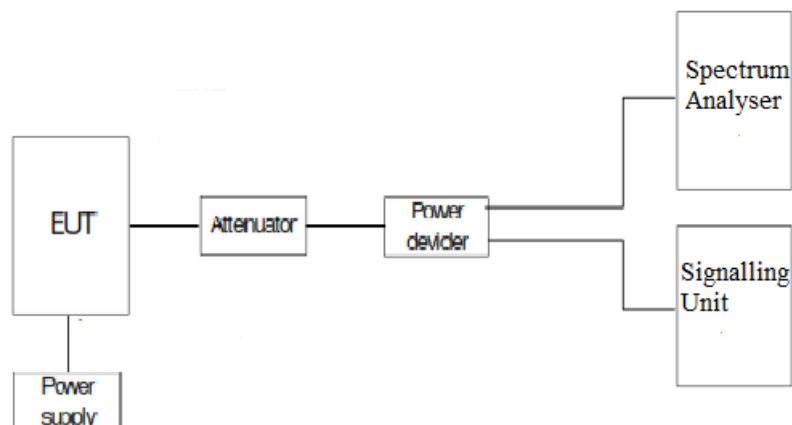

RESULTS:

3G Band IV. WCDMA MODULATION.

- Lowest Channel:

Spurious frequencies detected at less than 20 dB below the limit:

| Frequency (MHz) | Emission limitations conducted (dBm) |
|-----------------|--------------------------------------|
| 5139.309 | -31.73 |

- Middle Channel:

No spurious frequencies detected at less than 20 dB below the limit in all the range.

- Highest Channel:

Spurious frequencies detected at less than 20 dB below the limit:

| Frequency (MHz) | Emission limitations conducted (dBm) |
|-----------------|--------------------------------------|
| 5253.909 | -31.56 |

Verdict: PASS

3G Band IV. HSUPA MODULATION.

- Lowest Channel:

Spurious frequencies detected at less than 20 dB below the limit:

| Frequency (MHz) | Emission limitations conducted (dBm) |
|-----------------|--------------------------------------|
| 5133.909 | -32.54 |

- Middle Channel:

No spurious frequencies detected at less than 20 dB below the limit in all the range.

- Highest Channel:

No spurious frequencies detected at less than 20 dB below the limit in all the range.

Verdict: PASS

LTE BANDS: Test performed on the worst-case modulation and worst RB and worst Offset for all the nominal BW of each LTE band.

LTE Band 4. QPSK MODULATION. BW = 1.4 MHz.

- Lowest Channel:

Spurious frequencies detected at less than 20 dB below the limit:

| Frequency (MHz) | Emission limitations conducted (dBm) |
|-----------------|--------------------------------------|
| 5131.2 | -23.12 |

- Middle Channel:

Spurious frequencies detected at less than 20 dB below the limit:

| Frequency (MHz) | Emission limitations conducted (dBm) |
|-----------------|--------------------------------------|
| 5197.2 | -28.25 |

- Highest Channel:

Spurious frequencies detected at less than 20 dB below the limit:

| Frequency (MHz) | Emission limitations conducted (dBm) |
|-----------------|--------------------------------------|
| 5260.9 | -27.63 |

LTE Band 4. QPSK MODULATION. BW = 3 MHz.

- Lowest Channel:

Spurious frequencies detected at less than 20 dB below the limit:

| Frequency (MHz) | Emission limitations conducted (dBm) |
|-----------------|--------------------------------------|
| 5135.6 | -25.14 |

- Middle Channel:

Spurious frequencies detected at less than 20 dB below the limit:

| Frequency (MHz) | Emission limitations conducted (dBm) |
|-----------------|--------------------------------------|
| 5197.2 | -27 |

- Highest Channel:

Spurious frequencies detected at less than 20 dB below the limit:

| Frequency (MHz) | Emission limitations conducted (dBm) |
|-----------------|--------------------------------------|
| 5260.9 | -28.09 |

LTE Band 4. QPSK MODULATION. BW = 5 MHz.

- Lowest Channel:

Spurious frequencies detected at less than 20 dB below the limit:

| Frequency (MHz) | Emission limitations conducted (dBm) |
|-----------------|--------------------------------------|
| 5144.4 | -26.22 |

- Middle Channel:

Spurious frequencies detected at less than 20 dB below the limit:

| Frequency (MHz) | Emission limitations conducted (dBm) |
|-----------------|--------------------------------------|
| 5203.8 | -26.91 |

- Highest Channel:

Spurious frequencies detected at less than 20 dB below the limit:

| Frequency (MHz) | Emission limitations conducted (dBm) |
|-----------------|--------------------------------------|
| 5263.1 | -28.74 |

LTE Band 4. QPSK MODULATION. BW = 10 MHz.

- Lowest Channel:

Spurious frequencies detected at less than 20 dB below the limit:

| Frequency (MHz) | Emission limitations conducted (dBm) |
|-----------------|--------------------------------------|
| 5157.6 | -26.5 |

- Middle Channel:

Spurious frequencies detected at less than 20 dB below the limit:

| Frequency (MHz) | Emission limitations conducted (dBm) |
|-----------------|--------------------------------------|
| 5210.4 | -26.25 |

- Highest Channel:

Spurious frequencies detected at less than 20 dB below the limit:

| Frequency (MHz) | Emission limitations conducted (dBm) |
|-----------------|--------------------------------------|
| 5263.1 | -28.14 |

LTE Band 4. QPSK MODULATION. BW = 15 MHz.

- Lowest Channel:

Spurious frequencies detected at less than 20 dB below the limit:

| Frequency (MHz) | Emission limitations conducted (dBm) |
|-----------------|--------------------------------------|
| 5173 | -27.89 |

- Middle Channel:

Spurious frequencies detected at less than 20 dB below the limit:

| Frequency (MHz) | Emission limitations conducted (dBm) |
|-----------------|--------------------------------------|
| 5217 | -26.27 |

- Highest Channel:

Spurious frequencies detected at less than 20 dB below the limit:

| Frequency (MHz) | Emission limitations conducted (dBm) |
|-----------------|--------------------------------------|
| 5263.1 | -28.26 |

LTE Band 4. QPSK MODULATION. BW = 20 MHz.

- Lowest Channel:

Spurious frequencies detected at less than 20 dB below the limit:

| Frequency (MHz) | Emission limitations conducted (dBm) |
|-----------------|--------------------------------------|
| 5133.4 | -25.01 |

- Middle Channel:

Spurious frequencies detected at less than 20 dB below the limit:

| Frequency (MHz) | Emission limitations conducted (dBm) |
|-----------------|--------------------------------------|
| 5170.8 | -29.09 |

- Highest Channel:

Spurious frequencies detected at less than 20 dB below the limit:

| Frequency (MHz) | Emission limitations conducted (dBm) |
|-----------------|--------------------------------------|
| 5208.2 | -26.58 |

| | |
|------------------------------|--------|
| Measurement uncertainty (dB) | <±2.03 |
|------------------------------|--------|

Verdict: PASS

3G Band IV. WCDMA MODULATION.

Lowest Channel:

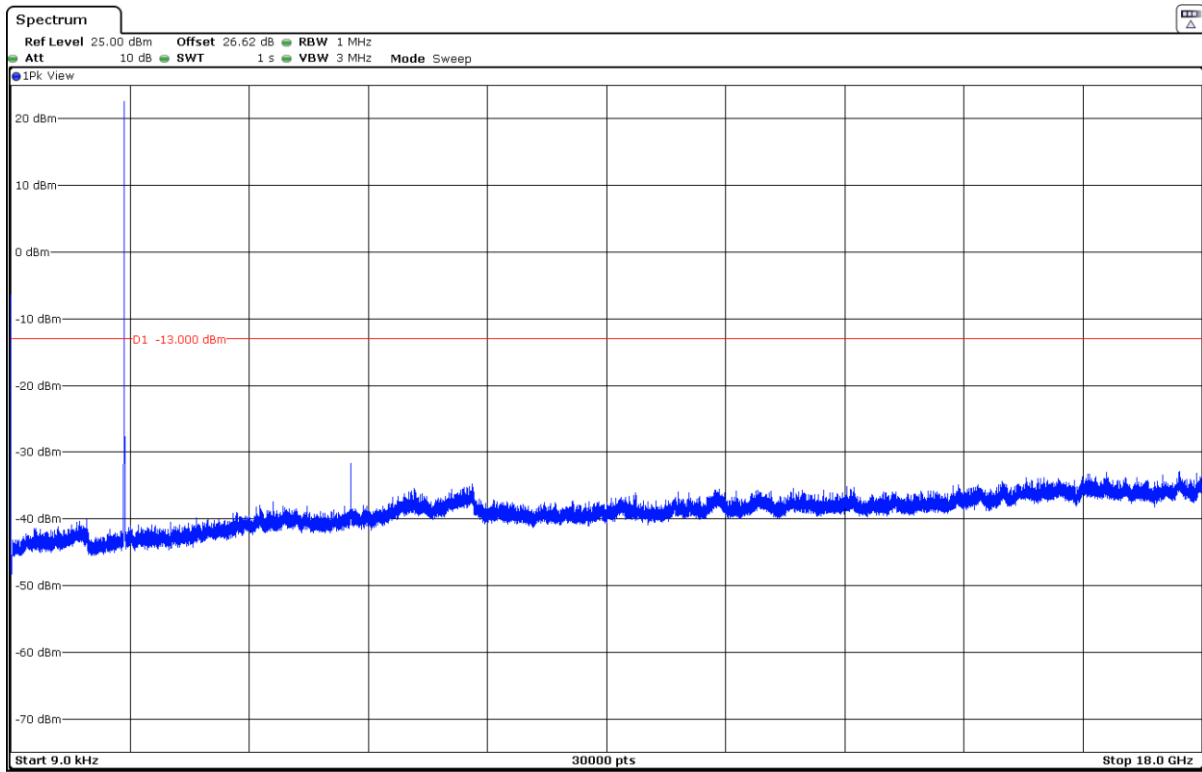

The peak above the limit is the carrier frequency.

Middle Channel:

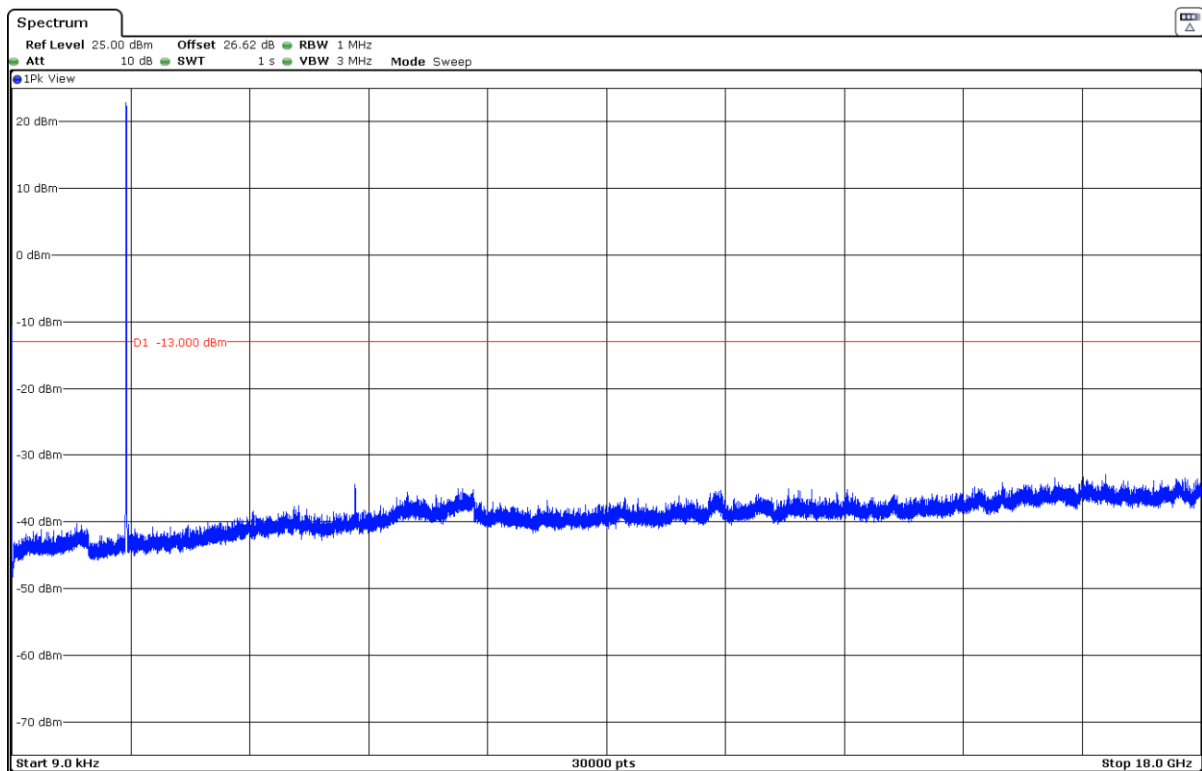

The peak above the limit is the carrier frequency.

Highest Channel:

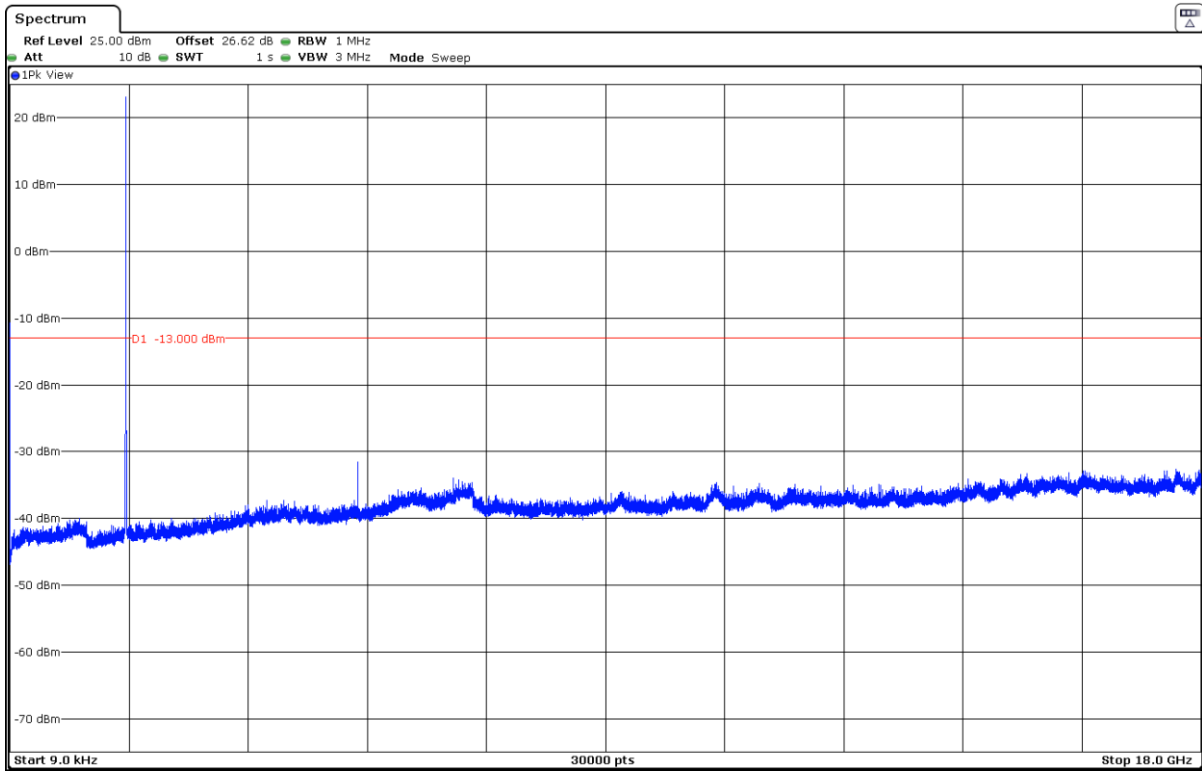

3G Band IV. HSUPA MODULATION.

Lowest Channel:

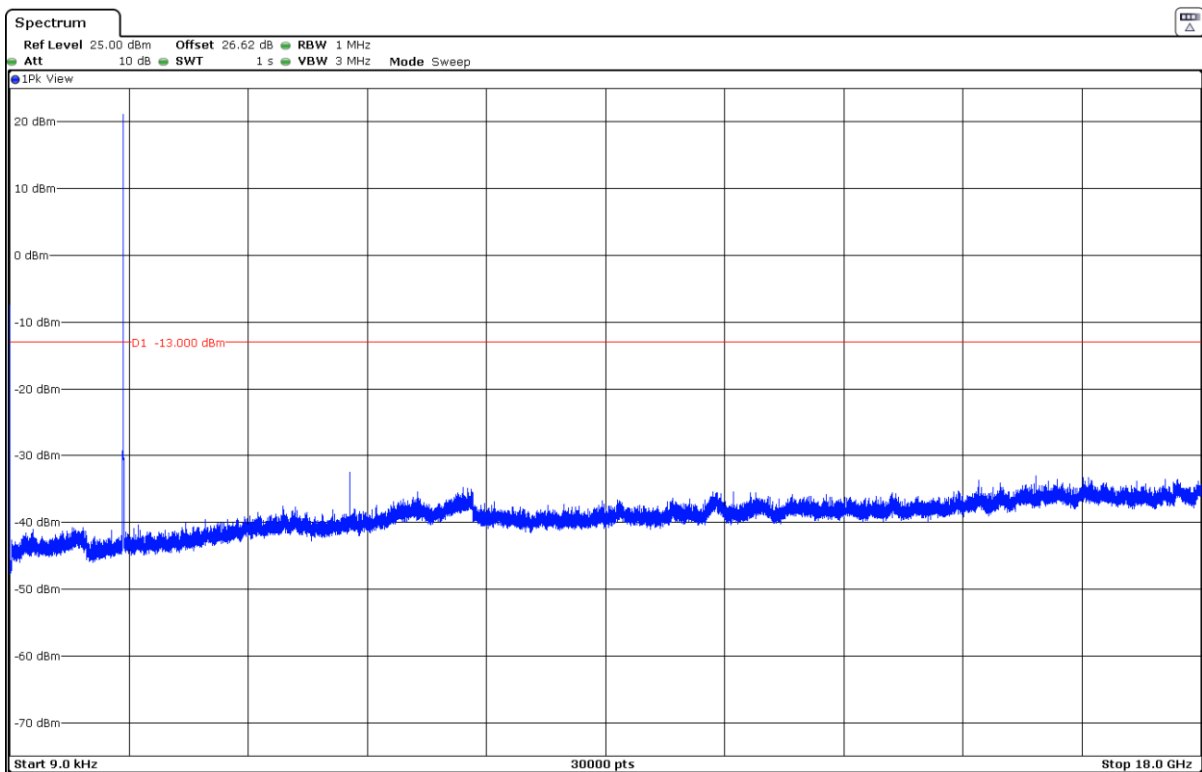

The peak above the limit is the carrier frequency.

Middle Channel:

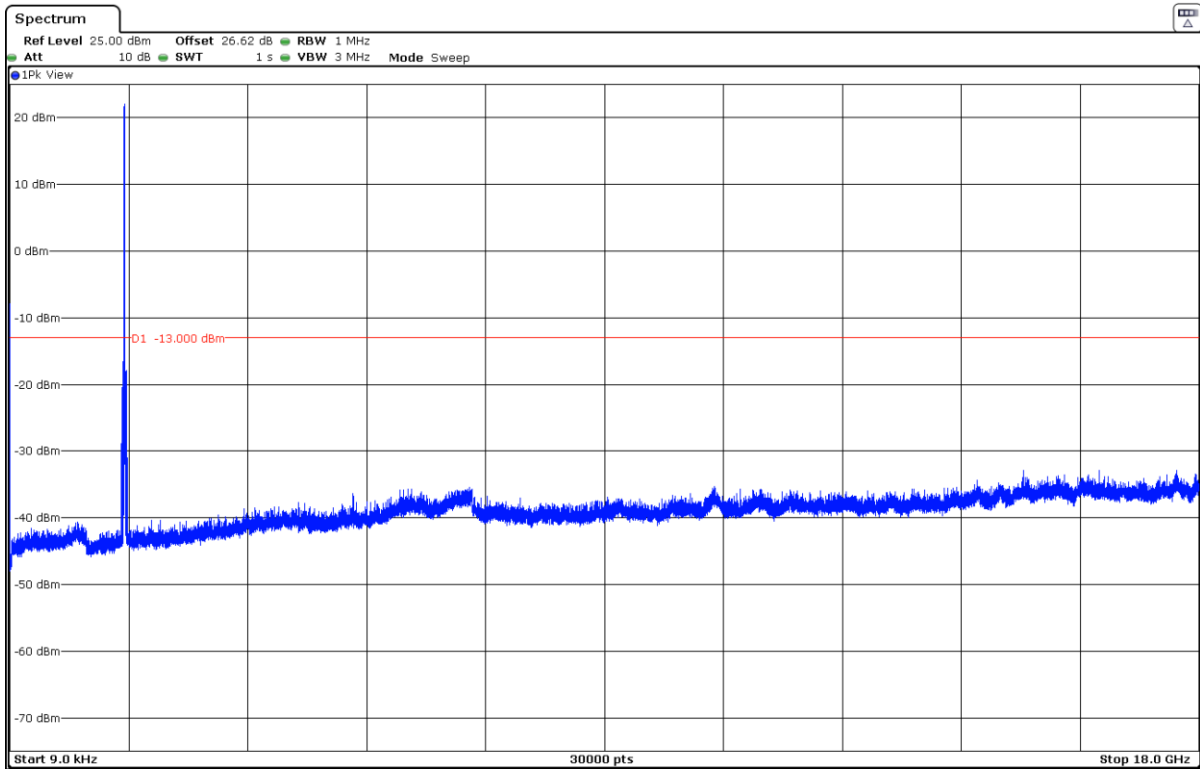

The peak above the limit is the carrier frequency.

Highest Channel:

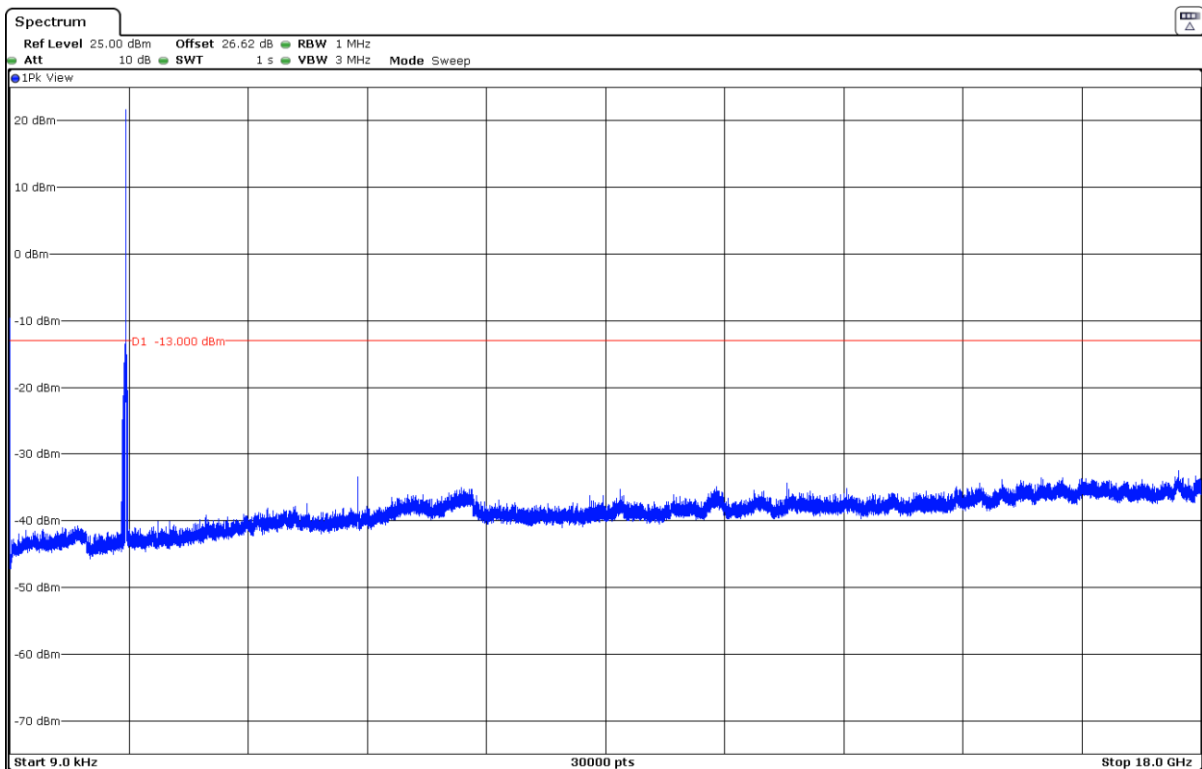

The peak above the limit is the carrier frequency.

LTE Band 4. QPSK MODULATION. BW = 1.4 MHz.

Lowest Channel:

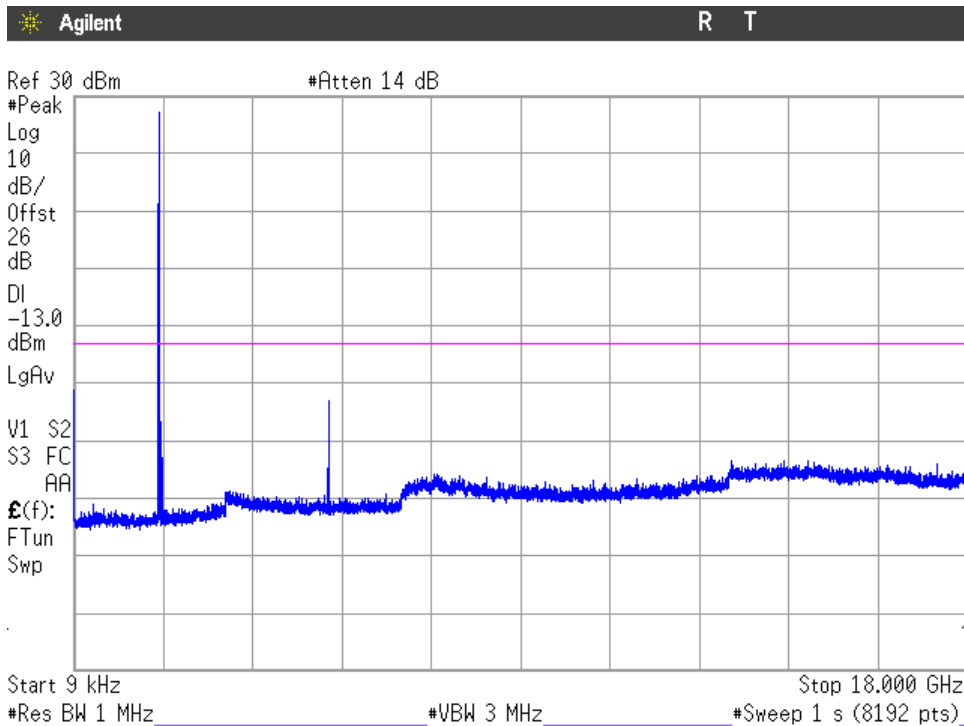

The peak above the limit is the carrier frequency.

Middle Channel:

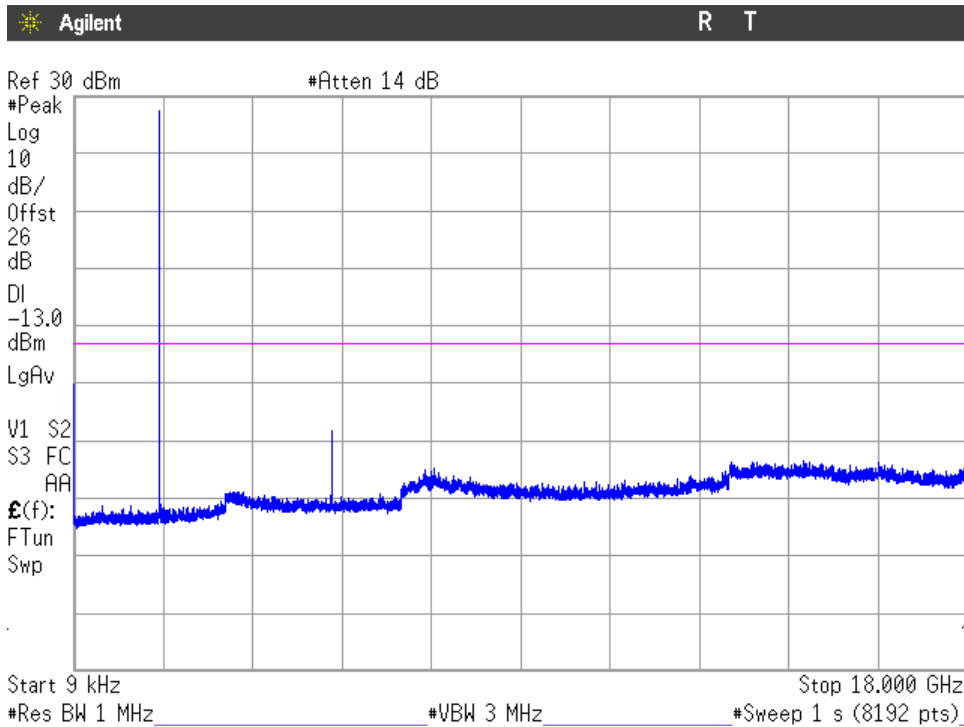

The peak above the limit is the carrier frequency.

Highest Channel:

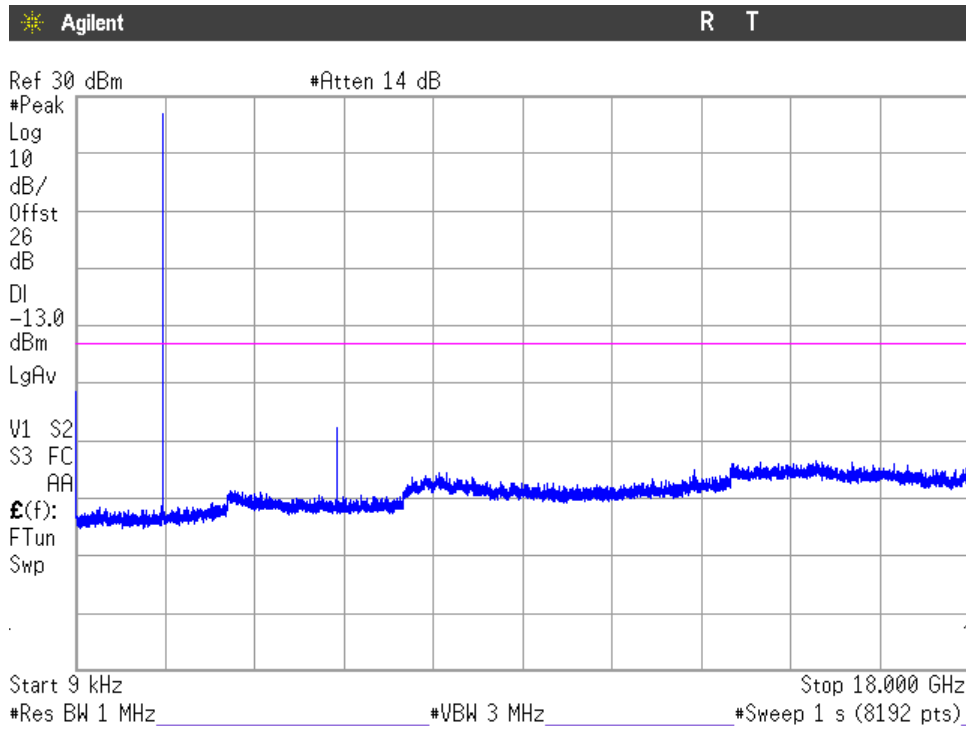

The peak above the limit is the carrier frequency.

LTE Band 4. QPSK MODULATION. BW = 3 MHz.

Lowest Channel:

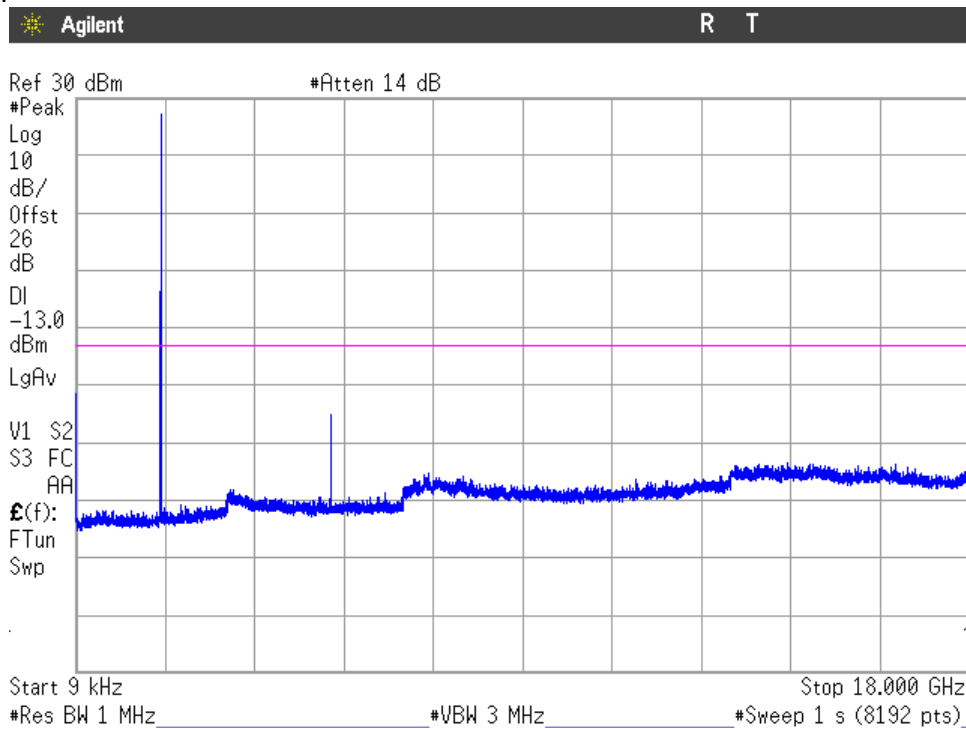

The peak above the limit is the carrier frequency.

Middle Channel:

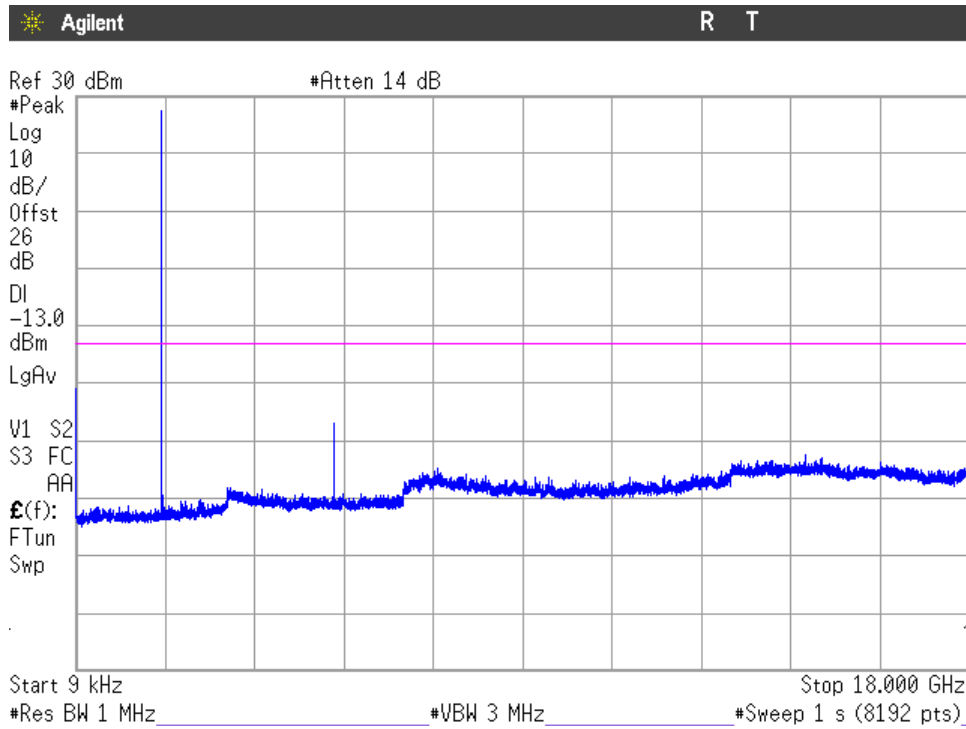

The peak above the limit is the carrier frequency.

Highest Channel:

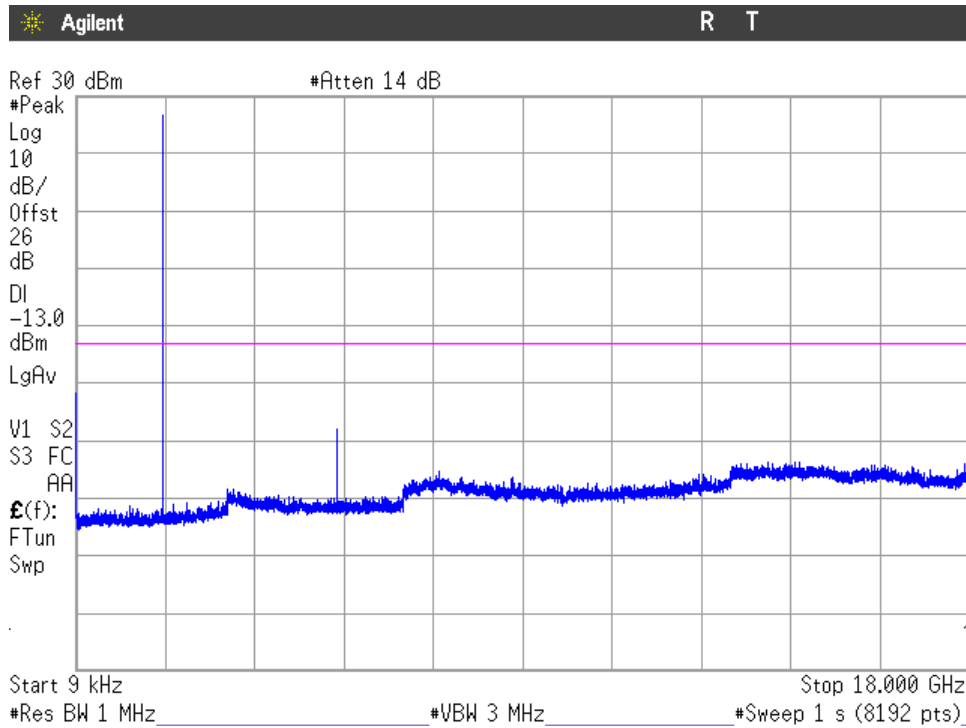

The peak above the limit is the carrier frequency.

LTE Band 4. QPSK MODULATION. BW = 5 MHz.

Lowest Channel:

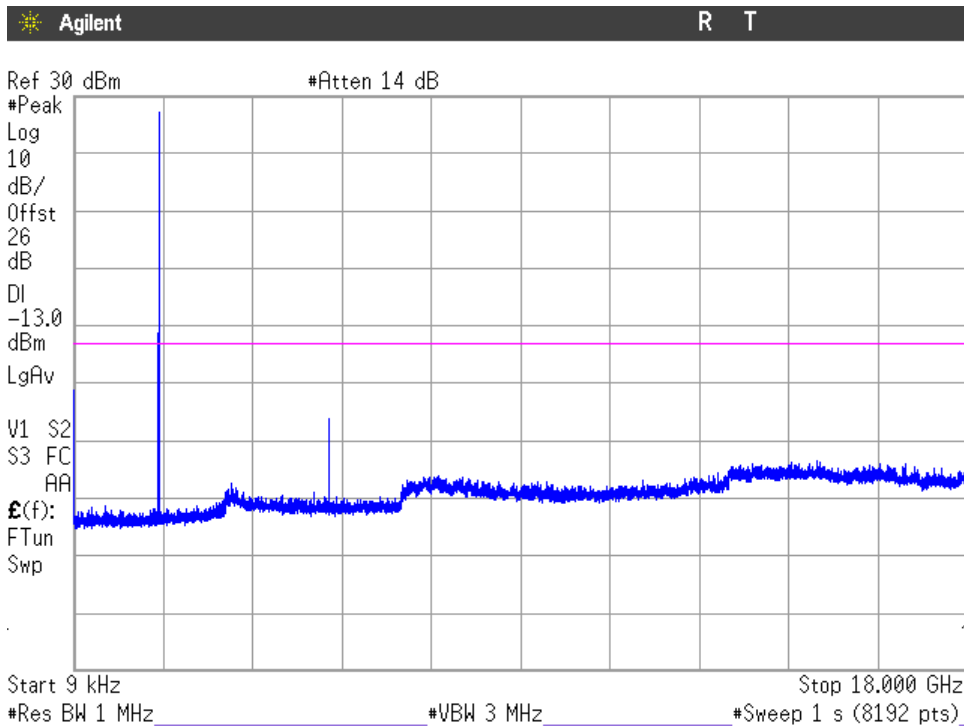

The peak above the limit is the carrier frequency.

Middle:

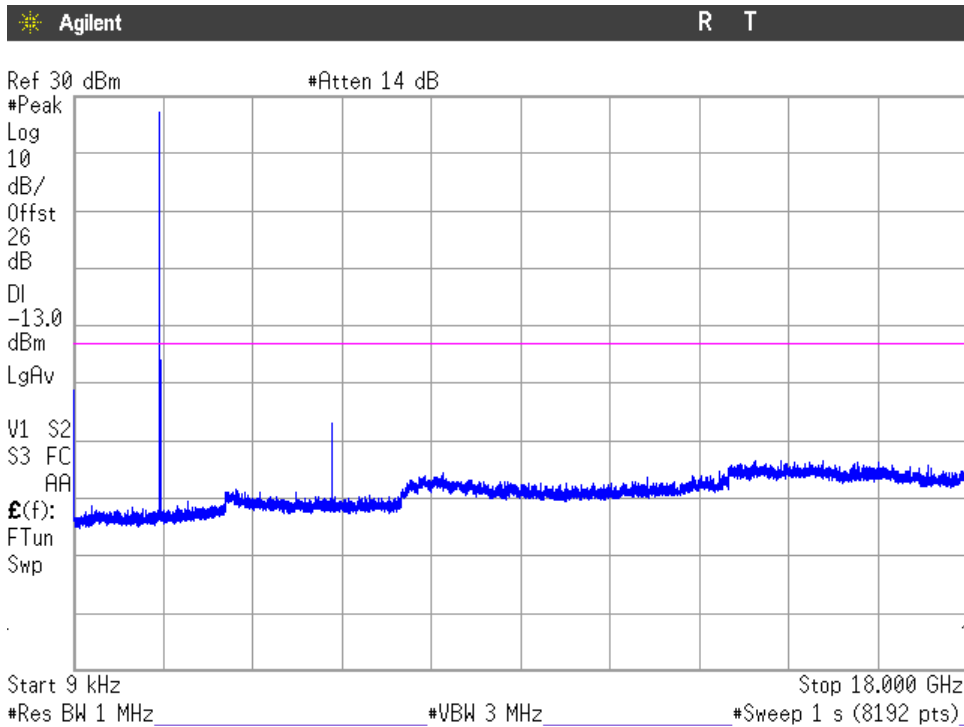

The peak above the limit is the carrier frequency.

Highest Channel:

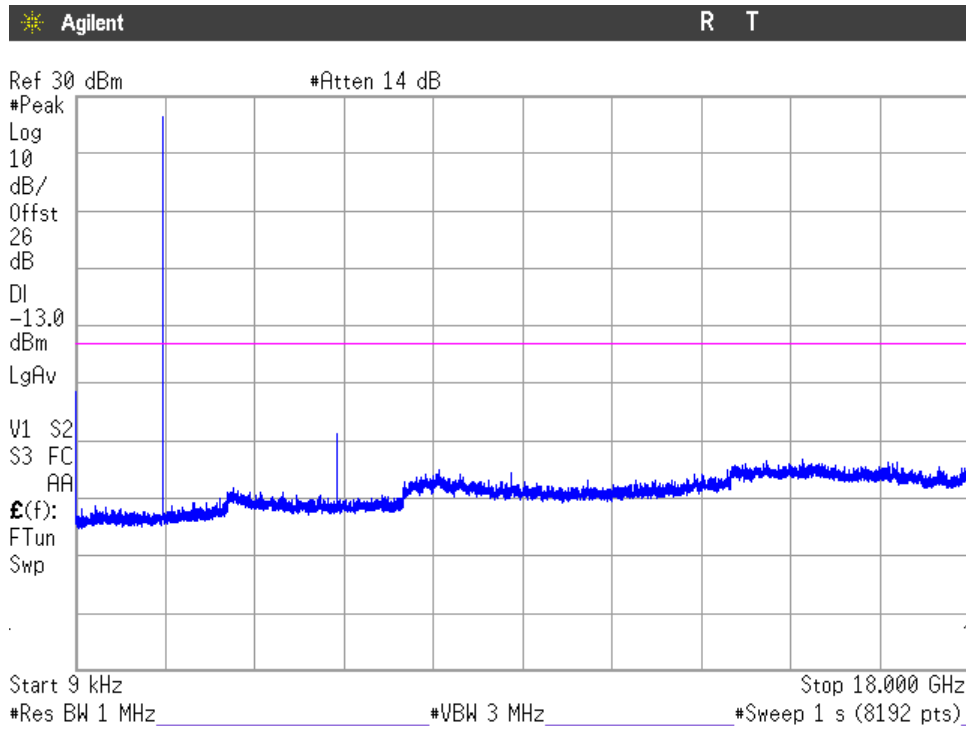

The peak above the limit is the carrier frequency.

LTE Band 4. QPSK MODULATION. BW = 10 MHz.

Lowest Channel:

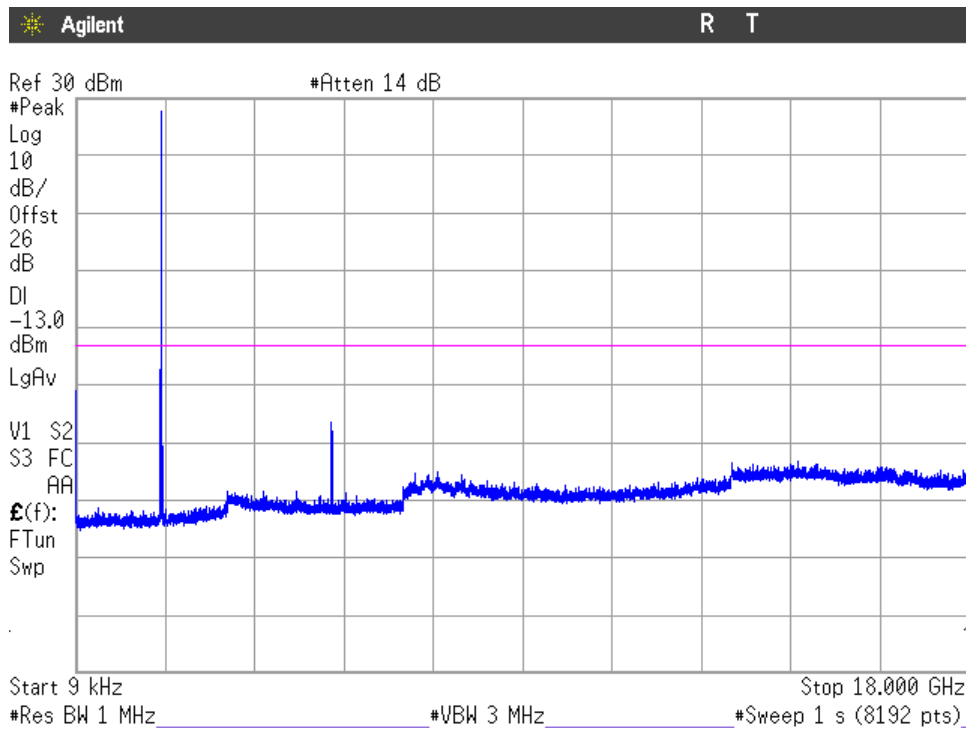

The peak above the limit is the carrier frequency.

Middle Channel:

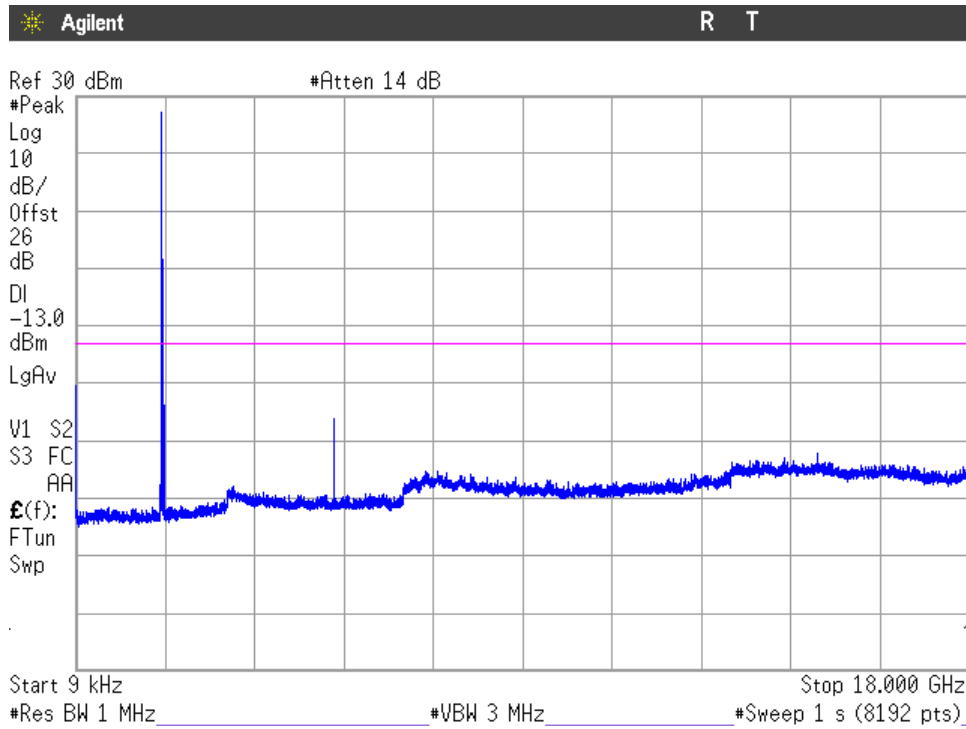

The peak above the limit is the carrier frequency.

Highest Channel:

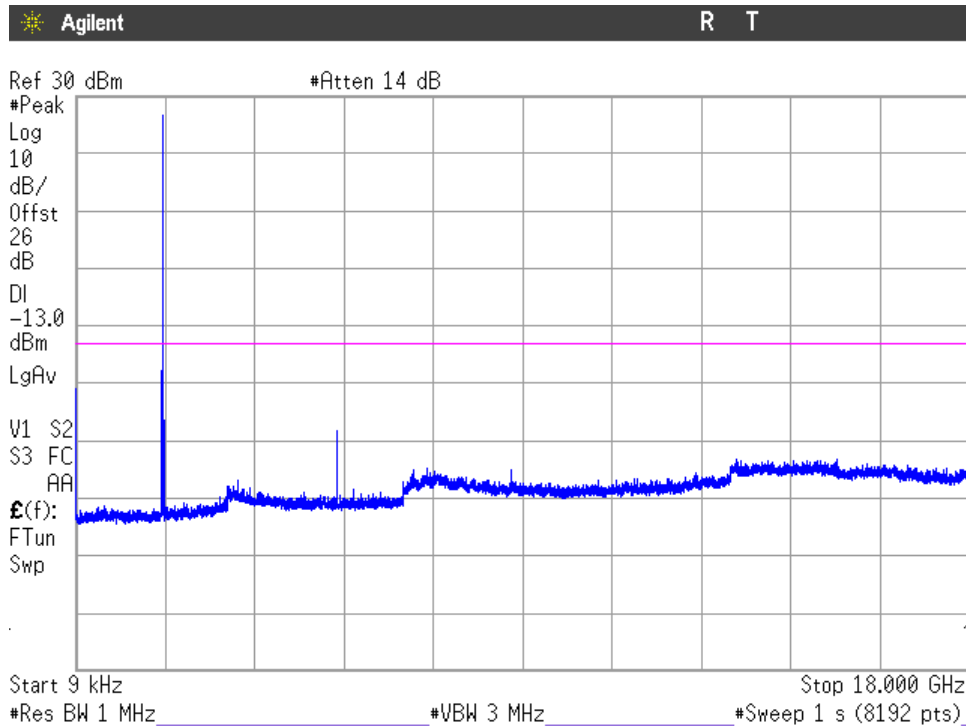

The peak above the limit is the carrier frequency.

LTE Band 4. QPSK MODULATION. BW = 15 MHz.

Lowest Channel:

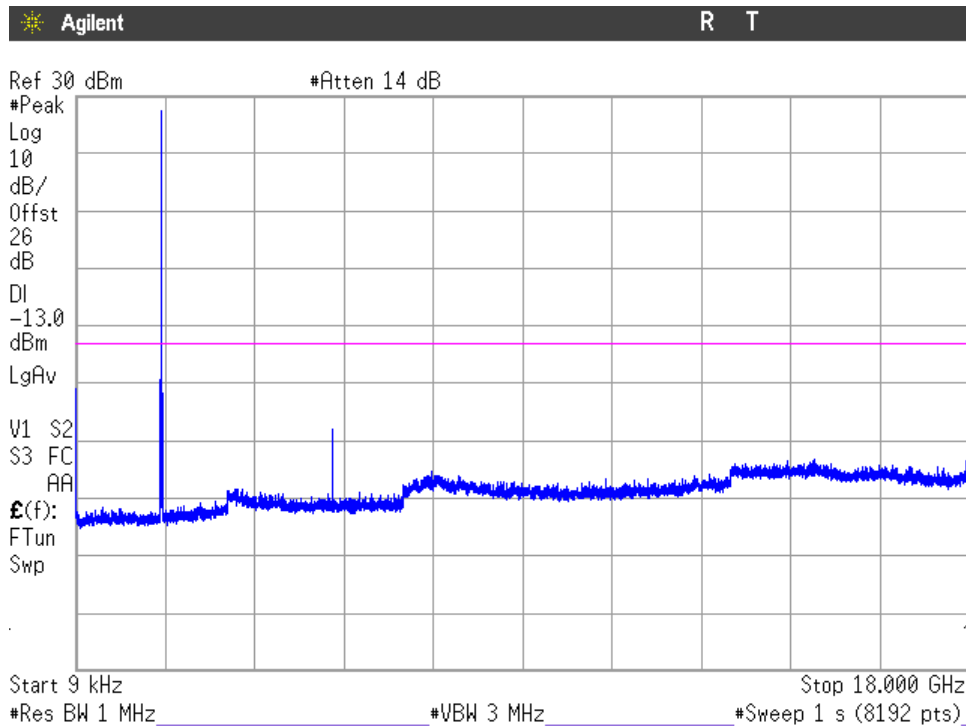

The peak above the limit is the carrier frequency.

Middle Channel:

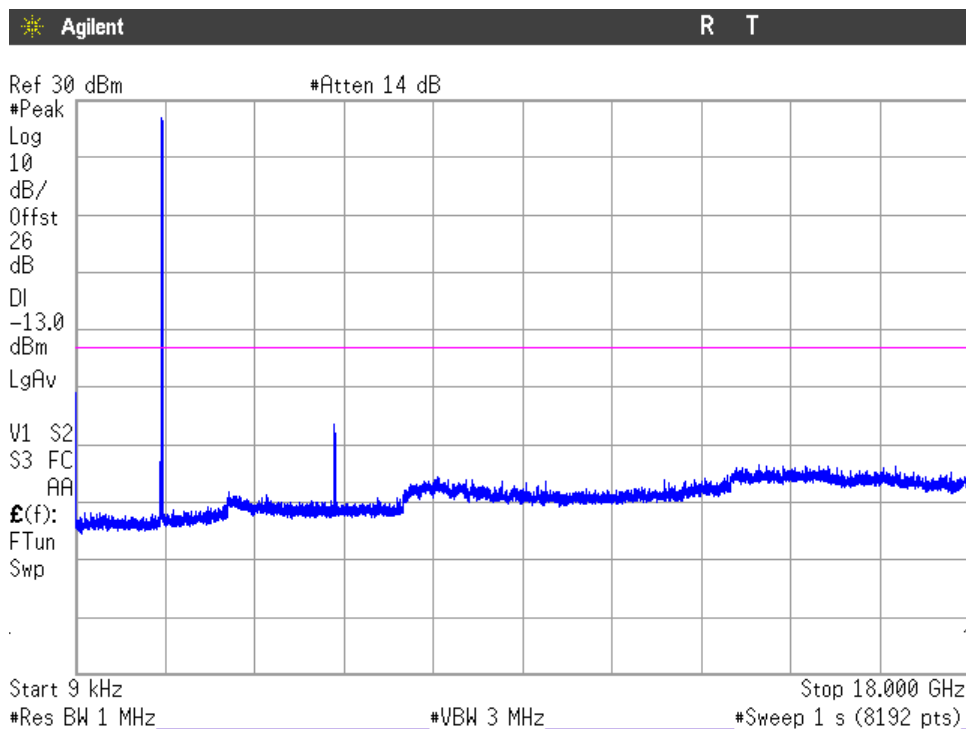

The peak above the limit is the carrier frequency.

Highest Channel:

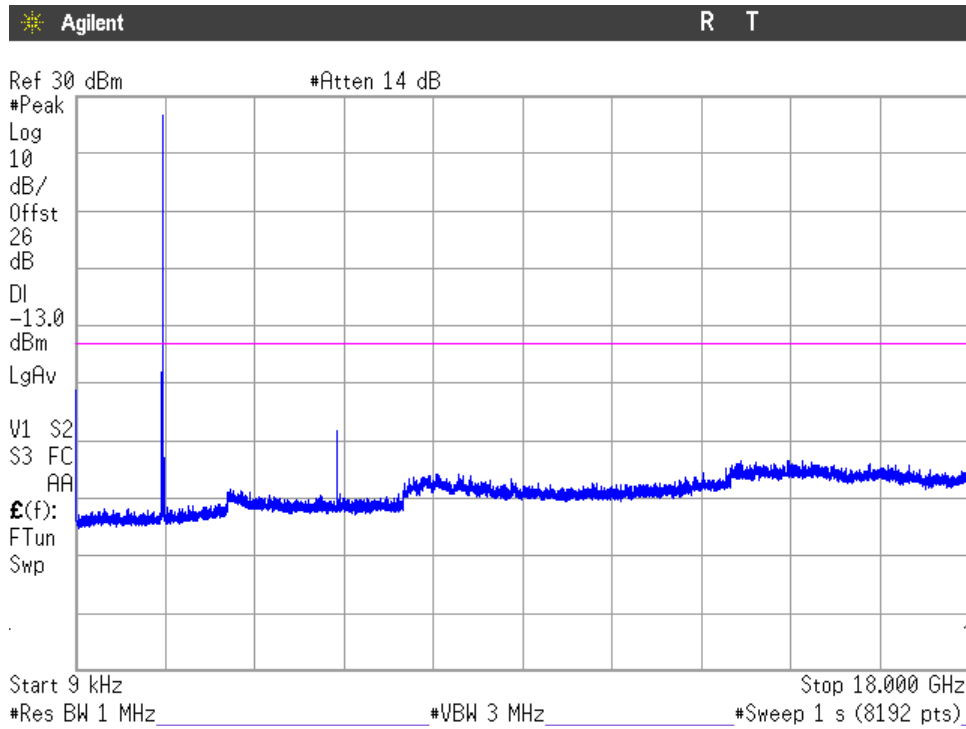

The peak above the limit is the carrier frequency.

LTE Band 4. QPSK MODULATION. BW = 20 MHz.

Lowest Channel:

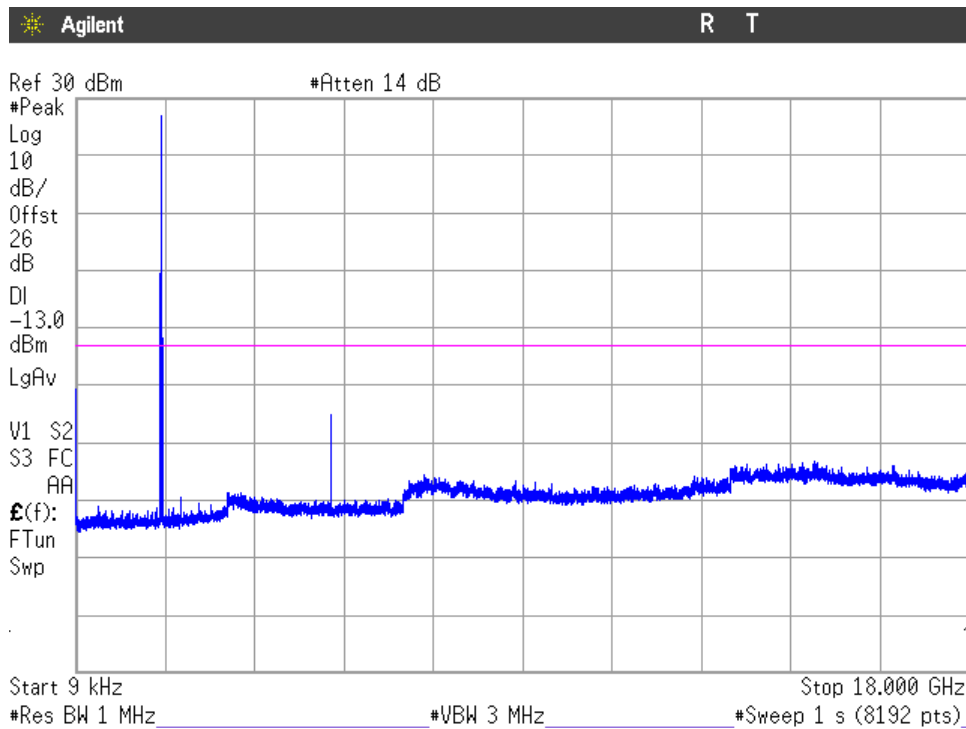

The peak above the limit is the carrier frequency.

Middle Channel:

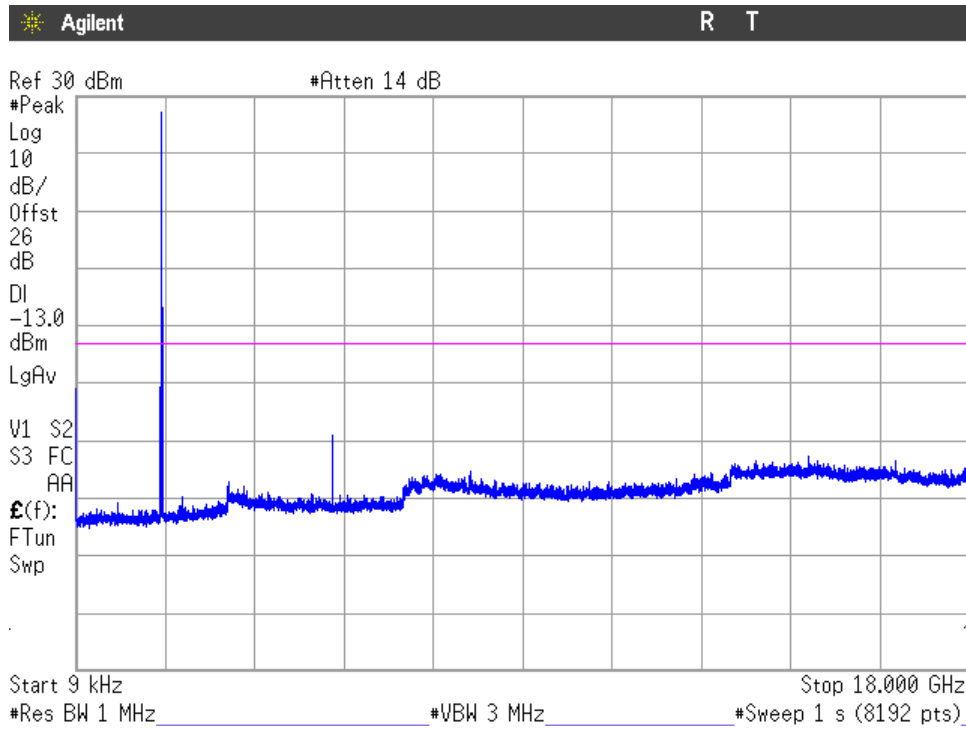

The peak above the limit is the carrier frequency.

Highest Channel:

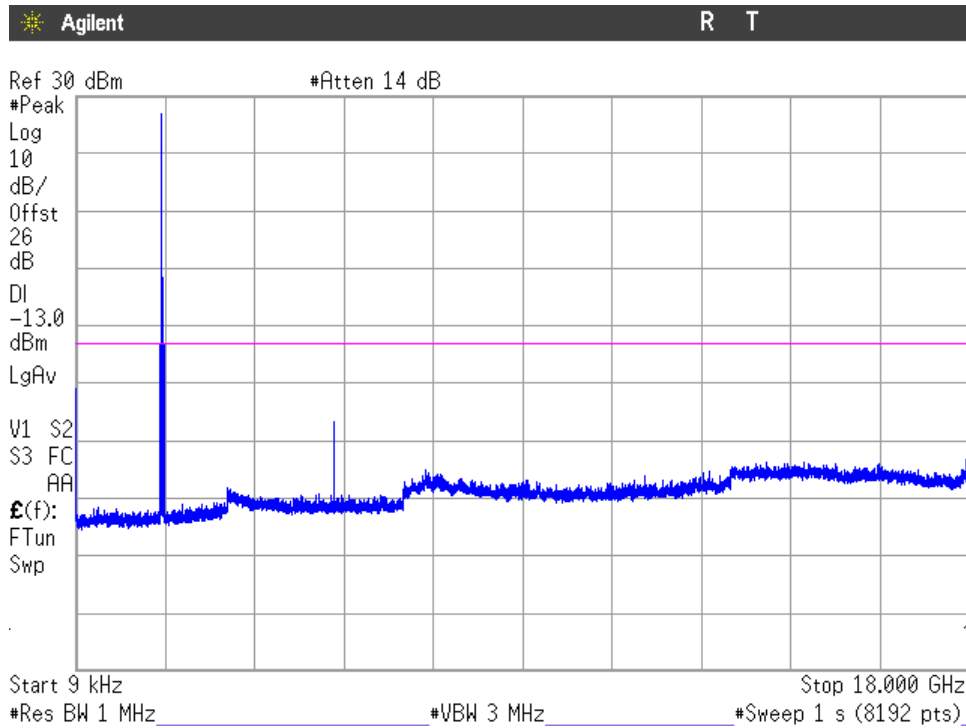

The peak above the limit is the carrier frequency.

Spurious emissions at antenna terminals at Block Edges

SPECIFICATION:

FCC §27.53 (h):

According to specification. the power of emissions shall be attenuated below the transmitter power (P) by a factor of at least $43 + 10 \log (P)$ dB. P in watts.

At P_o transmitting power. the specified minimum attenuation becomes $43+10\log (P_o)$. and the level in dBm relative P_o becomes:

$$P_o \text{ (dBm)} - [43 + 10 \log (P_o \text{ in mwatts}) - 30] = -13 \text{ dBm}$$

RSS-139 Clause 6.6:

In the first 1.0 MHz bands immediately outside and adjacent to the equipment's smallest operating frequency block, which can contain the equipment's occupied bandwidth, the emission power per any 1% of the emission bandwidth shall be attenuated below the transmitter output power P (in dBW) by at least $43 + 10 \log_{10} p$ (watts) dB.

After the first 1.0 MHz outside the equipment's smallest operating frequency block, which can contain the equipment's occupied bandwidth, the emission power in any 1 MHz bandwidth shall be attenuated below the transmitter output power P (in dBW) by at least $43 + 10 \log_{10} p$ (watts) dB.

METHOD:

The EUT RF output connector was connected to a spectrum analyser and to the Universal Radio Communication tester R&S CMW500 (selecting maximum transmission power of the EUT and different modes of modulation) using a 50 Ohm attenuator and a power splitter.

The reading of the spectrum analyser is corrected with the attenuation loss of connection between output terminal of EUT and input of the spectrum analyser.

The configuration of modulation which is the worst case for conducted power was used.

For WCDMA and LTE Band 4, as indicated in FCC part 27.53 (h) (5), in the 1 MHz bands immediately outside and adjacent to the licensee's frequency block, a resolution bandwidth of at least one percent of the emission bandwidth/occupied bandwidth of the fundamental emission of the transmitter may be employed.

TEST SETUP:

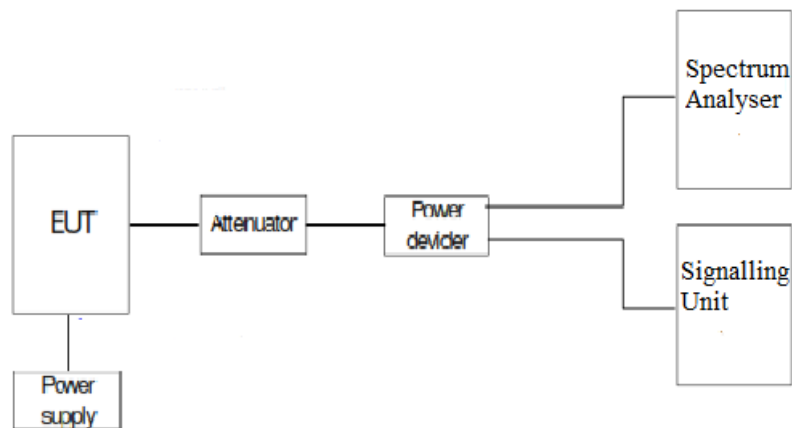

RESULTS:

3G Band IV. WCDMA and HSUPA MODULATIONS.

| MODULATION: | WCDMA | HSUPA |
|--|--------|--------|
| Maximum measured level at <u>Lowest Block Edge</u> at antenna port (dBm) | -28.74 | -29.94 |

| MODULATION: | WCDMA | HSUPA |
|---|--------|--------|
| Maximum measured level at <u>Highest Block Edge</u> at antenna port (dBm) | -29.71 | -29.62 |

LTE Band 4.

| LTE QPSK MODULATION: | RB=1, Offset=0, BW=1.4 MHz | RB=1, Offset=0, BW=3 MHz | RB=1, Offset=0, BW=5 MHz | RB=1, Offset =0, BW = 10 MHz | RB=1, Offset=0, BW=15 MHz | RB=1 , Offset =0, BW = 20 MHz |
|--|----------------------------------|--------------------------------|--------------------------------|------------------------------------|---------------------------------|-------------------------------------|
| Maximum measured level at <u>Lowest Block Edge</u> at antenna port (dBm) | -23.9 | -20.89 | -22.19 | -33.13 | -29.5 | -34.34 |

| LTE QPSK MODULATION: | RB=All, Offset=0, BW=1.4 MHz | RB=All, Offset=0, BW=3 MHz | RB=All, Offset=0, BW=5 MHz | RB=All, Offset =0, BW = 10 MHz | RB=All, Offset=0, BW=15 MHz | RB=All, Offset =0, BW = 20 MHz |
|--|------------------------------------|----------------------------------|----------------------------------|--------------------------------------|-----------------------------------|--------------------------------------|
| Maximum measured level at <u>Lowest Block Edge</u> at antenna port (dBm) | -30.26 | -27.57 | -30.3 | -35 | -33.32 | -37.04 |

| LTE QPSK MODULATION: | RB=1, Offset=Max, BW=1.4 MHz | RB=1, Offset=Max, BW=3 MHz | RB=1, Offset=Max, BW=5 MHz | RB=1, Offset =Max, BW = 10 MHz | RB=1, Offset=Max, BW=15 MHz | RB=1 , Offset =Max, BW = 20 MHz |
|---|------------------------------------|----------------------------------|----------------------------------|--------------------------------------|-----------------------------------|---------------------------------------|
| Maximum measured level at <u>Highest Block Edge</u> at antenna port (dBm) | -21.33 | -17.97 | -19.02 | -29.97 | -27.96 | -31.52 |

| LTE QPSK MODULATION: | RB=All, Offset=0, BW=1.4 MHz | RB=All, Offset=0, BW=3 MHz | RB=All, Offset=0, BW=5 MHz | RB=All, Offset =0, BW = 10 MHz | RB=All, Offset=0, BW=15 MHz | RB=All, Offset =0, BW = 20 MHz |
|---|------------------------------------|----------------------------------|----------------------------------|--------------------------------------|-----------------------------------|--------------------------------------|
| Maximum measured level at <u>Highest Block Edge</u> at antenna port (dBm) | -24.5 | -25.05 | -24.55 | -26.7 | -25.5 | -26.3 |

| | |
|------------------------------|--------|
| Measurement uncertainty (dB) | <±2.03 |
|------------------------------|--------|

Verdict: PASS

3G Band IV. WCDMA MODULATION.

Lowest Channel:

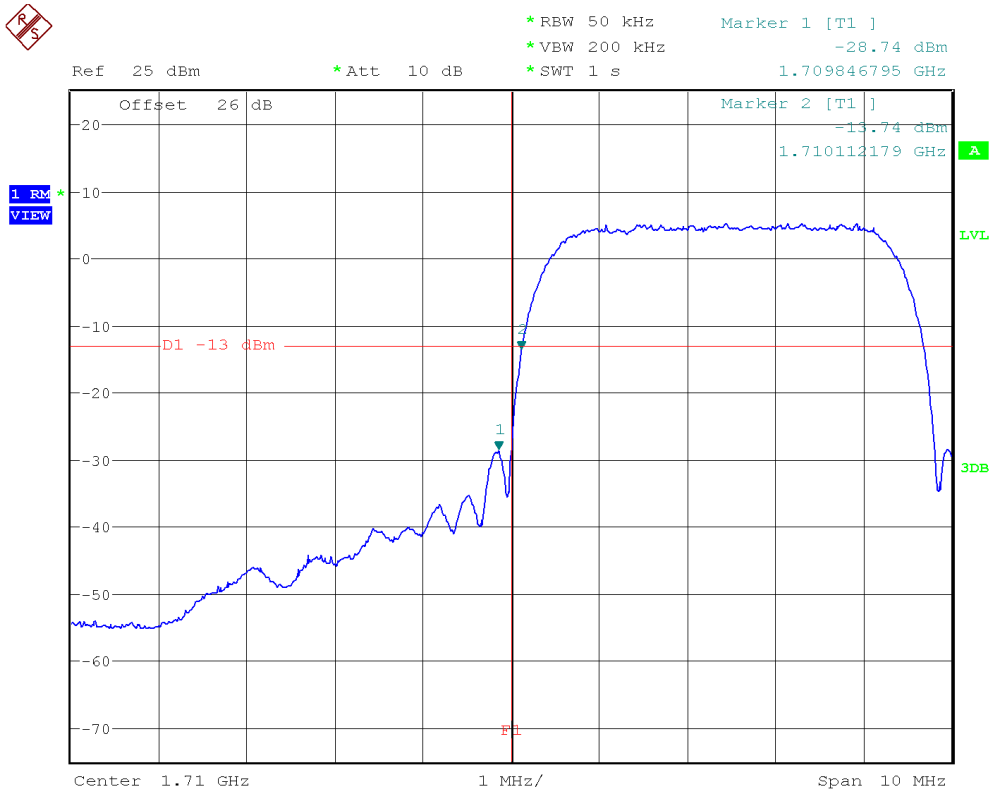

Highest Channel:

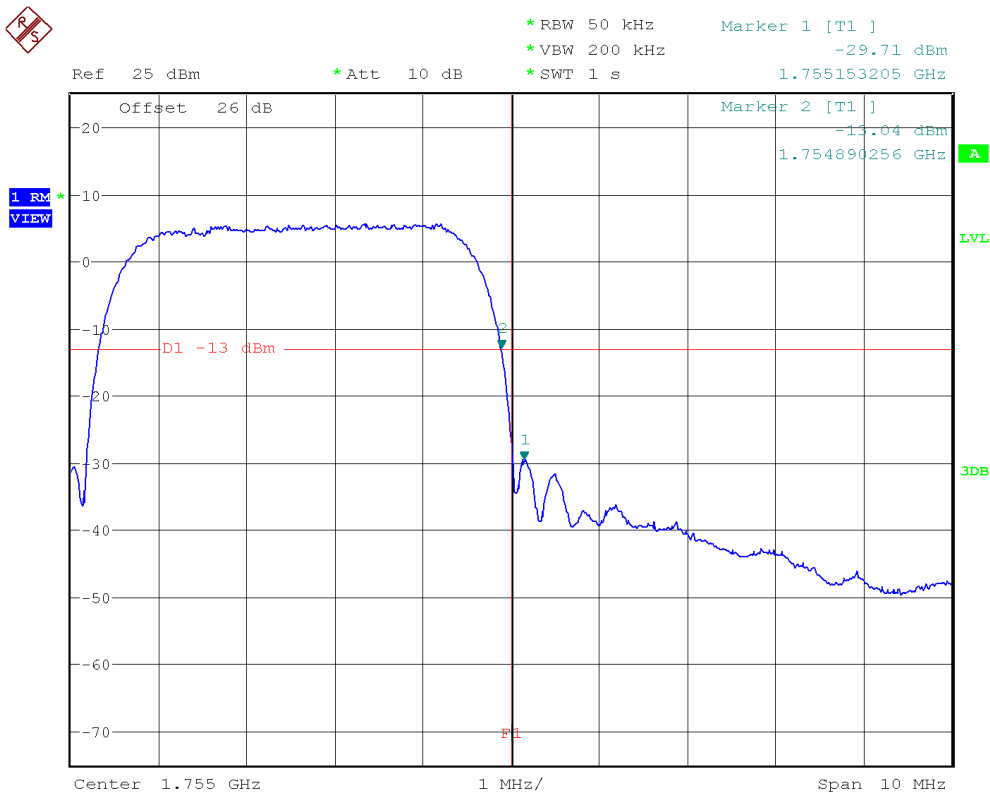

3G Band IV. HSUPA MODULATION.

Lowest Channel:

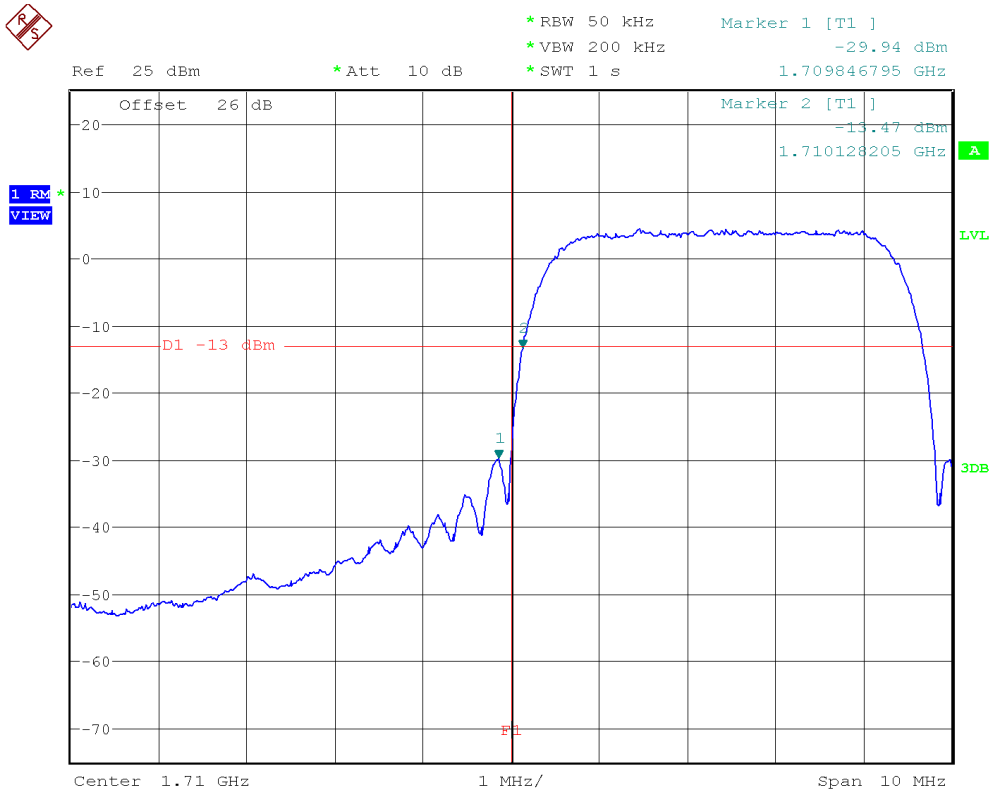

Highest Channel:

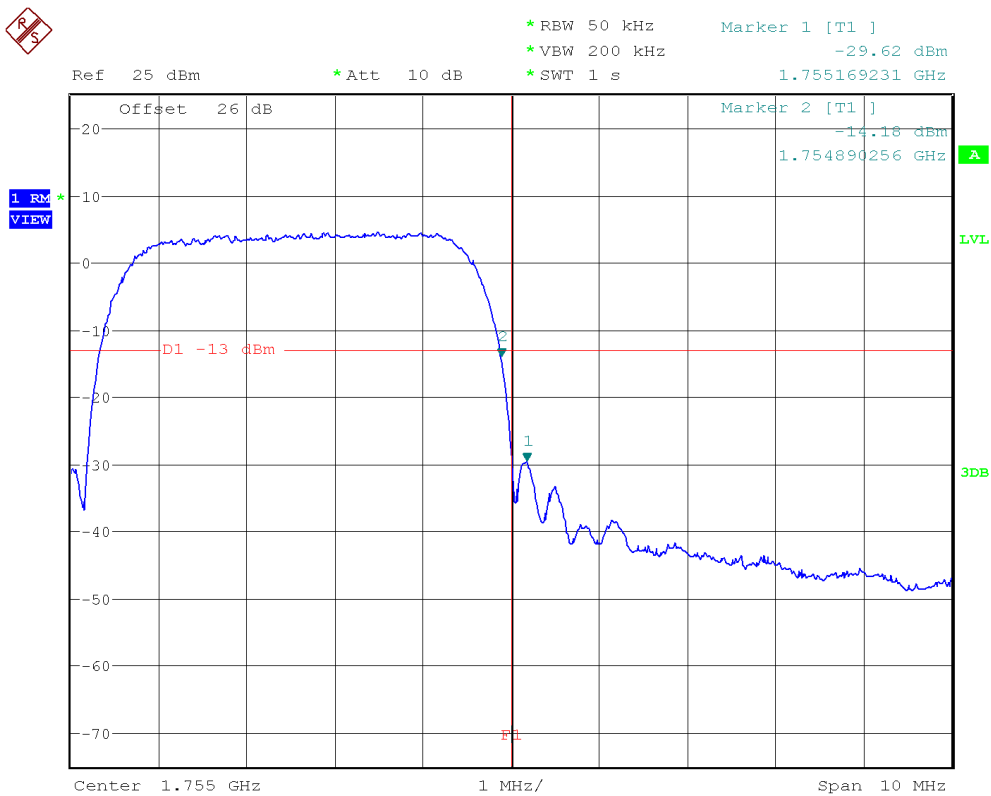

LTE Band 4. QPSK MODULATION. BW=1.4 MHz. RB=1. Offset=0. Lowest Block Edge:

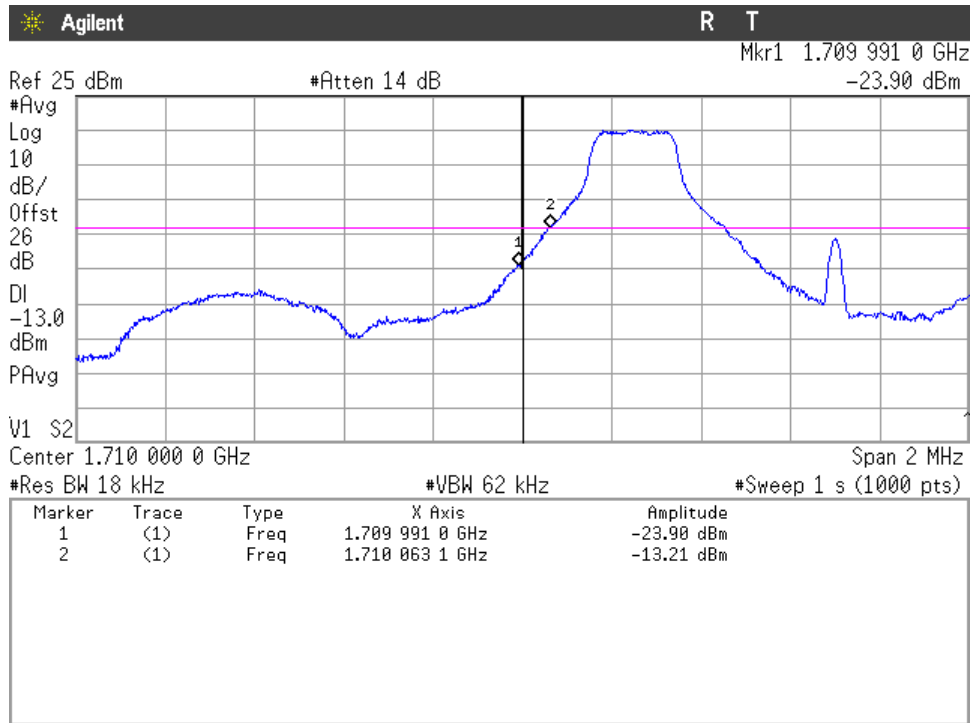

LTE Band 4. QPSK MODULATION. BW=1.4 MHz. RB=1. Offset=Max. Highest Block Edge:

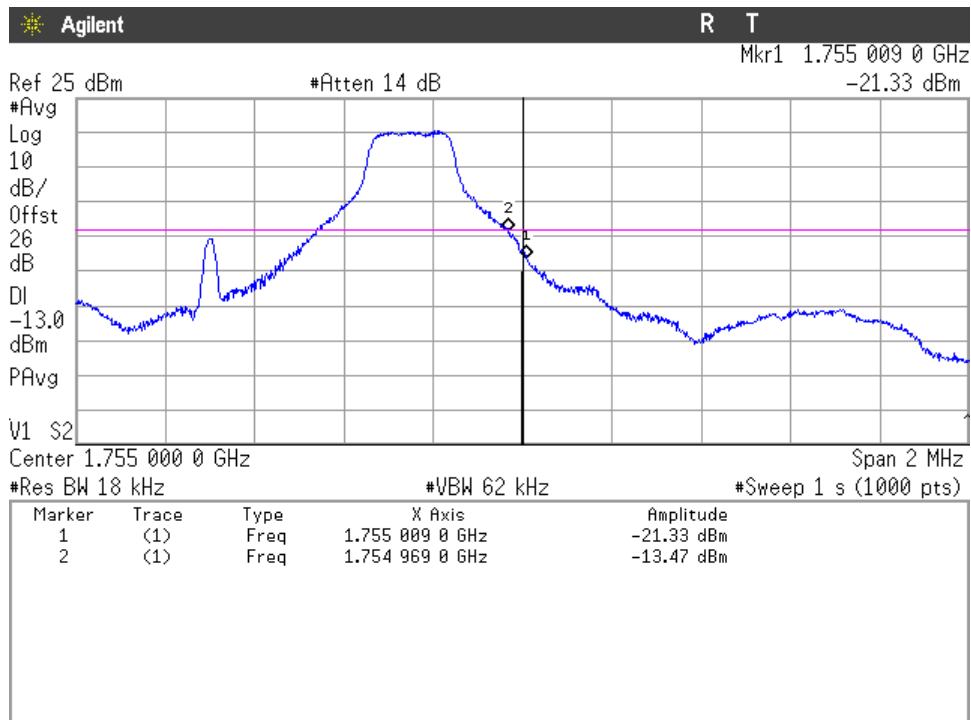

LTE Band 4. QPSK MODULATION. BW=1.4 MHz. RB=All. Offset=0. Lowest and Highest Block Edges:

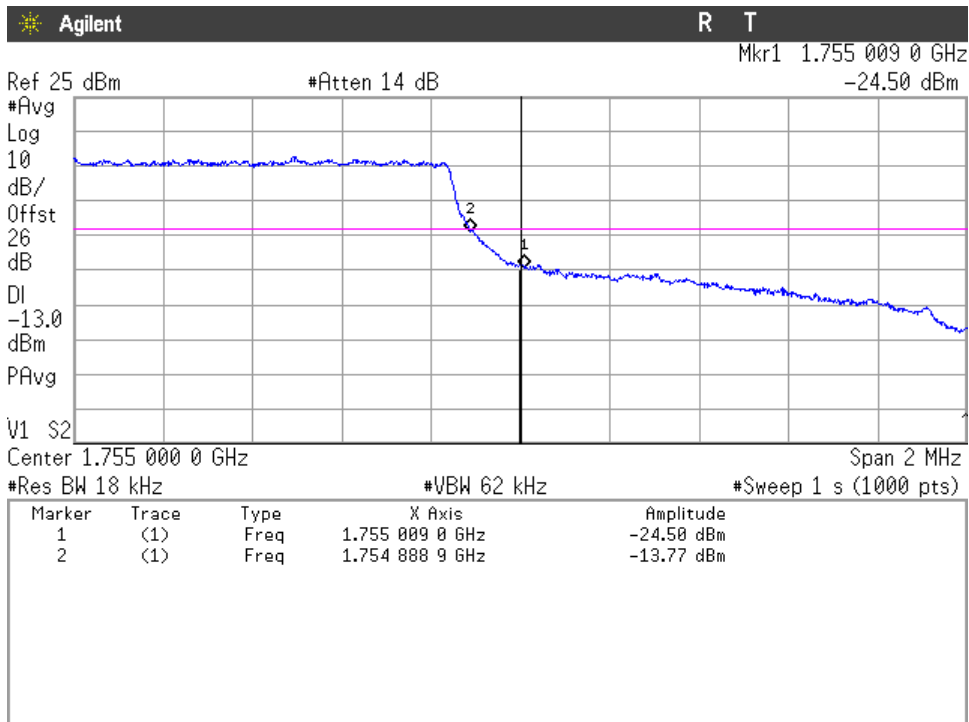
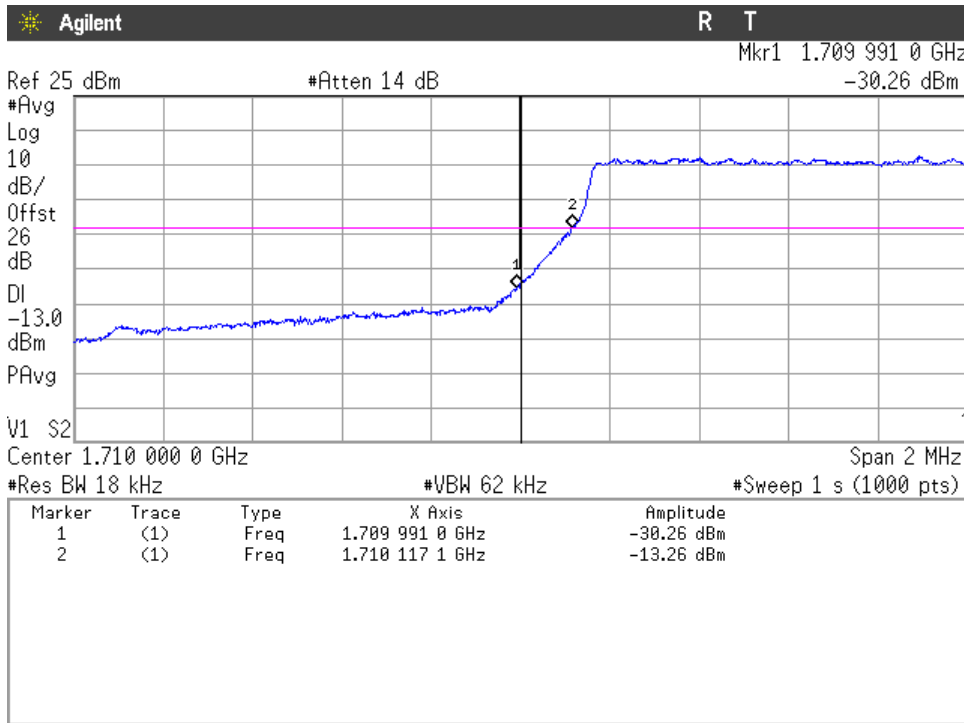

LTE Band 4. QPSK MODULATION. BW=3 MHz. RB=1. Offset=0. Lowest Block Edge:

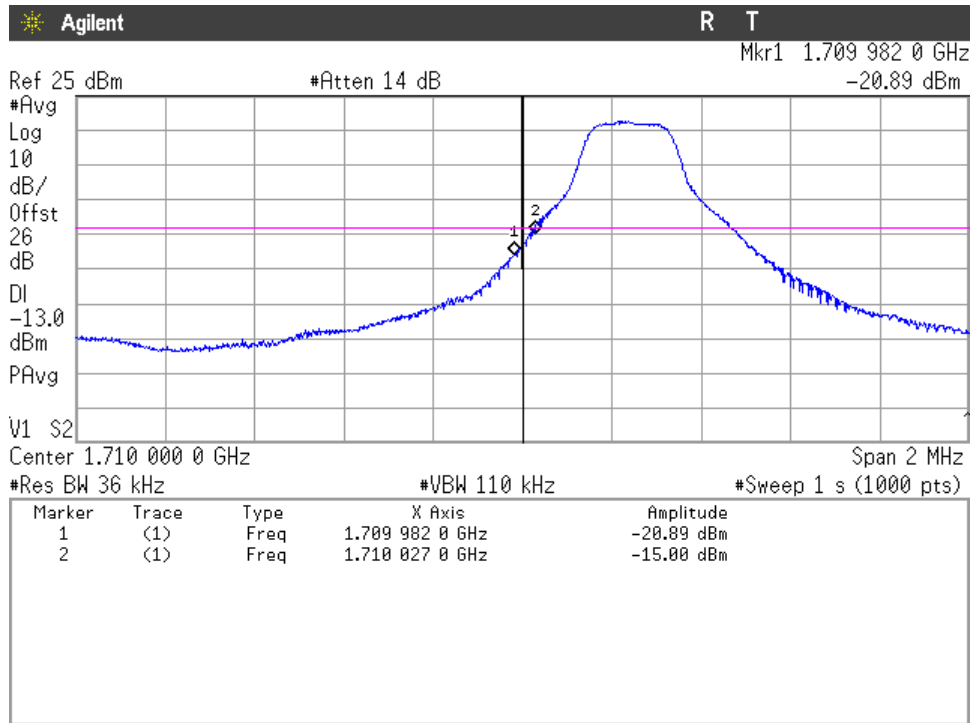

LTE Band 4. QPSK MODULATION. BW=3 MHz. RB=1. Offset=Max. Highest Block Edge:

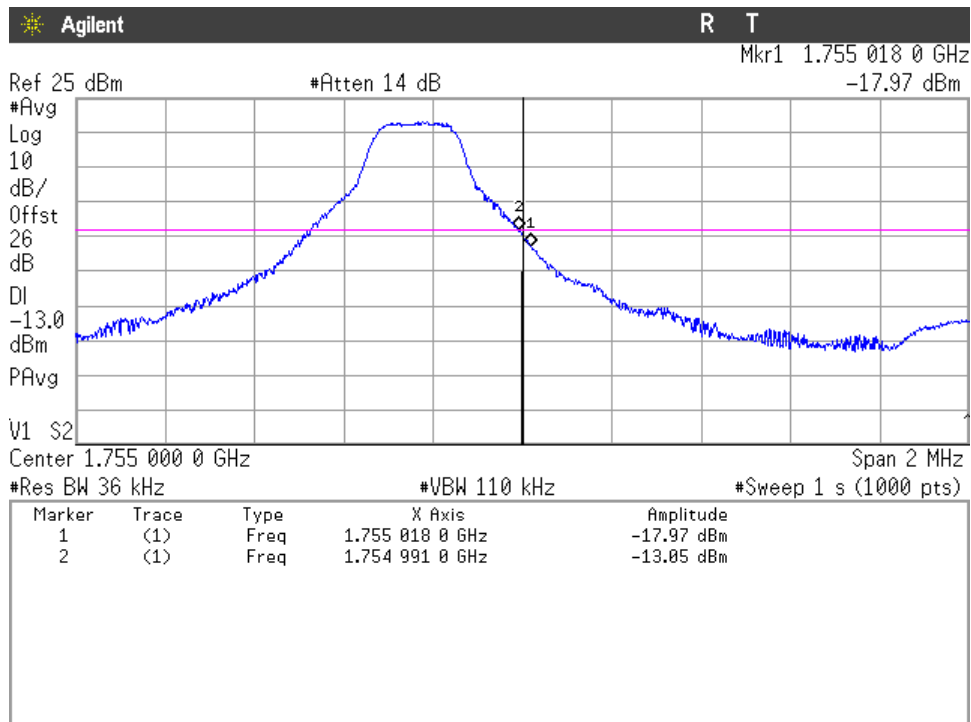

LTE Band 4. QPSK MODULATION. BW=3 MHz. RB=All. Offset=0. Lowest and Highest Block Edges:

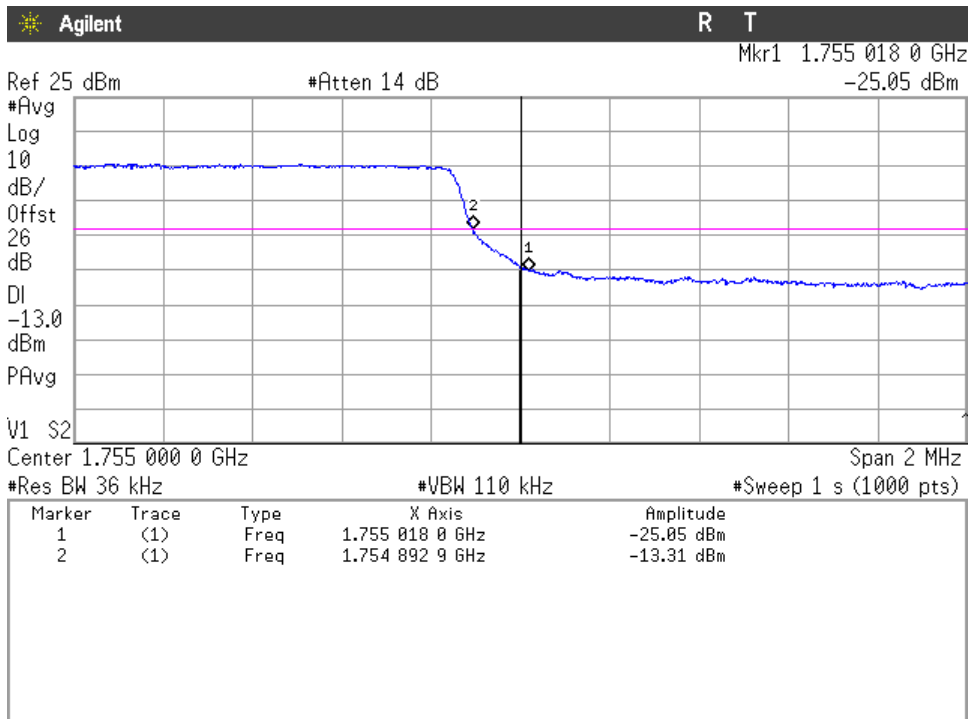
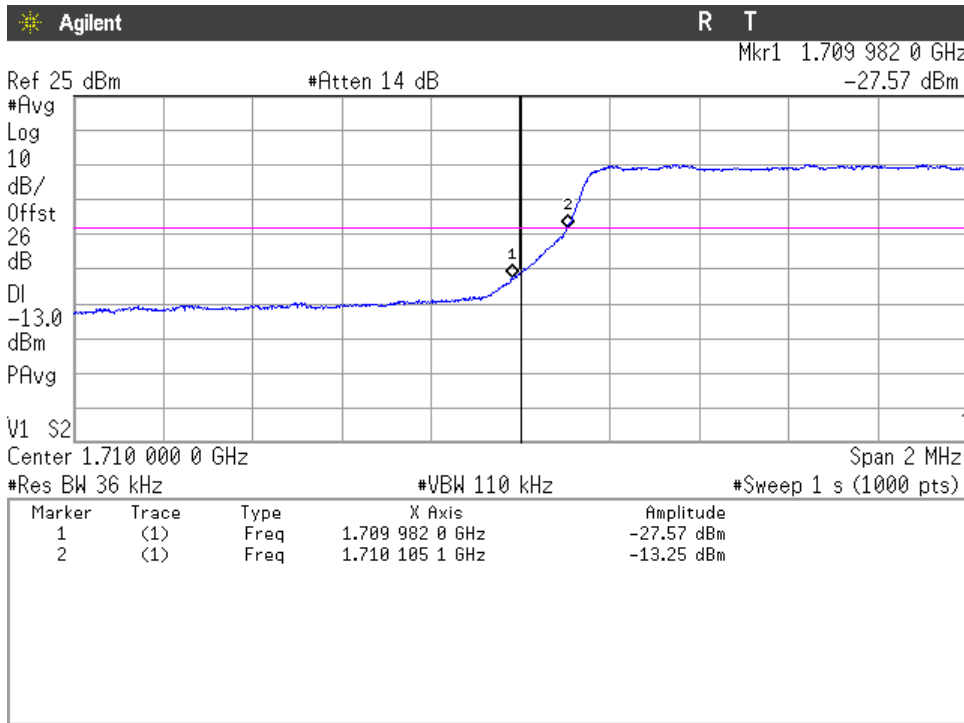

LTE Band 4. QPSK MODULATION. BW=5 MHz. RB=1. Offset=0. Lowest Block Edge:

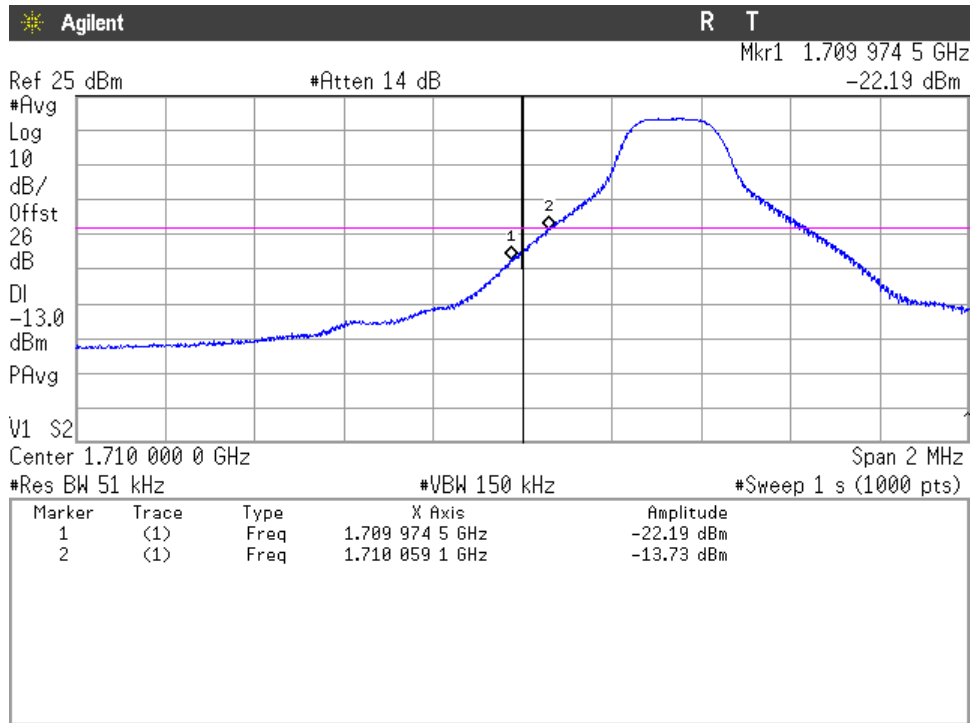

LTE Band 4. QPSK MODULATION. BW=5 MHz. RB=1. Offset=Max. Highest Block Edge:

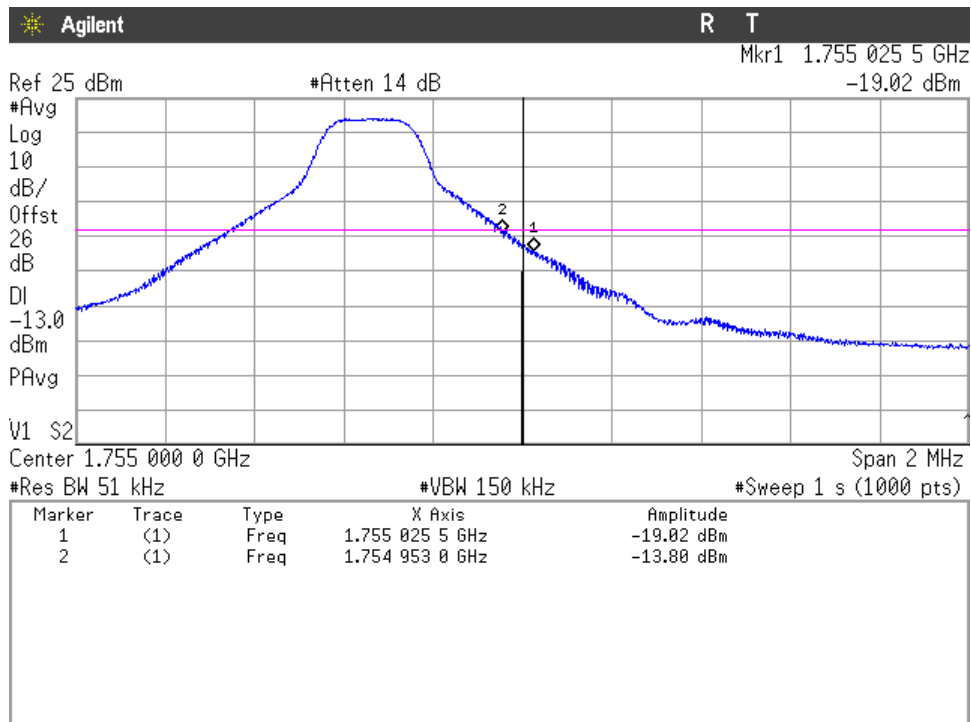

LTE Band 4. QPSK MODULATION. BW=5 MHz. RB=All. Offset=0. Lowest and Highest Block Edges:

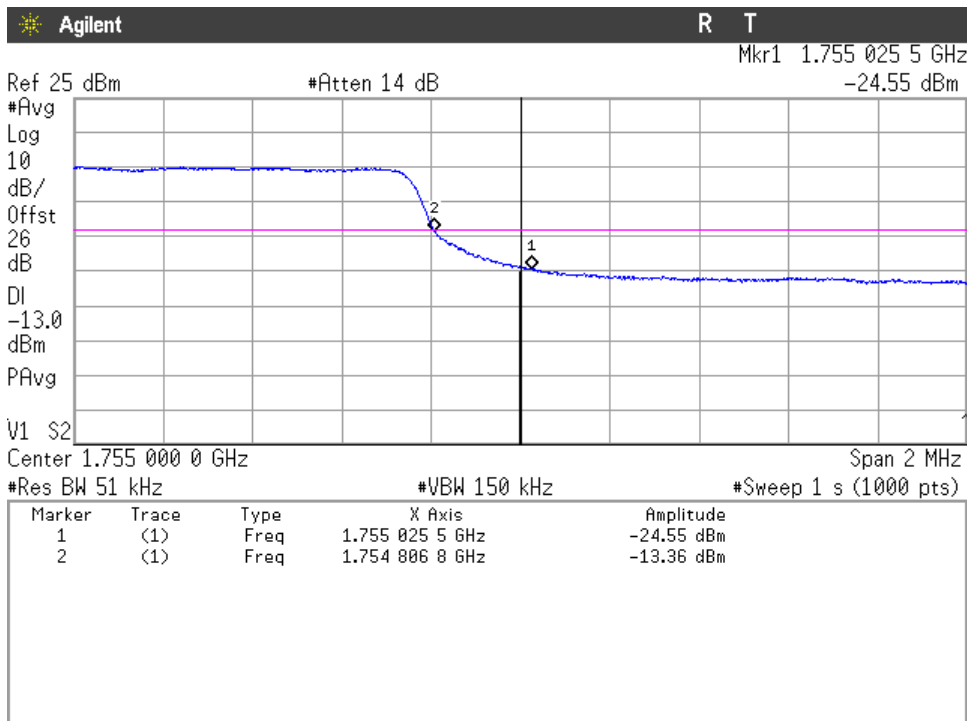
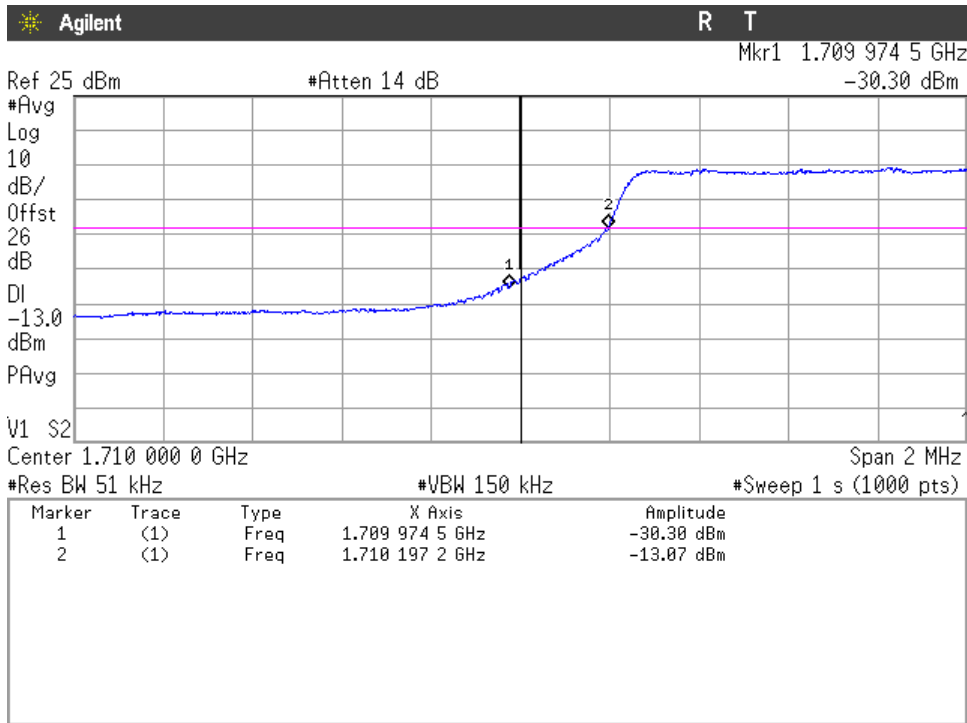

LTE Band 4. QPSK MODULATION. BW=10 MHz. RB=1. Offset=0. Lowest Block Edge:

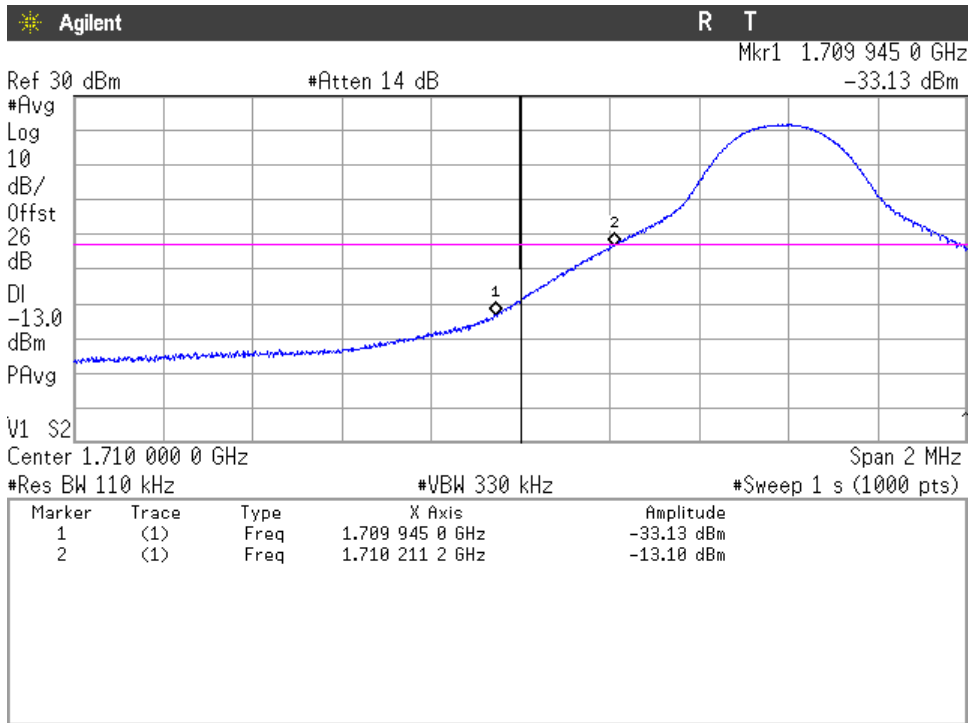

LTE Band 4. QPSK MODULATION. BW=10 MHz. RB=1. Offset=Max. Highest Block Edge:

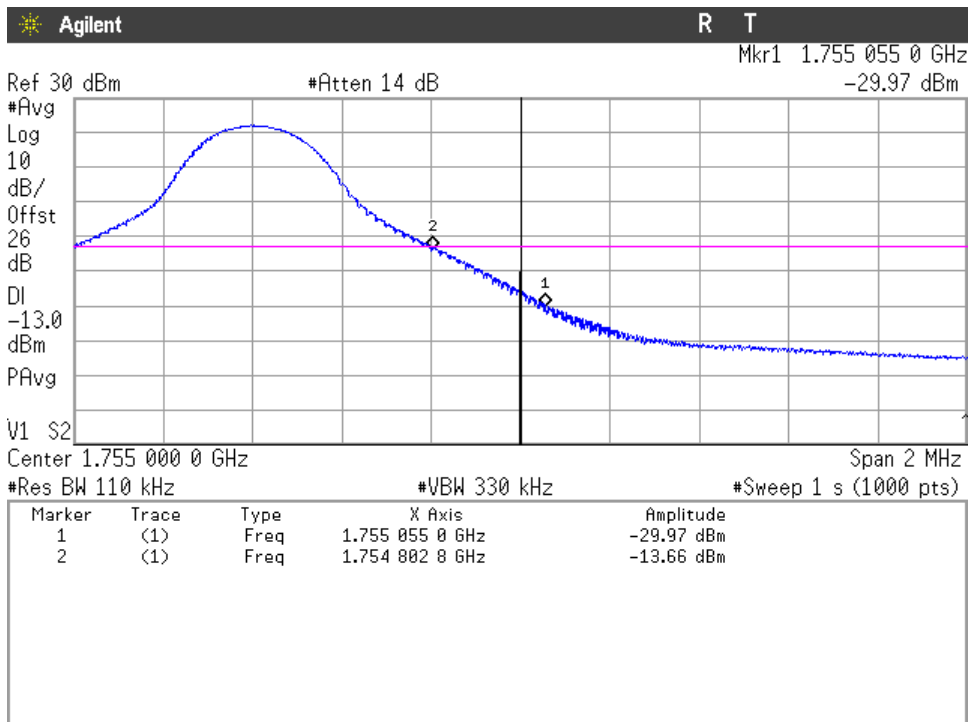

LTE Band 4. QPSK MODULATION. BW=10 MHz. RB=All. Offset=0. Lowest and Highest Block Edges:

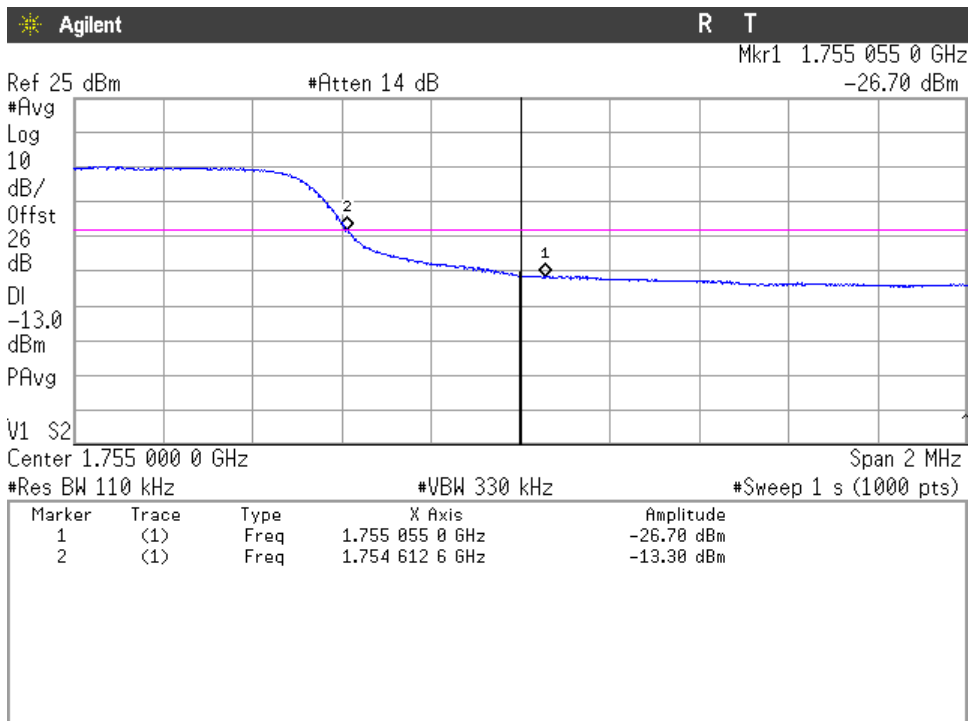
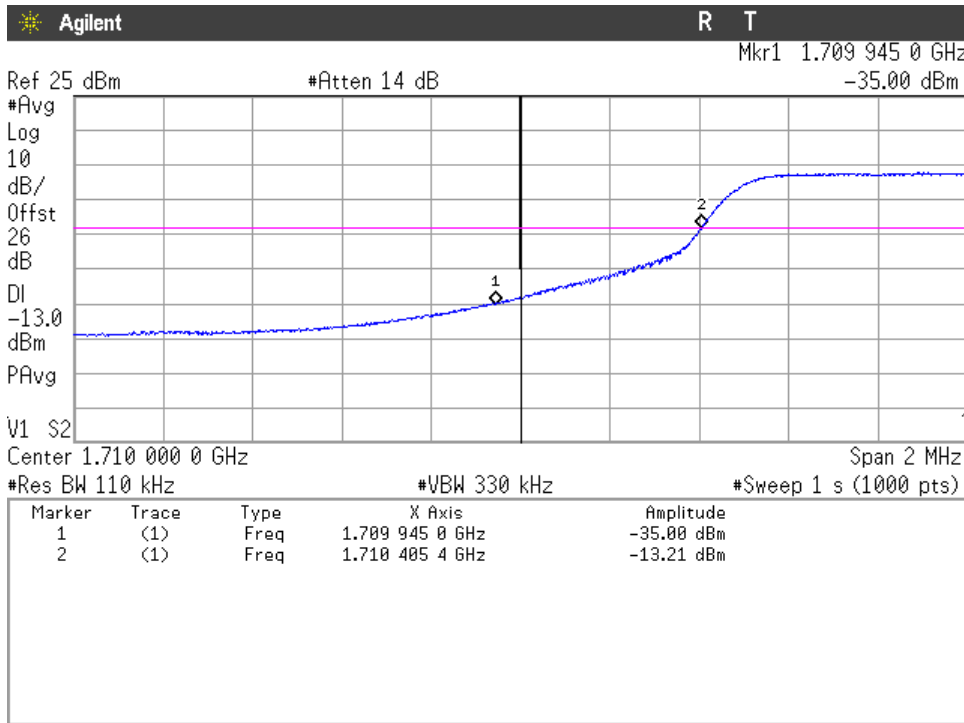

LTE Band 4. QPSK MODULATION. BW=15 MHz. RB=1. Offset=0. Lowest Block Edge:

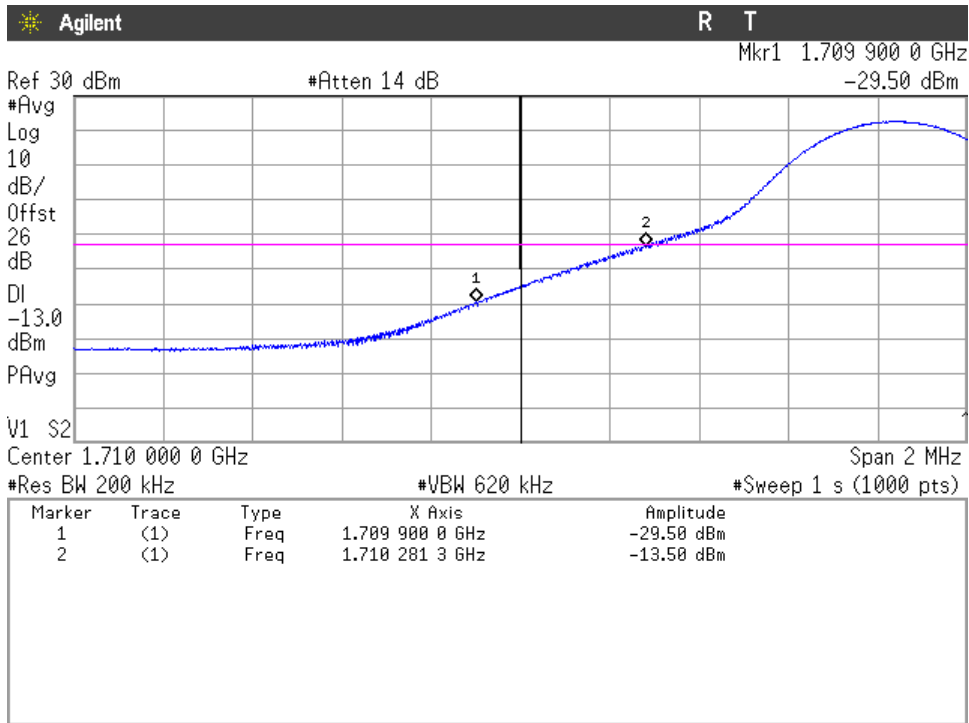

LTE Band 4. QPSK MODULATION. BW=15 MHz. RB=1. Offset=Max. Highest Block Edge:

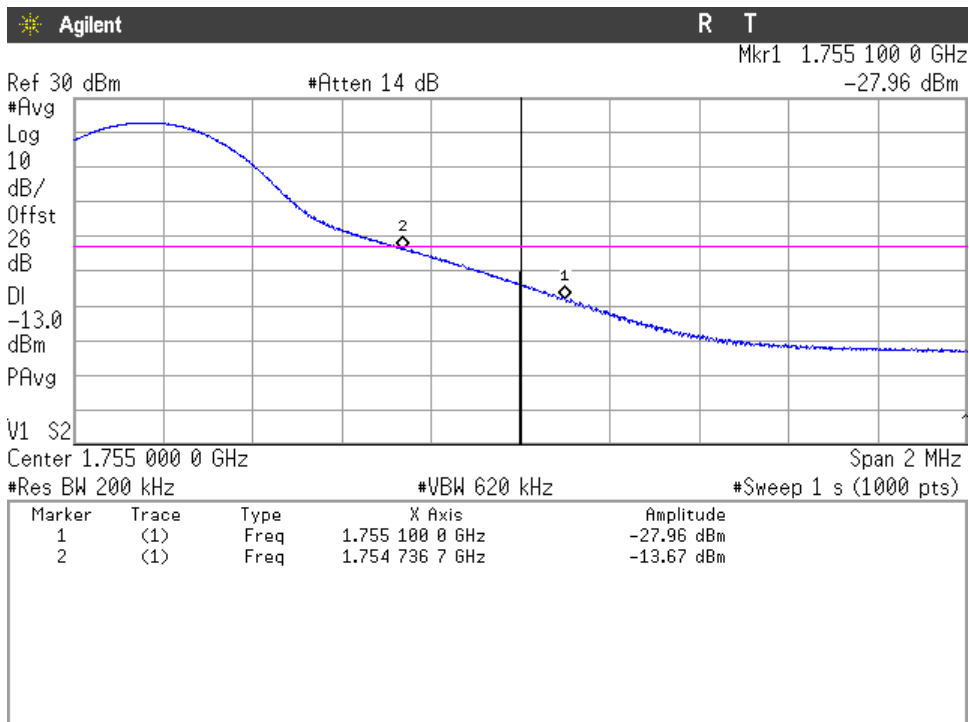

LTE Band 4. QPSK MODULATION. BW=15 MHz. RB=All. Offset=0. Lowest and Highest Block Edges:

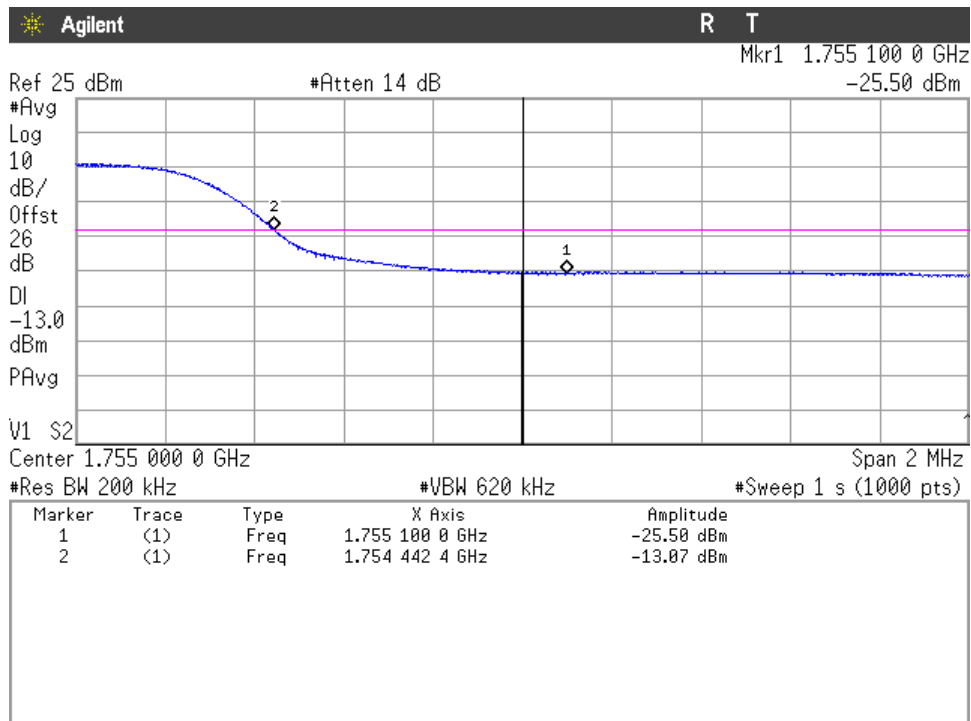
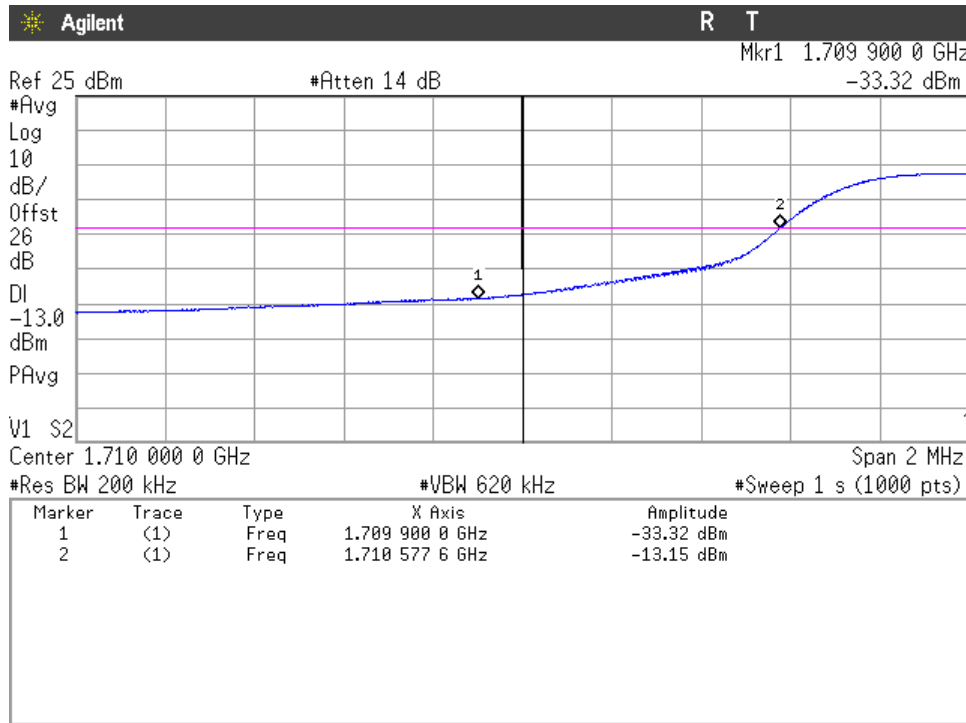

LTE Band 4. QPSK MODULATION. BW=20 MHz. RB=1. Offset=0. Lowest Block Edge:

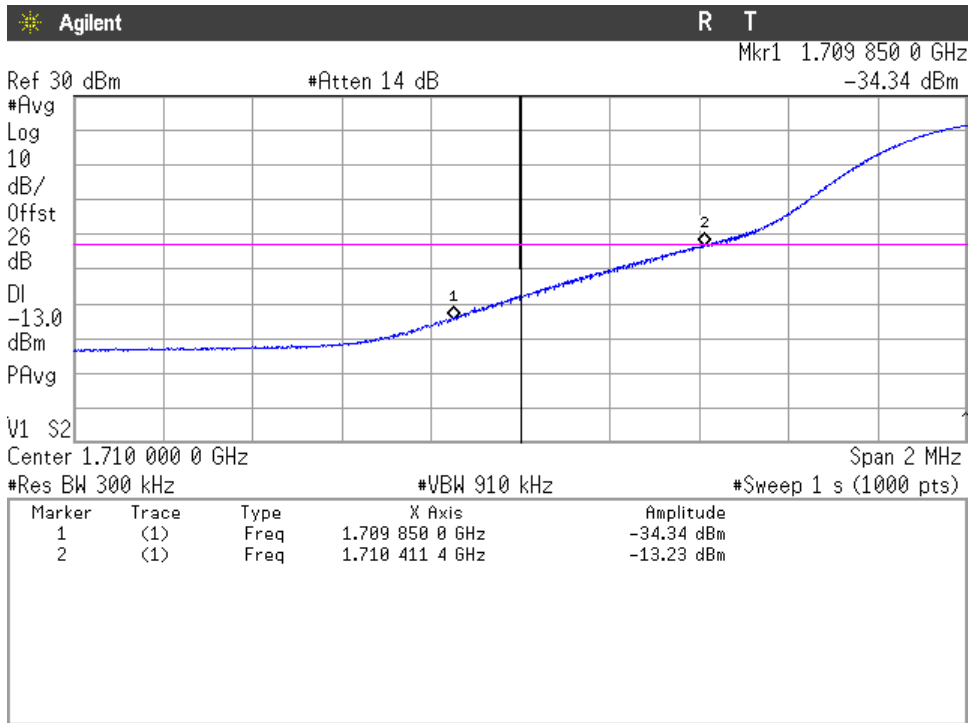

LTE Band 4. QPSK MODULATION. BW=20 MHz. RB=1. Offset=Max. Highest Block Edge:

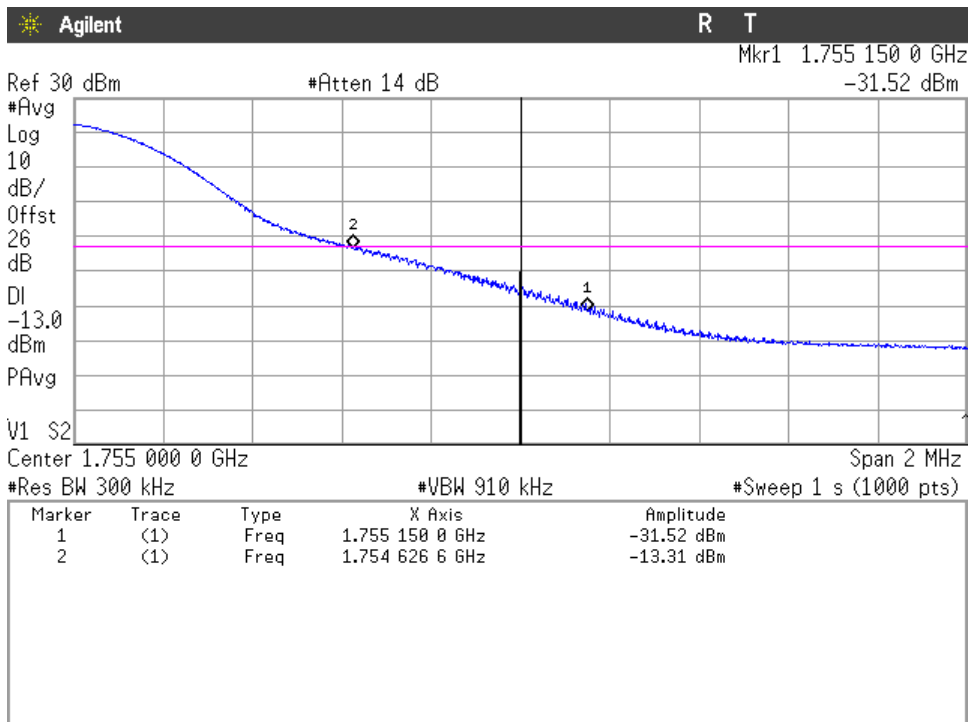

LTE Band 4. QPSK MODULATION. BW=20 MHz. RB=All. Offset=0. Lowest and Highest Block Edges:

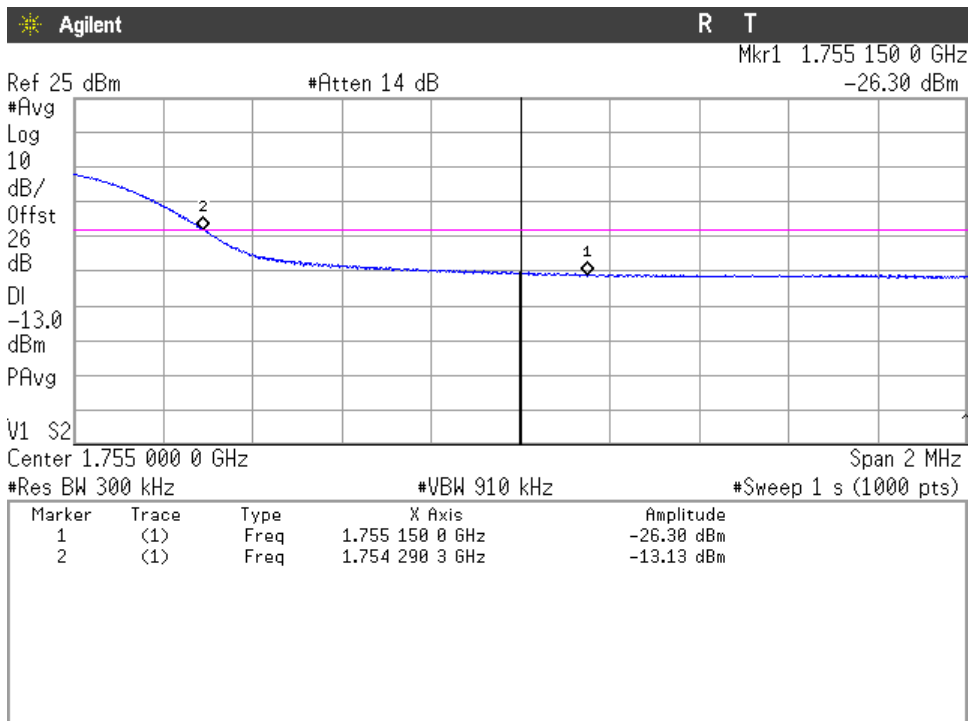
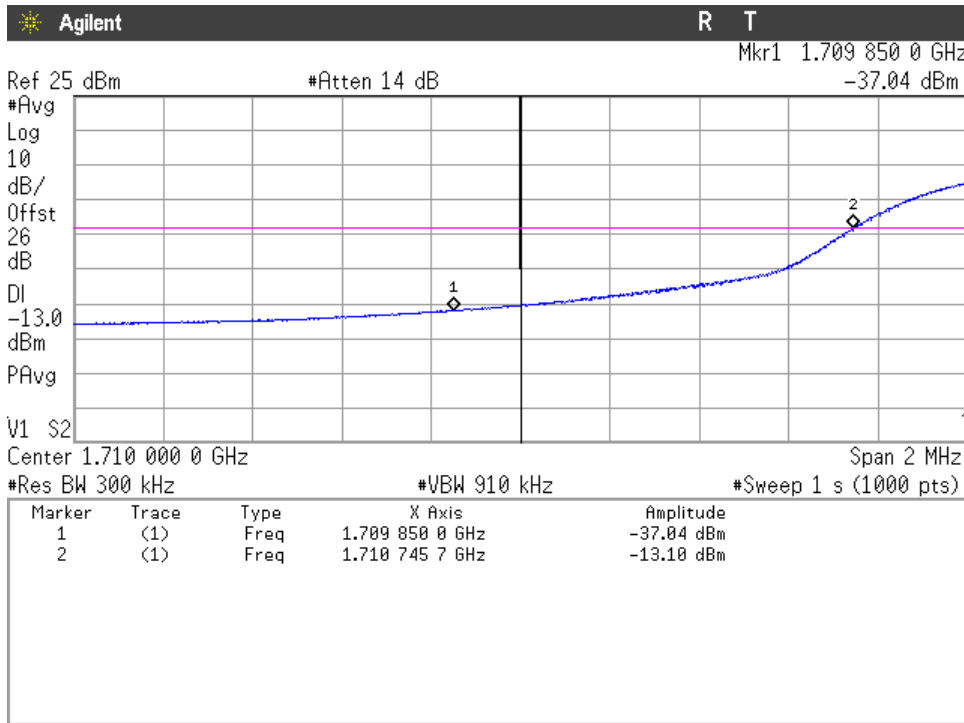

Radiated emissions

SPECIFICATION:

LTE Band 4 and 3G Band IV. FCC §2.1053 & §27.53 (h) / RSS-139 Issue 3 Clause 6.6.

FCC §27.53 (h):

(h) Except as otherwise specified below, for operations in the 1695-1710 MHz, 1710-1755 MHz, 1755-1780 MHz, 1915-1920 MHz, 1995-2000 MHz, 2000-2020 MHz, 2110-2155 MHz, 2155-2180 MHz, and 2180-2200 MHz bands, the power of any emission outside a licensee's frequency block shall be attenuated below the transmitter power (P) in watts by at least $43 + 10 \log_{10}(P)$ dB.

RSS-139 Clause 6.6:

i. In the first 1.0 MHz bands immediately outside and adjacent to the equipment's smallest operating frequency block, which can contain the equipment's occupied bandwidth, the emission power per any 1% of the emission bandwidth shall be attenuated below the transmitter output power P (in dBW) by at least $43 + 10 \log_{10} P$ (watts) dB.

ii. After the first 1.0 MHz outside the equipment's smallest operating frequency block, which can contain the equipment's occupied bandwidth, the emission power in any 1 MHz bandwidth shall be attenuated below the transmitter output power P (in dBW) by at least $43 + 10 \log_{10} P$ (watts) dB.

LTE Band 4 MEASUREMENT LIMIT:

At P_o transmitting power, the specified minimum attenuation becomes $43 + 10 \log(P_o)$, and the level in dBm relative P_o becomes:

$$P_o \text{ (dBm)} - [43 + 10 \log(P_o \text{ in mwatts}) - 30] = -13 \text{ dBm}$$

METHOD:

The measurement was performed with the EUT inside an anechoic chamber.

The spectrum was scanned from 30 MHz to at least the 10th harmonic of the highest frequency generated within the equipment.

The EUT was placed on a non-conductive stand at a 3 meter distance from the measuring antenna for measurements below 1 GHz and at 1 m distance for measurements above 1 GHz.

Detected emissions were maximized at each frequency by rotating the EUT and adjusting the measuring antenna height and polarization. The maximum meter reading was recorded.

Each detected emission at less than 20 dB respect to the limit is substituted by the Substitution method in accordance with the ANSI/TIA-603-E: 2016.

TEST SETUP:

Radiated measurements below 1 GHz.

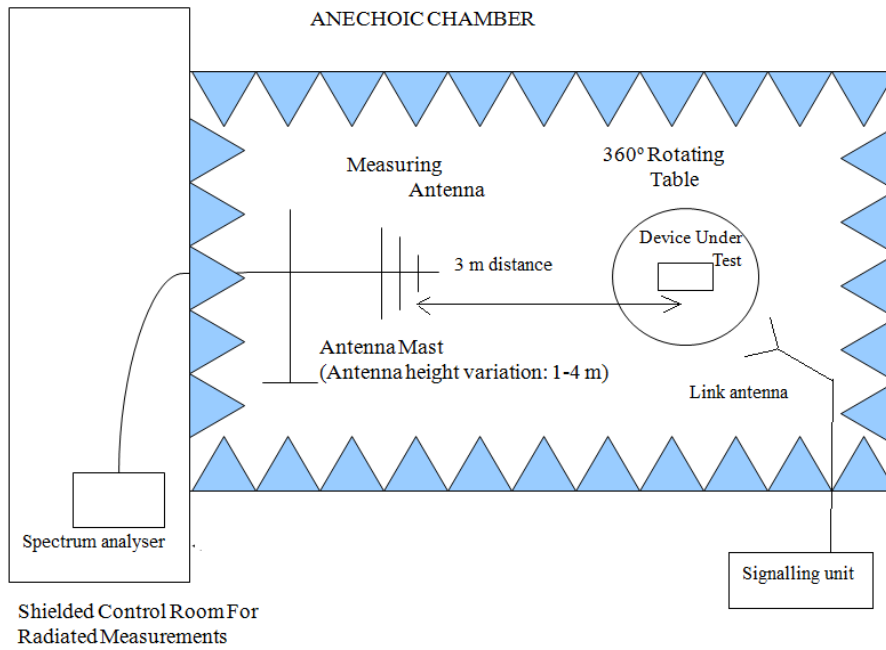

Radiated measurements above 1 GHz.

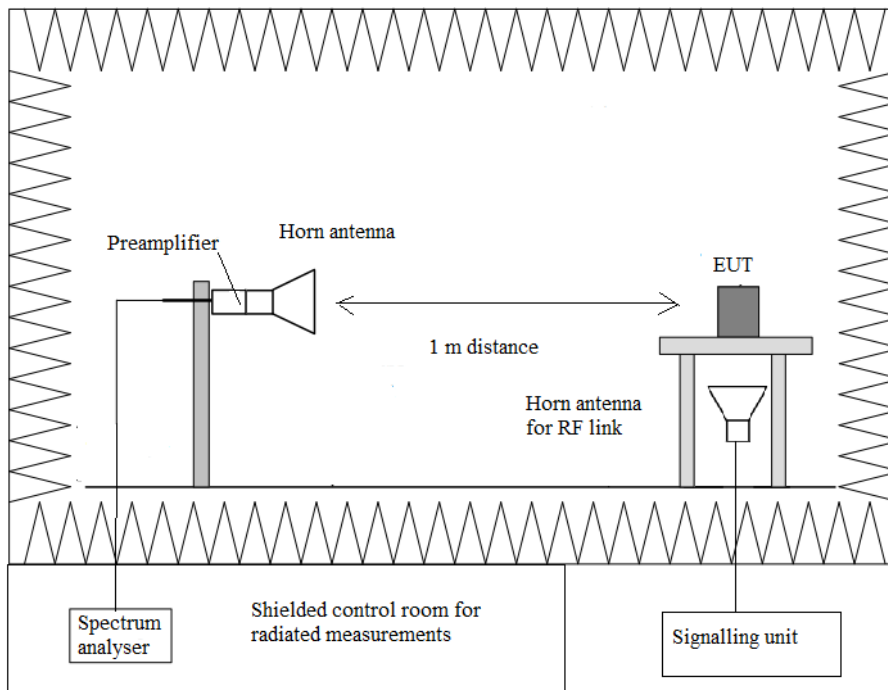

RESULTS:

3G Band IV:

WCDMA and HSUPA Modulations:

A preliminary scan determined the HSUPA modulation as the worst case.

- Lowest Channel:

Frequency range 30 MHz - 1 GHz

No spurious frequencies detected at less than 20 dB below the limit.

Frequency range 1 - 18 GHz

No spurious frequencies detected at less than 20 dB below the limit.

- Middle Channel:

Frequency range 30 MHz - 1 GHz

No spurious frequencies detected at less than 20 dB below the limit.

Frequency range 1 - 18 GHz

No spurious frequencies detected at less than 20 dB below the limit.

- Highest Channel:

Frequency range 30 MHz - 1 GHz

No spurious frequencies detected at less than 20 dB below the limit.

Frequency range 1 - 18 GHz

No spurious frequencies detected at less than 20 dB below the limit.

| | |
|------------------------------|--|
| Measurement uncertainty (dB) | <±3.88 for f < 1GHz <±3.70 for f ≥ 1 GHz up to 18 GHz |
|------------------------------|--|

Verdict: PASS

FREQUENCY RANGE 30 MHz - 1 GHz

HSUPA MODULATION

This plot is valid for the Lowest, Middle and Highest Channels.

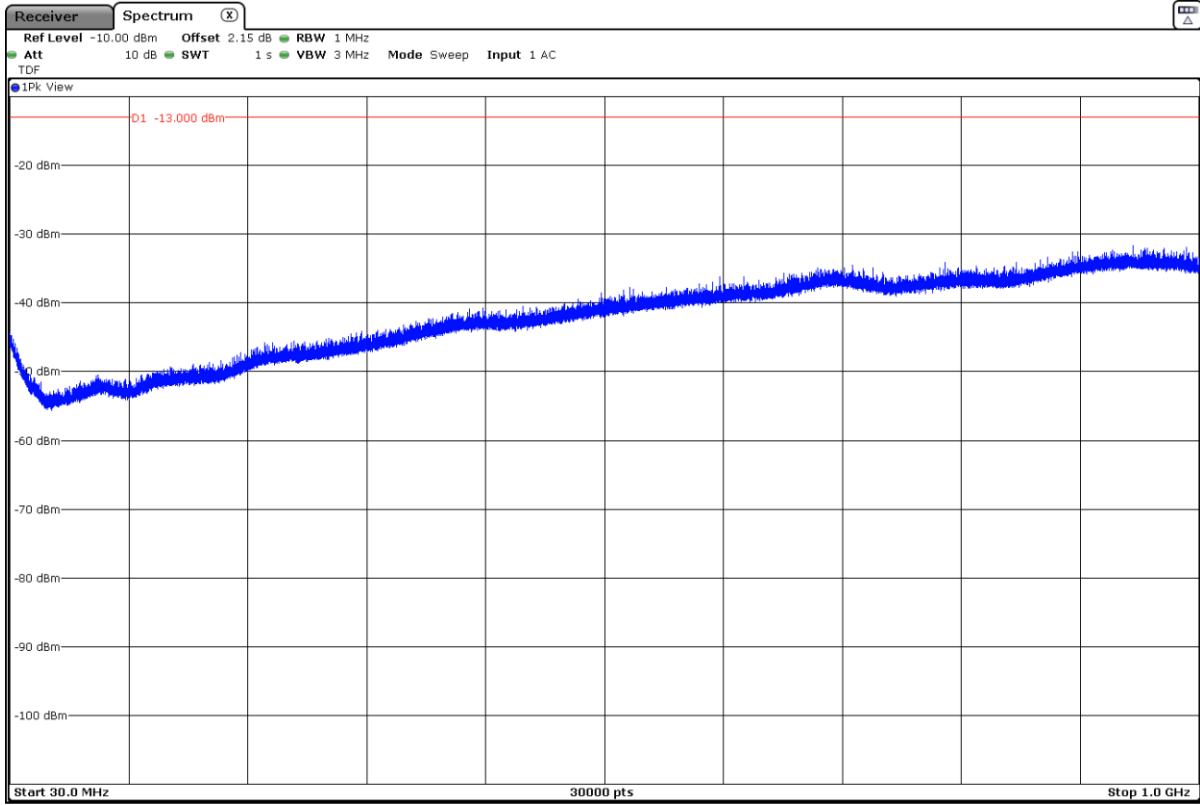

FREQUENCY RANGE 1 - 3 GHz

HSUPA MODULATION

- Lowest Channel:

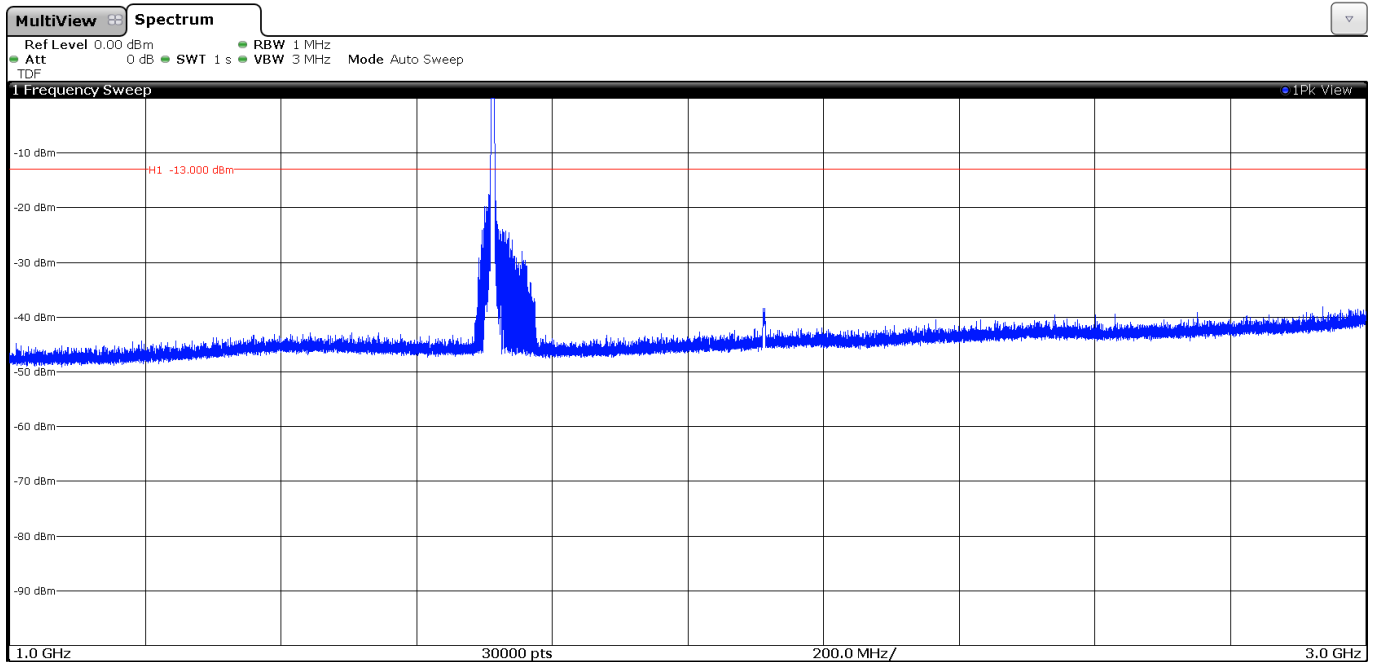

The peak above the limit is the carrier frequency.

- Middle Channel:

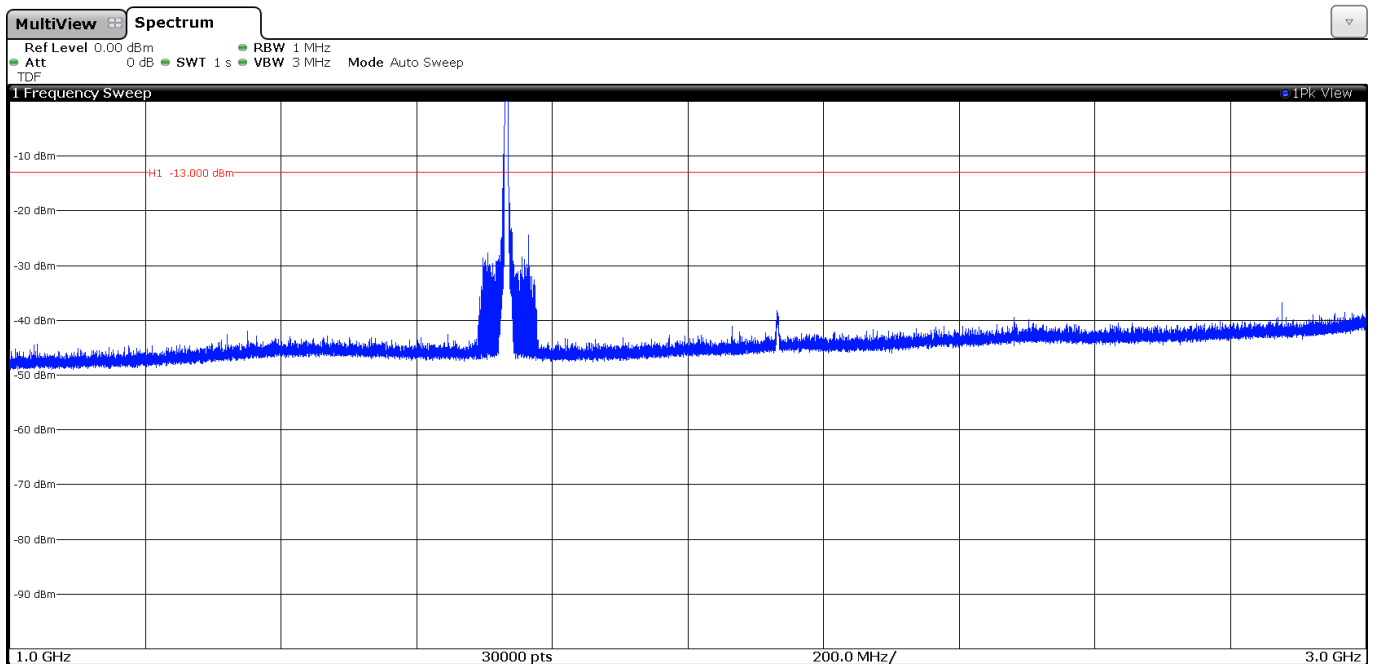

The peak above the limit is the carrier frequency

- Highest Channel:

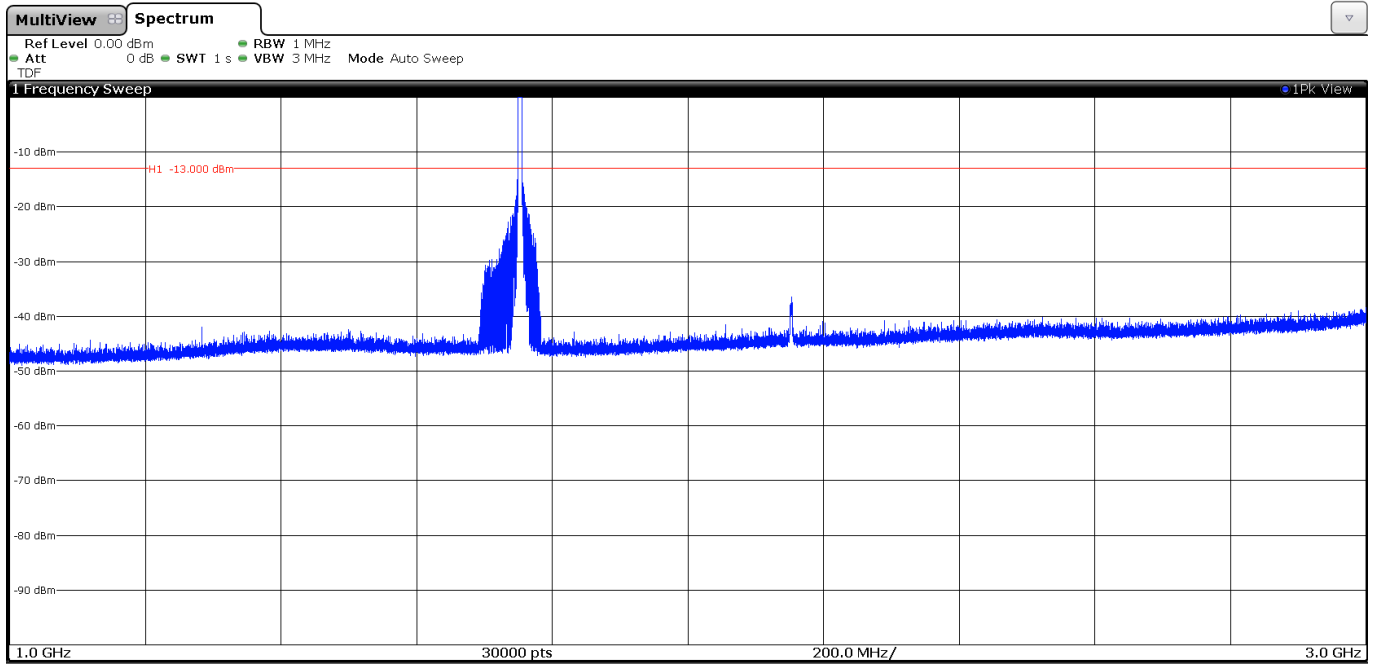

The peak above the limit is the carrier frequency

FREQUENCY RANGE 3 – 18 GHz

This plot is valid for the Lowest, Middle and Highest Channels.

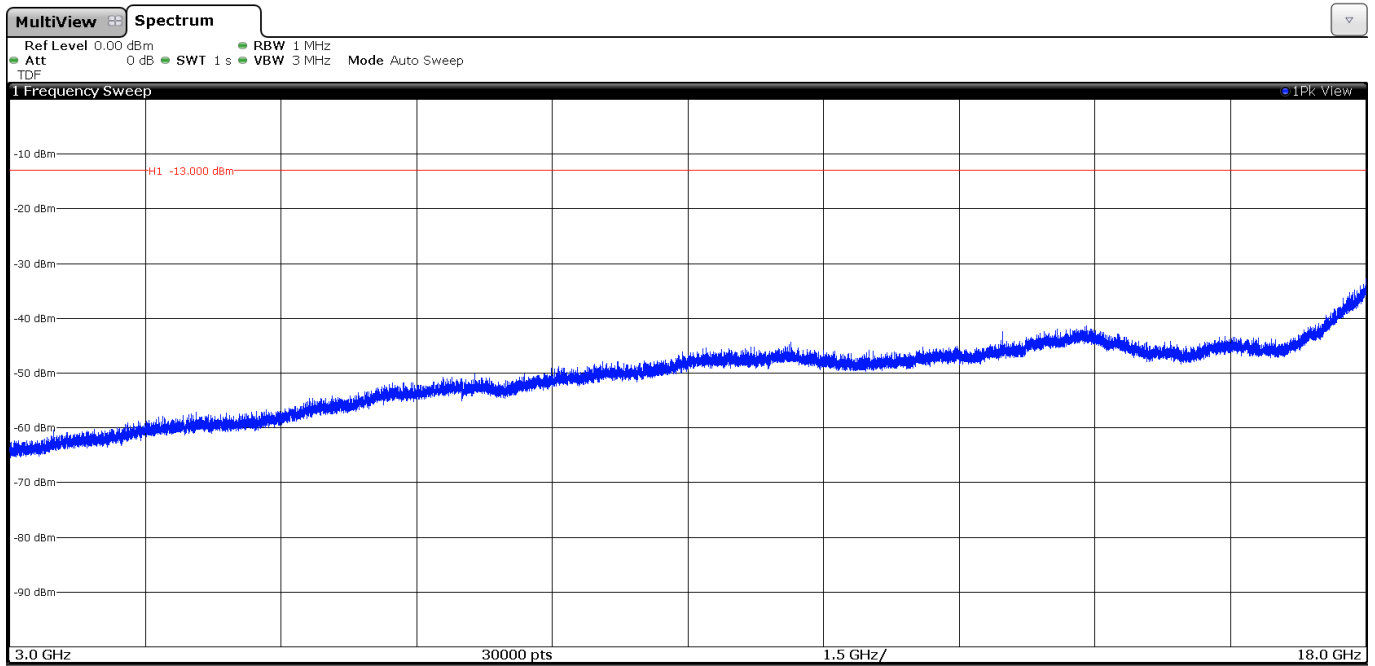

LTE Band 4:

QPSK and 16QAM Modulations:

A preliminary scan determined the QPSK modulation, BW=1.4 MHz, RB=1, Offset=0 as the worst case.

- Lowest Channel:

Frequency range 30 MHz - 1 GHz

No spurious frequencies detected at less than 20 dB below the limit.

Frequency range 1 - 18 GHz

No spurious frequencies detected at less than 20 dB below the limit.

- Middle Channel:

Frequency range 30 MHz - 1 GHz

No spurious frequencies detected at less than 20 dB below the limit.

Frequency range 1 - 18 GHz

No spurious frequencies detected at less than 20 dB below the limit.

- Highest Channel:

Frequency range 30 MHz - 1 GHz

No spurious frequencies detected at less than 20 dB below the limit.

Frequency range 1 - 18 GHz

No spurious frequencies detected at less than 20 dB below the limit.

| | |
|------------------------------|--|
| Measurement uncertainty (dB) | <±3.88 for f < 1GHz <±3.70 for f ≥ 1 GHz up to 18 GHz |
|------------------------------|--|

Verdict: PASS

FREQUENCY RANGE 30 MHz - 1 GHz

QPSK MODULATION

This plot is valid for the Low, Middle and High Channels.

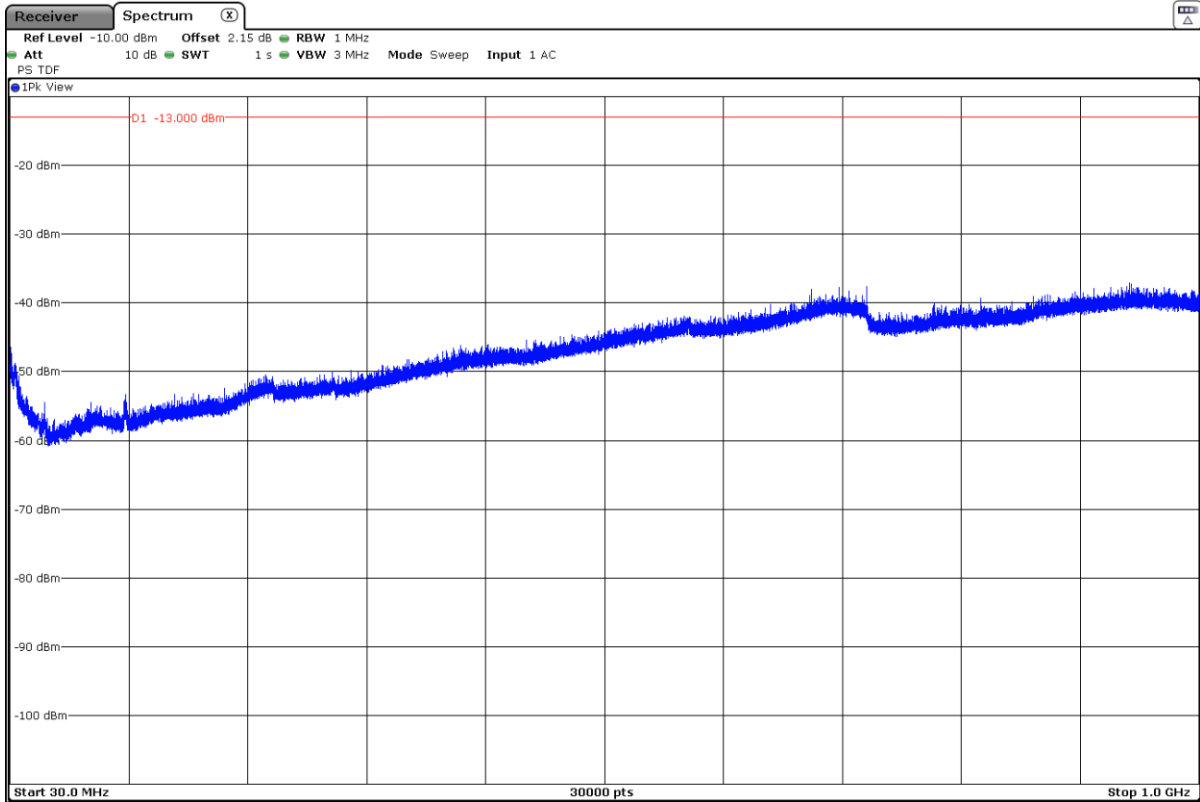

FREQUENCY RANGE 1 - 3 GHz

QPSK MODULATION

- Lowest Channel:

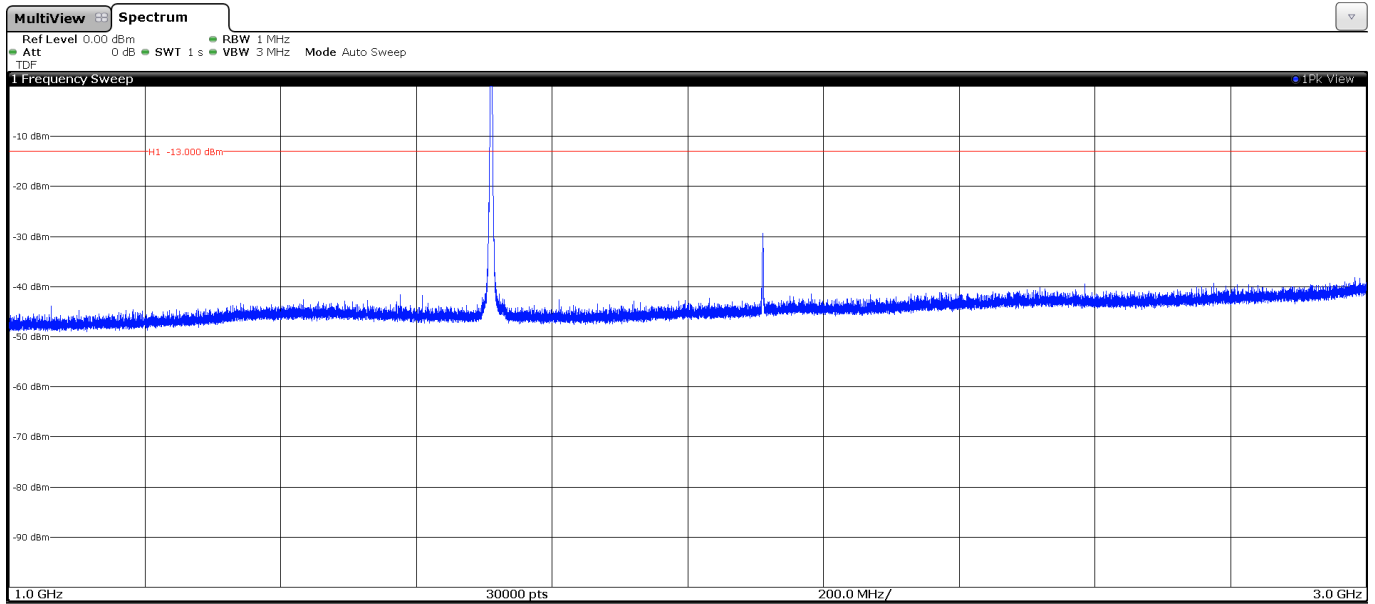

The peak above the limit is the carrier frequency:

- Middle Channel:

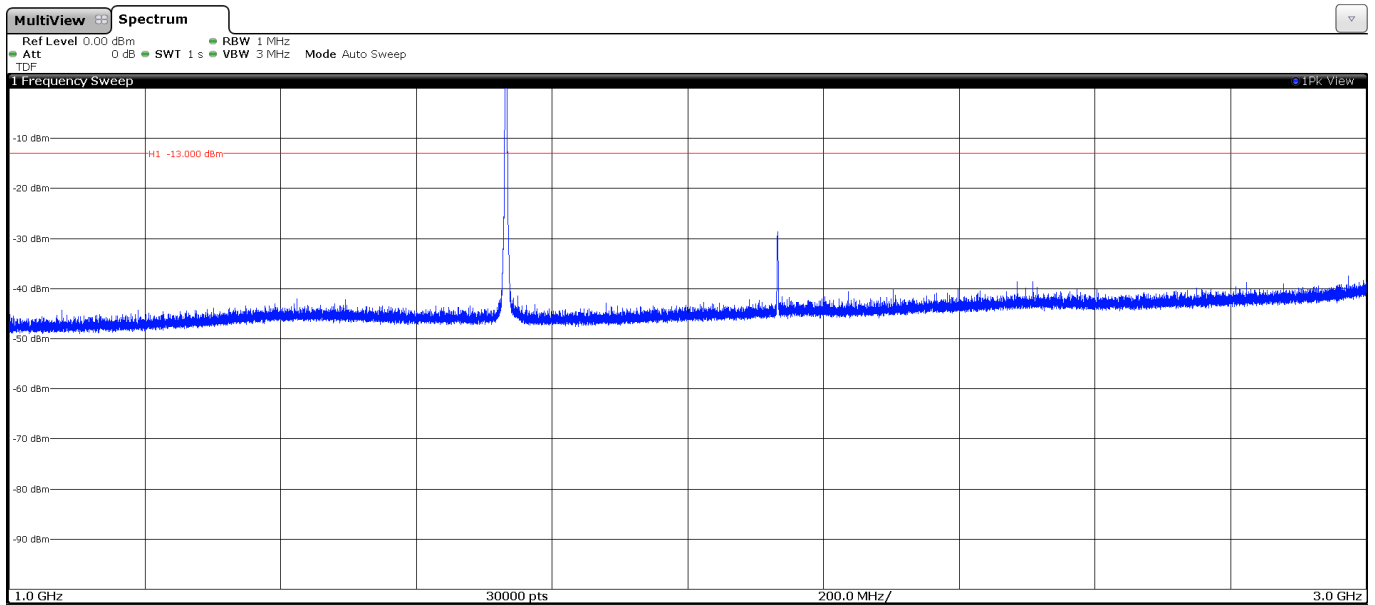

The peak above the limit is the carrier frequency:

- Highest Channel:

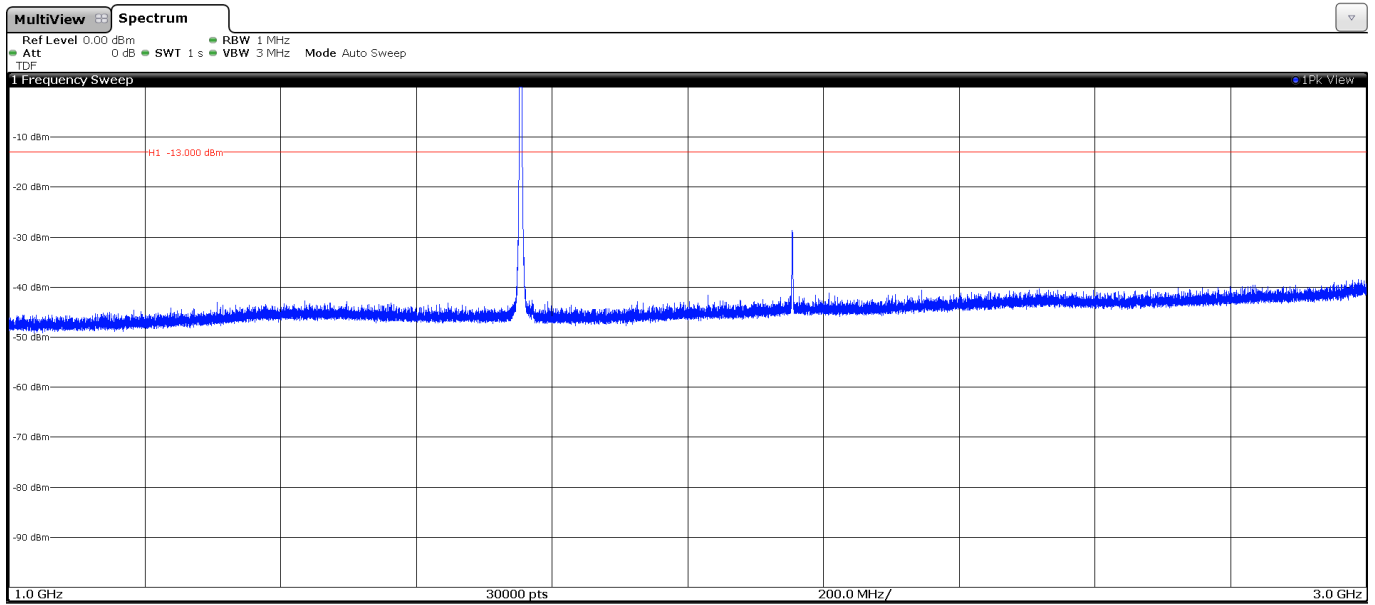

The peak above the limit is the carrier frequency:

FREQUENCY RANGE 3 – 18 GHz

- Lowest Channel:

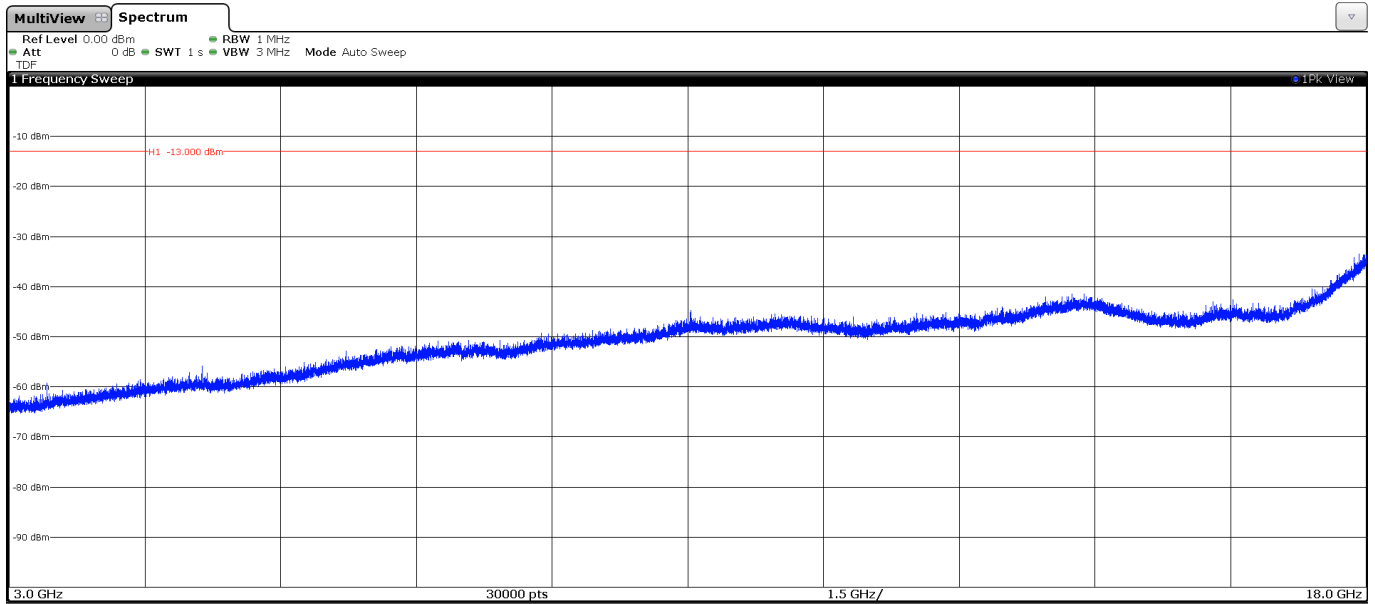

- Middle Channel:

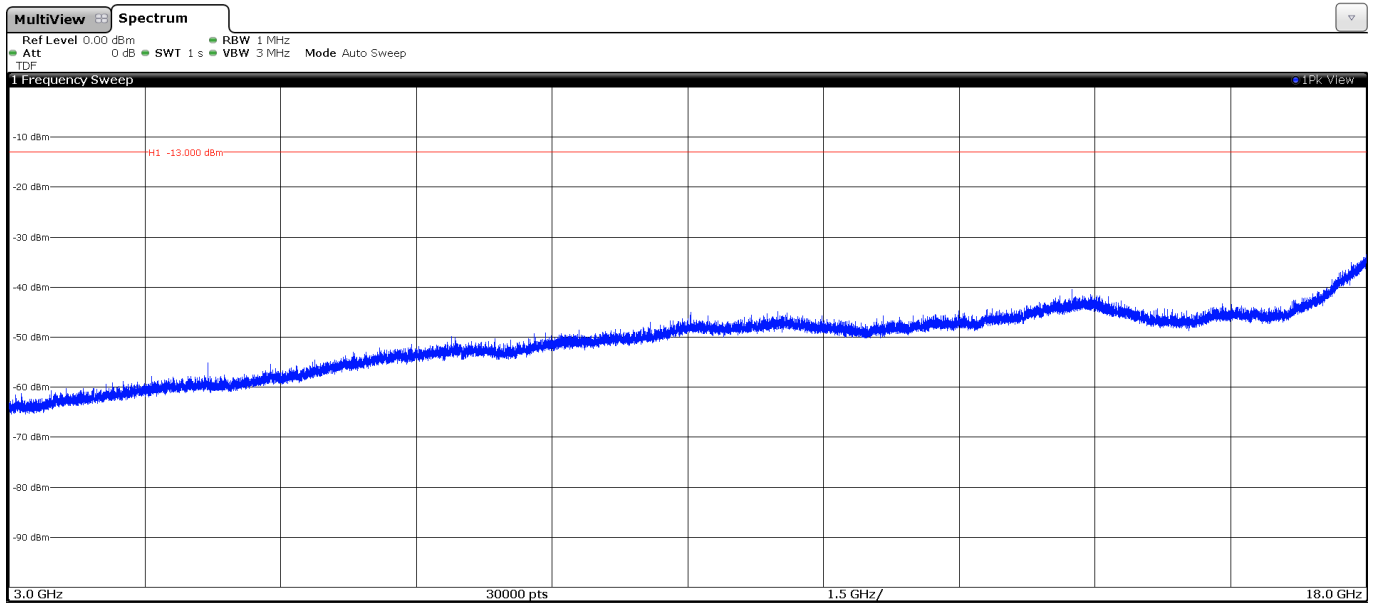

- Highest Channel:

