



Test report No:
 NIE: 61457RRF.003A2

Test report
 Reference Standard:
 USA FCC Part 24
 CANADA RSS-133

(*) Identification of item tested	Data Logger
(*) Trademark	Danlaw
(*) Model and /or type reference	DL970
Other identification of the product	HW Version: 2.0 SW Version: 1.4.0.0 FCC ID: 2AD9I-DL970 IC: 20087-DL970
(*) Features	LTE, 3G, GPS, WLAN, Bluetooth (BLE)
Applicant	DANLAW INC 41211 Vincenti Court, Novi, Michigan 48375, USA
Test method requested, standard	USA FCC Part 24 (10-1-18 Edition). CANADA RSS-133 Issue 6, Jan. 2018. ANSI C63.26-2015. ANSI/TIA-603-E: 2016. KDB 971168 D01 Power Meas License Digital Systems v03r01, April. 2018.
Summary	IN COMPLIANCE
Approved by (name / position & signature)	Rafael López Martín EMC Consumer & RF Lab. Manager
Date of issue	2020-01-22
Report template No	FDT08_22 (*) "Data provided by the client"

Index

Competences and guarantees	3
General conditions	3
Uncertainty.....	3
Data provided by the client	3
Usage of samples	4
Test sample description.....	5
Identification of the client	6
Testing period and place	6
Document history.....	6
Environmental conditions	6
Remarks and comments.....	7
Testing verdicts.....	8
Summary	8
Appendix A: Test results for FCC PART 24 / RSS-133.....	9

Competences and guarantees

DEKRA Testing and Certification S.A.U. is a testing laboratory accredited by the National Accreditation Body (ENAC -Entidad Nacional de Acreditación), to perform the tests indicated in the Certificate No. 51/LE 147.

DEKRA Testing and Certification is a FCC-recognized accredited testing laboratory with appropriate scope of accreditation that include testing performed in this test report.

DEKRA Testing and Certification is an ISED-recognized accredited testing laboratory with appropriate scope of accreditation that include testing performed in this test report.

In order to assure the traceability to other national and international laboratories, DEKRA Testing and Certification S.A.U. has a calibration and maintenance program for its measurement equipment.

DEKRA Testing and Certification S.A.U. guarantees the reliability of the data presented in this report, which is the result of the measurements and the tests performed to the item under test on the date and under the conditions stated on the report and, it is based on the knowledge and technical facilities available at DEKRA Testing and Certification S.A.U. at the time of performance of the test.

DEKRA Testing and Certification S.A.U. is liable to the client for the maintenance of the confidentiality of all information related to the item under test and the results of the test.

The results presented in this Test Report apply only to the particular item under test established in this document. **IMPORTANT:** No parts of this report may be reproduced or quoted out of context, in any form or by any means, except in full, without the previous written permission of DEKRA Testing and Certification S.A.U.

General conditions

1. This report is only referred to the item that has undergone the test.
2. This report does not constitute or imply on its own an approval of the product by the Certification Bodies or competent Authorities.
3. This document is only valid if complete; no partial reproduction can be made without previous written permission of DEKRA Testing and Certification S.A.U.
4. This test report cannot be used partially or in full for publicity and/or promotional purposes without previous written permission of DEKRA Testing and Certification S.A.U. and the Accreditation Bodies.

Uncertainty

Uncertainty (factor $k=2$) was calculated according to the DEKRA Testing and Certification S.A.U. internal document PODT000.

Data provided by the client

The following data has been provided by the client:

1. Information relating to the description of the sample ("Identification of the item tested", "Trademark", "Model and/or type reference tested").
2. The sample of DL970 consists of a Data Logger developed to provide companies with an easy to install, wireless communication device for monitoring and logging vehicle network message data.

The Danlaw Data Logger provides:

- Support for all major passenger car & light truck protocols.
- Simple plug-n-go via the vehicle's OBDII connector.

- OBD Vehicle Data logging with real-time data stamp.
- LTE & 3G communication.
- Support for FTP, TCP/IP data transfer.
- Firmware Over-The-Air (FOTA) Re-flash.
- Rugged, compact field-hardened design.
- No external antenna connections needed.
- Completely self-contained.

DEKRA Testing and Certification S.A.U. declines any responsibility with respect to the information provided by the client and that may affect the validity of results.

Usage of samples

Samples undergoing test have been selected by: The client.

- Sample S/01 is composed of the following elements:

Control Nº	Description	Model	Serial Nº	Date of reception
61457C/003	Data Logger	DL970	5337	2019/07/23

Sample S/01 has undergone the following test(s): All radiated tests indicated in Appendix A.

- Sample S/02 is composed of the following elements:

Control Nº	Description	Model	Serial Nº	Date of reception
61457C/001	Data Logger	DL970	--	2019/06/20

Sample S/02 has undergone the following test(s): All conducted tests indicated in Appendix A.

Test sample description

Ports..... .: :	Port name and description	Cable					
		Specified max length [m]	Attached during test	Shielded	Coupled to patient ⁽³⁾		
	USB connector; access virtual COM port	1.70	<input checked="" type="checkbox"/>	<input type="checkbox"/>	<input type="checkbox"/>		
Supplementary information to the ports..... :	-						
Rated power supply	Voltage and Frequency		Reference poles				
			L1	L2	L3	N	PE
	<input type="checkbox"/>	AC:	<input type="checkbox"/>	<input type="checkbox"/>	<input type="checkbox"/>	<input type="checkbox"/>	<input type="checkbox"/>
	<input checked="" type="checkbox"/>	DC: $V_{nom} = 12\text{ V}$; $V_{low} = 9\text{ V}$; $V_{high} = 15\text{ V}$					
Rated Power	-						
Clock frequencies..... :	-						
Other parameters	-						
Software version	1.4.0.0						
Hardware version	2.0						
Dimensions in cm (W x H x D)	4.75 x 4.4 x 2.3						
Mounting position	<input checked="" type="checkbox"/>	Other: Vehicle					
Modules/parts..... :	Module/parts of test item		Type	Manufacturer			
	WLAN/BLT module		QCA9377	Qualcomm			
	3G/LTE/GPS module		MDM9207	Qualcomm			
Accessories (not part of the test item)	Description		Type	Manufacturer			
	-						
Documents as provided by the applicant..... :	Description		File name	Issue date			
	PICS						
	User Manual						
	Instruction for testing						

Identification of the client

DANLAW INC
 41211 Vincenti Court, Novi, Michigan 48375, USA

Testing period and place

Test Location	DEKRA Testing and Certification S.A.U.
Date (start)	2019-08-12
Date (finish)	2019-09-27

Document history

Report number	Date	Description
61457RRF.003	2019-10-07	First release.
61457RRF.003A1	2019-10-28	Second release. RF Output Power measurements added on the modulation 16QAM. All results for the CANADA RSS-133 Issue 6 standard added. This modification test report cancels and replaces the test report 61457RRF.003
61457RRF.003A2	2020-01-22	Third release. Correction on measurement method on page 29. This modification test report cancels and replaces the test report 61457RRF.003A1

Environmental conditions

In the control chamber, the following limits were not exceeded during the test:

Temperature	Min. = 15 °C Max. = 35 °C
Relative humidity	Min. = 20 % Max. = 75 %

In the semianechoic chamber, the following limits were not exceeded during the test.

Temperature	Min. = 15 °C Max. = 35 °C
Relative humidity	Min. = 20 % Max. = 75 %
Air pressure	Min. = 860 mbar Max. = 1060 mbar

In the chamber for conducted measurements, the following limits were not exceeded during the test:

Temperature	Min. = 15 °C Max. = 35 °C
Relative humidity	Min. = 20 % Max. = 35
Air pressure	Min. = 860 mbar Max. = 1060 mbar

Remarks and comments

The tests have been performed by the technical personnel: José Manuel Jiménez, Miguel Ángel Torres, Verónica García, José Alberto Aranda, Jaime Barranquero, Cristina Calle, Jesús García.

Used instrumentation:

Conducted Measurements

	Last Calibration	Due Calibration
1. Chamber HERAEUS VMT 04/35	2018/06	2020/06
2. Wideband Radio Communication Tester ROHDE AND SCHWARZ CMW500	2019/05	2020/05
3. Signal Analyzer 20 Hz to 8 GHz ROHDE AND SCHWARZ FSQ8	2018/08	2020/08
4. DC Power Supply 40V/40A Rohde & Schwarz NGPE40	2018/02	2021/02
5. Signal and Spectrum Analyzer ROHDE AND SCHWARZ FSV40	2019/09	2021/09
6. Spectrum analyser Agilent PSA E4440A	2017/10	2019/10

Radiated Measurements

	Last Calibration	Due Calibration
1. Semianechoic Absorber Lined Chamber ETS LINDGREN FACT 3 200 STP	N.A.	N.A.
2. Wideband Radio Communication Tester ROHDE AND SCHWARZ CMW500	2019/05	2020/05
3. EMI Test Receiver ROHDE AND SCHWARZ ESR7	2018/10	2020/10
4. Biconical/Log Antenna ETS LINDGREN 3142E	2017/04	2020/04
5. Signal and Spectrum Analyzer ROHDE AND SCHWARZ FSW50	2018/02	2020/02
6. RF pre-amplifier 1-18 GHz Bonn Elektronik BLMA 0118-1M	2019/04	2020/04
7. Broadband Horn antenna 1-18 GHz SCHWARZBECK MESS-ELEKTRONIK BBHA 9120 D	2016/11	2019/11
8. DC Power Supply Keysight Technologies U8002A	---	---
9. Digital multimeter FLUKE 179	2019/06	2020/06
10. RF Pre-amplifier, G>48dB, 18-40GHz NARDA JS44-18004000-33-8P	2018/02	2020/02
11. Broadband Horn antenna 18 - 40 GHz SCHWARZBECK MESS-ELEKTRONIK BBHA 9170	2018/07	2021/07

Testing verdicts

Not applicable:	N/A
Pass:	P
Fail:	F
Not measured:	N/M

Summary

FCC PART 24 / RSS-133 PARAGRAPH		
Requirement – Test case	Verdict	Remark
Clause 24.232/RSS-133 Clause 6.4: RF output power	P	(1)
Clause 2.1047/RSS-133 Clause 6.2: Modulation characteristics	P	(1)
Clause 24.235/RSS-133 Clause 6.3: Frequency stability	P	(1)
Clause 2.1049: Occupied Bandwidth	P	(1)
Clause 24.238/RSS-133 Clause 6.5: Spurious emissions at antenna terminals	P	(1)
Clause 24.238/RSS-133 Clause 6.5: Radiated emissions	P	(1)
<u>Supplementary information and remarks:</u>		
<p>(1) HSDPA modulation mode has not been tested to prove USA FCC Part 24 compliance because it is an improved mode of operation only for Downlink (UE reception), but using the normal WCDMA mode for UL (Up Link, UE transmission). Therefore HSDPA has no associated a Power class or modulation scheme different than WCDMA mode for the UL transmission.</p> <p>Taking into account the above comments, testing in HSDPA modulation mode is redundant for FCC Part 24 as it is the same as WCDMA mode as long as UE transmission is concerned. WCDMA modulation mode has been tested as indicated on the present test report.</p>		

Appendix A: Test results for FCC PART 24 / RSS-133

INDEX

TEST CONDITIONS	11
RF Output Power	11
Frequency Stability	29
Modulation Characteristics	33
Occupied Bandwidth	36
Spurious emissions at antenna terminals.....	56
Spurious emissions at antenna terminals at Block Edges.....	72
Radiated emissions	89

TEST CONDITIONS

POWER SUPPLY (V):

Vn: 12 Vdc
 Vmin: 9 Vdc (*)
 Vmax: 15 Vdc (*)

Type of Power Supply: External power supply (car battery).

The subscripts 'n', 'min' and 'max' indicate voltage test conditions (nominal, minimum and maximum respectively), as declared by the applicant.

ANTENNA:

MIDDLE Bands		ANTENNA TYPE
3G WCDMA Band II	2.5 dBi	Internal (embedded in the plastics of the device)
LTE Band 2	2.5 dBi	Internal (embedded in the plastics of the device)

TEST FREQUENCIES:

3G Band II:

WCDMA and HSUPA MODULATIONS:

Lowest Channel (9262): 1852.4 MHz
 Middle Channel (9400): 1880.0 MHz
 Highest Channel (9538): 1907.6 MHz

LTE Band 2. QPSK AND 16QAM MODULATIONS:

	Channel (Frequency)					
	BW = 1.4 MHz	BW = 3 MHz	BW = 5 MHz	BW = 10 MHz	BW = 15 MHz	BW = 20 MHz
Lowest	18607 (1850.7 MHz)	18615 (1851.5 MHz)	18625 (1852.5 MHz)	18650 (1855 MHz)	18675 (1857.5 MHz)	18700 (1860 MHz)
Middle	18900 (1880 MHz)	18900 (1880 MHz)	18900 (1880 MHz)	18900 (1880 MHz)	18900 (1880 MHz)	18900 (1880 MHz)
Highest	19193 (1909.3 MHz)	19185 (1908.5 MHz)	19175 (1907.5 MHz)	19150 (1905 MHz)	19125 (1902.5 MHz)	19100 (1900 MHz)

Note: LTE Category 1 device, so for BW=10 MHz, 15 MHz and 20 MHz the 16QAM modulation does not support transmission in RB=All.

RF Output Power

SPECIFICATION:

FCC §2.1046 and §24.232

Mobile/portable stations are limited to 2 Watts (33 dBm) Effective Isotropic Radiated Power (E.I.R.P.).
The peak-to-average ratio (PAR) of the transmission shall not exceed 13 dB.

RSS-133. Clause 6.4.

The peak-to-average power ratio (PAPR) shall not exceed 13 dB for more than 0.1% of the time using a signal corresponding to the highest PAPR during periods of continuous transmission.

METHOD:

The conducted RF output power measurements were made at the RF output terminals of the EUT using the power meter of the Universal Radio Communication tester CMW500, selecting maximum transmission power of the EUT and different modes of modulation.

The maximum equivalent isotropically radiated power (e.i.r.p.) is calculated by adding the declared maximum antenna gain (dBi).

The peak-to-average power ratio (PAPR) is measured using an attenuator, power splitter and spectrum analyser with a Complementary Cumulative Distribution Function implemented.

The EUT was controlled via the Universal Radio Communication tester R&S CMW500 selecting maximum transmission power of the EUT and different modes of modulation.

TEST SETUP:

1. CONDUCTED AVERAGE POWER:



2. PEAK-TO-AVERAGE POWER RATIO (PAPR):

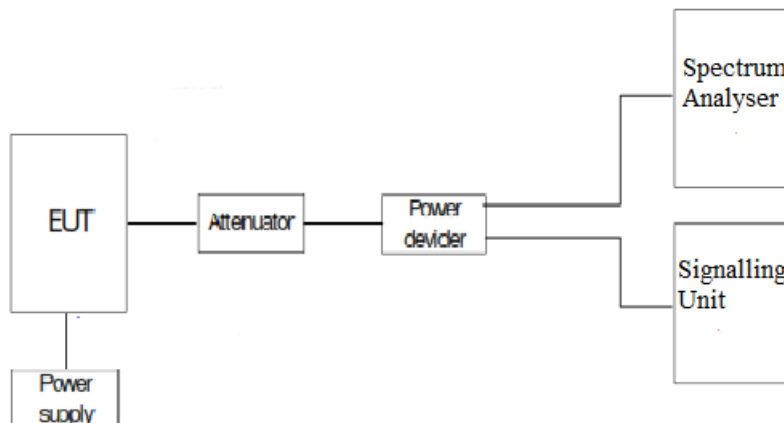

RESULTS:

1. AVERAGE POWER:

3G Band II:

WCDMA MODULATION:

Channel	Lowest	Middle	Highest
Maximum declared antenna gain (dBi)	2.50	2.50	2.50
Measured maximum average power (dBm) at antenna port	22.38	22.47	22.19
Maximum effective isotropically radiated average power E.I.R.P. (dBm)	24.88	24.97	24.69
Peak-to-average ratio (PAR) (dB)	3.21	3.05	3.05
Measurement uncertainty (dB)	<±0.66		

HSUPA MODULATION:

Channel	Lowest	Middle	Highest
Maximum declared antenna gain (dBi)	2.50	2.50	2.50
Measured maximum average power (dBm) at antenna port	20.52	20.59	20.47
Maximum effective isotropically radiated average power E.I.R.P. (dBm)	23.02	23.09	22.97
Peak-to-average ratio (PAR) (dB)	3.19	3.33	3.41
Measurement uncertainty (dB)	<±0.66		

LTE BAND 2:

LTE Band 2. QPSK MODULATION. Bandwidth = 1.4 MHz.

Channel	Lowest	Middle	Highest
Maximum declared antenna gain (dBi)	2.50	2.50	2.50
Measured maximum average power (dBm) at antenna port	22.45	23.48	22.18
Maximum equivalent isotropically radiated power (E.I.R.P.) (dBm)	24.95	25.98	24.68
Peak-to-average ratio (PAR) (dB)	(*)	(*)	(*)
Measurement uncertainty (dB)	<±0.66		

Worst case AVERAGE POWER: Modulation QPSK. RB Size: 1. RB Offset: 2.

(*): Preliminary measurements determined PAPR of 16QAM as the worst case.

LTE Band 2. 16QAM MODULATION. Bandwidth = 1.4 MHz.

Channel	Lowest	Middle	Highest
Maximum declared antenna gain (dBi)	2.50	2.50	2.50
Measured maximum average power (dBm) at antenna port	22.46	22.17	21.86
Maximum equivalent isotropically radiated power (E.I.R.P.) (dBm)	24.96	24.67	24.36
Peak-to-average ratio (PAR) (dB)	5.99	6.09	5.5
Measurement uncertainty (dB)	<±0.66		

Worst case AVERAGE POWER:
 Worst case PAPR:

Modulation 16QAM. RB Size: 3. RB Offset: 1.
 Modulation 16QAM. RB Size: 6. RB Offset: 0.

LTE Band 2. QPSK MODULATION. Bandwidth = 3 MHz.

Channel	Lowest	Middle	Highest
Maximum declared antenna gain (dBi)	2.50	2.50	2.50
Measured maximum average power (dBm) at antenna port	22.47	23.24	22.14
Maximum equivalent isotropically radiated power (E.I.R.P.) (dBm)	24.97	25.74	24.64
Peak-to-average ratio (PAR) (dB)	(*)	(*)	(*)
Measurement uncertainty (dB)	<±0.66		

Worst case AVERAGE POWER:

Modulation QPSK. RB Size: 1. RB Offset: 7.

(*): Preliminary measurements determined PAPR of 16QAM as the worst case.

LTE Band 2. 16QAM MODULATION. Bandwidth = 3 MHz.

Channel	Lowest	Middle	Highest
Maximum declared antenna gain (dBi)	2.50	2.50	2.50
Measured maximum average power (dBm) at antenna port	22.02	22.12	21.99
Maximum equivalent isotropically radiated power (E.I.R.P.) (dBm)	24.52	24.62	24.49
Peak-to-average ratio (PAR) (dB)	5.99	6.12	5.99
Measurement uncertainty (dB)	<±0.66		

Worst case AVERAGE POWER:
 Worst case PAPR:

Modulation 16QAM. RB Size: 1. RB Offset: 0.
 Modulation 16QAM. RB Size: 15. RB Offset: 0.

LTE Band 2. QPSK MODULATION. Bandwidth = 5 MHz.

Channel	Lowest	Middle	Highest
Maximum declared antenna gain (dBi)	2.50	2.50	2.50
Measured maximum average power (dBm) at antenna port	22.45	23.20	22.65
Maximum equivalent isotropically radiated power (E.I.R.P.) (dBm)	24.95	25.70	25.15
Peak-to-average ratio (PAR) (dB)	(*)	(*)	(*)
Measurement uncertainty (dB)	<±0.66		

Worst case AVERAGE POWER: Modulation QPSK. RB Size: 1. RB Offset: 12.

(*): Preliminary measurements determined PAPR of 16QAM as the worst case.

LTE Band 2. 16QAM MODULATION. Bandwidth = 5 MHz.

Channel	Lowest	Middle	Highest
Maximum declared antenna gain (dBi)	2.50	2.50	2.50
Measured maximum average power (dBm) at antenna port	22.02	21.92	21.61
Maximum equivalent isotropically radiated power (E.I.R.P.) (dBm)	24.52	24.42	24.11
Peak-to-average ratio (PAR) (dB)	5.99	5.93	5.93
Measurement uncertainty (dB)	<±0.66		

Worst case AVERAGE POWER: Modulation 16QAM. RB Size: 1. RB Offset: 12.
 Worst case PAPR: Modulation 16QAM. RB Size: 25. RB Offset: 0.

LTE Band 2. QPSK MODULATION. Bandwidth = 10 MHz.

Channel	Lowest	Middle	Highest
Maximum declared antenna gain (dBi)	2.50	2.50	2.50
Measured maximum average power (dBm) at antenna port	22.26	23.51	22.17
Maximum equivalent isotropically radiated power (E.I.R.P.) (dBm)	24.76	26.01	24.67
Peak-to-average ratio (PAR) (dB)	5.18	5.18	5
Measurement uncertainty (dB)	<±0.66		

Worst case AVERAGE POWER: Modulation QPSK. RB Size: 1. RB Offset: 24.
 Worst case PAPR: Modulation QPSK. RB Size: 50. RB Offset: 0.

(*): Not supported the modulation 16QAM.

LTE Band 2. QPSK MODULATION. Bandwidth = 15 MHz.

Channel	Lowest	Middle	Highest
Maximum declared antenna gain (dBi)	2.50	2.50	2.50
Measured maximum average power (dBm) at antenna port	22.47	23.71	22.25
Maximum equivalent isotropically radiated power (E.I.R.P.) (dBm)	24.97	26.21	24.75
Peak-to-average ratio (PAR) (dB)	5.22	5.22	5.37
Measurement uncertainty (dB)	<±0.66		

Worst case AVERAGE POWER: Modulation QPSK. RB Size: 1. RB Offset: 37.
 Worst case PAPR: Modulation QPSK. RB Size: 75. RB Offset: 0.

(*): Not supported the modulation 16QAM.

LTE Band 2. QPSK MODULATION. Bandwidth = 20 MHz.

Channel	Lowest	Middle	Highest
Maximum declared antenna gain (dBi)	2.50	2.50	2.50
Measured maximum average power (dBm) at antenna port	22.24	23.48	22.40
Maximum equivalent isotropically radiated power (E.I.R.P.) (dBm)	24.74	25.98	24.90
Peak-to-average ratio (PAR) (dB)	5.21	5.06	5.14
Measurement uncertainty (dB)	<±0.66		

Worst case AVERAGE POWER: Modulation QPSK. RB Size: 1. RB Offset: 49.
 Worst case PAPR: Modulation QPSK. RB Size: 100. RB Offset: 0.

(*): Not supported the modulation 16QAM.

Verdict: PASS

2. PEAK-TO-AVERAGE POWER RATIO (PAPR):

3G Band II. WCDMA MODULATION.

Lowest Channel:

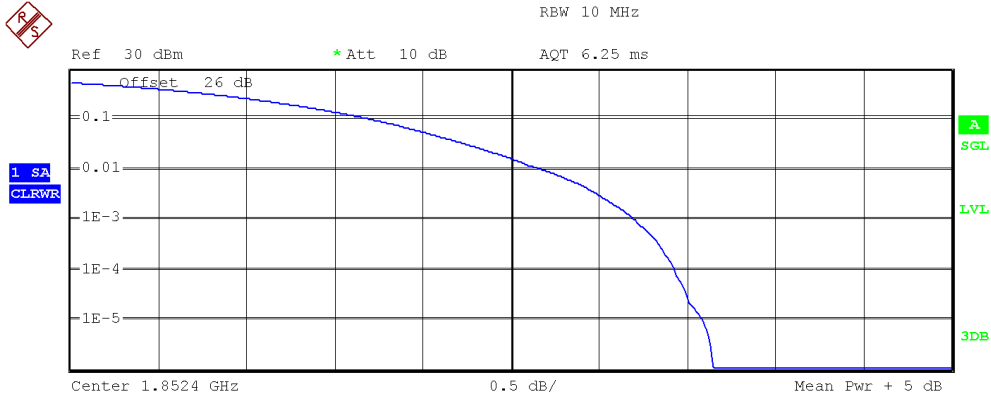

Complementary Cumulative Distribution Function
 NOF samples: 100000, Usable BW: 11.2MHz

Trace 1	
Mean	22.74 dBm
Peak	26.39 dBm
Crest	3.65 dB
10 %	1.70 dB
1 %	2.68 dB
.1 %	3.21 dB
.01 %	3.43 dB

Middle Channel:

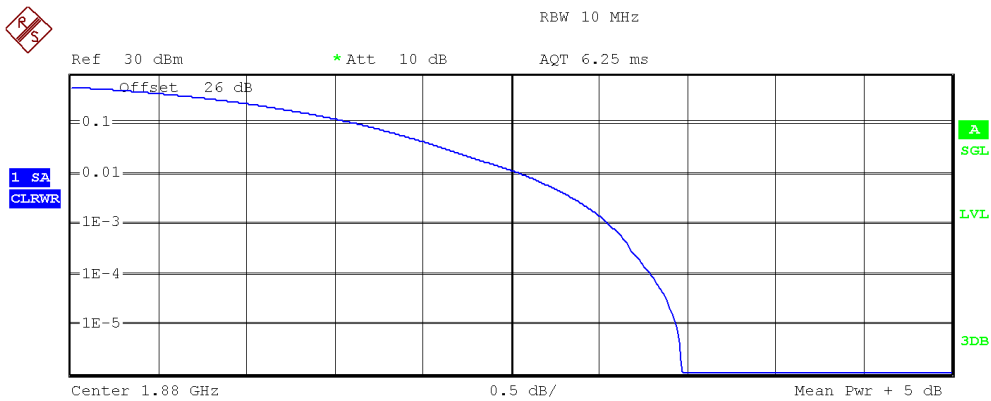

Complementary Cumulative Distribution Function
 NOF samples: 100000, Usable BW: 11.2MHz

Trace 1	
Mean	22.90 dBm
Peak	26.37 dBm
Crest	3.47 dB
10 %	1.63 dB
1 %	2.56 dB
.1 %	3.05 dB
.01 %	3.29 dB

Highest Channel:

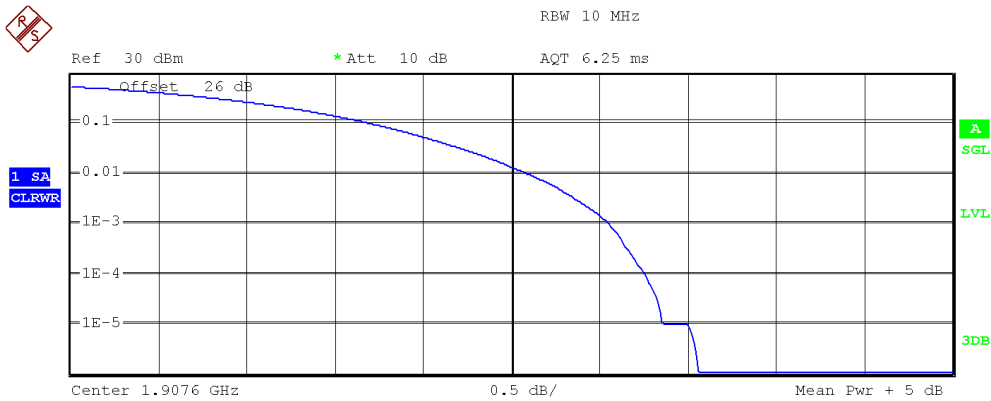

Center 1.9076 GHz 0.5 dB/ Mean Pwr + 5 dB
 Complementary Cumulative Distribution Function
 NOF samples: 100000, Usable BW: 11.2MHz

	Trace 1
Mean	22.58 dBm
Peak	26.14 dBm
Crest	3.56 dB
10 %	1.70 dB
1 %	2.59 dB
.1 %	3.05 dB
.01 %	3.25 dB

3G Band II. HSUPA MODULATION.

Lowest Channel:

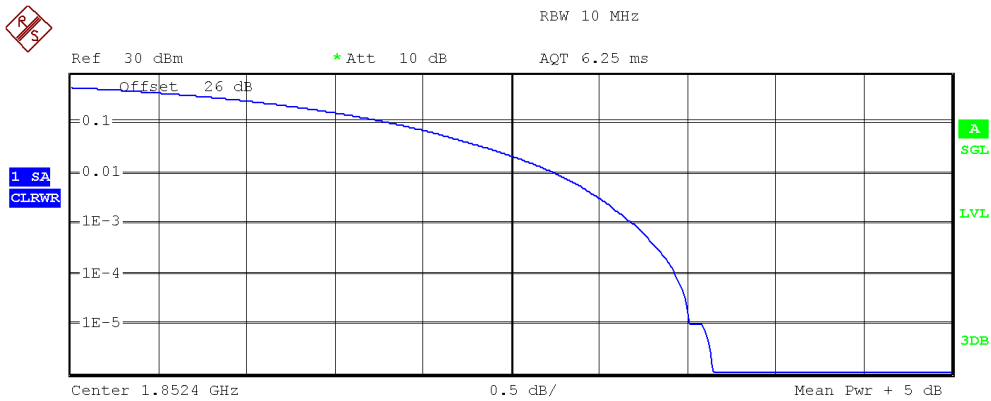

Center 1.8524 GHz 0.5 dB/ Mean Pwr + 5 dB
 Complementary Cumulative Distribution Function
 NOF samples: 100000, Usable BW: 11.2MHz

	Trace 1
Mean	21.68 dBm
Peak	25.33 dBm
Crest	3.65 dB
10 %	1.83 dB
1 %	2.75 dB
.1 %	3.19 dB
.01 %	3.44 dB

Middle Channel:

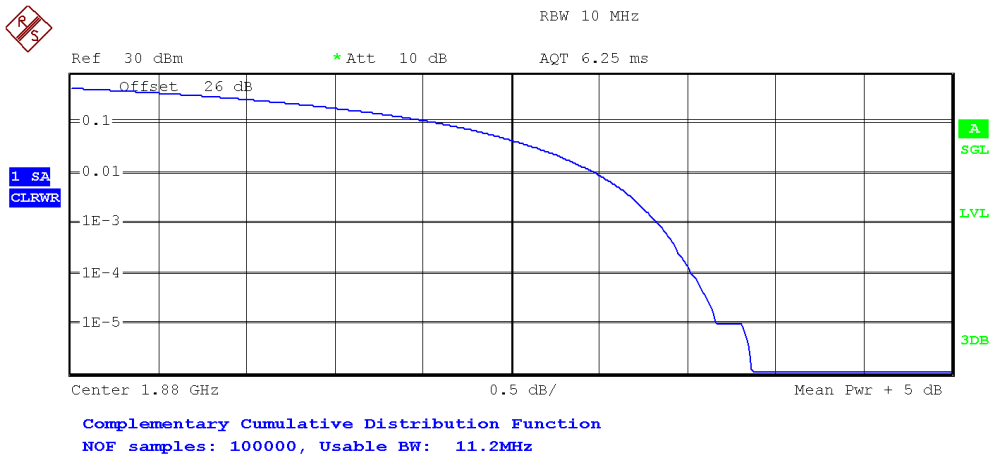

Trace 1	
Mean	21.30 dBm
Peak	25.17 dBm
Crest	3.87 dB
10 %	2.09 dB
1 %	2.98 dB
.1 %	3.33 dB
.01 %	3.53 dB

Highest Channel:

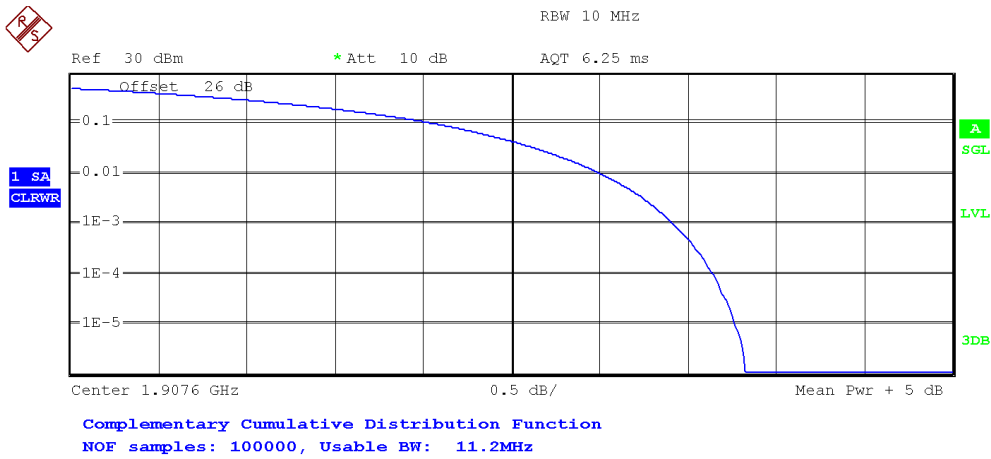

Trace 1	
Mean	21.11 dBm
Peak	24.94 dBm
Crest	3.83 dB
10 %	2.05 dB
1 %	3.00 dB
.1 %	3.41 dB
.01 %	3.65 dB

LTE Band 2. Bandwidth = 1.4 MHz. Modulation 16 QAM. RB Size: 6. RB Offset: 0.

Lowest Channel:

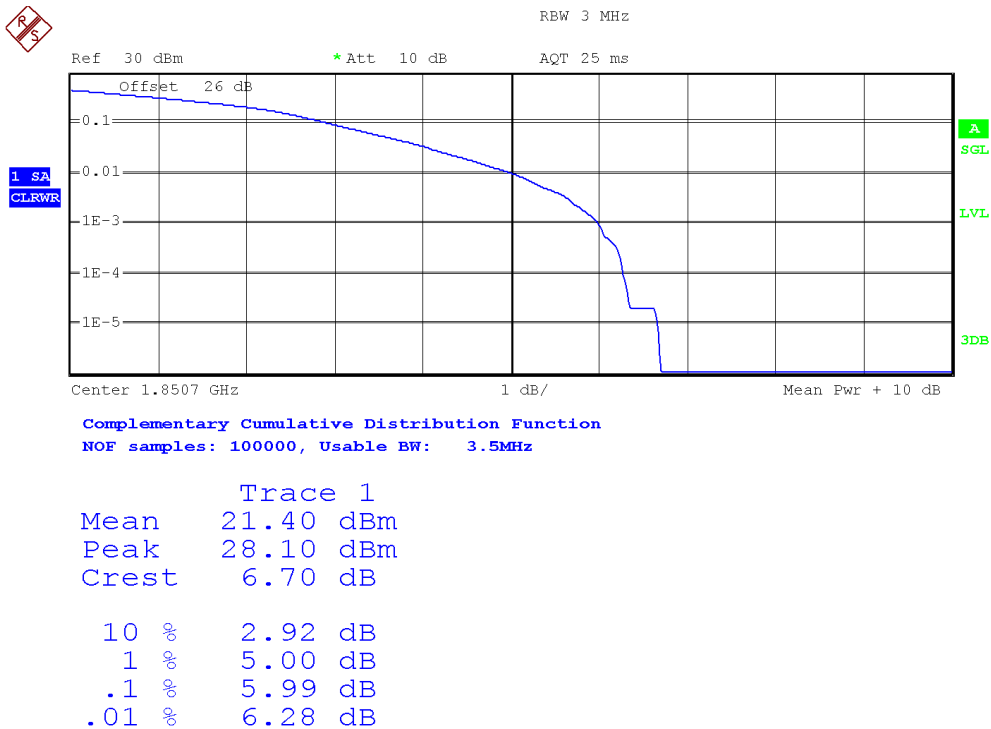

Middle Channel:

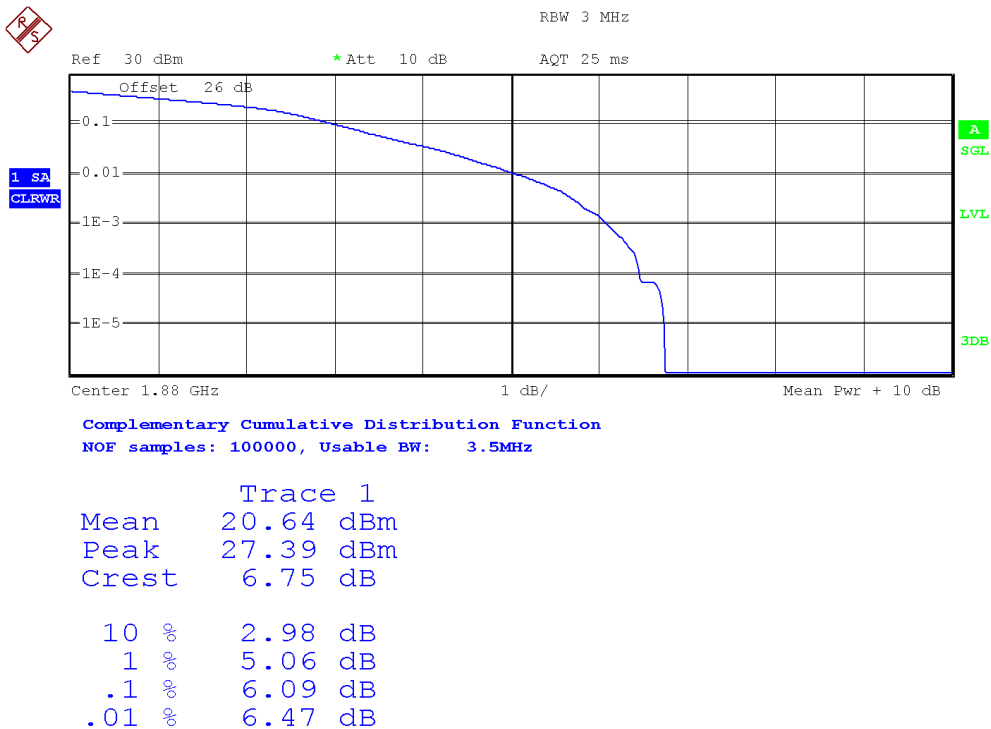

Highest Channel:

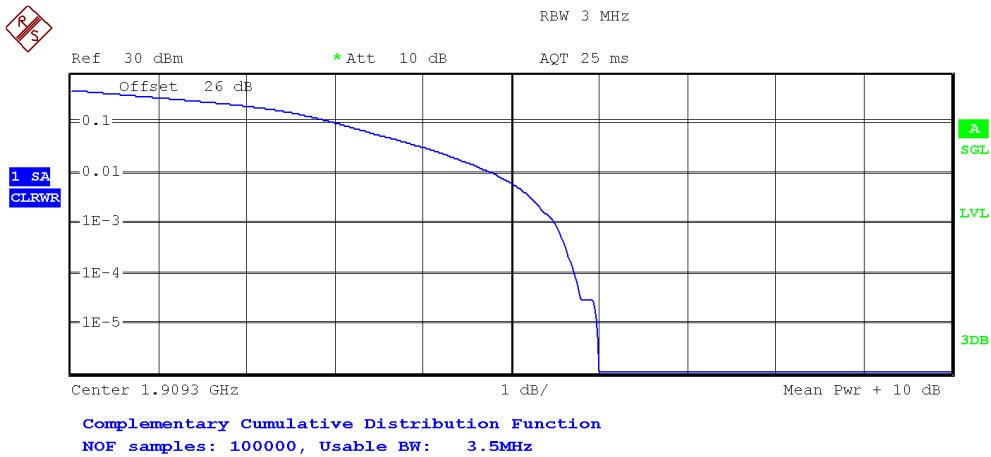

	Trace 1
Mean	20.69 dBm
Peak	26.69 dBm
Crest	6.00 dB
10 %	3.01 dB
1 %	4.79 dB
.1 %	5.50 dB
.01 %	5.72 dB

LTE Band 2. Bandwidth = 3 MHz. Modulation 16 QAM. RB Size: 15. RB Offset: 0.

Lowest Channel:

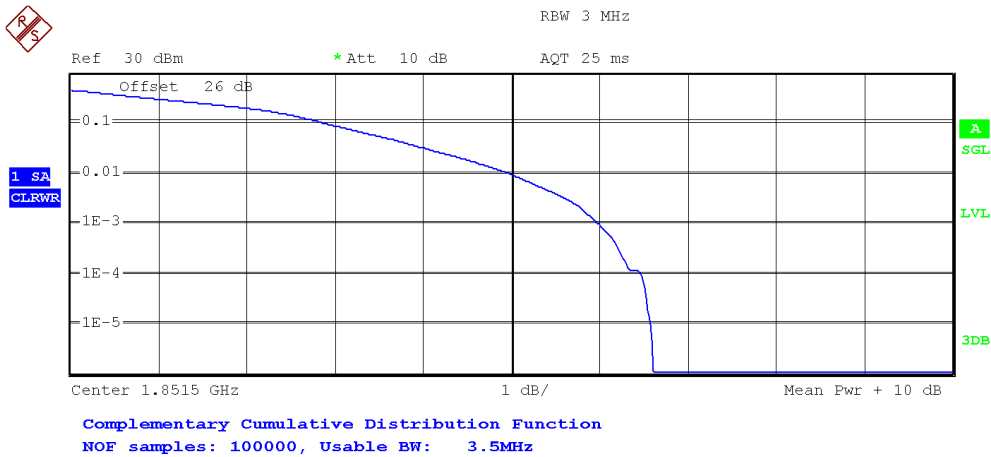

	Trace 1
Mean	21.14 dBm
Peak	27.75 dBm
Crest	6.61 dB
10 %	2.88 dB
1 %	4.97 dB
.1 %	5.99 dB
.01 %	6.47 dB

Middle Channel:

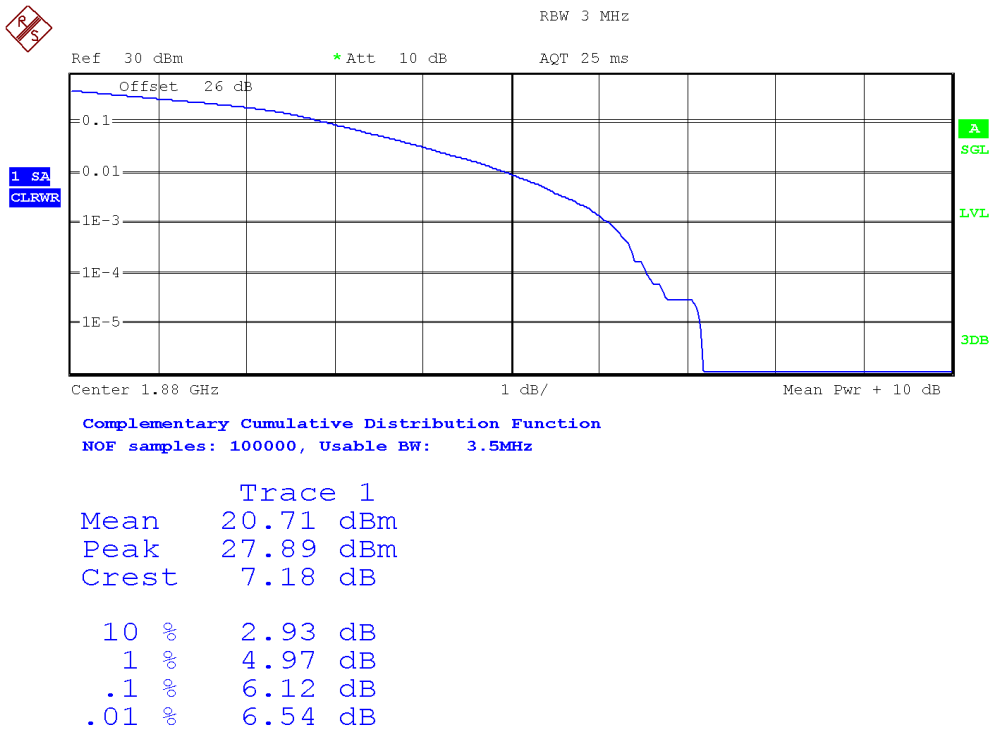

Highest Channel:

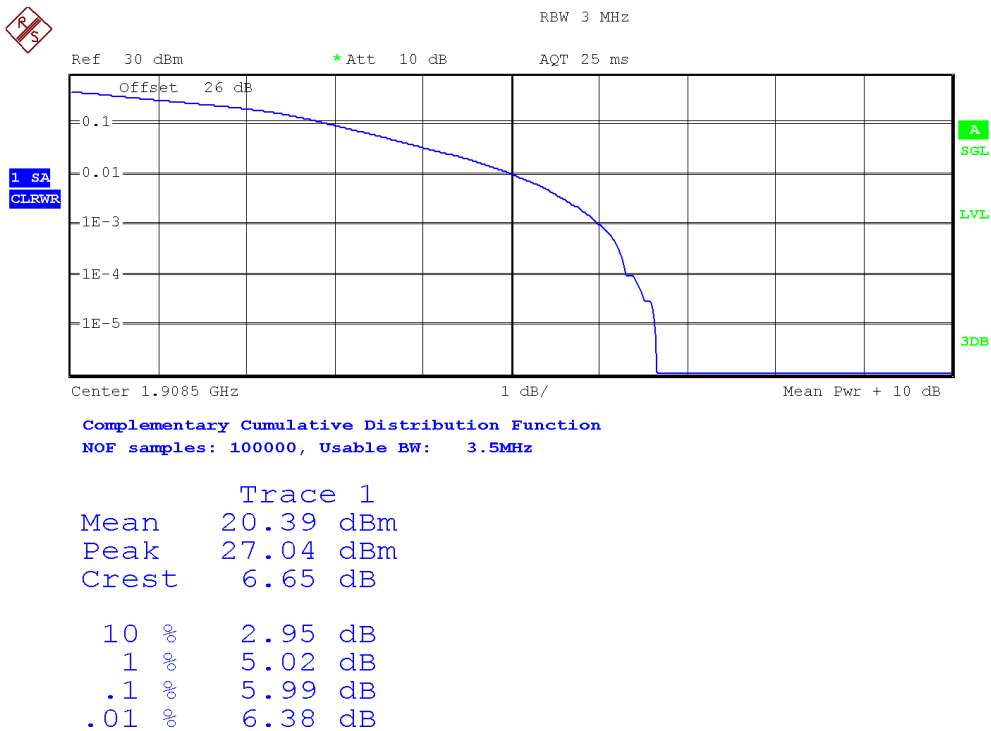

LTE Band 2. Bandwidth = 5 MHz. Modulation 16 QAM. RB Size: 25. RB Offset: 0.

Lowest Channel:

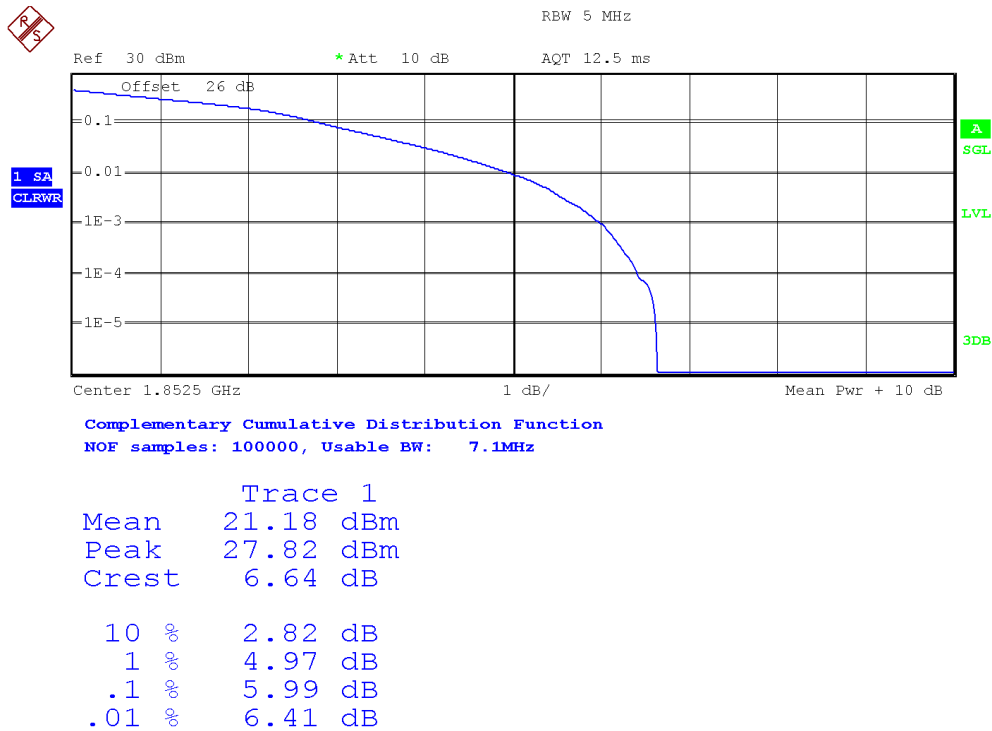

Middle Channel:

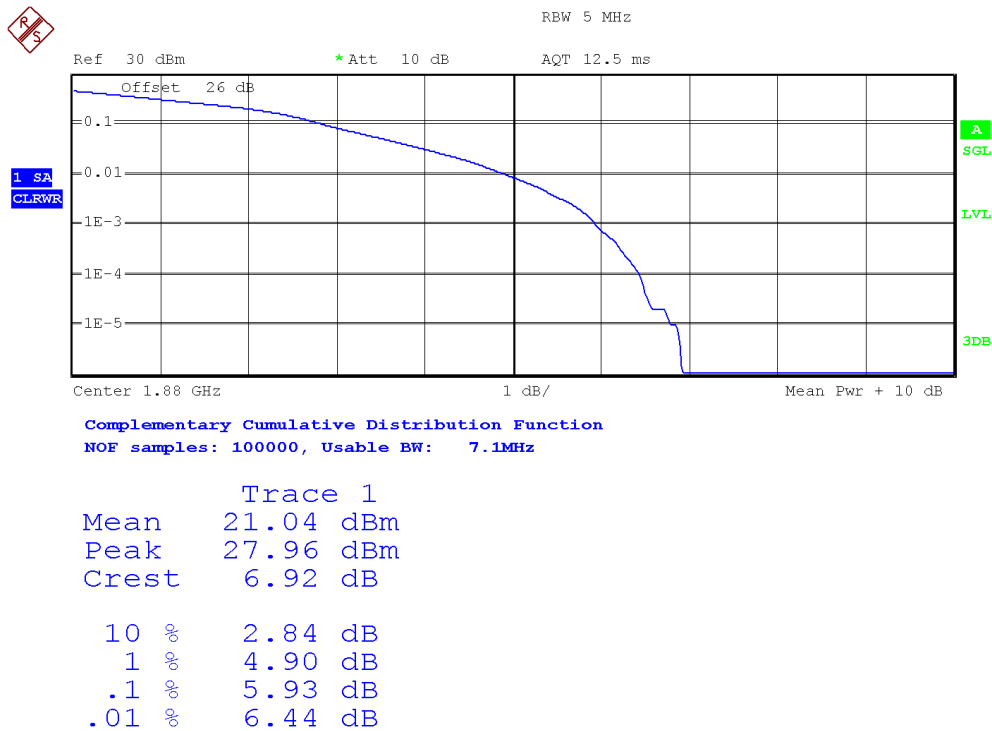

Highest Channel:

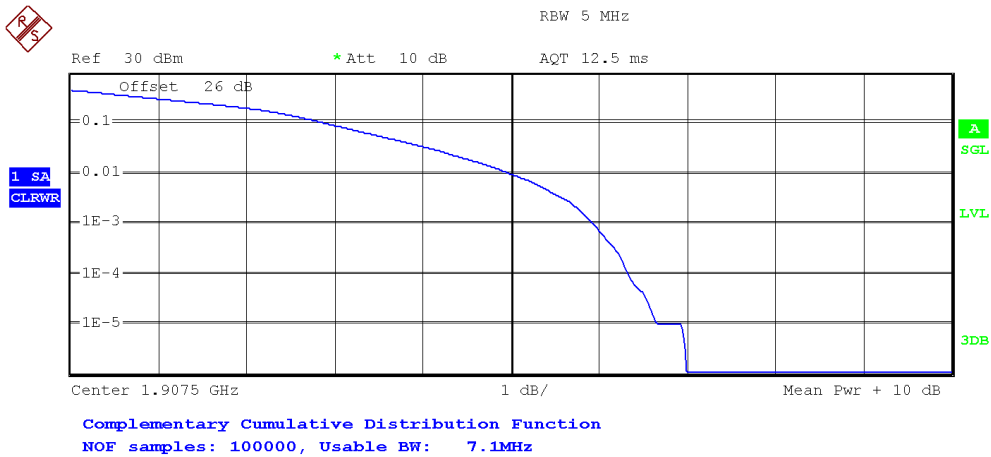

Trace 1	
Mean	20.47 dBm
Peak	27.46 dBm
Crest	7.00 dB
10 %	2.90 dB
1 %	4.98 dB
.1 %	5.93 dB
.01 %	6.33 dB

LTE Band 2. Bandwidth = 10 MHz. Modulation QPSK. RB Size: 50. RB Offset: 0.

Lowest Channel:

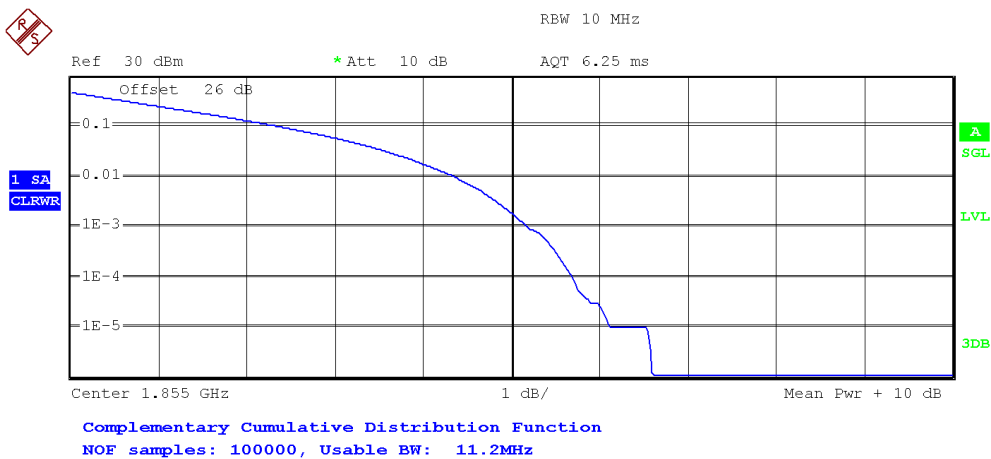

Trace 1	
Mean	22.27 dBm
Peak	28.87 dBm
Crest	6.60 dB
10 %	2.36 dB
1 %	4.34 dB
.1 %	5.18 dB
.01 %	5.69 dB

Middle Channel:

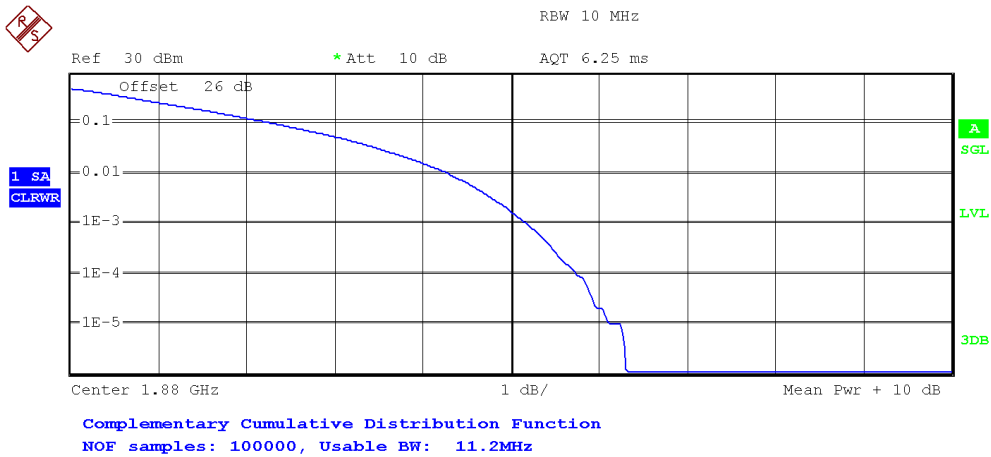

Trace 1	
Mean	22.11 dBm
Peak	28.42 dBm
Crest	6.31 dB
10 %	2.29 dB
1 %	4.28 dB
.1 %	5.18 dB
.01 %	5.74 dB

Highest Channel:

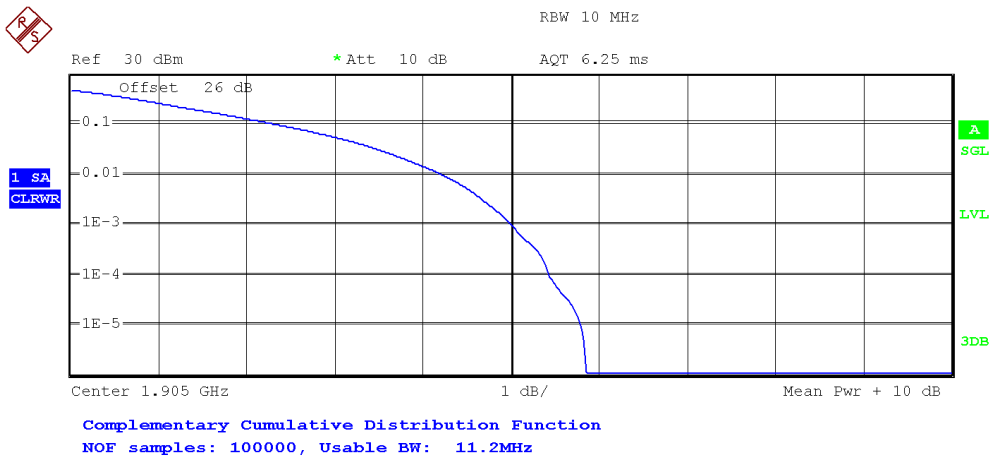

Trace 1	
Mean	21.90 dBm
Peak	27.76 dBm
Crest	5.86 dB
10 %	2.32 dB
1 %	4.20 dB
.1 %	5.00 dB
.01 %	5.43 dB

LTE Band 2. Bandwidth = 15 MHz. Modulation QPSK. RB Size: 75. RB Offset: 0.

Lowest Channel:

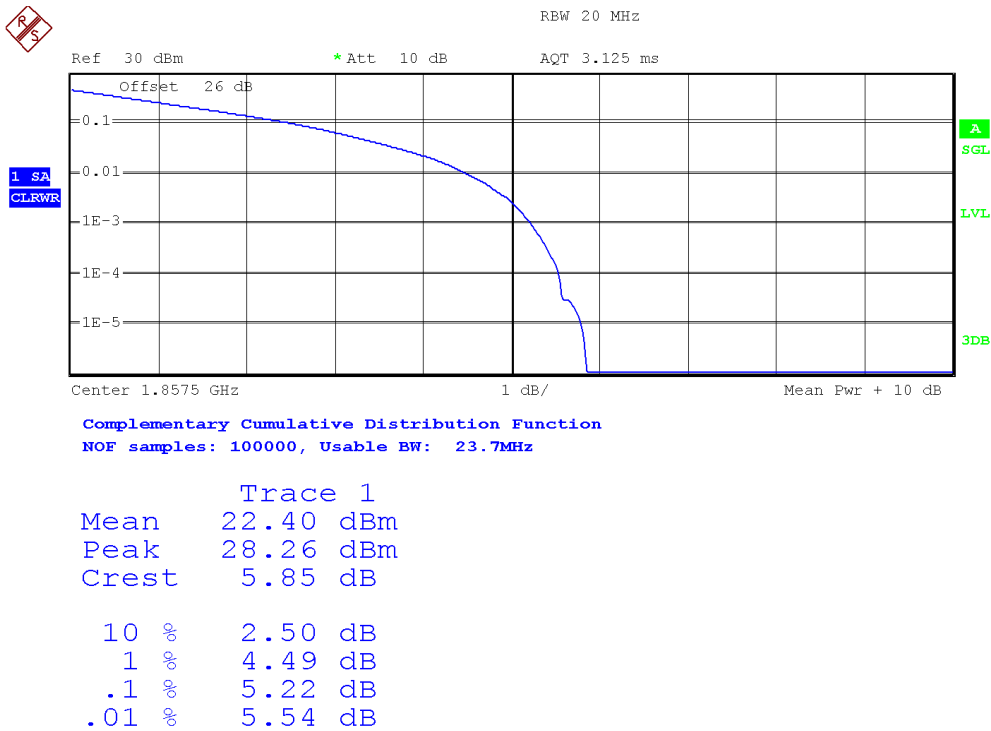

Middle Channel:

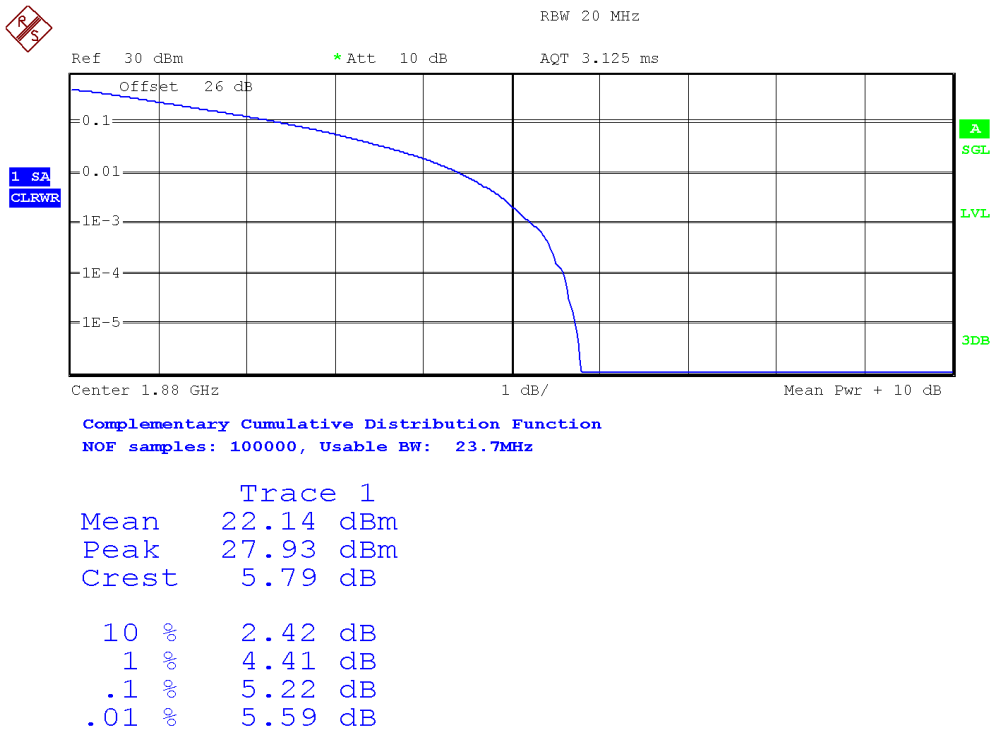

Highest Channel:

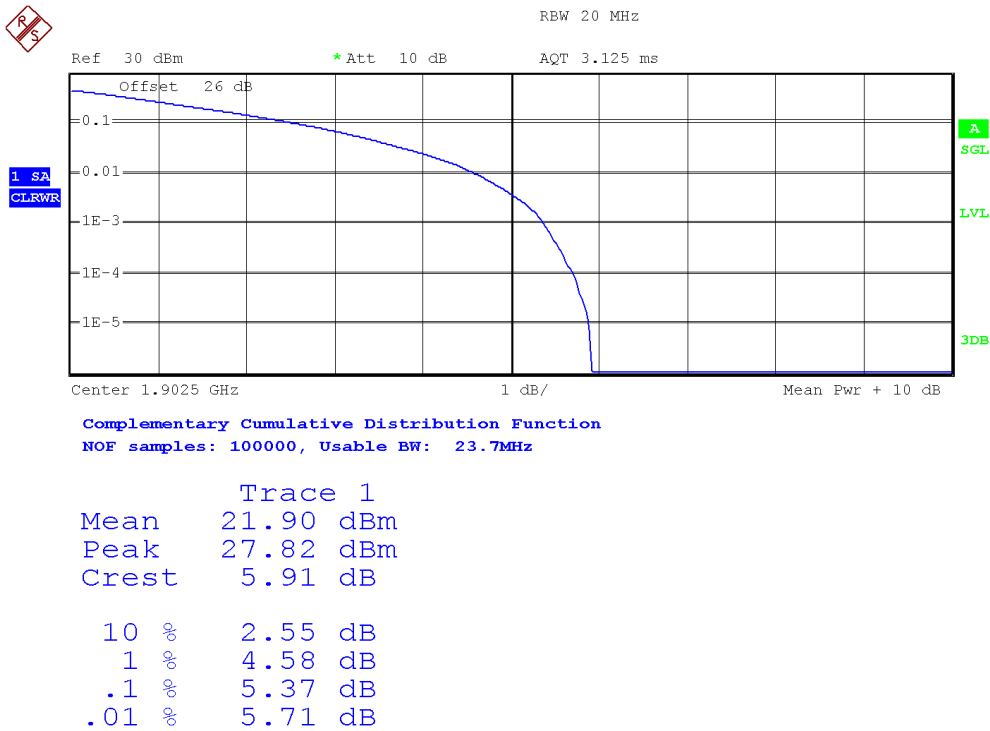

LTE Band 2. Bandwidth = 20 MHz. Modulation QPSK. RB Size: 100. RB Offset: 0.

Lowest Channel:

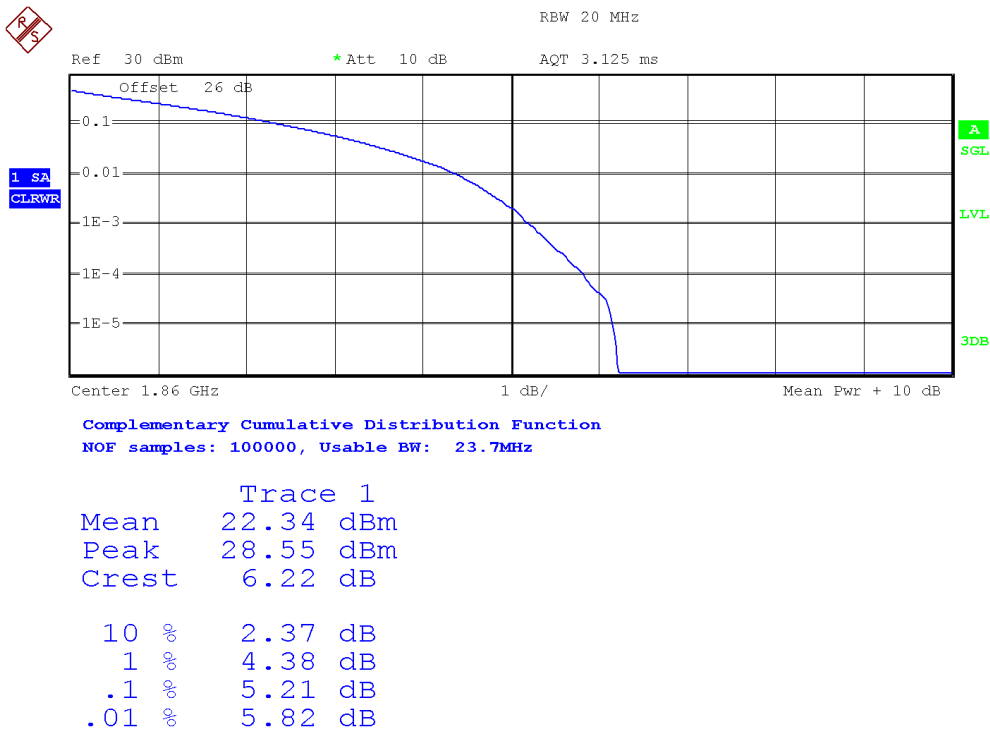

Middle Channel:

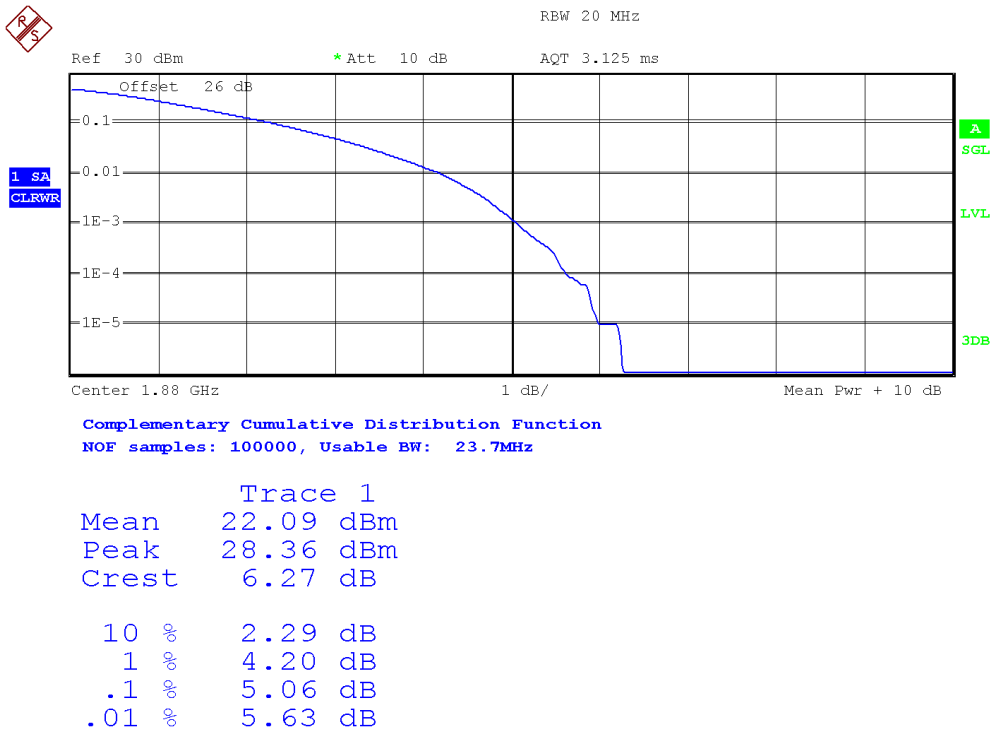

Highest Channel:

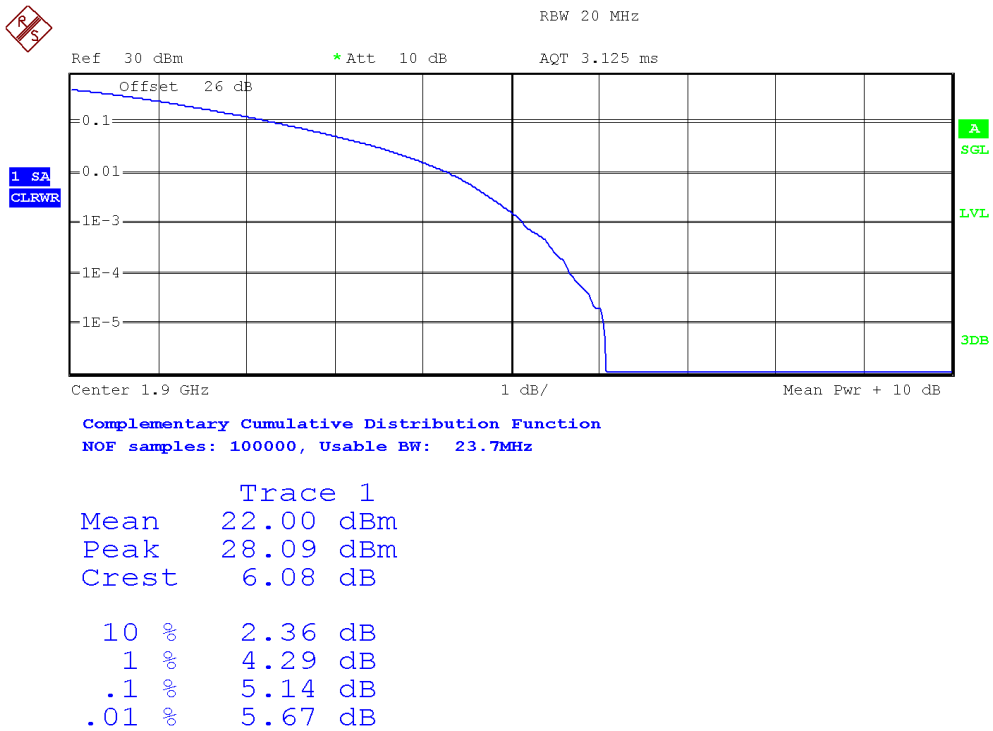

Frequency Stability

SPECIFICATION:

FCC §2.1055 and §24.235. The frequency stability shall be sufficient to ensure that the fundamental emission stays within the authorized frequency block.

RSS-133. Clause 6.3. The carrier frequency shall not depart from the reference frequency in excess of ± 2.5 ppm for mobile stations.

METHOD:

The frequency tolerance measurements over temperature variations were made over the temperature range of -30°C to $+50^{\circ}\text{C}$. The EUT was placed inside a climatic chamber and the temperature was raised hourly in 10°C steps from -30°C up to $+50^{\circ}\text{C}$.

The supply voltage was varied between 85% and 115% of nominal voltage.

The EUT was set in "Radio Resource Control (RRC) mode" in the middle channel using the Universal Radio Communication tester R&S CMW500 and the maximum frequency error was measured using the built-in calibrated frequency meter.

In order to check that the frequency stability is sufficient such that the fundamental emissions stay within the authorized bands of operation, a reference point is established at the applicable unwanted emissions limit using a RBW equal to the RBW required by the unwanted emissions specification of the applicable regulatory standard. These reference points measured using the lowest and highest channel of operation are identified as fL and fH respectively. The worst-case frequency offset determined in the above methods is added or subtracted from the values of fL and fH to check that the resulting frequencies remain within the band.

The reference point measurements were made at the RF output terminals of the EUT using an attenuator, power splitter and spectrum analyser. The EUT was controlled via the Universal Radio Communication tester R&S CMW500 selecting maximum transmission power of the EUT and different modes of modulation.

TEST SETUP:

1. Frequency Tolerance:

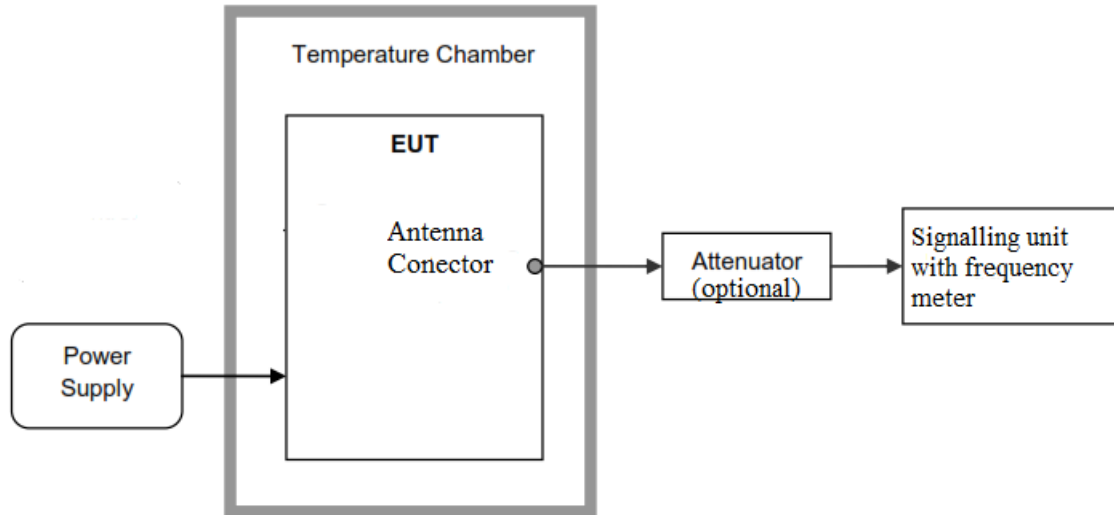

2. Reference Frequency Points f_L and f_H :

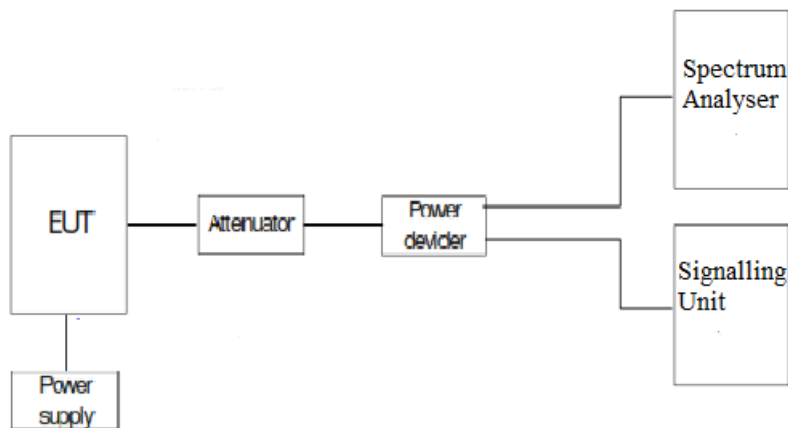

RESULTS:

1. Frequency Tolerance:

• **Frequency Stability over Temperature Variations:**

3G Band II. WCDMA AND HSUPA MODULATION.

Temperature (°C)	Frequency Error (Hz)	Frequency Error (ppm)
+50	-0.21	-0.000111702
+40	-2.97	-0.001579787
+30	-0.54	-0.000287234
+20	-0.34	-0.000180851
+10	-2.65	-0.001409574
0	-0.25	-0.000132979
-10	-2.71	-0.001441489
-20	-0.1	-5.31915E-05
-30	0.15	7.97872E-05

LTE Band 2. QPSK MODULATION. BW = 10 MHz.

Temperature (°C)	Frequency Error (Hz)	Frequency Error (ppm)
+50	-3.68	-0.001957447
+40	-3.55	-0.001888298
+30	-3.76	-0.002
+20	-3.05	-0.00162234
+10	-2.55	-0.001356383
0	-2.36	-0.001255319
-10	-2.32	-0.001234043
-20	-3.35	-0.001781915
-30	-2.02	-0.001074468

- **Frequency Stability over Voltage Variations.**

3G Band II. WCDMA AND HSUPA MODULATIONS.

Battery Supply voltage	Voltage (V)	Frequency Error (Hz)	Frequency Error (ppm)
Vmax	15	-1.03	-0.000547872
Vmin(*)	9	-1.02	-0.000542553

(*): Operating end point specified by the manufacturer.

LTE Band 2. QPSK MODULATION. BW = 3 MHz.

Battery Supply voltage	Voltage (V)	Frequency Error (Hz)	Frequency Error (ppm)
Vmax	15	-3.69	-0.001962766
Vmin(*)	9	-3.35	-0.001781915

(*): Operating end point specified by the manufacturer.

2. Reference Frequency Points fL and fH:

The worst-case frequency offsets added or subtracted per band and bandwidth:

3G Band II:

	WCDMA MODULATION
fL (MHz)	1850.1038430300
fH (MHz)	1909.8871791500

LTE Band 2:

	LTE QPSK MODULATION. BW = 3 MHz
fL (MHz)	1850.0470
fH (MHz)	1909.9647

Measurement uncertainty	<±1x 10 ⁻⁶
-------------------------	-----------------------

The reference frequency points fL and fH stay within the authorized blocks for all the bands above.

Verdict: PASS

Modulation Characteristics

SPECIFICATION:

FCC §2.1047

RSS-133. Clause 6.2. Equipment certified under this standard shall use digital modulation.

METHOD:

For 3G, the EUT operates with WCDMA (QPSK) and HSUPA (QPSK) modulation modes, in which the information is digitized and coded into a bit stream.

For LTE the EUT operates with QPSK and 16QAM modulation modes in which the information is digitised and coded into a bit stream. The RF transmission is multiplexed using *Orthogonal Frequency Division Multiplexing (OFDM)* using different possible arrangement of subcarriers (Resource Blocks RB).

TEST SETUP:

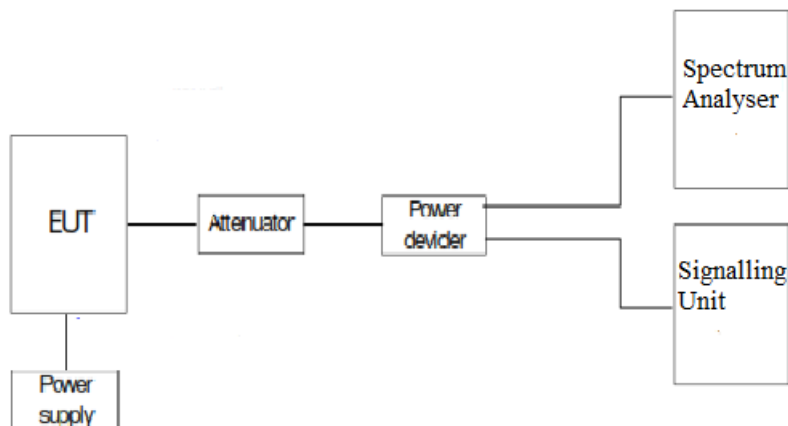

RESULTS:

The following plots show the modulation schemes in the EUT.

3G Band II. WCDMA MODULATION.

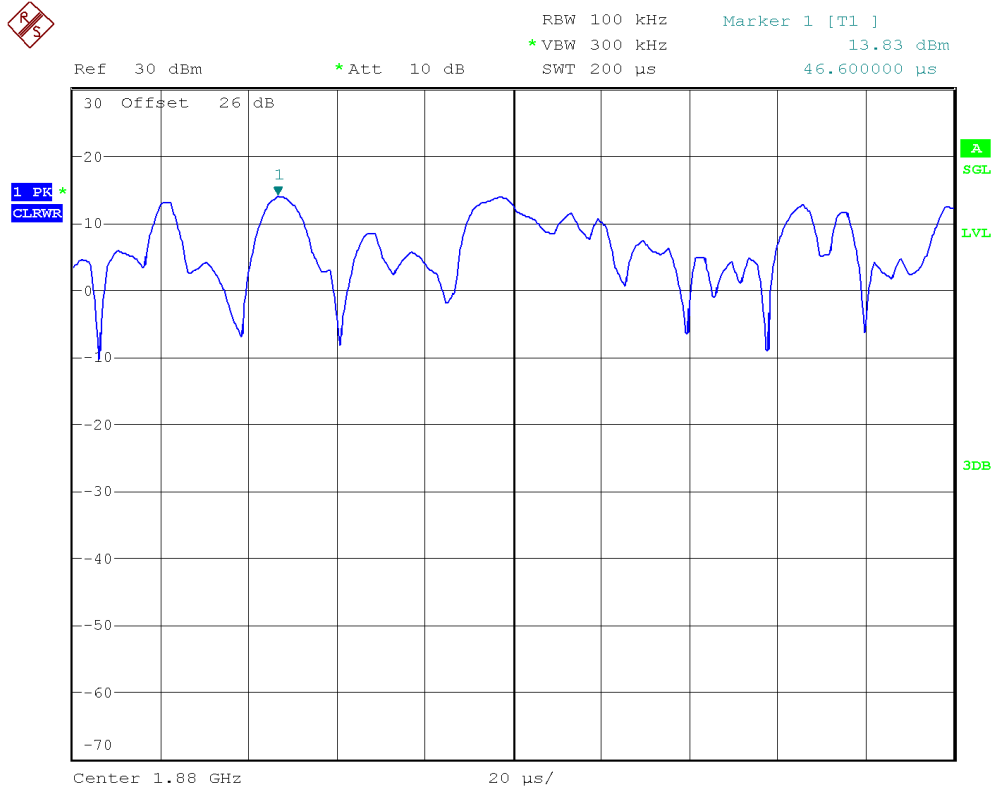

3G Band II. HSUPA MODULATION.

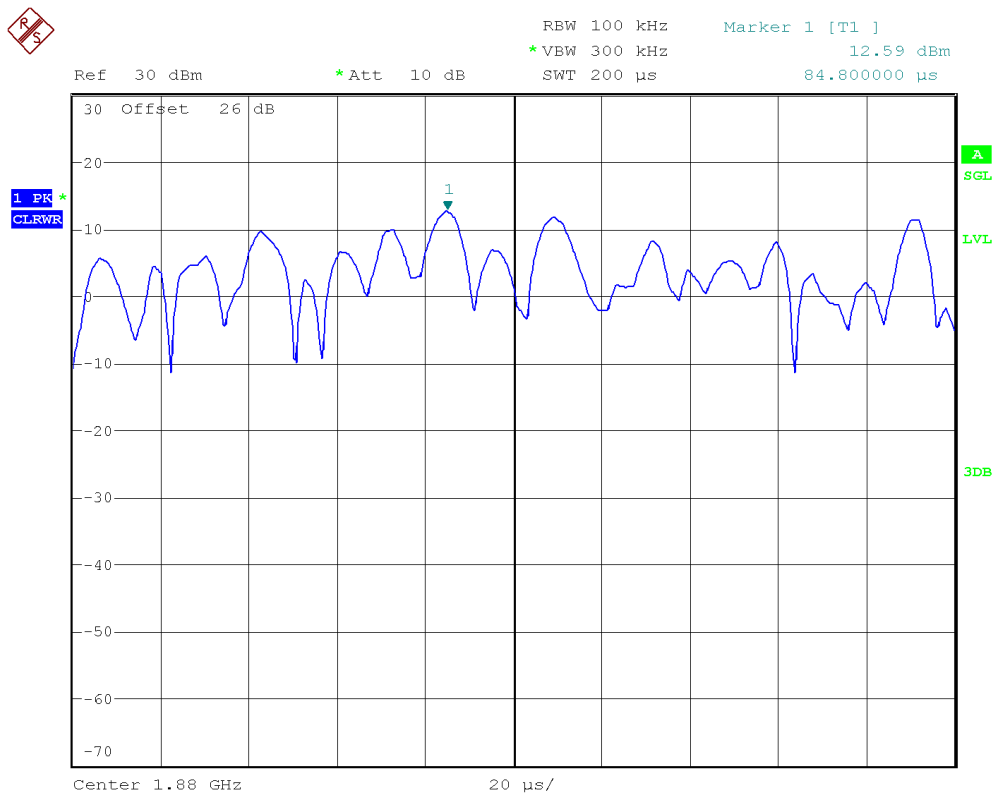

LTE Band 2. QPSK MODULATION. BW = 5 MHz.

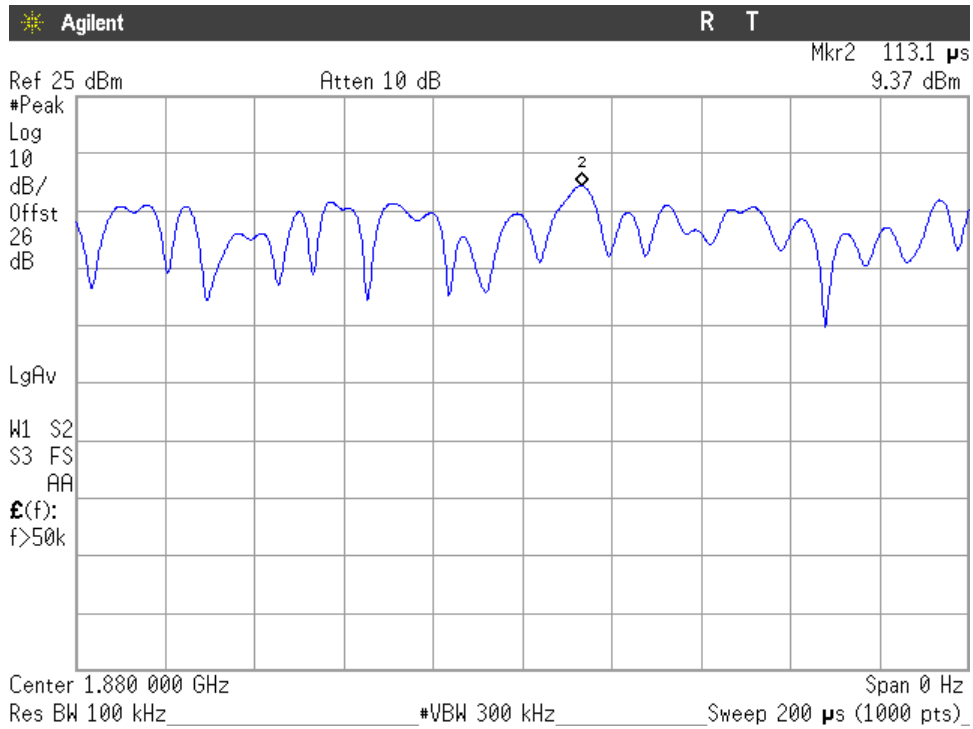

LTE Band 2. 16QAM MODULATION. BW = 5 MHz.

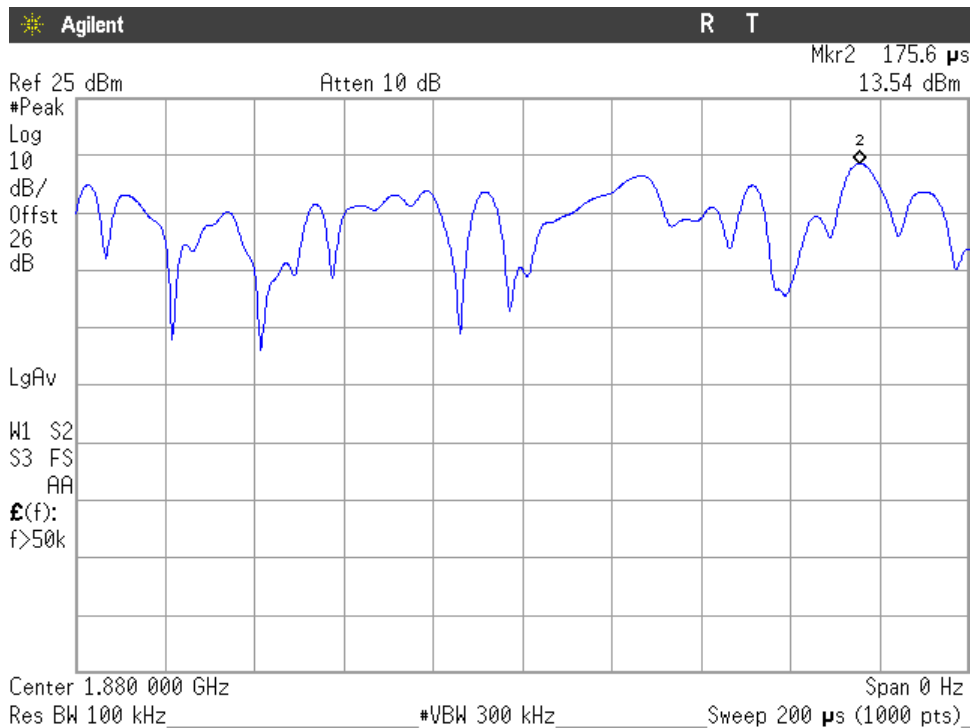

Occupied Bandwidth

SPECIFICATION:

FCC §2.1049. Measurements required: Occupied bandwidth.

RSS-Gen Clause 6.7.

METHOD:

The occupied bandwidth measurement was performed at the output terminals of the EUT using an attenuator, power splitter and spectrum analyser. The EUT was controlled via the Universal Radio Communication tester R&S CMW500 selecting maximum transmission power of the EUT and different modes of modulation. The 99% occupied bandwidth and the -26 dBc bandwidth were measured directly using the built-in bandwidth measuring option of spectrum analyser.

TEST SETUP:

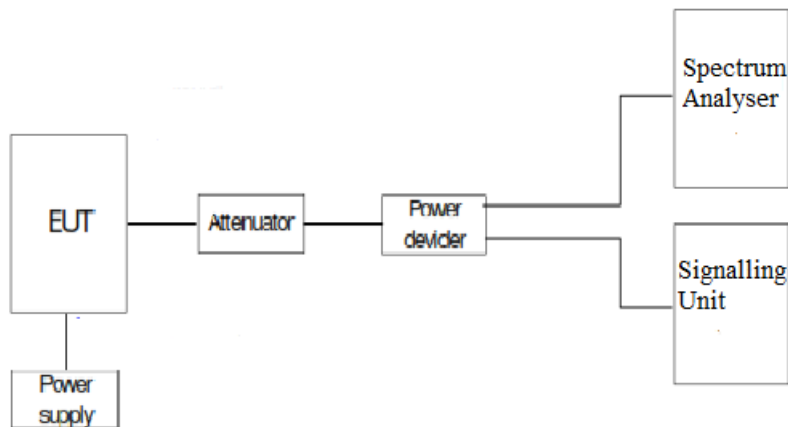

RESULTS:

3G Band II:

3G Band II. WCDMA MODULATION.

Channel	Lowest	Middle	Highest
99% Occupied bandwidth (kHz)	4130.00	4130.00	4130.00
-26 dBc bandwidth (kHz)	4711.54	4711.54	4711.54
Measurement uncertainty (kHz)	<±16.67		

3G Band II. HSUPA MODULATION.

Channel	Lowest	Middle	Highest
99% Occupied bandwidth (kHz)	4130.00	4130.00	4130.00
-26 dBc bandwidth (kHz)	4727.56	4727.56	4714.10
Measurement uncertainty (kHz)	<±16.67		

LTE Bands: The worst case of Occupied Bandwidth corresponds to all Resource Blocks (RB) with Offset 0, regardless the nominal bandwidth selected.

LTE Band 2:

LTE Band 2. QPSK MODULATION. BW = 1.4 MHz.

Channel	Lowest	Middle	Highest
99% Occupied bandwidth (kHz)	1102.10	1098.30	1113.80
-26 dBc bandwidth (kHz)	1329.00	1302.00	1407.00
Measurement uncertainty (kHz)	<±4.67		

LTE Band 2. 16QAM MODULATION. BW = 1.4 MHz.

Channel	Lowest	Middle	Highest
99% Occupied bandwidth (kHz)	1097.40	1093.60	1108.30
-26 dBc bandwidth (kHz)	1304.00	1294.00	1329.00
Measurement uncertainty (kHz)	<±4.67		

LTE Band 2. QPSK MODULATION. BW = 3 MHz.

Channel	Lowest	Middle	Highest
99% Occupied bandwidth (kHz)	2745.00	2740.90	2750.40
-26 dBc bandwidth (kHz)	3058.00	3082.00	3092.00
Measurement uncertainty (kHz)	<±10		

LTE Band 2. 16QAM MODULATION. BW = 3 MHz.

Channel	Lowest	Middle	Highest
99% Occupied bandwidth (kHz)	2738.40	2750.80	2754.20
-26 dBc bandwidth (kHz)	3082.00	3073.00	3093.00
Measurement uncertainty (kHz)	<±10		

LTE Band 2. QPSK MODULATION. BW = 5 MHz.

Channel	Lowest	Middle	Highest
99% Occupied bandwidth (kHz)	4505.20	4519.10	4505.10
-26 dBc bandwidth (kHz)	5041.00	5049.00	5011.00
Measurement uncertainty (kHz)	<±16.67		

LTE Band 2. 16QAM MODULATION. BW = 5 MHz.

Channel	Lowest	Middle	Highest
99% Occupied bandwidth (kHz)	4506.20	4513.20	4520.30
-26 dBc bandwidth (kHz)	5006.00	5031.00	5039.00
Measurement uncertainty (kHz)	<±16.67		

LTE Band 2. QPSK MODULATION. BW = 10 MHz.

Channel	Lowest	Middle	Highest
99% Occupied bandwidth (kHz)	8970.00	8952.10	8951.60
-26 dBc bandwidth (kHz)	9888.00	9900.00	9865.00
Measurement uncertainty (kHz)	<±33.33		

LTE Band 2. QPSK MODULATION. BW = 15 MHz.

Channel	Lowest	Middle	Highest
99% Occupied bandwidth (kHz)	13428.90	13383.90	13374.90
-26 dBc bandwidth (kHz)	14638.00	14639.00	14530.00
Measurement uncertainty (kHz)	<±50		

LTE Band 2. QPSK MODULATION. BW = 20 MHz.

Channel	Lowest	Middle	Highest
99% Occupied bandwidth (kHz)	17946.20	17794.00	17931.50
-26 dBc bandwidth (kHz)	19460.00	19083.00	19483.00
Measurement uncertainty (kHz)	<±66.67		

3G Band II. WCDMA MODULATION.

Lowest Channel:

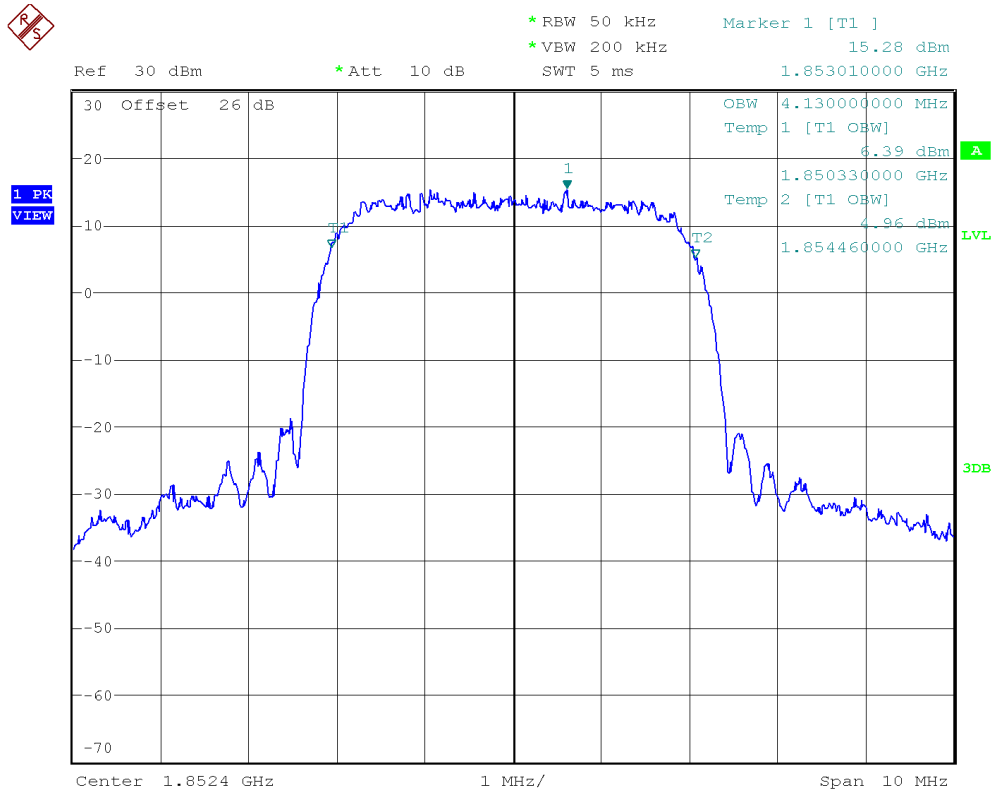

Middle Channel:

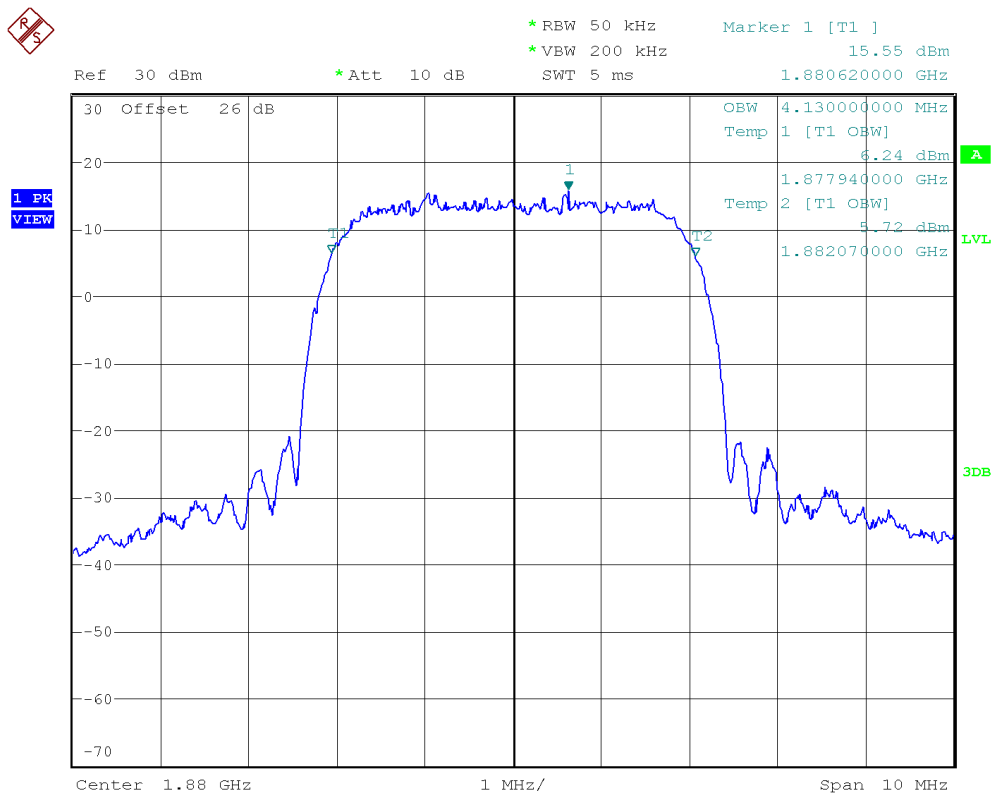

Highest Channel:

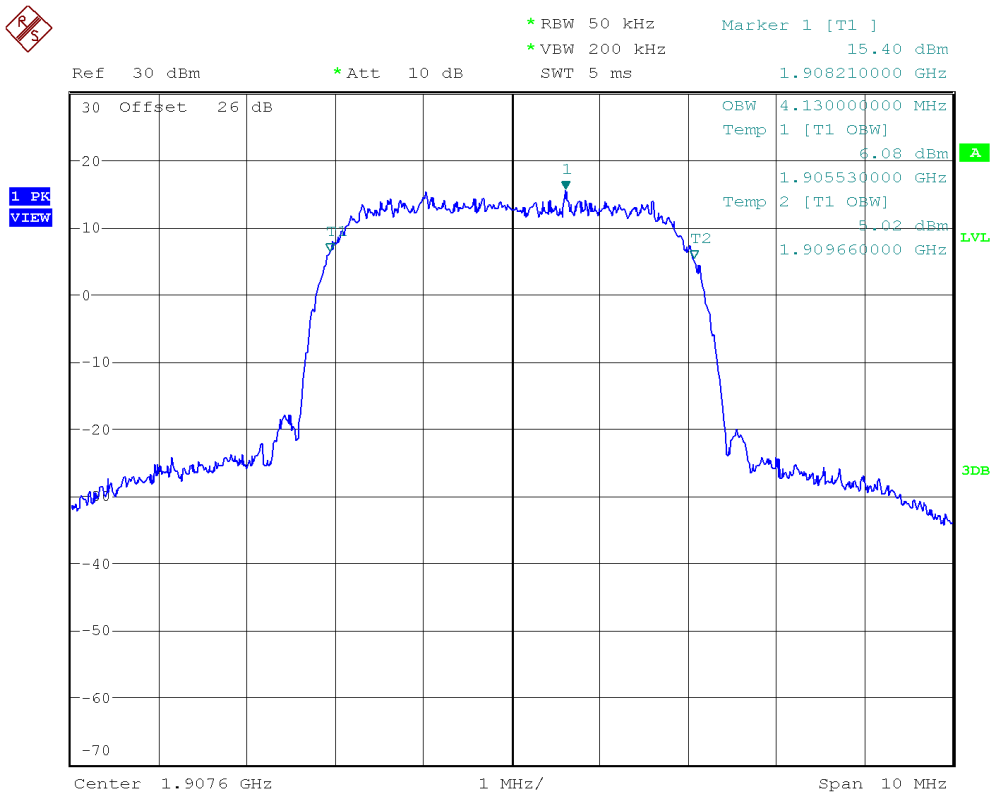

3G Band II. HSUPA MODULATION.

Lowest Channel:

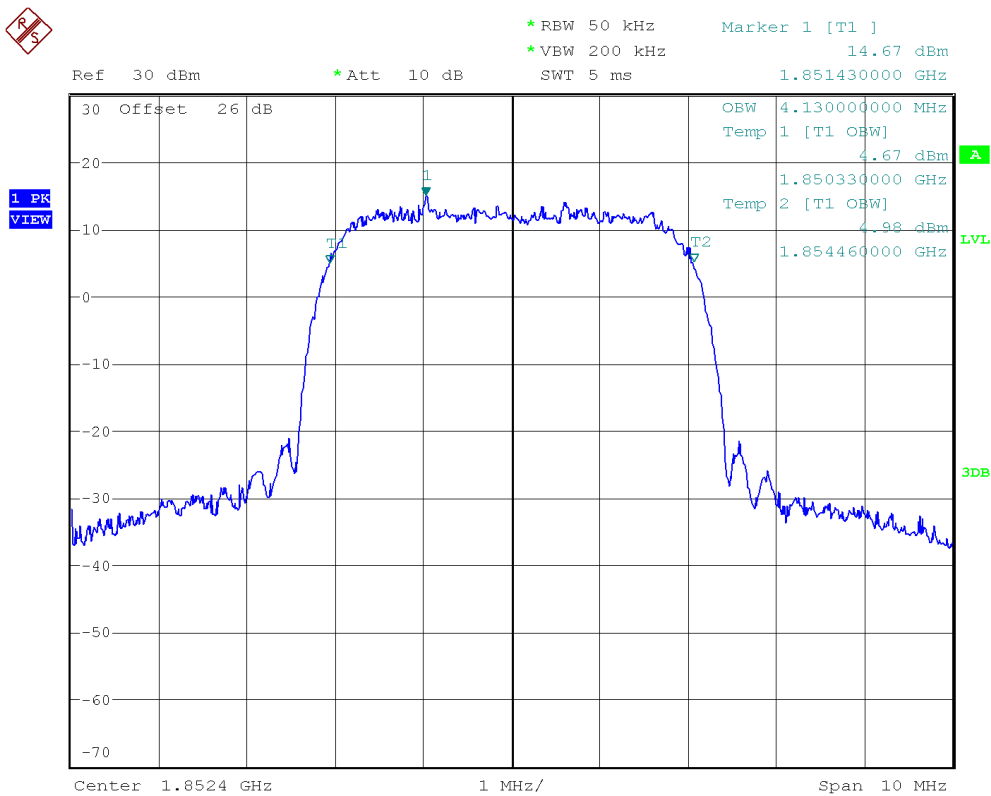

Middle Channel:

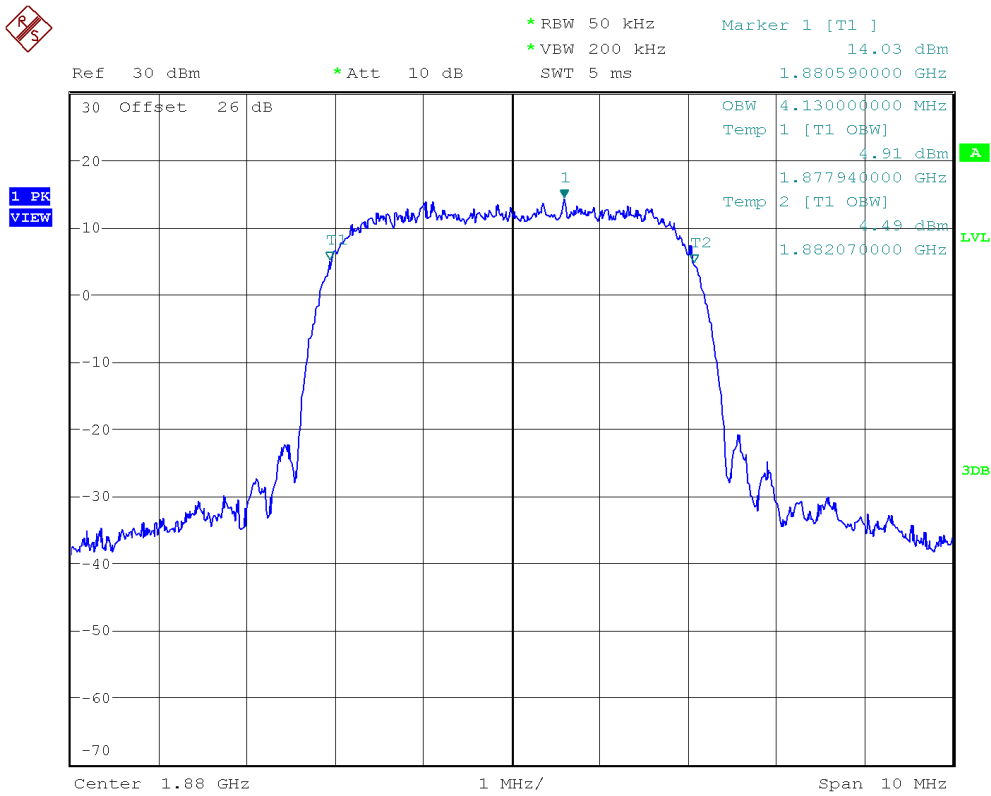

Highest Channel:

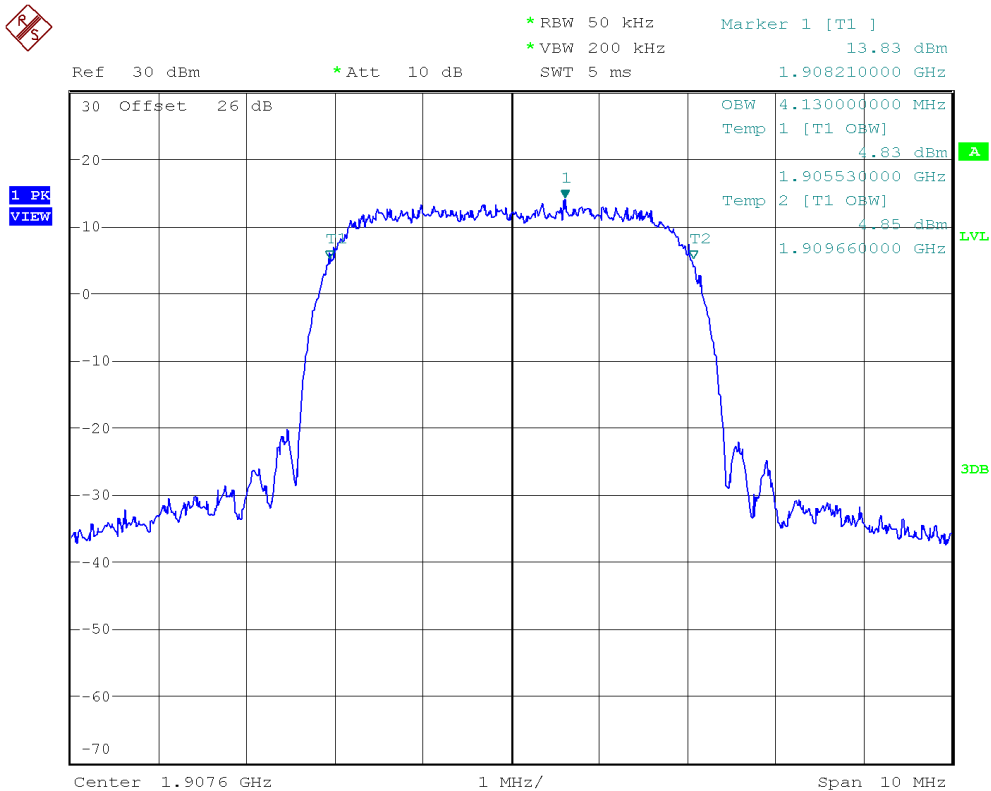

LTE Band 2. QPSK MODULATION. BW = 1.4 MHz.

Lowest Channel:

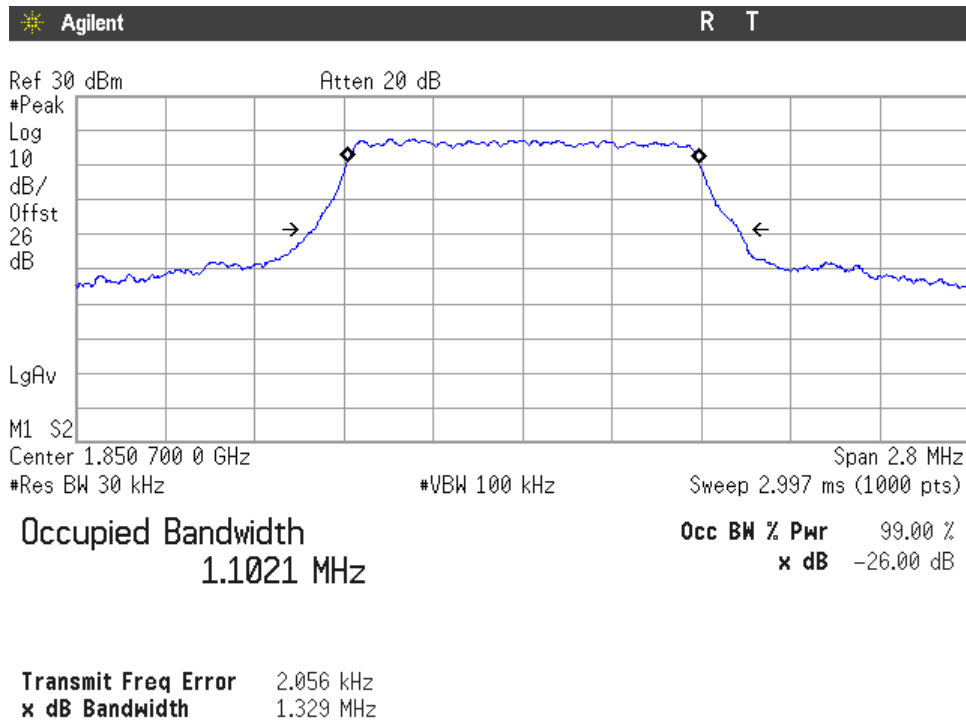

Middle Channel:

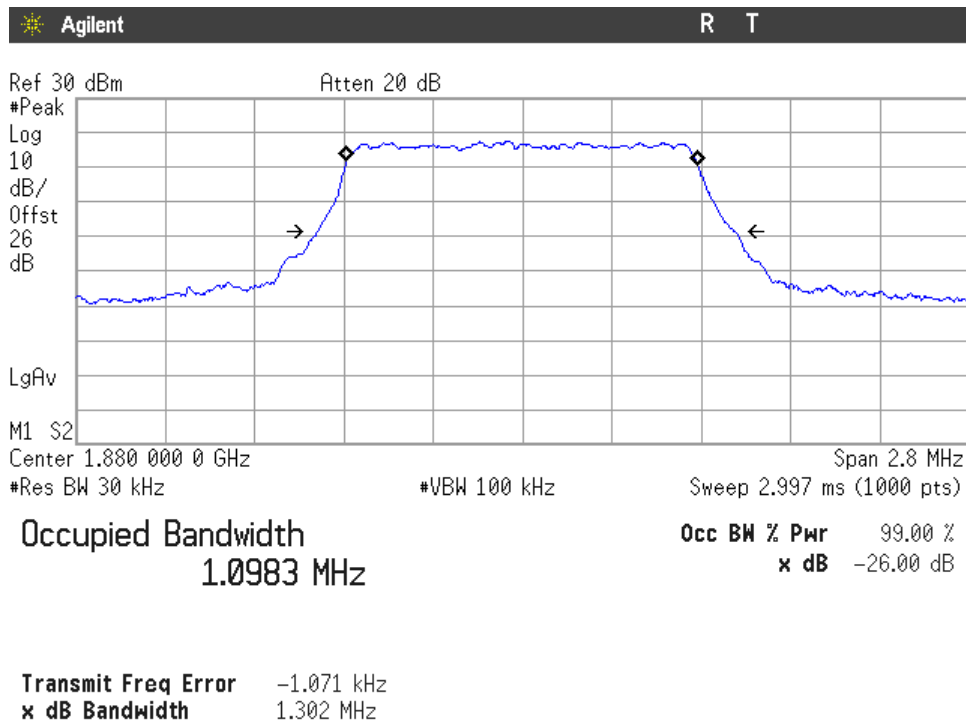

Highest Channel:

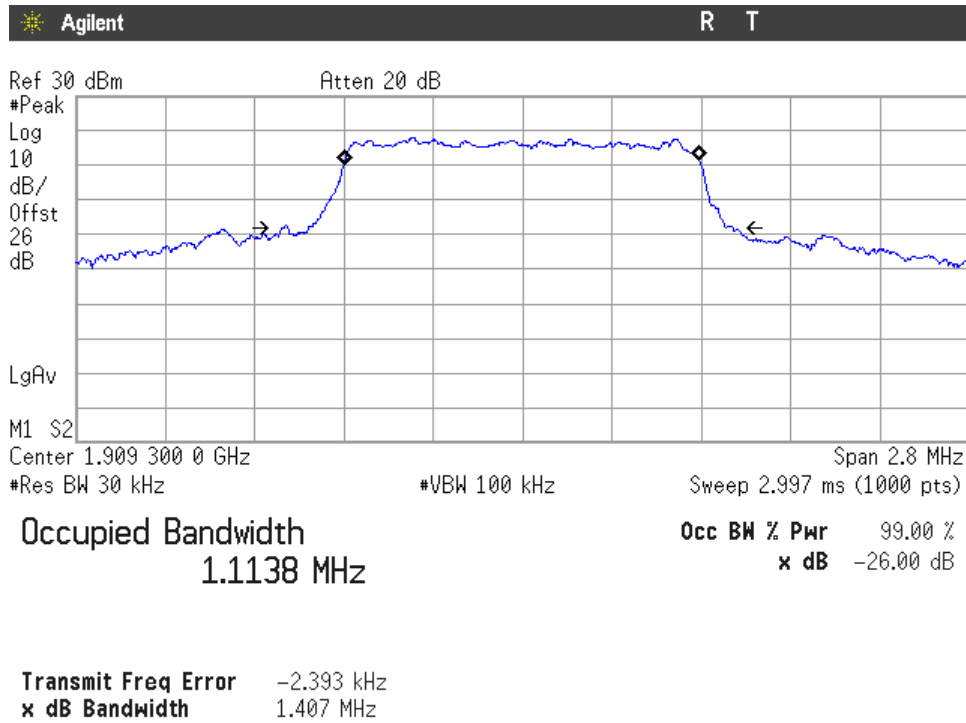

LTE Band 2. 16QAM MODULATION. BW = 1.4 MHz.

Lowest Channel:

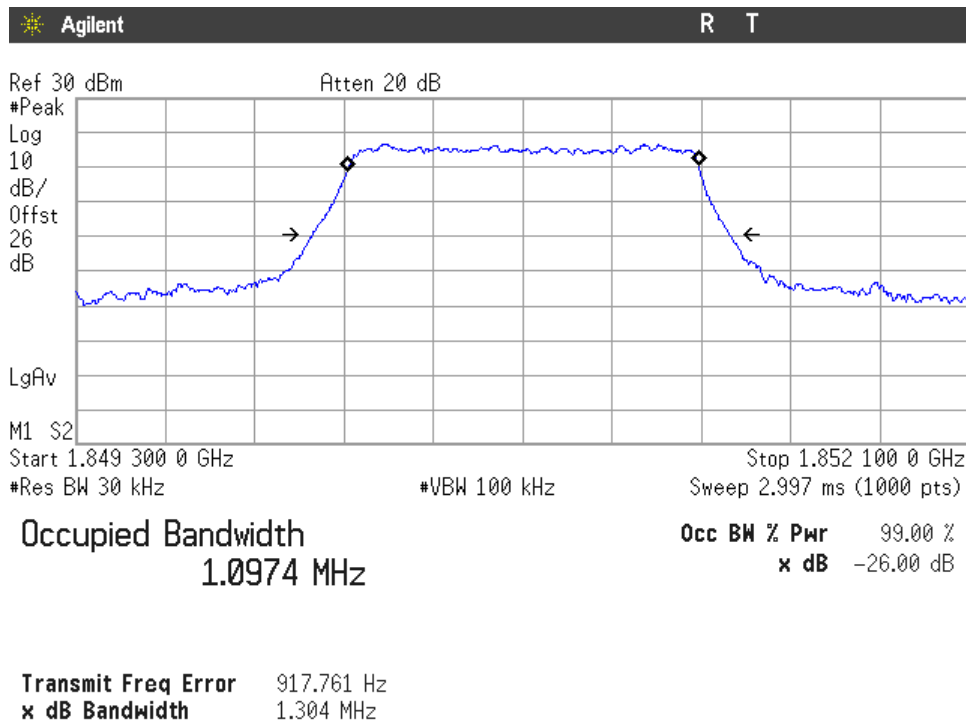

Middle Channel:

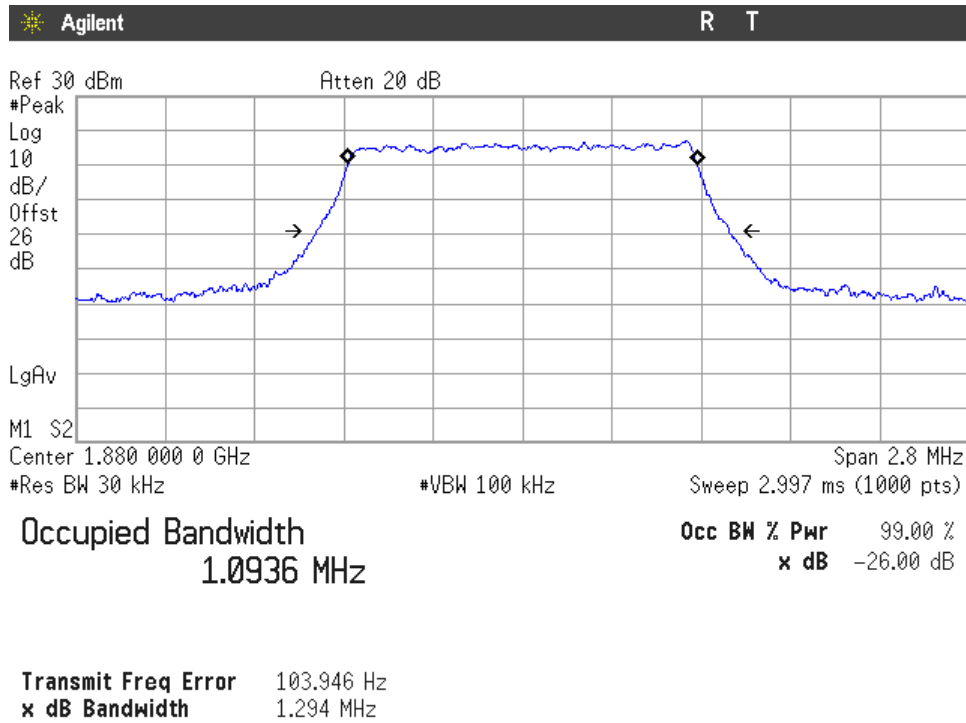

Highest Channel:

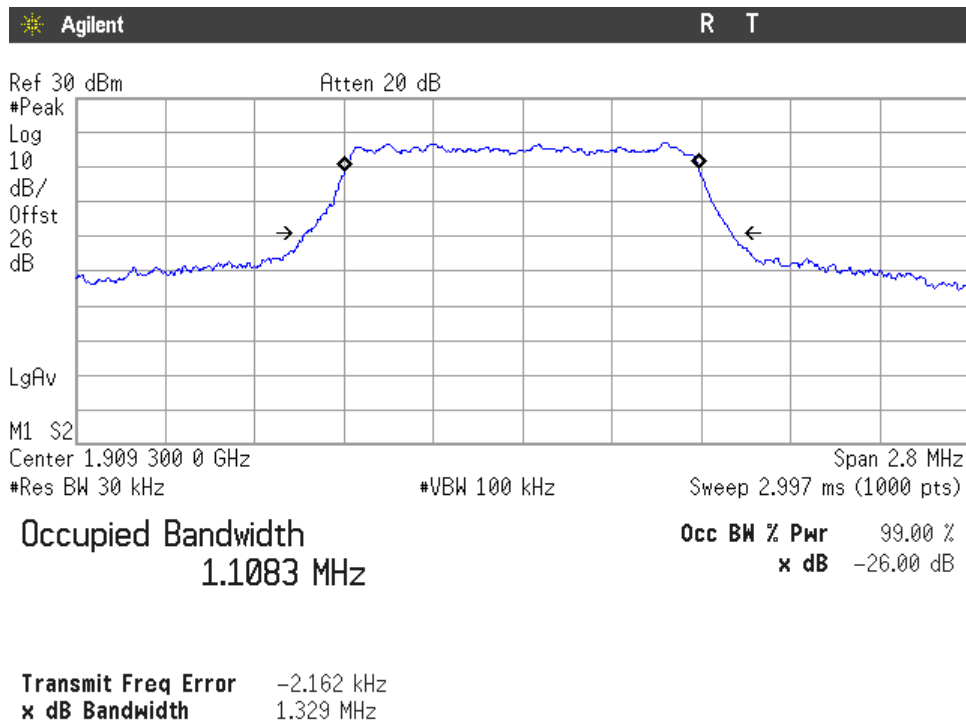

LTE Band 2. QPSK MODULATION. BW = 3 MHz.

Lowest Channel:

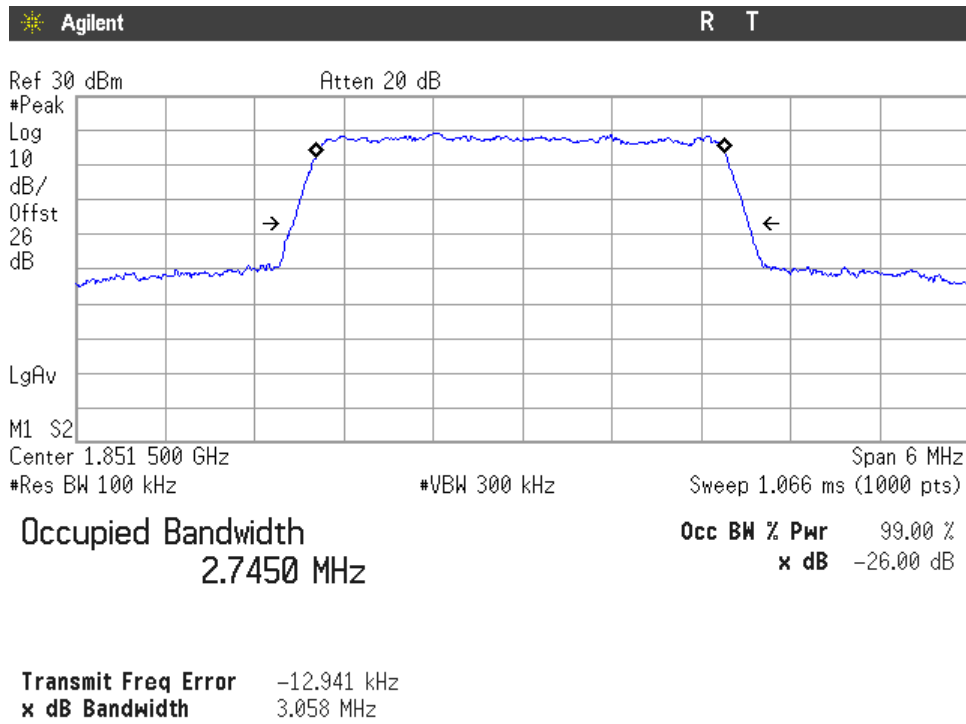

Middle Channel:

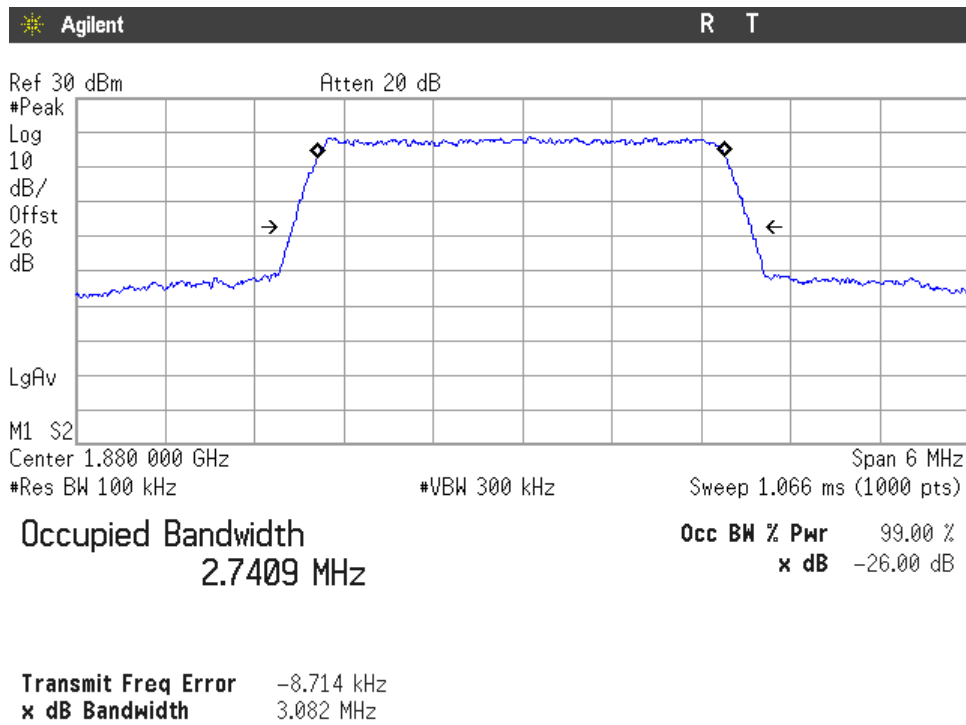

Highest Channel:

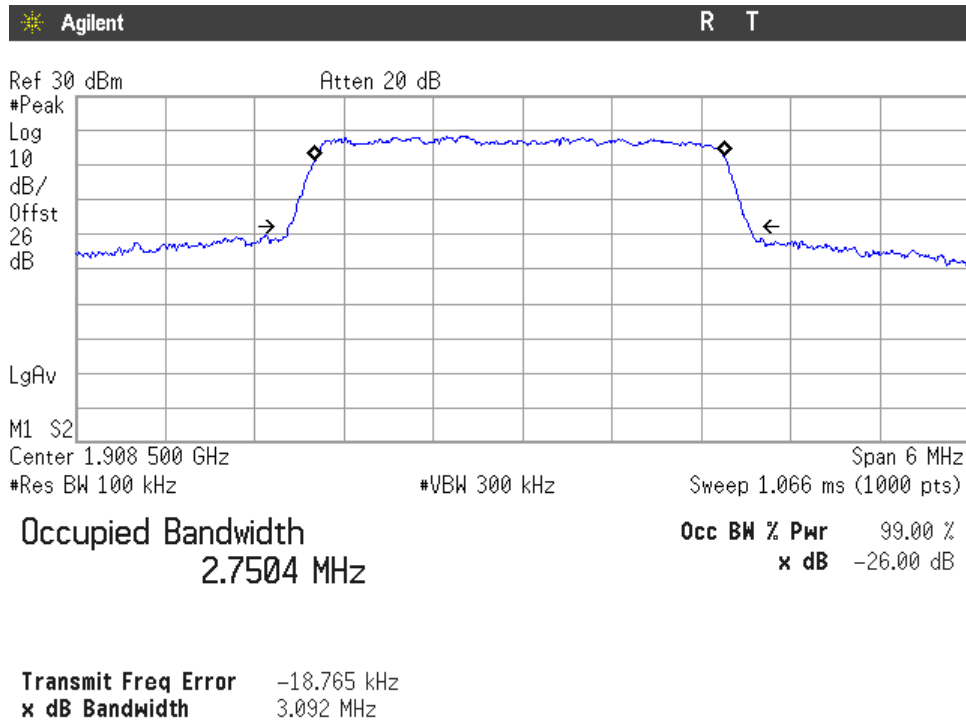

LTE Band 2. 16QAM MODULATION. BW = 3 MHz.

Lowest Channel:

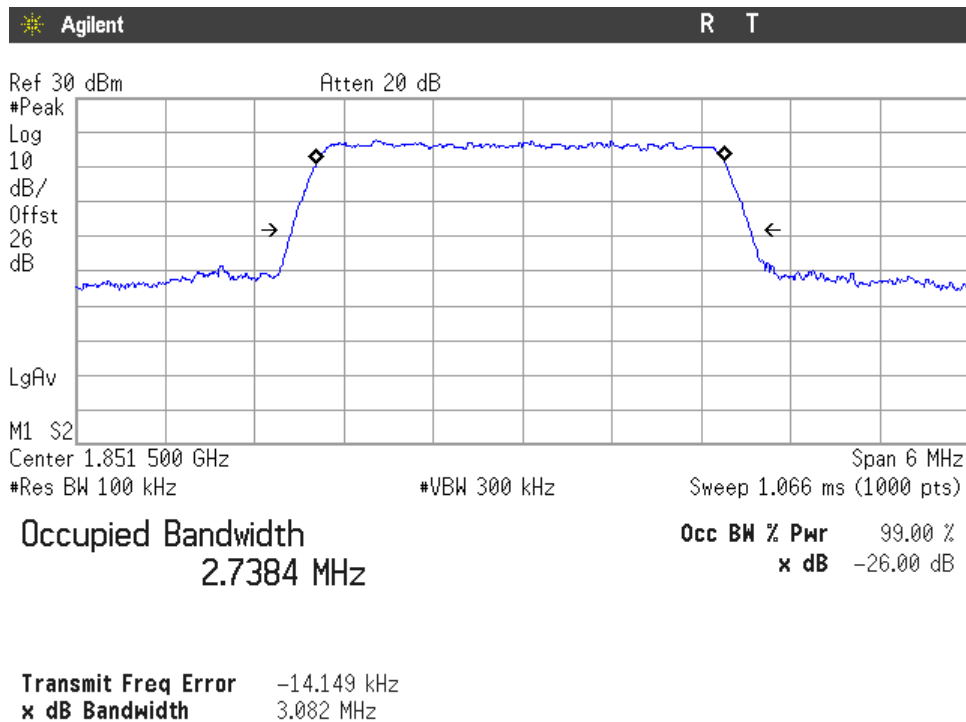

Middle Channel:

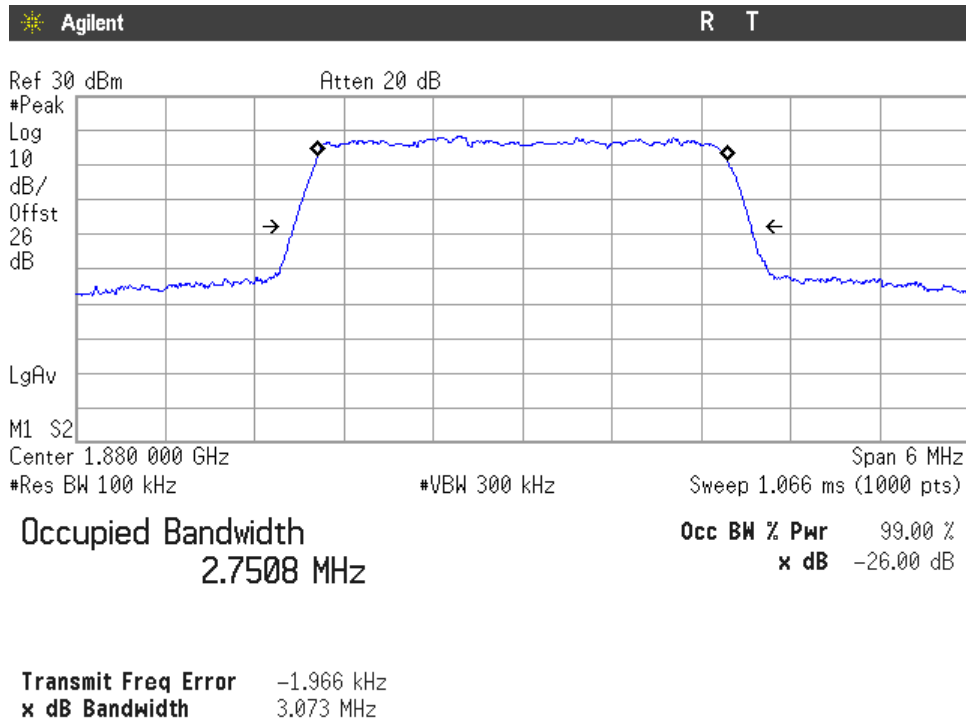

Highest Channel:

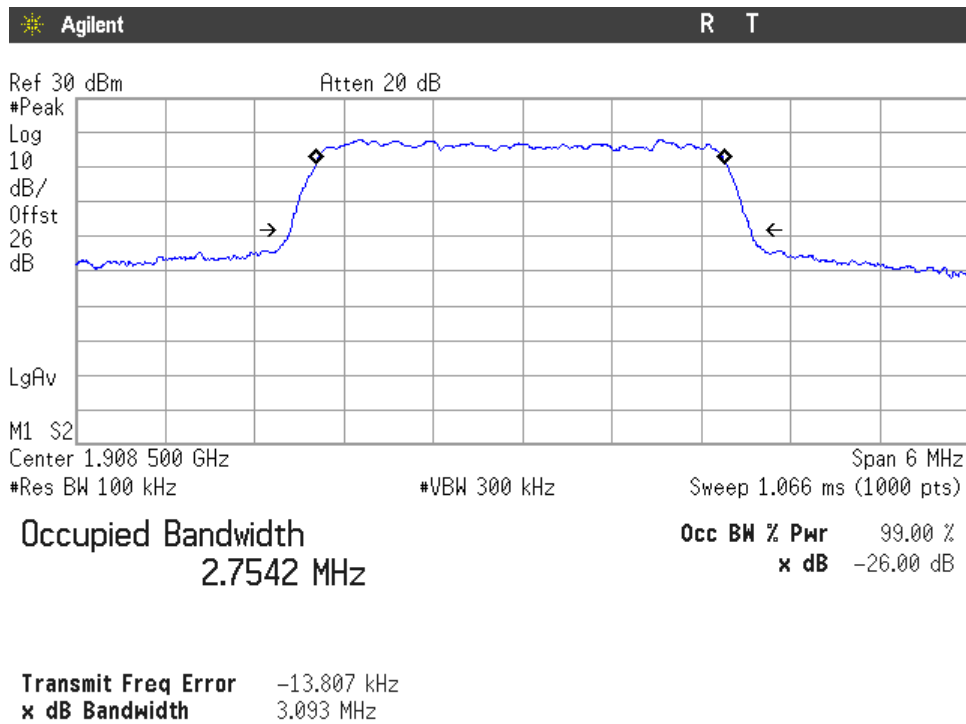

LTE Band 2. QPSK MODULATION. BW = 5 MHz.

Lowest Channel:

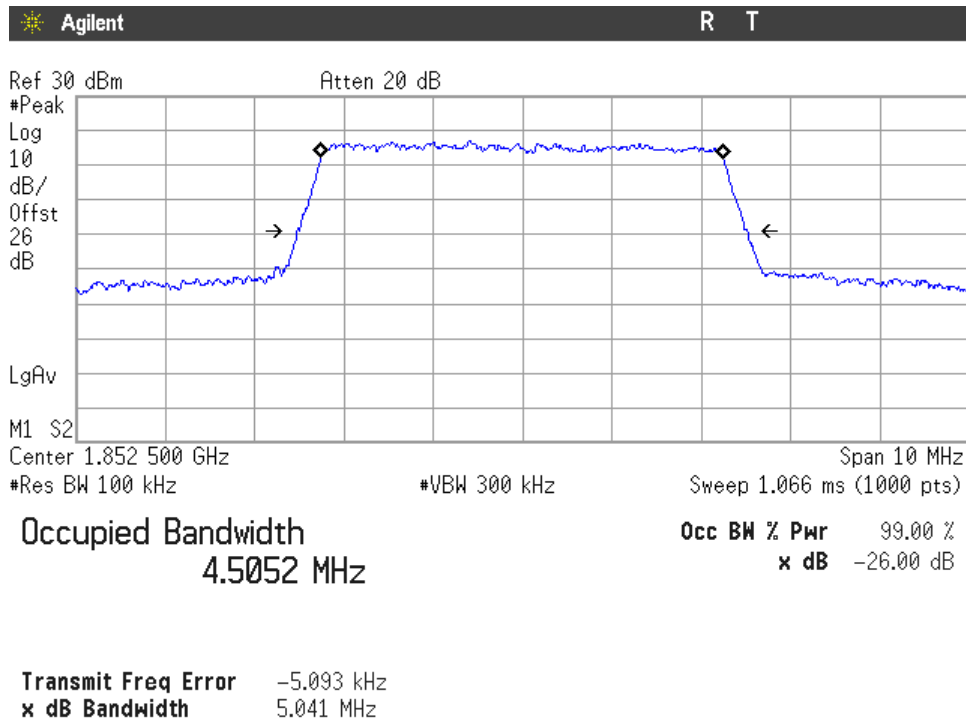

Middle Channel:

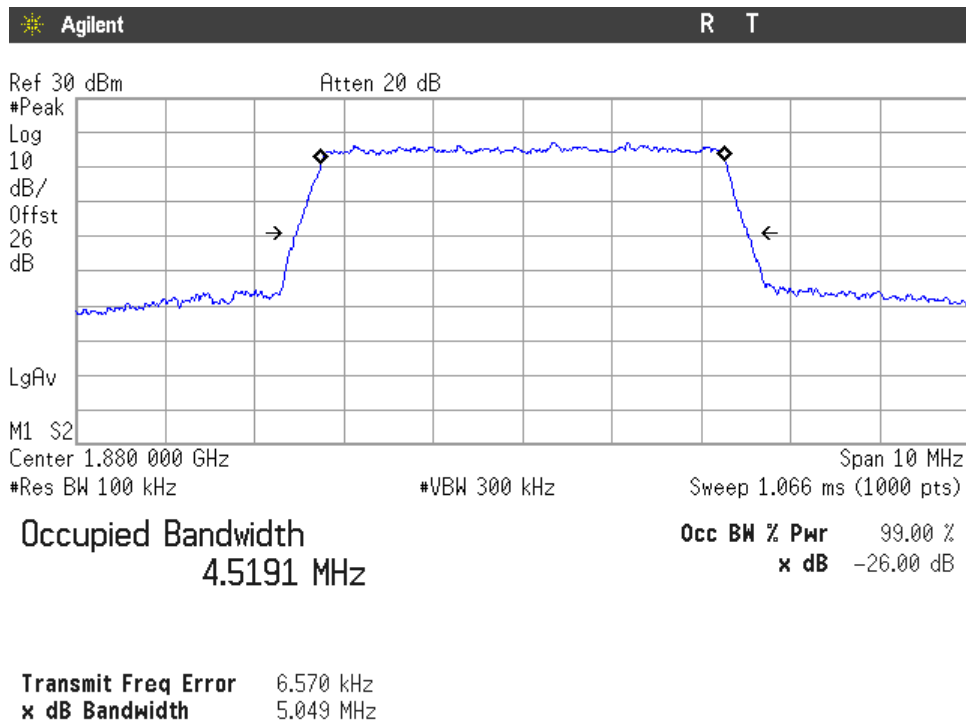

Highest Channel:

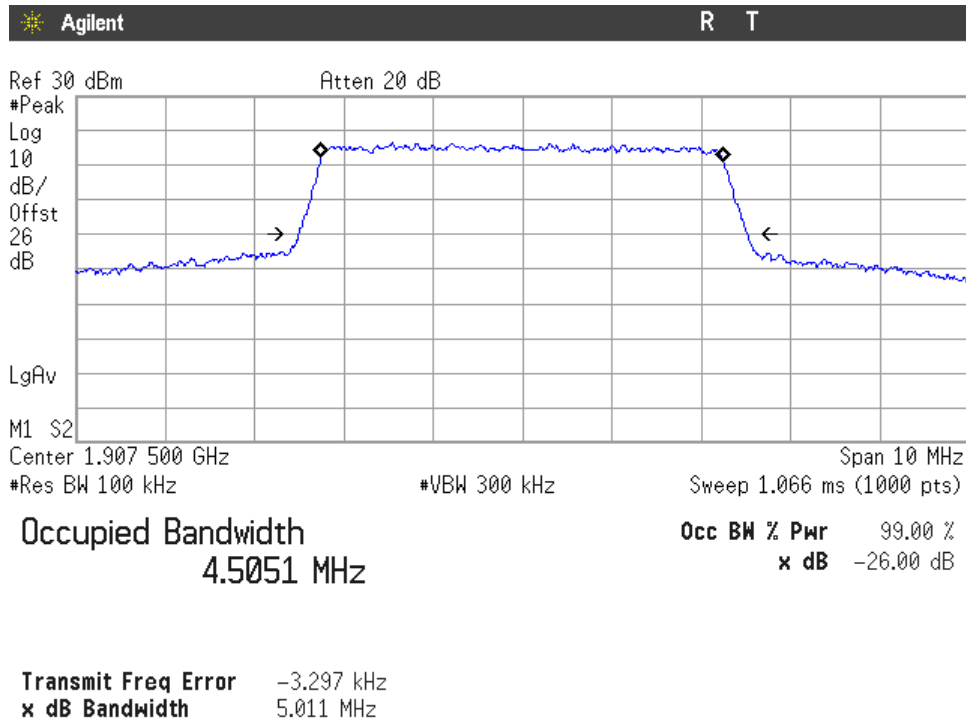

LTE Band 2. 16QAM MODULATION. BW = 5 MHz.

Lowest Channel:

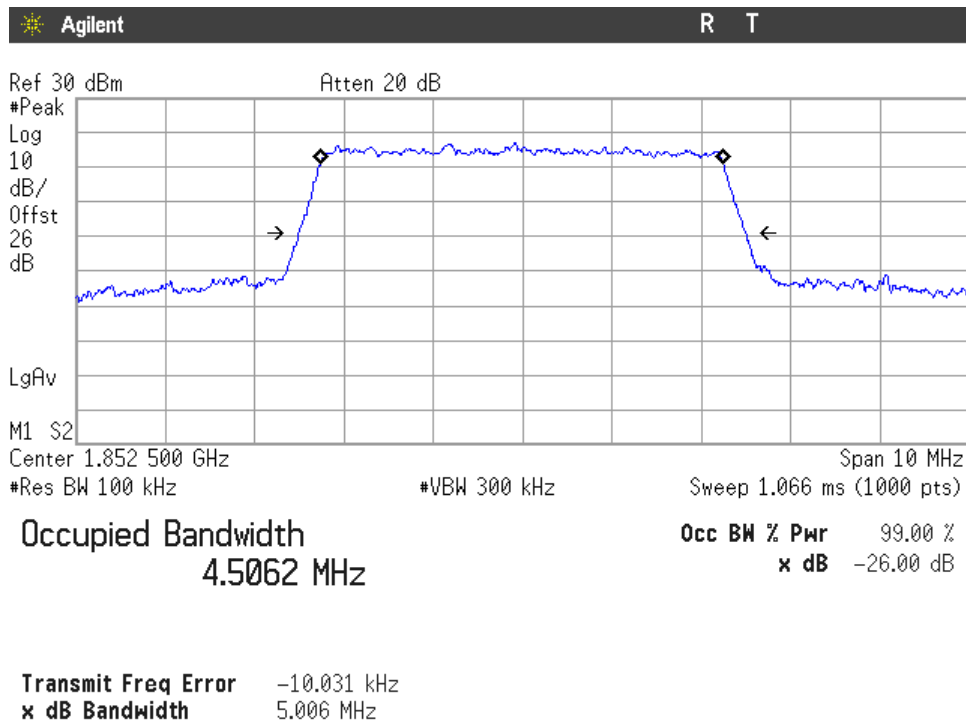

Middle Channel:

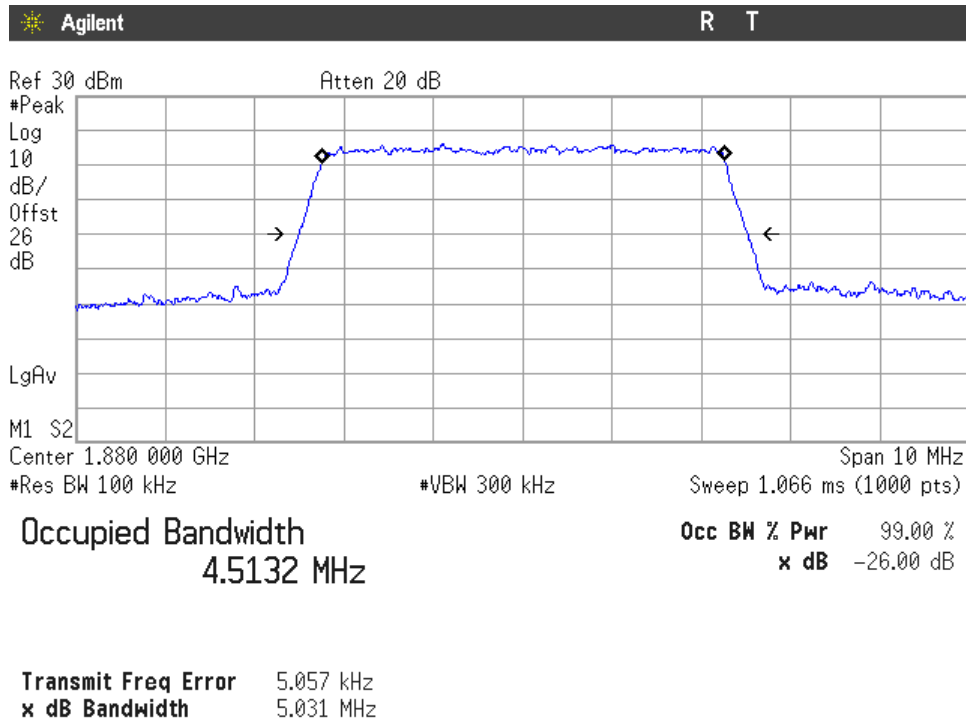

Highest Channel:

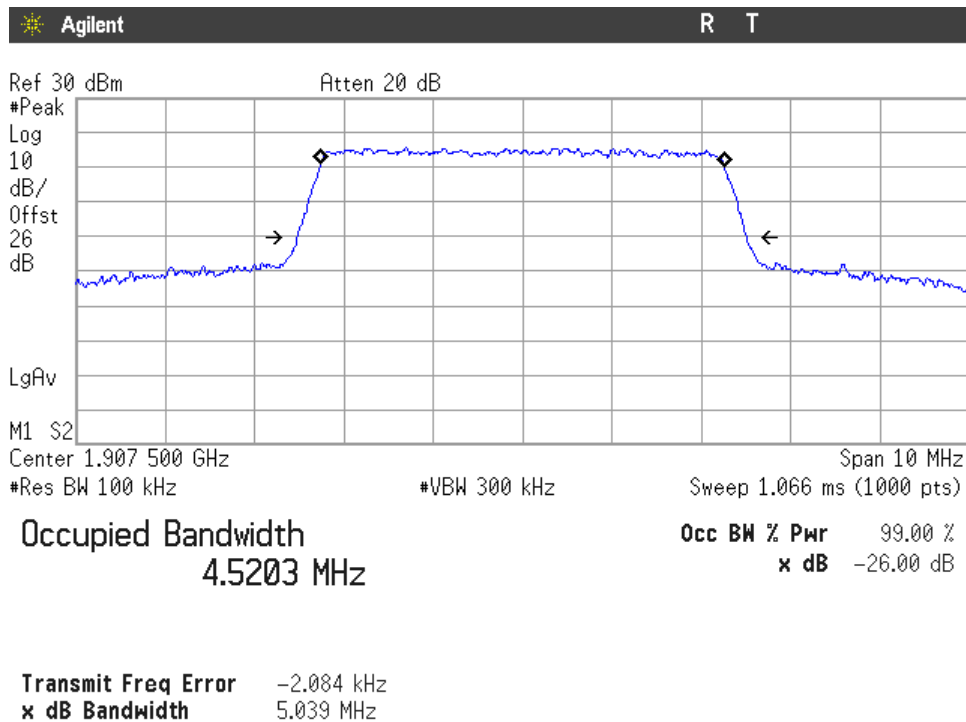

LTE Band 2. QPSK MODULATION. BW = 10 MHz.

Lowest Channel:

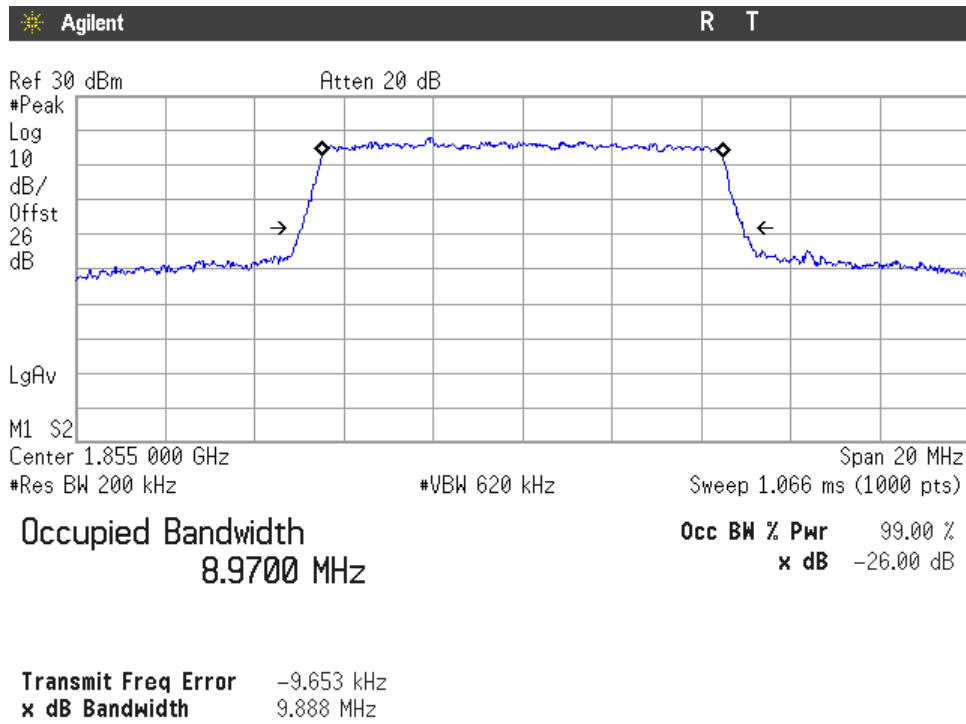

Middle Channel:

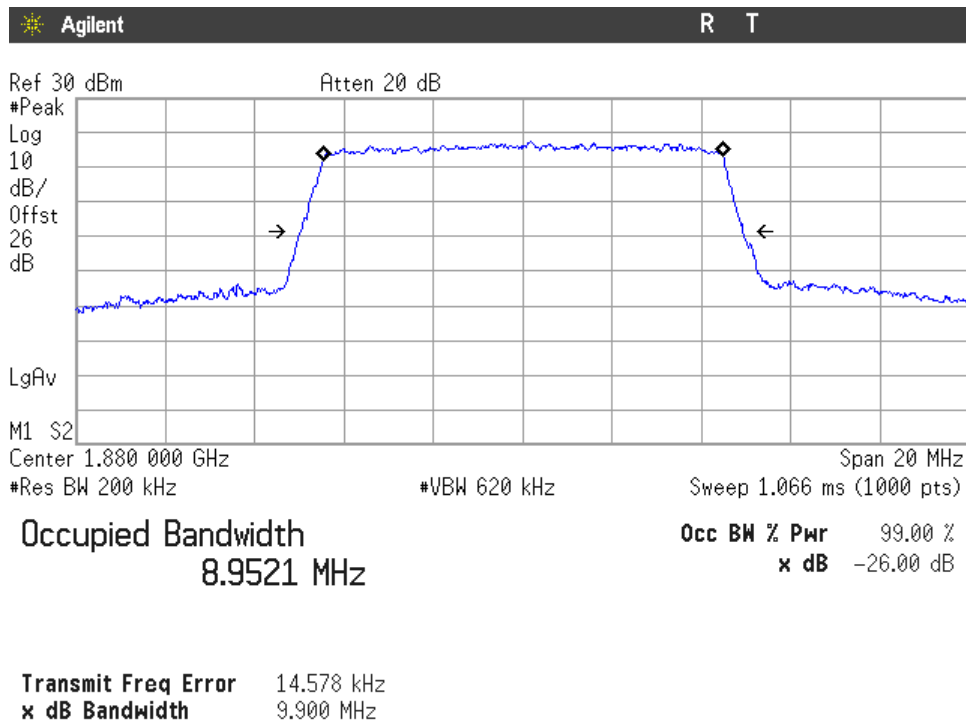

Highest Channel:

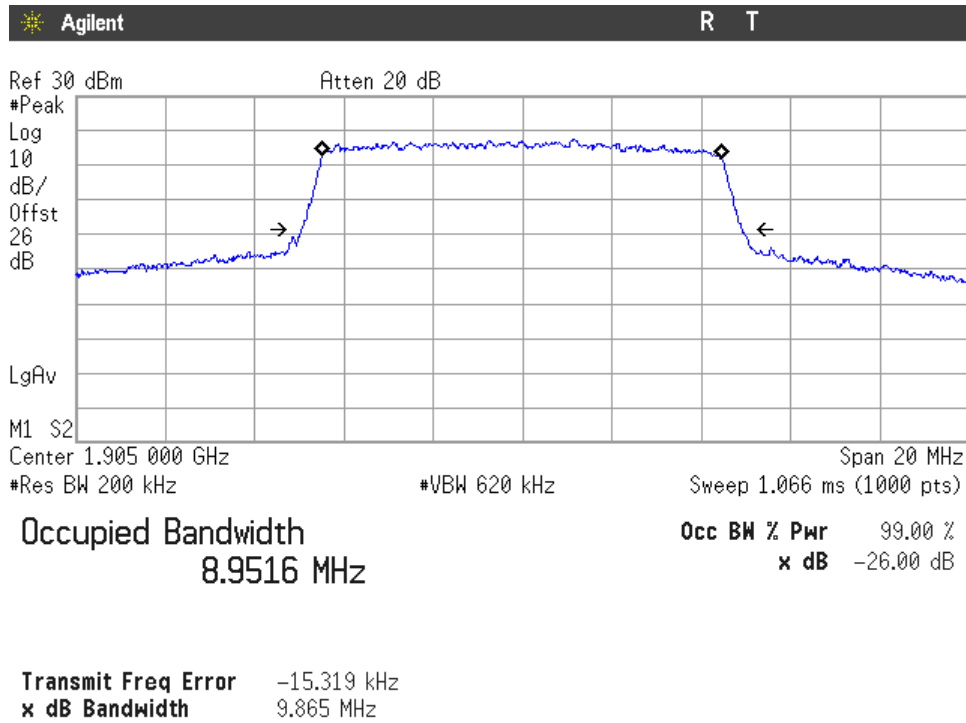

LTE Band 2. QPSK MODULATION. BW = 15 MHz.

Lowest Channel:

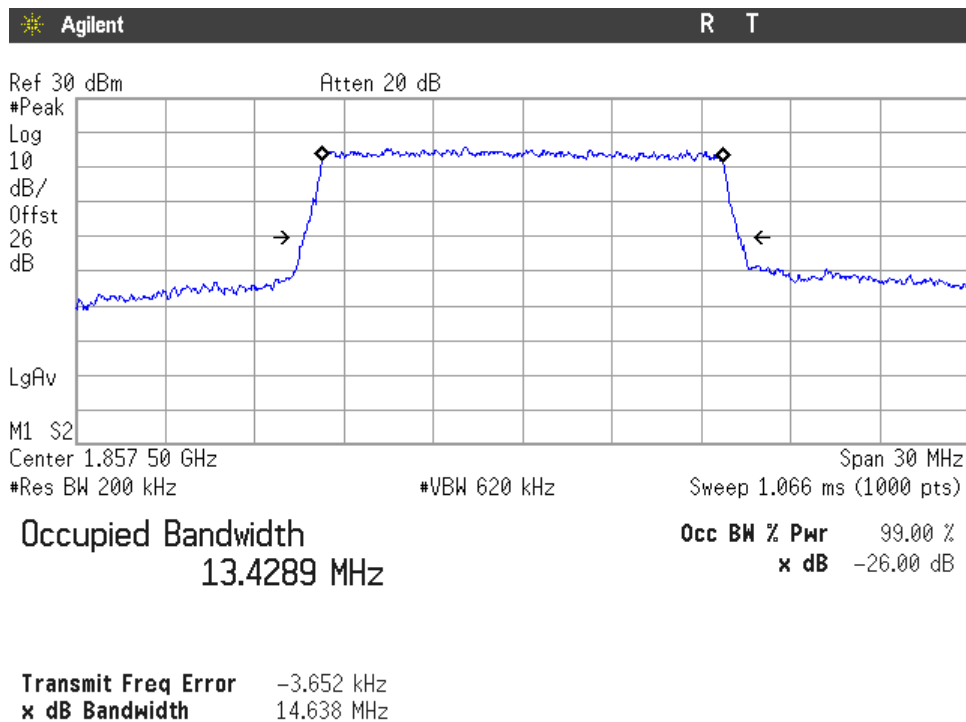

Middle Channel:

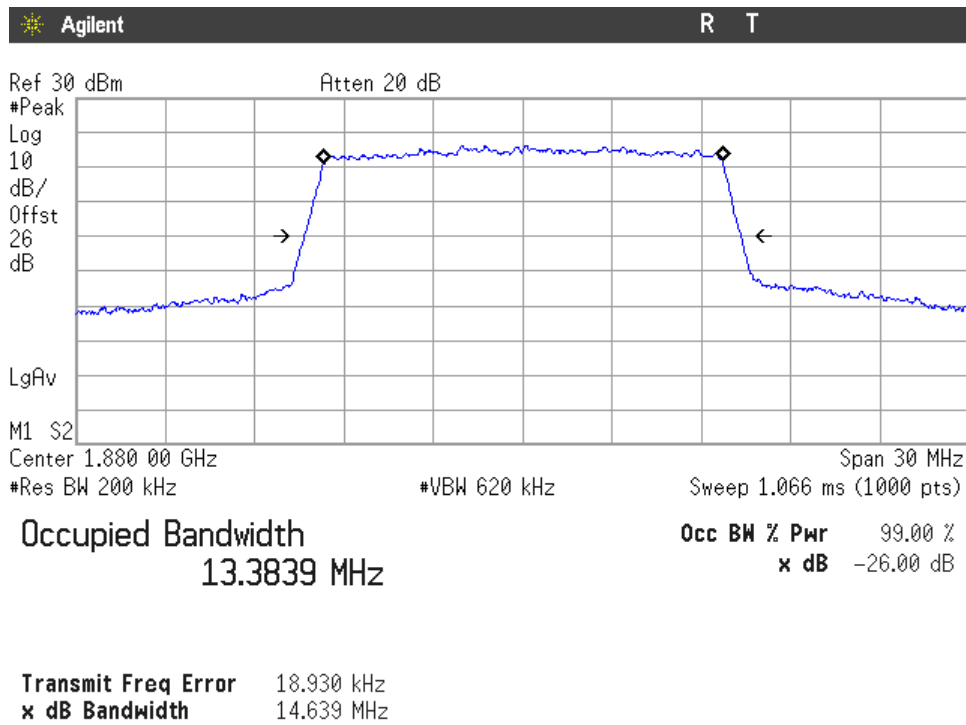

Highest Channel:

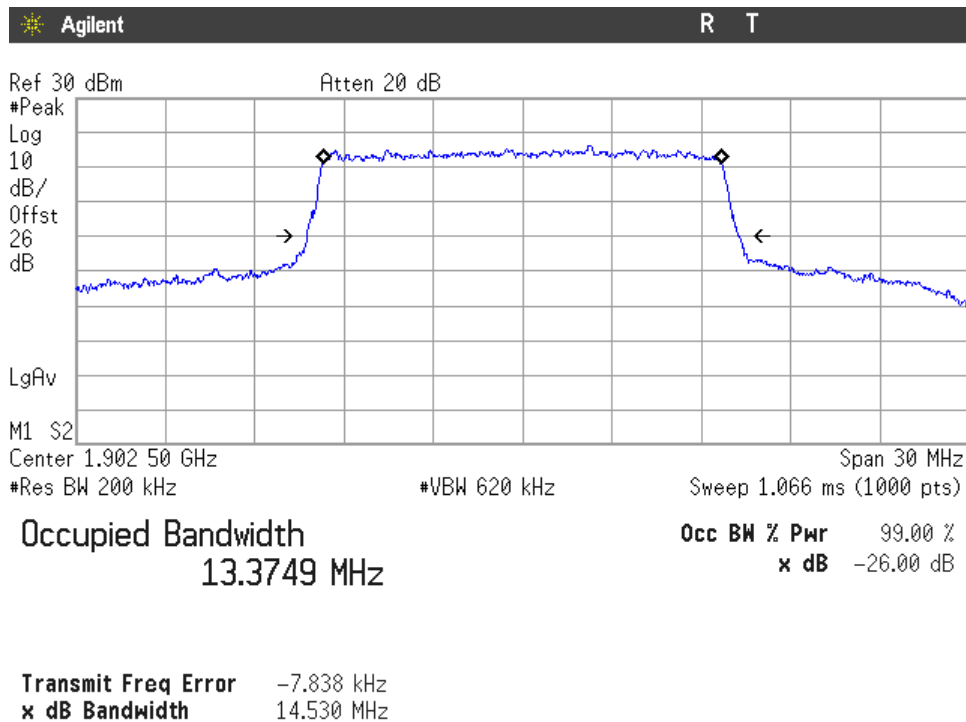

LTE Band 2. QPSK MODULATION. BW = 20 MHz.

Lowest Channel:

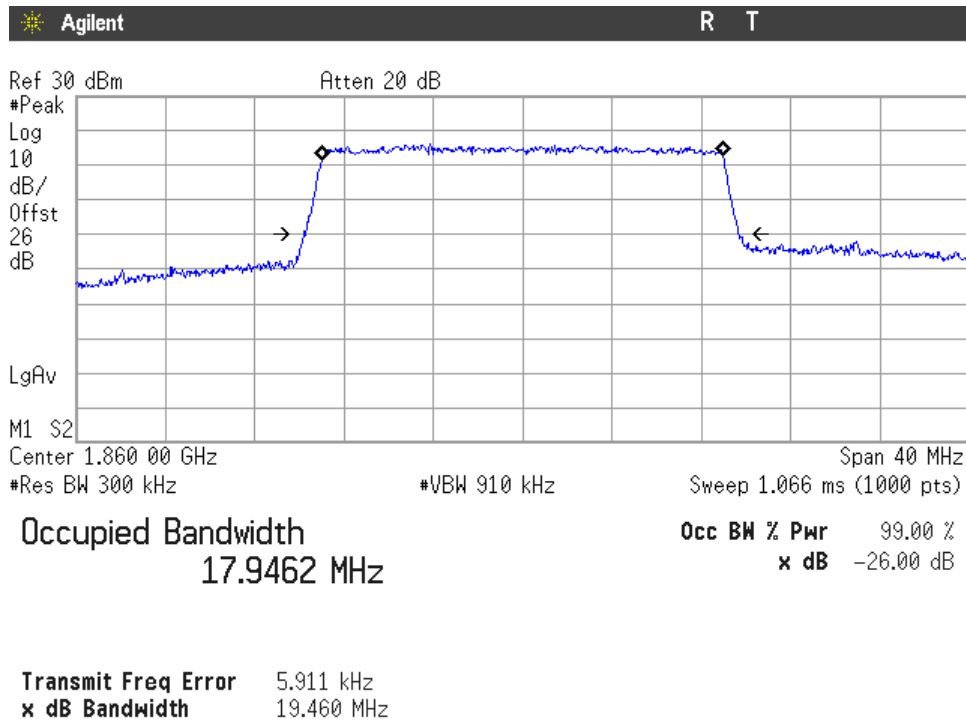

Middle Channel:

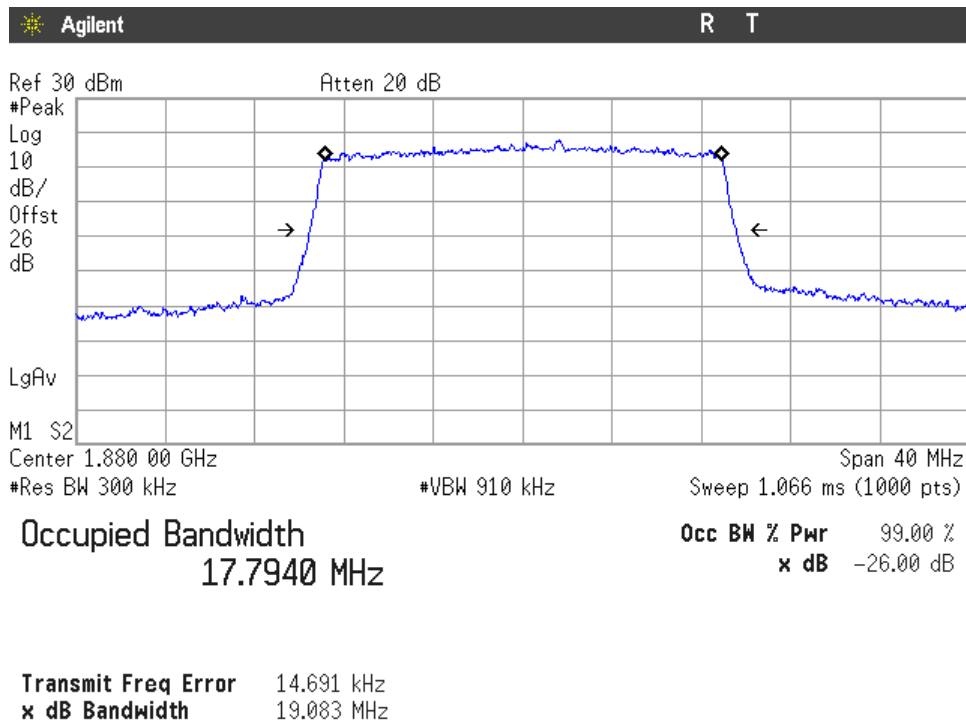

Highest Channel:

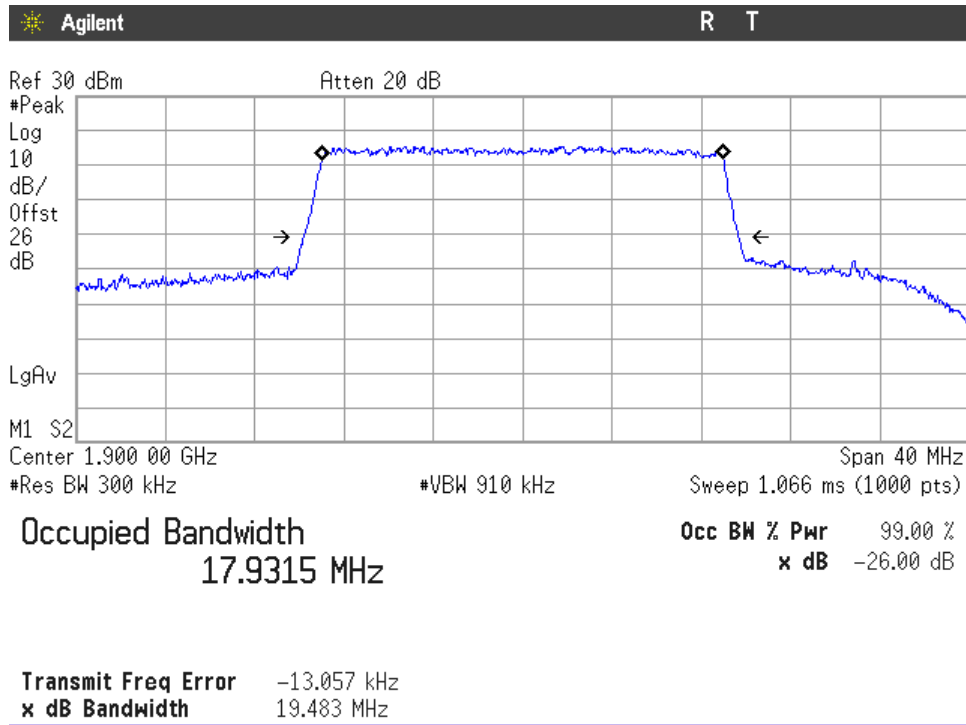

Spurious emissions at antenna terminals

SPECIFICATION:

FCC §2.1051 and §24.238. RSS-133. Clause 6.5.

The power of emissions shall be attenuated below the transmitter power (P) by a factor of at least $43 + 10 \log (P)$ dB. P in watts.

At P_o transmitting power, the specified minimum attenuation becomes $43+10 \log (P_o)$, and the level in dBm relative P_o becomes:

$$P_o \text{ (dBm)} - [43 + 10 \log (P_o \text{ in mwatts}) - 30] = -13 \text{ dBm.}$$

METHOD:

The EUT RF output connector was connected to a spectrum analyser and to the Universal Radio Communication tester R&S CMU200 and CMW500 (selecting maximum transmission power of the EUT and different modes of modulation) using a 50 ohm attenuator and a power splitter.

The spectrum was investigated from 9 kHz to 20 GHz.

For LTE mode the configuration of Resource Blocks and modulation which is the worst case for conducted power was used.

The reading of the spectrum analyser is corrected with the attenuation loss of connection between output terminal of EUT and input of the spectrum analyser.

Measurement Limit:

According to specification. the power of emissions shall be attenuated below the transmitter power (P) by a factor of at least $43 + 10 \log (P)$ dB. P in watts.

At P_o transmitting power. the specified minimum attenuation becomes $43+10 \log (P_o)$. and the level in dBm relative P_o becomes:

$$P_o \text{ (dBm)} - [43 + 10 \log (P_o \text{ in mwatts}) - 30] = - 13 \text{ dBm}$$

TEST SETUP:

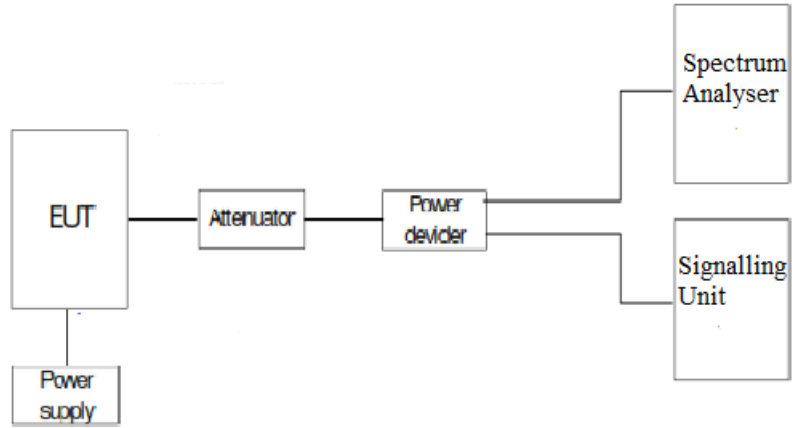

RESULTS:

3G Band II. WCDMA MODULATION.

- Lowest Channel:
No spurious frequencies detected at less than 20 dB below the limit in all the range.
- Middle Channel:
No spurious frequencies detected at less than 20 dB below the limit in all the range.
- Highest Channel:
No spurious frequencies detected at less than 20 dB below the limit in all the range.

3G Band II. HSUPA MODULATION.

- Lowest Channel:
No spurious frequencies detected at less than 20 dB below the limit in all the range.
- Middle Channel:
No spurious frequencies detected at less than 20 dB below the limit in all the range.
- Highest Channel:
No spurious frequencies detected at less than 20 dB below the limit in all the range.

LTE Band 2. QPSK MODULATION. BW = 1.4 MHz.

- Lowest Channel:
No spurious frequencies detected at less than 20 dB below the limit in all the range.
- Middle Channel:
No spurious frequencies detected at less than 20 dB below the limit in all the range.
- Highest Channel:
No spurious frequencies detected at less than 20 dB below the limit in all the range.

LTE Band 2. QPSK MODULATION. BW = 3 MHz.

- Lowest Channel:
No spurious frequencies detected at less than 20 dB below the limit in all the range.
- Middle Channel:
No spurious frequencies detected at less than 20 dB below the limit in all the range.
- Highest Channel:
No spurious frequencies detected at less than 20 dB below the limit in all the range.

LTE Band 2. QPSK MODULATION. BW = 5 MHz.

- Lowest Channel:
No spurious frequencies detected at less than 20 dB below the limit in all the range.
- Middle Channel:
No spurious frequencies detected at less than 20 dB below the limit in all the range.
- Highest Channel:
No spurious frequencies detected at less than 20 dB below the limit in all the range.

LTE Band 2. QPSK MODULATION. BW = 10 MHz.

- Lowest Channel:

No spurious frequencies detected at less than 20 dB below the limit in all the range.

- Middle Channel:

No spurious frequencies detected at less than 20 dB below the limit in all the range.

- Highest Channel:

No spurious frequencies detected at less than 20 dB below the limit in all the range.

LTE Band 2. QPSK MODULATION. BW = 15 MHz.

- Lowest Channel:

No spurious frequencies detected at less than 20 dB below the limit in all the range.

- Middle Channel:

No spurious frequencies detected at less than 20 dB below the limit in all the range.

- Highest Channel:

No spurious frequencies detected at less than 20 dB below the limit in all the range.

LTE Band 2. QPSK MODULATION. BW = 20 MHz.

- Lowest Channel:

No spurious frequencies detected at less than 20 dB below the limit in all the range.

- Middle Channel:

No spurious frequencies detected at less than 20 dB below the limit in all the range.

- Highest Channel:

No spurious frequencies detected at less than 20 dB below the limit in all the range.

Measurement uncertainty (dB)	<±2.03
------------------------------	--------

Verdict: PASS

3G Band II. WCDMA MODULATION.

Lowest Channel:

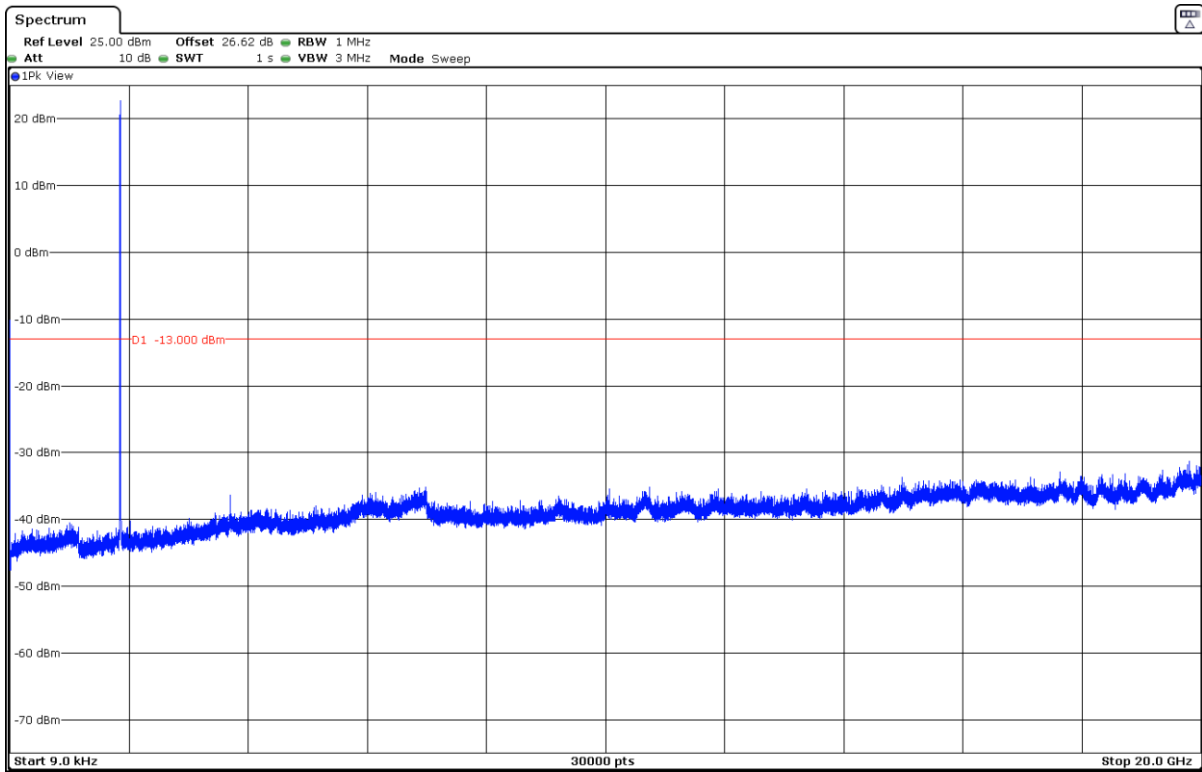

The peak above the limit is the carrier frequency.

Middle Channel:

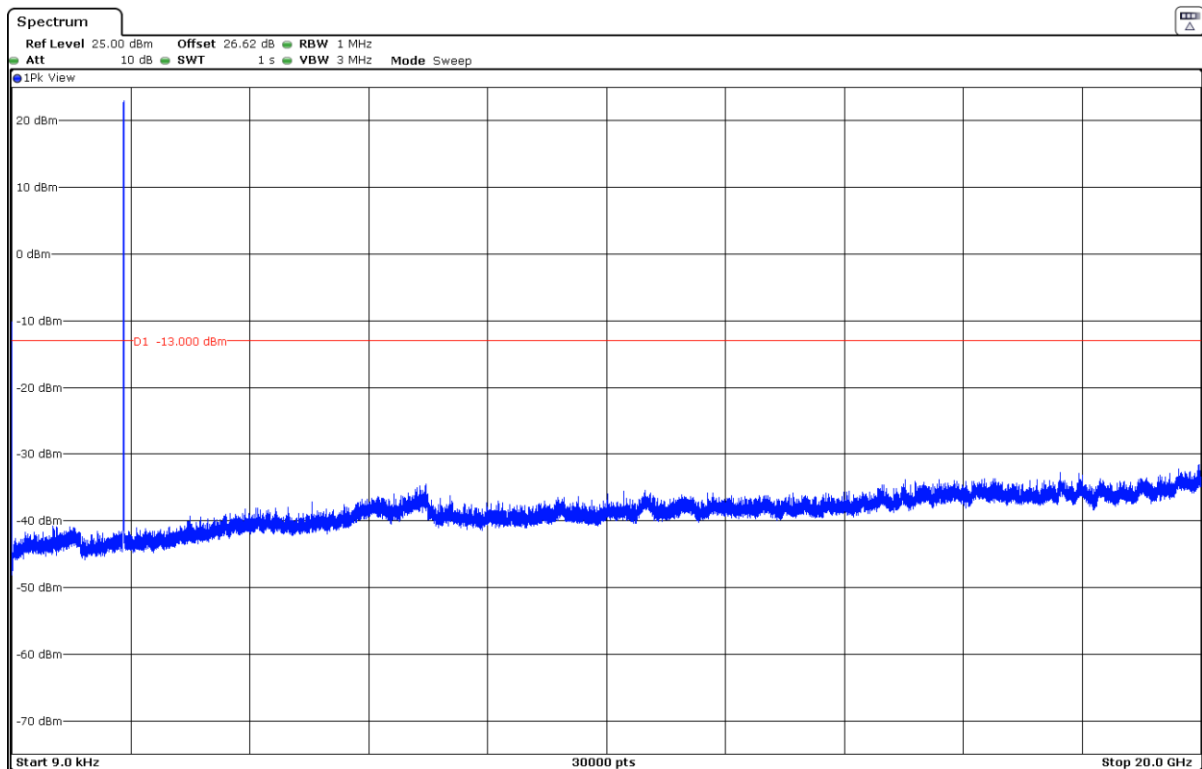

The peak above the limit is the carrier frequency.

Highest Channel:

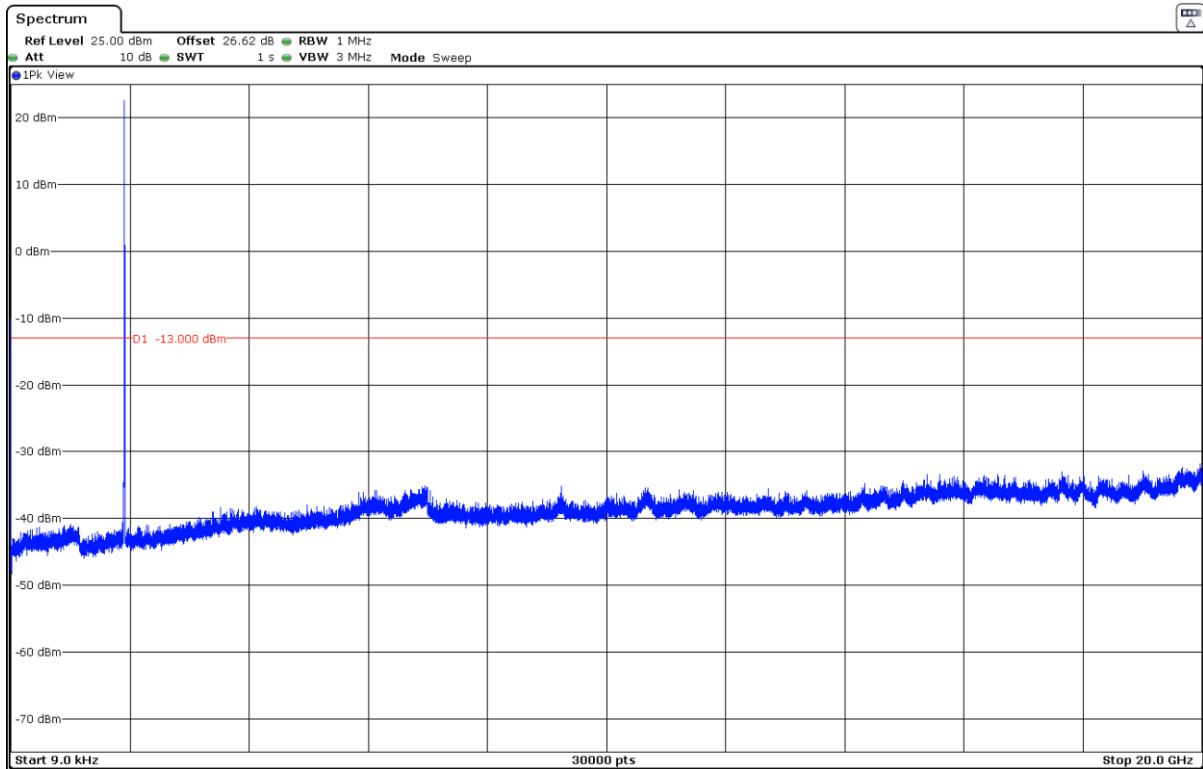

The peak above the limit is the carrier frequency.

3G Band II. HSUPA MODULATION.

Lowest Channel:

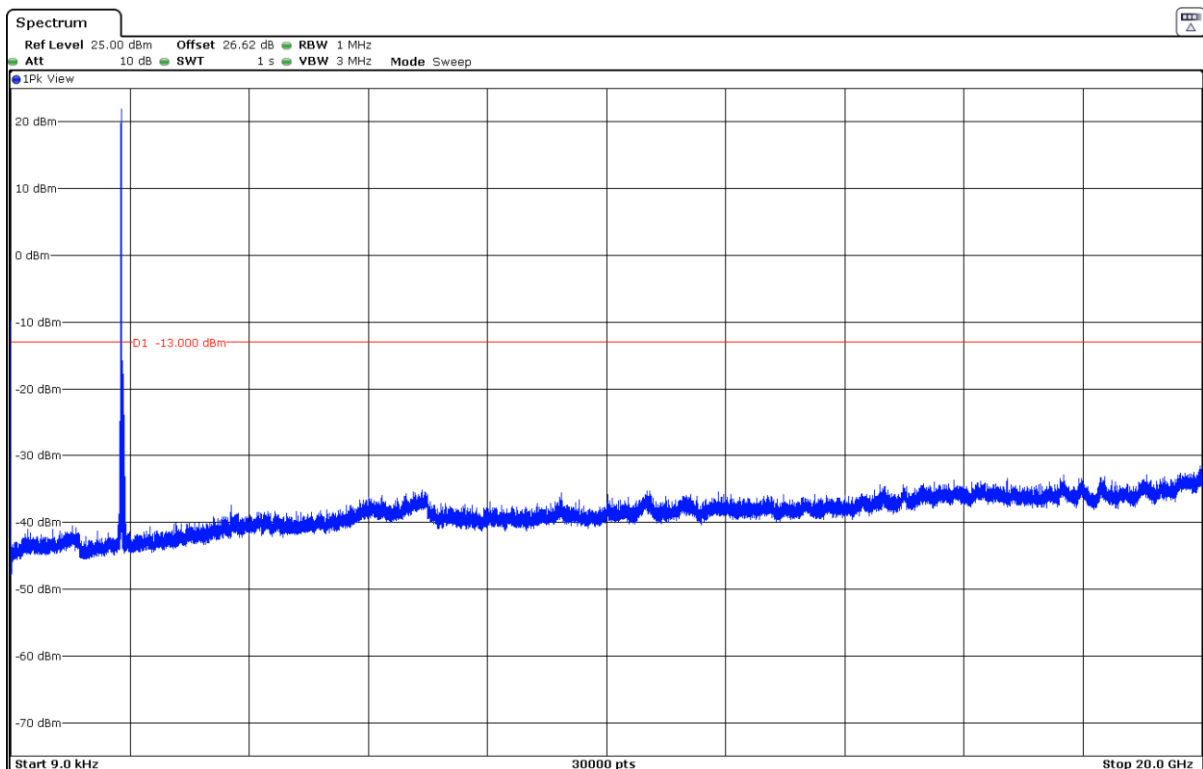

The peak above the limit is the carrier frequency.

Middle Channel:

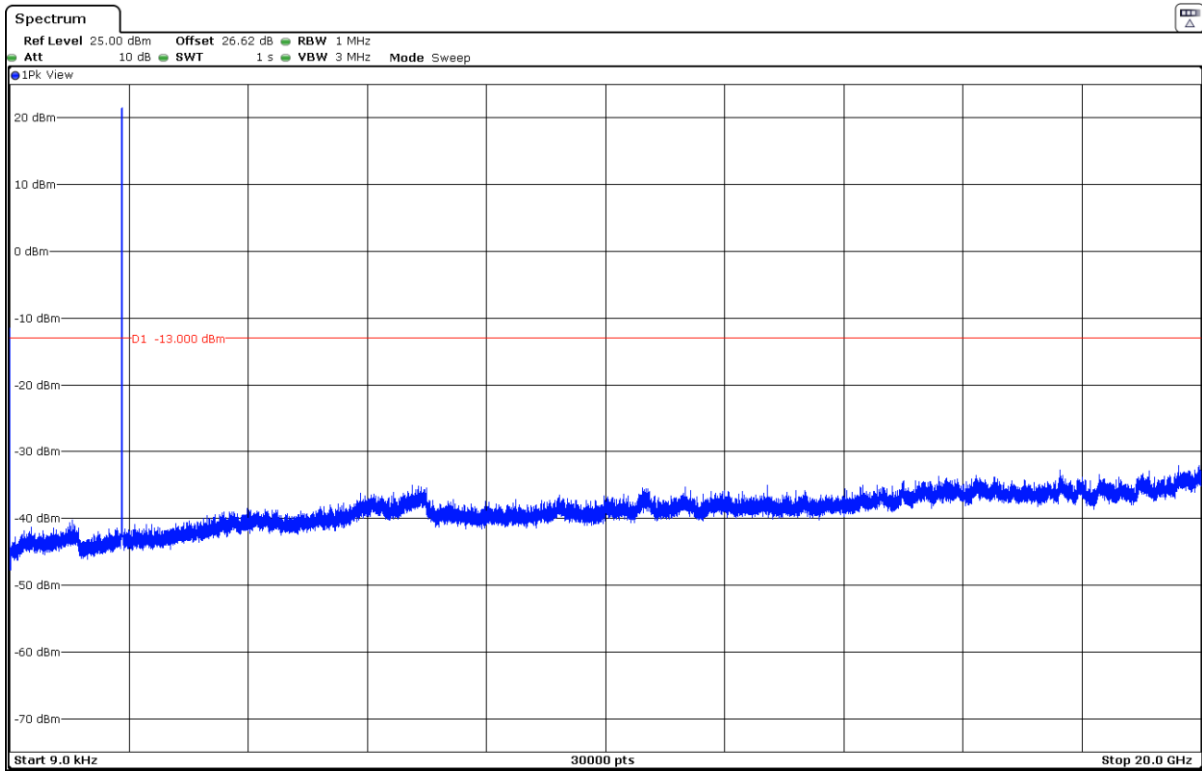

The peak above the limit is the carrier frequency.

Highest Channel:

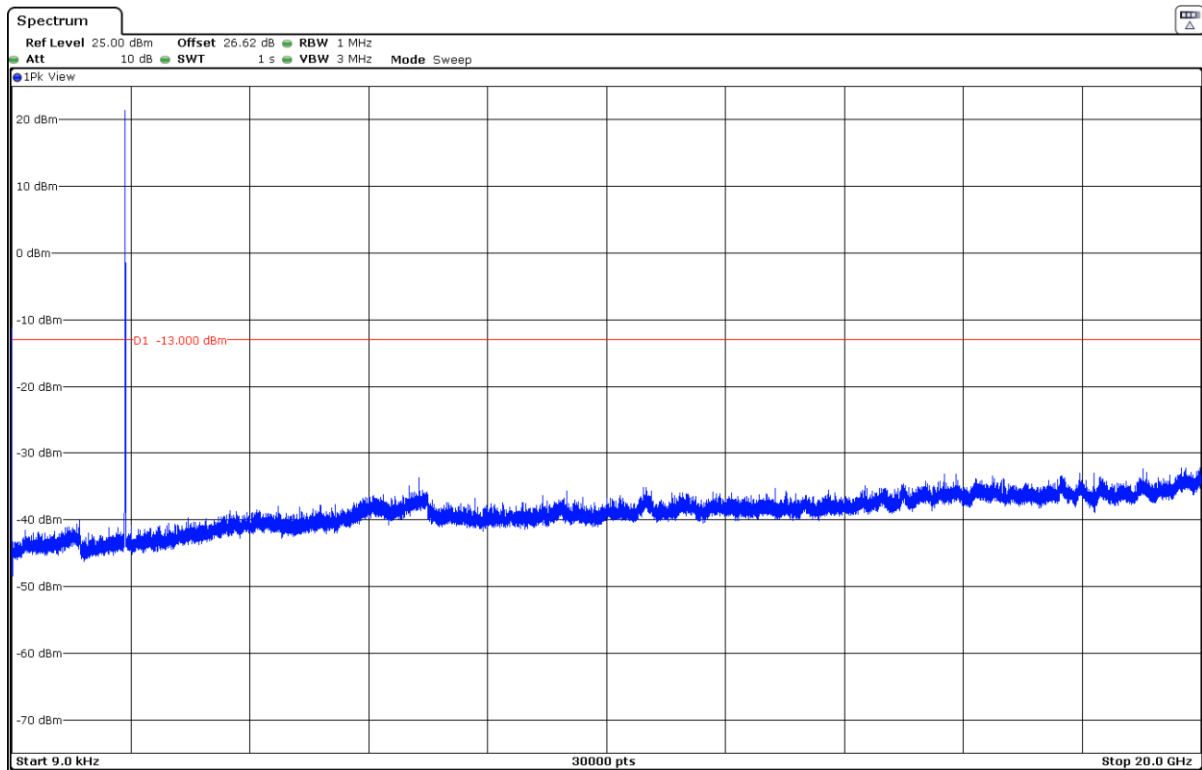

The peak above the limit is the carrier frequency.

LTE Band 2. QPSK MODULATION. BW = 1.4 MHz.

Lowest Channel:

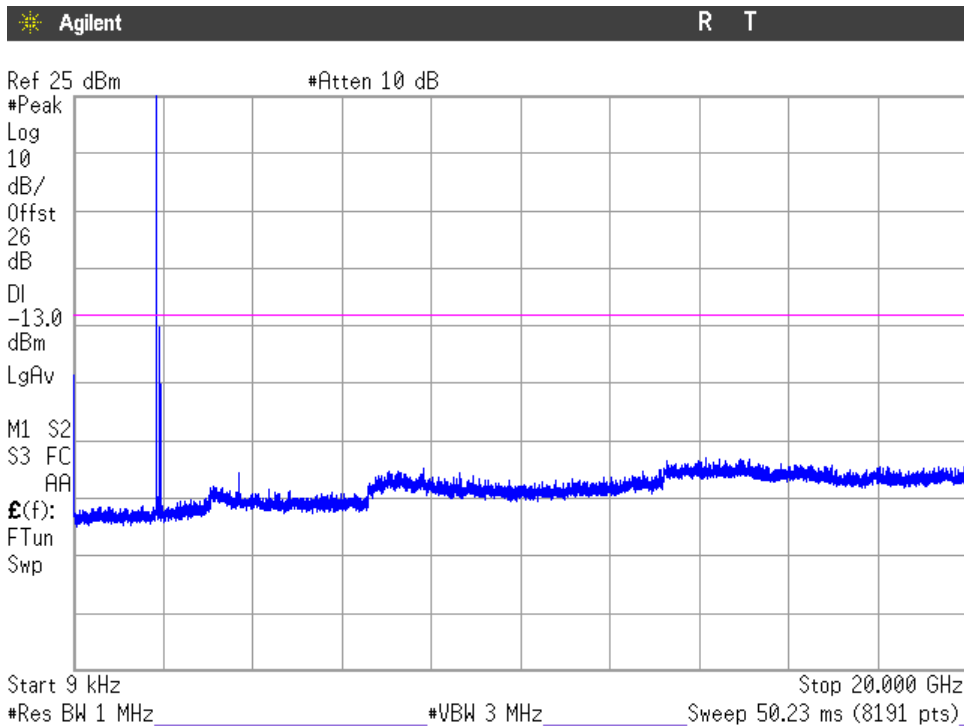

The peak above the limit is the carrier frequency.

Middle Channel:

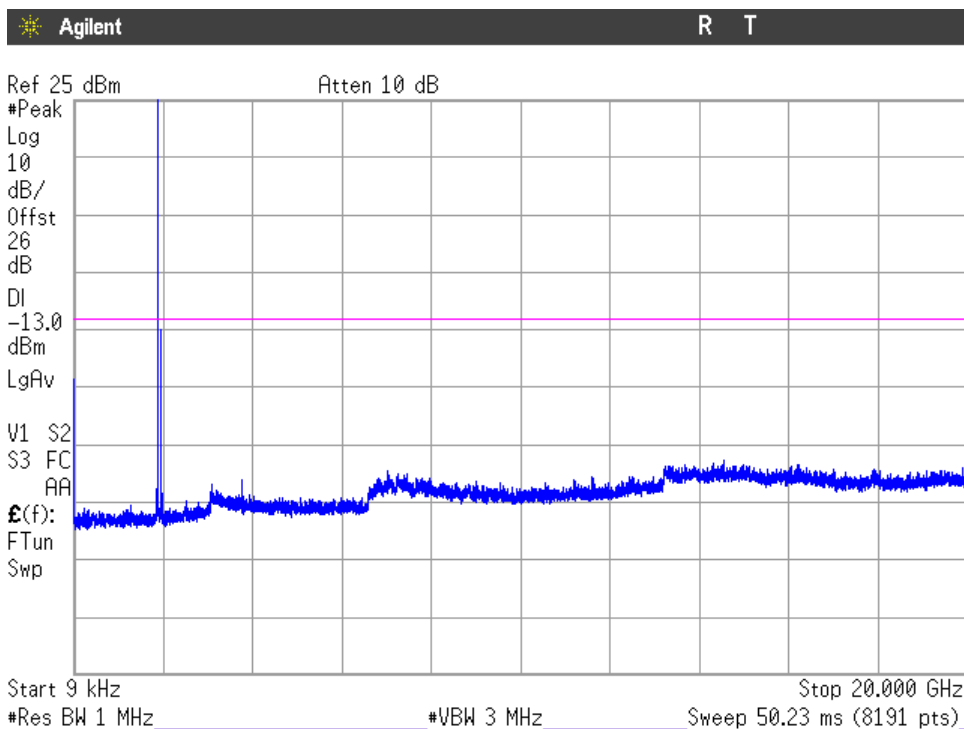

The peak above the limit is the carrier frequency.

Highest Channel:

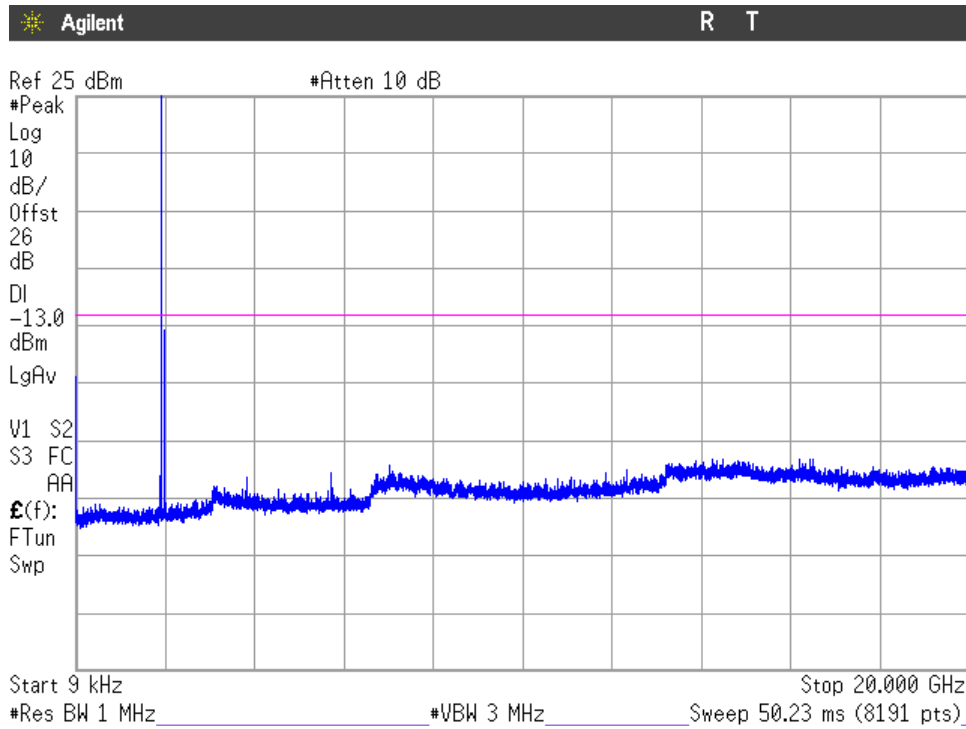

The peak above the limit is the carrier frequency.

LTE Band 2. QPSK MODULATION. BW = 3 MHz.

Lowest Channel:

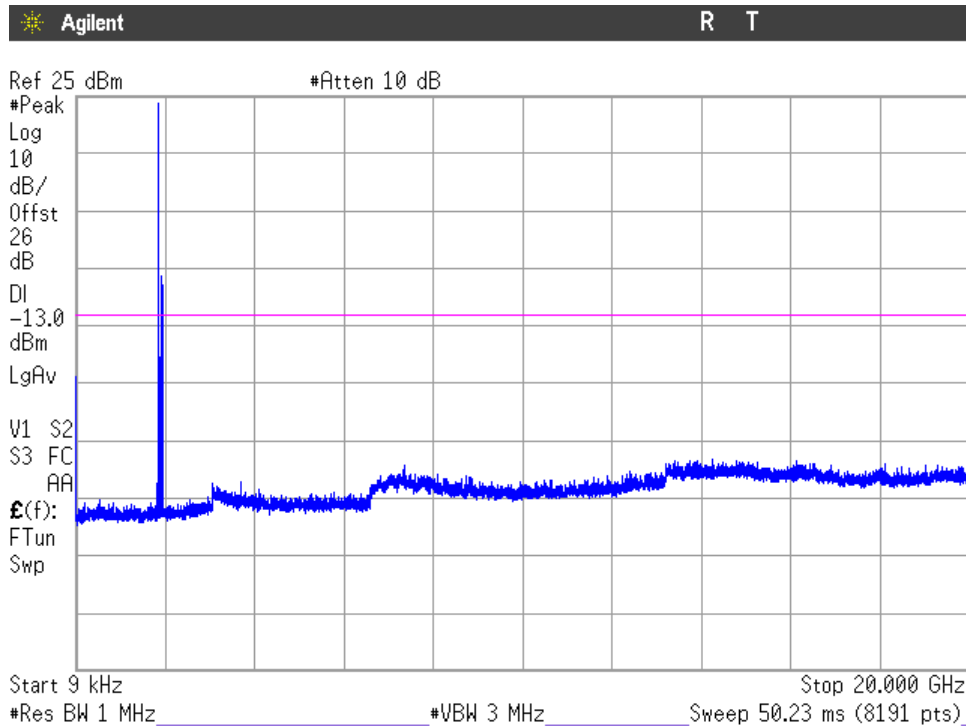

The peak above the limit is the carrier frequency.

Middle Channel:

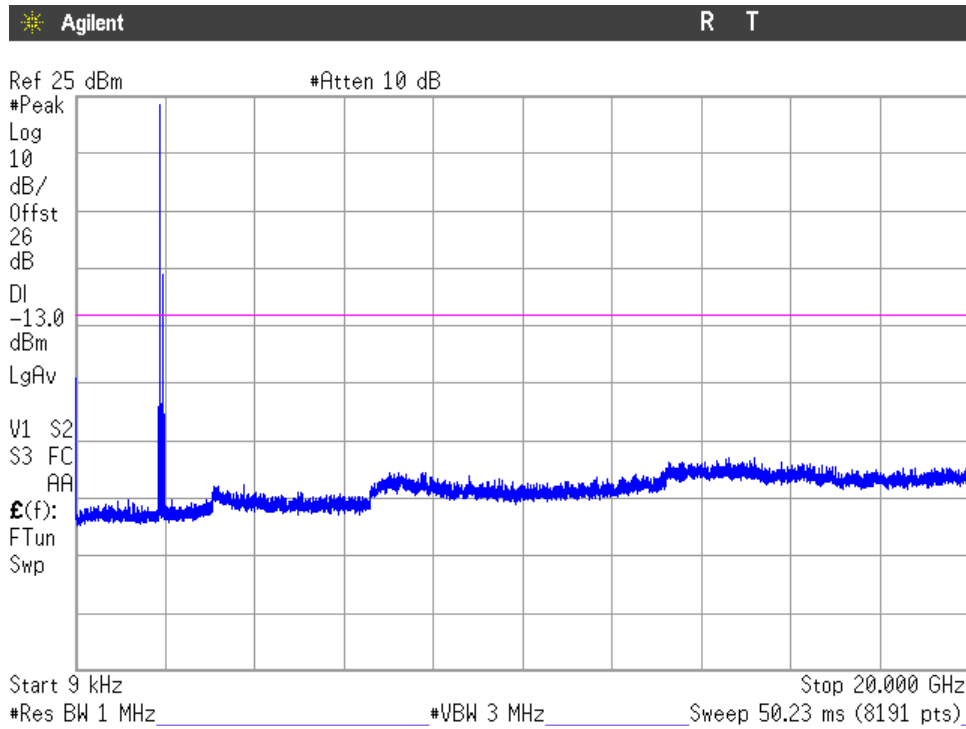

The peak above the limit is the carrier frequency.

Highest Channel:

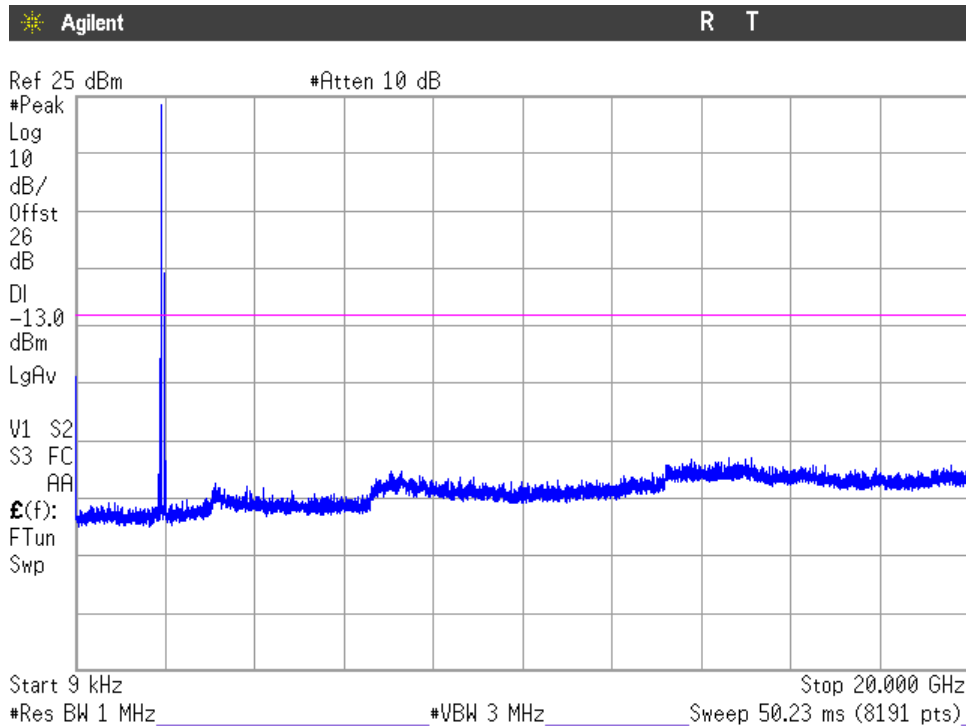

The peak above the limit is the carrier frequency.

LTE Band 2. QPSK MODULATION. BW = 5 MHz.

Lowest Channel:

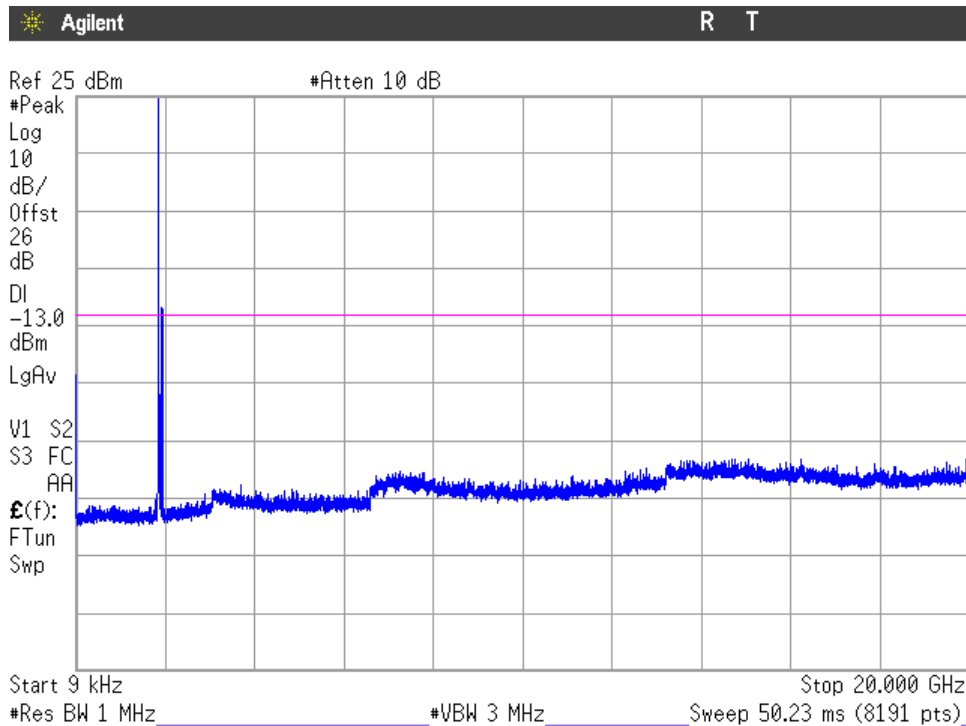

The peak above the limit is the carrier frequency.

Middle Channel:

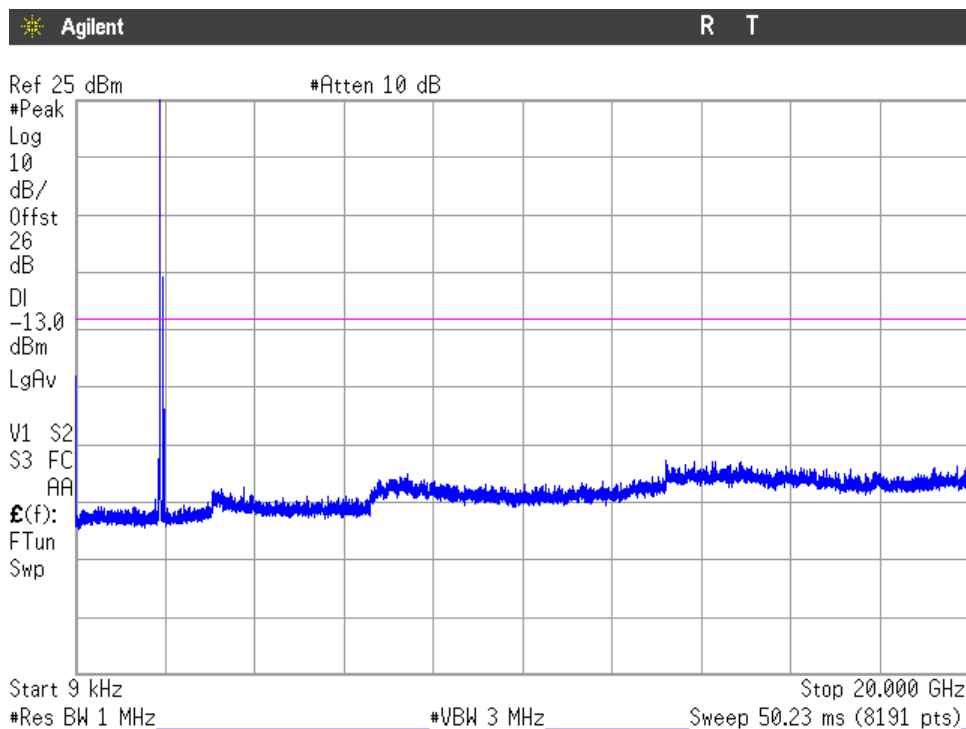

The peak above the limit is the carrier frequency.

Highest Channel:

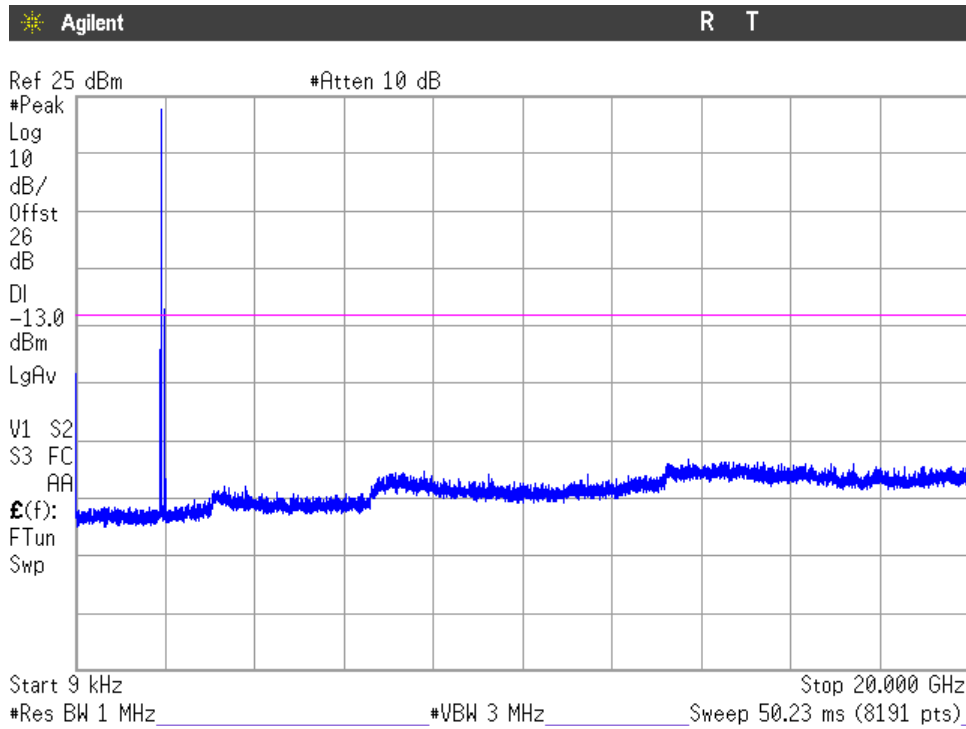

The peak above the limit is the carrier frequency.

LTE Band 2. QPSK MODULATION. BW = 10 MHz.

Lowest Channel:

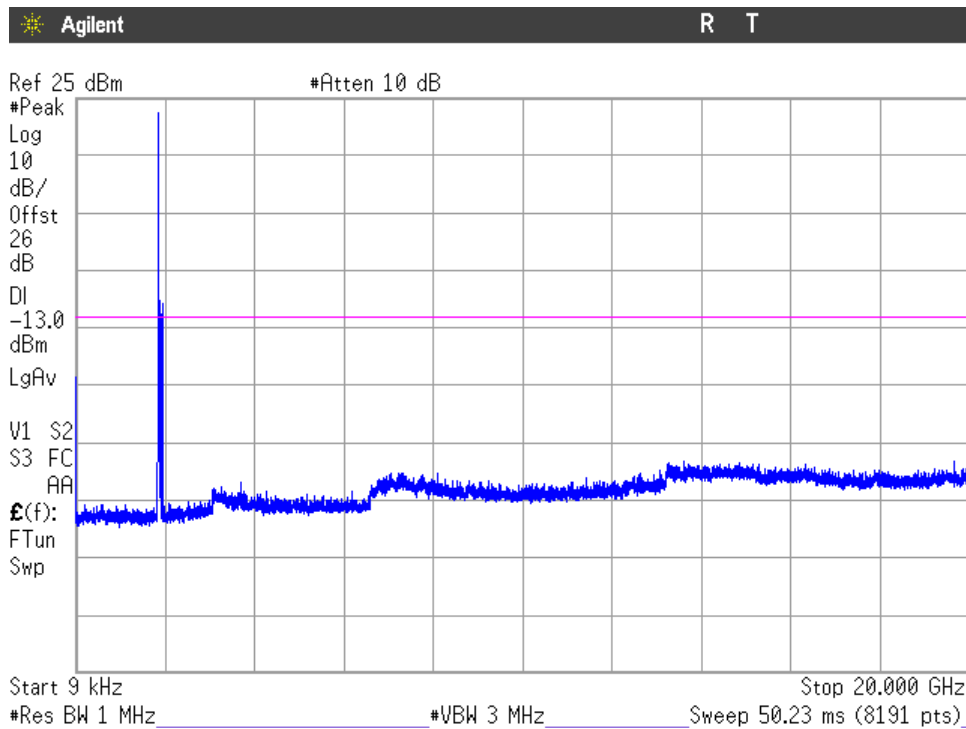

The peak above the limit is the carrier frequency.

Middle Channel:

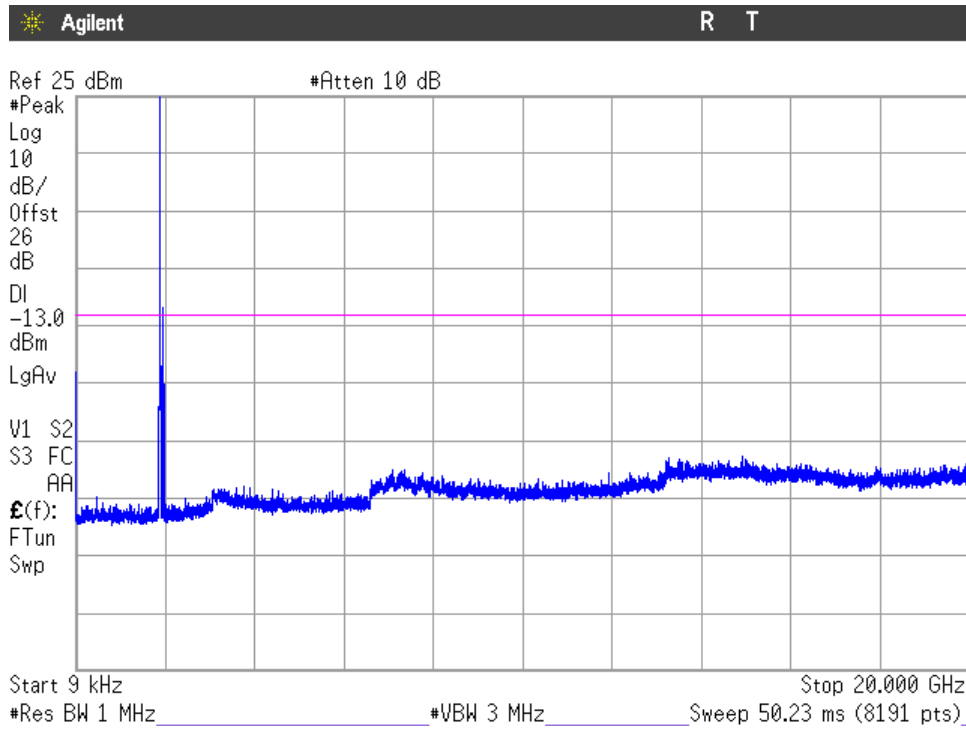

The peak above the limit is the carrier frequency.

Highest Channel:

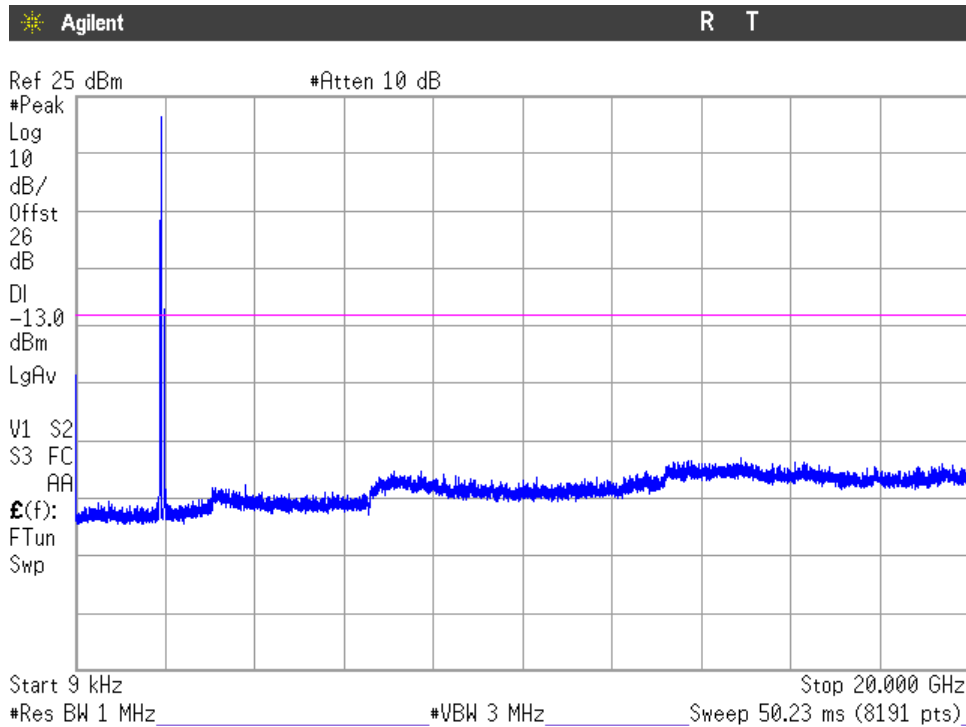

The peak above the limit is the carrier frequency.

LTE Band 2. QPSK MODULATION. BW = 15 MHz.

Lowest Channel:

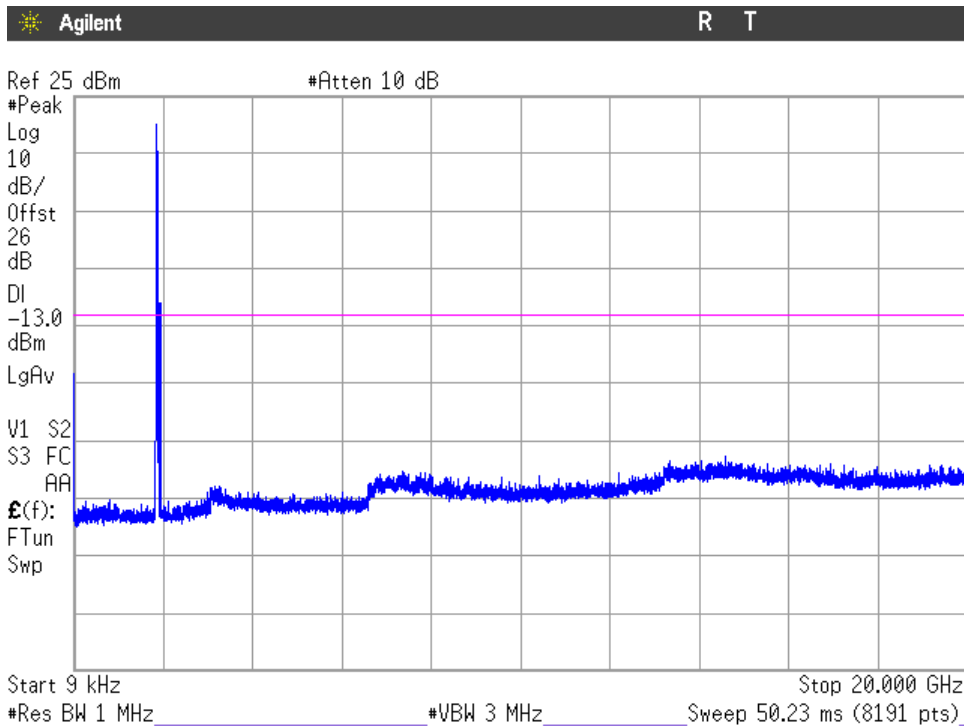

The peak above the limit is the carrier frequency.

Middle Channel:

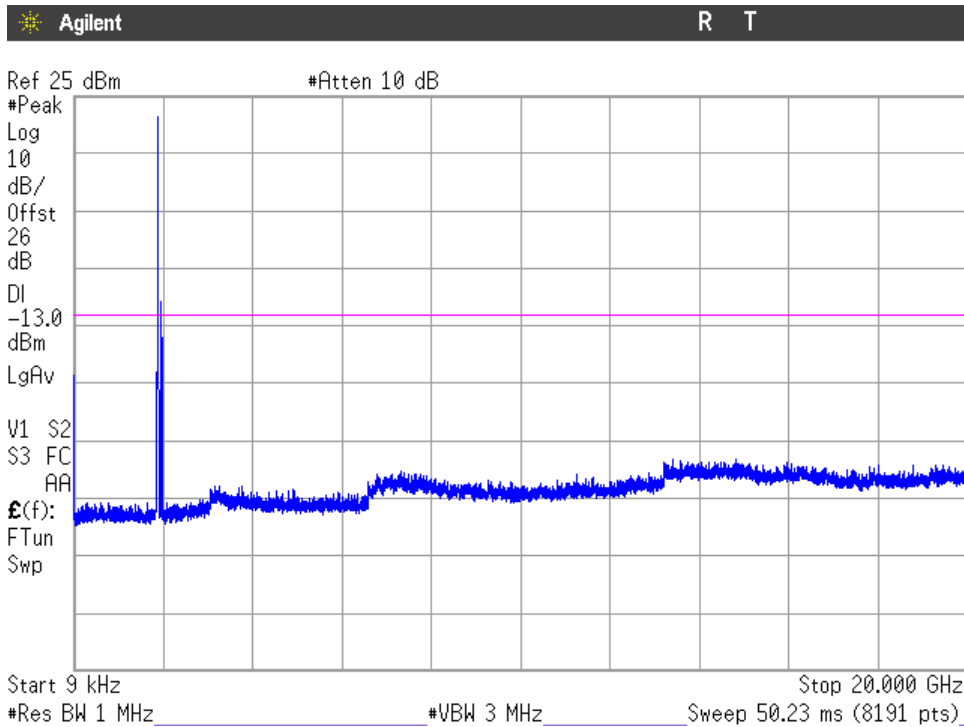

The peak above the limit is the carrier frequency.

Highest Channel:

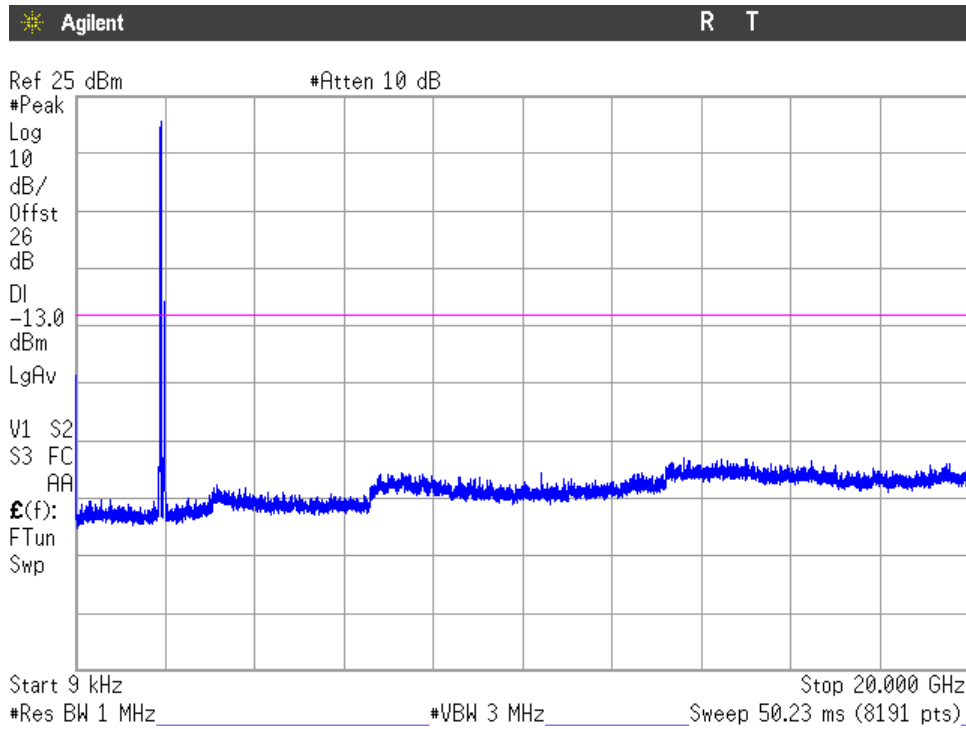

The peak above the limit is the carrier frequency.

LTE Band 2. QPSK MODULATION. BW = 20 MHz.

Lowest Channel:

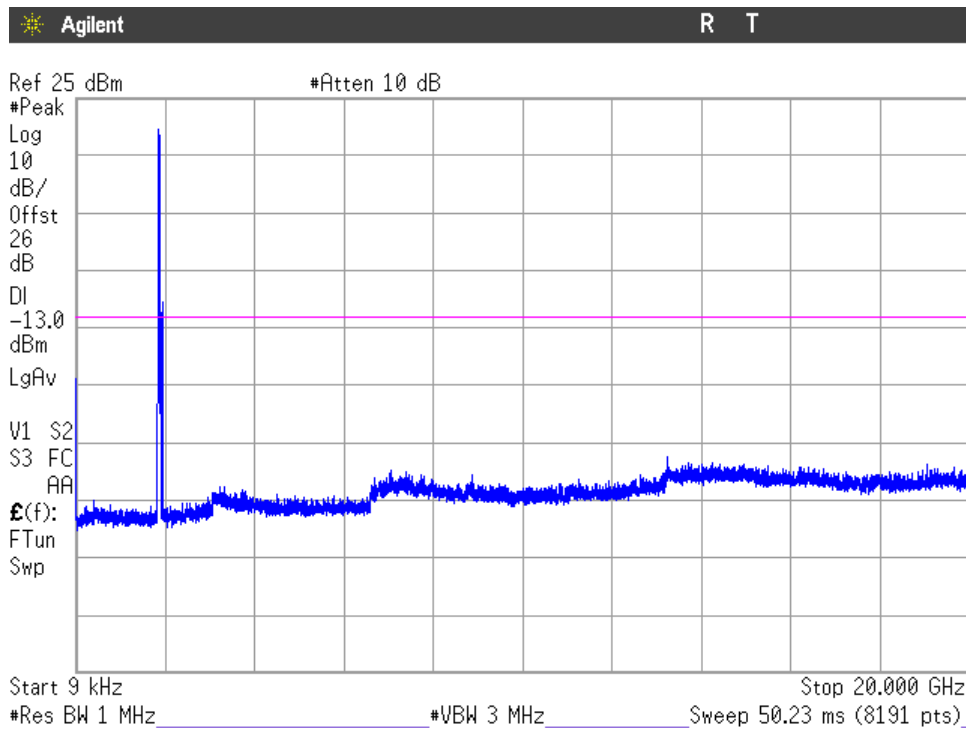

The peak above the limit is the carrier frequency.

Middle Channel:

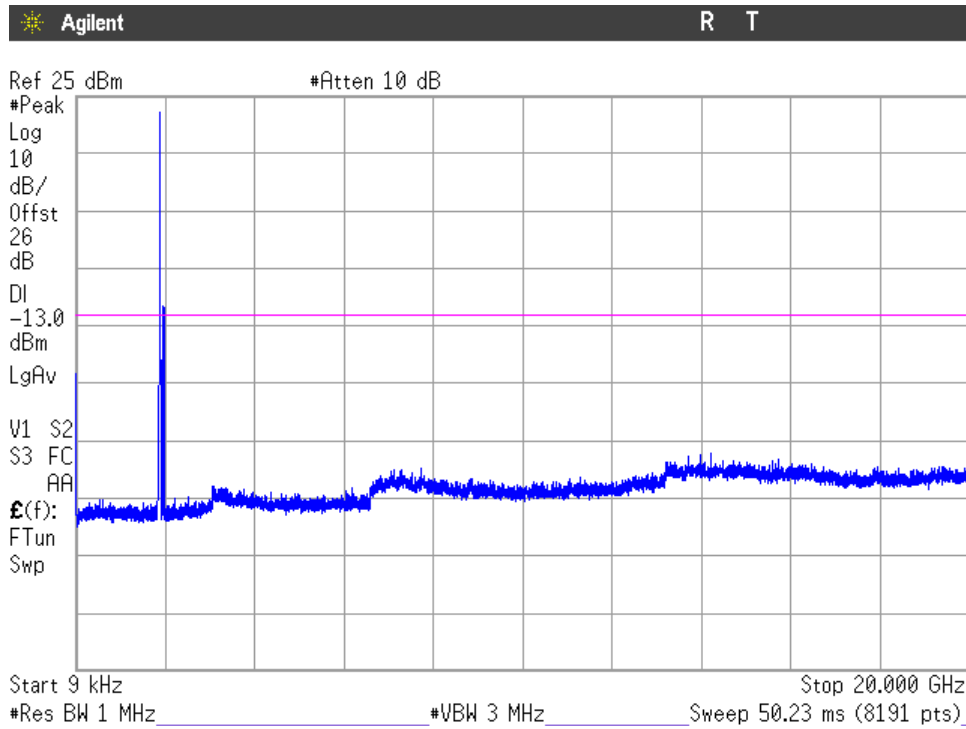

The peak above the limit is the carrier frequency.

Highest Channel:

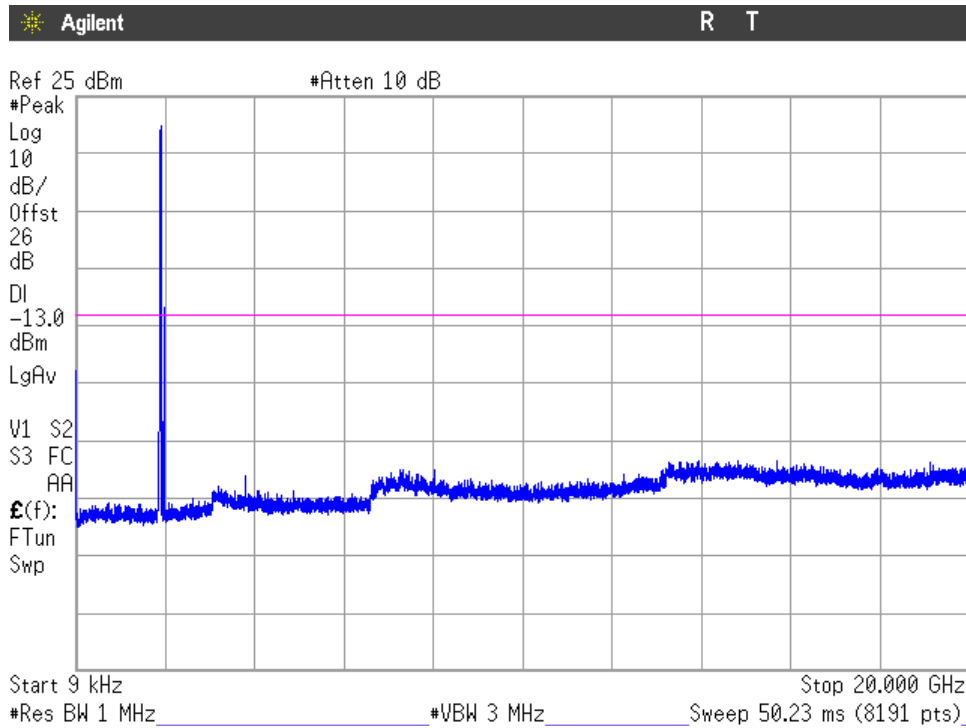

The peak above the limit is the carrier frequency.

Spurious emissions at antenna terminals at Block Edges

SPECIFICATION:

FCC §2.1051 and §24.238. RSS-133 Clause 6.5.

METHOD:

The EUT RF output connector was connected to a spectrum analyser and to the Universal Radio Communication tester R&S CMW500 (selecting maximum transmission power of the EUT and different modes of modulation) using a 50 ohm attenuator and a power splitter.

The reading of the spectrum analyser is corrected with the attenuation loss of connection between output terminal of EUT and input of the spectrum analyser.

As indicated in FCC part 24 in the 1 MHz bands immediately outside and adjacent to the frequency block or band a resolution bandwidth of at least one percent of the emission bandwidth of the fundamental emission of the transmitter may be employed.

The configuration of modulation which is the worst case for conducted power was used.

Measurement Limit:

According to specification, the power of emissions shall be attenuated below the transmitter power (P) by a factor of at least $43 + 10 \log (P)$ dB. P in watts.

At P_o transmitting power, the specified minimum attenuation becomes $43+10\log (P_o)$, and the level in dBm relative P_o becomes:

$$P_o \text{ (dBm)} - [43 + 10 \log (P_o \text{ in mwatts}) - 30] = - 13 \text{ dBm}$$

TEST SETUP:

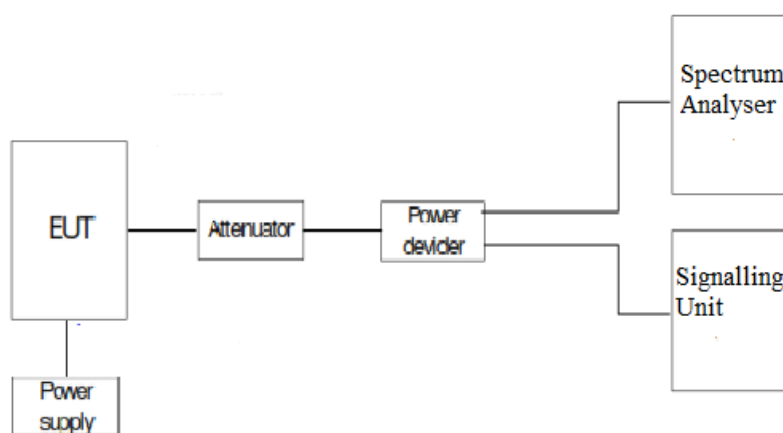

RESULTS:

3G Band II.

MODULATION:	WCDMA	HSUPA
Maximum measured level at <u>Lowest Block Edge</u> at antenna port (dBm)	-27.69	-29.02

MODULATION:	WCDMA	HSUPA
Maximum measured level at <u>Highest Block Edge</u> at antenna port (dBm)	-25.65	-30.75

Measurement uncertainty: $\leq \pm 1.57$ dB

LTE Band 2.

LTE QPSK MODULATION:	RB=1. Offset=0. BW=1.4 MHz	RB=1 . Offset =0. BW = 3 MHz	RB=1 . Offset =0. BW = 5 MHz	RB=1 . Offset =0. BW = 10 MHz	RB=1 . Offset =0. BW = 15 MHz	RB=1 . Offset =0. BW = 20 MHz
Maximum measured level at <u>Lowest Block Edge</u> at antenna port (dBm)	-23.66	-24.81	-24.77	-33.68	-30.33	-33.45

LTE QPSK MODULATION:	RB= All. Offset=0. BW=1.4 MHz	RB= All. Offset =0. BW = 3 MHz	RB= All. Offset =0. BW = 5 MHz	RB= All. Offset =0. BW = 10 MHz	RB= All. Offset =0. BW = 15 MHz	RB= All. Offset =0. BW = 20 MHz
Maximum measured level at <u>Lowest Block Edge</u> at antenna port (dBm)	-28.23	-26.48	-28.67	-29.4	-31.78	-32.15

LTE QPSK MODULATION:	RB=1. Offset=Max. BW =1.4 MHz	RB=1. Offset=Max. BW = 3 MHz	RB=1 . Offset=Max. BW = 5 MHz	RB=1 . Offset=Max. BW = 10 MHz	RB=1 . Offset=Max. BW = 15 MHz	RB=1 . Offset=Max. BW = 20 MHz
Maximum measured level at <u>Highest Block Edge</u> at antenna port (dBm)	-24.17	-23.02	-22.21	-23.26	-30.08	-29.55

LTE QPSK MODULATION:	RB= All. Offset=0. BW=1.4 MHz	RB= All. Offset =0. BW = 3 MHz	RB= All. Offset =0. BW = 5 MHz	RB= All. Offset =0. BW = 10 MHz	RB= All. Offset =0. BW = 15 MHz	RB= All. Offset =0. BW = 20 MHz
Maximum measured level at <u>Highest Block Edge</u> at antenna port (dBm)	-24.88	-23.1	-22.9	-26.78	-27.62	-30.62

Measurement uncertainty: $\leq \pm 2.03$ dB

Verdict: PASS

3G Band II. WCDMA MODULATION.

Lowest Channel:

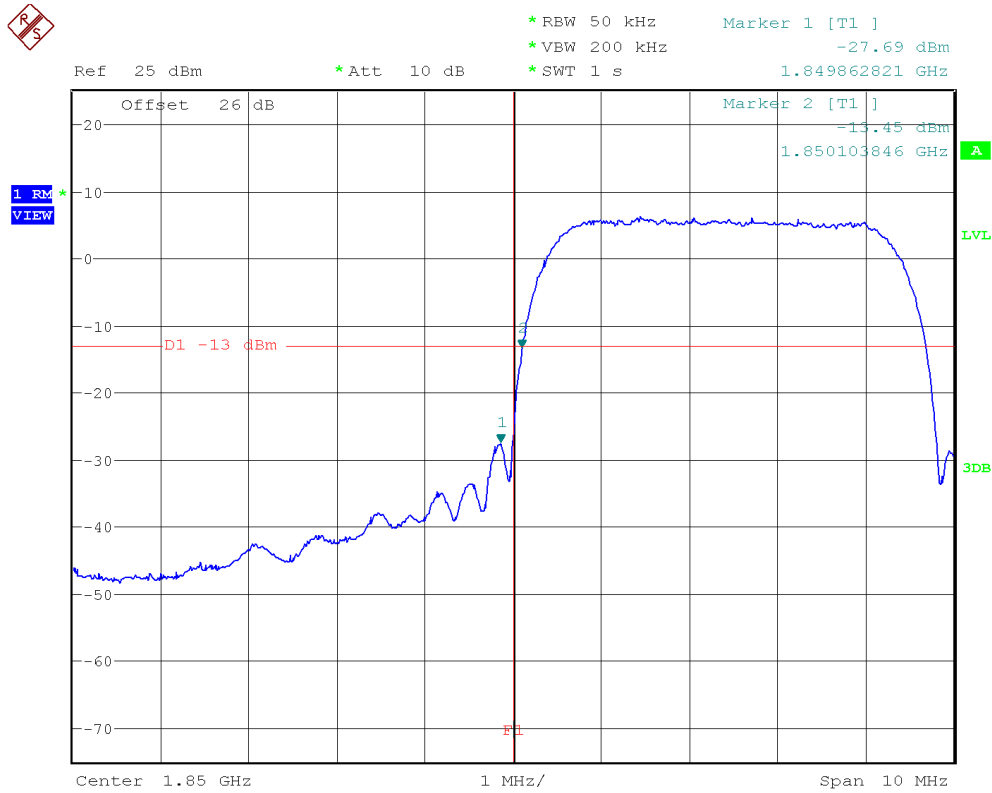

The equipment transmits at the maximum output power

Highest Channel:

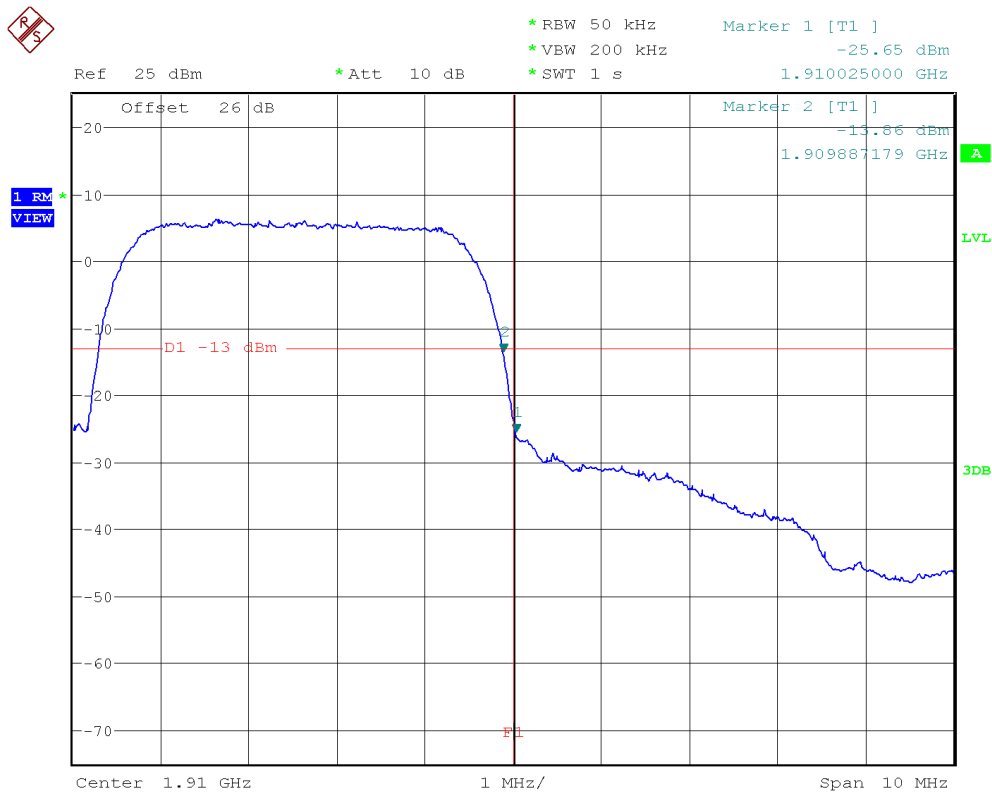

The equipment transmits at the maximum output power

3G Band II. HSUPA MODULATION.

Lowest Channel:

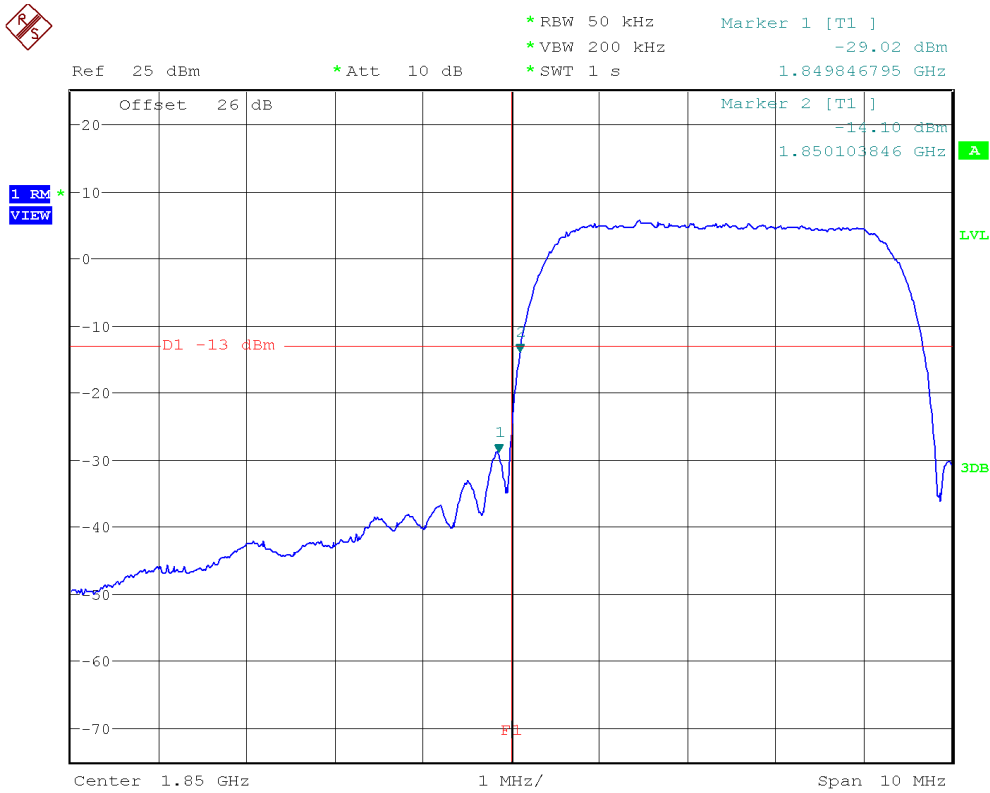

The equipment transmits at the maximum output power

Highest Channel:

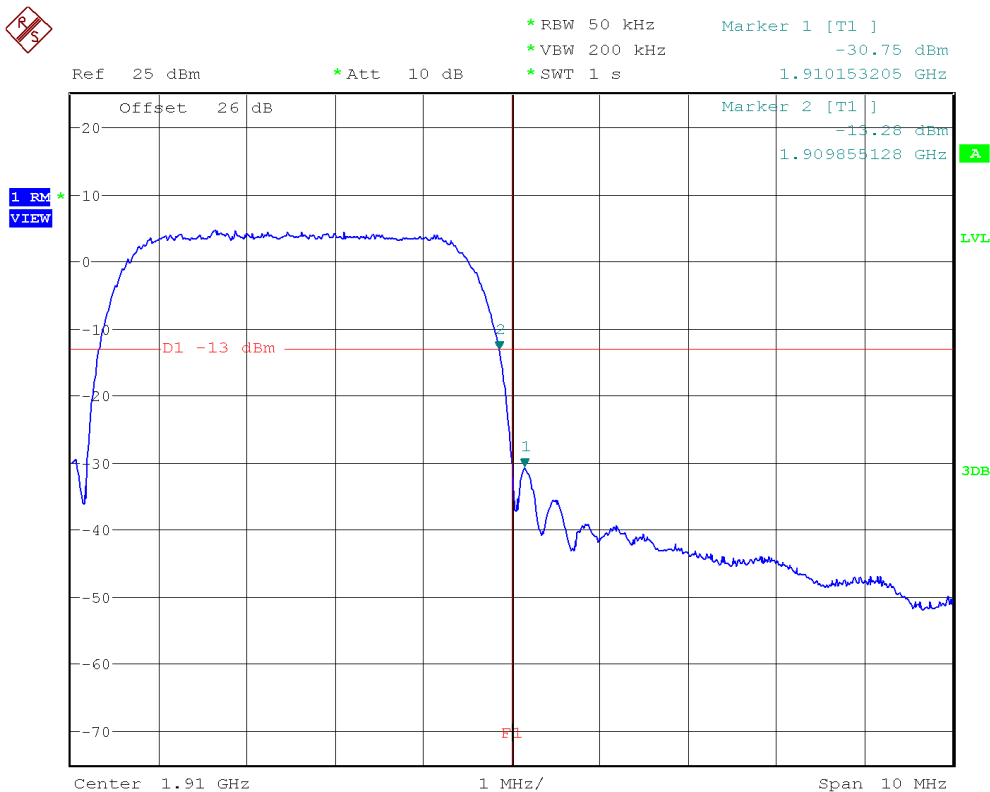

The equipment transmits at the maximum output power

LTE Band 2. QPSK MODULATION. BW=1.4 MHz. RB=1. Offset=0. Lowest Block Edge:

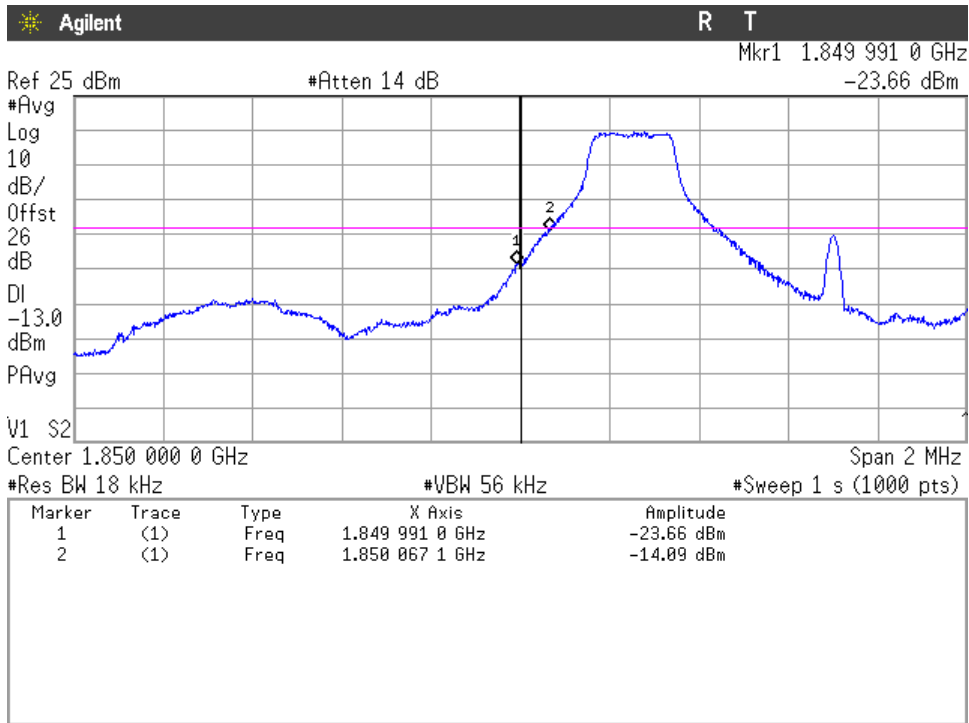

The equipment transmits at the maximum output power

LTE Band 2. QPSK MODULATION. BW=1.4 MHz. RB=1. Offset=Max. Highest Block Edge:

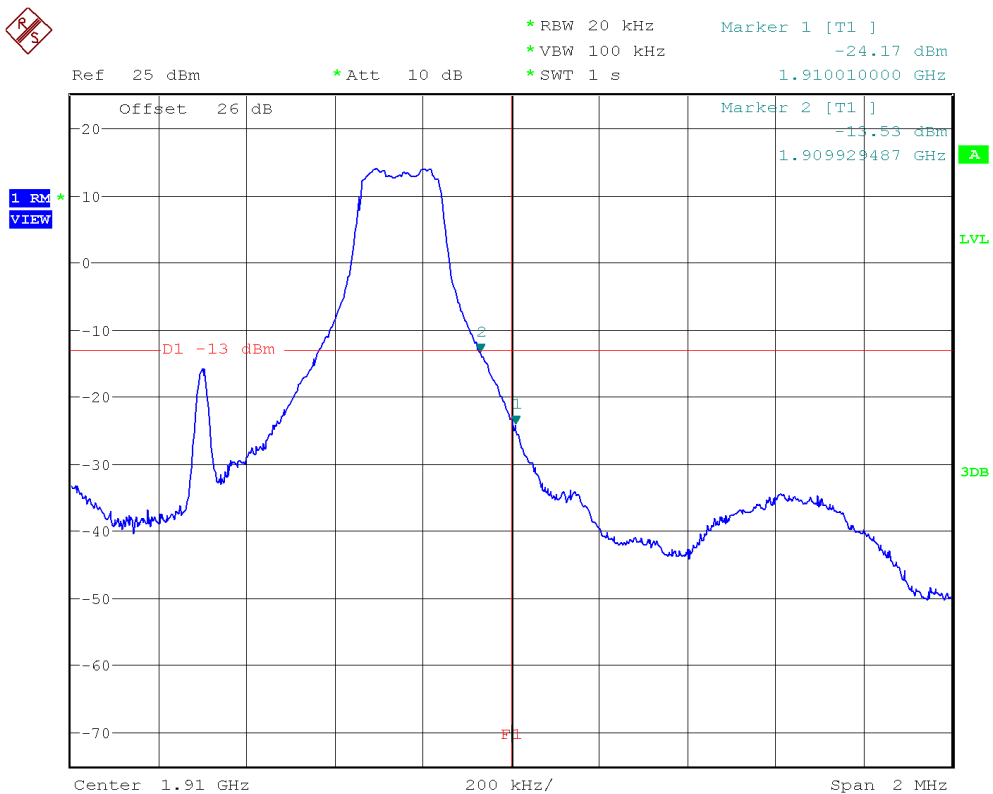

The equipment transmits at the maximum output power

LTE Band 2. QPSK MODULATION. BW=1.4 MHz. RB=All. Offset=0. Lowest and Highest Block Edges:

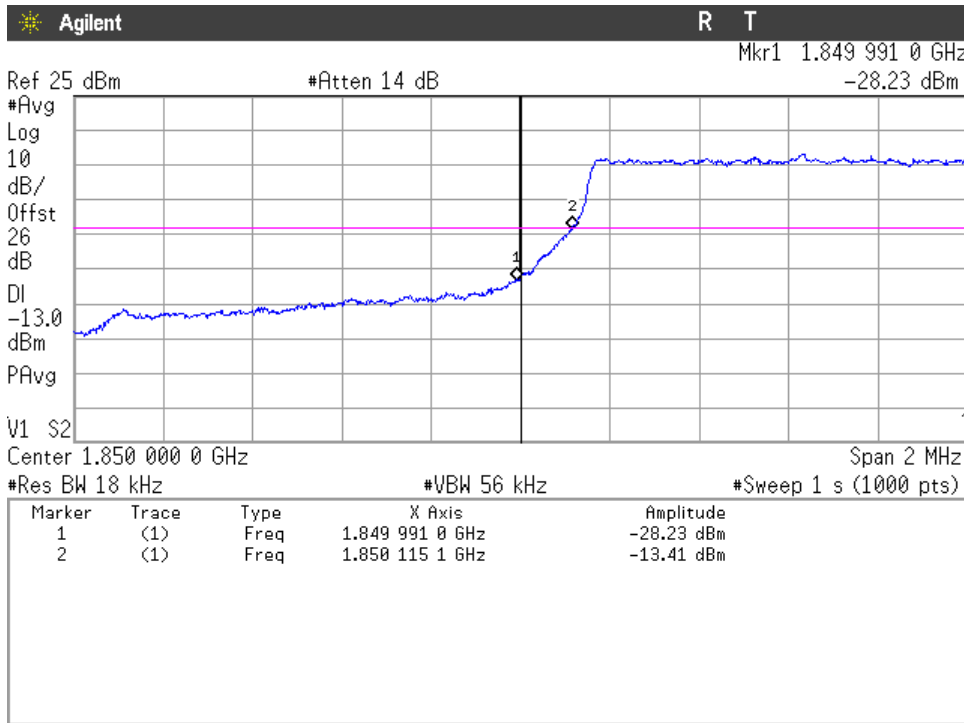

The equipment transmits at the maximum output power

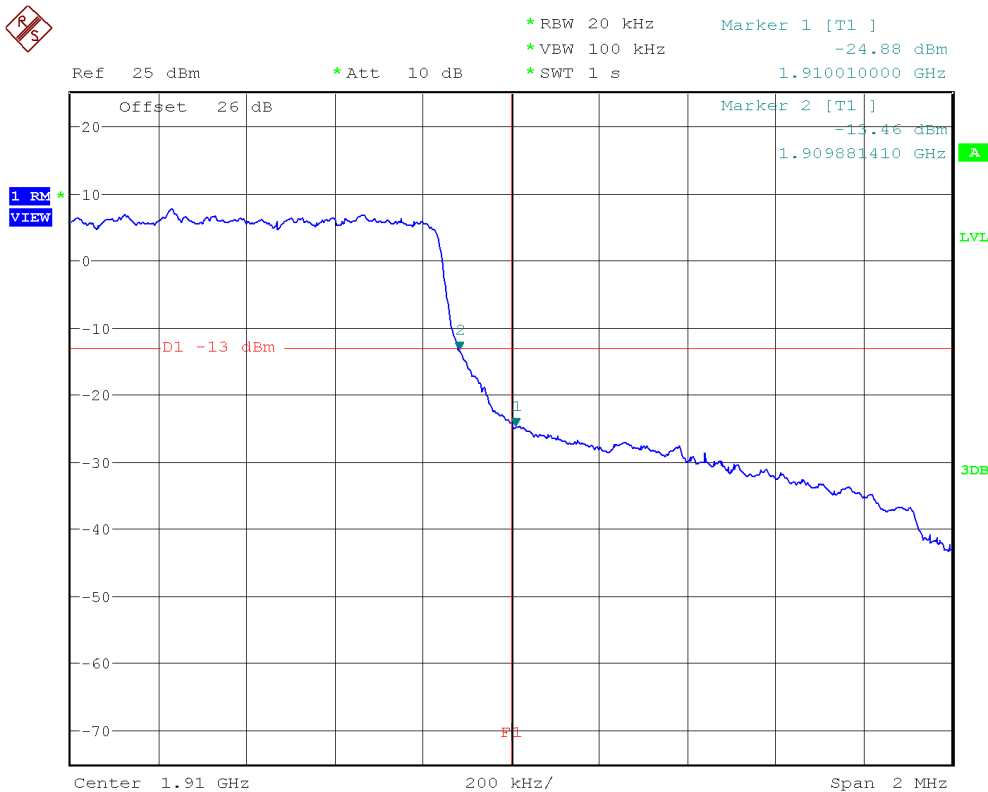

The equipment transmits at the maximum output power

Verdict: PASS

LTE Band 2. QPSK MODULATION. BW=3 MHz. RB=1. Offset=0. Lowest Block Edge:

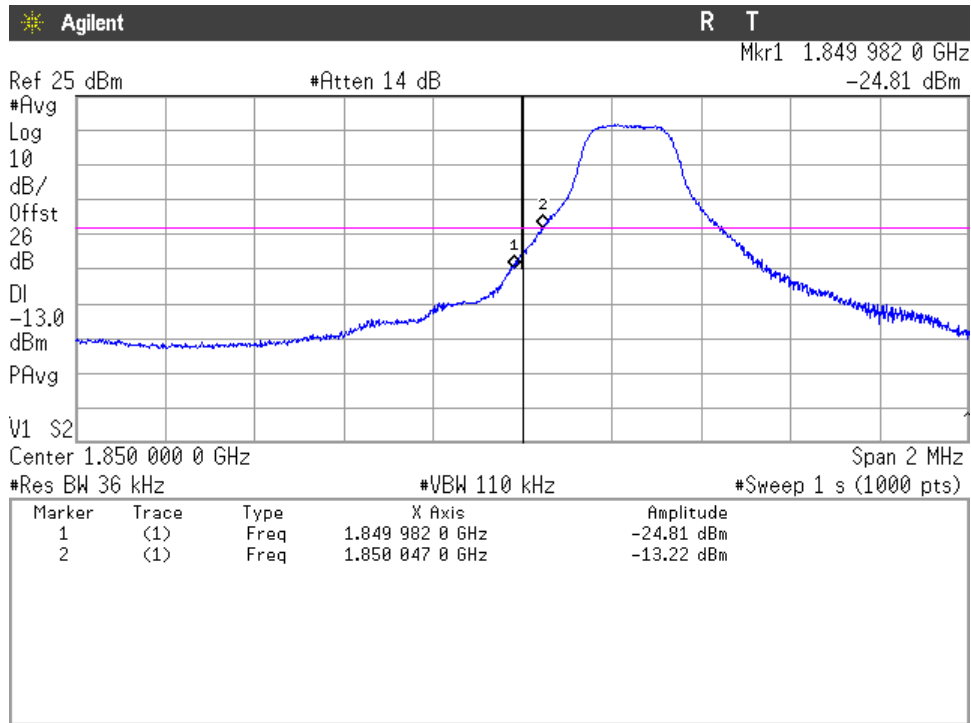

The equipment transmits at the maximum output power

LTE Band 2. QPSK MODULATION. BW=3 MHz. RB=1. Offset=Max. Highest Block Edge:

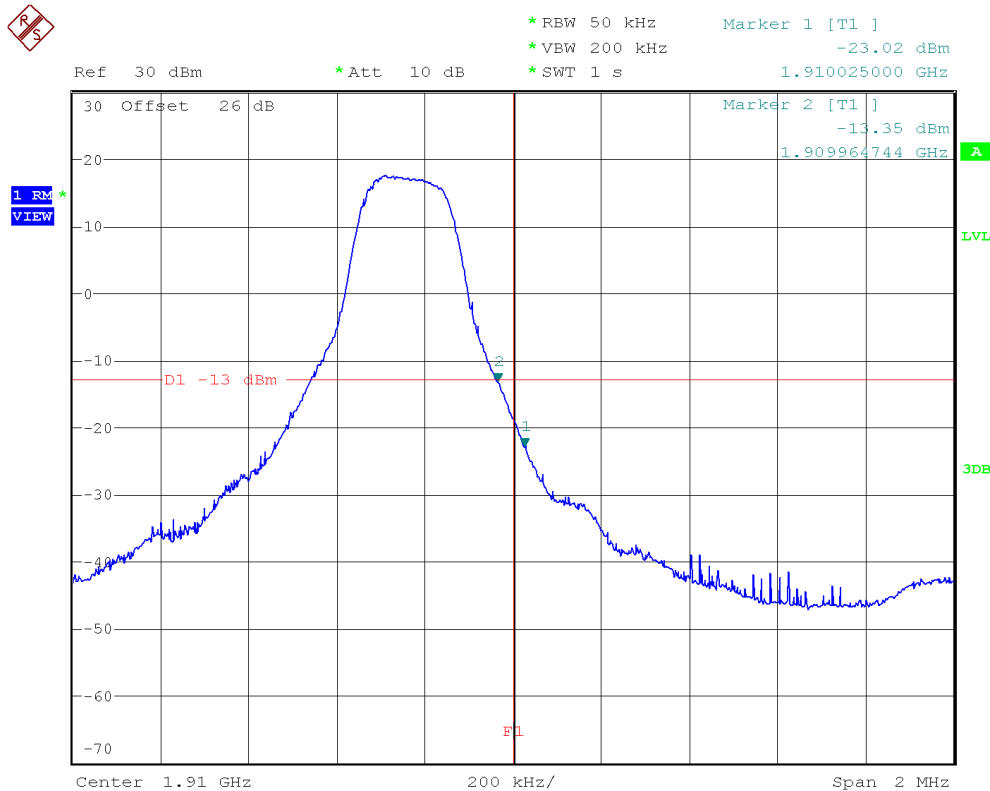

The equipment transmits at the maximum output power

LTE Band 2. QPSK MODULATION. BW=3 MHz. RB=All. Offset=0. Lowest and Highest Block Edges:

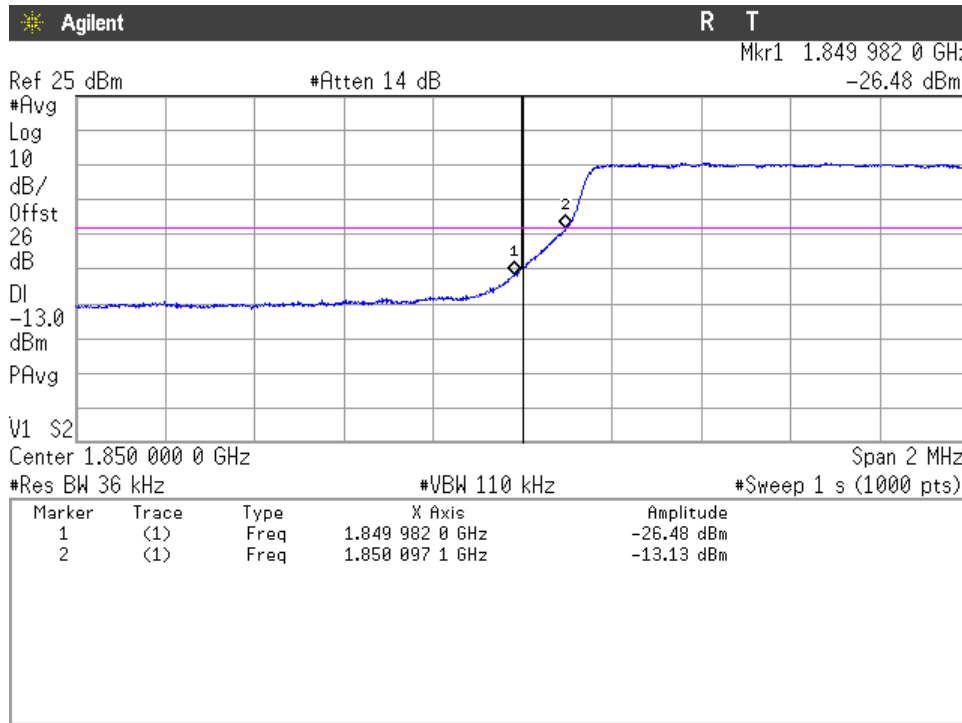

The equipment transmits at the maximum output power

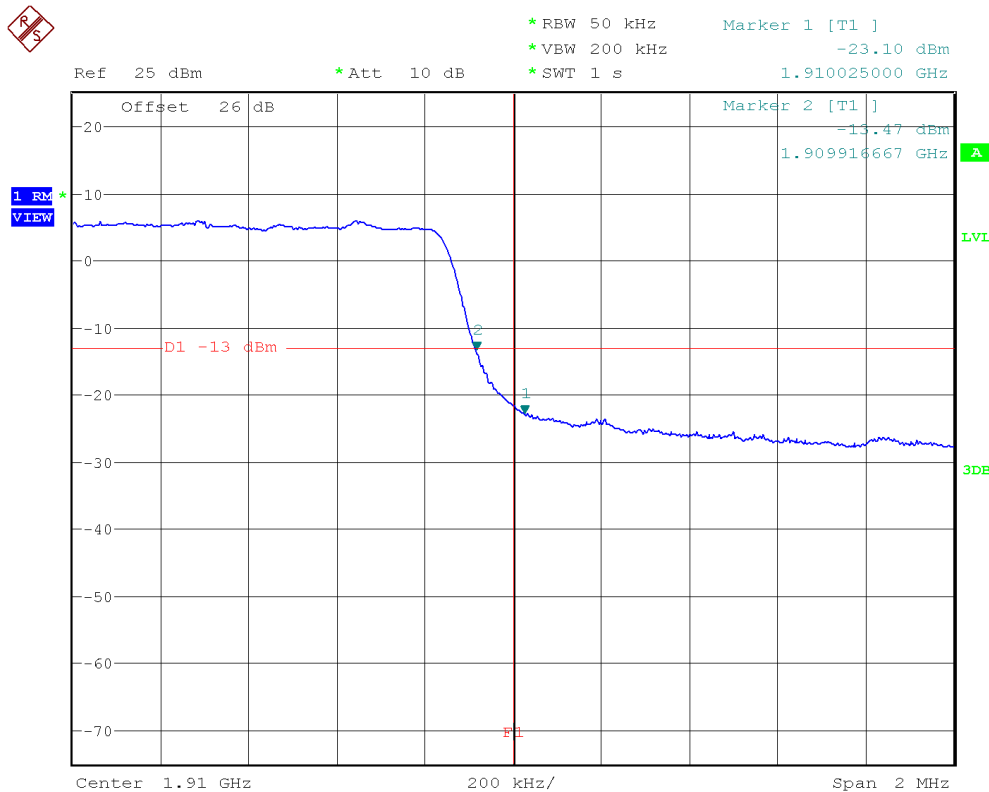

The equipment transmits at the maximum output power

Verdict: PASS

LTE Band 2. QPSK MODULATION. BW=5 MHz. RB=1. Offset=0. Lowest Block Edge:

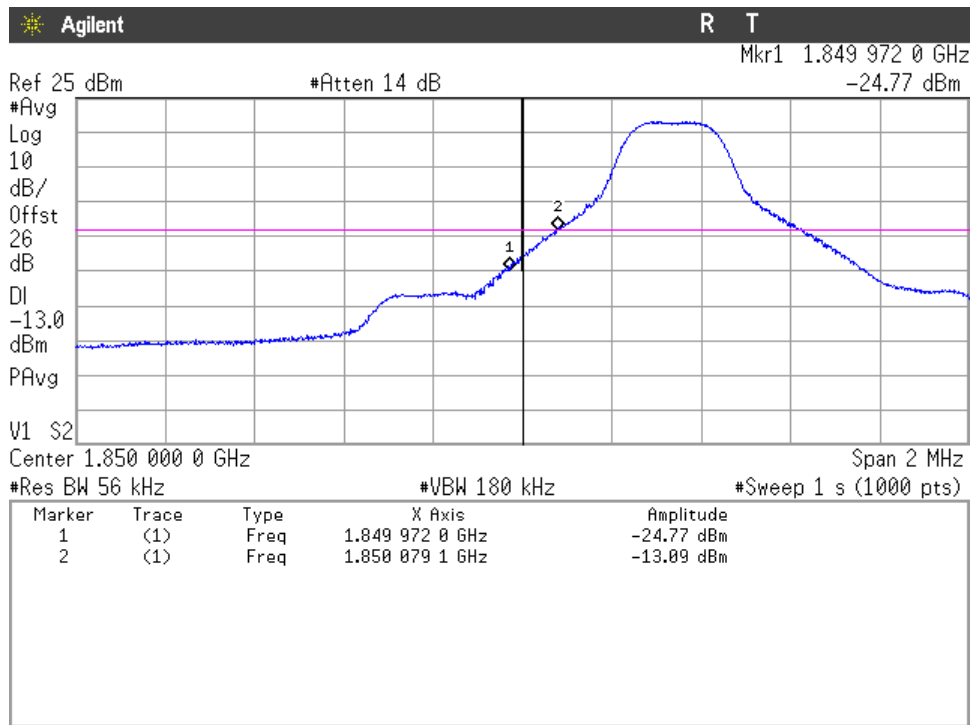

The equipment transmits at the maximum output power

LTE Band 2. QPSK MODULATION. BW=5 MHz. RB=1. Offset=Max. Highest Block Edge:

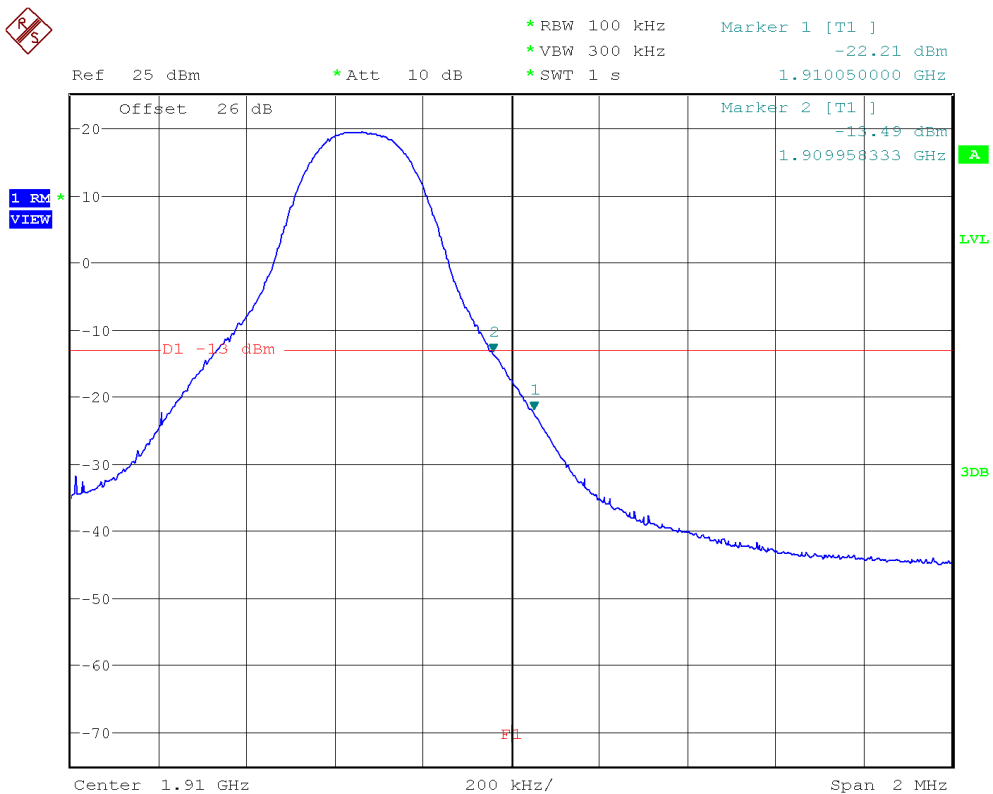

The equipment transmits at the maximum output power

LTE Band 2. QPSK MODULATION. BW=5 MHz. RB=All. Offset=0. Lowest and Highest Block Edges:

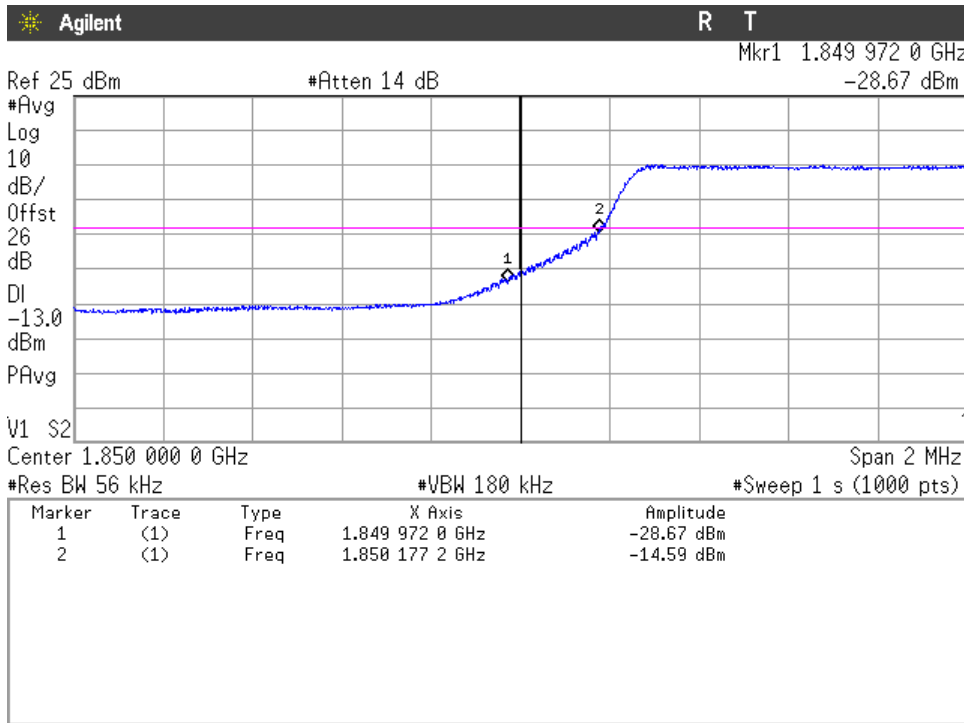

The equipment transmits at the maximum output power

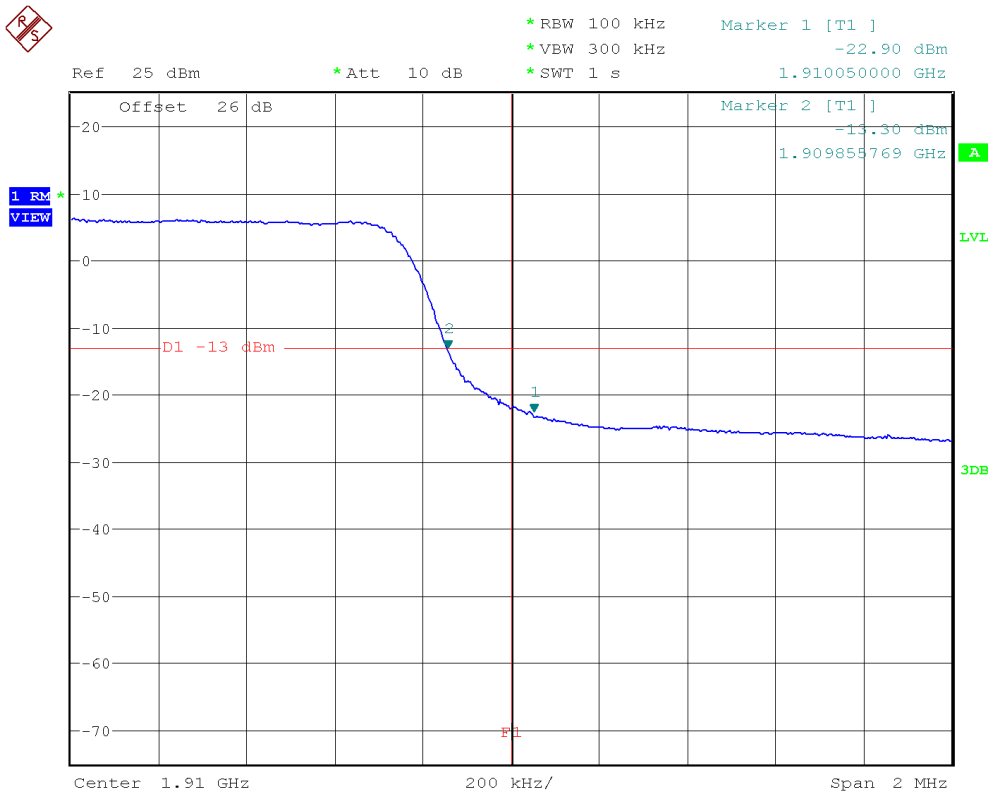

The equipment transmits at the maximum output power

Verdict: PASS

LTE Band 2. QPSK MODULATION. BW=10 MHz. RB=1. Offset=0. Lowest Block Edge:

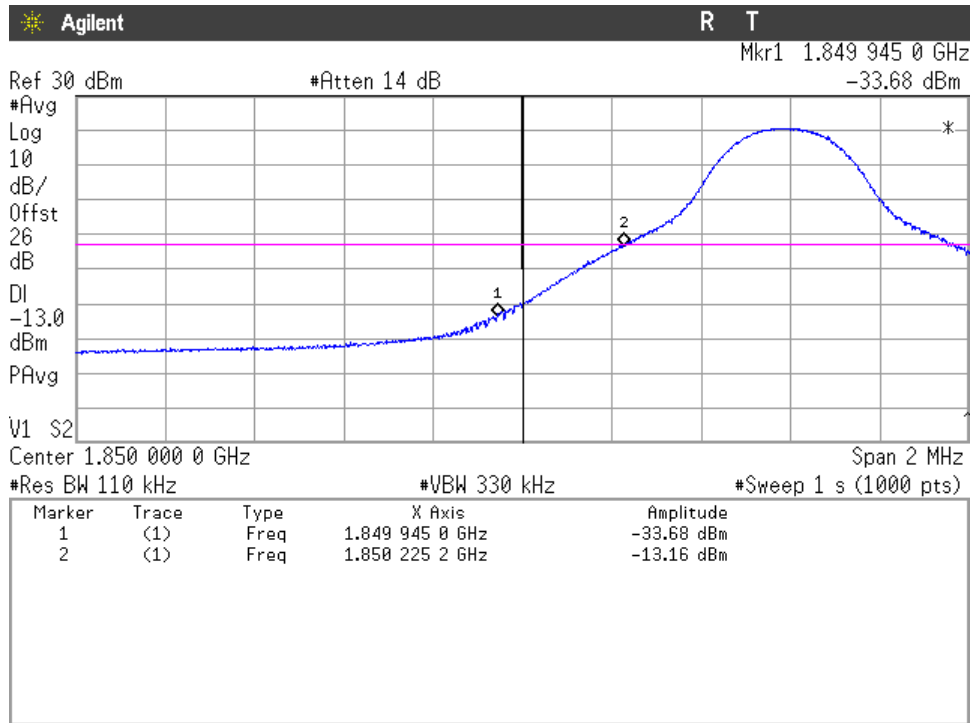

The equipment transmits at the maximum output power

LTE Band 2. QPSK MODULATION. BW=10 MHz. RB=1. Offset=Max. Highest Block Edge:

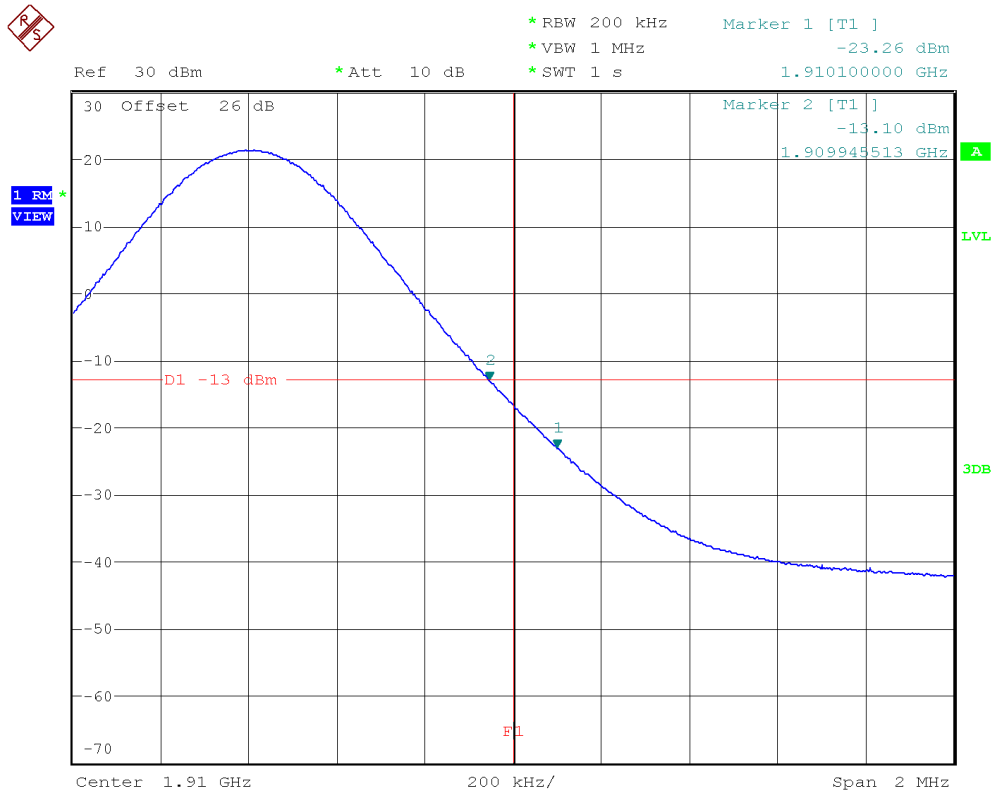

The equipment transmits at the maximum output power

LTE Band 2. QPSK MODULATION. BW=10 MHz. RB=All. Offset=0. Lowest and Highest Block Edges:

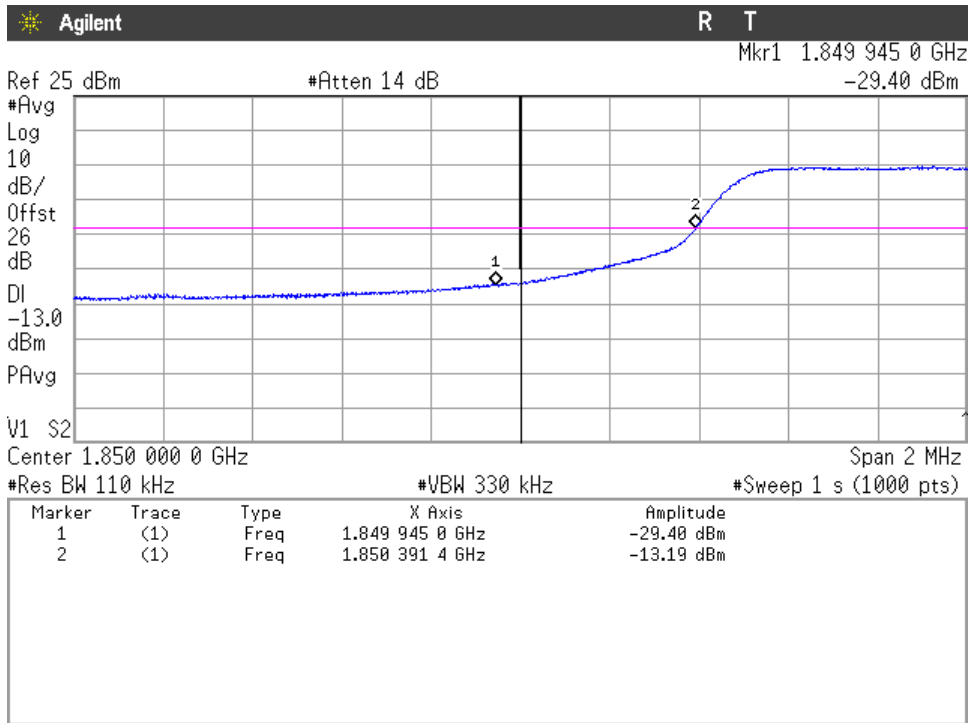

The equipment transmits at the maximum output power

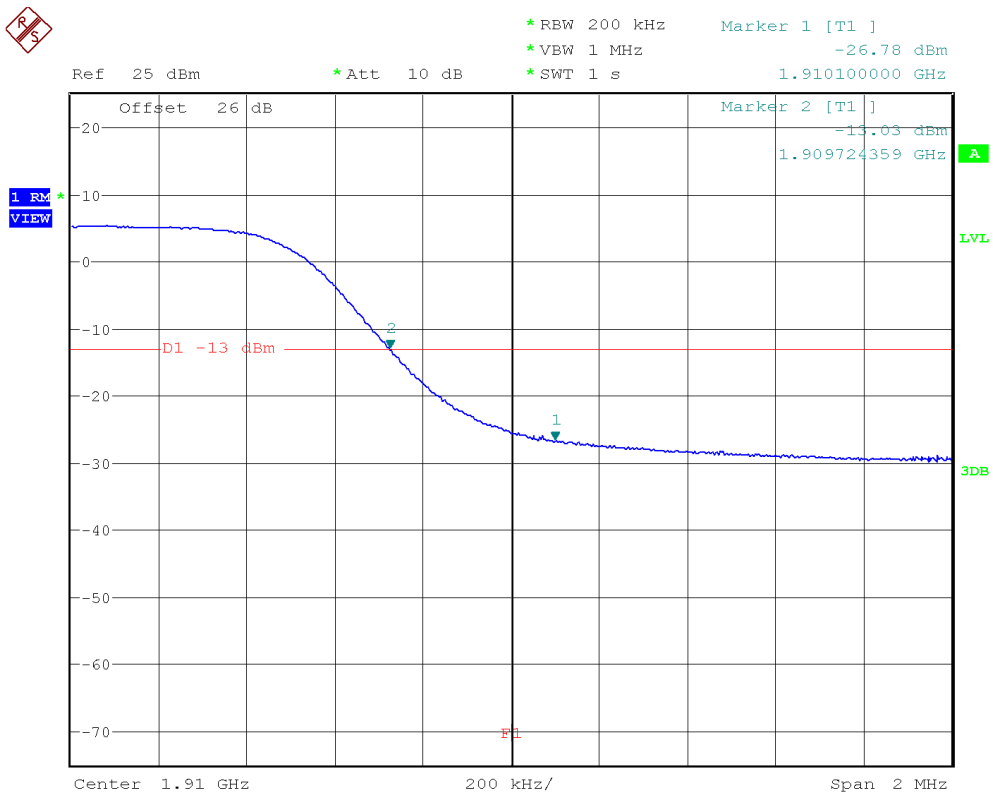

The equipment transmits at the maximum output power

Verdict: PASS

LTE Band 2. QPSK MODULATION. BW=15 MHz. RB=1. Offset=0. Lowest Block Edge:

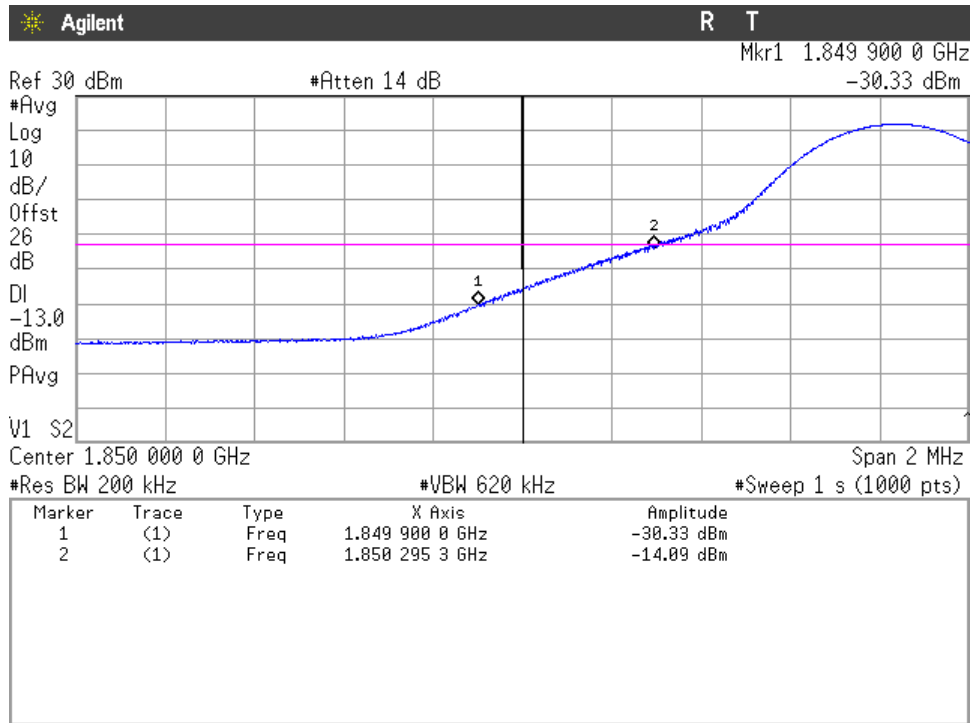

The equipment transmits at the maximum output power

LTE Band 2. QPSK MODULATION. BW=15 MHz. RB=1. Offset=Max. Highest Block Edge:

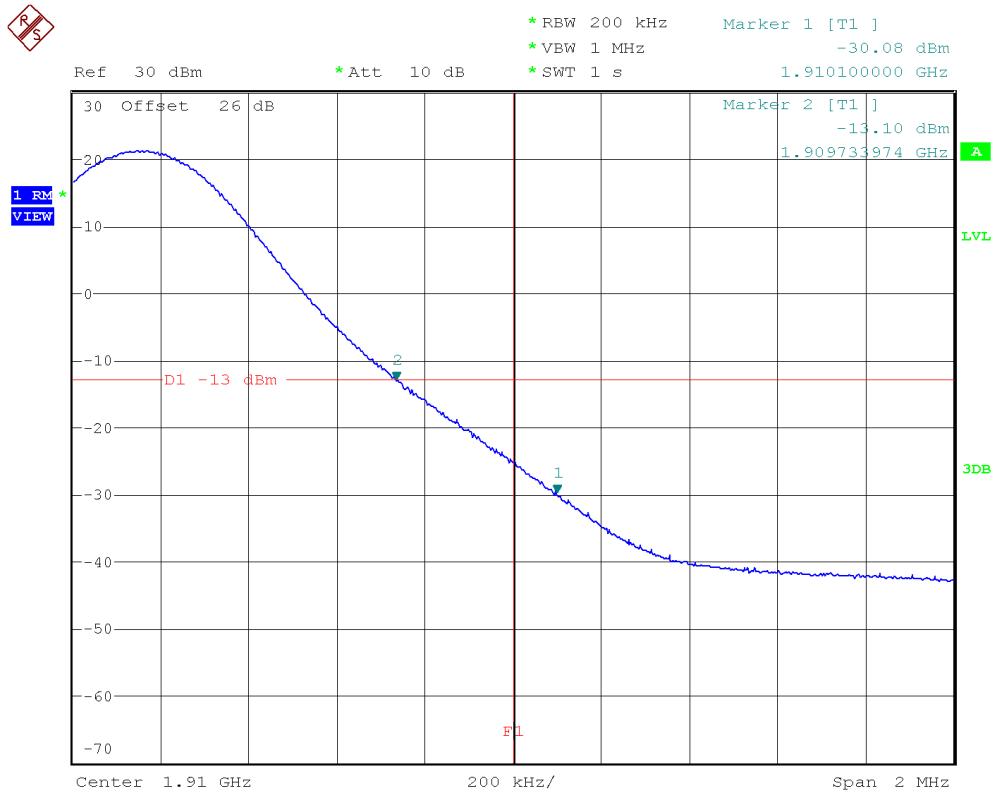

The equipment transmits at the maximum output power

LTE Band 2. QPSK MODULATION. BW=20 MHz. RB=1. Offset=0. Lowest Block Edge:

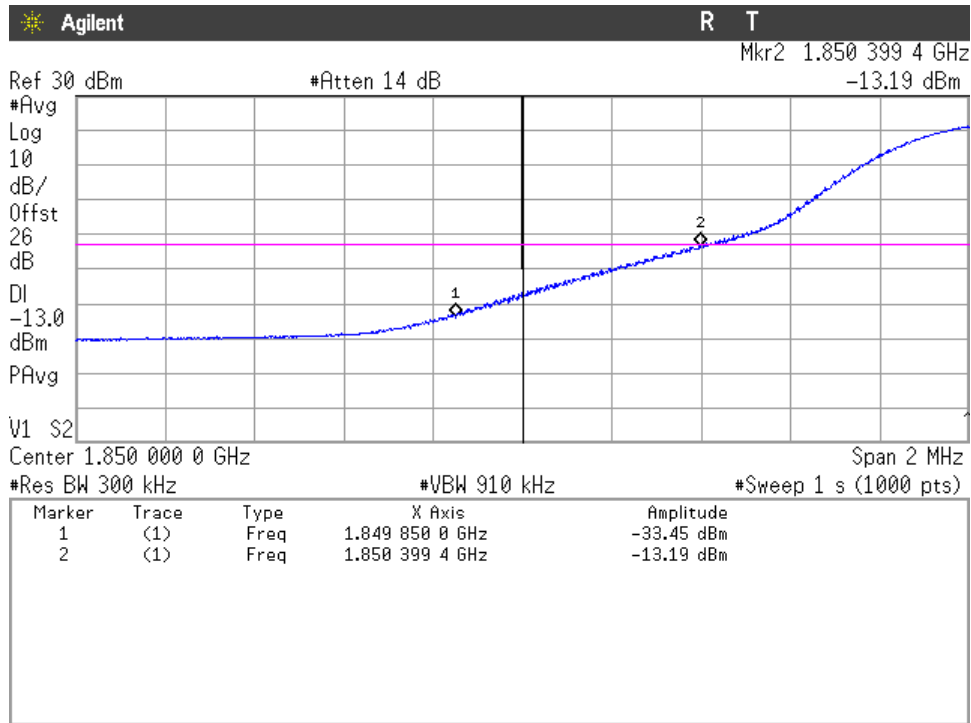

The equipment transmits at the maximum output power

LTE Band 2. QPSK MODULATION. BW=20 MHz. RB=1. Offset=Max. Highest Block Edge:

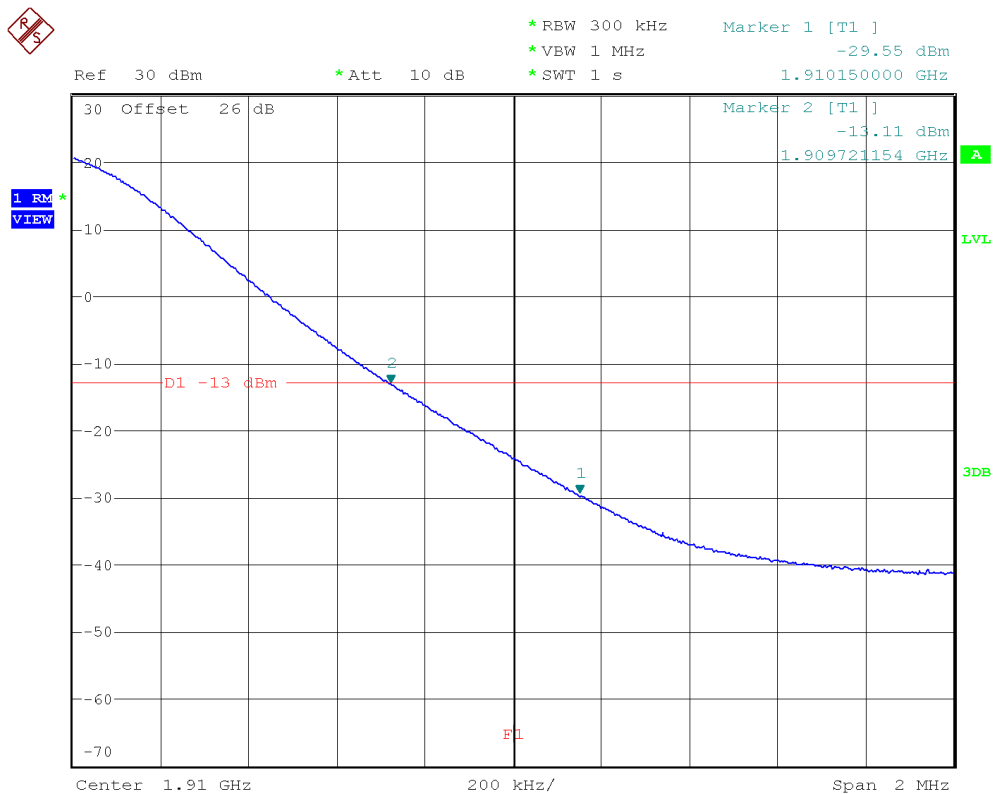

The equipment transmits at the maximum output power

LTE Band 2. QPSK MODULATION. BW=20 MHz. RB=All. Offset=0. Lowest and Highest Block Edges:

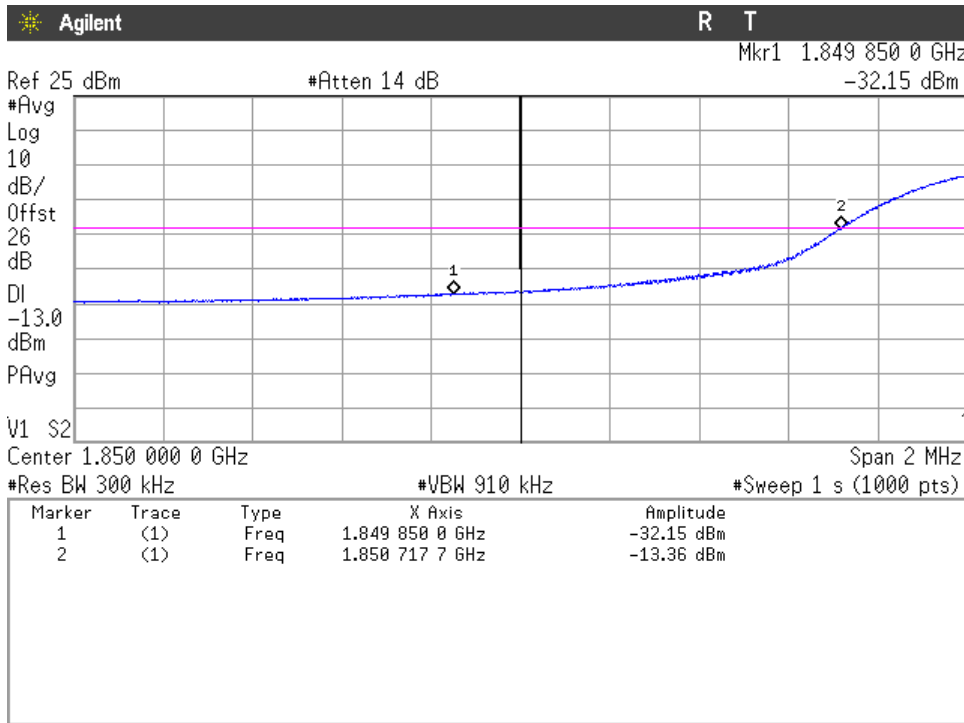

The equipment transmits at the maximum output power

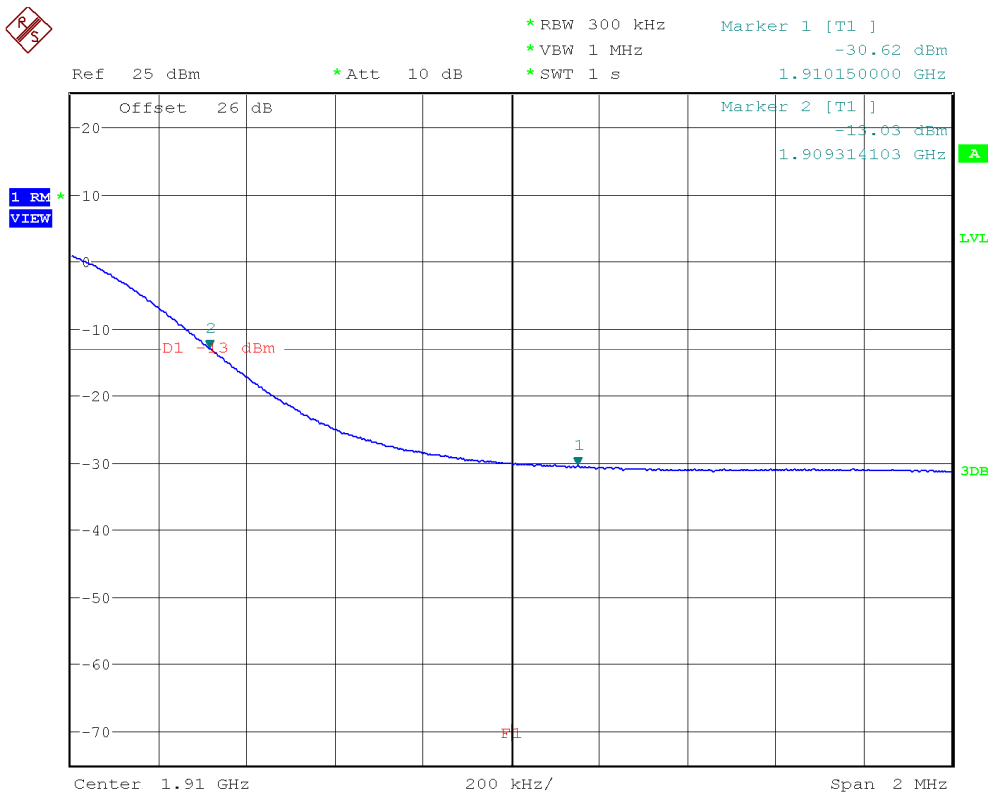

The equipment transmits at the maximum output power

Verdict: PASS

Radiated emissions

SPECIFICATION:

FCC § 24.238. RSS-133 Clause 6.5.

The power of emissions shall be attenuated below the transmitter power (P) by a factor of at least $43 + 10 \log (P)$ dB. P in watts.

METHOD:

The measurement was performed with the EUT inside an anechoic chamber.

The spectrum was scanned from 30 MHz to at least the 10th harmonic of the highest frequency generated within the equipment.

The EUT was placed on a non-conductive stand at a 3 meter distance from the measuring antenna for measurements below 1 GHz and at 1 m distance for measurements above 1 GHz.

Detected emissions were maximized at each frequency by rotating the EUT and adjusting the measuring antenna height and polarization. The maximum meter reading was recorded.

Each detected emission at less than 20 dB respect to the limit is substituted by the Substitution method in accordance with the ANSI/TIA-603-E: 2016.

Measurement Limit:

According to specification. the power of emissions shall be attenuated below the transmitter power (P) by a factor of at least $43 + 10 \log (P)$ dB. P in watts.

At P_o transmitting power. the specified minimum attenuation becomes $43+10\log (P_o)$. and the level in dBm relative P_o becomes:

$$P_o \text{ (dBm)} - [43 + 10 \log (P_o \text{ in mwatts}) - 30] = - 13 \text{ dBm}$$

TEST SETUP:

Radiated measurements below 1 GHz.

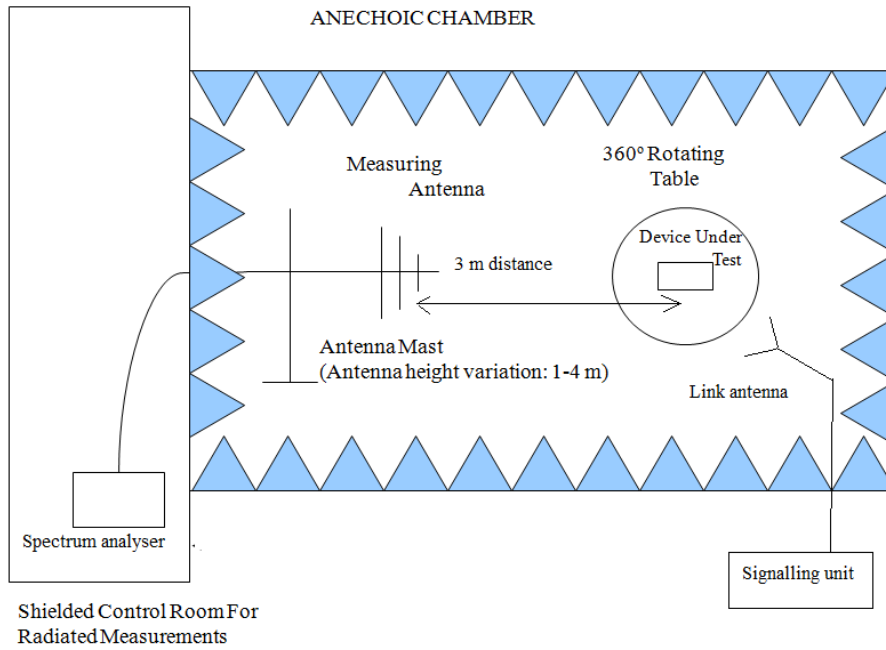

Radiated measurements above 1 GHz.

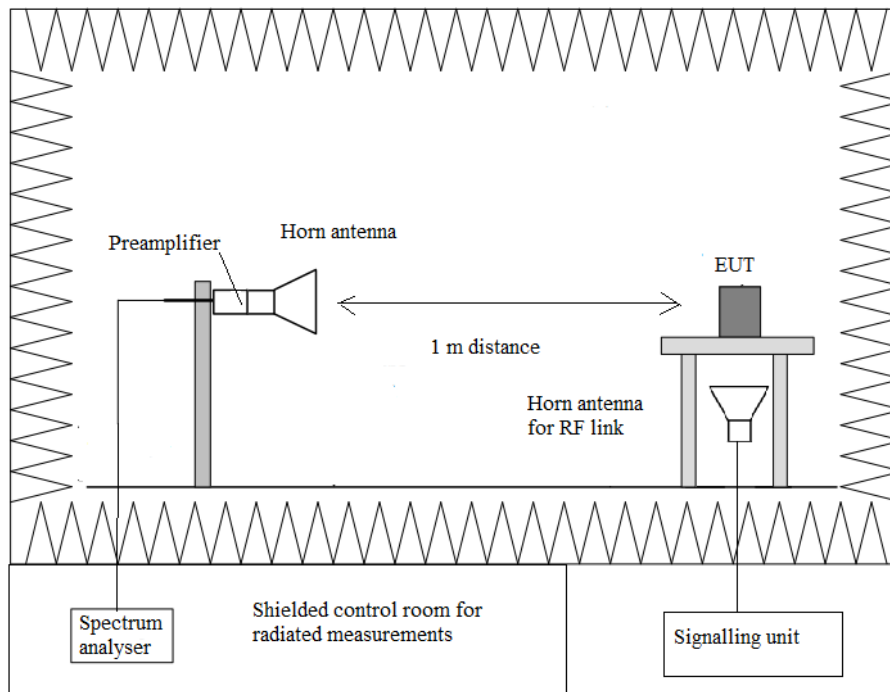

RESULTS:

3G Band II:

WCDMA AND HSUPA MODULATION:

A preliminary scan determined the WCDMA modulation as the worst case. The following tables and plots show the results for WCDMA modulation.

- Lowest Channel:

Frequency range 30 MHz - 1 GHz

No spurious frequencies detected at less than 20 dB below the limit.

Frequency range 1 - 18 GHz

No spurious frequencies detected at less than 20 dB below the limit.

Frequency range 18 - 20 GHz

No spurious frequencies detected at less than 20 dB below the limit.

- Middle Channel:

Frequency range 30 MHz - 1 GHz

No spurious frequencies detected at less than 20 dB below the limit.

Frequency range 1 - 18 GHz

No spurious frequencies detected at less than 20 dB below the limit.

Frequency range 18 - 20 GHz

No spurious frequencies detected at less than 20 dB below the limit.

- Highest Channel:

Frequency range 30 MHz - 1 GHz

No spurious frequencies detected at less than 20 dB below the limit.

Frequency range 1 - 18 GHz

No spurious frequencies detected at less than 20 dB below the limit.

Frequency range 18 - 20 GHz

No spurious frequencies detected at less than 20 dB below the limit.

Verdict: PASS

Measurement uncertainty (dB)	<±2.07 for f < 1GHz <±4.88 for f ≥ 1 GHz up to 18 GHz <±3.31 for f ≥ 18 GHz up to 20 GHz
------------------------------	--

FREQUENCY RANGE 30 MHz - 1 GHz

WCDMA MODULATION

This plot is valid for the Lowest, Middle and Highest Channels:

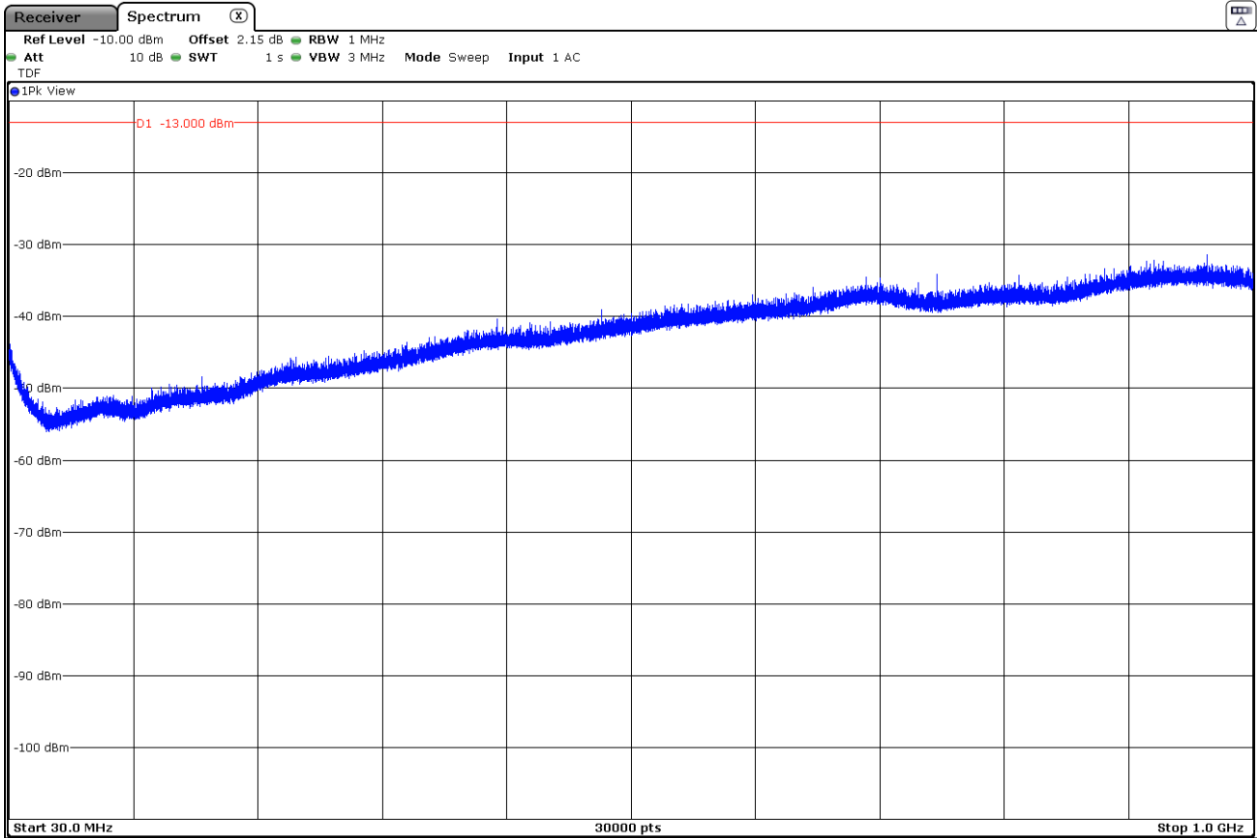

FREQUENCY RANGE 1 - 3 GHz

WCDMA MODULATION

- Lowest Channel:

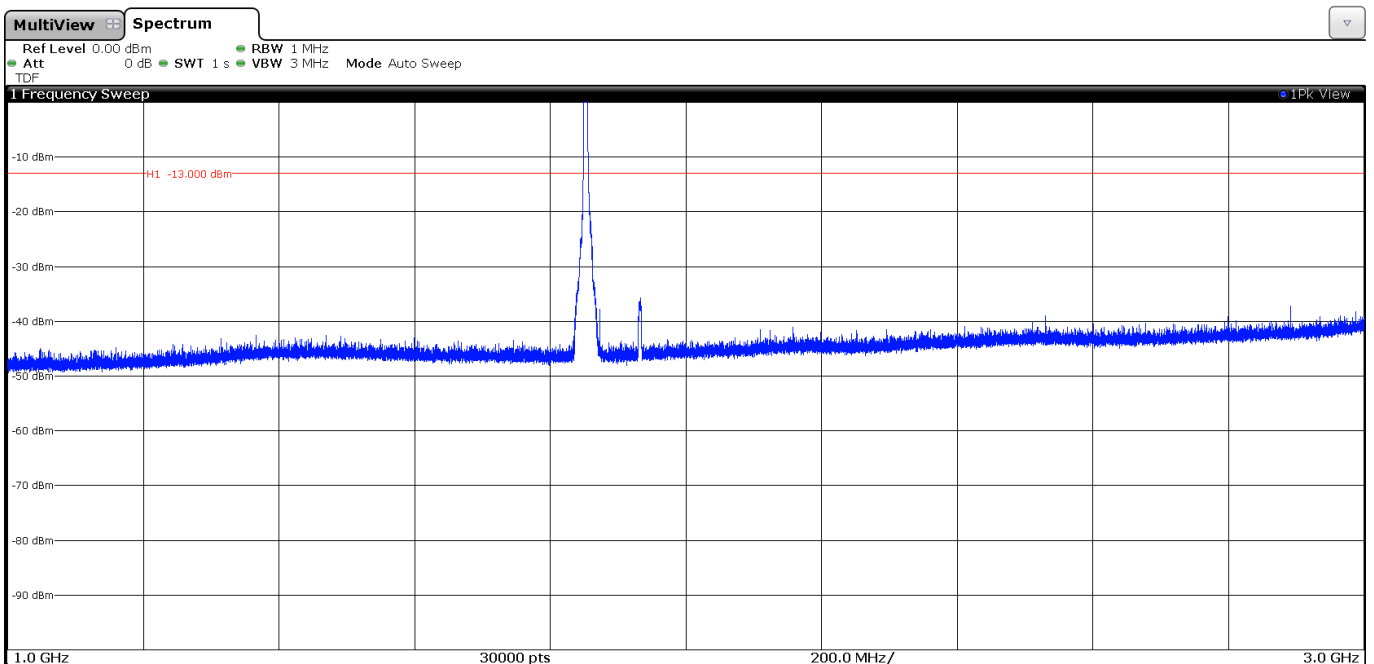

The peak above the limit is the carrier frequency.

- Middle Channel:

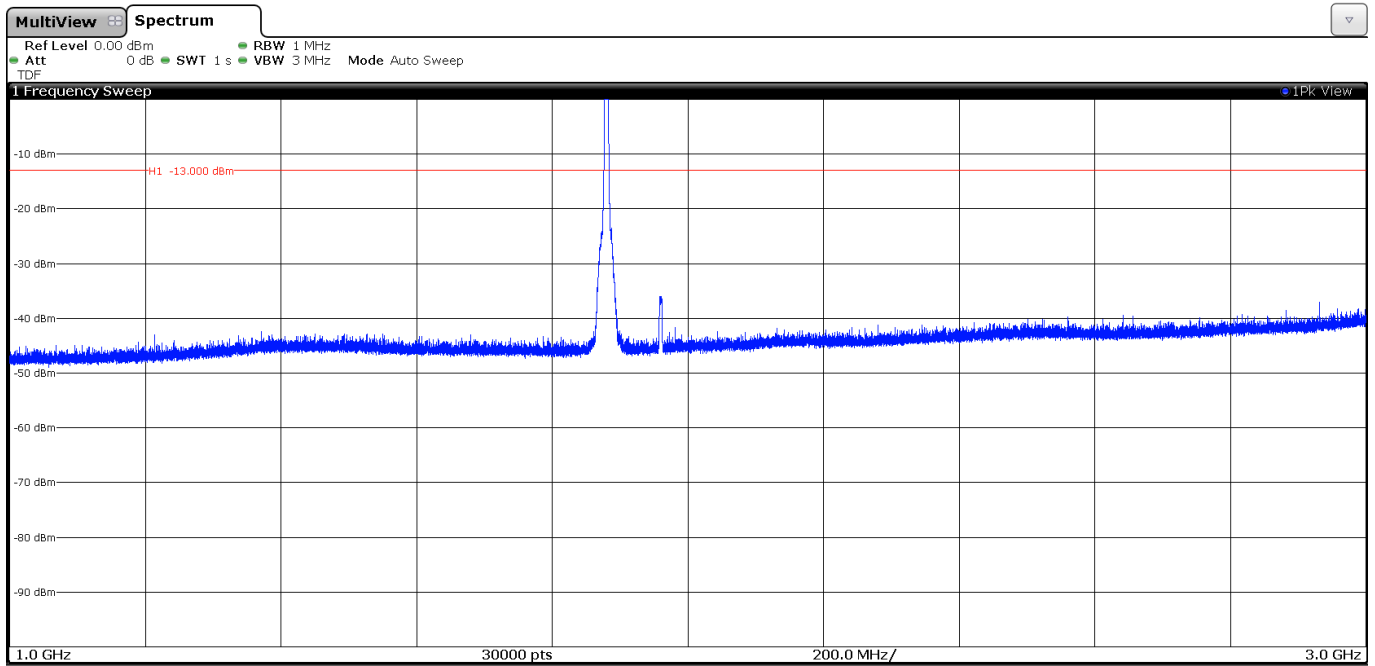

The peak above the limit is the carrier frequency.

- Highest Channel:

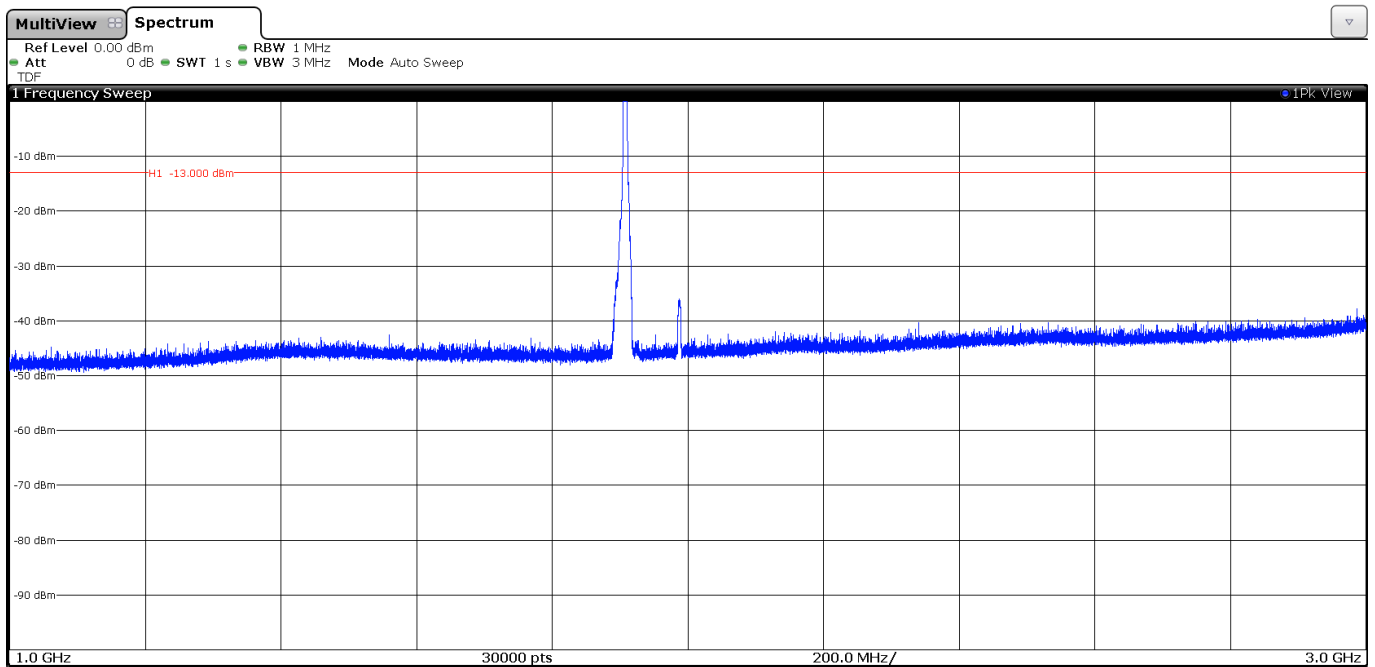

The peak above the limit is the carrier frequency.

FREQUENCY RANGE 3 - 18 GHz

WCDMA MODULATION

This plot is valid for the Lowest, Middle and Highest Channels:

- Lowest Channel:

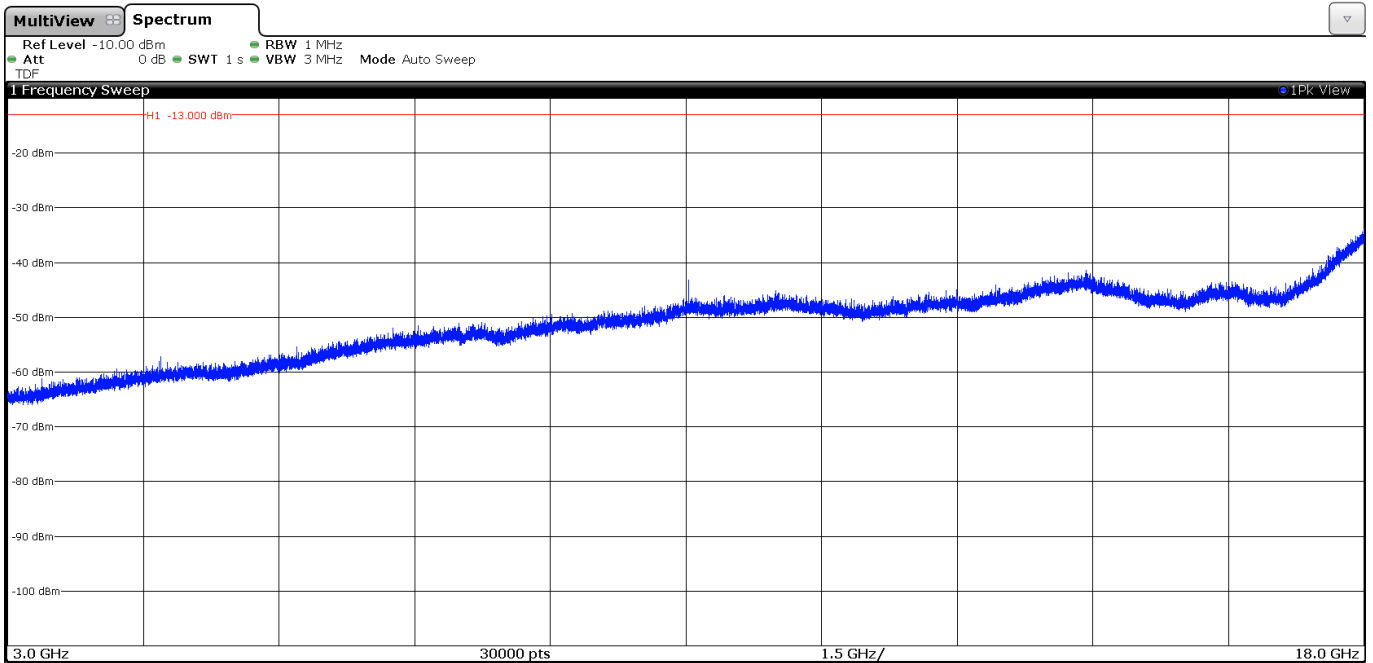

- Middle Channel:

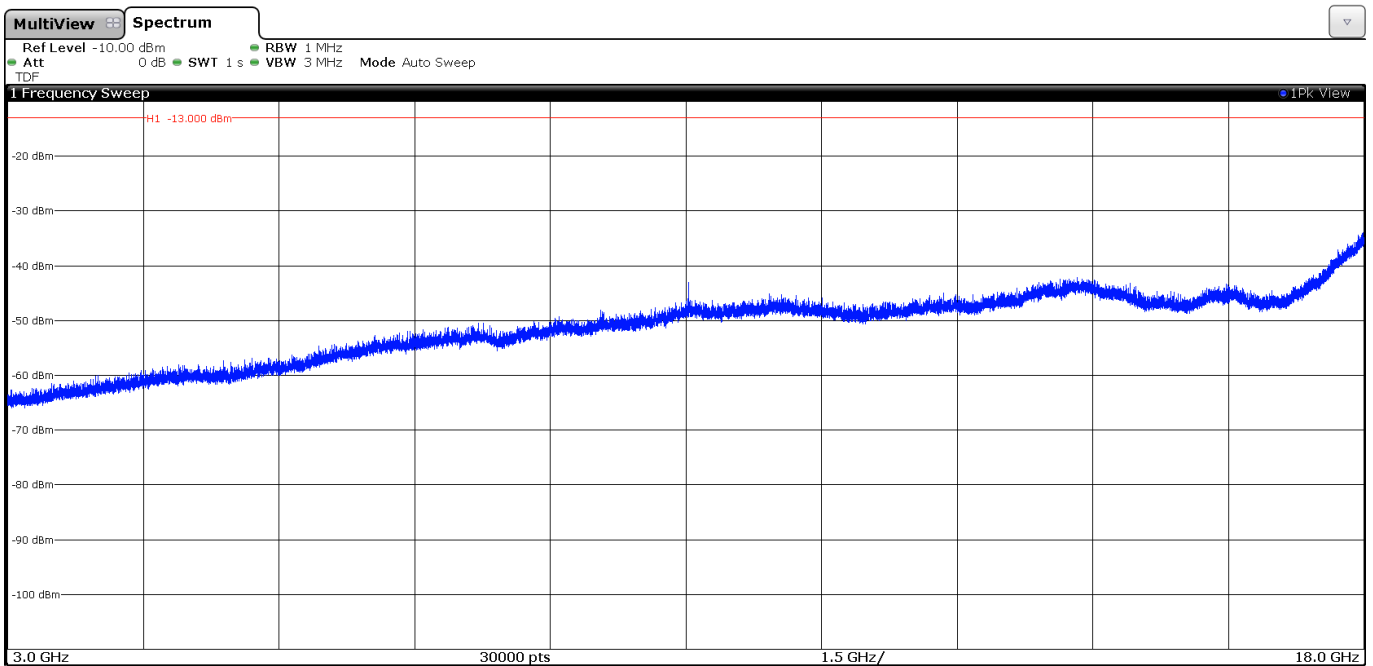

- Highest Channel:

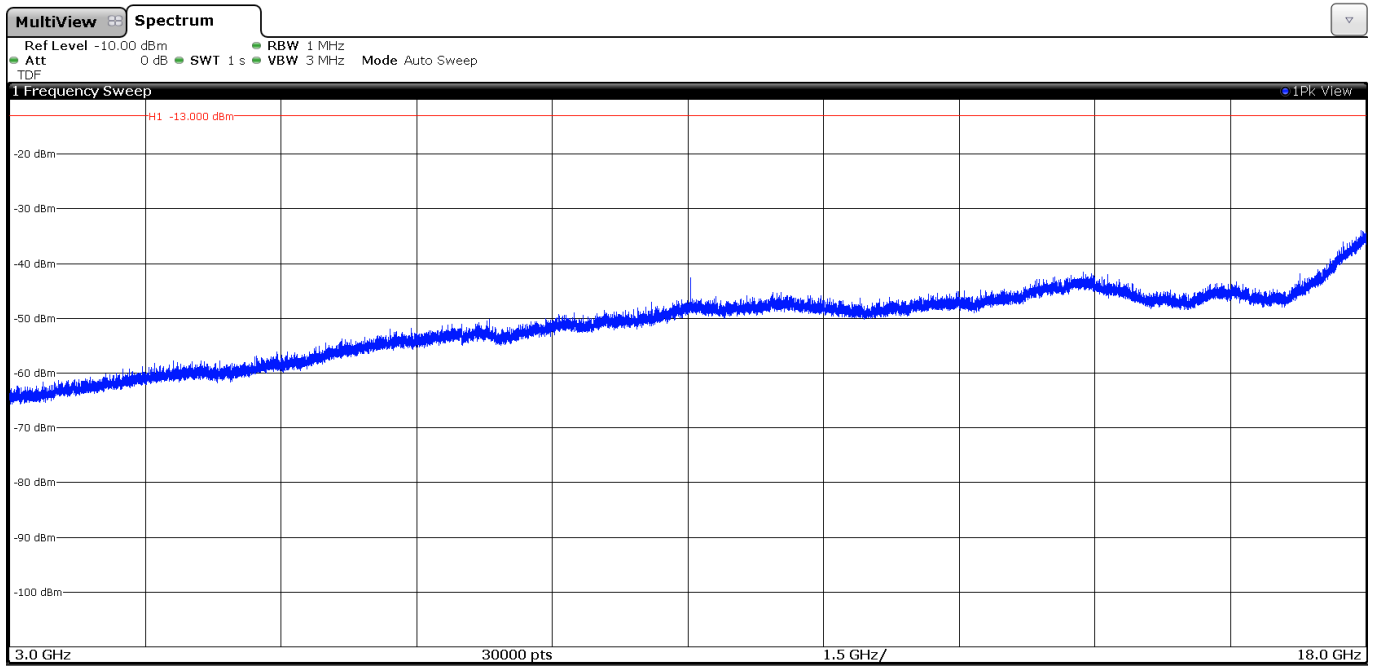

FREQUENCY RANGE 18 - 20 GHz

WCDMA MODULATION

This plot is valid for the Lowest, Middle and Highest Channels:

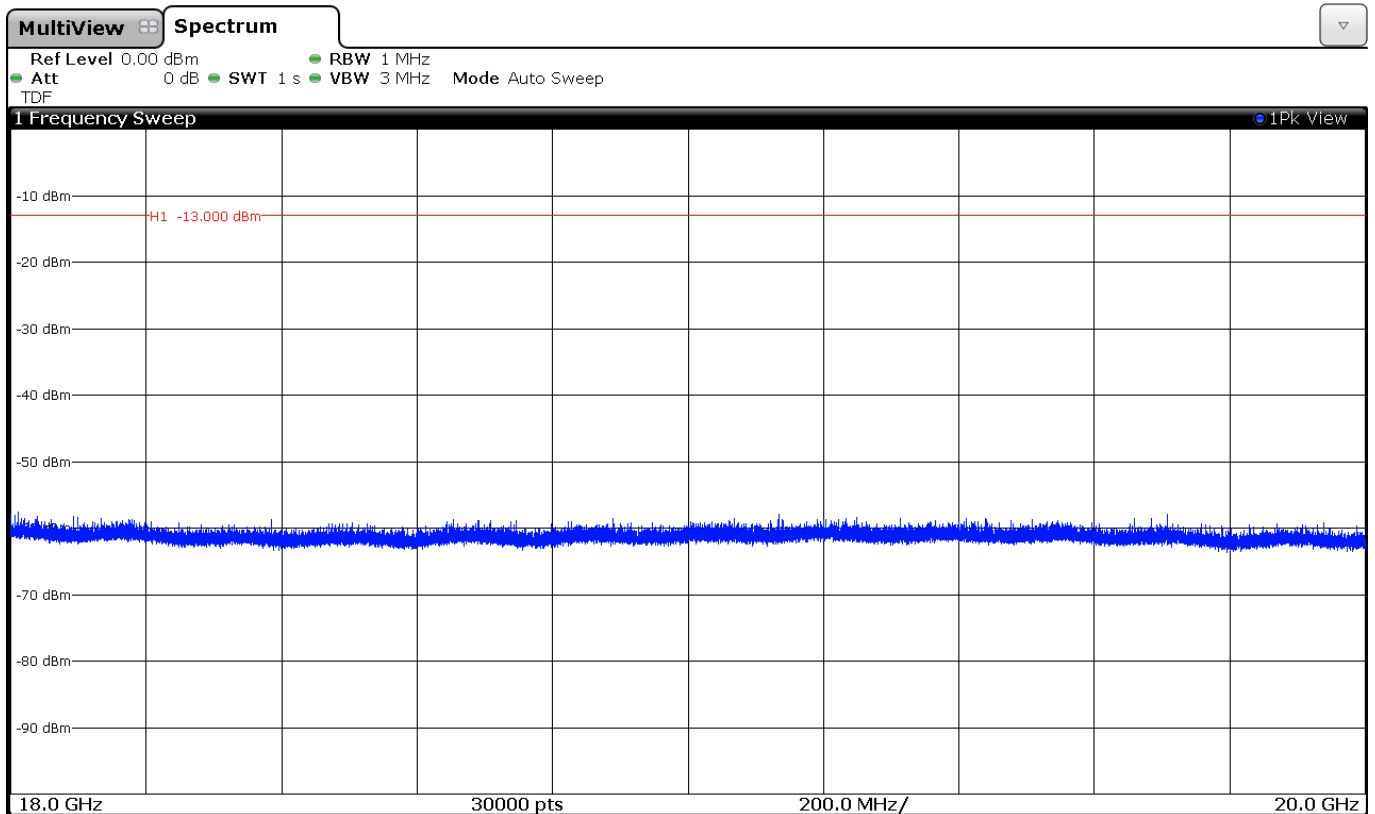

LTE Band 2:

QPSK and 16QAM Modulations:

A preliminary scan determined the QPSK modulation, BW=15 MHz, RB=1, Offset=37 as the worst case.

- Lowest Channel:

Frequency range 30 MHz - 1 GHz

No spurious frequencies detected at less than 20 dB below the limit.

Frequency range 1 - 18 GHz

No spurious frequencies detected at less than 20 dB below the limit.

Frequency range 18 - 20 GHz

No spurious frequencies detected at less than 20 dB below the limit.

- Middle Channel:

Frequency range 30 MHz - 1 GHz

No spurious frequencies detected at less than 20 dB below the limit.

Frequency range 1 GHz-18 GHz

No spurious frequencies detected at less than 20 dB below the limit.

Frequency range 18 - 20 GHz

No spurious frequencies detected at less than 20 dB below the limit.

- Highest Channel:

Frequency range 30 MHz - 1 GHz

No spurious frequencies detected at less than 20 dB below the limit.

Frequency range 1 GHz-18 GHz.

No spurious frequencies detected at less than 20 dB below the limit.

Frequency range 18 - 20 GHz

No spurious frequencies detected at less than 20 dB below the limit.

Measurement uncertainty (dB)	<±2.07 for f < 1GHz <±4.88 for f ≥ 1 GHz up to 18 GHz <±3.31 for f ≥ 18 GHz up to 20 GHz
------------------------------	--

Verdict: PASS

FREQUENCY RANGE 30 MHz - 1 GHz

QPSK MODULATION

This plot is valid for the Lowest, Middle and Highest Channels:

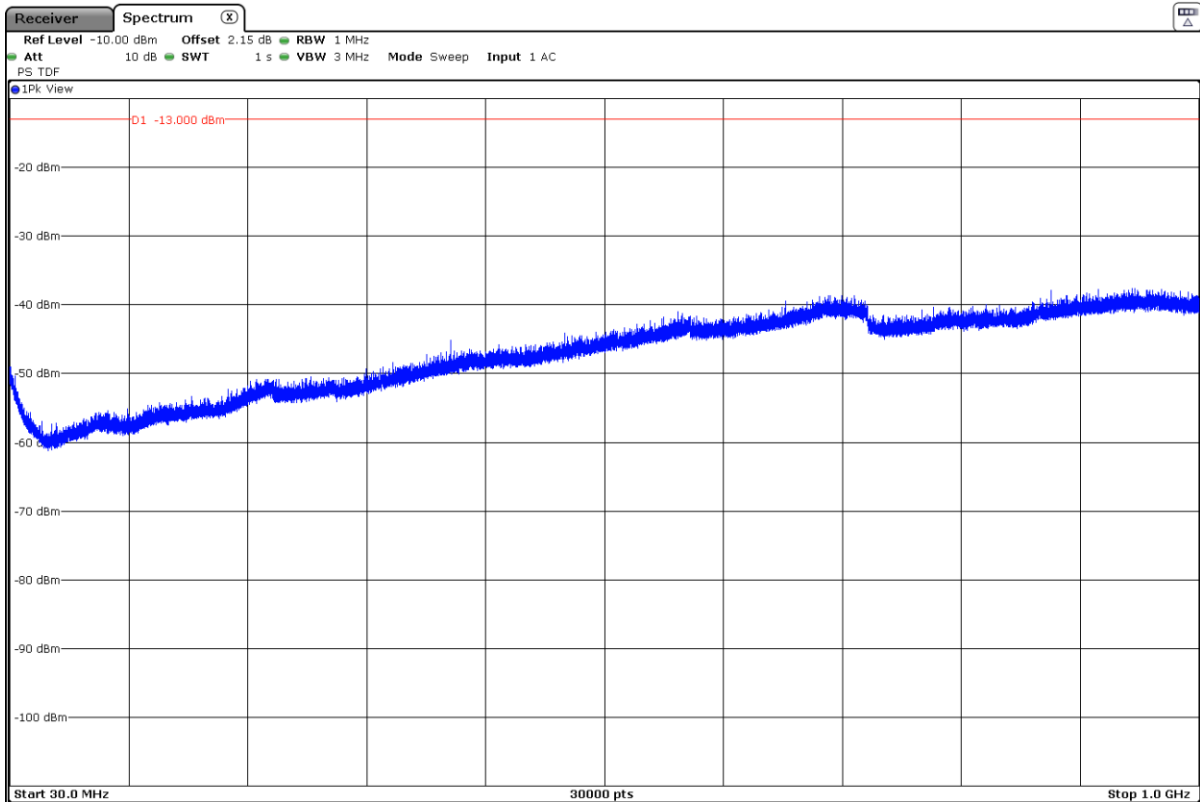

FREQUENCY RANGE 1 - 3 GHz

QPSK MODULATION

- Lowest Channel:

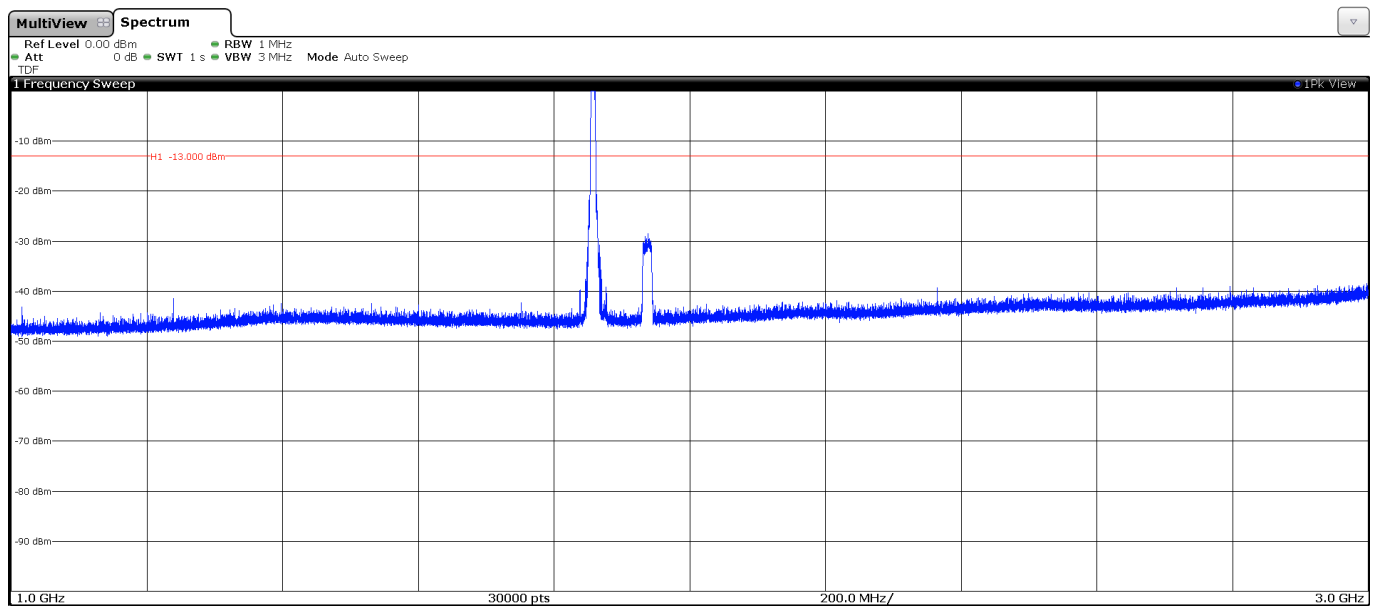

The peak above the limit is the carrier frequency. The peak at 1930 MHz corresponds to the downlink signal.

- Middle Channel:

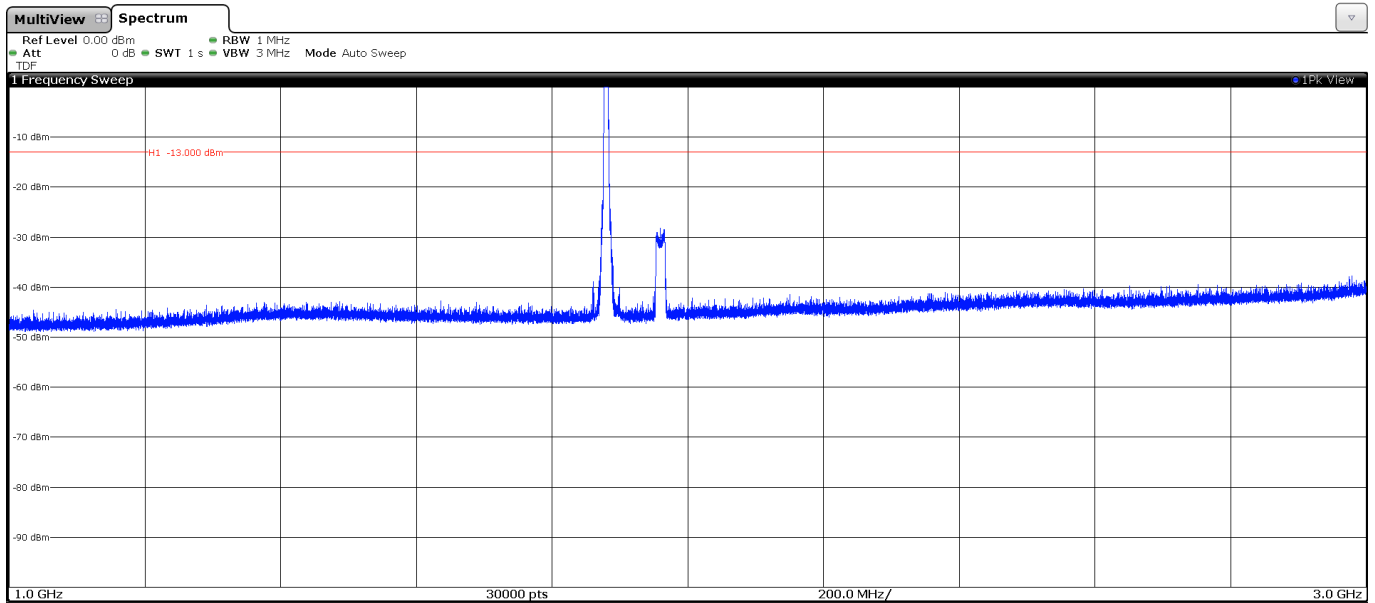

The peak above the limit is the carrier frequency. The peak at 1960 MHz corresponds to the downlink signal.

- Highest Channel:

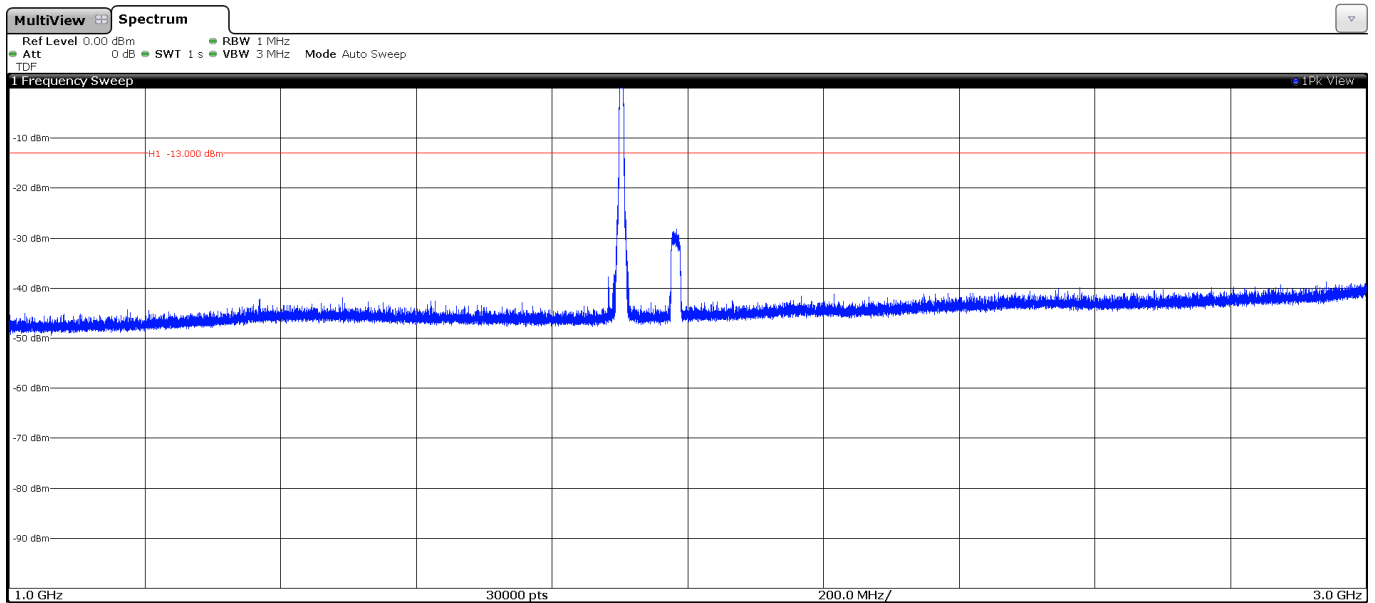

The peak above the limit is the carrier frequency. The peak at 1990 MHz corresponds to the downlink signal.

FREQUENCY RANGE 3 - 18 GHz

QPSK MODULATION

- Lowest Channel:

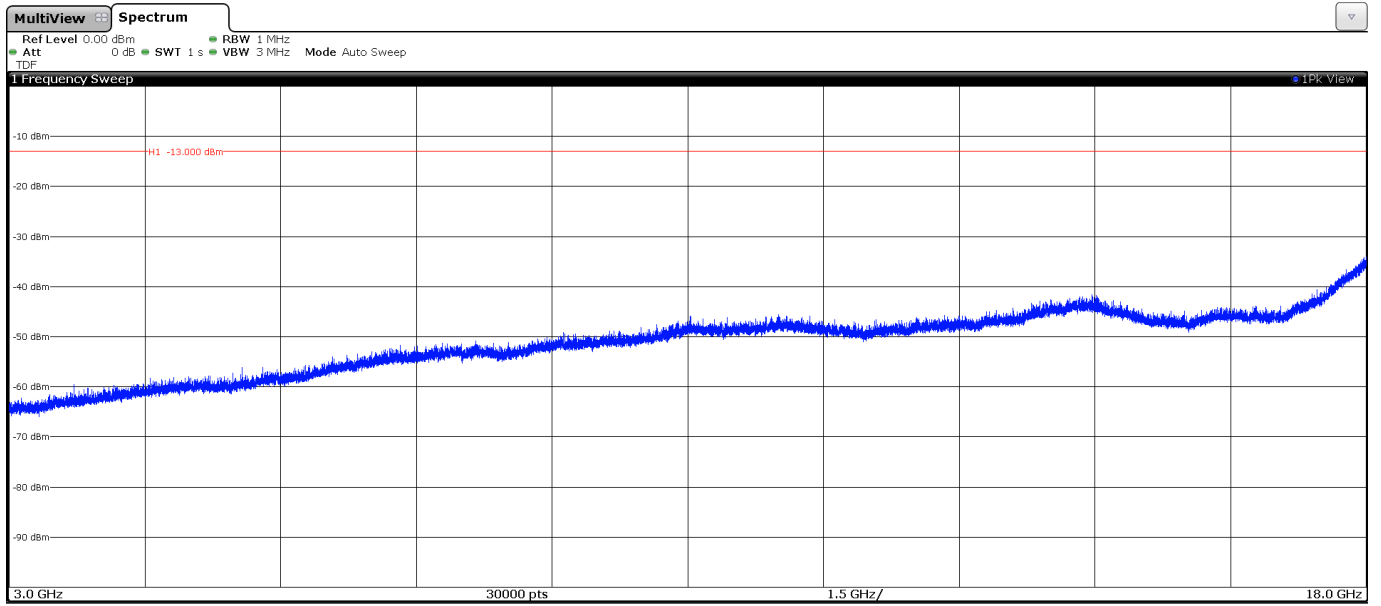

- Middle Channel:

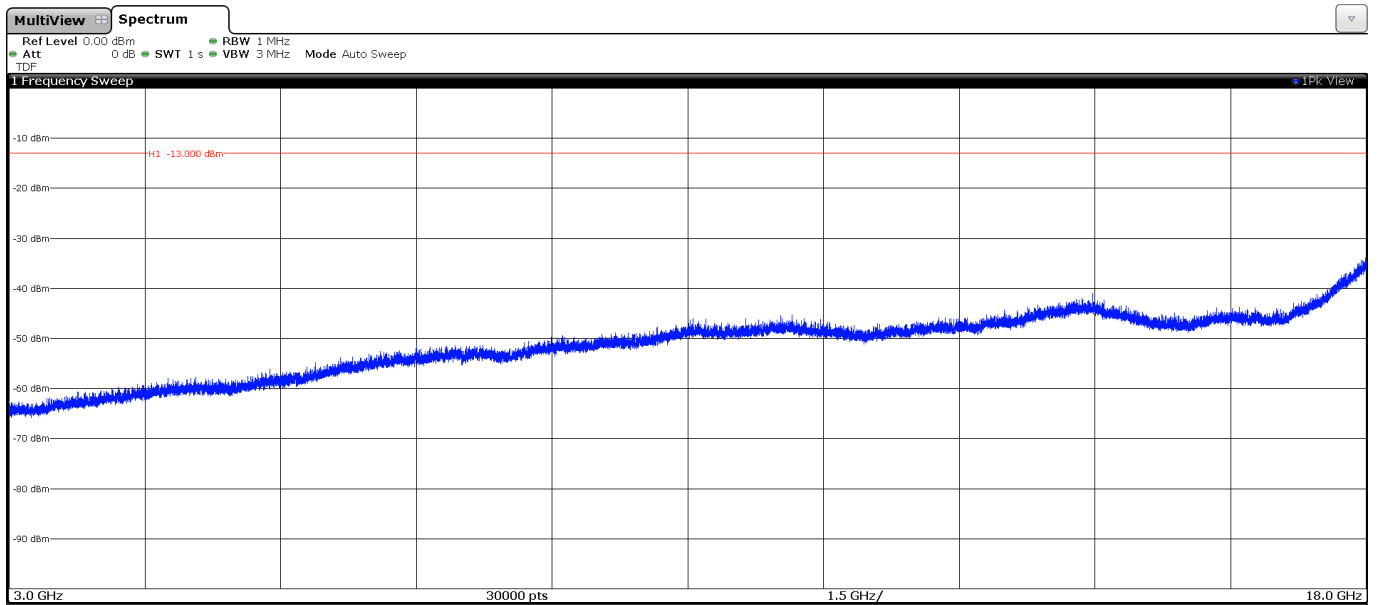

- Highest Channel:

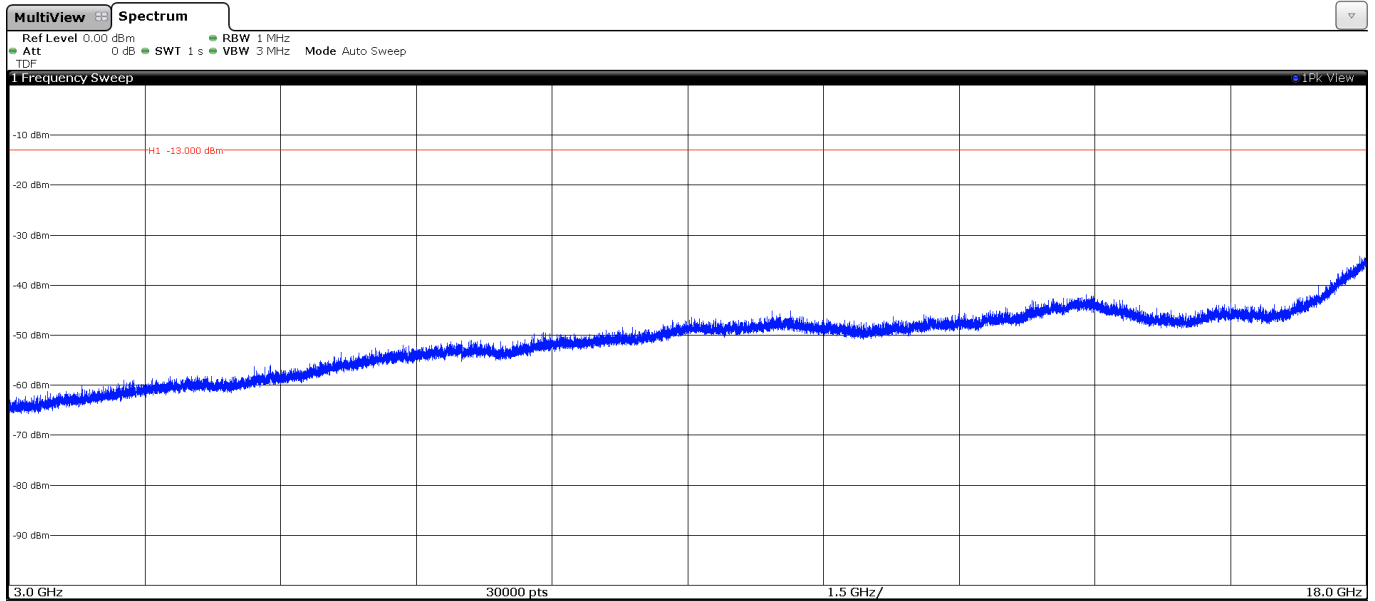

FREQUENCY RANGE 18 - 20 GHz

QPSK MODULATION

This plot is valid for the Lowest, Middle and Highest Channels:

