

FCC &ISED Radio Test Report

FCC ID: 2AD9EMM50
IC: 25930-SKU99911

The report concerns: Original Grant

Report Reference No.....: 21EFSS12009 10591
Date Sample(s) Received.....: 2021-12-10
Date of Tested.....: From 2021-12-10 to 2021-12-23
Date of issue.....: 2021-12-23
Testing Laboratory: DongGuan ShuoXin Electronic Technology Co., Ltd.
Address: Zone A, 1F, No. 6, XinGang Road YuanGang Street,
XinAn District, ChangAn Town, DongGuan City,
GuangDong, China

Applicant's name: JL Audio INC
Address: 10369 N Commerce Parkway Miramar, FL 33025
USA
Manufacturer.....: JL Audio INC

Equipment.....: Marine Audio Controller

Trade Mark: 

Model: MM50
Ratings: I/P: DC 12V
Audio output: Rated RMS power @14.4V, 25W*4 Ω

Test Engineer: 
Blue Qiu

Responsible Engineer : 
Smile Wang

Authorized Signatory: 
King Wang

| Table of Contents | Page |
|--|-------------|
| 1 . TEST REPORT DECLARE | 5 |
| 2 . SUMMARY OF TEST RESULTS | 6 |
| 2.1 MEASUREMENT UNCERTAINTY | 7 |
| 3 . GENERAL INFORMATION | 8 |
| 3.1 GENERAL DESCRIPTION OF EUT | 8 |
| 3.2 DESCRIPTION OF TEST MODES | 10 |
| 3.3 PARAMETERS OF TEST SOFTWARE | 11 |
| 3.4 BLOCK DIAGRAM SHOWING THE CONFIGURATION OF SYSTEM TESTED | 11 |
| 3.5 SUPPORT UNITS | 11 |
| 3.6 TEST ENVIRONMENT CONDITIONS | 12 |
| 4 . AC POWER LINE CONDUCTED EMISSIONS TEST | 13 |
| 4.1 LIMIT | 13 |
| 4.2 TEST PROCEDURE | 13 |
| 4.3 MEASUREMENT INSTRUMENTS LIST | 13 |
| 4.4 TESTSETUP | 14 |
| 4.5 EUT OPERATING CONDITIONS | 14 |
| 4.6 TEST RESULTS | 15 |
| 5 . RADIATED EMISSION TEST | 17 |
| 5.1 LIMIT | 17 |
| 5.2 TEST PROCEDURE AND SETTING | 18 |
| 5.3 MEASUREMENT INSTRUMENTS LIST | 19 |
| 5.4 TESTSETUP | 19 |
| 5.5 EUT OPERATING CONDITIONS | 20 |
| 5.6 TEST RESULTS - 9 KHZ TO 30MHZ | 21 |
| 5.7 TEST RESULTS- 30 MHZ TO 1000MHZ | 22 |
| 5.8 TEST RESULTS - ABOVE 1000MHZ(BAND EDGE) | 24 |
| 5.9 TEST RESULTS - ABOVE 1000MHZ(HARMONIC) | 32 |
| 6 . NUMBER OF HOPPING FREQUENCY | 44 |
| 6.1 LIMIT | 44 |
| 6.2 TEST PROCEDURE AND SETTING | 44 |
| 6.3 MEASUREMENT INSTRUMENTS LIST | 44 |
| 6.4 TEST SETUP | 44 |

| Table of Contents | Page |
|---|-------------|
| 6.5 EUT OPERATION CONDITIONS | 44 |
| 6.6 TEST RESULTS | 45 |
| 7 . AVERAGE TIME OF OCCUPANCY | 46 |
| 7.1 LIMIT | 46 |
| 7.2 TEST PROCEDURE AND SETTING | 46 |
| 7.3 MEASUREMENT INSTRUMENTS LIST | 46 |
| 7.4 TEST SETUP | 46 |
| 7.5 EUT OPERATION CONDITIONS | 46 |
| 7.6 TEST RESULTS | 47 |
| 8 . HOPPING CHANNEL SEPARATION MEASUREMENT | 49 |
| 8.1 LIMIT | 49 |
| 8.2 TEST PROCEDURE AND SETTING | 49 |
| 8.3 MEASUREMENT INSTRUMENTS LIST | 49 |
| 8.4 TEST SETUP | 49 |
| 8.5 EUT OPERATION CONDITIONS | 49 |
| 8.6 TEST RESULTS | 50 |
| 9 . BANDWIDTH TEST | 52 |
| 9.1 LIMIT | 52 |
| 9.2 TEST PROCEDURE AND SETTING | 52 |
| 9.3 MEASUREMENT INSTRUMENTS LIST | 52 |
| 9.4 TEST SETUP | 52 |
| 9.5 EUT OPERATION CONDITIONS | 52 |
| 9.6 TEST RESULTS | 53 |
| 10 . MAXIMUM OUTPUT POWER | 55 |
| 10.1 LIMIT | 55 |
| 10.2 TEST PROCEDURE AND SETTING | 55 |
| 10.3 MEASUREMENT INSTRUMENTS LIST | 55 |
| 10.4 TEST SETUP | 55 |
| 10.5 EUT OPERATION CONDITIONS | 55 |
| 10.6 TEST RESULTS | 56 |
| 11 . CONDUCTED SPURIOUS EMISSION | 59 |
| 11.1 LIMIT | 59 |
| 11.2 TEST PROCEDURE AND SETTING | 59 |
| 11.3 MEASUREMENT INSTRUMENTS LIST | 59 |

| Table of Contents | Page |
|---|-------------|
| 11.4 TEST SETUP | 59 |
| 11.5 EUT OPERATION CONDITIONS | 59 |
| 11.6 TEST RESULTS | 60 |
| 12 . FREQUENCY STABILITY MEASUREMENT | 62 |
| 12.1 LIMIT | 62 |
| 12.2 TEST PROCEDURE | 62 |
| 12.3 MEASUREMENT INSTRUMENTS LIST | 62 |
| 12.4 TEST SETUP | 62 |
| 12.5 EUT OPERATION CONDITIONS | 62 |
| 12.6 TEST RESULTS | 63 |

1TEST REPORT DECLARE

| | |
|--------------|--|
| Applicant | JL Audio INC |
| Address | 10369 N Commerce Parkway Miramar, FL 33025 USA |
| Manufacturer | JL Audio INC |
| Address | 10369 N Commerce Parkway Miramar, FL 33025 USA |
| Factory | EVERVICTORY ELECTRONIC COMPANY LIMITED |
| Address | Chu Chi Management District, Hu Men Town, Dong-Guan City, Guang-Dong Province, P.R.China |
| Equipment | Marine Audio Controller |
| Model No. | MM50 |
| Trade Mark |  |
| Standard | FCC Part15, Subpart C (15.247) RSS-247 Issue 2, Feb. 2017 RSS-Gen Issue 5, Apr. 2018 ANSI C63.10-2013 |

We Declare:

The equipment described above is tested by DongGuan ShuoXin Electronic Technology Co., Ltd(ATT). and in the configuration tested the equipment complied with the standards specified above. The test results are contained in this test report and DongGuan ShuoXin Electronic Technology Co., Ltd.(ATT) is assumed of full responsibility for the accuracy and completeness of these tests.

ATT is not responsible for the sampling stage, so the results only apply to the sample as received.

ATT's reports apply only to the specific samples tested under conditions. It is manufacture's responsibility to ensure that additional production units of this model are manufactured with the identical electrical and mechanical components. ATT shall have no liability for any declarations, inferences or generalizations drawn by the client or others from ATT issued reports.

2SUMMARY OF TEST RESULTS

The EUT have been tested according to the applicable standards as referenced below:

| Standard(s) Section | | Test Item | Judgment | Remark |
|-------------------------------------|--|-----------------------------------|----------|---------|
| FCC | ISED | | | |
| 15.207 | RSS-Gen8.8 | AC Power Line Conducted Emissions | PASS | ----- |
| 15.247(d) 15.205(a) 15.209(a) | RSS-247 5.5 RSS-Gen 8.9 RSS-Gen 8.10 | Radiated Emission | PASS | ----- |
| 15.247(a)(1)(iii) | RSS-247 5.1 (d) | Number of Hopping Frequency | PASS | ----- |
| 15.247(a)(1)(iii) | RSS-247 5.1 (d) | Average Time Of Occupancy | PASS | ----- |
| 15.247(a)(1) | RSS-247 5.1 (b) | Hopping Channel Separation | PASS | ----- |
| 15.247(a)(1) | RSS-247 5.1 (a) RSS-Gen 6.7 | Bandwidth | PASS | ----- |
| 15.247(a)(1) | RSS-247 5.1 (b) | Maximum Output Power | PASS | ----- |
| 15.247(d) | RSS-247 5.5 | Conducted Spurious Emission | PASS | ----- |
| - | RSS-Gen6.11 | Frequency Stability | PASS | ----- |
| 15.203 | - | Antenna Requirement | PASS | Note(2) |

Note:

- (1) "N/A" denotes test is not applicable in this test report
- (2) The device what use a permanently attached antenna were considered sufficient to comply with the provisions of 15.203.

2.1 MEASUREMENT UNCERTAINTY

| Test Item | Uncertainty |
|---|-----------------------|
| Uncertainty for Conduction emission test (9kHz-150kHz) | 3.7 dB |
| Uncertainty for Conduction emission test (150kHz-30MHz) | 3.3 dB |
| Uncertainty for Radiation Emission test (30MHz-200MHz) | 4.60 dB (Polarize: V) |
| | 4.60 dB (Polarize: H) |
| Uncertainty for Radiation Emission test (200MHz-1GHz) | 6.10 dB (Polarize: V) |
| | 5.08 dB (Polarize: H) |
| Uncertainty for Radiation Emission test (1GHz-6GHz) | 5.01 dB (Polarize: V) |
| | 5.01 dB (Polarize: H) |
| Uncertainty for Radiation Emission test (6GHz-18GHz) | 5.26 dB (Polarize: V) |
| | 5.26 dB (Polarize: H) |
| Uncertainty for Radiation Emission test (18GHz-40GHz) | 5.06 dB (Polarize: V) |
| | 5.06 dB (Polarize: H) |
| Uncertainty for radio frequency | ±0.048kHz |
| Uncertainty for conducted RF Power | ±0.32dB |

Note:

This uncertainty represents an expanded uncertainty expressed at approximately the 95% confidence level using a coverage factor of k=2.

Test Facility:

The Test site used by DongGuan ShuoXin Electronic Technology Co., Ltd. to collect test data is located on the Zone A, 1F, No. 6, XinGang Road YuanGang Street, XinAn District, ChangAn Town, DongGuan City, GuangDong, China

The test facility is recognized, certified, or accredited by the following organizations:

| Item | Registration No. | Expiration Date |
|--|----------------------------------|-----------------|
| CNAS | L3098 | 2024-08-27 |
| A2LA | 4893.01 | 2022-06-30 |
| Innovation, Science and Economic Development Canada (ISED) | 11033A CAB identifier:CN0083 | 2022-06-30 |
| Federal Communications Commission (FCC) | 171688 Designation No.:CN1235 | 2022-06-30 |

3 GENERAL INFORMATION

3.1 GENERAL DESCRIPTION OF EUT

| | | |
|-------------------------|---|--------------------------|
| Equipment | Marine Audio Controller | |
| Brand Name |  | |
| Test Model | MM50 | |
| Series Model | N/A | |
| Model Difference(s) | N/A | |
| Hardware Version | 0372 | |
| Software Version | 20210817102811 | |
| Power Source | Supplied from storage battery. | |
| Power Rating | DC 12V | |
| Operation Frequency | 2402 MHz ~ 2480 MHz | |
| Modulation Technology | GFSK, $\pi/4$ -DQPSK, 8-DPSK | |
| Bit Rate of Transmitter | 1Mbps /2Mbps /3Mbps | |
| Antenna Information | Antenna Type: Dipole antenna | Maximum Peak Gain:2.0dBi |
| Max. Output Power | 1Mbps: 8.096dBm (0.006450W) 2Mbps: 9.056dBm (0.008046W) 3Mbps: 9.516dBm (0.008945W) | |

Note:

1. For a more detailed features description, please refer to the manufacturer’s specifications or the user’s manual.

2. Channel List:

| Channel | Frequency (MHz) | Channel | Frequency (MHz) | Channel | Frequency (MHz) |
|---------|-----------------|---------|-----------------|---------|-----------------|
| 00 | 2402 | 27 | 2429 | 54 | 2456 |
| 01 | 2403 | 28 | 2430 | 55 | 2457 |
| 02 | 2404 | 29 | 2431 | 56 | 2458 |
| 03 | 2405 | 30 | 2432 | 57 | 2459 |
| 04 | 2406 | 31 | 2433 | 58 | 2460 |
| 05 | 2407 | 32 | 2434 | 59 | 2461 |
| 06 | 2408 | 33 | 2435 | 60 | 2462 |
| 07 | 2409 | 34 | 2436 | 61 | 2463 |
| 08 | 2410 | 35 | 2437 | 62 | 2464 |
| 09 | 2411 | 36 | 2438 | 63 | 2465 |
| 10 | 2412 | 37 | 2439 | 64 | 2466 |
| 11 | 2413 | 38 | 2440 | 65 | 2467 |
| 12 | 2414 | 39 | 2441 | 66 | 2468 |
| 13 | 2415 | 40 | 2442 | 67 | 2469 |
| 14 | 2416 | 41 | 2443 | 68 | 2470 |
| 15 | 2417 | 42 | 2444 | 69 | 2471 |
| 16 | 2418 | 43 | 2445 | 70 | 2472 |
| 17 | 2419 | 44 | 2446 | 71 | 2473 |
| 18 | 2420 | 45 | 2447 | 72 | 2474 |
| 19 | 2421 | 46 | 2448 | 73 | 2475 |
| 20 | 2422 | 47 | 2449 | 74 | 2476 |
| 21 | 2423 | 48 | 2450 | 75 | 2477 |
| 22 | 2424 | 49 | 2451 | 76 | 2478 |
| 23 | 2425 | 50 | 2452 | 77 | 2479 |
| 24 | 2426 | 51 | 2453 | 78 | 2480 |
| 25 | 2427 | 52 | 2454 | | |
| 26 | 2428 | 53 | 2455 | | |

3.2 DESCRIPTION OF TEST MODES

The test system was pre-tested based on the consideration of all possible combinations of EUT operation mode.

| Prefest Mode | Description |
|--------------|---------------------------|
| Mode 1 | TX Mode NOTE (1) |
| Mode 2 | TX Mode Channel 78 _3Mbps |

Following mode(s) was (were) found to be the worst case(s) and selected for the final test.

| AC power line conducted emissions test | |
|---|---------------------------|
| Final Test Mode | Description |
| Mode 2 | TX Mode Channel 78 _3Mbps |

| Radiated emissions test - Below 1GHz | |
|---|---------------------------|
| Final Test Mode | Description |
| Mode 2 | TX Mode Channel 78 _3Mbps |

| Radiated emissions test - Above 1GHz | |
|---|-------------------------|
| Final Test Mode | Description |
| Mode 1 | TX Mode NOTE (1) |

| Conducted test | |
|-----------------------|-------------------------|
| Final Test Mode | Description |
| Mode 1 | TX Mode NOTE (1) |

Note:

- (1) The measurements are performed at the high, middle, low available channels.
- (2) The measurements for Hopping Channel Separation, Bandwidth and Maximum Output Power were tested during 1Mbps, 2Mbps and 3Mbps, the worst case are 1Mbps and 3Mbps, only worst case was documented.

3.3PARAMETERS OF TEST SOFTWARE

During testing, channel & power controlling software provided by the customer was used to control the operating channel as well as the output power level. The RF output power selection is for the setting of RF output power expected by the customer and is going to be fixed on the firmware of the final end product power parameters of FHSS

| | | | |
|-------------------|---------|---------|---------|
| Test Software | N/A | | |
| Frequency (MHz) | 2402 | 2441 | 2480 |
| Parameters(1Mbps) | Default | Default | Default |
| Parameters(3Mbps) | Default | Default | Default |

3.4BLOCK DIAGRAM SHOWING THE CONFIGURATION OF SYSTEM TESTED

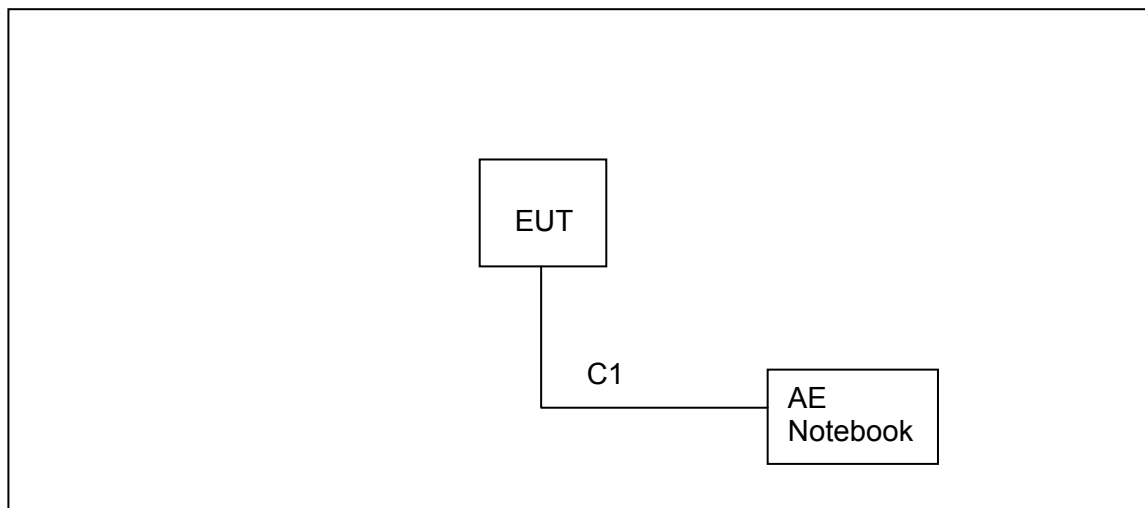

3.5SUPPORT UNITS

| Item | Equipment | Brand | Model No. | Series No. |
|------|-----------|--------|-----------|------------|
| AE | Notebook | Lenovo | / | / |

| Item | Cable Type | Shielded Type | Ferrite Core | Length |
|------|------------|---------------|--------------|--------|
| C1 | DC Cable | NO | NO | 0.8m |

3.6 TEST ENVIRONMENT CONDITIONS

| Test Item | Temperature | Humidity | Test Voltage |
|-----------------------------------|-------------|----------|--------------|
| AC Power Line Conducted Emissions | 25°C | 53% | DC 14.4V |
| Radiated Emissions-9K-30MHz | 25°C | 60% | DC 14.4V |
| Radiated Emissions-30 MHz to 1GHz | 24°C | 68% | DC 14.4V |
| Radiated Emissions-Above 1000 MHz | 24°C | 68% | DC 14.4V |
| Number of Hopping Frequency | 24.8°C | 40.9% | DC 14.4V |
| Average Time Of Occupancy | 24.8°C | 40.9% | DC 14.4V |
| Hopping Channel Separation | 24.8°C | 40.9% | DC 14.4V |
| Bandwidth | 24.8°C | 40.9% | DC 14.4V |
| Maximum Output Power | 24.8°C | 40.9% | DC 14.4V |
| Conducted Spurious Emission | 24.8°C | 40.9% | DC 14.4V |

4AC POWER LINE CONDUCTED EMISSIONS TEST

4.1LIMIT

| Frequency of Emission (MHz) | Limit (dBµV) | |
|-----------------------------|--------------|-----------|
| | Quasi-peak | Average |
| 0.15 - 0.50 | 66 to 56* | 56 to 46* |
| 0.50 - 5.0 | 56 | 46 |
| 5.0 - 30.0 | 60 | 50 |

Note:

- (1) The tighter limit applies at the band edges.
- (2) The limit of " * " marked band means the limitation decreases linearly with the logarithm of the frequency in the range.

The following table is the setting of the receiver

| Receiver Parameters | Setting |
|---------------------|----------|
| Attenuation | 10 dB |
| Start Frequency | 0.15 MHz |
| Stop Frequency | 30 MHz |
| IF Bandwidth | 9 kHz |

4.2TEST PROCEDURE

- a. The EUT was placed 0.8 meters from the horizontal ground plane with EUT being connected to the power mains through a line impedance stabilization network (LISN). All other support equipment powered from additional LISN(s). The LISN provide 50 Ohm/ 50uH of coupling impedance for the measuring instrument.
- b. Interconnecting cables that hang closer than 40 cm to the ground plane shall be folded back and forth in the center forming a bundle 30 to 40 cm long.
- c. I/O cables that are not connected to a peripheral shall be bundled in the center. The end of the cable may be terminated, if required, using the correct terminating impedance. The overall length shall not exceed 1 m.
- d. LISN at least 80 cm from nearest part of EUT chassis.

4.3MEASUREMENT INSTRUMENTS LIST

| Item | Kind of Equipment | Manufacturer | Type No. | Serial No. | Calibrated until |
|------|----------------------|-------------------|----------------------|-----------------|------------------|
| 1 | Pulse Limiter | MTS-systemtechnik | MTS-IMP-136 | 261115-010-0024 | 12/19/2022 |
| 2 | EMI Test Receiver | R&S | ESCI | 101308 | 12/17/2022 |
| 3 | LISN | AFJ | LS16 | 16011103219 | 06/09/2022 |
| 4 | LISN | Schwarzbeck | NSLK 8127 | 8127-432 | 12/17/2022 |
| 5 | Measurement Software | Farad | EZ-EMC (Ver.ATT-03A) | N/A | N/A |

4.4 TEST SETUP

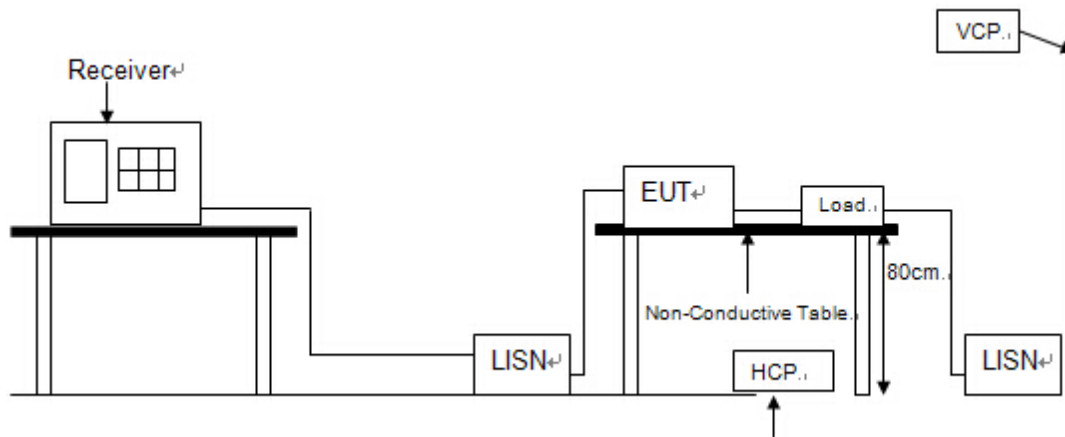

4.5 EUT OPERATING CONDITIONS

The EUT was configured for testing in a typical function (as a customer would normally use it), EUT was programmed to be in continuously transmitting data or hopping on mode.

4.6 TEST RESULTS

Test Mode: TX Mode Channel 78 _3Mbps

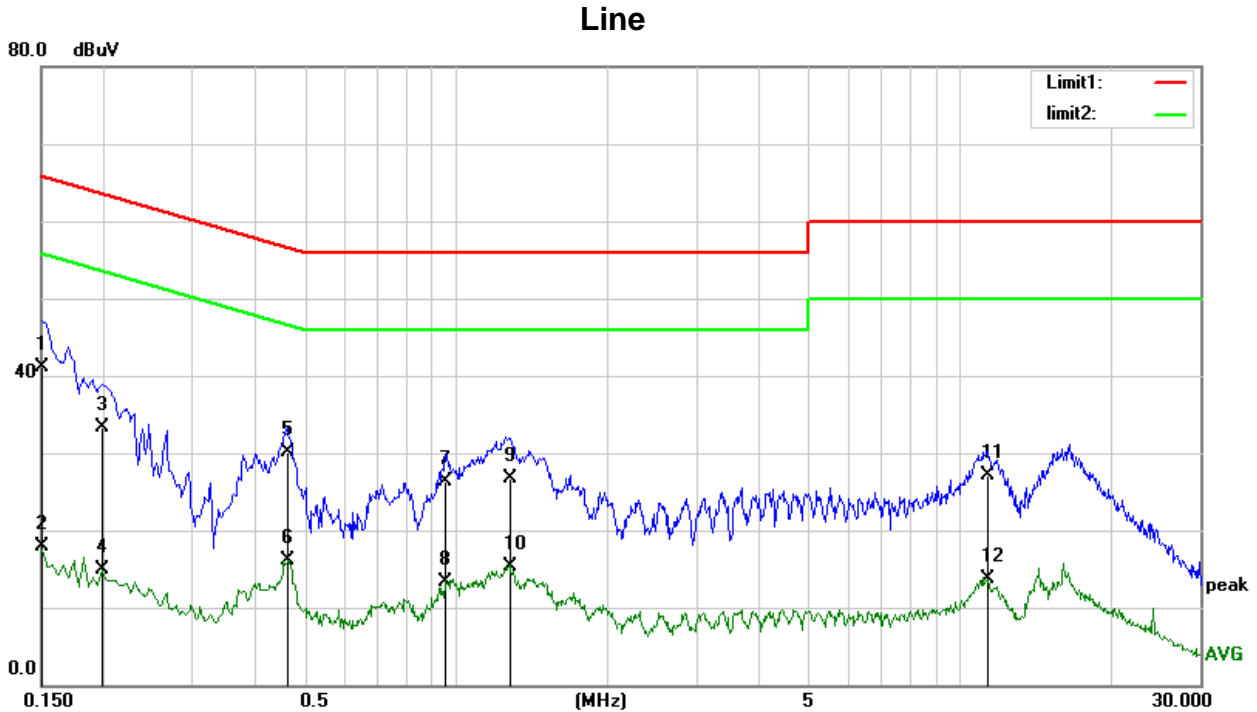

| No. | Frequency (MHz) | Reading (dBuV) | Correct Factor(dB) | Result (dBuV) | Limit (dBuV) | Margin (dB) | Remark |
|-----|-----------------|----------------|--------------------|---------------|--------------|-------------|--------|
| 1 | 0.1500 | 29.59 | 11.53 | 41.12 | 65.99 | -24.87 | QP |
| 2 | 0.1500 | 6.47 | 11.53 | 18.00 | 55.99 | -37.99 | AVG |
| 3 | 0.1980 | 22.06 | 11.20 | 33.26 | 63.69 | -30.43 | QP |
| 4 | 0.1980 | 3.73 | 11.20 | 14.93 | 53.69 | -38.76 | AVG |
| 5 | 0.4660 | 19.88 | 10.32 | 30.20 | 56.58 | -26.38 | QP |
| 6 | 0.4660 | 5.73 | 10.32 | 16.05 | 46.58 | -30.53 | AVG |
| 7 | 0.9580 | 16.17 | 10.21 | 26.38 | 56.00 | -29.62 | QP |
| 8 | 0.9580 | 3.19 | 10.21 | 13.40 | 46.00 | -32.60 | AVG |
| 9 | 1.2780 | 16.42 | 10.21 | 26.63 | 56.00 | -29.37 | QP |
| 10 | 1.2780 | 5.19 | 10.21 | 15.40 | 46.00 | -30.60 | AVG |
| 11 | 11.3300 | 16.94 | 10.20 | 27.14 | 60.00 | -32.86 | QP |
| 12 | 11.3300 | 3.55 | 10.20 | 13.75 | 50.00 | -36.25 | AVG |

Remarks:

- (1) Measurement Value = Reading Level + Correct Factor.
- (2) Margin Level = Measurement Value - Limit Value.

Test Mode: TX Mode Channel 78 _3Mbps

Neutral

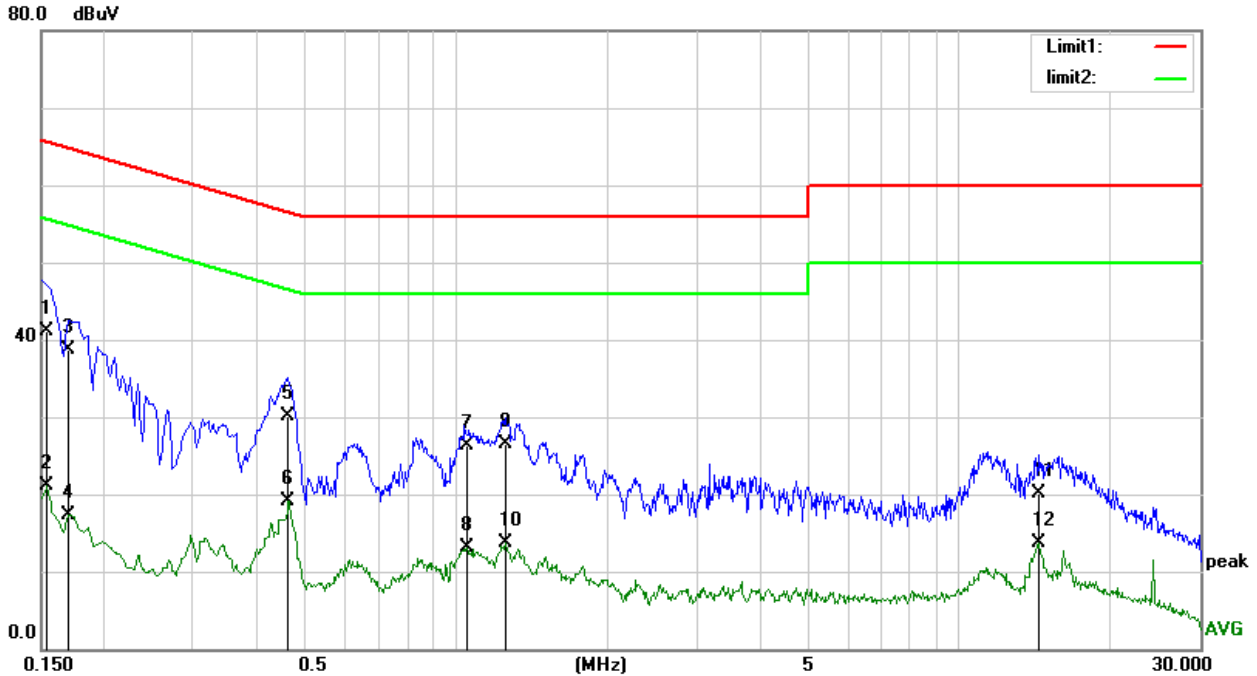

| No. | Frequency (MHz) | Reading (dBuV) | Correct Factor(dB) | Result (dBuV) | Limit (dBuV) | Margin (dB) | Remark |
|-----|-----------------|----------------|--------------------|---------------|--------------|-------------|--------|
| 1 | 0.1539 | 29.64 | 11.50 | 41.14 | 65.78 | -24.64 | QP |
| 2 | 0.1539 | 9.56 | 11.50 | 21.06 | 55.78 | -34.72 | AVG |
| 3 | 0.1700 | 27.26 | 11.39 | 38.65 | 64.96 | -26.31 | QP |
| 4 | 0.1700 | 5.93 | 11.39 | 17.32 | 54.96 | -37.64 | AVG |
| 5 | 0.4660 | 19.88 | 10.32 | 30.20 | 56.58 | -26.38 | QP |
| 6 | 0.4660 | 8.84 | 10.32 | 19.16 | 46.58 | -27.42 | AVG |
| 7 | 1.0500 | 16.13 | 10.21 | 26.34 | 56.00 | -29.66 | QP |
| 8 | 1.0500 | 2.95 | 10.21 | 13.16 | 46.00 | -32.84 | AVG |
| 9 | 1.2540 | 16.35 | 10.21 | 26.56 | 56.00 | -29.44 | QP |
| 10 | 1.2540 | 3.48 | 10.21 | 13.69 | 46.00 | -32.31 | AVG |
| 11 | 14.3820 | 9.91 | 10.21 | 20.12 | 60.00 | -39.88 | QP |
| 12 | 14.3820 | 3.40 | 10.21 | 13.61 | 50.00 | -36.39 | AVG |

Remarks:

- (1) Measurement Value = Reading Level + Correct Factor.
- (2) Margin Level = Measurement Value - Limit Value.

5 RADIATED EMISSION TEST

5.1 LIMIT

In case the emission fall within the restricted band specified on 15.205(a) & RSS-Gen 8.10, then the 15.209(a) & RSS-Gen 8.9 limit in the table below has to be followed.

LIMITS OF RADIATED EMISSION MEASUREMENT (9 kHz-1000MHz)

| Frequency (MHz) | Field Strength (microvolts/meter) | Measurement Distance (meters) |
|-----------------|-----------------------------------|-------------------------------|
| 0.009-0.490 | 2400/F(kHz) | 300 |
| 0.490-1.705 | 24000/F(kHz) | 30 |
| 1.705-30.0 | 30 | 30 |
| 30-88 | 100 | 3 |
| 88-216 | 150 | 3 |
| 216-960 | 200 | 3 |
| Above 960 | 500 | 3 |

LIMITS OF RADIATED EMISSION MEASUREMENT (9 kHz-30 MHz)

| Frequency (MHz) | Magnetic field strength (H-Field) (μA/m) | Measurement Distance (meters) |
|-----------------|--|-------------------------------|
| 0.009-0.490 | 6.37/F(kHz) | 300 |
| 0.490-1.705 | 6.37/F(kHz) | 30 |
| 1.705-30.0 | 0.08 | 30 |

LIMITS OF RADIATED EMISSION MEASUREMENT (30 MHz-1000MHz)

| Frequency (MHz) | Field Strength (μV/m at 3m) |
|-----------------|-----------------------------|
| 30-88 | 100 |
| 88-216 | 150 |
| 216-960 | 200 |
| Above 960 | 500 |

LIMITS OF RADIATED EMISSION MEASUREMENT (Above 1000MHz)

| Frequency (MHz) | (dBuV/m at 3 m) | |
|-----------------|-----------------|---------|
| | Peak | Average |
| Above 1000 | 74 | 54 |

Note:

- (1) The limit for radiated test was performed according to FCC PART 15C and RSS-247.
- (2) The tighter limit applies at the band edges.
- (3) Emission level (dBuV/m)=20log Emission level (uV/m).

5.2 TEST PROCEDURE AND SETTING

- a. The measuring distance of 3 m shall be used for measurements. The EUT was placed on the top of a rotating table 0.8 meter above the ground at a 3 meter semi-anechoic chamber. The table was rotated 360 degrees to determine the position of the highest radiation.(below 1GHz)
- b. The measuring distance of 3 m shall be used for measurements. The EUT was placed on the top of a rotating table 1.5 meter above the ground at a 3 meter semi-anechoic chamber. The table was rotated 360 degrees to determine the position of the highest radiation.(above 1GHz)
- c. The height of the equipment or of the substitution antenna shall be 0.8m or 1.5m; the height of the test antenna shall vary between 1 m to 4 m. Both horizontal and vertical polarizations of the antenna are set to make the measurement.
- d. For each suspected emission, the EUT was arranged to its worst case and then the antenna was tuned to heights find the maximum reading (used Bore sight function).
- e. The receiver system was set to peak and average detect function and specified bandwidth with maximum hold mode when the test frequency is above 1GHz.
- f. The initial step in collecting radiated emission data is a receiver peak detector mode pre-scanning the measurement frequency range. Significant peaks are then marked and then Quasi Peak detector mode re-measured.
- g. All readings are Peak unless otherwise stated QP in column of Note. Peak denotes that the Peak reading compliance with the QP Limits and then QP Mode measurement didn't perform. (below 1GHz)
- h. All readings are Peak Mode value unless otherwise stated AVG in column of Note. If the Peak Mode Measured value compliance with the Peak Limits and lower than AVG Limits, the EUT shall be deemed to meet both Peak & AVG Limits and then only Peak Mode was measured, but AVG Mode didn't perform. (above 1GHz)
- i. The test result is calculated as the following:
 - (1) Result = Reading + Correct Factor
 - (2) Correct Factor = Antenna Factor + Cable Loss – Amplifier Gain + Attenuator
 - (3) Margin = Result - Limit

| Spectrum Parameter | Setting |
|--|---|
| Attenuation | Auto |
| Start Frequency | 1000 MHz |
| Stop Frequency | 10th carrier harmonic |
| RBW / VBW (Emission in restricted band) | RBW 1MHz VBW 3MHz peak detector for Pk value RMS detector for AV value |

| Receiver Parameter | Setting |
|------------------------|-------------------------------------|
| Attenuation | Auto |
| Start ~ Stop Frequency | 9 kHz~90 kHz for PK/AVG detector |
| Start ~ Stop Frequency | 90 kHz~110 kHz for QP detector |
| Start ~ Stop Frequency | 110 kHz~490 kHz for PK/AVG detector |
| Start ~ Stop Frequency | 490 kHz~30 MHz for QP detector |
| Start ~ Stop Frequency | 30MHz~1000MHz for QP detector |

5.3 MEASUREMENT INSTRUMENTS LIST

| Item | Equipment | Manufacturer | Model No. | Serial No. | Calibrated until |
|------|------------------------|---------------|----------------------|--------------|------------------|
| 1 | EMI Test Receiver | R&S | ESCI | 101307 | 12/17/2022 |
| 2 | Spectrum Analyzer | Agilent | E4407B | US40240708 | 11/16/2022 |
| 3 | Loop antenna | SCHWARZBECK K | FMZB1519 | 1519-062 | 12/17/2022 |
| 4 | Broadband antenna | SCHWARZBECK | VULB9168 | VULB9168-192 | 08/05/2022 |
| 5 | HORN ANTENNA | SCHWARZBECK | BBHA9120D | 9120D 1065 | 05/07/2022 |
| 6 | Preamplifier Amplifier | HP | 8447F | 3113A05680 | 12/19/2022 |
| 7 | PRE-AMPLIFIER | CY | EMC011830 | 980136 | 12/19/2022 |
| 8 | RF Cable | R&S | Test Cable 4 | 4 | 12/19/2022 |
| 9 | RF Cable | R&S | Test Cable 5 | 5 | 12/19/2022 |
| 10 | RF Cable | R&S | Test Cable 9 | 9 | 04/21/2022 |
| 11 | RF Cable | R&S | Test Cable 10 | 10 | 12/19/2022 |
| 12 | Measurement Software | Farad | EZ-EMC (Ver.ATT-03A) | N/A | N/A |

5.4 TEST SETUP

9 kHz-30 MHz

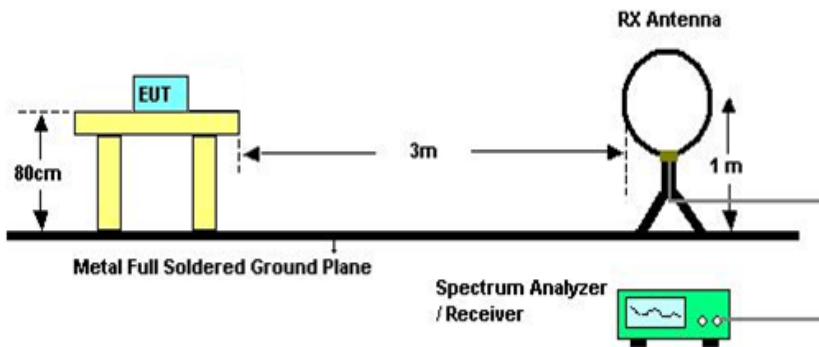

30 MHz to 1 GHz

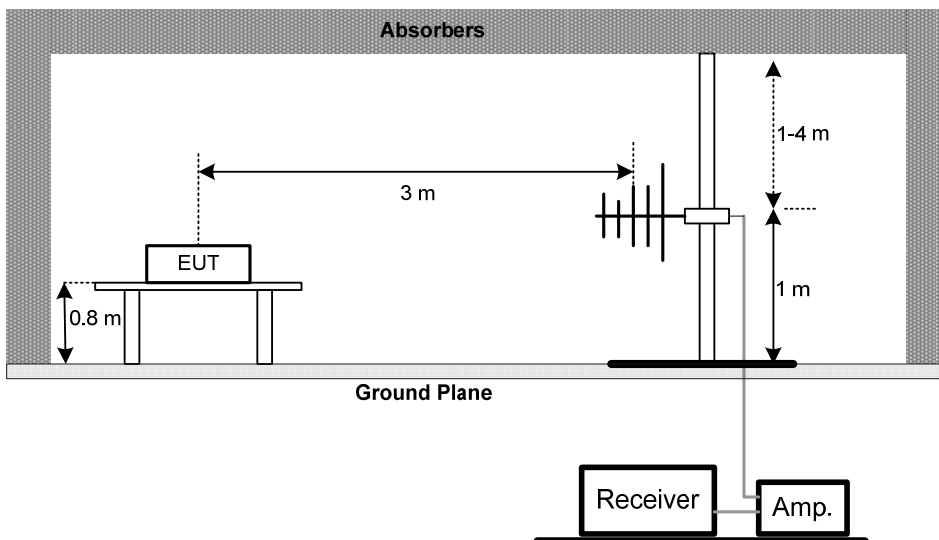

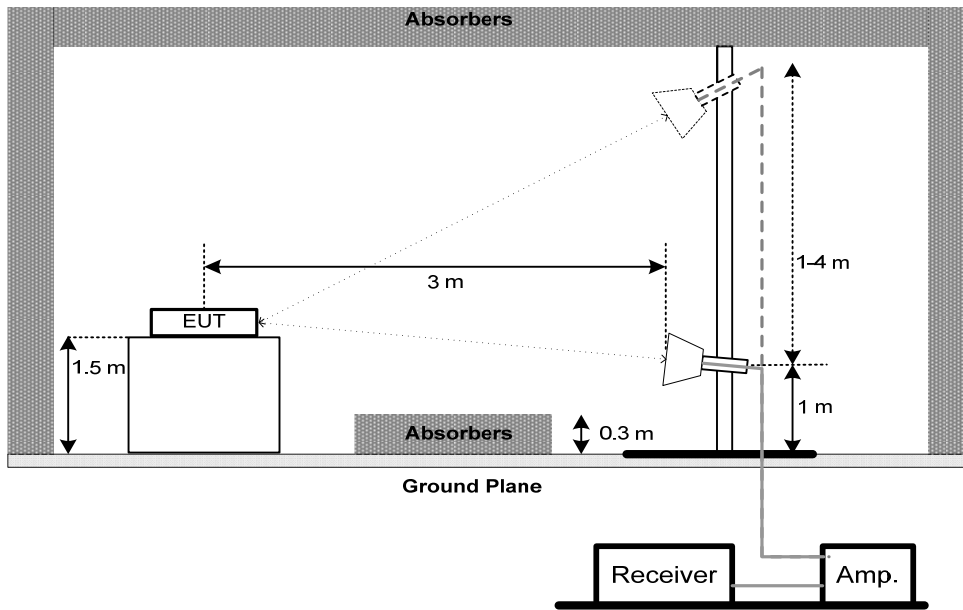
Above 1 GHz**5.5 EUT OPERATING CONDITIONS**

The EUT was programmed to be in continuously transmitting mode.

5.6 TEST RESULTS - 9 kHz TO 30MHz

| | |
|------------|---------------------------|
| Test Mode: | TX Mode Channel 00 _3Mbps |
|------------|---------------------------|

| Freq. | Reading | Limit | Margin | State |
|-------|----------|----------|--------|-------|
| (MHz) | (dBuV/m) | (dBuV/m) | (dB) | P/F |
| -- | -- | -- | -- | P |
| -- | -- | -- | -- | P |

Note:

The amplitude of spurious emissions which are attenuated by more than 20dB below the permissible value has no need to be reported.

Distance extrapolation factor = $20 \log (\text{specific distance}/\text{test distance})(\text{dB})$;

Limit line = specific limits(dBuv) + distance extrapolation factor

5.7 TEST RESULTS- 30 MHz TO 1000MHz

Test Mode: TX Mode Channel 78 _3Mbps

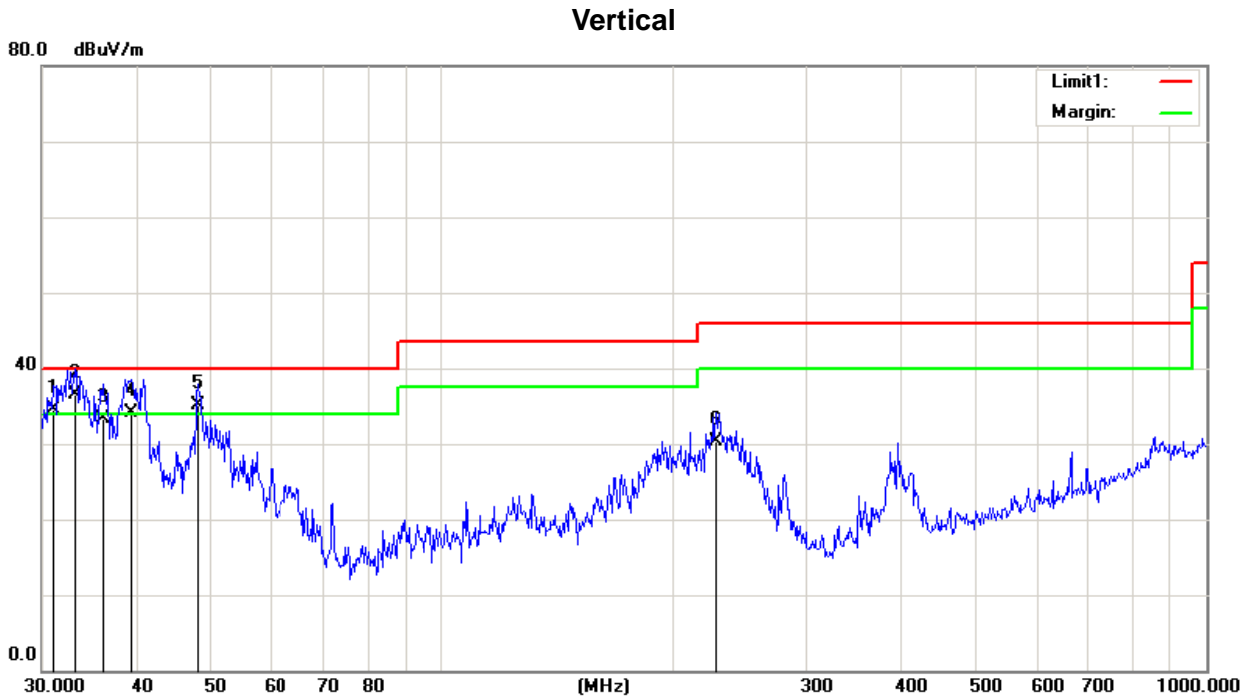

| No. | Frequency (MHz) | Reading (dBuV/m) | Correct Factor(dB/m) | Result (dBuV/m) | Limit (dBuV/m) | Margin (dB) | Remark | Antenna Height (cm) | Table Degree (degree) |
|-----|--------------------|---------------------|-------------------------|--------------------|-------------------|----------------|--------|---------------------------|-----------------------------|
| 1 | 31.0704 | 46.13 | -11.68 | 34.45 | 40.00 | -5.55 | QP | 100 | 235 |
| 2 | 33.2111 | 49.18 | -12.65 | 36.53 | 40.00 | -3.47 | QP | 100 | 114 |
| 3 | 36.0007 | 46.60 | -13.34 | 33.26 | 40.00 | -6.74 | QP | 100 | 12 |
| 4 | 39.2991 | 47.05 | -12.93 | 34.12 | 40.00 | -5.88 | QP | 100 | 114 |
| 5 | 47.9938 | 48.67 | -13.47 | 35.20 | 40.00 | -4.80 | QP | 200 | 252 |
| 6 | 228.4902 | 38.44 | -8.23 | 30.21 | 46.00 | -15.79 | QP | 100 | 1 |

Test Mode: TX Mode Channel 78 _3Mbps

Horizontal

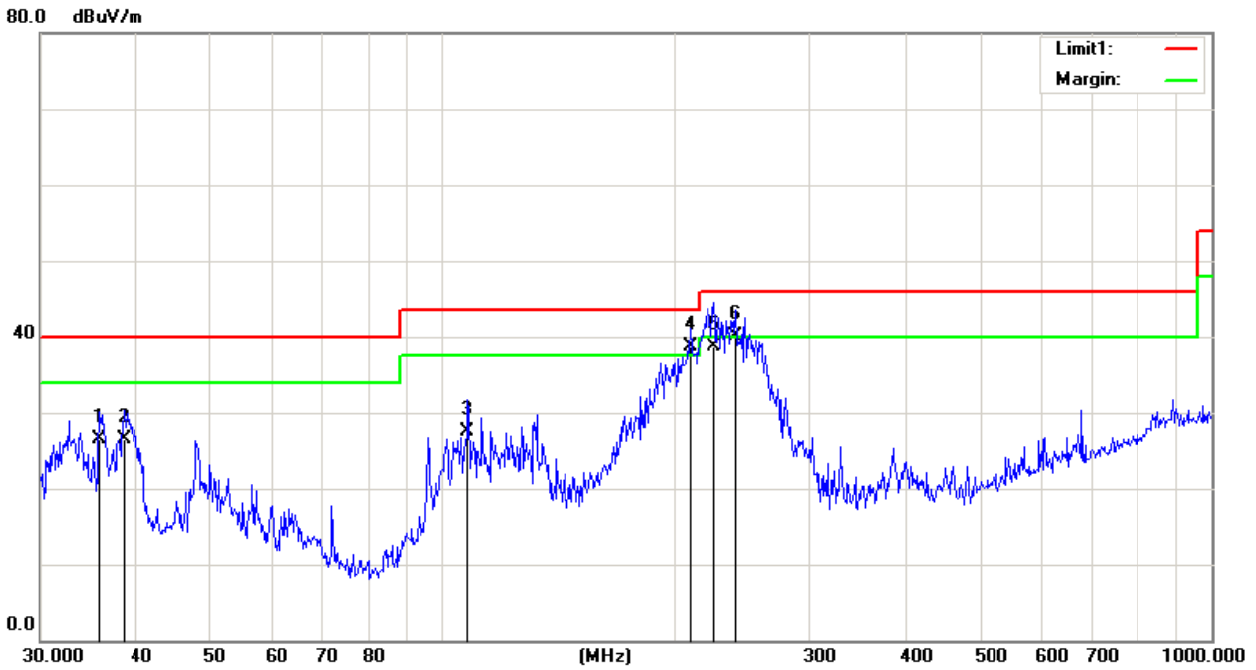

| No. | Frequency (MHz) | Reading (dBuV/m) | Correct Factor(dB/m) | Result (dBuV/m) | Limit (dBuV/m) | Margin (dB) | Remark | Antenna Height (cm) | Table Degree (degree) |
|-----|--------------------|---------------------|-------------------------|--------------------|-------------------|----------------|--------|---------------------------|-----------------------------|
| 1 | 35.7490 | 41.24 | -14.68 | 26.56 | 40.00 | -13.44 | QP | 300 | 114 |
| 2 | 38.4809 | 41.89 | -15.43 | 26.46 | 40.00 | -13.54 | QP | 300 | 12 |
| 3 | 107.8877 | 42.32 | -14.85 | 27.47 | 43.50 | -16.03 | QP | 300 | 55 |
| 4 | 210.0482 | 47.54 | -8.76 | 38.78 | 43.50 | -4.72 | QP | 200 | 325 |
| 5 | 225.9380 | 47.01 | -8.27 | 38.74 | 46.00 | -7.26 | QP | 100 | 14 |
| 6 | 240.8304 | 46.30 | -6.18 | 40.12 | 46.00 | -5.88 | QP | 100 | 212 |

5.8TEST RESULTS - ABOVE 1000MHz(BAND EDGE)

Test Mode: TX 2402 MHz_CH00_1Mbps

Vertical

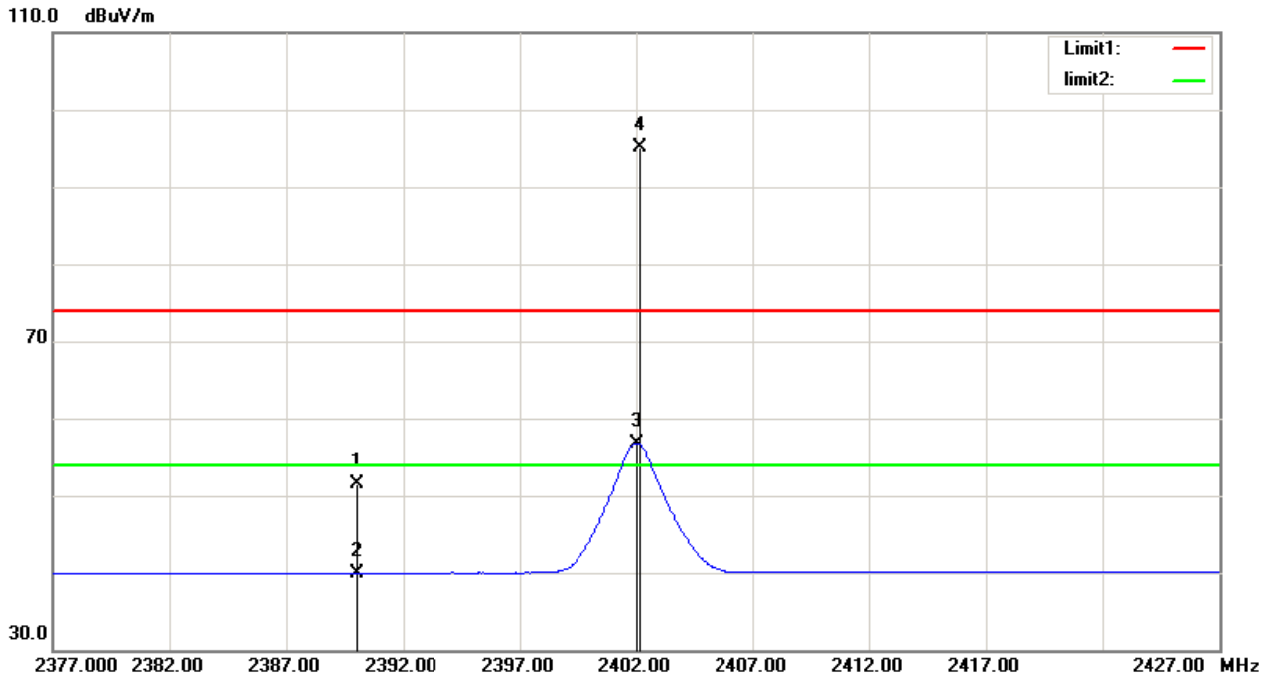

| No. | Frequency (MHz) | Reading (dBuV/m) | Correct Factor(dB/m) | Result (dBuV/m) | Limit (dBuV/m) | Margin (dB) | Remark | Antenna Height (cm) | Table Degree (degree) |
|-----|--------------------|---------------------|-------------------------|--------------------|-------------------|----------------|--------|---------------------------|-----------------------------|
| 1 | 2390.000 | 21.42 | 30.06 | 51.48 | 74.00 | -22.52 | peak | 150 | 62 |
| 2 | 2390.000 | 9.89 | 30.06 | 39.95 | 54.00 | -14.05 | AVG | 150 | 62 |
| 3 | 2402.000 | 26.67 | 30.10 | 56.77 | / | / | AVG | 150 | 62 |
| 4 | 2402.200 | 64.96 | 30.10 | 95.06 | / | / | peak | 150 | 62 |

Test Mode: TX 2402 MHz_CH00_1Mbps

Horizontal

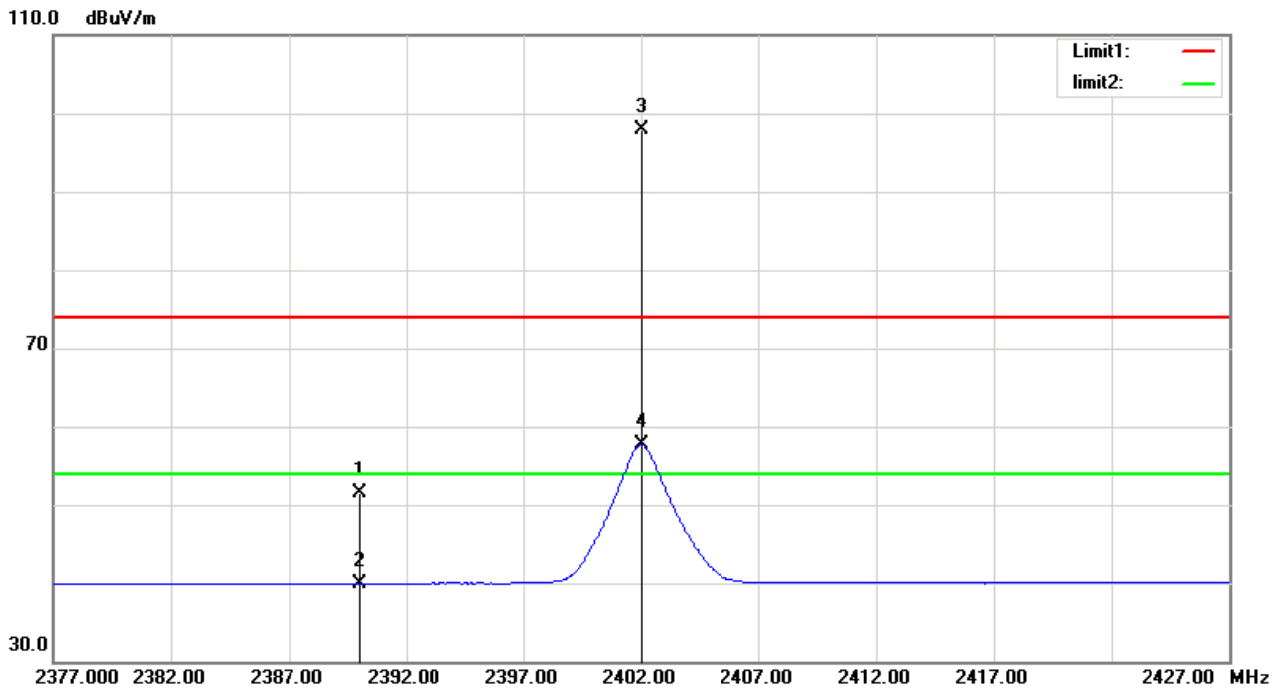

| No. | Frequency (MHz) | Reading (dBuV/m) | Correct Factor(dB/m) | Result (dBuV/m) | Limit (dBuV/m) | Margin (dB) | Remark | Antenna Height (cm) | Table Degree (degree) |
|-----|--------------------|---------------------|-------------------------|--------------------|-------------------|----------------|--------|---------------------------|-----------------------------|
| 1 | 2390.000 | 21.54 | 30.06 | 51.60 | 74.00 | -22.40 | peak | 150 | 97 |
| 2 | 2390.000 | 9.89 | 30.06 | 39.95 | 54.00 | -14.05 | AVG | 150 | 97 |
| 3 | 2402.000 | 67.85 | 30.10 | 97.95 | / | / | peak | 150 | 97 |
| 4 | 2402.000 | 27.56 | 30.10 | 57.66 | / | / | AVG | 150 | 97 |

Test Mode: TX 2480 MHz_CH78_1Mbps

Vertical

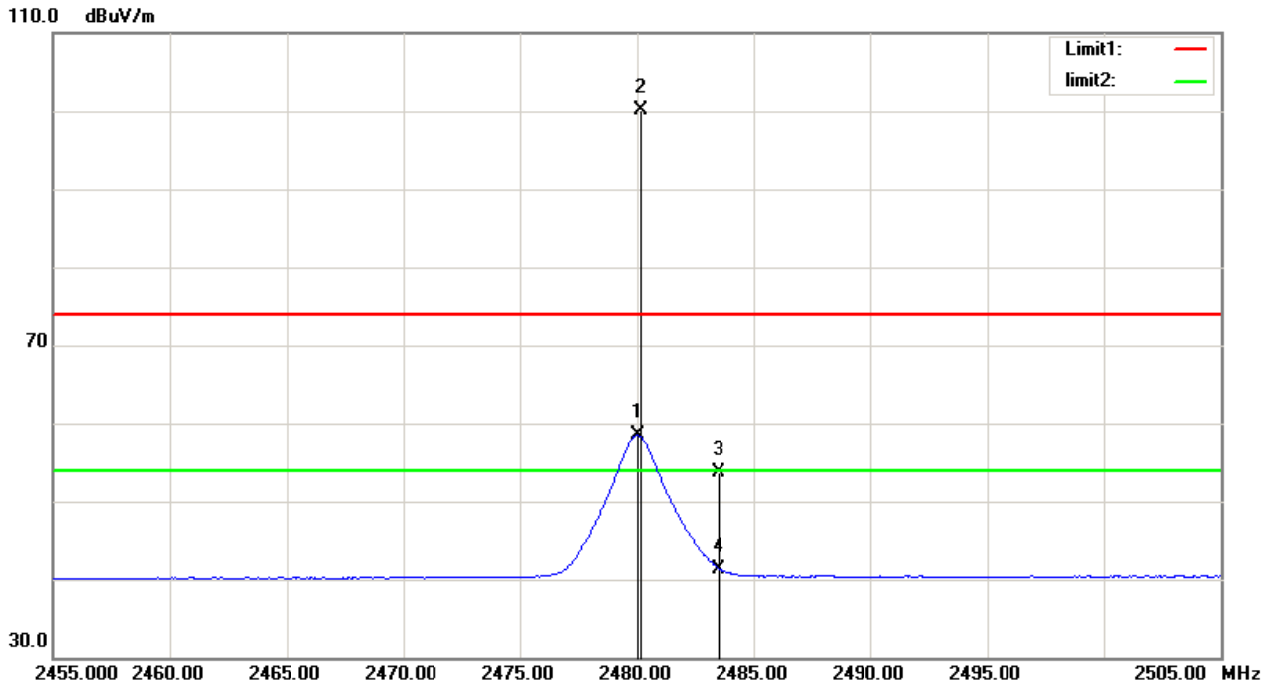

| No. | Frequency (MHz) | Reading (dBuV/m) | Correct Factor(dB/m) | Result (dBuV/m) | Limit (dBuV/m) | Margin (dB) | Remark | Antenna Height (cm) | Table Degree (degree) |
|-----|--------------------|---------------------|-------------------------|--------------------|-------------------|----------------|--------|---------------------------|-----------------------------|
| 1 | 2480.000 | 28.16 | 30.32 | 58.48 | / | / | AVG | 150 | 69 |
| 2 | 2480.200 | 69.77 | 30.32 | 100.09 | / | / | peak | 150 | 69 |
| 3 | 2483.500 | 23.45 | 30.33 | 53.78 | 74.00 | -20.22 | peak | 150 | 69 |
| 4 | 2483.500 | 11.03 | 30.33 | 41.36 | 54.00 | -12.64 | AVG | 150 | 69 |

Test Mode: TX 2480 MHz_CH78_1Mbps

Horizontal

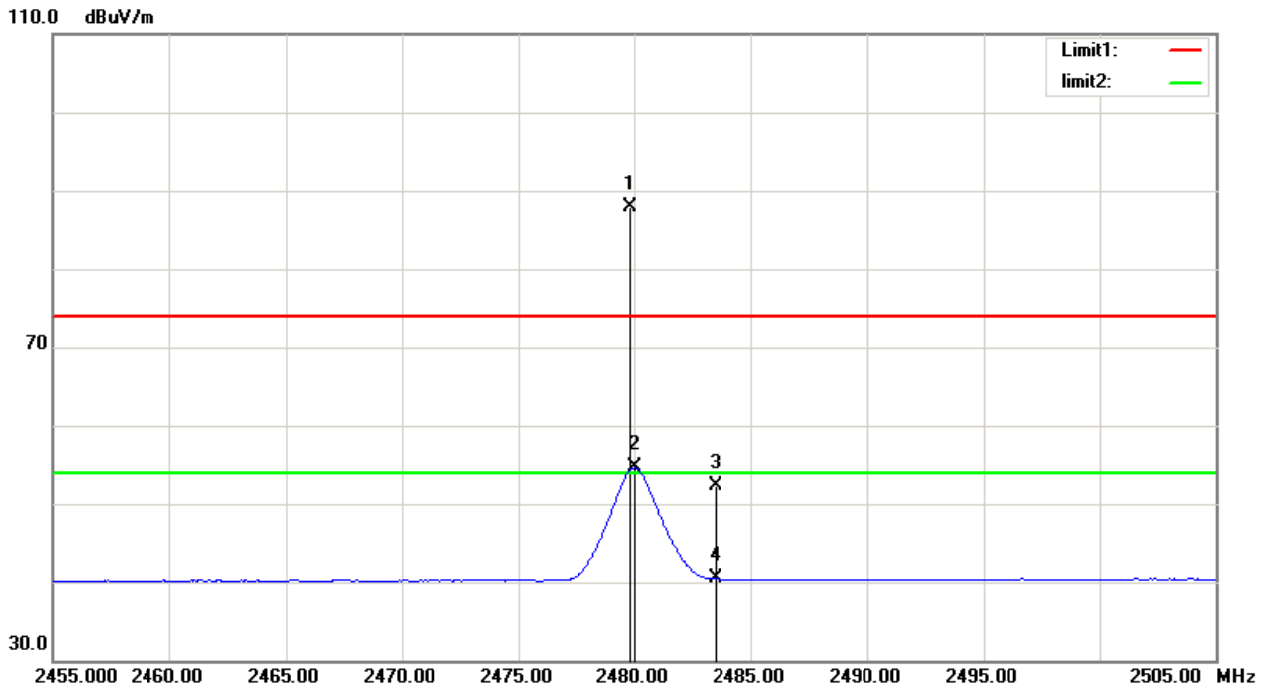

| No. | Frequency (MHz) | Reading (dBuV/m) | Correct Factor(dB/m) | Result (dBuV/m) | Limit (dBuV/m) | Margin (dB) | Remark | Antenna Height (cm) | Table Degree (degree) |
|-----|--------------------|---------------------|-------------------------|--------------------|-------------------|----------------|--------|---------------------------|-----------------------------|
| 1 | 2479.850 | 57.55 | 30.32 | 87.87 | / | / | peak | 150 | 90 |
| 2 | 2480.000 | 24.30 | 30.32 | 54.62 | / | / | AVG | 150 | 90 |
| 3 | 2483.500 | 22.02 | 30.33 | 52.35 | 74.00 | -21.65 | peak | 150 | 90 |
| 4 | 2483.500 | 10.12 | 30.33 | 40.45 | 54.00 | -13.55 | AVG | 150 | 90 |

Test Mode: TX 2402 MHz_CH00_3Mbps

Vertical

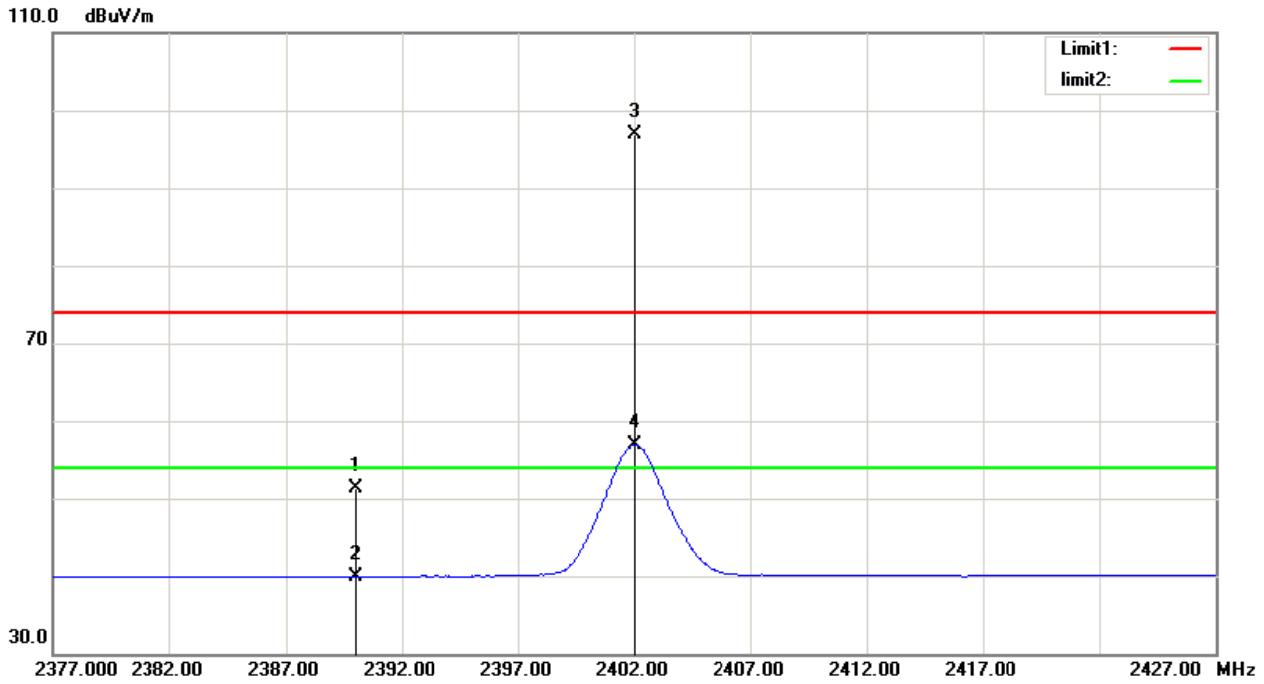

| No. | Frequency (MHz) | Reading (dBuV/m) | Correct Factor(dB/m) | Result (dBuV/m) | Limit (dBuV/m) | Margin (dB) | Remark | Antenna Height (cm) | Table Degree (degree) |
|-----|--------------------|---------------------|-------------------------|--------------------|-------------------|----------------|--------|---------------------------|-----------------------------|
| 1 | 2390.000 | 21.26 | 30.06 | 51.32 | 74.00 | -22.68 | peak | 150 | 77 |
| 2 | 2390.000 | 9.86 | 30.06 | 39.92 | 54.00 | -14.08 | AVG | 150 | 77 |
| 3 | 2402.050 | 66.81 | 30.10 | 96.91 | / | / | peak | 150 | 77 |
| 4 | 2402.050 | 26.80 | 30.10 | 56.90 | / | / | AVG | 150 | 77 |

Test Mode: TX 2402 MHz_CH00_3Mbps

Horizontal

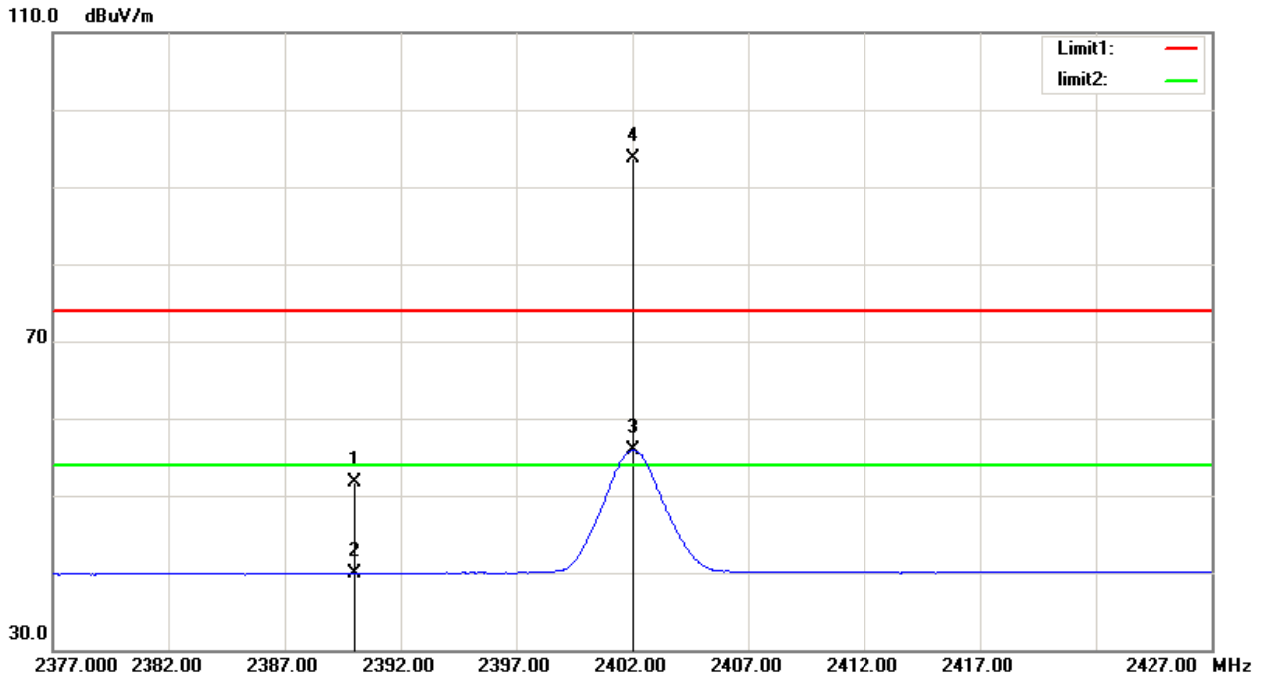

| No. | Frequency (MHz) | Reading (dBuV/m) | Correct Factor(dB/m) | Result (dBuV/m) | Limit (dBuV/m) | Margin (dB) | Remark | Antenna Height (cm) | Table Degree (degree) |
|-----|--------------------|---------------------|-------------------------|--------------------|-------------------|----------------|--------|---------------------------|-----------------------------|
| 1 | 2390.000 | 21.62 | 30.06 | 51.68 | 74.00 | -22.32 | peak | 150 | 0 |
| 2 | 2390.000 | 9.82 | 30.06 | 39.88 | 54.00 | -14.12 | AVG | 150 | 0 |
| 3 | 2402.000 | 25.77 | 30.10 | 55.87 | / | / | AVG | 150 | 0 |
| 4 | 2402.050 | 63.65 | 30.10 | 93.75 | / | / | peak | 150 | 0 |

Test Mode: TX 2480 MHz_CH78_3Mbps

Vertical

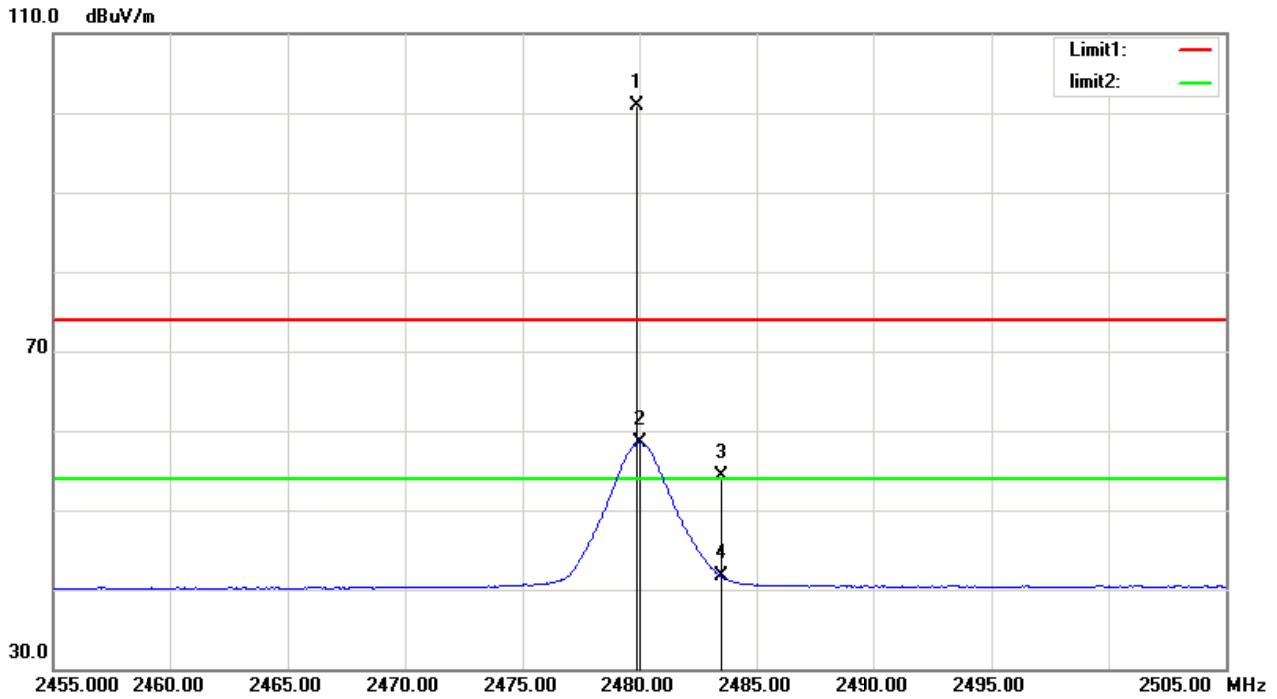

| No. | Frequency (MHz) | Reading (dBuV/m) | Correct Factor(dB/m) | Result (dBuV/m) | Limit (dBuV/m) | Margin (dB) | Remark | Antenna Height (cm) | Table Degree (degree) |
|-----|--------------------|---------------------|-------------------------|--------------------|-------------------|----------------|--------|---------------------------|-----------------------------|
| 1 | 2479.900 | 70.66 | 30.32 | 100.98 | / | / | peak | 150 | 69 |
| 2 | 2480.000 | 28.20 | 30.32 | 58.52 | / | / | AVG | 150 | 69 |
| 3 | 2483.500 | 23.89 | 30.33 | 54.22 | 74.00 | -19.78 | peak | 150 | 69 |
| 4 | 2483.500 | 11.35 | 30.33 | 41.68 | 54.00 | -12.32 | AVG | 150 | 69 |

Test Mode: TX 2480 MHz_CH78_3Mbps

Horizontal

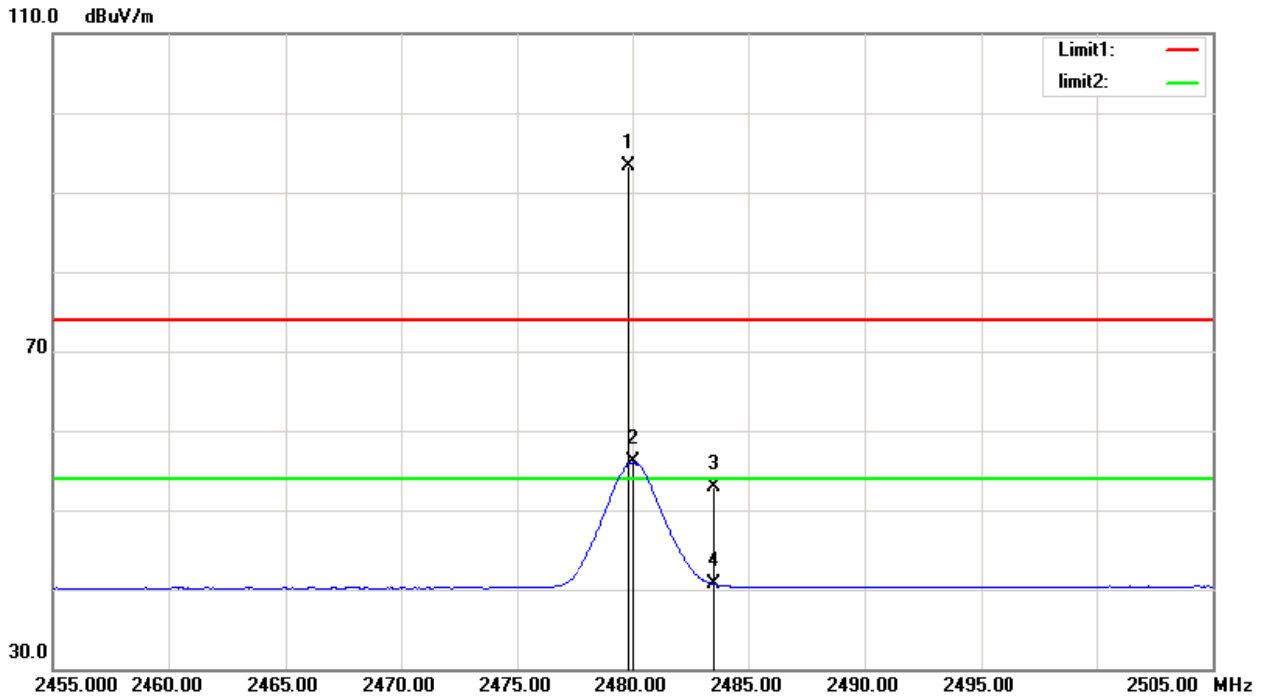

| No. | Frequency (MHz) | Reading (dBuV/m) | Correct Factor(dB/m) | Result (dBuV/m) | Limit (dBuV/m) | Margin (dB) | Remark | Antenna Height (cm) | Table Degree (degree) |
|-----|-----------------|------------------|----------------------|-----------------|----------------|-------------|--------|---------------------|-----------------------|
| 1 | 2479.850 | 62.99 | 30.32 | 93.31 | / | / | peak | 150 | 0 |
| 2 | 2480.050 | 25.70 | 30.32 | 56.02 | / | / | AVG | 150 | 0 |
| 3 | 2483.500 | 22.57 | 30.33 | 52.90 | 74.00 | -21.10 | peak | 150 | 0 |
| 4 | 2483.500 | 10.32 | 30.33 | 40.65 | 54.00 | -13.35 | AVG | 150 | 0 |

5.9 TEST RESULTS - ABOVE 1000MHz(HARMONIC)

Test Mode: TX 2402 MHz_CH00_1Mbps

Vertical

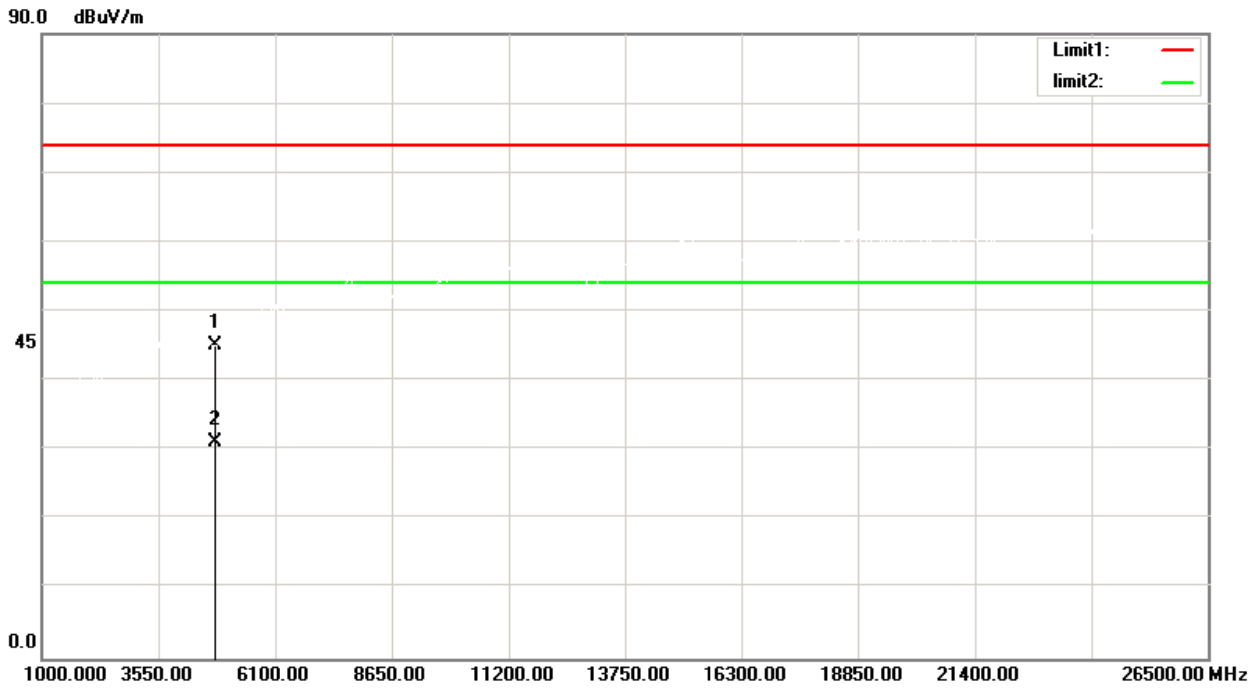

| No. | Frequency (MHz) | Reading (dBuV/m) | Correct Factor(dB/m) | Result (dBuV/m) | Limit (dBuV/m) | Margin (dB) | Remark | Antenna Height (cm) | Table Degree (degree) |
|-----|--------------------|---------------------|-------------------------|--------------------|-------------------|----------------|--------|---------------------------|-----------------------------|
| 1 | 4804.000 | 52.75 | -7.53 | 45.22 | 74.00 | -28.78 | peak | 150 | 68 |
| 2 | 4804.000 | 38.80 | -7.53 | 31.27 | 54.00 | -22.73 | AVG | 150 | 68 |

Test Mode: TX 2402 MHz_CH00_1Mbps

Horizontal

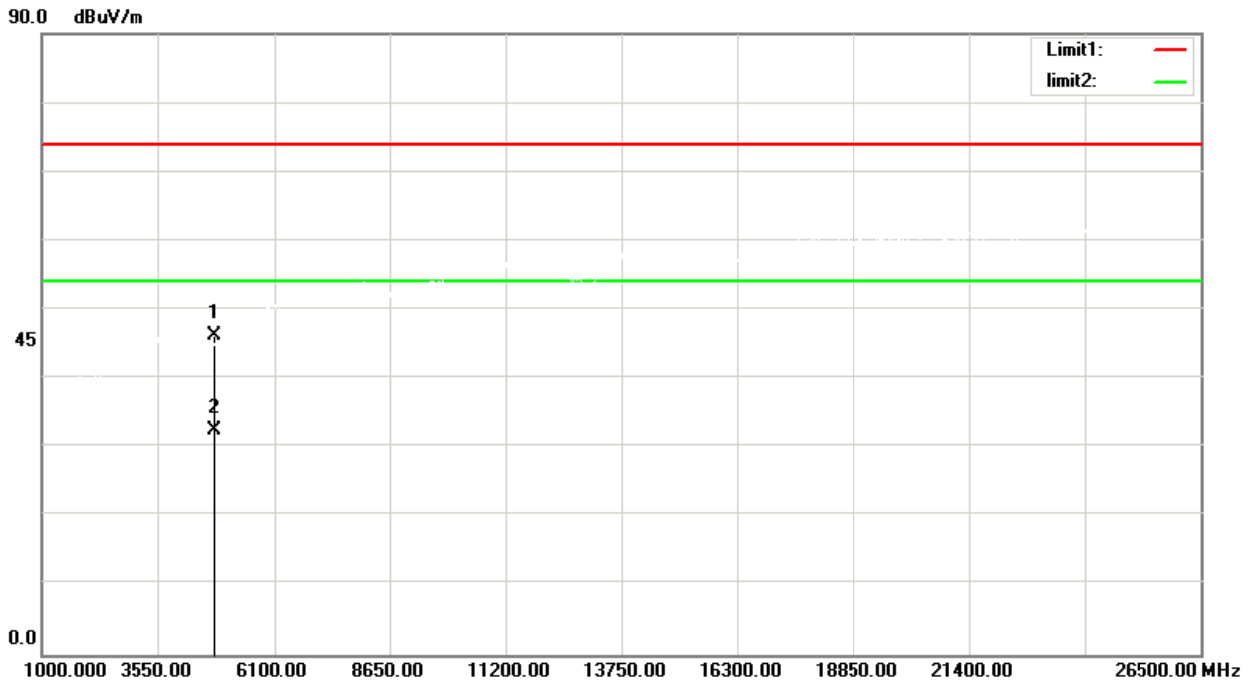

| No. | Frequency (MHz) | Reading (dBuV/m) | Correct Factor(dB/m) | Result (dBuV/m) | Limit (dBuV/m) | Margin (dB) | Remark | Antenna Height (cm) | Table Degree (degree) |
|-----|--------------------|---------------------|-------------------------|--------------------|-------------------|----------------|--------|---------------------------|-----------------------------|
| 1 | 4804.000 | 53.78 | -7.53 | 46.25 | 74.00 | -27.75 | peak | 150 | 97 |
| 2 | 4804.000 | 40.05 | -7.53 | 32.52 | 54.00 | -21.48 | AVG | 150 | 97 |

Test Mode: TX 2441 MHz_CH39_1Mbps

Vertical

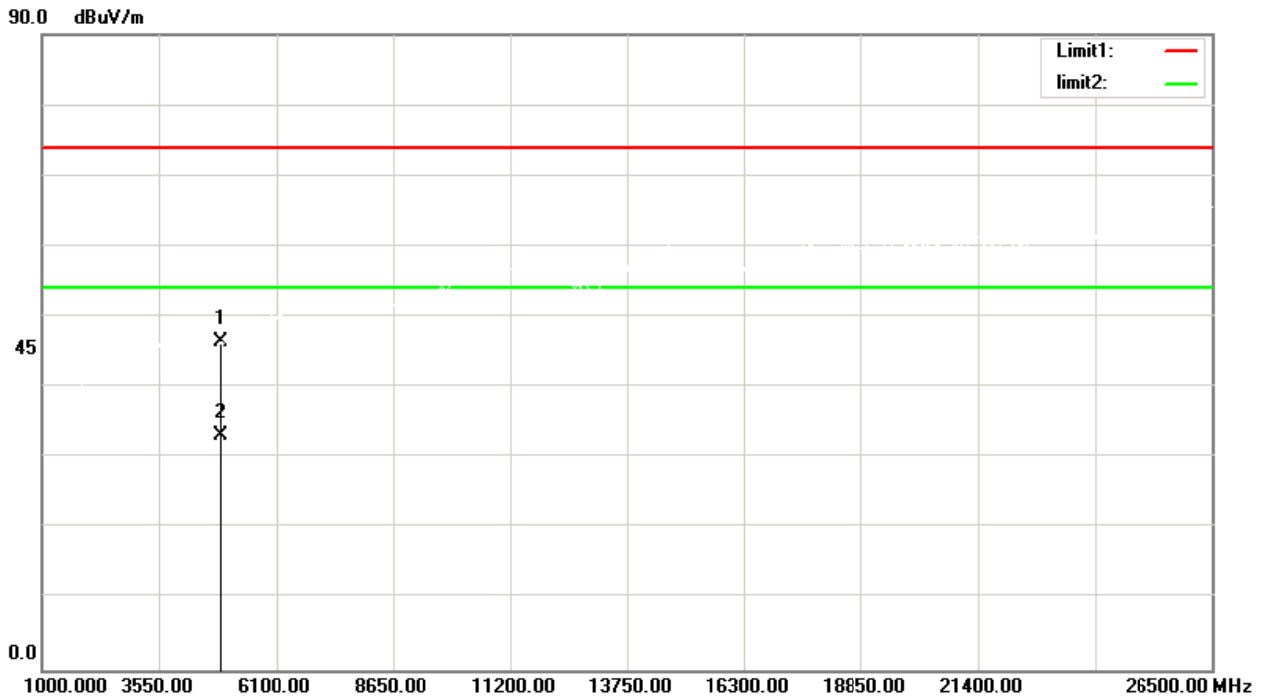

| No. | Frequency (MHz) | Reading (dBuV/m) | Correct Factor(dB/m) | Result (dBuV/m) | Limit (dBuV/m) | Margin (dB) | Remark | Antenna Height (cm) | Table Degree (degree) |
|-----|--------------------|---------------------|-------------------------|--------------------|-------------------|----------------|--------|---------------------------|-----------------------------|
| 1 | 4882.000 | 53.83 | -7.31 | 46.52 | 74.00 | -27.48 | peak | 150 | 71 |
| 2 | 4882.000 | 40.51 | -7.31 | 33.20 | 54.00 | -20.80 | AVG | 150 | 71 |

Test Mode: TX 2441 MHz_CH39_1Mbps

Horizontal

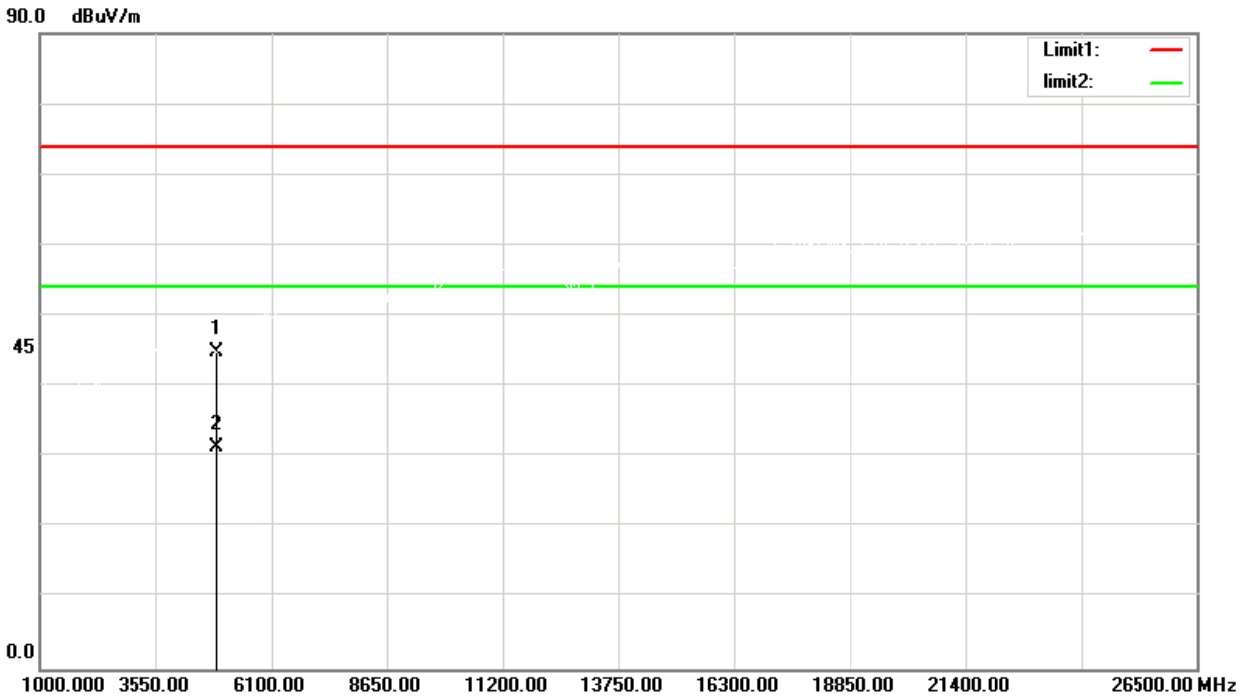

| No. | Frequency (MHz) | Reading (dBuV/m) | Correct Factor(dB/m) | Result (dBuV/m) | Limit (dBuV/m) | Margin (dB) | Remark | Antenna Height (cm) | Table Degree (degree) |
|-----|--------------------|---------------------|-------------------------|--------------------|-------------------|----------------|--------|---------------------------|-----------------------------|
| 1 | 4882.000 | 52.28 | -7.31 | 44.97 | 74.00 | -29.03 | peak | 150 | 92 |
| 2 | 4882.000 | 38.59 | -7.31 | 31.28 | 54.00 | -22.72 | AVG | 150 | 92 |

Test Mode: TX 2480 MHz_CH78_1Mbps

Vertical

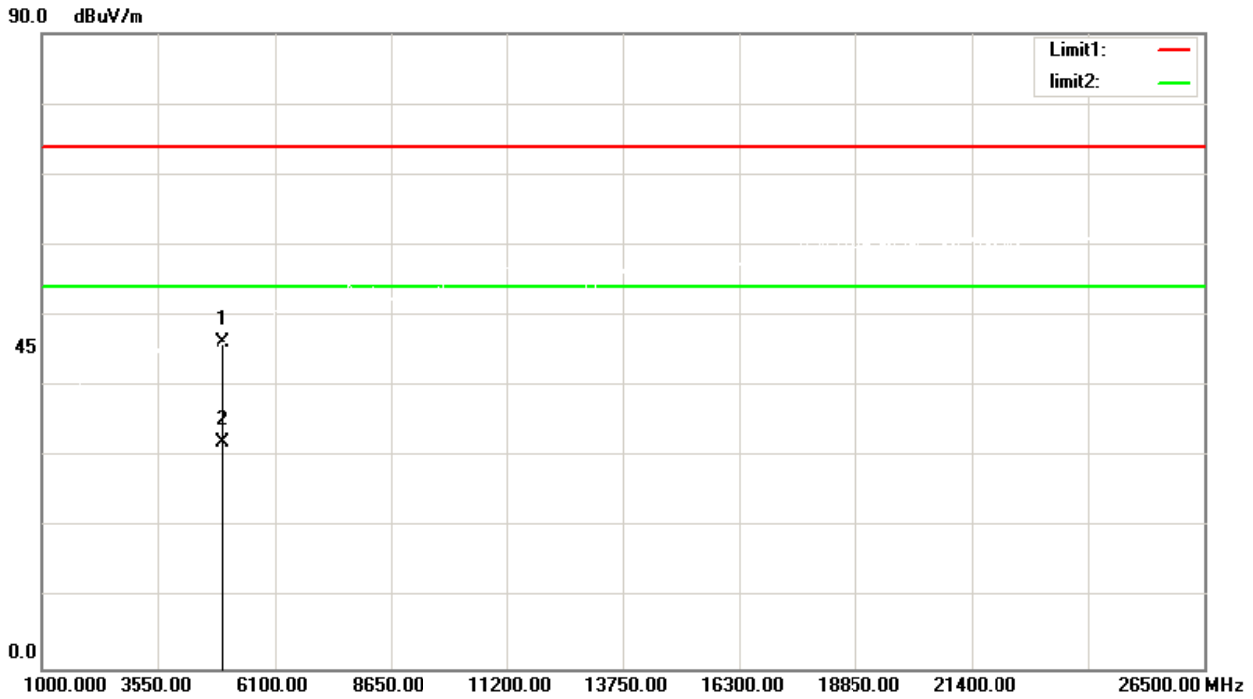

| No. | Frequency (MHz) | Reading (dBuV/m) | Correct Factor(dB/m) | Result (dBuV/m) | Limit (dBuV/m) | Margin (dB) | Remark | Antenna Height (cm) | Table Degree (degree) |
|-----|--------------------|---------------------|-------------------------|--------------------|-------------------|----------------|--------|---------------------------|-----------------------------|
| 1 | 4960.000 | 53.28 | -7.09 | 46.19 | 74.00 | -27.81 | peak | 150 | 67 |
| 2 | 4960.000 | 39.24 | -7.09 | 32.15 | 54.00 | -21.85 | AVG | 150 | 67 |

Test Mode: TX 2480 MHz_CH78_1Mbps

Horizontal

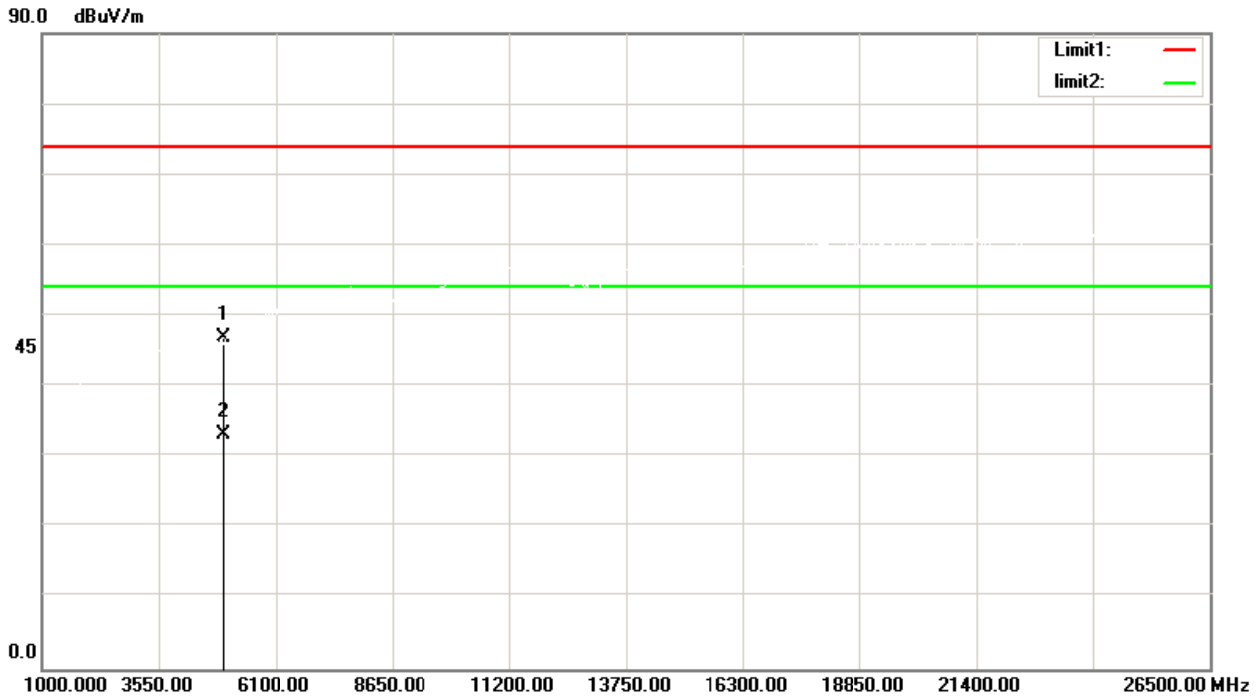

| No. | Frequency (MHz) | Reading (dBuV/m) | Correct Factor(dB/m) | Result (dBuV/m) | Limit (dBuV/m) | Margin (dB) | Remark | Antenna Height (cm) | Table Degree (degree) |
|-----|--------------------|---------------------|-------------------------|--------------------|-------------------|----------------|--------|---------------------------|-----------------------------|
| 1 | 4960.000 | 54.05 | -7.09 | 46.96 | 74.00 | -27.04 | peak | 150 | 96 |
| 2 | 4960.000 | 40.29 | -7.09 | 33.20 | 54.00 | -20.80 | AVG | 150 | 96 |

Test Mode: TX 2402 MHz_CH00_3Mbps

Vertical

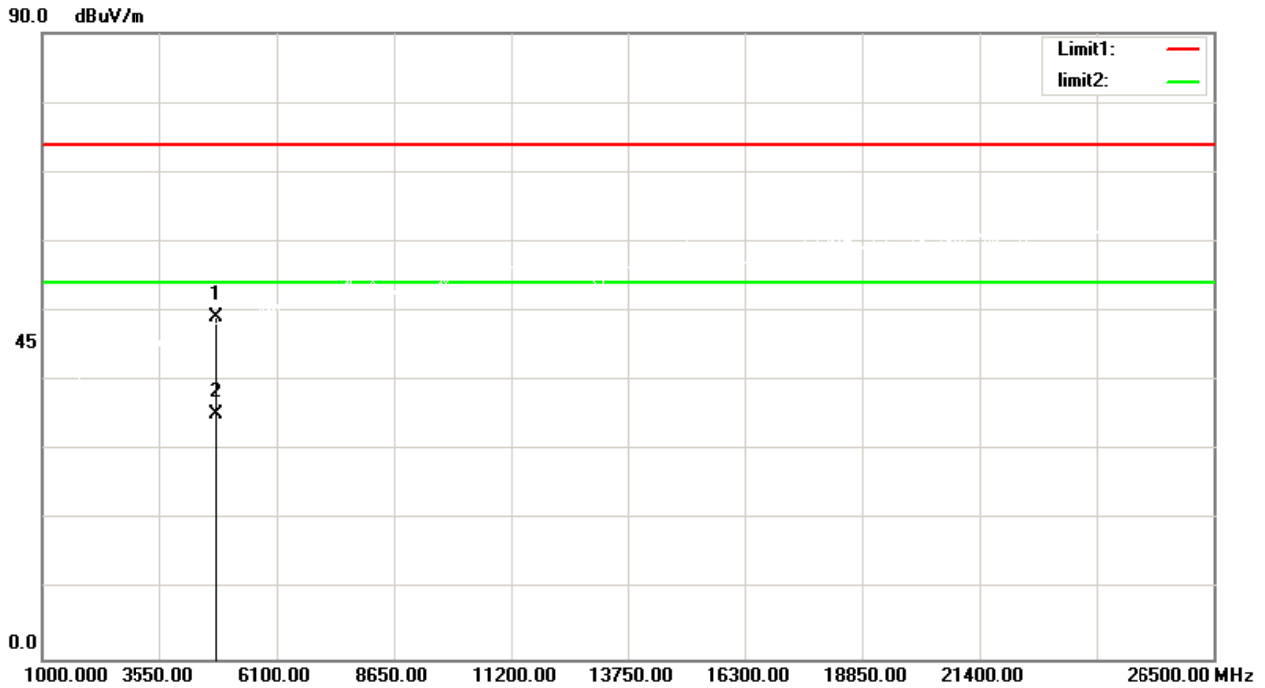

| No. | Frequency (MHz) | Reading (dBuV/m) | Correct Factor(dB/m) | Result (dBuV/m) | Limit (dBuV/m) | Margin (dB) | Remark | Antenna Height (cm) | Table Degree (degree) |
|-----|--------------------|---------------------|-------------------------|--------------------|-------------------|----------------|--------|---------------------------|-----------------------------|
| 1 | 4804.000 | 56.71 | -7.53 | 49.18 | 74.00 | -24.82 | peak | 150 | 71 |
| 2 | 4804.000 | 42.79 | -7.53 | 35.26 | 54.00 | -18.74 | AVG | 150 | 71 |

Test Mode: TX 2402 MHz_CH00_3Mbps

Horizontal

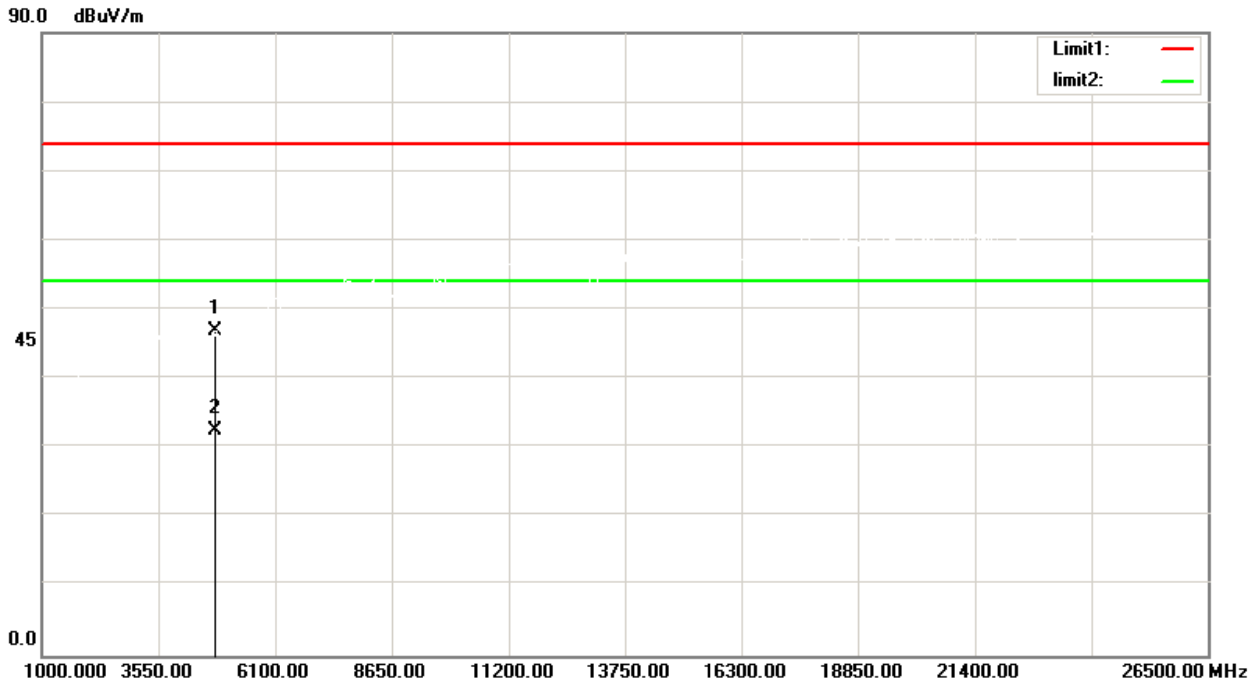

| No. | Frequency (MHz) | Reading (dBuV/m) | Correct Factor(dB/m) | Result (dBuV/m) | Limit (dBuV/m) | Margin (dB) | Remark | Antenna Height (cm) | Table Degree (degree) |
|-----|--------------------|---------------------|-------------------------|--------------------|-------------------|----------------|--------|---------------------------|-----------------------------|
| 1 | 4804.000 | 54.49 | -7.53 | 46.96 | 74.00 | -27.04 | peak | 150 | 1 |
| 2 | 4804.000 | 40.15 | -7.53 | 32.62 | 54.00 | -21.38 | AVG | 150 | 1 |

Test Mode: TX 2441 MHz_CH39_3Mbps

Vertical

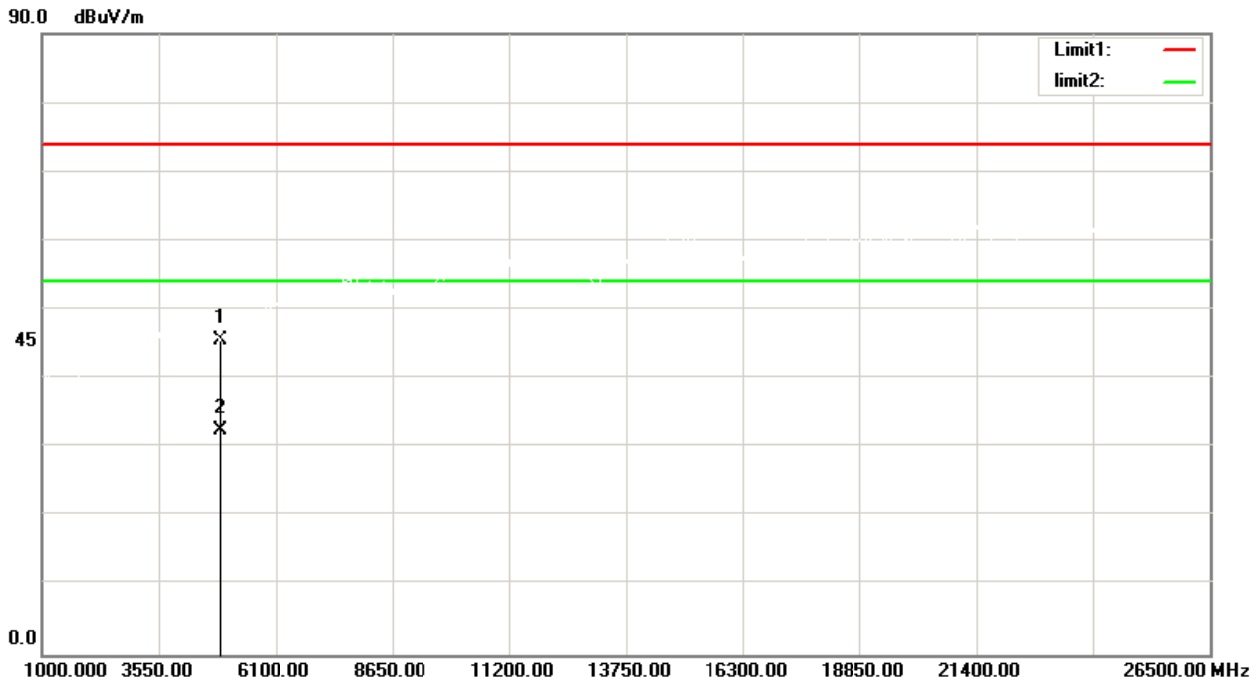

| No. | Frequency (MHz) | Reading (dBuV/m) | Correct Factor(dB/m) | Result (dBuV/m) | Limit (dBuV/m) | Margin (dB) | Remark | Antenna Height (cm) | Table Degree (degree) |
|-----|--------------------|---------------------|-------------------------|--------------------|-------------------|----------------|--------|---------------------------|-----------------------------|
| 1 | 4882.000 | 52.94 | -7.31 | 45.63 | 74.00 | -28.37 | peak | 150 | 68 |
| 2 | 4882.000 | 39.73 | -7.31 | 32.42 | 54.00 | -21.58 | AVG | 150 | 68 |

Test Mode: TX 2441 MHz_CH39_3Mbps

Horizontal

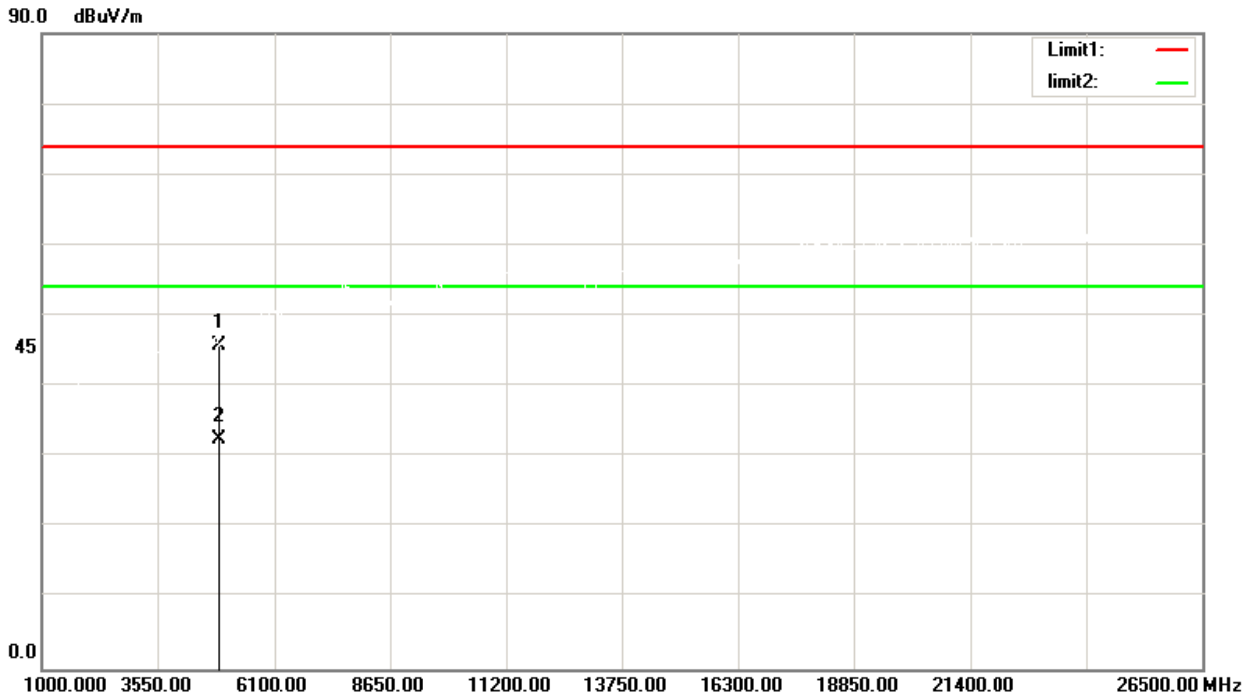

| No. | Frequency (MHz) | Reading (dBuV/m) | Correct Factor(dB/m) | Result (dBuV/m) | Limit (dBuV/m) | Margin (dB) | Remark | Antenna Height (cm) | Table Degree (degree) |
|-----|--------------------|---------------------|-------------------------|--------------------|-------------------|----------------|--------|---------------------------|-----------------------------|
| 1 | 4882.000 | 53.10 | -7.31 | 45.79 | 74.00 | -28.21 | peak | 150 | 2 |
| 2 | 4882.000 | 39.84 | -7.31 | 32.53 | 54.00 | -21.47 | AVG | 150 | 2 |

Test Mode: TX 2480 MHz_CH78_3Mbps

Vertical

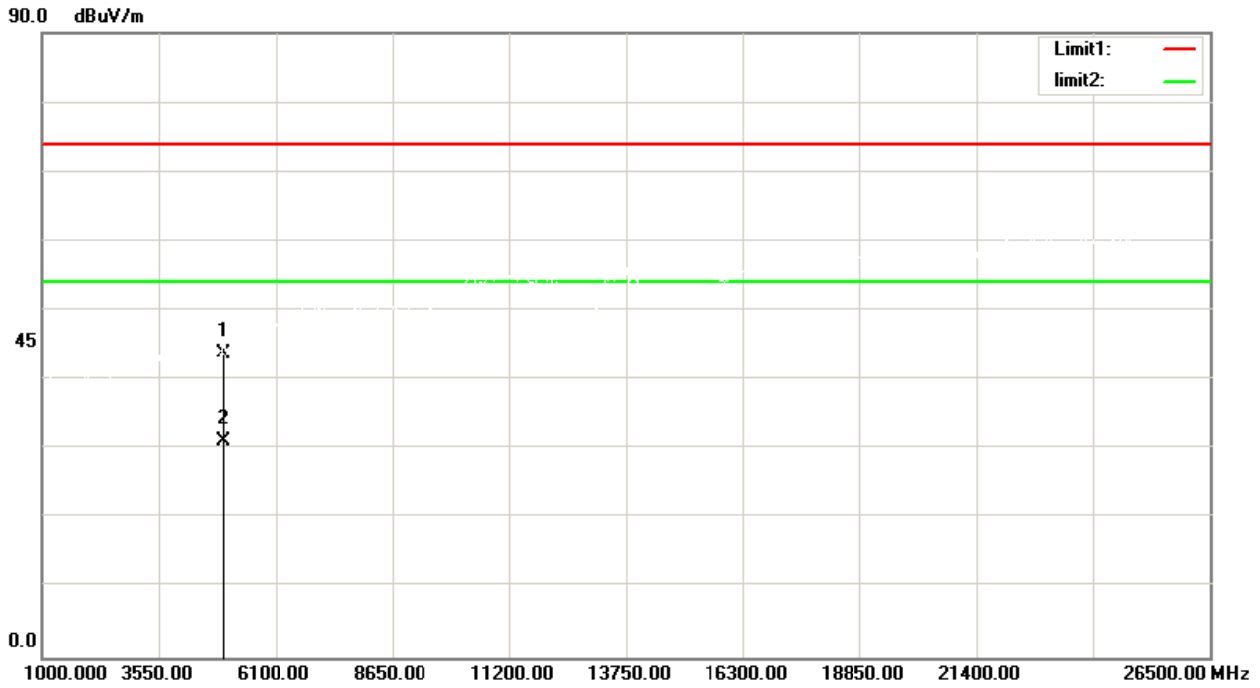

| No. | Frequency (MHz) | Reading (dBuV/m) | Correct Factor(dB/m) | Result (dBuV/m) | Limit (dBuV/m) | Margin (dB) | Remark | Antenna Height (cm) | Table Degree (degree) |
|-----|--------------------|---------------------|-------------------------|--------------------|-------------------|----------------|--------|---------------------------|-----------------------------|
| 1 | 4960.000 | 50.90 | -7.09 | 43.81 | 74.00 | -30.19 | peak | 150 | 77 |
| 2 | 4960.000 | 38.33 | -7.09 | 31.24 | 54.00 | -22.76 | AVG | 150 | 77 |

Test Mode: TX 2480 MHz_CH78_3Mbps

Horizontal

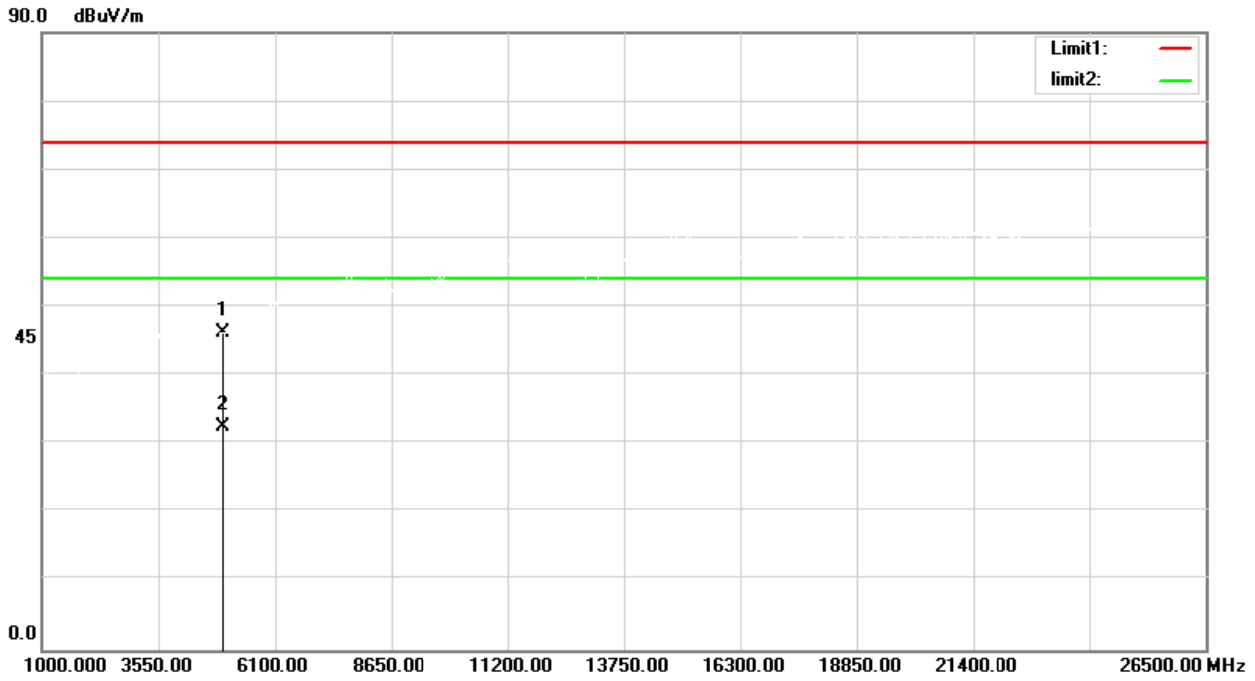

| No. | Frequency (MHz) | Reading (dBuV/m) | Correct Factor(dB/m) | Result (dBuV/m) | Limit (dBuV/m) | Margin (dB) | Remark | Antenna Height (cm) | Table Degree (degree) |
|-----|-----------------|------------------|----------------------|-----------------|----------------|-------------|--------|---------------------|-----------------------|
| 1 | 4960.000 | 53.24 | -7.09 | 46.15 | 74.00 | -27.85 | peak | 150 | 0 |
| 2 | 4960.000 | 39.71 | -7.09 | 32.62 | 54.00 | -21.38 | AVG | 150 | 0 |

6NUMBER OF HOPPING FREQUENCY

6.1LIMIT

| FCC Part15, Subpart C (15.247)&RSS-247 | |
|--|-----------------------------|
| Section | Test Item |
| 15.247(a)(1)(iii) RSS-247 5.1 (d) | Number of Hopping Frequency |

6.2TEST PROCEDURE AND SETTING

- a. The EUT was directly connected to the spectrum analyzer and antenna output port as show in the block diagram below.
- b. Spectrum Setting: RBW=100 kHz, VBW=300 kHz, Sweep time = Auto.

| Spectrum Parameters | Setting |
|---------------------|-----------------------------|
| Attenuation | Auto |
| Span Frequency | > Operating Frequency Range |
| RBW | 100kHz |
| VBW | 300kHz |
| Detector | Peak |
| Trace | Max Hold |
| Sweep Time | Auto |

6.3MEASUREMENT INSTRUMENTS LIST

| Item | Kind of Equipment | Manufacturer | Type No. | Serial No. | Calibrated until |
|------|-------------------|---------------|-------------|------------|------------------|
| 1 | Spectrum analyzer | KEYSIGHT | N9010A | MY55150427 | 2022/05/28 |
| 2 | Attenuator | Mini-Circuits | BW-S10W2 | 101109 | N/A |
| 3 | RF Cable | Mi-cable | C10-01-01-1 | 100309 | N/A |

6.4TEST SETUP



6.5EUT OPERATION CONDITIONS

The EUT tested system was configured as the statements of 4.5 unless otherwise a special operating condition is specified in the follows during the testing.

6.6 TEST RESULTS

| Hopping Mode_1Mbps | | |
|-----------------------------|------------------------|-----------|
| Number of Hopping Frequency | Measurement result(CH) | Limit(CH) |
| | | 79 |

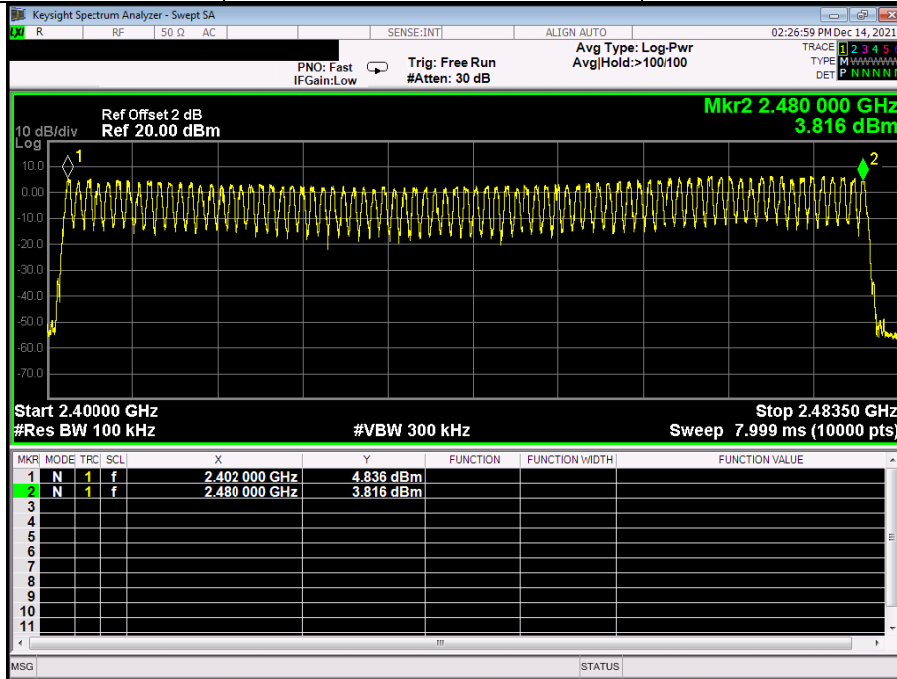

| Hopping Mode_3Mbps | | |
|-----------------------------|------------------------|-----------|
| Number of Hopping Frequency | Measurement result(CH) | Limit(CH) |
| | | 79 |

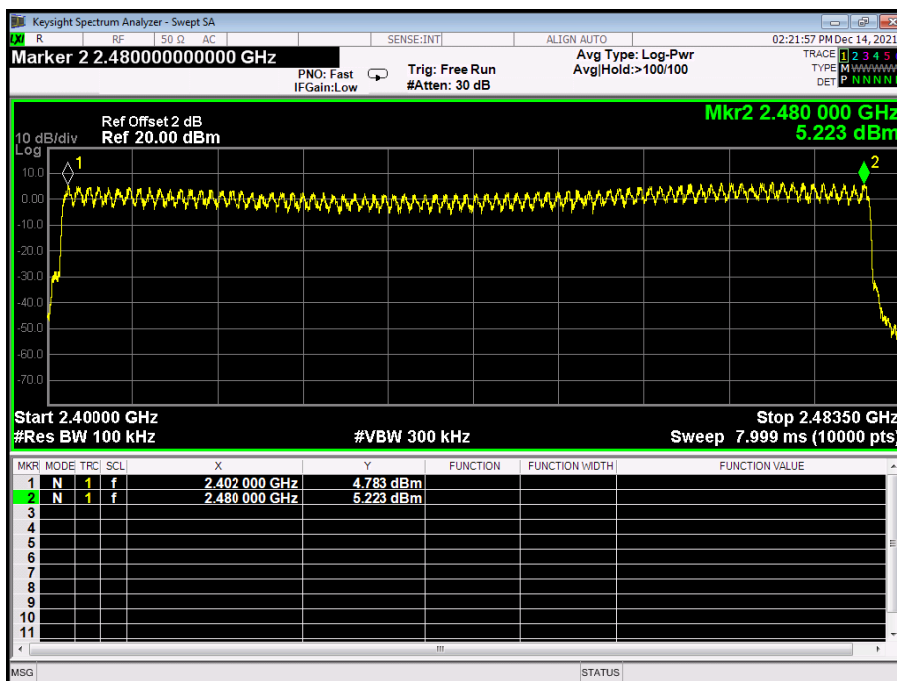

7.AVERAGE TIME OF OCCUPANCY

7.1LIMIT

| FCC Part15, Subpart C (15.247)&RSS-247 | | |
|--|---------------------------|--------|
| Section | Test Item | Limit |
| 15.247(a)(1)(iii) RSS-247 5.1 (d) | Average Time of Occupancy | 0.4sec |

7.2TEST PROCEDURE AND SETTING

- a. The transmitter output (antenna port) was connected to the spectrum analyzer
- b. Set RBW of spectrum analyzer to 1MHz and VBW to 1MHz
- c. Use a video trigger with the trigger level set to enable triggering only on full pulses
- d. Sweep Time is more than once pulse time
- e. Set the center frequency on any frequency would be measure and set the frequency span to zero span
- f. Measure the maximum time duration of one single pulse
- g. Set the EUT for DH1, DH3 and DH5 packet transmitting
- h. Measure the maximum time duration of one single pulse
- i. DH1 Packet permit maximum $1600 / 79 / 2 = 10.12$ hops per second in each channel (1 time slot TX, 1 time slot RX). So, the dwell time is the time duration of the pulse times $10.12 \times 31.6 = 320$ within 31.6 seconds
- j. DH3 Packet permit maximum $1600 / 79 / 4 = 5.06$ hops per second in each channel (3 time slots TX, 1 time slot RX). So, the dwell time is the time duration of the pulse times $5.06 \times 31.6 = 160$ within 31.6 seconds
- k. DH5 Packet permit maximum $1600 / 79 / 6 = 3.37$ hops per second in each channel (5 time slots TX, 1 time slot RX). So, the dwell time is the time duration of the pulse times $3.37 \times 31.6 = 106.6$ within 31.6 seconds

7.3MEASUREMENT INSTRUMENTS LIST

| Item | Kind of Equipment | Manufacturer | Type No. | Serial No. | Calibrated until |
|------|-------------------|---------------|-------------|------------|------------------|
| 1 | Spectrum analyzer | KEYSIGHT | N9010A | MY55150427 | 2022/05/28 |
| 2 | Attenuator | Mini-Circuits | BW-S10W2 | 101109 | N/A |
| 3 | RF Cable | Mi-cable | C10-01-01-1 | 100309 | N/A |

7.4TEST SETUP



7.5EUT OPERATION CONDITIONS

The EUT tested system was configured as the statements of 4.5 unless otherwise a special operating condition is specified in the follows during the testing.

7.6 TEST RESULTS

| TX Mode_1Mbps | | | | |
|---------------|-------------------------|-----------------|-----------------|------------|
| Mode | Channel Frequency (MHz) | Pulse Time (ms) | Dwell Time (ms) | Limit (ms) |
| DH1 | 2441 | 0.3996 | 125.9 | 400 |
| DH3 | 2441 | 1.648 | 264.0 | 400 |
| DH5 | 2441 | 2.904 | 309.6 | 400 |

DH1

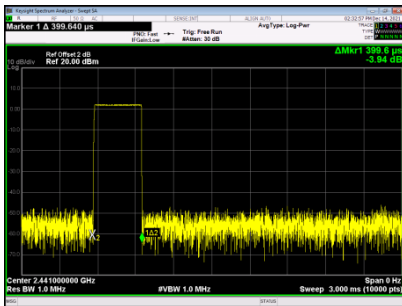

DH3

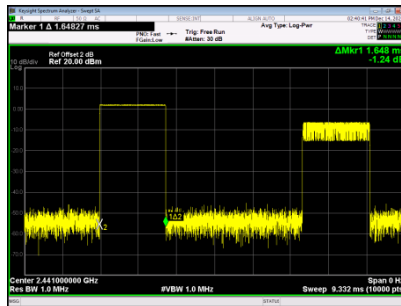

DH5

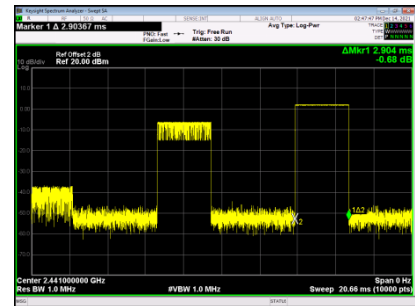

| TX Mode_3Mbps | | | | |
|---------------|-------------------------|-----------------|-----------------|------------|
| Mode | Channel Frequency (MHz) | Pulse Time (ms) | Dwell Time (ms) | Limit (ms) |
| DH1 | 2441 | 0.4023 | 128.2 | 400 |
| DH3 | 2441 | 1.657 | 264.2 | 400 |
| DH5 | 2441 | 2.906 | 310.3 | 400 |

2441MHzDH1

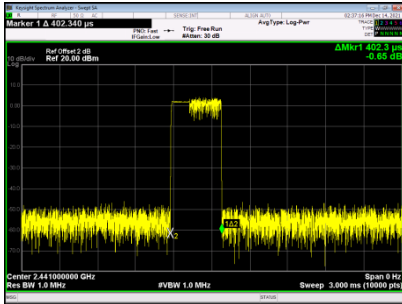

2441MHzDH3

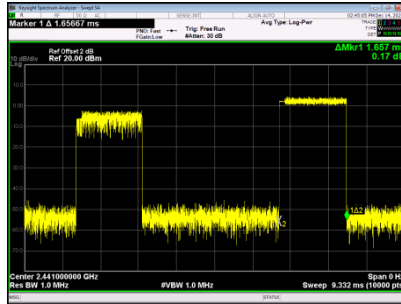

2441MHzDH5

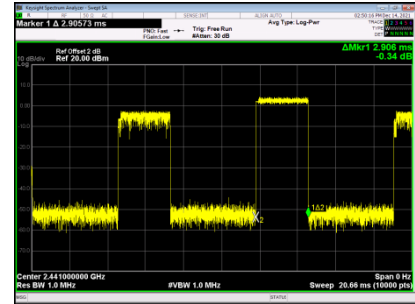

8 HOPPING CHANNEL SEPARATION MEASUREMENT

8.1 LIMIT

Frequency hopping systems operating in the 2400-2483.5 MHz band may have hopping channel carrier frequencies that are separated by 25 kHz or two-thirds of the 20 dB bandwidth of the hopping channel, whichever is greater, provided the systems operate with an output power no greater than 125 mW.

8.2 TEST PROCEDURE AND SETTING

- a. The EUT was directly connected to the spectrum analyzer and antenna output port as show in the block diagram below.
- b. Span = wide enough to capture the peaks of two adjacent channels
 Resolution (or IF) Bandwidth (RBW) \geq 1% of the span
 Video (or Average) Bandwidth (VBW) \geq RBW
 Sweep = Auto
 Detector function = Peak
 Trace = Max Hold

| Spectrum Parameter | Setting |
|--------------------|---|
| Attenuation | Auto |
| Span Frequency | > Measurement Bandwidth or Channel Separation |
| RBW | 10 kHz |
| VBW | 30 kHz |
| Detector | Peak |
| Trace | Max Hold |
| Sweep Time | Auto |

8.3 MEASUREMENT INSTRUMENTS LIST

| Item | Kind of Equipment | Manufacturer | Type No. | Serial No. | Calibrated until |
|------|-------------------|---------------|-------------|------------|------------------|
| 1 | Spectrum analyzer | KEYSIGHT | N9010A | MY55150427 | 2022/05/28 |
| 2 | Attenuator | Mini-Circuits | BW-S10W2 | 101109 | N/A |
| 3 | RF Cable | Mi-cable | C10-01-01-1 | 100309 | N/A |

8.4 TEST SETUP



8.5 EUT OPERATION CONDITIONS

The EUT tested system was configured as the statements of 4.5 unless otherwise a special operating condition is specified in the follows during the testing.

8.6 TEST RESULTS

| TX Mode_1Mbps | | | | |
|---------------|-----------------|-------------------------|--------------------------------|--------|
| Channel | Frequency (MHz) | Channel Separation(MHz) | Limit (MHz) | Result |
| CH00 | 2402 | 1.0000 | >(25KHz or 2/3*20dB Bandwidth) | PASS |
| CH39 | 2441 | 1.0006 | >(25KHz or 2/3*20dB Bandwidth) | PASS |
| CH78 | 2480 | 0.9985 | >(25KHz or 2/3*20dB Bandwidth) | PASS |

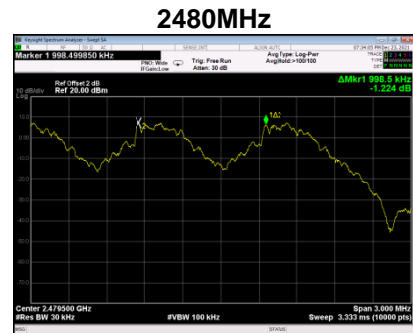
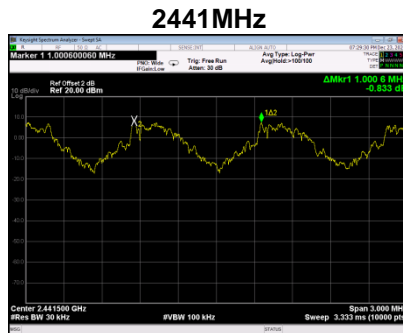
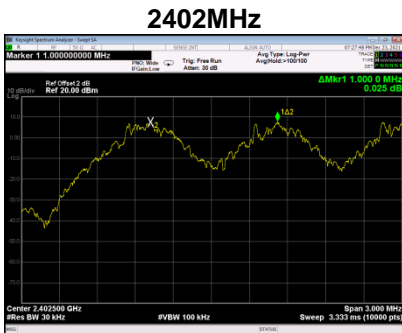

| TX Mode_3Mbps | | | | |
|---------------|-----------------|-------------------------|--------------------------------|--------|
| Channel | Frequency (MHz) | Channel Separation(MHz) | Limit (MHz) | Result |
| CH00 | 2402 | 0.9871 | >(25KHz or 2/3*20dB Bandwidth) | PASS |
| CH39 | 2441 | 1.0030 | >(25KHz or 2/3*20dB Bandwidth) | PASS |
| CH78 | 2480 | 0.9988 | >(25KHz or 2/3*20dB Bandwidth) | PASS |

2402MHz

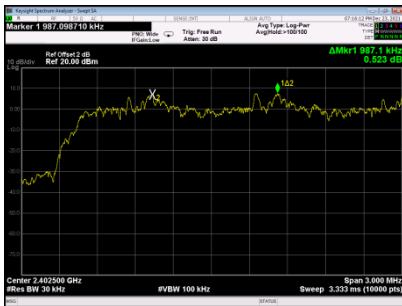

2441MHz

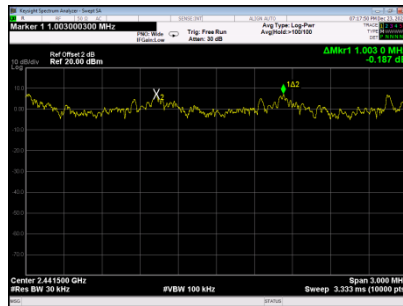

2480MHz

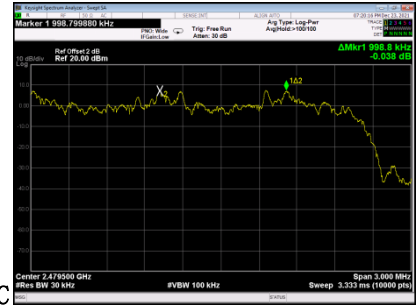

9 BANDWIDTH TEST

9.1 LIMIT

| FCC Part15, Subpart C (15.247)&RSS-247 | |
|--|-----------|
| Section | Test Item |
| 15.247(a)(1) RSS-Gen 6.7 RSS-247 5.1 (a) | Bandwidth |

9.2 TEST PROCEDURE AND SETTING

- a. The EUT was directly connected to the spectrum analyzer and antenna output port as show in the block diagram below.
- b. Spectrum Setting: RBW= 30 kHz, VBW=100 kHz, Sweep Time = Auto.

| Spectrum Parameter | Setting |
|--------------------|-------------------------|
| Attenuation | Auto |
| Span Frequency | > Measurement Bandwidth |
| RBW | 30kHz |
| VBW | 100kHz |
| Detector | Peak |
| Trace | Max Hold |
| Sweep Time | Auto |

9.3 MEASUREMENT INSTRUMENTS LIST

| Item | Kind of Equipment | Manufacturer | Type No. | Serial No. | Calibrated until |
|------|-------------------|---------------|-------------|------------|------------------|
| 1 | Spectrum analyzer | KEYSIGHT | N9010A | MY55150427 | 2022/05/28 |
| 2 | Attenuator | Mini-Circuits | BW-S10W2 | 101109 | N/A |
| 3 | RF Cable | Mi-cable | C10-01-01-1 | 100309 | N/A |

9.4 TEST SETUP

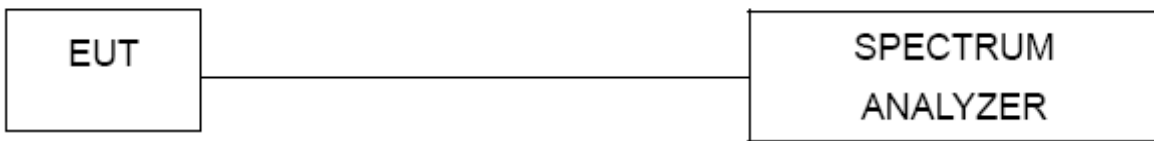

9.5 EUT OPERATION CONDITIONS

The EUT tested system was configured as the statements of 4.5 unless otherwise a special operating condition is specified in the follows during the testing.

9.6 TEST RESULTS

| TX Mode_1Mbps | | | | |
|---------------|-----------------|----------------------|-------------------------------|--------|
| Channel | Frequency (MHz) | 20dB Bandwidth (MHz) | 99 % Emission Bandwidth (MHz) | Result |
| CH00 | 2402 | 0.9224 | 0.8469 | PASS |
| CH39 | 2441 | 0.9230 | 0.8493 | PASS |
| CH78 | 2480 | 0.8873 | 0.8440 | PASS |

2402MHz

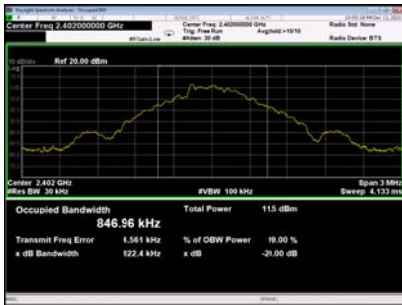

2441MHz

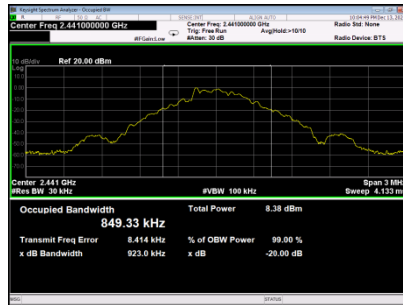

2480MHz



| TX Mode_3Mbps | | | | |
|---------------|-----------------|----------------------|-------------------------------|--------|
| Channel | Frequency (MHz) | 20dB Bandwidth (MHz) | 99 % Emission Bandwidth (MHz) | Result |
| CH00 | 2402 | 1.261 | 1.1739 | PASS |
| CH39 | 2441 | 1.268 | 1.1696 | PASS |
| CH78 | 2480 | 1.270 | 1.1809 | PASS |

2402MHz

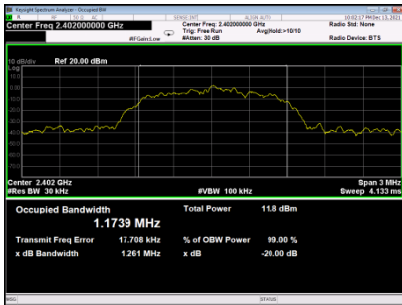

2441MHz

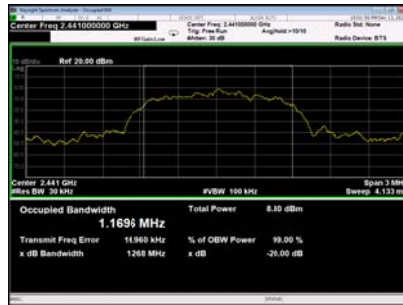

2480MHz

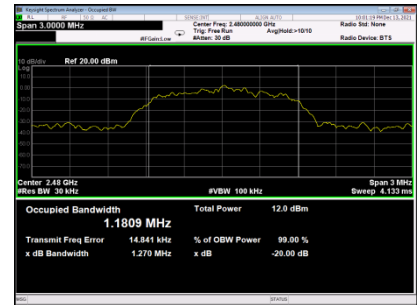

10 MAXIMUM OUTPUT POWER

10.1 LIMIT

| FCC Part15 , Subpart C (15.247)&RSS-247 | | |
|---|----------------------|--------------------|
| Section | Test Item | Limit |
| 15.247(a)(1) RSS-247 5.1 (b) | Maximum Output Power | 0.125Watt or 21dBm |

Note:

Frequency hopping systems shall have hopping channel carrier frequencies separated by a minimum of 25 kHz or the 20 dB bandwidth of the hopping channel, whichever is greater. Alternatively, frequency hopping systems operating in the 2400-2483.5 MHz band may have hopping channel carrier frequencies that are separated by 25 kHz or two-thirds of the 20 dB bandwidth of the hopping channel, whichever is greater, provided the systems operate with an output power no greater than 125 mW.

10.2 TEST PROCEDURE AND SETTING

- a. The EUT was directly connected to the spectrum analyzer and antenna output port as show in the block diagram below.
- b. Spectrum Setting: RBW= 1MHz/3MHz, VBW= 1MHz/3MHz, Sweep time = Auto.

10.3 MEASUREMENT INSTRUMENTS LIST

| Item | Kind of Equipment | Manufacturer | Type No. | Serial No. | Calibrated until |
|------|-------------------|---------------|-------------|------------|------------------|
| 1 | Spectrum analyzer | KEYSIGHT | N9010A | MY55150427 | 2022/05/28 |
| 2 | Attenuator | Mini-Circuits | BW-S10W2 | 101109 | N/A |
| 3 | RF Cable | Mi-cable | C10-01-01-1 | 100309 | N/A |

10.4 TEST SETUP



10.5 EUT OPERATION CONDITIONS

The EUT tested system was configured as the statements of 4.5 unless otherwise a special operating condition is specified in the follows during the testing.

10.6 TEST RESULTS

| TX Mode_1Mbps | | | | |
|---------------|-----------------|--------------------|------------------|--------|
| Channel | Frequency (MHz) | Output Power (dBm) | Output Power (W) | Result |
| CH00 | 2402 | 8.096 | 0.006450 | PASS |
| CH39 | 2441 | 7.902 | 0.006169 | PASS |
| CH78 | 2480 | 7.682 | 0.005864 | PASS |
| Limit | 21dBm /0.125W | | | |

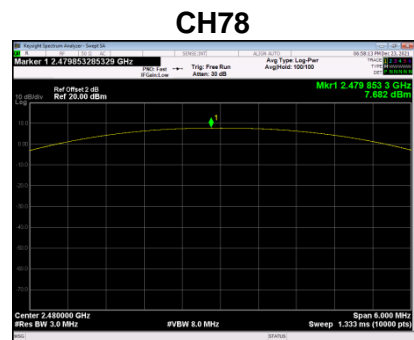
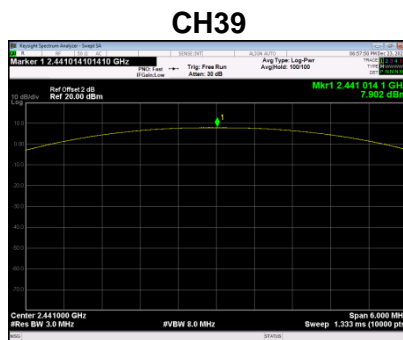
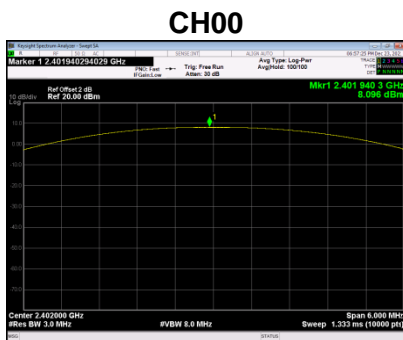

| TX Mode_2Mbps | | | | |
|---------------|-----------------|--------------------|------------------|--------|
| Channel | Frequency (MHz) | Output Power (dBm) | Output Power (W) | Result |
| CH00 | 2402 | 9.056 | 0.008046 | PASS |
| CH39 | 2441 | 8.851 | 0.007675 | PASS |
| CH78 | 2480 | 8.818 | 0.007617 | PASS |
| Limit | 21dBm /0.125W | | | |

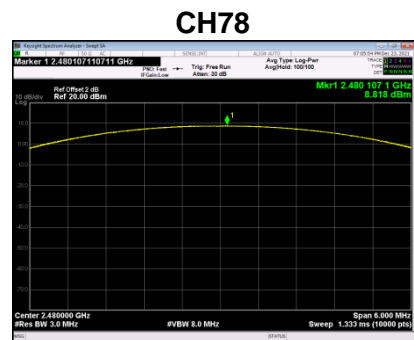
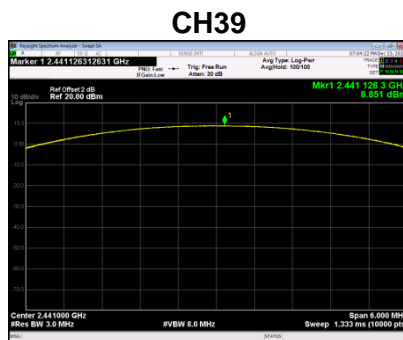
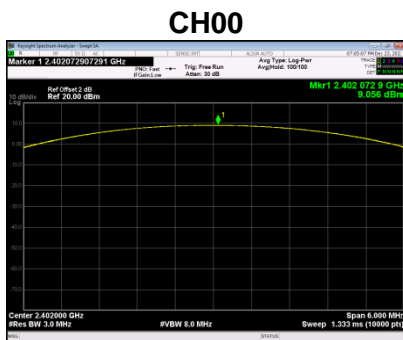

| TX Mode_3Mbps | | | | |
|---------------|-----------------|--------------------|------------------|--------|
| Channel | Frequency (MHz) | Output Power (dBm) | Output Power (W) | Result |
| CH00 | 2402 | 9.511 | 0.008935 | PASS |
| CH39 | 2441 | 9.360 | 0.008630 | PASS |
| CH78 | 2480 | 9.516 | 0.008945 | PASS |
| Limit | 21dBm /0.125W | | | |

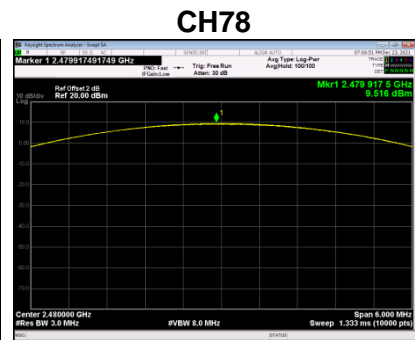
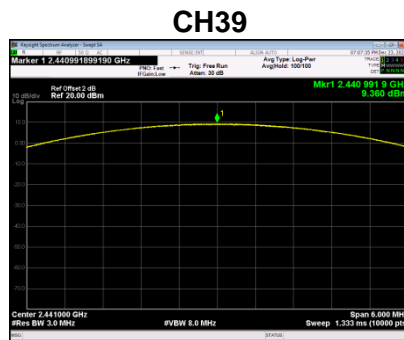
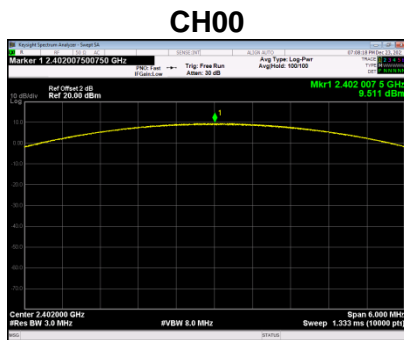

11 CONDUCTED SPURIOUS EMISSION

11.1 LIMIT

For FCC

In any 100 kHz bandwidth outside the frequency band in which the spread spectrum or digitally modulated intentional radiator is operating, the radio frequency power that is produced by the intentional radiator shall be at least 20 dB below that in the 100 kHz bandwidth within the band that contains the highest level of the desired power, based on either an RF conducted or a radiated measurement, provided the transmitter demonstrates compliance with the peak Output Power limits. If the transmitter complies with the Output Power limits based on the use of RMS averaging over a time interval, as permitted under paragraph (b)(3) of this section, the attenuation required under this paragraph shall be 30 dB instead of 20 dB. Attenuation below the general limits specified in Section 15.209(a) is not required.

For ISSED

In any 100 kHz bandwidth outside the frequency band in which the spread spectrum or digitally modulated device is operating, the RF power that is produced shall be at least 20 dB below that in the 100 kHz bandwidth within the band that contains the highest level of the desired power, based on either an RF conducted or a radiated measurement, provided that the transmitter demonstrates compliance with the peak Output Power limits. If the transmitter complies with the Output Power limits based on the use of root-mean-square averaging over a time interval, as permitted under section 5.4(d), the attenuation required shall be 30 dB instead of 20 dB. Attenuation below the general field strength limits specified in RSS-Gen is not required.

11.2 TEST PROCEDURE AND SETTING

- a. The EUT was directly connected to the spectrum analyzer and antenna output port as show in the block diagram below.
- b. Spectrum Setting: RBW= 100 kHz, VBW=300 kHz, Sweep time = Auto.

11.3 MEASUREMENT INSTRUMENTS LIST

| Item | Kind of Equipment | Manufacturer | Type No. | Serial No. | Calibrated until |
|------|-------------------|---------------|-------------|------------|------------------|
| 1 | Spectrum analyzer | KEYSIGHT | N9010A | MY55150427 | 2022/05/28 |
| 2 | Attenuator | Mini-Circuits | BW-S10W2 | 101109 | N/A |
| 3 | RF Cable | Mi-cable | C10-01-01-1 | 100309 | N/A |

11.4 TEST SETUP

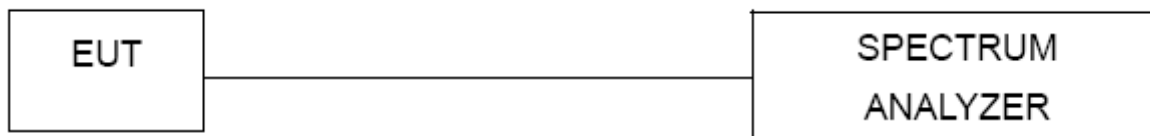

11.5 EUT OPERATION CONDITIONS

The EUT tested system was configured as the statements of 4.5 unless otherwise a special operating condition is specified in the follows during the testing.

11.6 TEST RESULTS

TX Mode_1Mbps

Bandedge- CH00 (Lower)

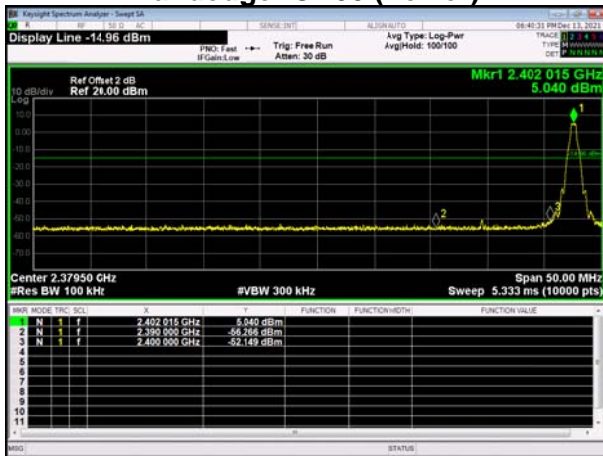

Bandedge CH78 (Upper)

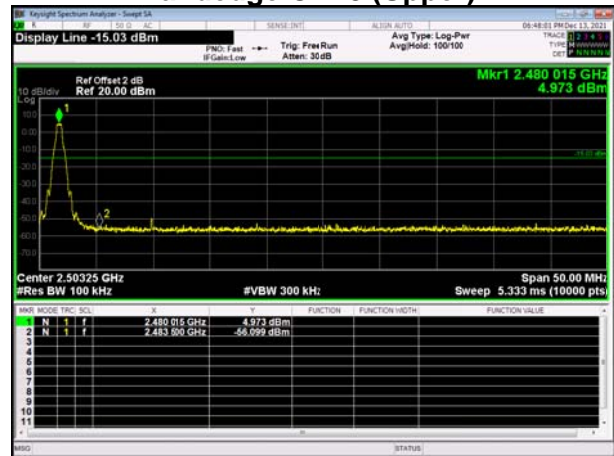

Bandedge- Hopping on (Lower)

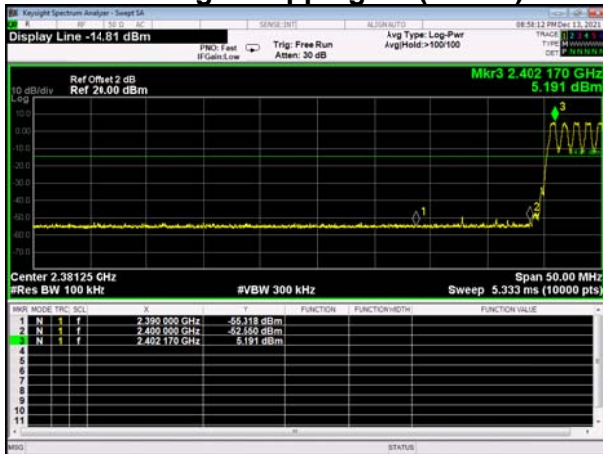

Bandedge Hopping on (Upper)

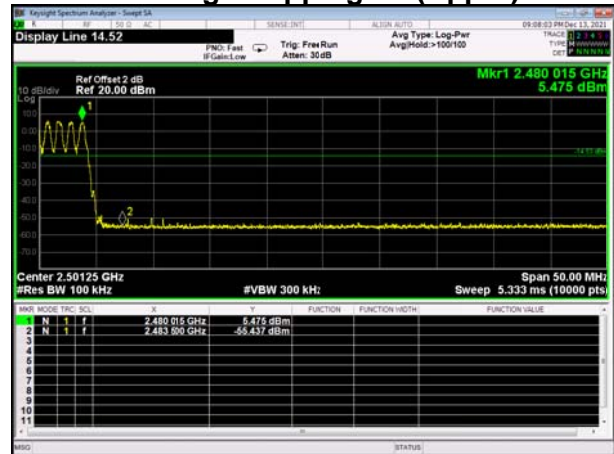

10th Harmonic of the fundamental frequency

CH00

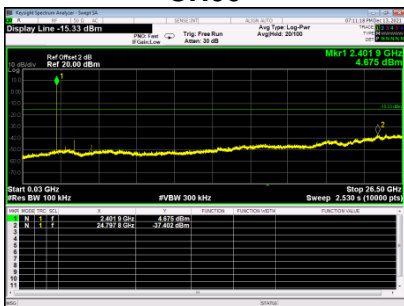

CH39

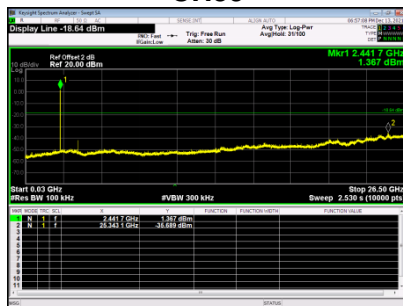

CH78

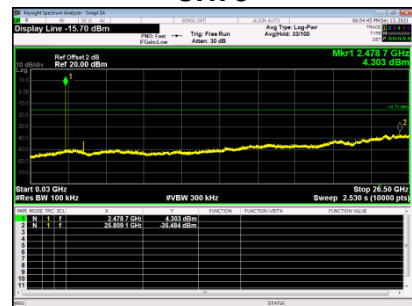

TX Mode_3Mbps

Bandedge- CH00 (Lower)

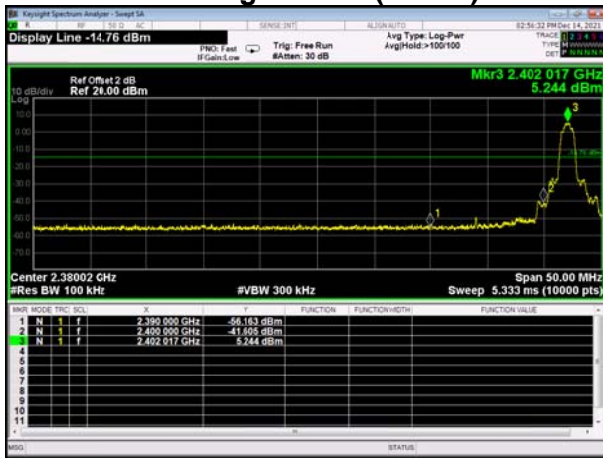

Bandedge CH78 (Upper)

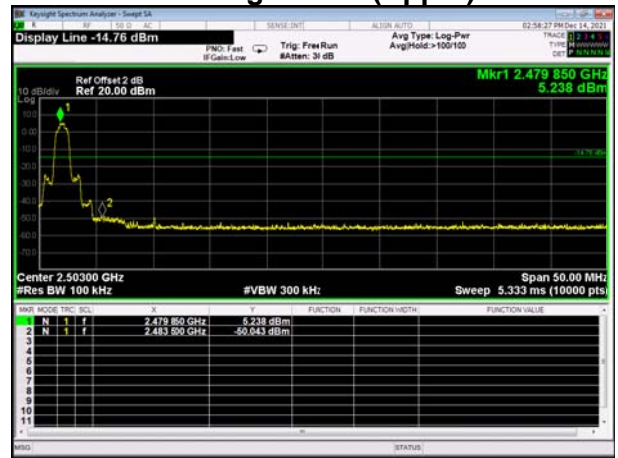

Bandedge- Hopping on (Lower)

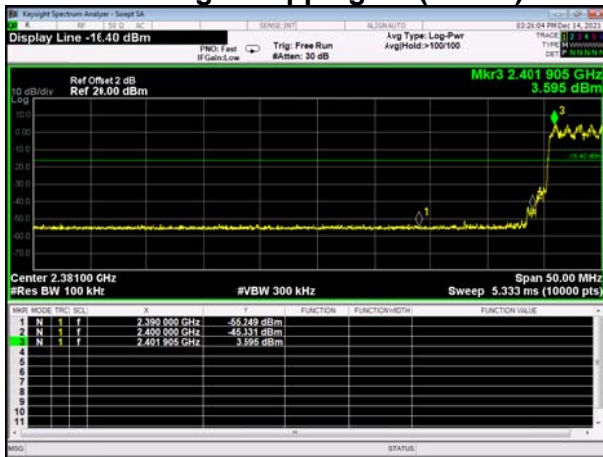

Bandedge- Hopping on (Upper)



**10th Harmonic of the fundamental frequency
CH00**

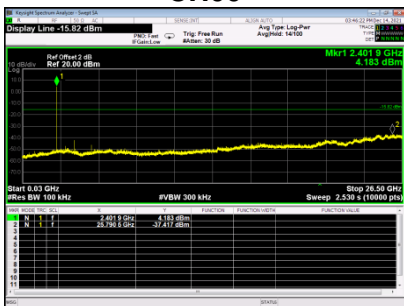

CH39

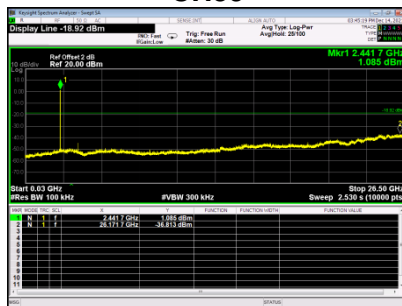

CH78

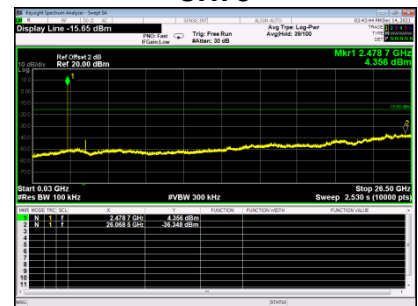

12 FREQUENCY STABILITY MEASUREMENT

12.1 LIMIT

| RSS-Gen | | | |
|--------------|---------------------|--------------------------------|-----------------------|
| Section | Test Item | Limit | Frequency Range (MHz) |
| RSS-Gen 6.11 | Frequency Stability | Specified in the user's manual | 2402-2480 |

12.2 TEST PROCEDURE

- a. The EUT was directly connected to the spectrum analyzer and antenna output port as show in the block diagram below.
- b. Spectrum Setting:

| Spectrum Parameter | Setting |
|--------------------|--|
| Attenuation | Auto |
| Span Frequency | Entire absence of modulation emissions bandwidth |
| RBW | 10 kHz |
| VBW | 10kHz |
| Sweep Time | Auto |

12.3 MEASUREMENT INSTRUMENTS LIST

| Item | Kind of Equipment | Manufacturer | Type No. | Serial No. | Calibrated until |
|------|--------------------------|-------------------|-------------|---------------|------------------|
| 1 | Spectrum analyzer | KEYSIGHT | N9010A | MY55150427 | 2022/05/28 |
| 2 | Attenuator | Mini-Circuits | BW-S10W2 | 101109 | N/A |
| 3 | RF Cable | Mi-cable | C10-01-01-1 | 100309 | N/A |
| 4 | Temperature conditioning | Guan Jian.HTH1000 | -20-130°C | GJ1000-10D001 | N/A |
| 5 | DC Power Supply | G.KE | IPR-10010D | 010931954 | N/A |

12.4 TEST SETUP

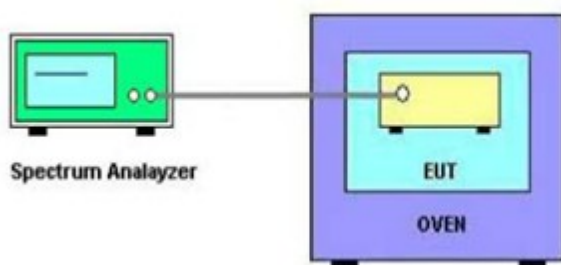

12.5 EUT OPERATION CONDITIONS

The EUT was programmed to be in continuously transmitting mode.

12.6 TEST RESULTS

| | Temperature vs. Frequency Stability | |
|----------------------|-------------------------------------|-----------------------------|
| Voltage | Temperature | Measurement Frequency (MHz) |
| 14.4V | (°C) | 2402 |
| | -20 | 2402.009031 |
| | 25 | 2402.008991 |
| | 50 | 2402.009211 |
| 10.8V | 25 | 2402.008992 |
| Max. Deviation (MHz) | | 0.009221 |
| Max. Deviation (ppm) | | 3.839 |

Note: 10.8V is the end point voltage, and products below 10.8V will cease working.

END OF TEST REPORT