

Inverted F Antenna Specification

MANUFACTURE : SHANGHAI MOUNTAIN VIEW SILICON CO., LTD

PRODUCT NAME : MV_BP10xx PCB Antenna

DATE : 2019-10-30

1. Antenna describe

Antenna plate: Inverted F Antenna

Frequency range: 2.4GHz-2.48GHz

ITEM Name	Inverted F Antenna Specification
Model Name	2.4GHz Antenna
Polarization	Horizontal and Vertical
Azimuth Beam Pattern	Omni-directional
Impedance	50 Ohm
Antenna Lengh	14.4mm
Gain(Max)	2.81(±1 dBi)

2. Antenna Photo& Lengh (mm)

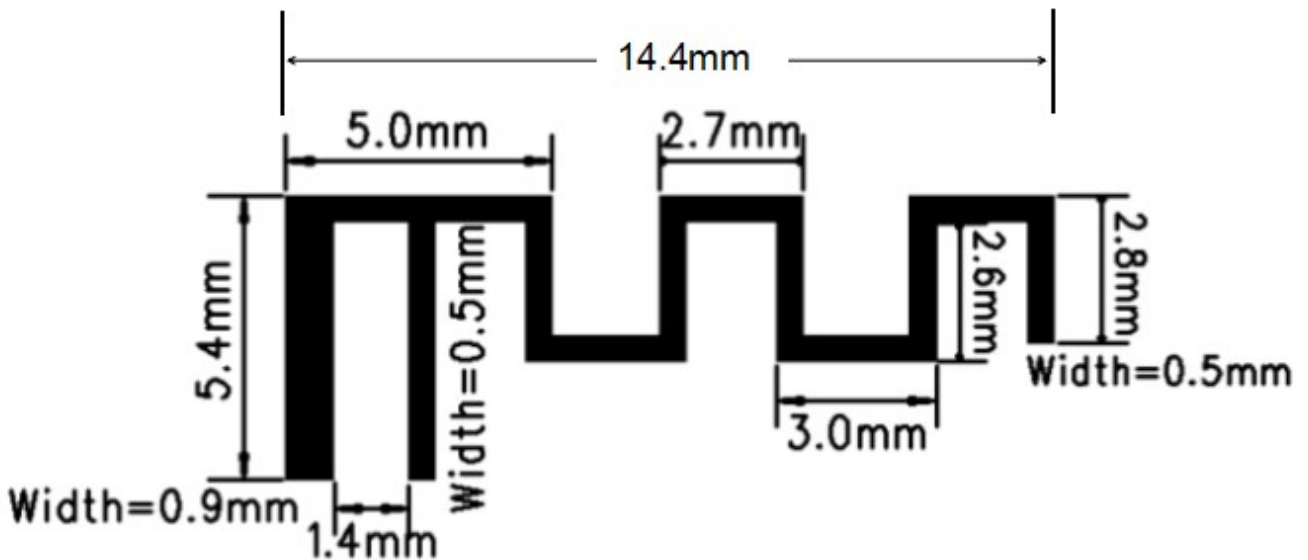

Actual Size

3. Gain

Frequency	Gain (dBi)
2400MHz	2.81
2410MHz	2.74
2420MHz	2.70
2430MHz	2.73
2440MHz	1.01
2450MHz	1.26
2460MHz	1.50
2470MHz	1.49
2480MHz	1.42
2490MHz	0.36
2500MHz	0.33

4. Return Loss/VSWR/Input Impedance

Frequency	Return Loss (dB)	VSWR	Input Impedance(Ω)
2400MHz	-7.23	2.53	25.37
2400MHz	-6.47	2.80	17.99
2450MHz	-6.22	2.90	17.18
2480MHz	-5.18	3.44	15.55
2500MHz	-4.56	3.89	15.48

Annex A Photographs

1. Test Setup

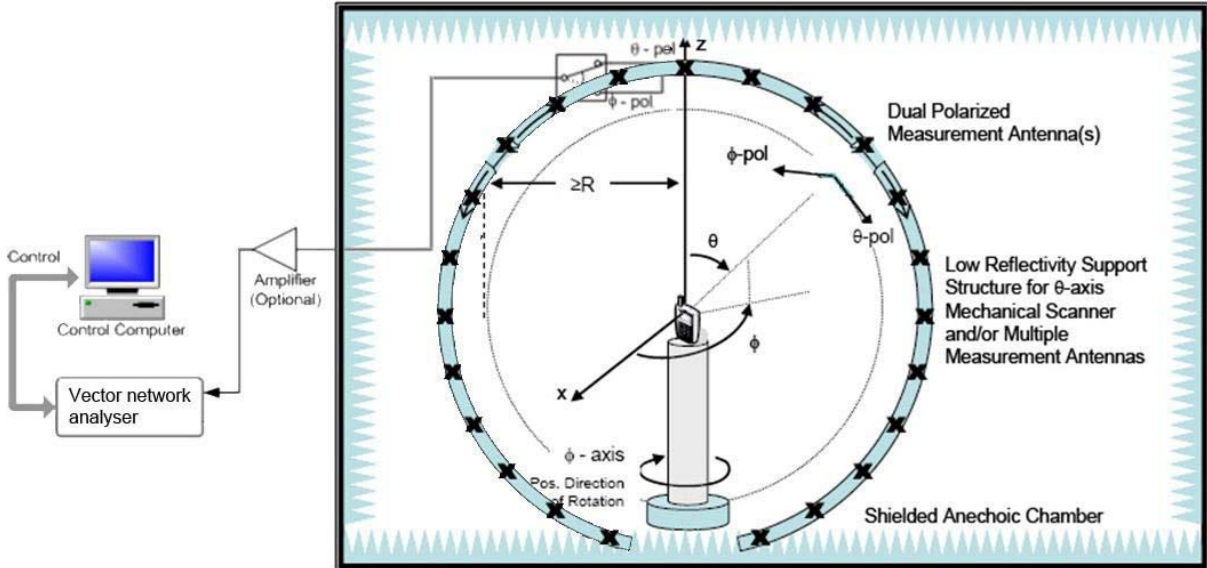

Annex B Figures

1. 2D Radiation Pattern

Phi=0°

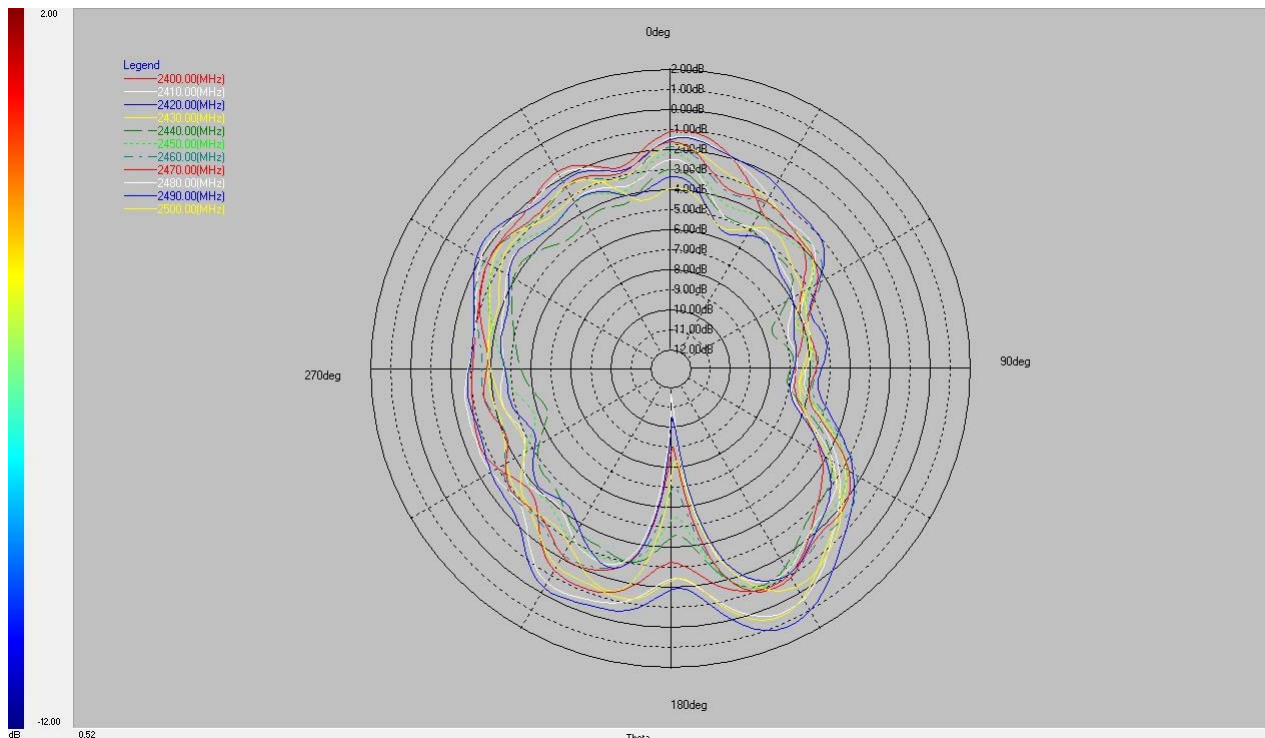

Phi=90°

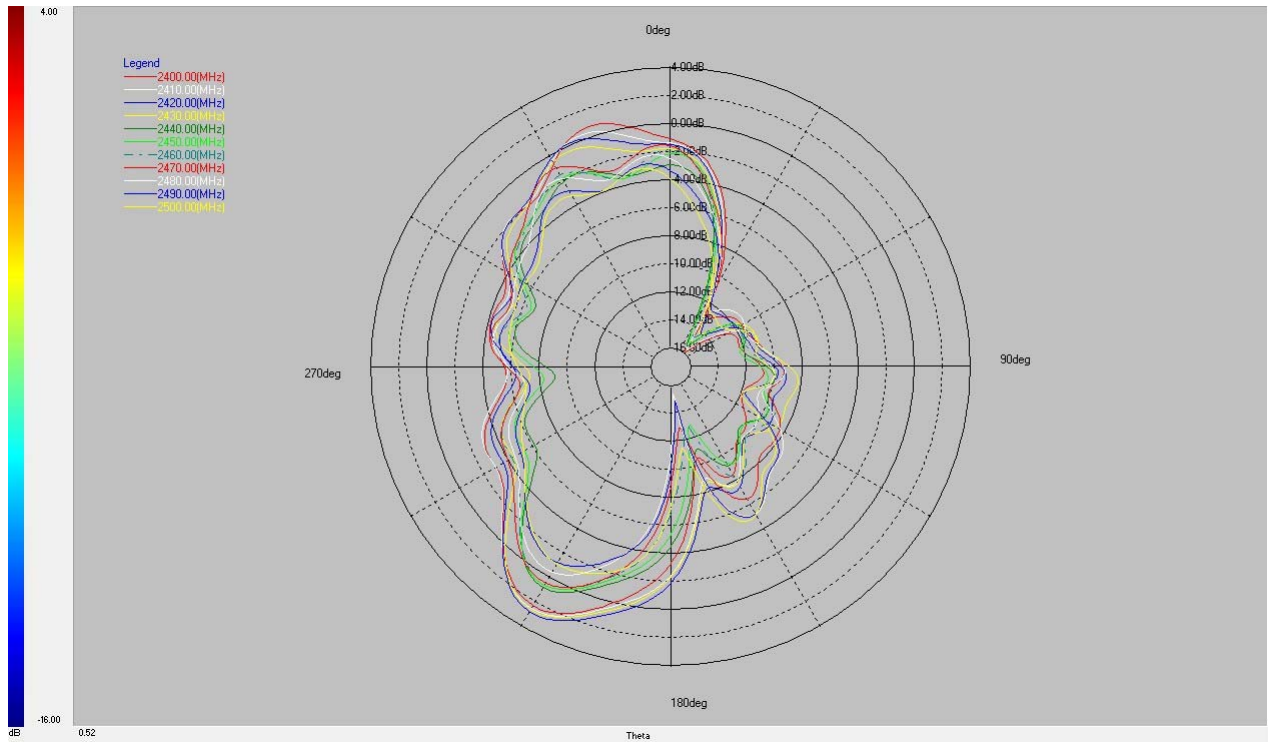

Theta=90°

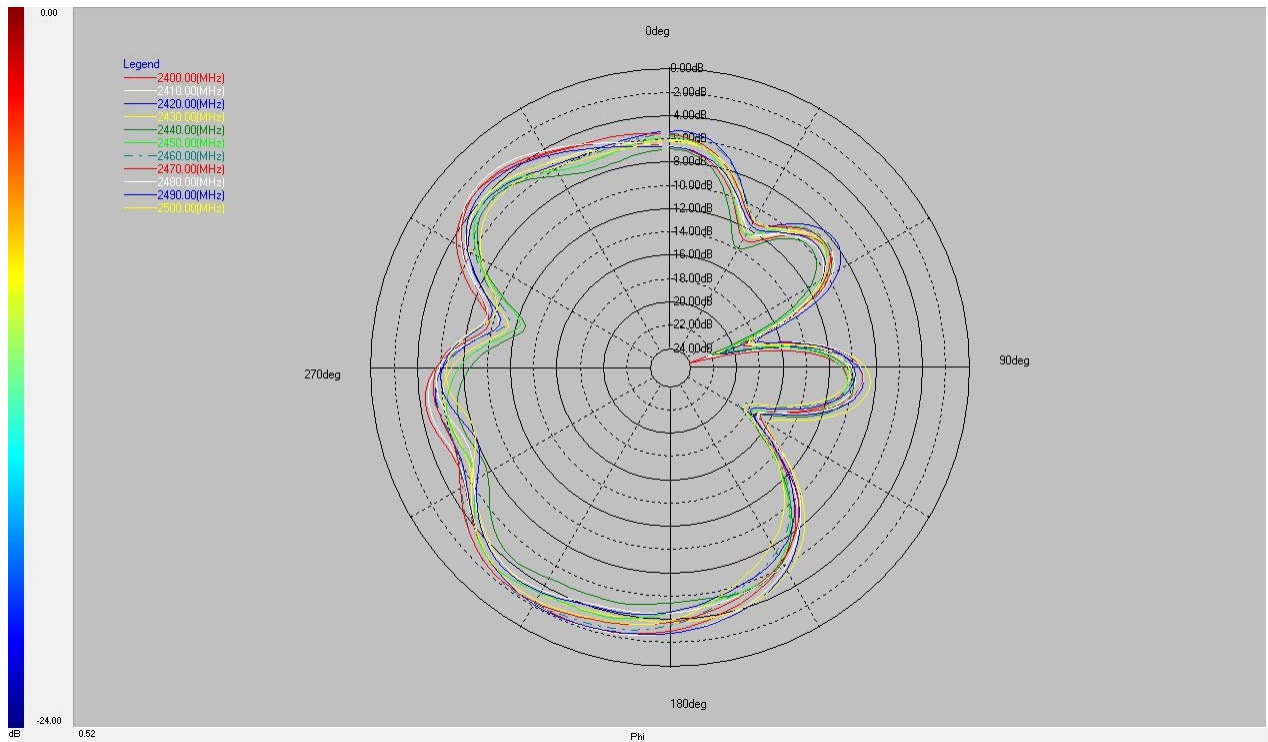

2. 3D Radiation Pattern

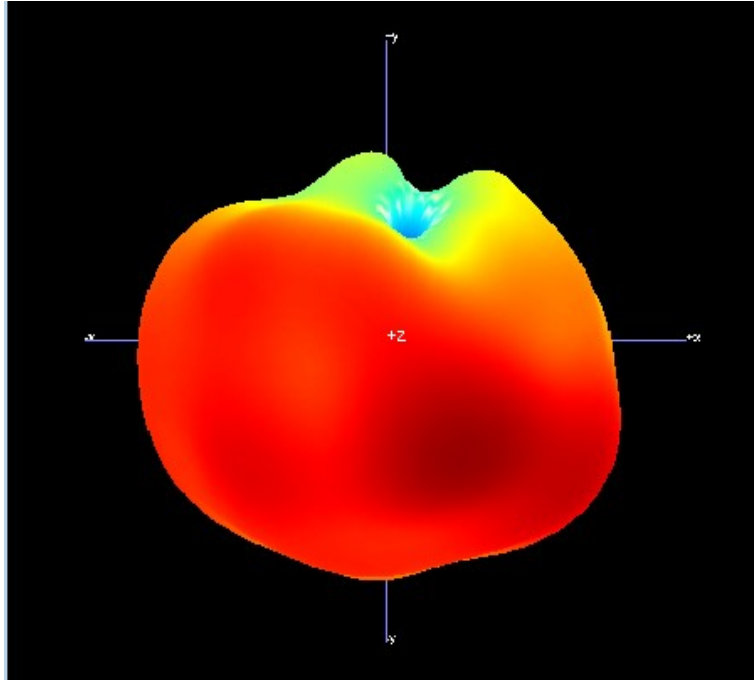

2400MHz

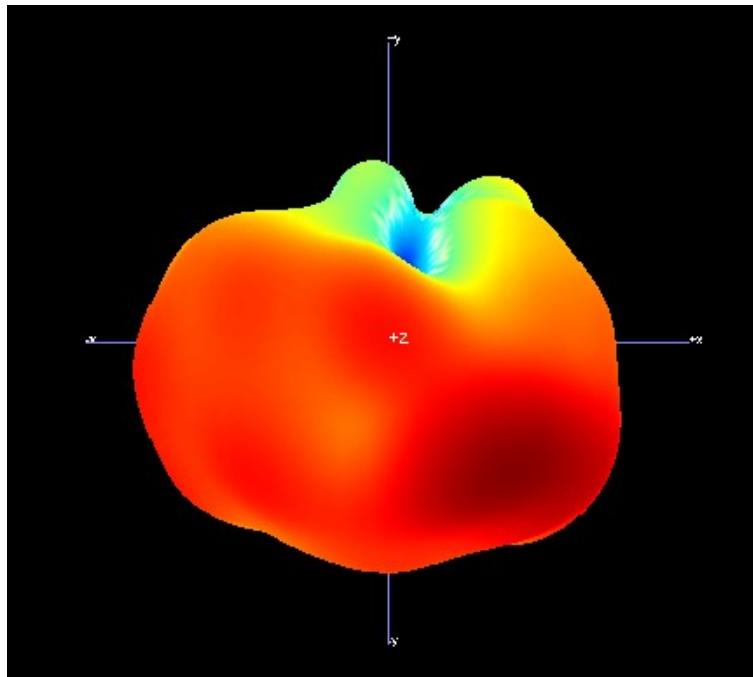

2450MHz

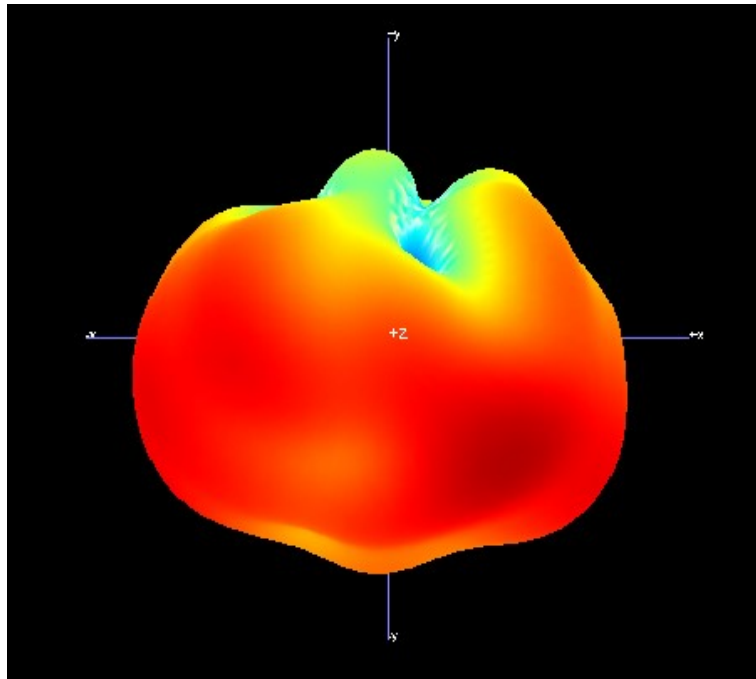

2500MH

3. Return Loss



4. VSWR

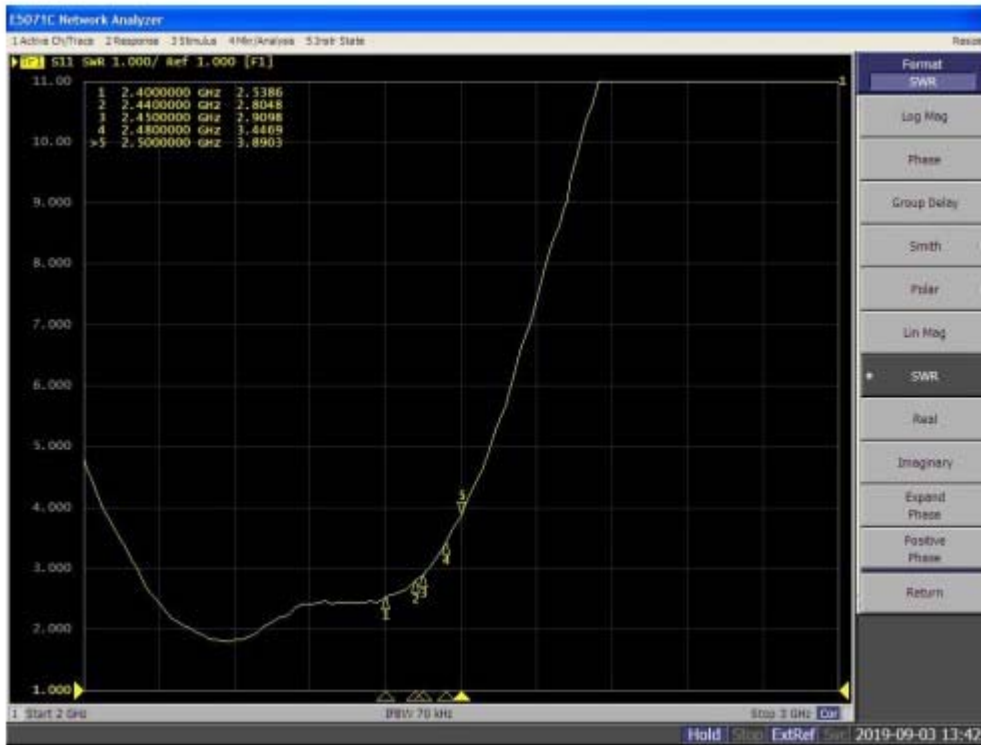

END