



# FCC Part 15C Test Report

## FCC ID:2AD99B008D

|                  |  |
|------------------|--|
| Product Name:    | IP Video Indoor Station  |
| Trademark:       | DoorBird   |
| Model Name :     | A1101  |
| Prepared For :   | Bird Home Automation GmbH  |
| Address :        | Uhlandstr. 165, Berlin, Germany, 10719   |
| Prepared By :    | Shenzhen BCTC Testing Co., Ltd.  |
| Address :        | BCTC Building & 1-2F, East of B Building, Pengzhou Industrial, Fuyuan 1st Road, Qiaotou Community, Fuyong Street, Bao'an District, Shenzhen, China |
| Test Date:       | Jul. 10, 2020 to Aug. 21, 2020   |
| Date of Report : | Aug. 21, 2020  |
| Report No.:      | BCTC2006000408E  |



### TEST RESULT CERTIFICATION

**Applicant's name** ..... Bird Home Automation GmbH  
 Address ..... Uhlandstr. 165, Berlin, Germany, 10719  
**Manufacture's Name** ..... Bird Home Automation GmbH  
 Address ..... Uhlandstr. 165, Berlin, Germany, 10719

**Product description**

Product name..... IP Video Indoor Station  
 Trademark ..... DoorBird

Model and/or type reference A1101

**Standards** ..... FCC Part15.247  
 ANSI C63.10:2013  
 KDB 558074

This device described above has been tested by BCTC, and the test results show that the equipment under test (EUT) is in compliance with the FCC requirements. And it is applicable only to the tested sample identified in the report.

This report shall not be reproduced except in full, without the written approval of BCTC, this document may be altered or revised by BCTC, personal only, and shall be noted in the revision of the document.

Tested by:

*Sam Zeng*

Sam zeng/Project Handler

Approved by:



Zero Zhou/Reviewer



| <b>Table of Contents</b>                                    | <b>Page</b> |
|---|-------------|
| <b>1 . SUMMARY OF TEST RESULTS</b>                          | <b>5</b>    |
| 1.1 TEST FACILITY   | 6           |
| 1.2 MEASUREMENT UNCERTAINTY                                 | 6           |
| <b>2 . GENERAL INFORMATION</b>                              | <b>7</b>    |
| 2.1 GENERAL DESCRIPTION OF EUT                              | 7           |
| 2.2 DESCRIPTION OF TEST MODES                               | 8           |
| 2.3 BLOCK DIGRAM SHOWING THE CONFIGURATION OF SYSTEM TESTED | 9           |
| 2.4 DESCRIPTION OF SUPPORT UNITS(CONDUCTED MODE)            | 9           |
| 2.5 EQUIPMENTS LIST FOR ALL TEST ITEMS                      | 10          |
| <b>3 . EMC EMISSION TEST</b>                                | <b>12</b>   |
| 3.1 CONDUCTED EMISSION MEASUREMENT                          | 12          |
| 3.1.1 POWER LINE CONDUCTED EMISSION LIMITS                  | 12          |
| 3.1.2 TEST PROCEDURE  | 12          |
| 3.1.3 DEVIATION FROM TEST STANDARD                          | 12          |
| 3.1.4 TEST SETUP  | 13          |
| 3.1.5 EUT OPERATING CONDITIONS                              | 13          |
| 3.1.6 TEST RESULTS  | 14          |
| 3.2 RADIATED EMISSION MEASUREMENT                           | 16          |
| 3.2.1 RADIATED EMISSION LIMITS                              | 16          |
| 3.2.2 TEST PROCEDURE  | 17          |
| 3.2.3 DEVIATION FROM TEST STANDARD                          | 17          |
| 3.2.4 TEST SETUP  | 17          |
| 3.2.5 EUT OPERATING CONDITIONS                              | 18          |
| 3.2.6 TEST RESULTS (BETWEEN 9KHZ – 30 MHZ)                  | 19          |
| 3.2.7 TEST RESULTS (BETWEEN 30MHZ – 1GHZ)                   | 20          |
| 3.2.8 TEST RESULTS (1GHZ~25GHZ)                             | 22          |
| 3.3 RADIATED BAND EMISSION MEASUREMENT                      | 26          |
| 3.3.1 TEST REQUIREMENT:                                     | 26          |
| 3.3.2 TEST PROCEDURE  | 26          |
| 3.3.3 DEVIATION FROM TEST STANDARD                          | 27          |
| 3.3.4 TEST SETUP  | 27          |
| 3.3.5 EUT OPERATING CONDITIONS                              | 27          |
| <b>4 . POWER SPECTRAL DENSITY TEST</b>                      | <b>29</b>   |
| 4.1 APPLIED PROCEDURES / LIMIT                              | 29          |
| 4.1.1 TEST PROCEDURE  | 29          |



| <b>Table of Contents</b>                            | <b>Page</b> |
|---|-------------|
| 4.1.2 DEVIATION FROM STANDARD                       | 29          |
| 4.1.3 TEST SETUP                                    | 29          |
| 4.1.4 EUT OPERATION CONDITIONS                      | 29          |
| 4.1.5 TEST RESULTS                                  | 30          |
| <b>5 . BANDWIDTH TEST</b>                           | <b>38</b>   |
| 5.1 APPLIED PROCEDURES / LIMIT                      | 38          |
| 5.1.1 TEST PROCEDURE                                | 38          |
| 5.1.2 DEVIATION FROM STANDARD                       | 38          |
| 5.1.3 TEST SETUP                                    | 38          |
| 5.1.4 EUT OPERATION CONDITIONS                      | 38          |
| 5.1.5 TEST RESULTS                                  | 39          |
| <b>6 . PEAK OUTPUT POWER TEST</b>                   | <b>47</b>   |
| 6.1 APPLIED PROCEDURES/LIMIT                        | 47          |
| 6.1.1 TEST PROCEDURE                                | 47          |
| 6.1.2 DEVIATION FROM STANDARD                       | 47          |
| 6.1.3 TEST SETUP                                    | 47          |
| 6.1.4 EUT OPERATION CONDITIONS                      | 47          |
| 6.1.5 TEST RESULTS                                  | 48          |
| <b>7 . 100 KHZ BANDWIDTH OF FREQUENCY BAND EDGE</b> | <b>49</b>   |
| 7.1 APPLICABLE STANDARD                             | 49          |
| 7.2 TEST PROCEDURE                                  | 49          |
| 7.3 DEVIATION FROM STANDARD                         | 49          |
| 7.4 TEST SETUP                                      | 49          |
| 7.5 EUT OPERATION CONDITIONS                        | 49          |
| 7.6 TEST RESULTS                                    | 49          |
| <b>8 . DUTY CYCLE OF TEST SIGNAL</b>                | <b>58</b>   |
| 8.1 STANDARD REQUIREMENT                            | 58          |
| 8.2 FORMULA:  | 58          |
| <b>9 . ANTENNA REQUIREMENT</b>                      | <b>60</b>   |
| 9.1 STANDARD REQUIREMENT                            | 60          |
| 9.2 EUT ANTENNA                                     | 60          |
| <b>10 . EUT TEST PHOTO</b>                          | <b>61</b>   |
| <b>11 . EUT PHOTO</b>                               | <b>63</b>   |



## 1. SUMMARY OF TEST RESULTS

Test procedures according to the technical standards:

| FCC Part15 (15.247) , Subpart C |                                   |          |        |
|---------------------------------|-----------------------------------|----------|--------|
| Standard Section                | Test Item                         | Judgment | Remark |
| 15.207                          | Conducted Emission                | PASS     |        |
| 15.247 (a)(2)                   | 6dB Bandwidth                     | PASS     |        |
| 15.247 (b)                      | Peak Output Power                 | PASS     |        |
| 15.247 (d)                      | Radiated Spurious Emission        | PASS     |        |
| 15.247 (e)                      | Power Spectral Density            | PASS     |        |
| 15.205                          | Restricted Band of Operation      | PASS     |        |
| 15.247 (d)                      | Band Edge (Out of Band Emissions) | PASS     |        |
| 15.203                          | Antenna Requirement               | PASS     |        |

NOTE:

(1) "N/A" denotes test is not applicable in this Test Report



**1.1 TEST FACILITY**

Shenzhen BCTC Testing Co., Ltd.  
 Add. : BCTC Building & 1-2F, East of B Building, Pengzhou Industrial, Fuyuan 1st Road,  
 Qiaotou Community, Fuyong Street, Bao'an District, Shenzhen, China  
 FCC Test Firm Registration Number: 712850  
 IC Registered No.: 23583

**1.2 MEASUREMENT UNCERTAINTY**

The reported uncertainty of measurement  $y \pm U$  , where expended uncertainty  $U$  is based on a standard uncertainty multiplied by a coverage factor of  $k=2$  , providing a level of confidence of approximately **95 %**.

| No. | Item   | Uncertainty |
|-----|--|-------------|
| 1   | 3m chamber Radiated spurious emission(30MHz-1GHz)  | U=4.3dB     |
| 2   | 3m chamber Radiated spurious emission(1GHz-18GHz)  | U=4.5dB     |
| 3   | 3m chamber Radiated spurious emission(18GHz-40GHz) | U=3.34dB    |
| 4   | Conducted Adjacent channel power                   | U=1.38dB    |
| 5   | Conducted output power uncertainty Above 1G        | U=1.576dB   |
| 6   | Conducted output power uncertainty below 1G        | U=1.28dB    |
| 7   | humidity uncertainty                               | U=5.3%      |
| 8   | Temperature uncertainty                            | U=0.59 °C   |



## 2. GENERAL INFORMATION

### 2.1 GENERAL DESCRIPTION OF EUT

|                        |                                   |  |
|------------------------|-----------------------------------|--|
| Equipment              | IP Video Indoor Station           |  |
| Trade Name             | DoorBird                          |  |
| Model Name             | A1101                             |  |
| Model Difference       | N/A                               |  |
| Product Description    | Operation Frequency:              | 802.11b/g/n20MHz:2412~2462 MHz<br>802.11n40MHz:2422~2452 MHz                         |
|                        | Modulation Type:                  | WIFI: OFDM/DSSS  |
|                        | Bit Rate of Transmitter           | 802.11b:11/5.5/2/1 Mbps<br>802.11g:54/48/36/24/18/12/9/6Mbps<br>802.11n Up to 75Mbps |
|                        | Number Of Channel                 | 802.11b/g/n20MHz:11 CH<br>802.11n40MHz: 7 CH   |
|                        | Antenna Designation:              | Please see Note 3.   |
| Channel List           | Please refer to the Note 2.       |  |
| Ratings                | AC120V/60Hz                       |  |
| Connecting I/O Port(s) | Please refer to the User's Manual |  |

Note:

1. For a more detailed features description, please refer to the manufacturer's specifications or the User's Manual.



2.

| Channel List for 802.11b/g/n(20) |                 |         |                 |         |                 |         |                 |
|----------------------------------|-----------------|---------|-----------------|---------|-----------------|---------|-----------------|
| Channel                          | Frequency (MHz) | Channel | Frequency (MHz) | Channel | Frequency (MHz) | Channel | Frequency (MHz) |
| 01                               | 2412            | 04      | 2427            | 07      | 2442            | 10      | 2457            |
| 02                               | 2417            | 05      | 2432            | 08      | 2447            | 11      | 2462            |
| 03                               | 2422            | 06      | 2437            | 09      | 2452            |         |                 |

| Channel List for 802.11n(40) |                 |         |                 |         |                 |         |                 |
|------------------------------|-----------------|---------|-----------------|---------|-----------------|---------|-----------------|
| Channel                      | Frequency (MHz) | Channel | Frequency (MHz) | Channel | Frequency (MHz) | Channel | Frequency (MHz) |
| 03                           | 2422            | 05      | 2432            | 07      | 2442            | 09      | 2452            |
| 04                           | 2427            | 06      | 2437            | 08      | 2447            |         |                 |

3.

Table for Internal antenna

| Ant. | Brand    | Model Name | Antenna Type     | Gain (dBi) | NOTE |
|------|----------|------------|------------------|------------|------|
| 1    | DoorBird | A1101      | Internal antenna | 1          |      |

## 2.2 DESCRIPTION OF TEST MODES

| Pretest Mode | Description              |
|--------------|--------------------------|
| Mode 1       | 802.11b CH1/ CH6/ CH11   |
| Mode 2       | 802.11g CH1/ CH6/ CH11   |
| Mode 3       | 802.11n20 CH1/ CH6/ CH11 |
| Mode 4       | 802.11n40 CH3/ CH6/ CH9  |
| Mode 5       | Link Mode                |

| Conducted Emission |             |
|--------------------|-------------|
| Final Test Mode    | Description |
| Mode 5             | Link Mode   |

| For Radiated Emission |                          |
|-----------------------|--------------------------|
| Final Test Mode       | Description              |
| Mode 1                | 802.11b CH1/ CH6/ CH11   |
| Mode 2                | 802.11g CH1/ CH6/ CH11   |
| Mode 3                | 802.11n20 CH1/ CH6/ CH11 |
| Mode 4                | 802.11n40 CH3/ CH6/ CH9  |

Note:

(1) The measurements are performed at all Bit Rate of Transmitter, the worst data was reported.



### 2.3 BLOCK DIGRAM SHOWING THE CONFIGURATION OF SYSTEM TESTED

Conducted Emissions Test

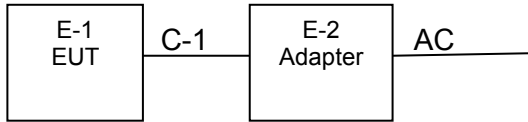

Spurious emissions Test

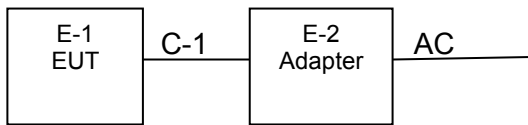

### 2.4 DESCRIPTION OF SUPPORT UNITS(CONDUCTED MODE)

The EUT has been tested as an independent unit together with other necessary accessories or support units. The following support units or accessories were used to form a representative test configuration during the tests.

| No. | Device Type             | Brand    | Model            | Series No. | Data Cable |
|-----|-------------------------|----------|------------------|------------|------------|
| E-1 | IP Video Indoor Station | DoorBird | A1101            | N/A        | EUT        |
| E-2 | Adapter                 | N/A      | UT20-15010<br>0W | N/A        | EUT        |

| Item | Shielded Type | Ferrite Core | Length | Note                |
|------|---------------|--------------|--------|---------------------|
| C-1  | NO            | NO           | 0.5M   | DC cable unshielded |

Note:

- (1) The support equipment was authorized by Declaration of Confirmation.
- (2) For detachable type I/O cable should be specified the length in cm in 『Length』 column.



## 2.5 EQUIPMENTS LIST FOR ALL TEST ITEMS

### Radiation Test equipment

| Item | Equipment                        | Manufacturer | Type No.      | Serial No.    | Last calibration | Calibrated until |
|------|----------------------------------|--------------|---------------|---------------|------------------|------------------|
| 1    | Spectrum Analyzer (9kHz-26.5GHz) | Agilent      | E4407B        | MY45109572    | Jun. 08, 2020    | Jun. 07, 2021    |
| 2    | Test Receiver (9kHz-7GHz)        | R&S          | ESR7          | 101154        | Jun. 08, 2020    | Jun. 07, 2021    |
| 3    | Bilog Antenna (30MHz-3GHz)       | SCHWARZBECK  | VULB9163      | VULB9163-942  | Jun. 08, 2020    | Jun. 07, 2021    |
| 4    | Horn Antenna (1GHz-18GHz)        | SCHWARZBECK  | BBHA9120D     | 1541          | Jun. 10, 2020    | Jun. 09, 2021    |
| 5    | Horn Antenna (18GHz-40GHz)       | SCHWARZBECK  | BBHA9170      | 822           | Jun. 10, 2020    | Jun. 09, 2021    |
| 6    | Amplifier (9KHz-6GHz)            | SCHWARZBECK  | BBV9744       | 9744-0037     | Jun. 04, 2020    | Jun. 03, 2021    |
| 7    | Amplifier (0.5GHz-18GHz)         | SCHWARZBECK  | BBV9718       | 9718-309      | Jun. 04, 2020    | Jun. 03, 2021    |
| 8    | Amplifier (18GHz-40GHz)          | MITEQ        | TTA1840-35-HG | 2034381       | Jun. 08, 2020    | Jun. 07, 2021    |
| 9    | Loop Antenna (9KHz-30MHz)        | SCHWARZBECK  | FMZB1519B     | 014           | Jun. 08, 2020    | Jun. 07, 2021    |
| 10   | RF cables1 (9kHz-30MHz)          | Huber+Suhnar | 9kHz-30MHz    | B1702988-0008 | Jun. 08, 2020    | Jun. 07, 2021    |
| 11   | RF cables2 (30MHz-1GHz)          | Huber+Suhnar | 30MHz-1GHz    | 1486150       | Jun. 08, 2020    | Jun. 07, 2021    |
| 12   | RF cables3 (1GHz-40GHz)          | Huber+Suhnar | 1GHz-40GHz    | 1607106       | Jun. 08, 2020    | Jun. 07, 2021    |
| 13   | Power Metter                     | Keysight     | E4419B        | \             | Jun. 08, 2020    | Jun. 07, 2021    |
| 14   | Power Sensor (AV)                | Keysight     | E9 300A       | \             | Jun. 08, 2020    | Jun. 07, 2021    |
| 15   | Signal Analyzer 20kHz-26.5GHz    | KEYSIGHT     | N9020A        | MY49100060    | Jun. 04, 2020    | Jun. 03, 2021    |
| 16   | Spectrum Analyzer 9kHz-40GHz     | Agilent      | FSP40         | 100363        | Jun. 04, 2020    | Jun. 03, 2021    |
| 17   | D.C. Power Supply                | LongWei      | TPR-6405D     | \             | \                | \                |
| 18   | Software                         | Frad         | EZ-EMC        | FA-03A2 RE    | \                | \                |



Conduction Test equipment

| Item | Equipment     | Manufacturer    | Type No.   | Serial No.        | Last calibration | Calibrated until |
|------|---------------|-----------------|------------|-------------------|------------------|------------------|
| 1    | Test Receiver | R&S             | ESR3       | 102075            | Jun. 08, 2020    | Jun. 07, 2021    |
| 2    | LISN          | SCHWARZBEC<br>K | NSLK8127   | 8127739           | Jun. 08, 2020    | Jun. 07, 2021    |
| 3    | LISN          | R&S             | ENV216     | 101375            | Jun. 04, 2020    | Jun. 03, 2021    |
| 4    | RF cables     | Huber+Suhnar    | 9kHz-30MHz | B1702988-00<br>08 | Jun. 08, 2020    | Jun. 07, 2021    |
| 5    | Software      | Frad            | EZ-EMC     | EMC-CON<br>3A1    | \                | \                |



### 3. EMC EMISSION TEST

#### 3.1 CONDUCTED EMISSION MEASUREMENT

##### 3.1.1 POWER LINE CONDUCTED EMISSION Limits (Frequency Range 150KHz-30MHz)

| FREQUENCY (MHz) | Limit (dBuV) |           | Standard |
|-----------------|--------------|-----------|----------|
|                 | Quasi-peak   | Average   |          |
| 0.15 -0.5       | 66 - 56 *    | 56 - 46 * | FCC      |
| 0.50 -5.0       | 56.00        | 46.00     | FCC      |
| 5.0 -30.0       | 60.00        | 50.00     | FCC      |

Note:

- (1) The tighter limit applies at the band edges.
- (2) The limit of " \* " marked band means the limitation decreases linearly with the logarithm of the frequency in the range.

The following table is the setting of the receiver

| Receiver Parameters | Setting  |
|---------------------|----------|
| Attenuation         | 10 dB    |
| Start Frequency     | 0.15 MHz |
| Stop Frequency      | 30 MHz   |
| IF Bandwidth        | 9 kHz    |

##### 3.1.2 TEST PROCEDURE

- a. The EUT was placed 0.8 meters from the horizontal ground plane with EUT being connected to the power mains through a line impedance stabilization network (LISN). All other support equipments powered from additional LISN(s). The LISN provide 50 Ohm/ 50uH of coupling impedance for the measuring instrument.
- b. Interconnecting cables that hang closer than 40 cm to the ground plane shall be folded back and forth in the center forming a bundle 30 to 40 cm long.
- c. I/O cables that are not connected to a peripheral shall be bundled in the center. The end of the cable may be terminated, if required, using the correct terminating impedance. The overall length shall not exceed 1 m.
- d. LISN at least 80 cm from nearest part of EUT chassis.
- e. For the actual test configuration, please refer to the related Item –EUT Test Photos.

##### 3.1.3 DEVIATION FROM TEST STANDARD

No deviation

### 3.1.4 TEST SETUP

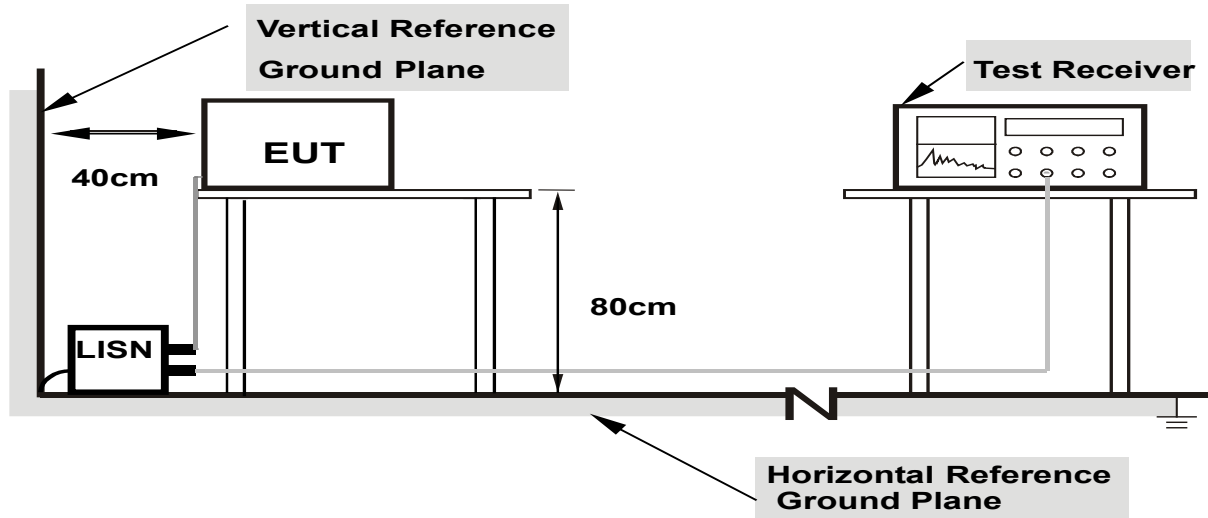

- Note: 1.Support units were connected to second LISN.**  
**2.Both of LISNs (AMN) are 80 cm from EUT and at least 80 from other units and other metal planes**

### 3.1.5 EUT OPERATING CONDITIONS

The EUT was configured for testing in a typical fashion (as a customer would normally use it). The EUT has been programmed to continuously transmit during test. This operating condition was tested and used to collect the included data.

We pretest AC 120V and AC 240V, the worst voltage was AC 120V and the data recording in the report.



**3.1.6 TEST RESULTS**

|                |              |                     |        |
|----------------|--------------|---------------------|--------|
| Temperature :  | 26 °C        | Relative Humidity : | 54%    |
| Pressure :     | 101kPa       | Phase :             | L      |
| Test Voltage : | AC 120V/60Hz | Test Mode :         | Mode 5 |

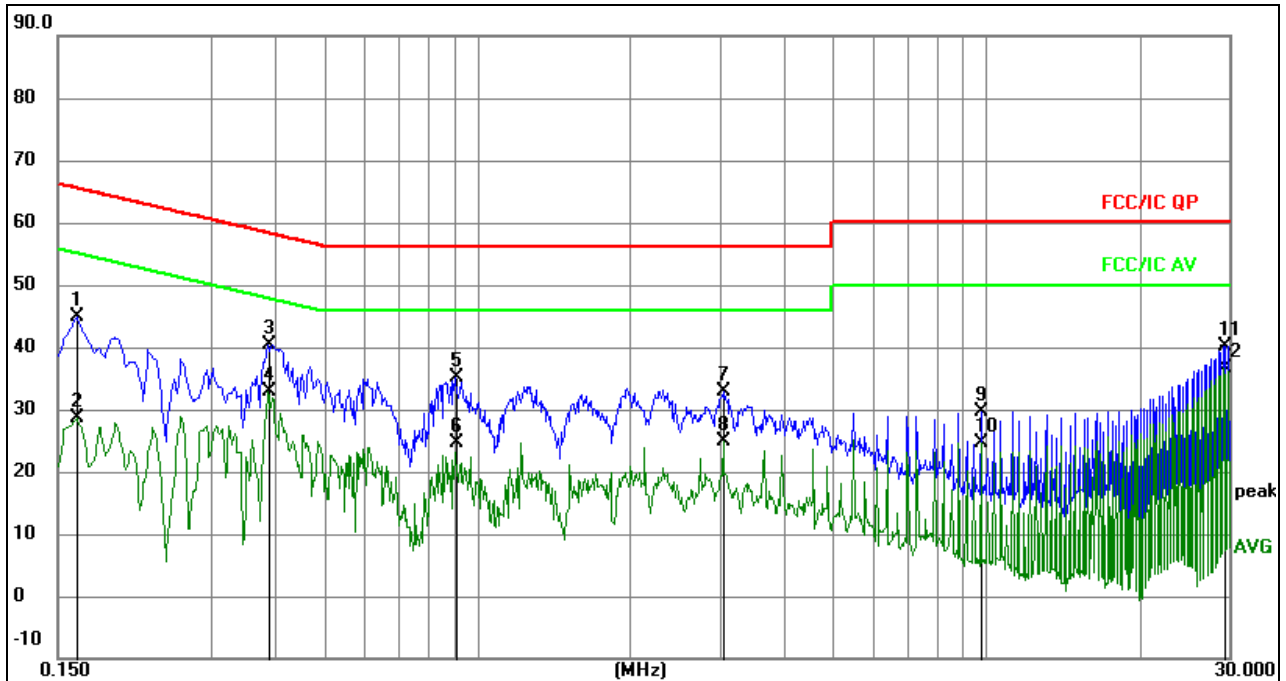

Remark:

1. All readings are Quasi-Peak and Average values.
2. Factor = Insertion Loss + Cable Loss.

| No. | Mk. | Freq.   | Reading Level | Correct Factor | Measurement | Limit | Over   | Detector |
|-----|-----|---------|---------------|----------------|-------------|-------|--------|----------|
|     |     | MHz     |               | dB             | dBuV        | dBuV  | dB     |          |
| 1   |     | 0.1635  | 35.37         | 9.50           | 44.87       | 65.28 | -20.41 | QP       |
| 2   |     | 0.1635  | 19.07         | 9.50           | 28.57       | 55.28 | -26.71 | AVG      |
| 3   |     | 0.3885  | 30.76         | 9.51           | 40.27       | 58.10 | -17.83 | QP       |
| 4   |     | 0.3885  | 23.47         | 9.51           | 32.98       | 48.10 | -15.12 | AVG      |
| 5   |     | 0.9060  | 25.60         | 9.60           | 35.20       | 56.00 | -20.80 | QP       |
| 6   |     | 0.9060  | 15.08         | 9.60           | 24.68       | 46.00 | -21.32 | AVG      |
| 7   |     | 3.0525  | 23.20         | 9.66           | 32.86       | 56.00 | -23.14 | QP       |
| 8   |     | 3.0525  | 15.34         | 9.66           | 25.00       | 46.00 | -21.00 | AVG      |
| 9   |     | 9.7709  | 19.82         | 9.69           | 29.51       | 60.00 | -30.49 | QP       |
| 10  |     | 9.7709  | 14.90         | 9.69           | 24.59       | 50.00 | -25.41 | AVG      |
| 11  |     | 29.3100 | 30.51         | 9.71           | 40.22       | 60.00 | -19.78 | QP       |
| 12  | *   | 29.3100 | 26.95         | 9.71           | 36.66       | 50.00 | -13.34 | AVG      |



|                |              |                     |        |
|----------------|--------------|---------------------|--------|
| Temperature :  | 26 °C        | Relative Humidity : | 54%    |
| Pressure :     | 101kPa       | Phase :             | N      |
| Test Voltage : | AC 120V/60Hz | Test Mode :         | Mode 5 |

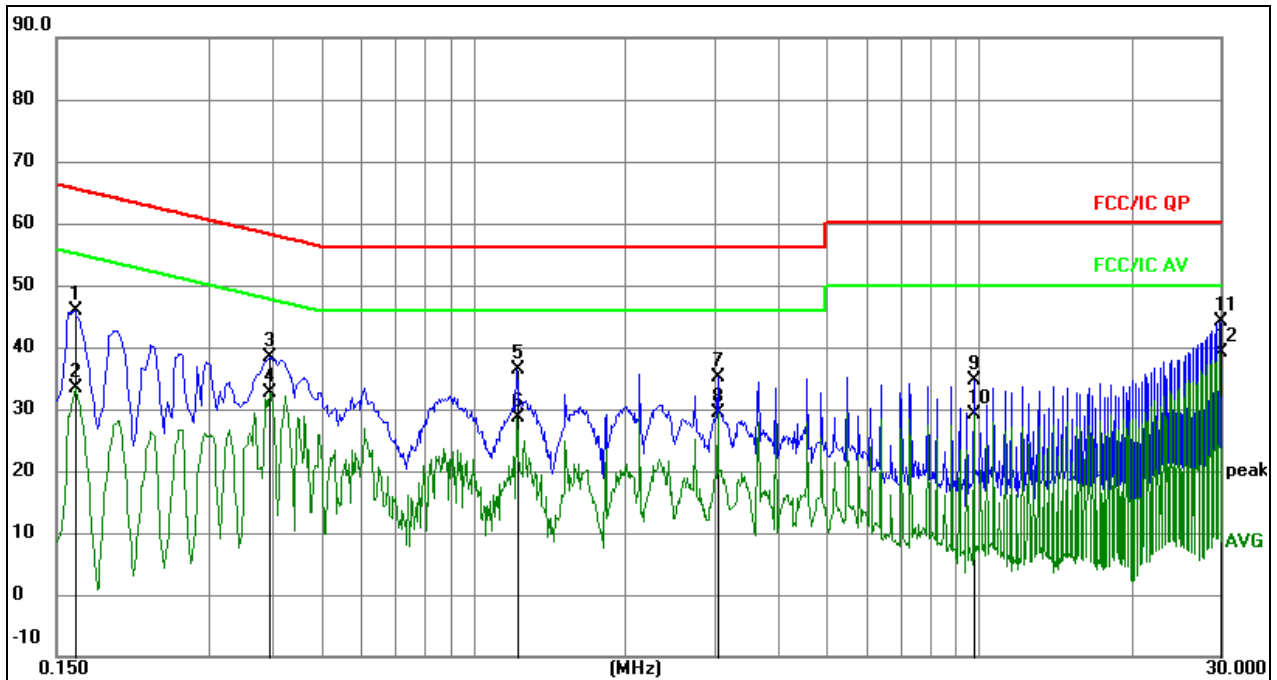

Remark:

1. All readings are Quasi-Peak and Average values.
2. Factor = Insertion Loss + Cable Loss.

| No. | Mk. | Freq.<br>MHz | Reading<br>Level | Correct<br>Factor<br>dB | Measure-<br>ment<br>dBuV | Limit<br>dBuV | Over<br>dB | Detector |
|-----|-----|--------------|------------------|-------------------------|--------------------------|---------------|------------|----------|
| 1   |     | 0.1633       | 36.29            | 9.50                    | 45.79                    | 65.29         | -19.50     | QP       |
| 2   |     | 0.1633       | 23.93            | 9.50                    | 33.43                    | 55.29         | -21.86     | AVG      |
| 3   |     | 0.3955       | 28.93            | 9.50                    | 38.43                    | 57.95         | -19.52     | QP       |
| 4   |     | 0.3955       | 23.19            | 9.50                    | 32.69                    | 47.95         | -15.26     | AVG      |
| 5   |     | 1.2162       | 26.83            | 9.57                    | 36.40                    | 56.00         | -19.60     | QP       |
| 6   |     | 1.2162       | 19.02            | 9.57                    | 28.59                    | 46.00         | -17.41     | AVG      |
| 7   |     | 3.0414       | 25.58            | 9.66                    | 35.24                    | 56.00         | -20.76     | QP       |
| 8   |     | 3.0414       | 19.63            | 9.66                    | 29.29                    | 46.00         | -16.71     | AVG      |
| 9   |     | 9.7567       | 24.83            | 9.69                    | 34.52                    | 60.00         | -25.48     | QP       |
| 10  |     | 9.7567       | 19.44            | 9.69                    | 29.13                    | 50.00         | -20.87     | AVG      |
| 11  |     | 29.8415      | 34.44            | 9.70                    | 44.14                    | 60.00         | -15.86     | QP       |
| 12  | *   | 29.8415      | 29.49            | 9.70                    | 39.19                    | 50.00         | -10.81     | AVG      |



### 3.2 RADIATED EMISSION MEASUREMENT

#### 3.2.1 RADIATED EMISSION LIMITS (Frequency Range 9kHz-1000MHz)

20dBc in any 100 kHz bandwidth outside the operating frequency band. In case the emission fall within the restricted band specified on 15.205(a), then the 15.209(a) limit in the table below has to be followed.

| Frequencies (MHz) | Field Strength (micorvolts/meter) | Measurement Distance (meters) |
|-------------------|-----------------------------------|-------------------------------|
| 0.009~0.490       | 2400/F(KHz)                       | 300                           |
| 0.490~1.705       | 24000/F(KHz)                      | 30                            |
| 1.705~30.0        | 30                                | 30                            |
| 30~88             | 100                               | 3                             |
| 88~216            | 150                               | 3                             |
| 216~960           | 200                               | 3                             |
| Above 960         | 500                               | 3                             |

#### LIMITS OF RADIATED EMISSION MEASUREMENT (Above 1000MHz)

| FREQUENCY (MHz) | Limit (dBuV/m) (at 3M) |         |
|-----------------|------------------------|---------|
|                 | PEAK                   | AVERAGE |
| Above 1000      | 74                     | 54      |

Notes:

- (1) The limit for radiated test was performed according to FCC PART 15C.
- (2) The tighter limit applies at the band edges.
- (3) Emission level (dBuV/m)=20log Emission level (uV/m).

| Spectrum Parameter                    | Setting  |
|---------------------------------------|--|
| Attenuation                           | Auto   |
| Start Frequency                       | 1000 MHz   |
| Stop Frequency                        | 25GHz  |
| RB / VB (emission in restricted band) | 1 MHz / 1 MHz for Peak, 1 MHz / 10Hz for Average |

| Receiver Parameter     | Setting                          |
|------------------------|----------------------------------|
| Attenuation            | Auto                             |
| Start ~ Stop Frequency | 9kHz~150kHz / RB 200Hz for QP    |
| Start ~ Stop Frequency | 150kHz~30MHz / RB 9kHz for QP    |
| Start ~ Stop Frequency | 30MHz~1000MHz / RB 120kHz for QP |



### 3.2.2 TEST PROCEDURE

Below 1GHz test procedure as below:

- a. The EUT was placed on the top of a rotating table 0.8 meters above the ground at a 3 meter semi-anechoic chamber. The table was rotated 360 degrees to determine the position of the highest radiation.
- b. The EUT was set 3 meters away from the interference-receiving antenna, which was mounted on the top of a variable-height antenna tower.
- c. The antenna height is varied from one meter to four meters above the ground to determine the maximum value of the field strength. Both horizontal and vertical polarizations of the antenna are set to make the measurement.
- d. For each suspected emission, the EUT was arranged to its worst case and then the antenna was tuned to heights from 1 meter to 4 meters (for the test frequency of below 30MHz, the antenna was tuned to heights 1 meter) and the rotatable table was turned from 0 degrees to 360 degrees to find the maximum reading.
- e. The test-receiver system was set to Peak Detect Function and Specified Bandwidth with Maximum Hold Mode.
- f. If the emission level of the EUT in peak mode was 10dB lower than the limit specified, then testing could be stopped and the peak values of the EUT would be reported. Otherwise the emissions that did not have 10dB margin would be re-tested one by one using peak, quasi-peak or average method as specified and then reported in a data sheet.

Above 1GHz test procedure as below:

- g. Different between above is the test site, change from Semi- Anechoic Chamber to fully Anechoic Chamber and change form table 0.8 metre to 1.5 metre( Above 18GHz the distance is 1 meter and table is 1.5 metre).
- h. Test the EUT in the lowest channel ,the middle channel ,the Highest channel

Note:

Both horizontal and vertical antenna polarities were tested and performed pretest to three orthogonal axis. The worst case emissions were reported

### 3.2.3 DEVIATION FROM TEST STANDARD

No deviation

### 3.2.4 TEST SETUP

(A) Radiated Emission Test-Up Frequency Below 30MHz

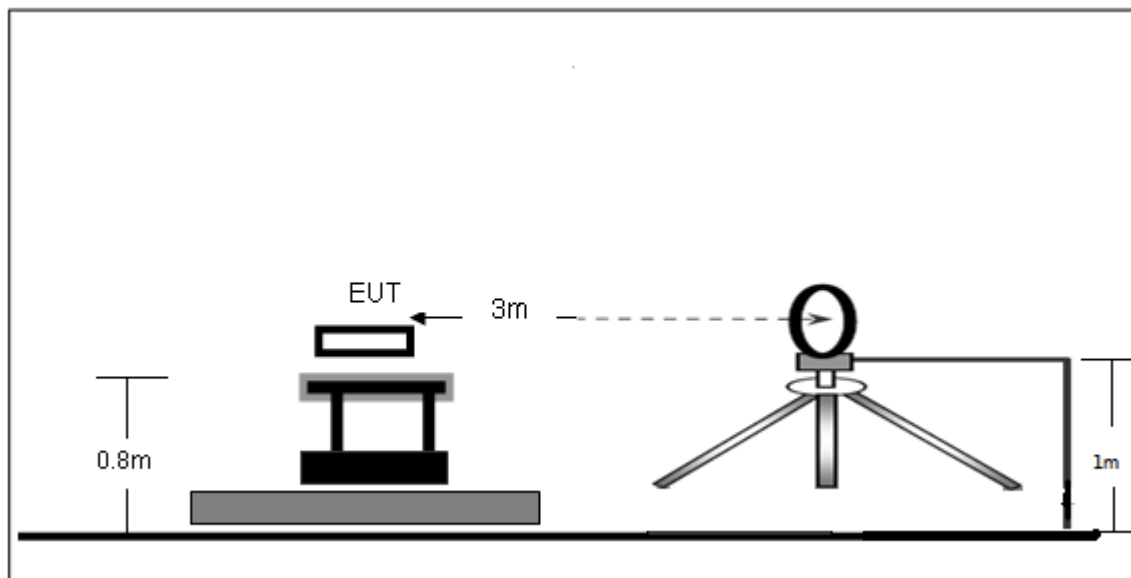

(B) Radiated Emission Test-Up Frequency 30MHz~1GHz

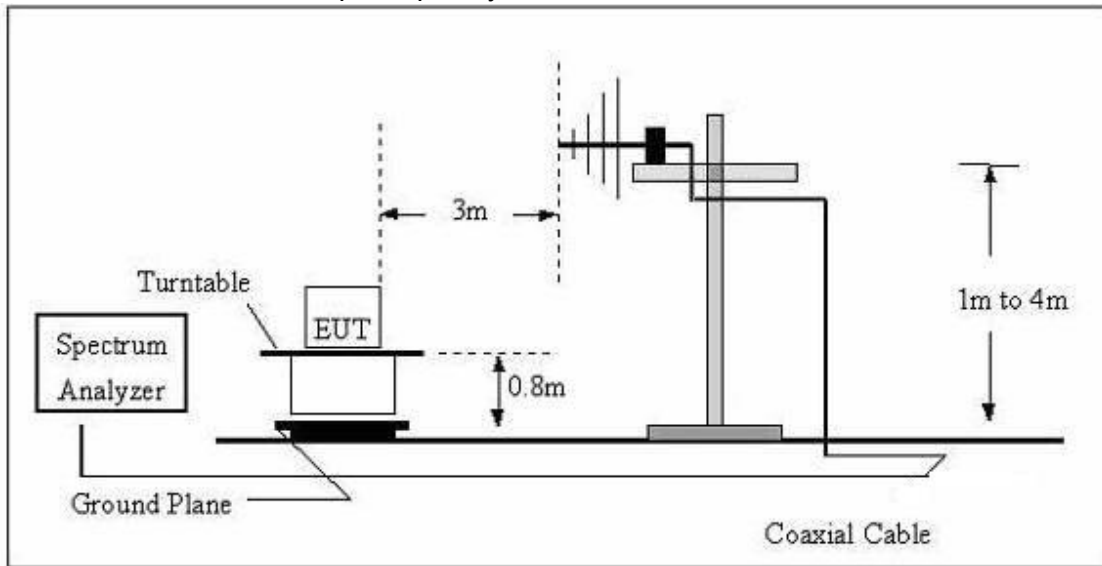

(C) Radiated Emission Test-Up Frequency Above 1GHz

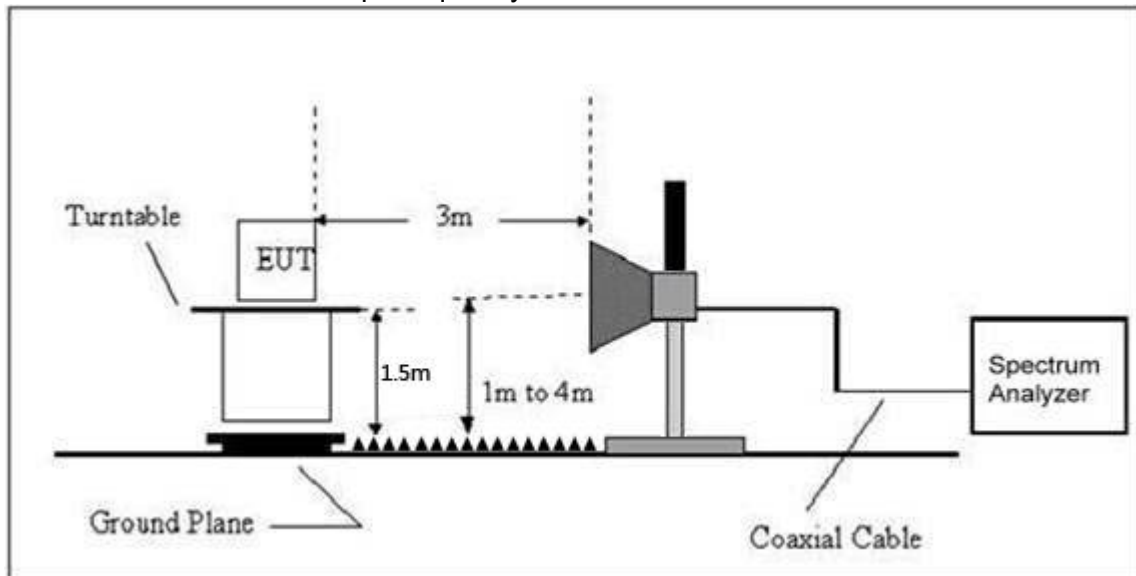

### 3.2.5 EUT OPERATING CONDITIONS

The EUT tested system was configured as the statements of 2.4 Unless otherwise a special operating condition is specified in the follows during the testing.



**3.2.6 TEST RESULTS (BETWEEN 9KHZ – 30 MHZ)**

|              |        |                    |             |
|--------------|--------|--------------------|-------------|
| Temperature: | 26°C   | Relative Humidity: | 54%         |
| Pressure:    | 101kPa | Test Voltage :     | AC120V/60Hz |
| Test Mode :  | Mode 5 | Polarization :     | --          |

| Freq.<br>(MHz) | Reading<br>(dBuV/m) | Limit<br>(dBuV/m) | Margin<br>(dB) | State<br>P/F |
|----------------|---------------------|-------------------|----------------|--------------|
| --             | --                  | --                | --             | PASS         |
| --             | --                  | --                | --             | PASS         |

**NOTE:**

The amplitude of spurious emissions which are attenuated by more than 20dB below the permissible value has no need to be reported.

Distance extrapolation factor =  $40 \log (\text{specific distance}/\text{test distance})$ (dB);

Limit line = specific limits(dBuv) + distance extrapolation factor.



**3.2.7 TEST RESULTS (BETWEEN 30MHZ – 1GHZ)**

|                |             |                     |            |
|----------------|-------------|---------------------|------------|
| Temperature :  | 26°C        | Relative Humidity : | 54%        |
| Pressure :     | 101 kPa     | Polarization :      | Horizontal |
| Test Voltage : | AC120V/60Hz | Test Mode :         | Mode 5     |

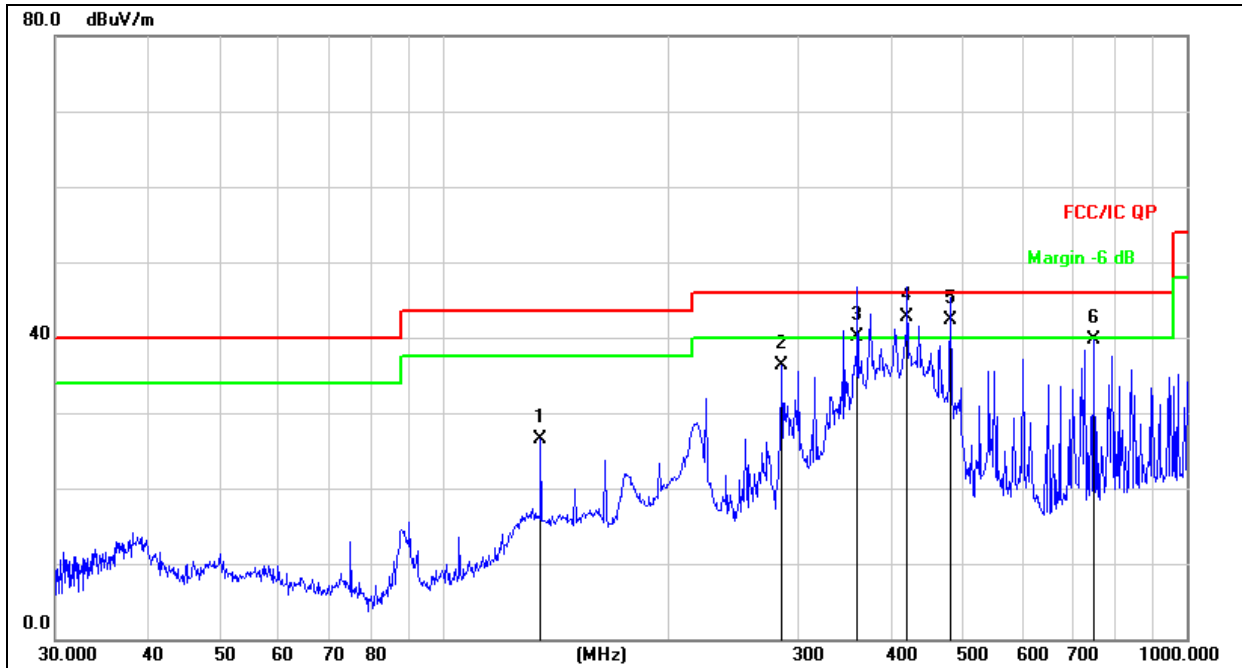

Remark:  
Factor = Antenna Factor + Cable Loss – Pre-amplifier.

| No. | Mk. | Freq.<br>MHz | Reading<br>Level<br>dBuV | Correct<br>Factor<br>dB | Measure-<br>ment<br>dBuV/m | Limit<br>dB/m | Over<br>dB | Detector |
|-----|-----|--------------|--------------------------|-------------------------|----------------------------|---------------|------------|----------|
| 1   |     | 135.0319     | 45.12                    | -18.54                  | 26.58                      | 43.50         | -16.92     | QP       |
| 2   |     | 284.9767     | 50.28                    | -14.07                  | 36.21                      | 46.00         | -9.79      | QP       |
| 3   | !   | 360.0077     | 52.02                    | -12.00                  | 40.02                      | 46.00         | -5.98      | QP       |
| 4   | *   | 420.5803     | 53.35                    | -10.63                  | 42.72                      | 46.00         | -3.28      | QP       |
| 5   | !   | 480.5276     | 51.73                    | -9.34                   | 42.39                      | 46.00         | -3.61      | QP       |
| 6   |     | 750.1083     | 44.05                    | -4.34                   | 39.71                      | 46.00         | -6.29      | QP       |



|                |             |                     |          |
|----------------|-------------|---------------------|----------|
| Temperature :  | 26°C        | Relative Humidity : | 54%      |
| Pressure :     | 101kPa      | Polarization :      | Vertical |
| Test Voltage : | AC120V/60Hz | Test Mode :         | Mode 5   |

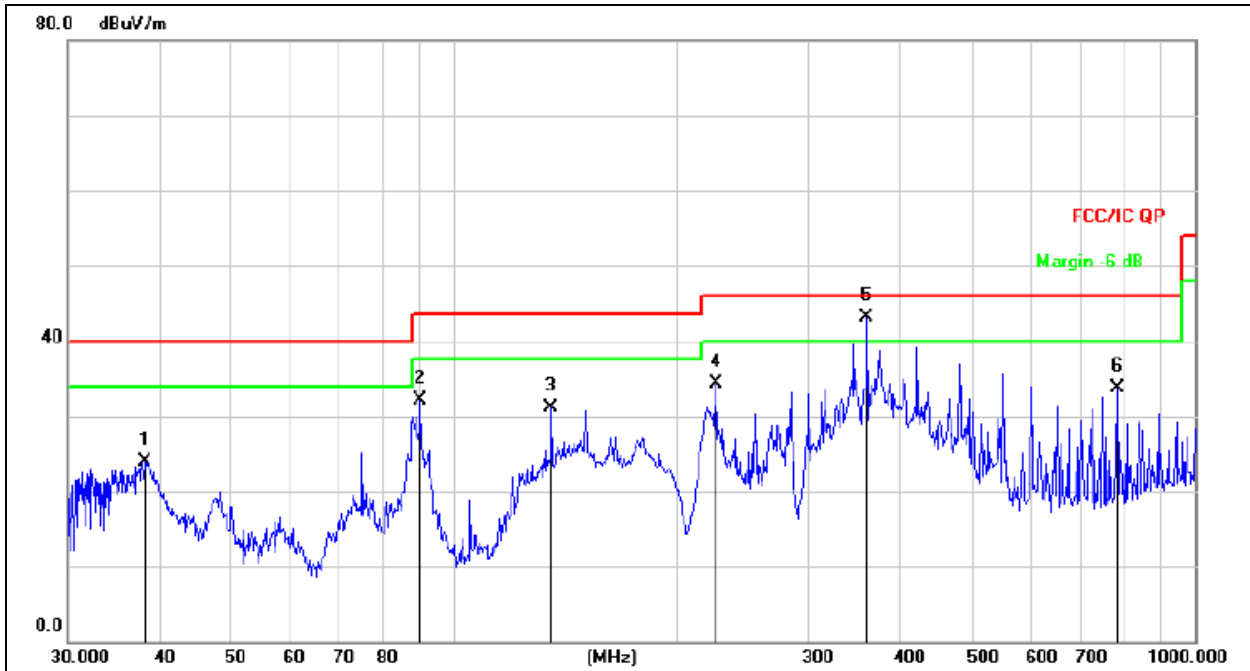

Remark:  
Factor = Antenna Factor + Cable Loss – Pre-amplifier.

| No. | Mk. | Freq.<br>MHz | Reading<br>Level<br>dBuV | Correct<br>Factor<br>dB | Measure-<br>ment<br>dBuV/m | Limit<br>dB/m | Over<br>dB | Detector |
|-----|-----|--------------|--------------------------|-------------------------|----------------------------|---------------|------------|----------|
| 1   |     | 38.0783      | 39.77                    | -15.77                  | 24.00                      | 40.00         | -16.00     | QP       |
| 2   |     | 89.9047      | 50.27                    | -18.12                  | 32.15                      | 43.50         | -11.35     | QP       |
| 3   |     | 135.0319     | 49.74                    | -18.54                  | 31.20                      | 43.50         | -12.30     | QP       |
| 4   |     | 225.3080     | 50.07                    | -15.72                  | 34.35                      | 46.00         | -11.65     | QP       |
| 5   | *   | 360.4476     | 55.18                    | -11.99                  | 43.19                      | 46.00         | -2.81      | QP       |
| 6   |     | 785.0935     | 37.60                    | -3.85                   | 33.75                      | 46.00         | -12.25     | QP       |



3.2.8 TEST RESULTS (1GHZ~25GHZ)

802.11b

| Polar (H/V)         | Frequency | Meter Reading | Pre-amplifier | Cable Loss | Antenna Factor | Emission Level | Limits   | Margin | Detector Type |
|---------------------|-----------|---------------|---------------|------------|----------------|----------------|----------|--------|---------------|
|                     | (MHz)     | (dBuV)        | (dB)          | (dB)       | (dB)           | (dBuV/m)       | (dBuV/m) | (dB)   |               |
| Low Channel:2412MHz |           |               |               |            |                |                |          |        |               |
| V                   | 4824.00   | 66.51         | 39.55         | 7.85       | 25.66          | 60.47          | 74.00    | -13.53 | PK            |
| V                   | 4824.00   | 52.26         | 39.55         | 7.85       | 25.66          | 46.22          | 54.00    | -7.78  | AV            |
| V                   | 7236.00   | 65.78         | 38.33         | 7.52       | 24.55          | 59.52          | 74.00    | -14.48 | PK            |
| V                   | 7236.00   | 51.21         | 38.33         | 7.52       | 24.55          | 44.95          | 54.00    | -9.05  | AV            |
| H                   | 4824.00   | 66.80         | 39.55         | 7.85       | 25.66          | 60.76          | 74.00    | -13.24 | PK            |
| H                   | 4824.00   | 50.12         | 39.55         | 7.85       | 25.66          | 44.08          | 54.00    | -9.92  | AV            |
| H                   | 7236.00   | 65.95         | 38.33         | 7.52       | 24.55          | 59.69          | 74.00    | -14.31 | PK            |
| H                   | 7236.00   | 48.61         | 38.33         | 7.52       | 24.55          | 42.35          | 54.00    | -11.65 | AV            |

| Polar (H/V)            | Frequency | Meter Reading | Pre-amplifier | Cable Loss | Antenna Factor | Emission Level | Limits   | Margin | Detector Type |
|------------------------|-----------|---------------|---------------|------------|----------------|----------------|----------|--------|---------------|
|                        | (MHz)     | (dBuV)        | (dB)          | (dB)       | (dB)           | (dBuV/m)       | (dBuV/m) | (dB)   |               |
| Middle Channel:2437MHz |           |               |               |            |                |                |          |        |               |
| V                      | 4874.00   | 65.38         | 38.89         | 7.57       | 25.45          | 59.51          | 74.00    | -14.49 | Pk            |
| V                      | 4874.00   | 52.45         | 38.89         | 7.57       | 25.45          | 46.58          | 54.00    | -7.42  | AV            |
| V                      | 7311.00   | 66.59         | 38.78         | 7.35       | 24.54          | 59.70          | 74.00    | -14.30 | Pk            |
| V                      | 7311.00   | 51.73         | 38.78         | 7.35       | 24.54          | 44.84          | 54.00    | -9.16  | AV            |
| H                      | 4874.00   | 66.30         | 38.89         | 7.57       | 25.45          | 60.43          | 74.00    | -13.57 | Pk            |
| H                      | 4874.00   | 48.65         | 38.89         | 7.57       | 25.45          | 42.78          | 54.00    | -11.22 | AV            |
| H                      | 7311.00   | 65.90         | 38.78         | 7.35       | 24.54          | 59.01          | 74.00    | -14.99 | Pk            |
| H                      | 7311.00   | 46.91         | 38.78         | 7.35       | 24.54          | 40.02          | 54.00    | -13.98 | AV            |

| Polar (H/V)           | Frequency | Meter Reading | Pre-amplifier | Cable Loss | Antenna Factor | Emission Level | Limits   | Margin | Detector Type |
|-----------------------|-----------|---------------|---------------|------------|----------------|----------------|----------|--------|---------------|
|                       | (MHz)     | (dBuV)        | (dB)          | (dB)       | (dB)           | (dBuV/m)       | (dBuV/m) | (dB)   |               |
| High Channel: 2462MHz |           |               |               |            |                |                |          |        |               |
| V                     | 4924.00   | 65.63         | 38.75         | 7.46       | 25.41          | 59.75          | 74.00    | -14.25 | PK            |
| V                     | 4924.00   | 52.73         | 38.75         | 7.46       | 25.41          | 46.85          | 54.00    | -7.15  | AV            |
| V                     | 7386.00   | 65.88         | 38.65         | 7.22       | 24.52          | 58.97          | 74.00    | -15.03 | PK            |
| V                     | 7386.00   | 52.61         | 38.65         | 7.22       | 24.52          | 45.70          | 54.00    | -8.30  | AV            |
| H                     | 4924.00   | 64.03         | 38.75         | 7.46       | 25.41          | 58.15          | 74.00    | -15.85 | PK            |
| H                     | 4924.00   | 48.78         | 38.75         | 7.46       | 25.41          | 42.90          | 54.00    | -11.10 | AV            |
| H                     | 7386.00   | 66.34         | 38.65         | 7.22       | 24.52          | 59.43          | 74.00    | -14.57 | PK            |
| H                     | 7386.00   | 48.70         | 38.65         | 7.22       | 24.52          | 41.79          | 54.00    | -12.21 | AV            |

Remark:

1. Emission Level = Meter Reading + Antenna Factor + Cable Loss – Pre-amplifier,

Margin= Emission Level - Limit

2. If peak below the average limit, the average emission was no test.

3. The amplitude of spurious emissions which are attenuated by more than 20dB below the permissible value has no need to be reported.



**802.11g**

| Polar (H/V)         | Frequency | Meter Reading | Pre-amplifier | Cable Loss | Antenna Factor | Emission Level | Limits   | Margin | Detector Type |
|---------------------|-----------|---------------|---------------|------------|----------------|----------------|----------|--------|---------------|
|                     | (MHz)     | (dBuV)        | (dB)          | (dB)       | (dB)           | (dBuV/m)       | (dBuV/m) | (dB)   |               |
| Low Channel:2412MHz |           |               |               |            |                |                |          |        |               |
| V                   | 4824.00   | 64.84         | 39.55         | 7.85       | 25.66          | 58.80          | 74.00    | -15.20 | PK            |
| V                   | 4824.00   | 50.52         | 39.55         | 7.85       | 25.66          | 44.48          | 54.00    | -9.52  | AV            |
| V                   | 7236.00   | 63.95         | 38.33         | 7.52       | 24.55          | 57.69          | 74.00    | -16.31 | PK            |
| V                   | 7236.00   | 47.57         | 38.33         | 7.52       | 24.55          | 41.31          | 54.00    | -12.69 | AV            |
| H                   | 4824.00   | 64.38         | 39.55         | 7.85       | 25.66          | 58.34          | 74.00    | -15.66 | PK            |
| H                   | 4824.00   | 46.64         | 39.55         | 7.85       | 25.66          | 40.60          | 54.00    | -13.40 | AV            |
| H                   | 7236.00   | 62.88         | 38.33         | 7.52       | 24.55          | 56.62          | 74.00    | -17.38 | PK            |
| H                   | 7236.00   | 47.11         | 38.33         | 7.52       | 24.55          | 40.85          | 54.00    | -13.15 | AV            |

| Polar (H/V)            | Frequency | Meter Reading | Pre-amplifier | Cable Loss | Antenna Factor | Emission Level | Limits   | Margin | Detector Type |
|------------------------|-----------|---------------|---------------|------------|----------------|----------------|----------|--------|---------------|
|                        | (MHz)     | (dBuV)        | (dB)          | (dB)       | (dB)           | (dBuV/m)       | (dBuV/m) | (dB)   |               |
| Middle Channel:2437MHz |           |               |               |            |                |                |          |        |               |
| V                      | 4874.00   | 65.87         | 38.89         | 7.57       | 25.45          | 60.00          | 74.00    | -14.00 | PK            |
| V                      | 4874.00   | 52.02         | 38.89         | 7.57       | 25.45          | 46.15          | 54.00    | -7.85  | AV            |
| V                      | 7311.00   | 66.22         | 38.78         | 7.35       | 24.54          | 59.33          | 74.00    | -14.67 | PK            |
| V                      | 7311.00   | 51.79         | 38.78         | 7.35       | 24.54          | 44.90          | 54.00    | -9.10  | AV            |
| H                      | 4874.00   | 64.44         | 38.89         | 7.57       | 25.45          | 58.57          | 74.00    | -15.43 | PK            |
| H                      | 4874.00   | 47.99         | 38.89         | 7.57       | 25.45          | 42.12          | 54.00    | -11.88 | AV            |
| H                      | 7311.00   | 65.88         | 38.78         | 7.35       | 24.54          | 58.99          | 74.00    | -15.01 | PK            |
| H                      | 7311.00   | 48.94         | 38.78         | 7.35       | 24.54          | 42.05          | 54.00    | -11.95 | AV            |

| Polar (H/V)           | Frequency | Meter Reading | Pre-amplifier | Cable Loss | Antenna Factor | Emission Level | Limits   | Margin | Detector Type |
|-----------------------|-----------|---------------|---------------|------------|----------------|----------------|----------|--------|---------------|
|                       | (MHz)     | (dBuV)        | (dB)          | (dB)       | (dB)           | (dBuV/m)       | (dBuV/m) | (dB)   |               |
| High Channel: 2462MHz |           |               |               |            |                |                |          |        |               |
| V                     | 4924.00   | 65.60         | 38.75         | 7.46       | 25.41          | 59.72          | 74.00    | -14.28 | PK            |
| V                     | 4924.00   | 52.96         | 38.75         | 7.46       | 25.41          | 47.08          | 54.00    | -6.92  | AV            |
| V                     | 7386.00   | 64.40         | 38.65         | 7.22       | 24.52          | 57.49          | 74.00    | -16.51 | PK            |
| V                     | 7386.00   | 50.77         | 38.65         | 7.22       | 24.52          | 43.86          | 54.00    | -10.14 | AV            |
| H                     | 4924.00   | 66.44         | 38.75         | 7.46       | 25.41          | 60.56          | 74.00    | -13.44 | PK            |
| H                     | 4924.00   | 48.34         | 38.75         | 7.46       | 25.41          | 42.46          | 54.00    | -11.54 | AV            |
| H                     | 7386.00   | 65.97         | 38.65         | 7.22       | 24.52          | 59.06          | 74.00    | -14.94 | PK            |
| H                     | 7386.00   | 49.48         | 38.65         | 7.22       | 24.52          | 42.57          | 54.00    | -11.43 | AV            |

Remark:

1. Emission Level = Meter Reading + Antenna Factor + Cable Loss – Pre-amplifier,  
Margin= Emission Level - Limit
2. If peak below the average limit, the average emission was no test.
3. The amplitude of spurious emissions which are attenuated by more than 20dB below the permissible value has no need to be reported.



**802.11n(20MHz)**

| Polar (H/V)         | Frequency | Meter Reading | Pre-amplifier | Cable Loss | Antenna Factor | Emission Level | Limits   | Margin | Detector Type |
|---------------------|-----------|---------------|---------------|------------|----------------|----------------|----------|--------|---------------|
|                     | (MHz)     | (dBuV)        | (dB)          | (dB)       | (dB)           | (dBuV/m)       | (dBuV/m) | (dB)   |               |
| Low Channel:2412MHz |           |               |               |            |                |                |          |        |               |
| V                   | 4824.00   | 63.25         | 39.55         | 7.85       | 25.66          | 57.21          | 74.00    | -16.79 | PK            |
| V                   | 4824.00   | 48.60         | 39.55         | 7.85       | 25.66          | 42.56          | 54.00    | -11.44 | AV            |
| V                   | 7236.00   | 63.00         | 38.33         | 7.52       | 24.55          | 56.74          | 74.00    | -17.26 | PK            |
| V                   | 7236.00   | 46.02         | 38.33         | 7.52       | 24.55          | 39.76          | 54.00    | -14.24 | AV            |
| H                   | 4824.00   | 61.55         | 39.55         | 7.85       | 25.66          | 55.51          | 74.00    | -18.49 | PK            |
| H                   | 4824.00   | 44.99         | 39.55         | 7.85       | 25.66          | 38.95          | 54.00    | -15.05 | AV            |
| H                   | 7236.00   | 63.19         | 38.33         | 7.52       | 24.55          | 56.93          | 74.00    | -17.07 | PK            |
| H                   | 7236.00   | 44.02         | 38.33         | 7.52       | 24.55          | 37.76          | 54.00    | -16.24 | AV            |

| Polar (H/V)            | Frequency | Meter Reading | Pre-amplifier | Cable Loss | Antenna Factor | Emission Level | Limits   | Margin | Detector Type |
|------------------------|-----------|---------------|---------------|------------|----------------|----------------|----------|--------|---------------|
|                        | (MHz)     | (dBuV)        | (dB)          | (dB)       | (dB)           | (dBuV/m)       | (dBuV/m) | (dB)   |               |
| Middle Channel:2437MHz |           |               |               |            |                |                |          |        |               |
| V                      | 4874.00   | 64.54         | 38.89         | 7.57       | 25.45          | 58.67          | 74.00    | -15.33 | PK            |
| V                      | 4874.00   | 47.53         | 38.89         | 7.57       | 25.45          | 41.66          | 54.00    | -12.34 | AV            |
| V                      | 7311.00   | 64.51         | 38.78         | 7.35       | 24.54          | 57.62          | 74.00    | -16.38 | PK            |
| V                      | 7311.00   | 45.37         | 38.78         | 7.35       | 24.54          | 38.48          | 54.00    | -15.52 | AV            |
| H                      | 4874.00   | 63.59         | 38.89         | 7.57       | 25.45          | 57.72          | 74.00    | -16.28 | PK            |
| H                      | 4874.00   | 44.12         | 38.89         | 7.57       | 25.45          | 38.25          | 54.00    | -15.75 | AV            |
| H                      | 7311.00   | 64.98         | 38.78         | 7.35       | 24.54          | 58.09          | 74.00    | -15.91 | PK            |
| H                      | 7311.00   | 43.26         | 38.78         | 7.35       | 24.54          | 36.37          | 54.00    | -17.63 | AV            |

| Polar (H/V)           | Frequency | Meter Reading | Pre-amplifier | Cable Loss | Antenna Factor | Emission Level | Limits   | Margin | Detector Type |
|-----------------------|-----------|---------------|---------------|------------|----------------|----------------|----------|--------|---------------|
|                       | (MHz)     | (dBuV)        | (dB)          | (dB)       | (dB)           | (dBuV/m)       | (dBuV/m) | (dB)   |               |
| High Channel: 2462MHz |           |               |               |            |                |                |          |        |               |
| V                     | 4924.00   | 63.34         | 38.75         | 7.46       | 25.41          | 57.46          | 74.00    | -16.54 | PK            |
| V                     | 4924.00   | 47.90         | 38.75         | 7.46       | 25.41          | 42.02          | 54.00    | -11.98 | AV            |
| V                     | 7386.00   | 64.25         | 38.65         | 7.22       | 24.52          | 57.34          | 74.00    | -16.66 | PK            |
| V                     | 7386.00   | 45.82         | 38.65         | 7.22       | 24.52          | 38.91          | 54.00    | -15.09 | AV            |
| H                     | 4924.00   | 64.32         | 38.75         | 7.46       | 25.41          | 58.44          | 74.00    | -15.56 | PK            |
| H                     | 4924.00   | 44.27         | 38.75         | 7.46       | 25.41          | 38.39          | 54.00    | -15.61 | AV            |
| H                     | 7386.00   | 63.55         | 38.65         | 7.22       | 24.52          | 56.64          | 74.00    | -17.36 | PK            |
| H                     | 7386.00   | 44.68         | 38.65         | 7.22       | 24.52          | 37.77          | 54.00    | -16.23 | AV            |

Remark:

1. Emission Level = Meter Reading + Antenna Factor + Cable Loss – Pre-amplifier,

Margin= Emission Level - Limit

2. If peak below the average limit, the average emission was no test.

3. The amplitude of spurious emissions which are attenuated by more than 20dB below the permissible value has no need to be reported.





**802.11n(40MHz)**

| Polar (H/V)         | Frequency | Meter Reading | Pre-amplifier | Cable Loss | Antenna Factor | Emission Level | Limits   | Margin | Detector Type |
|---------------------|-----------|---------------|---------------|------------|----------------|----------------|----------|--------|---------------|
|                     | (MHz)     | (dBuV)        | (dB)          | (dB)       | (dB)           | (dBuV/m)       | (dBuV/m) | (dB)   |               |
| Low Channel:2422MHz |           |               |               |            |                |                |          |        |               |
| V                   | 4844.00   | 63.11         | 39.55         | 7.77       | 25.66          | 56.99          | 74.00    | -17.01 | Pk            |
| V                   | 4844.00   | 49.13         | 39.55         | 7.77       | 25.66          | 43.01          | 54.00    | -10.99 | AV            |
| V                   | 7266.00   | 62.94         | 38.33         | 7.30       | 24.55          | 56.46          | 74.00    | -17.54 | Pk            |
| V                   | 7266.00   | 47.62         | 38.33         | 7.30       | 24.55          | 41.14          | 54.00    | -12.86 | AV            |
| H                   | 4844.00   | 62.46         | 39.55         | 7.77       | 25.66          | 56.34          | 74.00    | -17.66 | Pk            |
| H                   | 4844.00   | 45.86         | 39.55         | 7.77       | 25.66          | 39.74          | 54.00    | -14.26 | AV            |
| H                   | 7266.00   | 62.59         | 38.33         | 7.30       | 24.55          | 56.11          | 74.00    | -17.89 | Pk            |
| H                   | 7266.00   | 44.06         | 38.33         | 7.30       | 24.55          | 37.58          | 54.00    | -16.42 | AV            |

| Polar (H/V)            | Frequency | Meter Reading | Pre-amplifier | Cable Loss | Antenna Factor | Emission Level | Limits   | Margin | Detector Type |
|------------------------|-----------|---------------|---------------|------------|----------------|----------------|----------|--------|---------------|
|                        | (MHz)     | (dBuV)        | (dB)          | (dB)       | (dB)           | (dBuV/m)       | (dBuV/m) | (dB)   |               |
| Middle Channel:2437MHz |           |               |               |            |                |                |          |        |               |
| V                      | 4874.00   | 62.57         | 38.89         | 7.57       | 25.45          | 56.70          | 74.00    | -17.30 | PK            |
| V                      | 4874.00   | 50.13         | 38.89         | 7.57       | 25.45          | 44.26          | 54.00    | -9.74  | AV            |
| V                      | 7311.00   | 61.25         | 38.78         | 7.35       | 24.54          | 54.36          | 74.00    | -19.64 | PK            |
| V                      | 7311.00   | 49.72         | 38.78         | 7.35       | 24.54          | 42.83          | 54.00    | -11.17 | AV            |
| H                      | 4874.00   | 62.49         | 38.89         | 7.57       | 25.45          | 56.62          | 74.00    | -17.38 | PK            |
| H                      | 4874.00   | 47.63         | 38.89         | 7.57       | 25.45          | 41.76          | 54.00    | -12.24 | AV            |
| H                      | 7311.00   | 61.55         | 38.78         | 7.35       | 24.54          | 54.66          | 74.00    | -19.34 | PK            |
| H                      | 7311.00   | 47.10         | 38.78         | 7.35       | 24.54          | 40.21          | 54.00    | -13.79 | AV            |

| Polar (H/V)           | Frequency | Meter Reading | Pre-amplifier | Cable Loss | Antenna Factor | Emission Level | Limits   | Margin | Detector Type |
|-----------------------|-----------|---------------|---------------|------------|----------------|----------------|----------|--------|---------------|
|                       | (MHz)     | (dBuV)        | (dB)          | (dB)       | (dB)           | (dBuV/m)       | (dBuV/m) | (dB)   |               |
| High Channel: 2452MHz |           |               |               |            |                |                |          |        |               |
| V                     | 4904.00   | 61.92         | 38.75         | 7.38       | 25.41          | 55.96          | 74.00    | -18.04 | PK            |
| V                     | 4904.00   | 49.86         | 38.75         | 7.38       | 25.41          | 43.90          | 54.00    | -10.10 | AV            |
| V                     | 7356.00   | 60.62         | 38.65         | 7.15       | 24.52          | 53.64          | 74.00    | -20.36 | PK            |
| V                     | 7356.00   | 48.77         | 38.65         | 7.15       | 24.52          | 41.79          | 54.00    | -12.21 | AV            |
| H                     | 4904.00   | 60.58         | 38.75         | 7.38       | 25.41          | 54.62          | 74.00    | -19.38 | PK            |
| H                     | 4904.00   | 45.75         | 38.75         | 7.38       | 25.41          | 39.79          | 54.00    | -14.21 | AV            |
| H                     | 7356.00   | 60.70         | 38.65         | 7.15       | 24.52          | 53.72          | 74.00    | -20.28 | PK            |
| H                     | 7356.00   | 45.60         | 38.65         | 7.15       | 24.52          | 38.62          | 54.00    | -15.38 | AV            |

Remark:

1. Emission Level = Meter Reading + Antenna Factor + Cable Loss – Pre-amplifier,  
Margin= Emission Level - Limit
2. If peak below the average limit, the average emission was no test.
3. The amplitude of spurious emissions which are attenuated by more than 20dB below the permissible value has no need to be reported.
4. All the ANT have test, only the worst case reported.



### 3.3 RADIATED BAND EMISSION MEASUREMENT

#### 3.3.1 TEST REQUIREMENT:

FCC Part15 C Section 15.209 and 15.205

LIMITS OF RADIATED EMISSION MEASUREMENT (Above 1000MHz)

| FREQUENCY (MHz) | Class B (dBuV/m) (at 3M) |         |
|-----------------|--------------------------|---------|
|                 | PEAK                     | AVERAGE |
| Above 1000      | 74                       | 54      |

Notes:

- (1) The limit for radiated test was performed according to FCC PART 15C.
- (2) The tighter limit applies at the band edges.
- (3) Emission level (dBuV/m)=20log Emission level (uV/m).

| Spectrum Parameter                    | Setting  |
|---------------------------------------|--|
| Attenuation                           | Auto   |
| Start Frequency                       | 2300MHz  |
| Stop Frequency                        | 2520   |
| RB / VB (emission in restricted band) | 1 MHz / 1 MHz for Peak, 1 MHz / 10Hz for Average |

#### 3.3.2 TEST PROCEDURE

Above 1GHz test procedure as below:

- a. 1. The EUT was placed on the top of a rotating table 1.5 meters above the ground at a 3 meter camber. The table was rotated 360 degrees to determine the position of the highest radiation.
- b. The EUT was set 3 meters away from the interference-receiving antenna, which was mounted on the top of a variable-height antenna tower.
- c. The antenna height is varied from one meter to four meters above the ground to determine the maximum value of the field strength. Both horizontal and vertical polarizations of the antenna are set to make the measurement.
- d. For each suspected emission, the EUT was arranged to its worst case and then the antenna was tuned to heights from 1 meter to 4 meters and the rota table was turned from 0 degrees to 360 degrees to find the maximum reading.
- e. The test-receiver system was set to Peak Detect Function and Specified Bandwidth with Maximum Hold Mode.
- f. If the emission level of the EUT in peak mode was 10dB lower than the limit specified, then testing could be stopped and the peak values of the EUT would be reported. Otherwise the emissions that did not have 10dB margin would be re-tested one by one using peak, quasi-peak or average method as specified and then reported in a data sheet.
- g. Test the EUT in the lowest channel,the Highest channel

Note:

Both horizontal and vertical antenna polarities were tested and performed pretest to three orthogonal axis. The worst case emissions were reported

### 3.3.3 DEVIATION FROM TEST STANDARD

No deviation

### 3.3.4 TEST SETUP

Radiated Emission Test-Up Frequency Above 1GHz

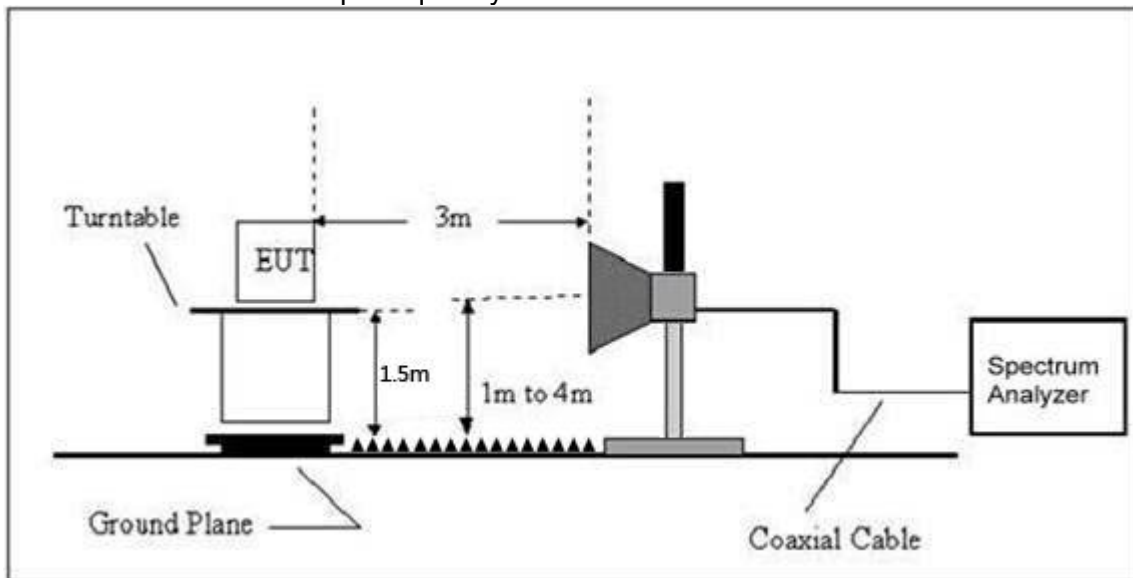

### 3.3.5 EUT OPERATING CONDITIONS

The EUT tested system was configured as the statements of 2.3 Unless otherwise a special operating condition is specified in the follows during the testing.



**3.3.6 TEST RESULT**

|  | Polar (H/V)                 | Frequency (MHz) | Meter Reading (dBuV) | Pre-amplifier (dB) | Cable Loss (dB) | Antenna Factor (dB/m) | Emission level (dBuV/m) | Limits (dBuV/m) |       | Result |
|--|-----------------------------|-----------------|----------------------|--------------------|-----------------|-----------------------|-------------------------|-----------------|-------|--------|
|  |                             |                 |                      |                    |                 |                       | PK                      | PK              | AV    |        |
| 802.11b  | <b>Low Channel 2412MHz</b>  |                 |                      |                    |                 |                       |                         |                 |       |        |
|  | H                           | 2390.00         | 60.54                | 38.06              | 7.42            | 20.15                 | 50.05                   | 74.00           | 54.00 | PASS   |
|  | H                           | 2400.00         | 56.89                | 38.06              | 7.42            | 20.15                 | 46.40                   | 74.00           | 54.00 | PASS   |
|  | V                           | 2390.00         | 61.74                | 38.06              | 7.42            | 20.15                 | 51.25                   | 74.00           | 54.00 | PASS   |
|  | V                           | 2400.00         | 59.53                | 38.06              | 7.42            | 20.15                 | 49.04                   | 74.00           | 54.00 | PASS   |
|  | <b>High Channel 2462MHz</b> |                 |                      |                    |                 |                       |                         |                 |       |        |
|  | H                           | 2483.50         | 58.67                | 38.17              | 7.45            | 20.54                 | 48.49                   | 74.00           | 54.00 | PASS   |
|  | H                           | 2485.50         | 60.55                | 38.17              | 7.45            | 20.54                 | 50.37                   | 74.00           | 54.00 | PASS   |
|  | V                           | 2483.50         | 60.97                | 38.20              | 7.45            | 20.54                 | 50.76                   | 74.00           | 54.00 | PASS   |
|  | V                           | 2485.50         | 61.47                | 38.20              | 7.45            | 20.54                 | 51.26                   | 74.00           | 54.00 | PASS   |
| 802.11g  | <b>Low Channel 2412MHz</b>  |                 |                      |                    |                 |                       |                         |                 |       |        |
|  | H                           | 2390.00         | 61.62                | 38.06              | 7.42            | 20.15                 | 51.13                   | 74.00           | 54.00 | PASS   |
|  | H                           | 2400.00         | 58.50                | 38.06              | 7.42            | 20.15                 | 48.01                   | 74.00           | 54.00 | PASS   |
|  | V                           | 2390.00         | 61.66                | 38.06              | 7.42            | 20.15                 | 51.17                   | 74.00           | 54.00 | PASS   |
|  | V                           | 2400.00         | 60.33                | 38.06              | 7.42            | 20.15                 | 49.84                   | 74.00           | 54.00 | PASS   |
|  | <b>High Channel 2462MHz</b> |                 |                      |                    |                 |                       |                         |                 |       |        |
|  | H                           | 2483.50         | 58.79                | 38.06              | 7.42            | 20.15                 | 48.30                   | 74.00           | 54.00 | PASS   |
|  | H                           | 2485.50         | 56.46                | 38.06              | 7.42            | 20.15                 | 45.97                   | 74.00           | 54.00 | PASS   |
|  | V                           | 2483.50         | 60.60                | 38.06              | 7.42            | 20.15                 | 50.11                   | 74.00           | 54.00 | PASS   |
|  | V                           | 2485.50         | 61.11                | 38.06              | 7.42            | 20.15                 | 50.62                   | 74.00           | 54.00 | PASS   |
| 802.11n20  | <b>Low Channel 2412MHz</b>  |                 |                      |                    |                 |                       |                         |                 |       |        |
|  | H                           | 2390.00         | 60.71                | 38.17              | 7.45            | 20.54                 | 50.53                   | 74.00           | 54.00 | PASS   |
|  | H                           | 2400.00         | 61.04                | 38.17              | 7.45            | 20.54                 | 50.86                   | 74.00           | 54.00 | PASS   |
|  | V                           | 2390.00         | 59.99                | 38.20              | 7.45            | 20.54                 | 49.78                   | 74.00           | 54.00 | PASS   |
|  | V                           | 2400.00         | 61.80                | 38.20              | 7.45            | 20.54                 | 51.59                   | 74.00           | 54.00 | PASS   |
|  | <b>High Channel 2462MHz</b> |                 |                      |                    |                 |                       |                         |                 |       |        |
|  | H                           | 2483.50         | 60.38                | 38.17              | 7.45            | 20.54                 | 50.20                   | 74.00           | 54.00 | PASS   |
|  | H                           | 2485.50         | 61.09                | 38.17              | 7.45            | 20.54                 | 50.91                   | 74.00           | 54.00 | PASS   |
|  | V                           | 2483.50         | 58.31                | 38.20              | 7.45            | 20.54                 | 48.10                   | 74.00           | 54.00 | PASS   |
|  | V                           | 2485.50         | 61.67                | 38.20              | 7.45            | 20.54                 | 51.46                   | 74.00           | 54.00 | PASS   |
| 802.11n40  | <b>Low Channel 2422MHz</b>  |                 |                      |                    |                 |                       |                         |                 |       |        |
|  | H                           | 2390.00         | 60.32                | 38.06              | 7.42            | 20.15                 | 49.83                   | 74.00           | 54.00 | PASS   |
|  | H                           | 2400.00         | 57.51                | 38.06              | 7.42            | 20.15                 | 47.02                   | 74.00           | 54.00 | PASS   |
|  | V                           | 2390.00         | 57.70                | 38.06              | 7.42            | 20.15                 | 47.21                   | 74.00           | 54.00 | PASS   |
|  | V                           | 2400.00         | 62.28                | 38.06              | 7.42            | 20.15                 | 51.79                   | 74.00           | 54.00 | PASS   |
|  | <b>High Channel 2452MHz</b> |                 |                      |                    |                 |                       |                         |                 |       |        |
|  | H                           | 2483.50         | 58.63                | 38.17              | 7.45            | 20.54                 | 48.45                   | 74.00           | 54.00 | PASS   |
|  | H                           | 2485.50         | 59.73                | 38.17              | 7.45            | 20.54                 | 49.55                   | 74.00           | 54.00 | PASS   |
|  | V                           | 2483.50         | 59.82                | 38.20              | 7.45            | 20.54                 | 49.61                   | 74.00           | 54.00 | PASS   |
|  | V                           | 2485.50         | 60.25                | 38.20              | 7.45            | 20.54                 | 50.04                   | 74.00           | 54.00 | PASS   |
| <b>Remark:</b>   |                             |                 |                      |                    |                 |                       |                         |                 |       |        |
| 1. Emission Level = Meter Reading + Antenna Factor + Cable Loss – Pre-amplifier, Margin= Emission Level - Limit          |                             |                 |                      |                    |                 |                       |                         |                 |       |        |
| 2. If the PK measured levels comply with average limit, then the average level were deemed to comply with average limit. |                             |                 |                      |                    |                 |                       |                         |                 |       |        |



## 4. POWER SPECTRAL DENSITY TEST

### 4.1 APPLIED PROCEDURES / LIMIT

| FCC Part15 (15.247) , Subpart C |                        |                        |                       |        |
|---------------------------------|------------------------|------------------------|-----------------------|--------|
| Section                         | Test Item              | Limit                  | Frequency Range (MHz) | Result |
| 15.247                          | Power Spectral Density | 8 dBm<br>(in any 3KHz) | 2400-2483.5           | PASS   |

#### 4.1.1 TEST PROCEDURE

1. Set analyzer center frequency to DTS channel center frequency.
2. Set the span to 1.5 times the DTS bandwidth.
3. Set the RBW to:  $3 \text{ kHz} \leq \text{RBW} \leq 100 \text{ kHz}$ .
4. Set the VBW  $\geq 3 \times \text{RBW}$ .
5. Detector = peak.
6. Sweep time = auto couple.
7. Trace mode = max hold.
8. Allow trace to fully stabilize.
9. Use the peak marker function to determine the maximum amplitude level within the RBW.
10. If measured value exceeds limit, reduce RBW (no less than 3 kHz) and repeat.

#### 4.1.2 DEVIATION FROM STANDARD

No deviation.

#### 4.1.3 TEST SETUP

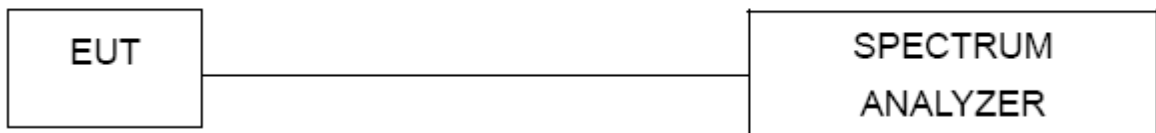

#### 4.1.4 EUT OPERATION CONDITIONS

The EUT tested system was configured as the statements of 2.1 Unless otherwise a special operating condition is specified in the follows during the testing.

Note: Power Spectral Density(dBm)=Reading+Cable Loss



4.1.5 TEST RESULTS

|               |           |                     |             |
|---------------|-----------|---------------------|-------------|
| Temperature : | 26°C      | Relative Humidity : | 54%         |
| Pressure :    | 101kPa    | Test Voltage :      | AC120V/60Hz |
| Test Mode :   | TX b Mode |                     |             |

| Frequency | Power Spectral Density(dBm/3k Hz) | Limit (dBm/3kHz) | Result |
|-----------|-----------------------------------|------------------|--------|
| 2412 MHz  | -7.305                            | 8                | PASS   |
| 2437 MHz  | -5.914                            | 8                | PASS   |
| 2462 MHz  | -5.921                            | 8                | PASS   |

TX CH01





### TX CH06



### TX CH11





|               |           |                     |             |
|---------------|-----------|---------------------|-------------|
| Temperature : | 26°C      | Relative Humidity : | 54%         |
| Pressure :    | 101kPa    | Test Voltage :      | AC120V/60Hz |
| Test Mode :   | TX g Mode |                     |             |

| Frequency | Power Spectral Density(dBm/3k Hz) | Limit (dBm/3kHz) | Result |
|-----------|-----------------------------------|------------------|--------|
| 2412 MHz  | -23.571                           | 8                | PASS   |
| 2437 MHz  | -24.584                           | 8                | PASS   |
| 2462 MHz  | -23.406                           | 8                | PASS   |

TX CH01

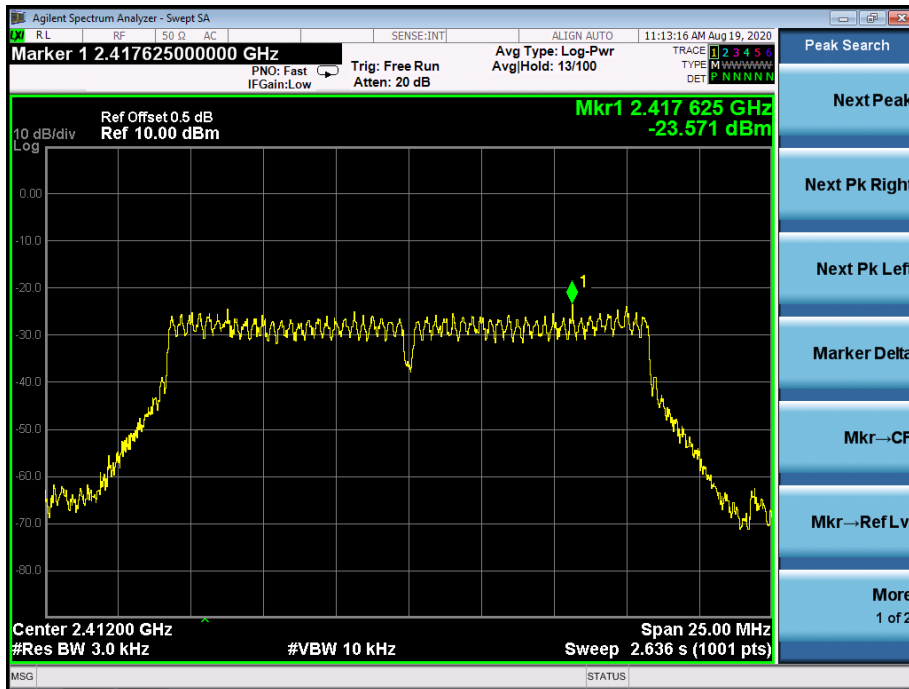





TX CH06

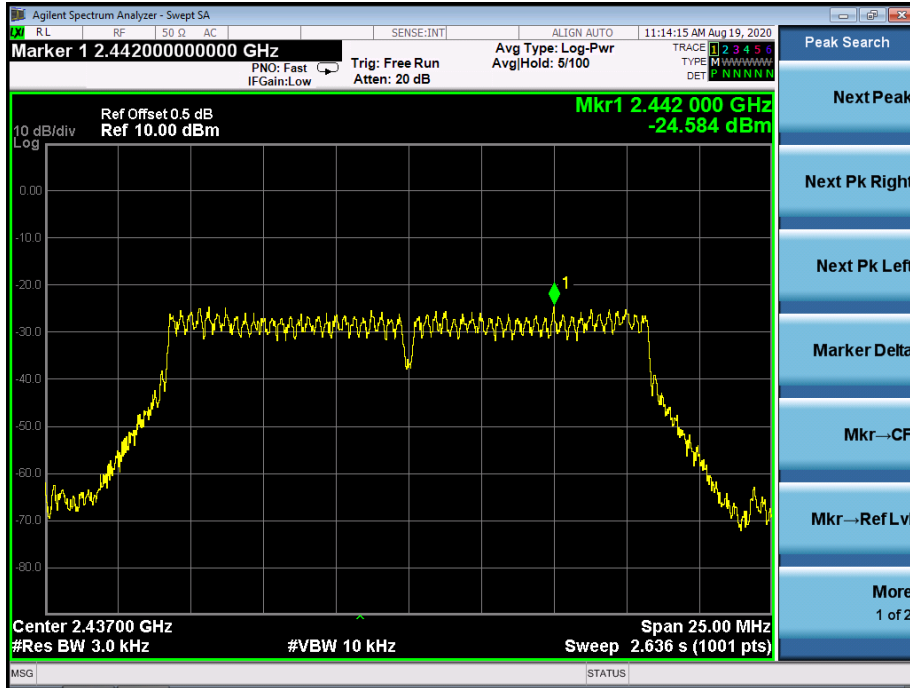

TX CH11

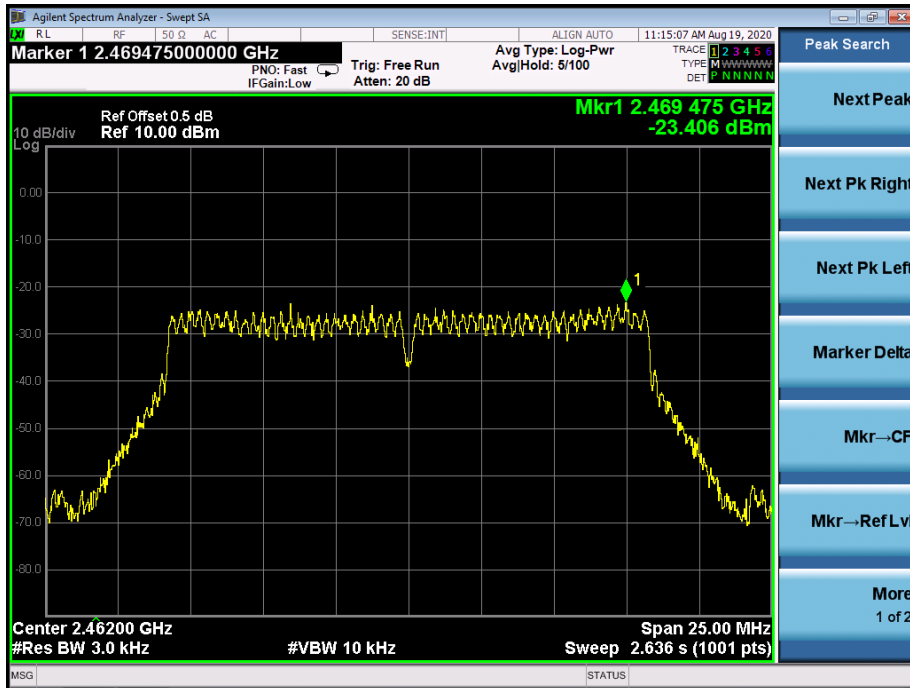



|               |                |                     |             |
|---------------|----------------|---------------------|-------------|
| Temperature : | 26°C           | Relative Humidity : | 54%         |
| Pressure :    | 101kPa         | Test Voltage :      | AC120V/60Hz |
| Test Mode :   | TX n Mode(20M) |                     |             |

| Frequency | Power Spectral Density(dBm/3k Hz) | Limit (dBm/3kHz) | Result |
|-----------|-----------------------------------|------------------|--------|
| 2412 MHz  | -25.586                           | 8                | PASS   |
| 2437 MHz  | -25.163                           | 8                | PASS   |
| 2462 MHz  | -23.990                           | 8                | PASS   |

TX CH01

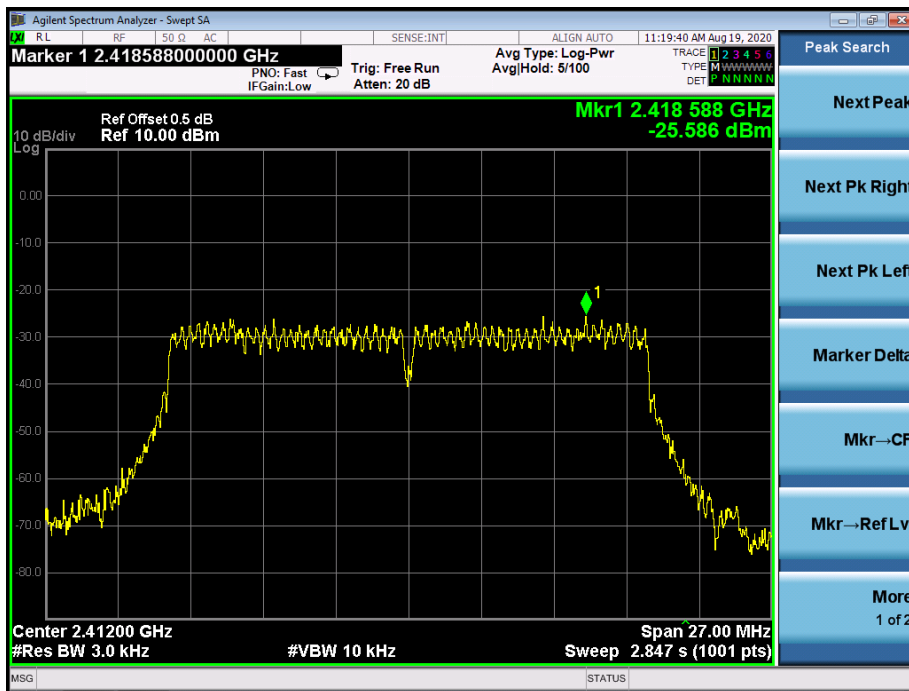



TX CH06

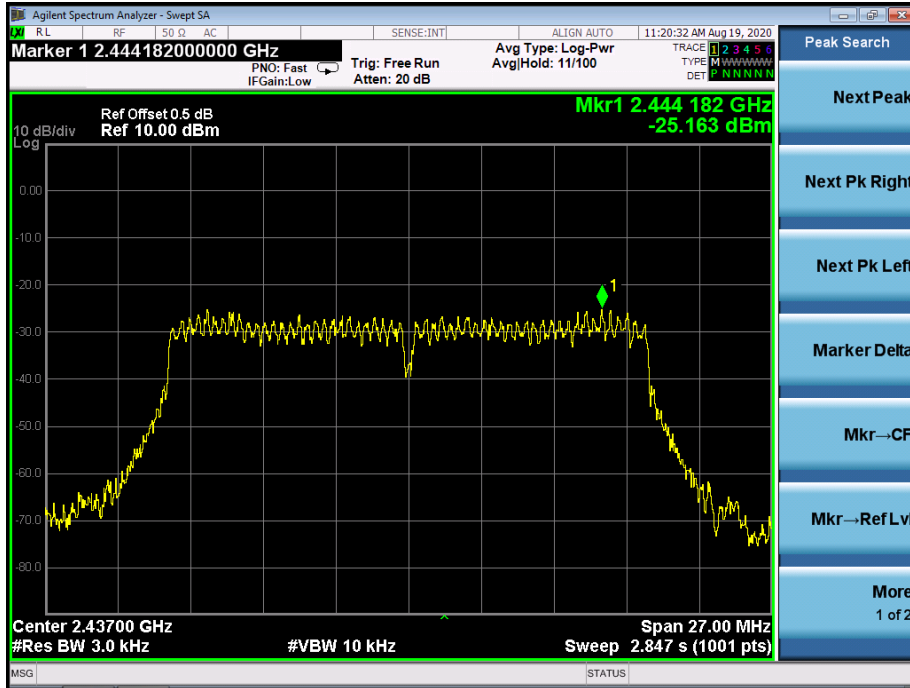

TX CH11

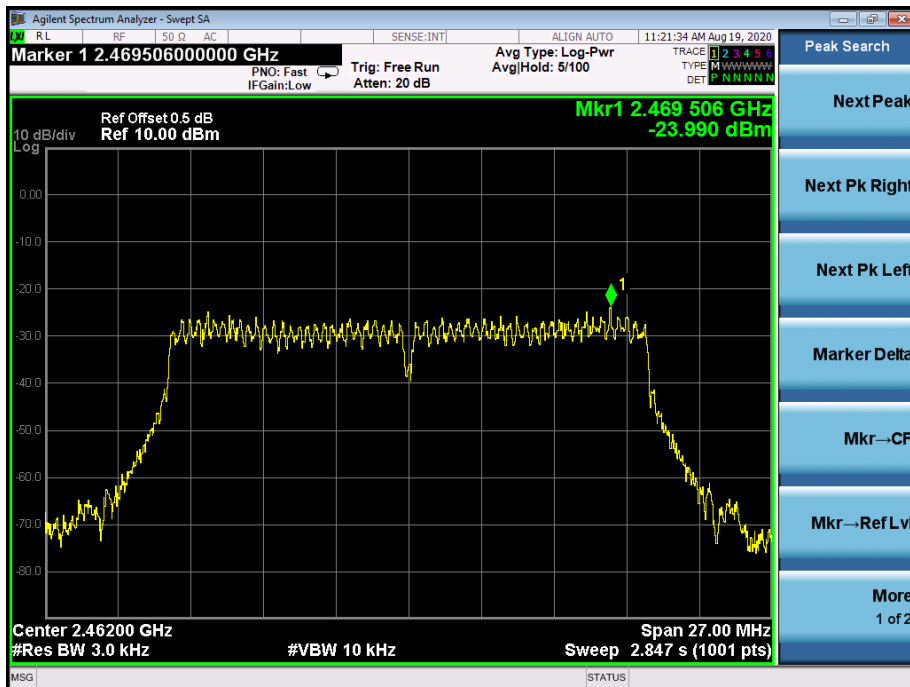



|               |                |                     |             |
|---------------|----------------|---------------------|-------------|
| Temperature : | 26°C           | Relative Humidity : | 54%         |
| Pressure :    | 101kPa         | Test Voltage :      | AC120V/60Hz |
| Test Mode :   | TX n Mode(40M) |                     |             |

| Frequency | Power Spectral Density(dBm/3k Hz) | Limit (dBm/3kHz) | Result |
|-----------|-----------------------------------|------------------|--------|
| 2422 MHz  | -26.233                           | 8                | PASS   |
| 2437 MHz  | -24.694                           | 8                | PASS   |
| 2452 MHz  | -25.078                           | 8                | PASS   |

**TX CH03**

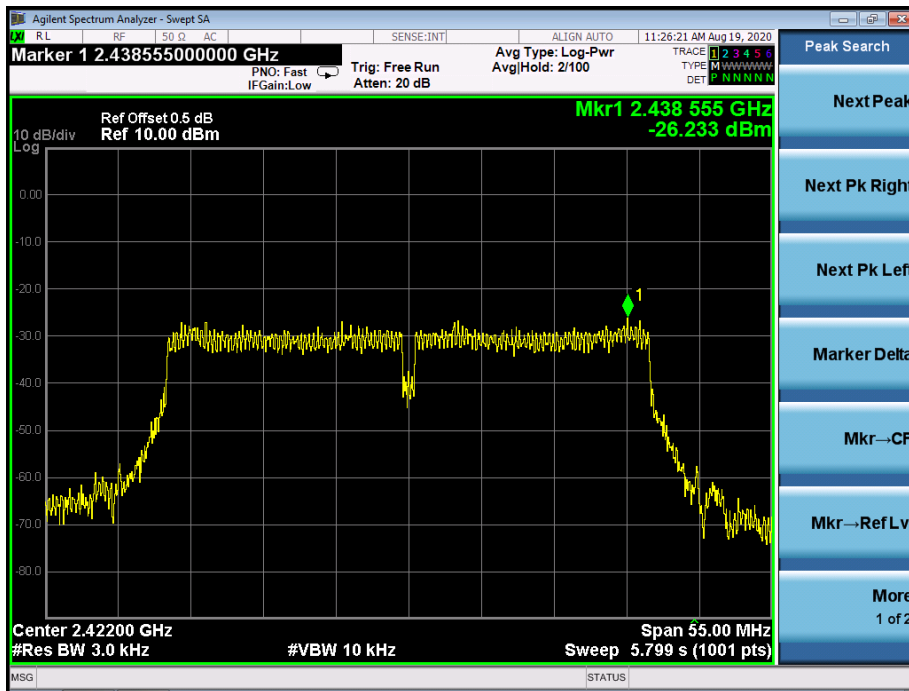



TX CH06

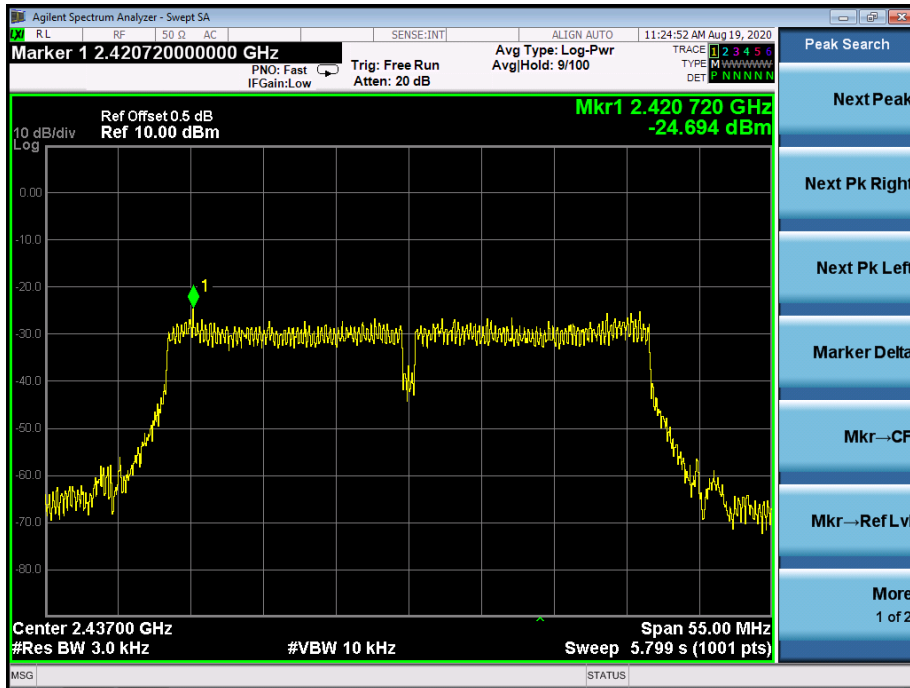

TX CH09

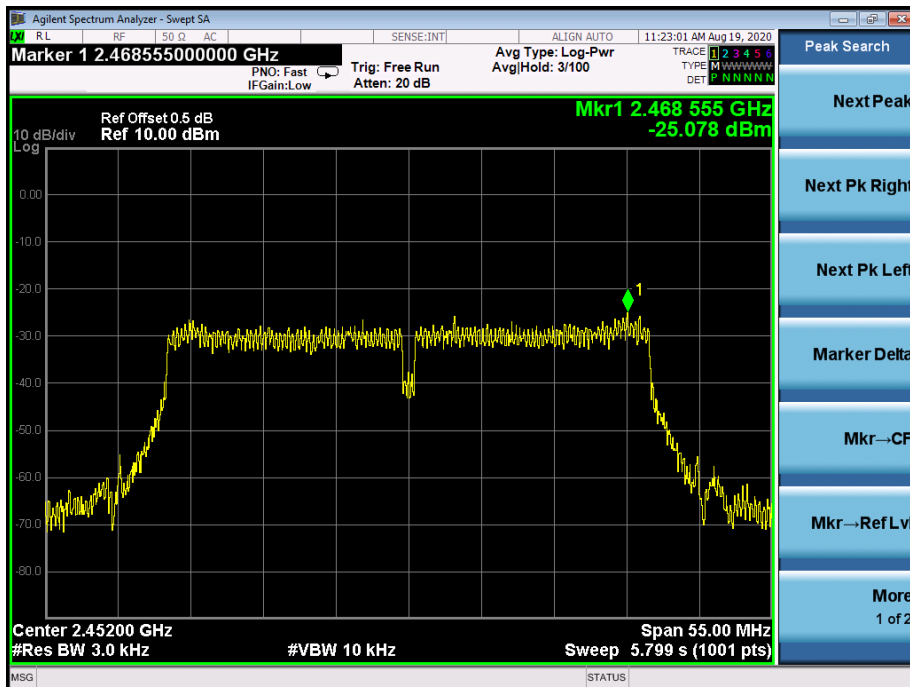

## 5. BANDWIDTH TEST

### 5.1 APPLIED PROCEDURES / LIMIT

| FCC Part15 (15.247) , Subpart C |           |   |                       |        |
|---------------------------------|-----------|---|-----------------------|--------|
| Section                         | Test Item | Limit                                   | Frequency Range (MHz) | Result |
| 15.247(a)(2)                    | Bandwidth | $\geq 500\text{KHz}$<br>(6dB bandwidth) | 2400-2483.5           | PASS   |

#### 5.1.1 TEST PROCEDURE

1. Set RBW = 100 kHz.
2. Set the video bandwidth (VBW)  $\geq 3 \times$  RBW.
3. Detector = Peak.
4. Trace mode = max hold.
5. Sweep = auto couple.
6. Allow the trace to stabilize.
7. Measure the maximum width of the emission that is constrained by the frequencies associated with the two outermost amplitude points (upper and lower frequencies) that are attenuated by 6 dB relative to the maximum level measured in the fundamental emission.

#### 5.1.2 DEVIATION FROM STANDARD

No deviation.

#### 5.1.3 TEST SETUP

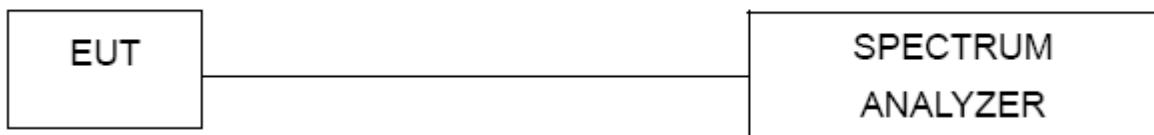

#### 5.1.4 EUT OPERATION CONDITIONS

The EUT tested system was configured as the statements of 2.4 Unless otherwise a special operating condition is specified in the follows during the testing.

**5.1.5 TEST RESULTS**

|               |           |                     |             |
|---------------|-----------|---------------------|-------------|
| Temperature : | 26°C      | Relative Humidity : | 54%         |
| Pressure :    | 101kPa    | Test Voltage :      | AC120V/60Hz |
| Test Mode :   | TX b Mode |                     |             |

| Frequency (MHz) | 6dB bandwidth (MHz) | Limit (kHz) | Result |
|-----------------|---------------------|-------------|--------|
| 2412            | 10.10               | 500         | Pass   |
| 2437            | 10.10               | 500         | Pass   |
| 2462            | 10.09               | 500         | Pass   |

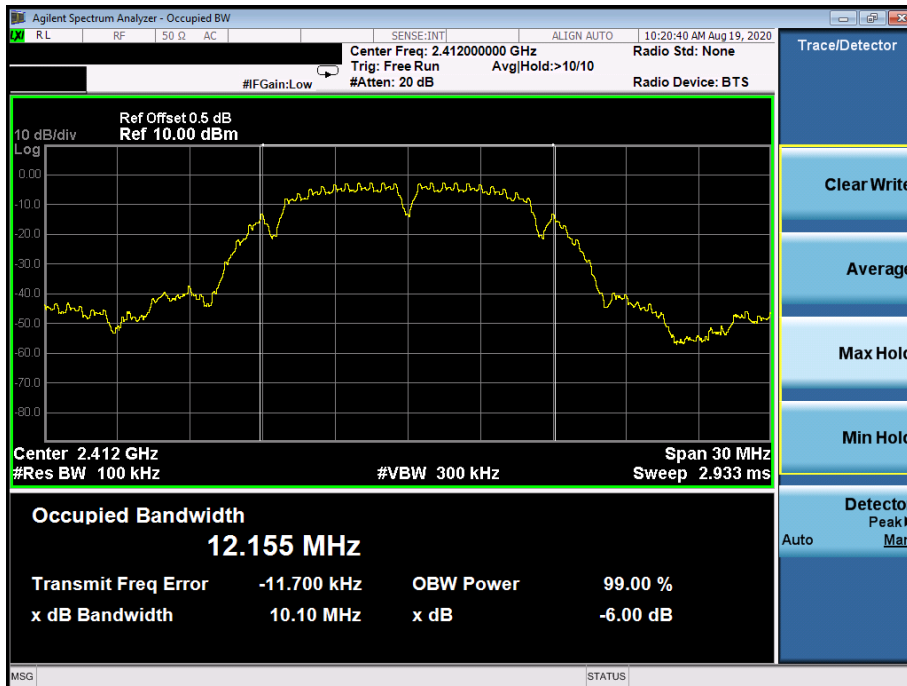
**TX CH 01**



**TX CH 06**

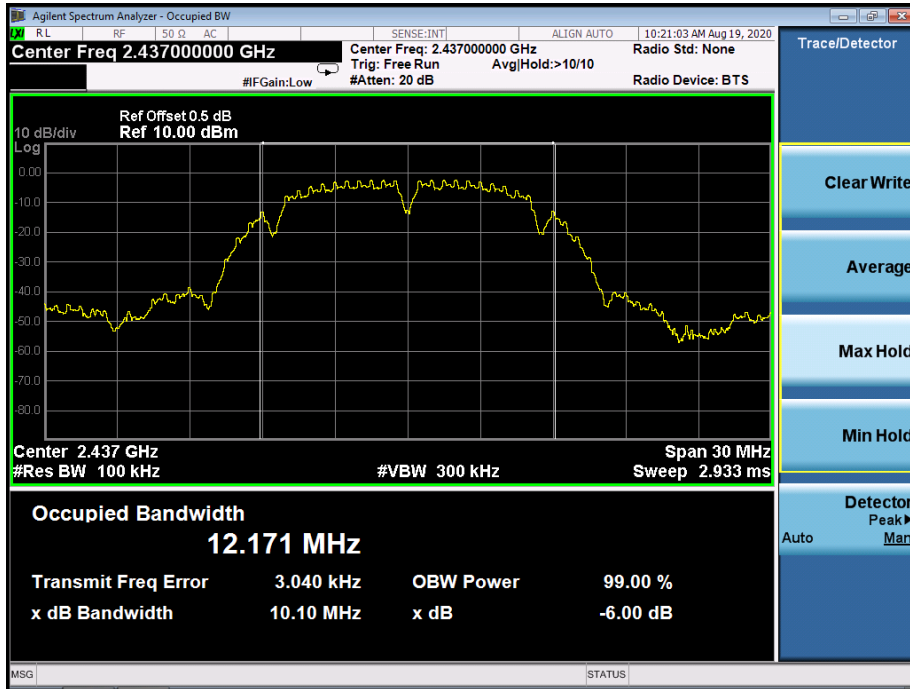

**TX CH 11**

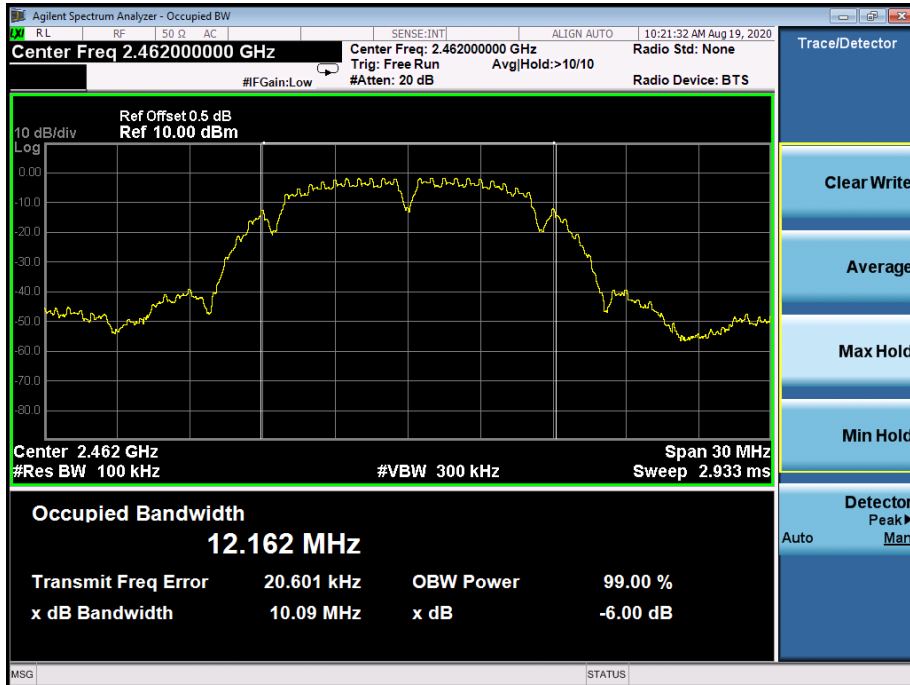





|               |           |                     |             |
|---------------|-----------|---------------------|-------------|
| Temperature : | 26°C      | Relative Humidity : | 54%         |
| Pressure :    | 101kPa    | Test Voltage :      | AC120V/60Hz |
| Test Mode :   | TX g Mode |                     |             |

| Frequency (MHz) | 6dB bandwidth (MHz) | Limit (kHz) | Result |
|-----------------|---------------------|-------------|--------|
| 2412            | 16.40               | 500         | Pass   |
| 2437            | 16.40               | 500         | Pass   |
| 2462            | 16.39               | 500         | Pass   |

**TX CH 01**

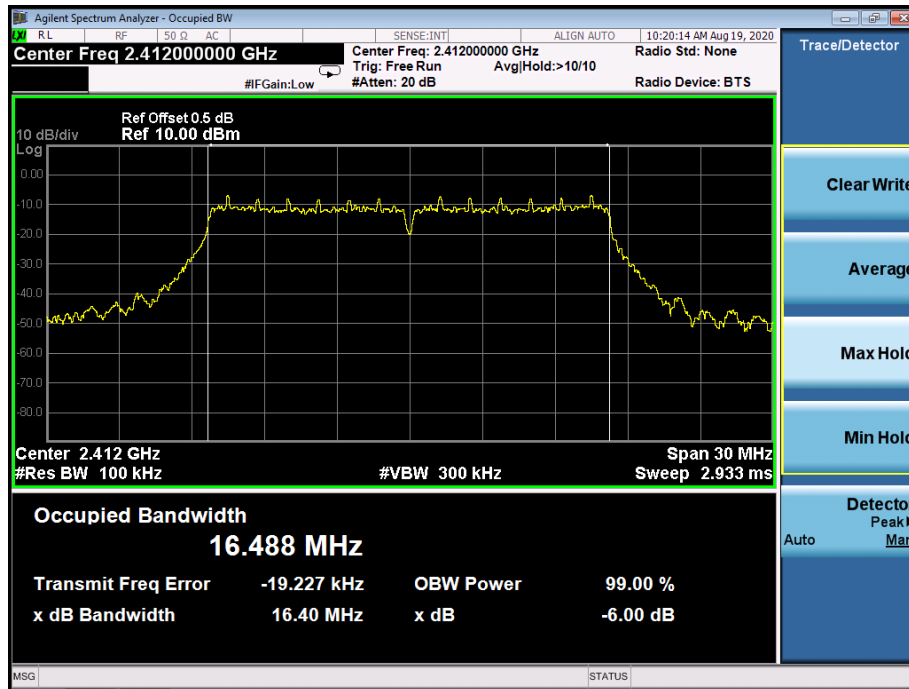



**TX CH 06**

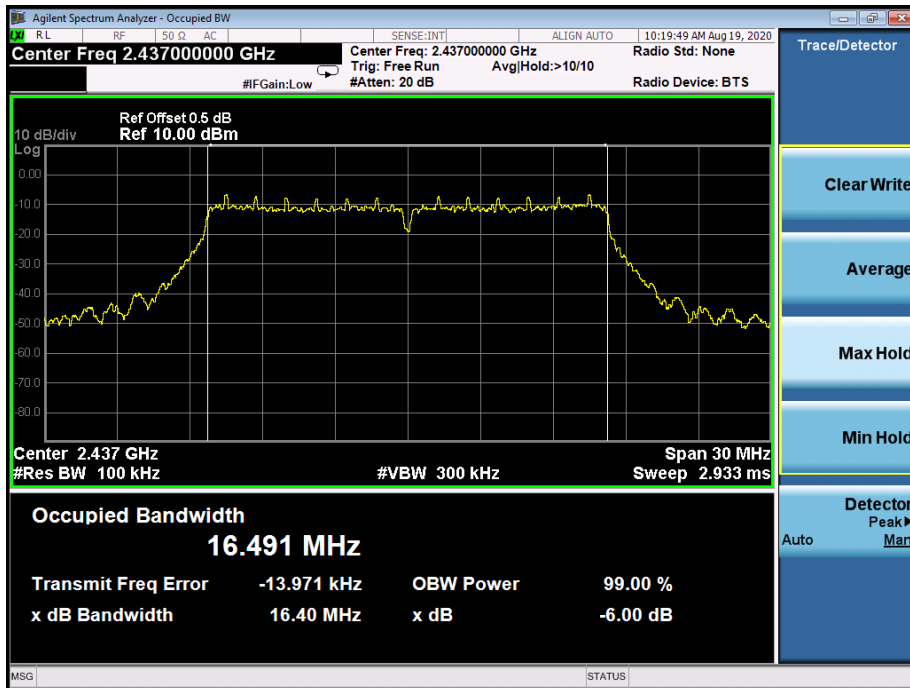

**TX CH 11**

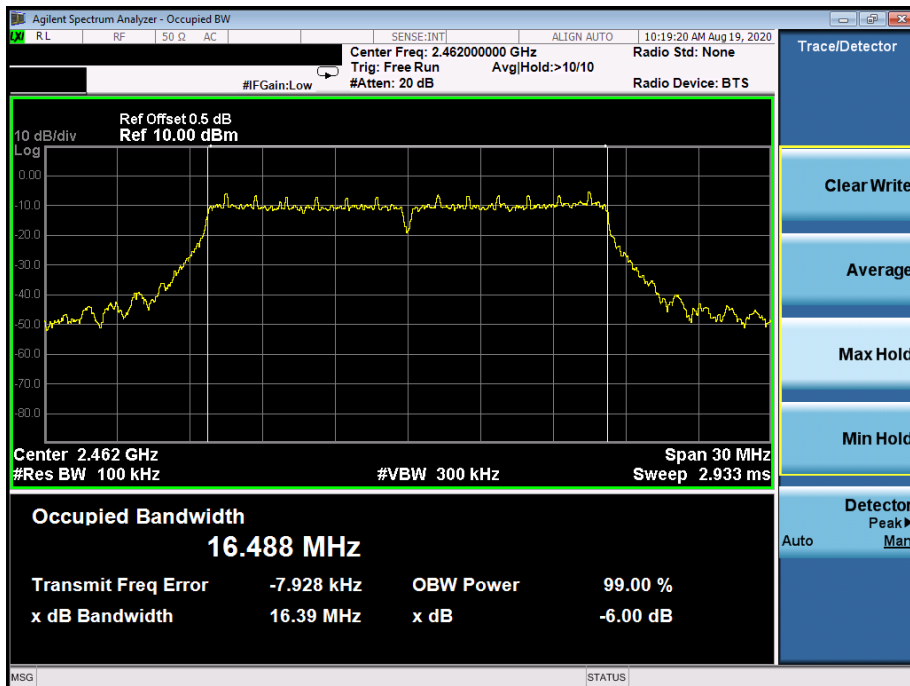



|               |                |                     |             |
|---------------|----------------|---------------------|-------------|
| Temperature : | 26°C           | Relative Humidity : | 54%         |
| Pressure :    | 101kPa         | Test Voltage :      | AC120V/60Hz |
| Test Mode :   | TX n Mode(20M) |                     |             |

| Frequency (MHz) | 6dB bandwidth (MHz) | Limit (kHz) | Result |
|-----------------|---------------------|-------------|--------|
| 2412            | 17.57               | 500         | Pass   |
| 2437            | 17.38               | 500         | Pass   |
| 2462            | 17.33               | 500         | Pass   |

**TX CH 01**

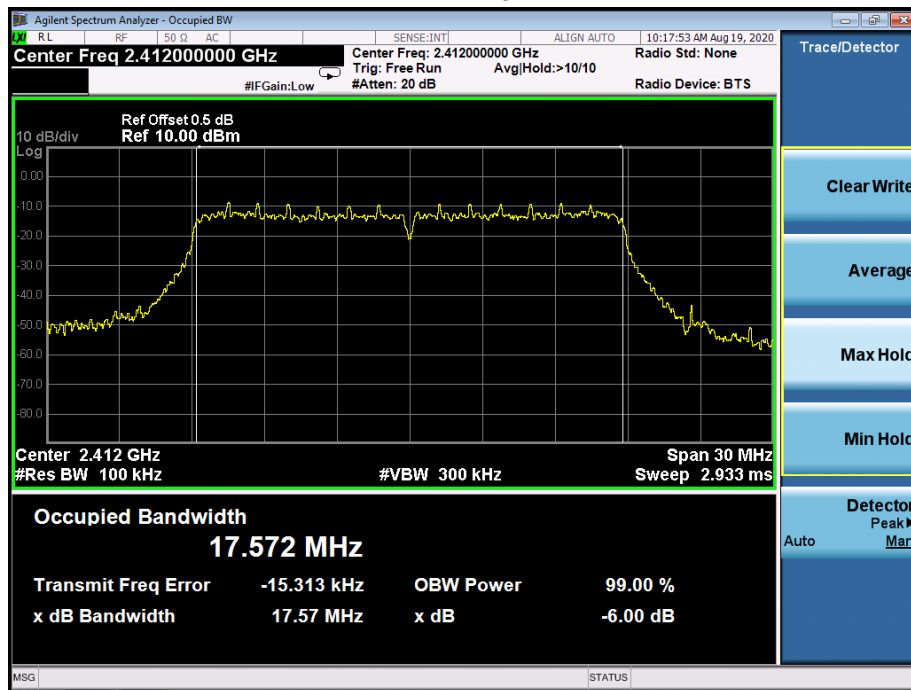



**TX CH 06**

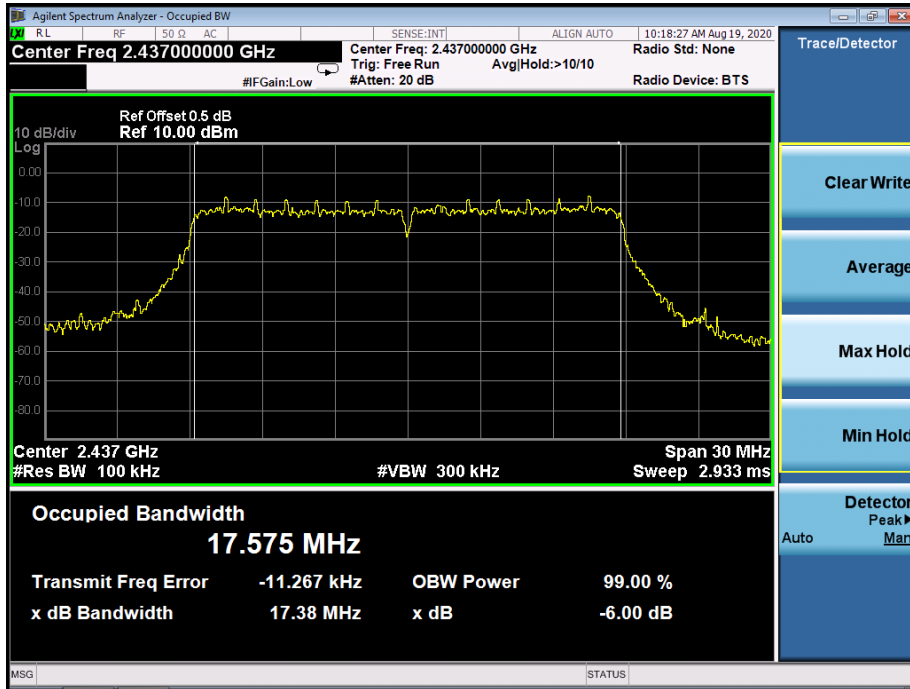

**TX CH 11**

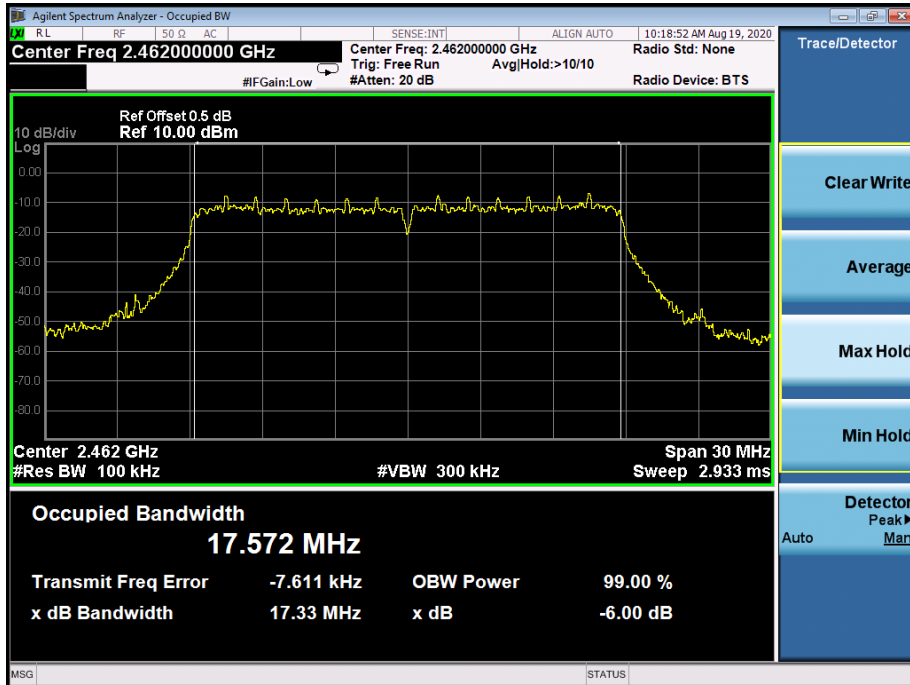



|               |                |                     |             |
|---------------|----------------|---------------------|-------------|
| Temperature : | 26°C           | Relative Humidity : | 54%         |
| Pressure :    | 101kPa         | Test Voltage :      | AC120V/60Hz |
| Test Mode :   | TX n Mode(40M) |                     |             |

| Frequency (MHz) | 6dB bandwidth (MHz) | Limit (kHz) | Result |
|-----------------|---------------------|-------------|--------|
| 2422            | 36.09               | 500         | Pass   |
| 2437            | 36.09               | 500         | Pass   |
| 2452            | 36.39               | 500         | Pass   |

**TX CH 03**

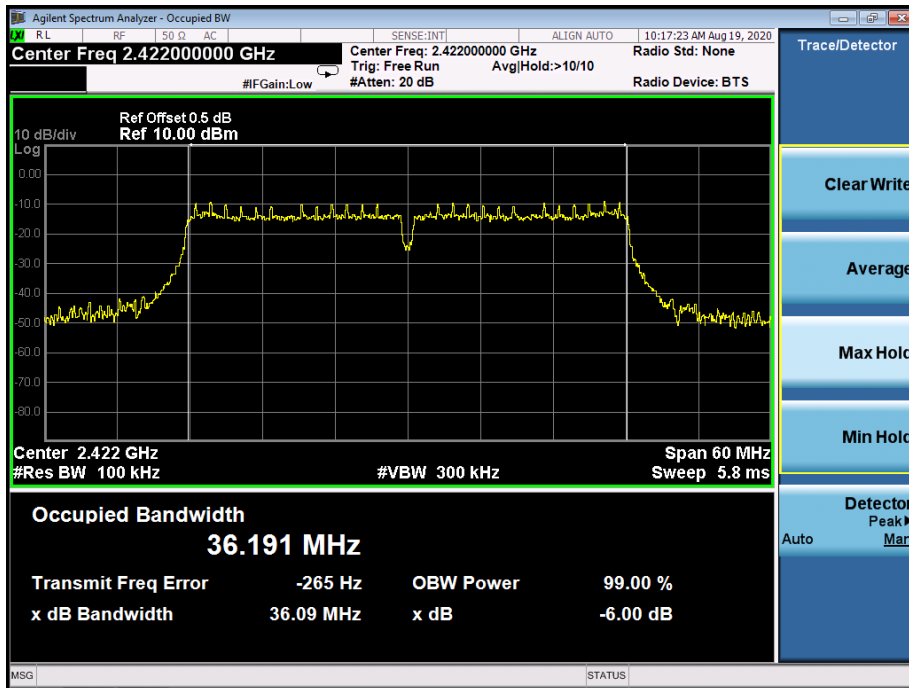



**TX CH 06**

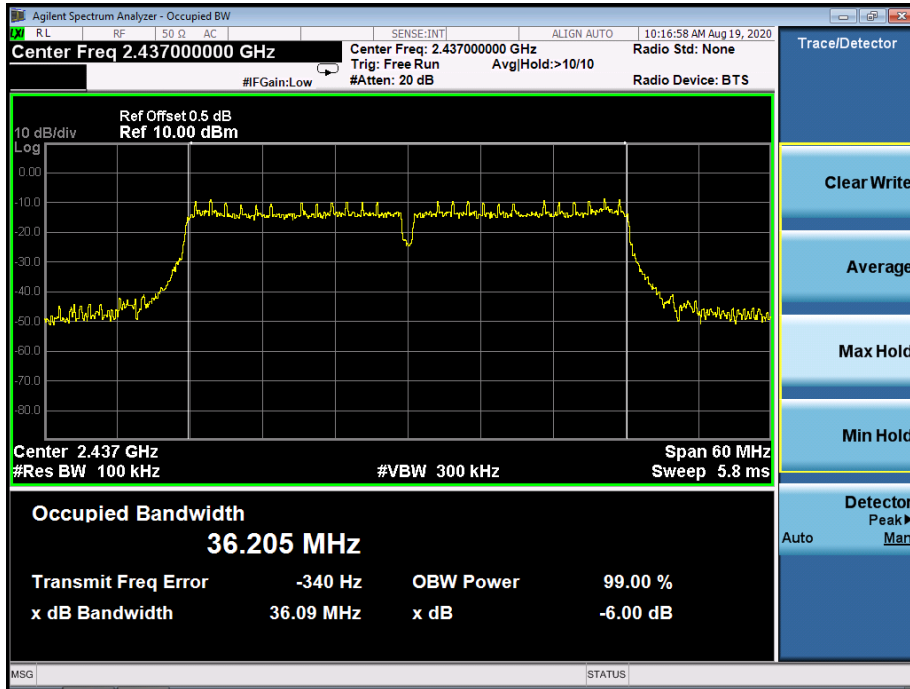

**TX CH 09**

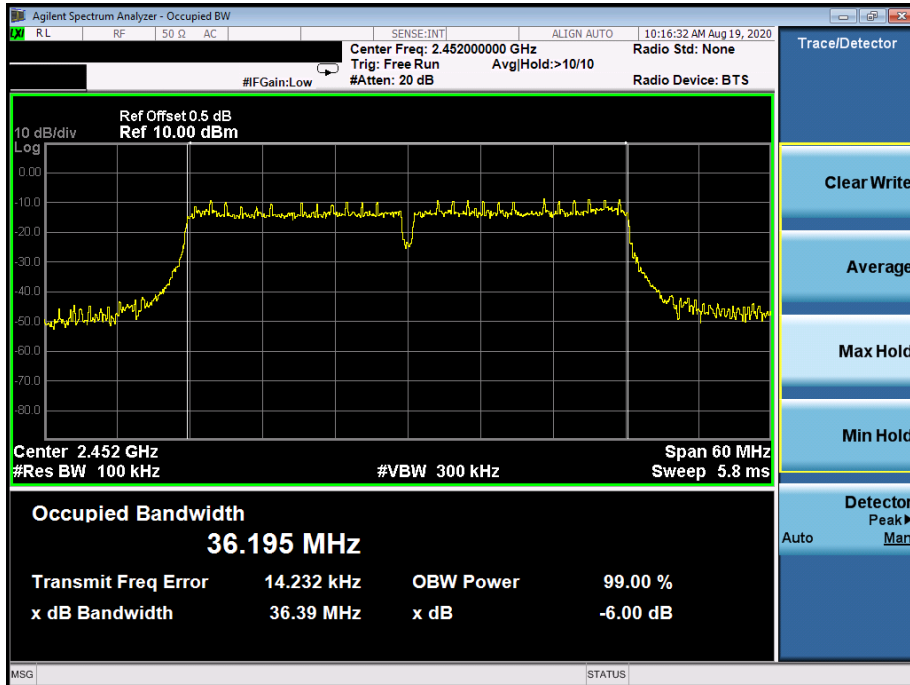



## 6. PEAK OUTPUT POWER TEST

### 6.1 APPLIED PROCEDURES/LIMIT

| FCC Part15 (15.247) , Subpart C |                   |                 |                       |        |
|---------------------------------|-------------------|-----------------|-----------------------|--------|
| Section                         | Test Item         | Limit           | Frequency Range (MHz) | Result |
| 15.247(b)(3)                    | Peak Output Power | 1 watt or 30dBm | 2400-2483.5           | PASS   |

#### 6.1.1 TEST PROCEDURE

- a. The EUT was directly connected to the Power meter

#### 6.1.2 DEVIATION FROM STANDARD

No deviation.

#### 6.1.3 TEST SETUP



#### 6.1.4 EUT OPERATION CONDITIONS

The EUT tested system was configured as the statements of 2.4 Unless otherwise a special operating condition is specified in the follows during the testing.



**6.1.5 TEST RESULTS**

|               |        |                     |             |
|---------------|--------|---------------------|-------------|
| Temperature : | 26°C   | Relative Humidity : | 54%         |
| Pressure :    | 101kPa | Test Voltage :      | AC120V/60Hz |

|           | Frequency | Maximum Conducted Output Power(PK) | LIMIT |
|-----------|-----------|------------------------------------|-------|
|           | (MHz)     | (dBm)                              | dBm   |
| 802.11b   | 2412      | 8.72                               | 30    |
|           | 2437      | 9.24                               | 30    |
|           | 2462      | 9.77                               | 30    |
| 802.11g   | 2412      | 7.58                               | 30    |
|           | 2437      | 7.67                               | 30    |
|           | 2462      | 8.24                               | 30    |
| 802.11n20 | 2412      | 6.28                               | 30    |
|           | 2437      | 6.43                               | 30    |
|           | 2462      | 6.93                               | 30    |
| 802.11n40 | 2422      | 4.87                               | 30    |
|           | 2437      | 4.96                               | 30    |
|           | 2452      | 5.09                               | 30    |





## 7. 100 KHZ BANDWIDTH OF FREQUENCY BAND EDGE

### 7.1 APPLICABLE STANDARD

in any 100 kHz bandwidth outside the frequency bands in which the spread spectrum intentional radiator is operating, the radio frequency power that is produced by the intentional radiator shall be at least 20dB below that in the 100kHz bandwidth within the band that contains the highest level of the desired power, In addition, radiated emissions which fall in the restricted bands, as defined in§15.205(a), must also comply with the radiated emission limits specified in15.209(a).

### 7.2 TEST PROCEDURE

Using the following spectrum analyzer setting:

- a) Set the RBW = 100KHz.
- b) Set the VBW = 300KHz.
- c) Sweep time = auto couple.
- d) Detector function = peak.
- e) Trace mode = max hold.
- f) Allow trace to fully stabilize.

### 7.3 DEVIATION FROM STANDARD

No deviation.

### 7.4 TEST SETUP

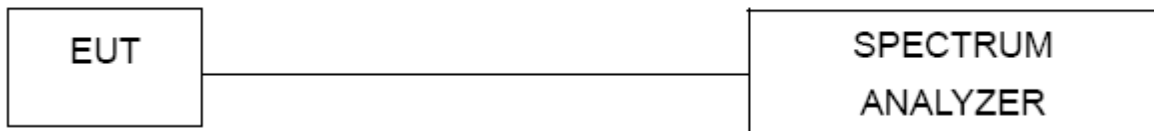

### 7.5 EUT OPERATION CONDITIONS

The EUT tested system was configured as the statements of 2.4 Unless otherwise a special operating condition is specified in the follows during the testing.

### 7.6 TEST RESULTS



802.11b: Band Edge, Left Side

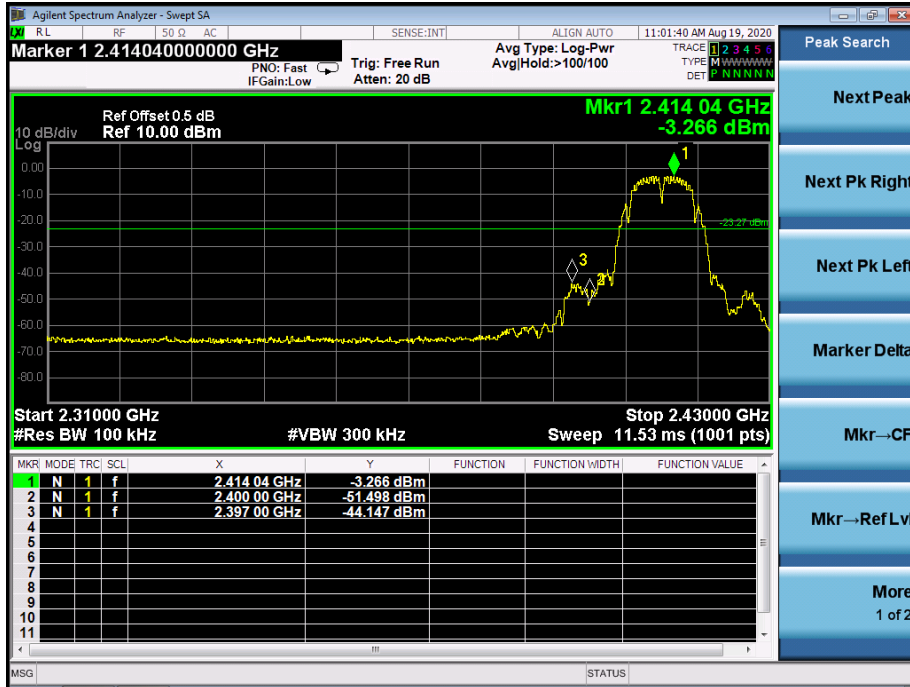

802.11b: Band Edge, Right Side





802.11g: Band Edge, Left Side

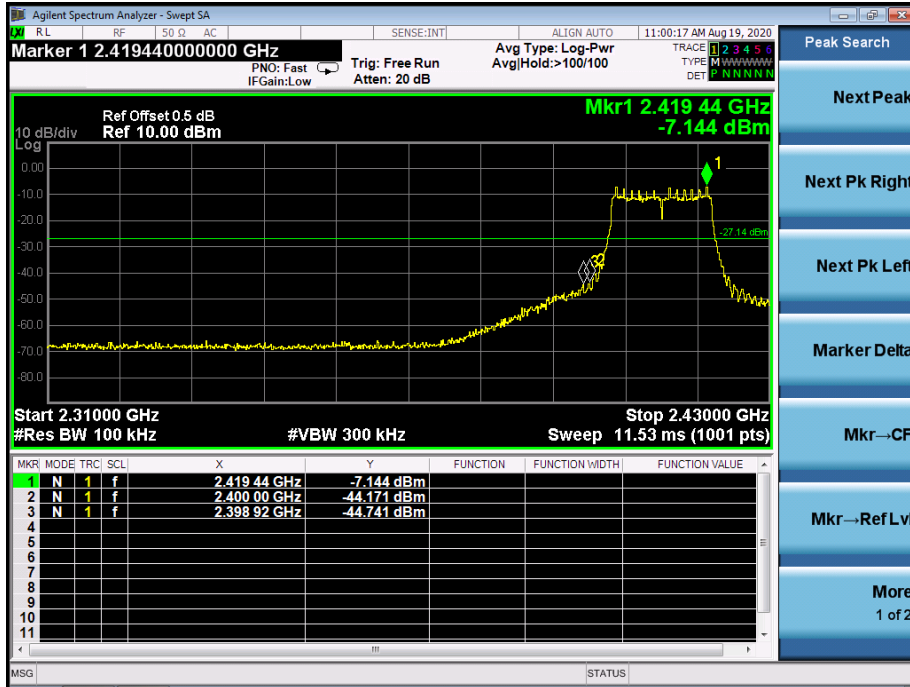

802.11g: Band Edge, Right Side

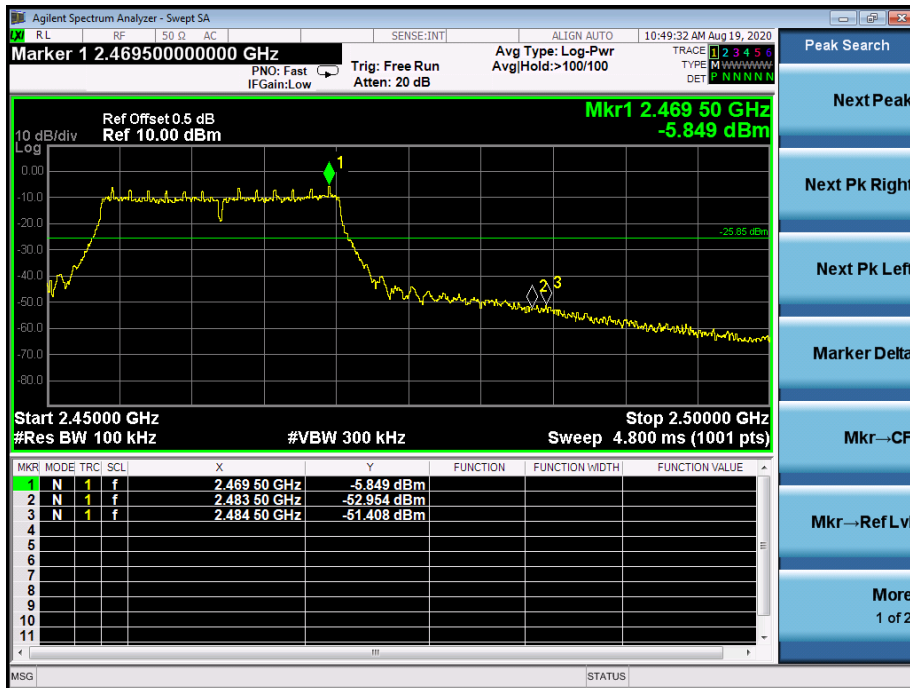



802.11n-HT20: Band Edge, Left Side

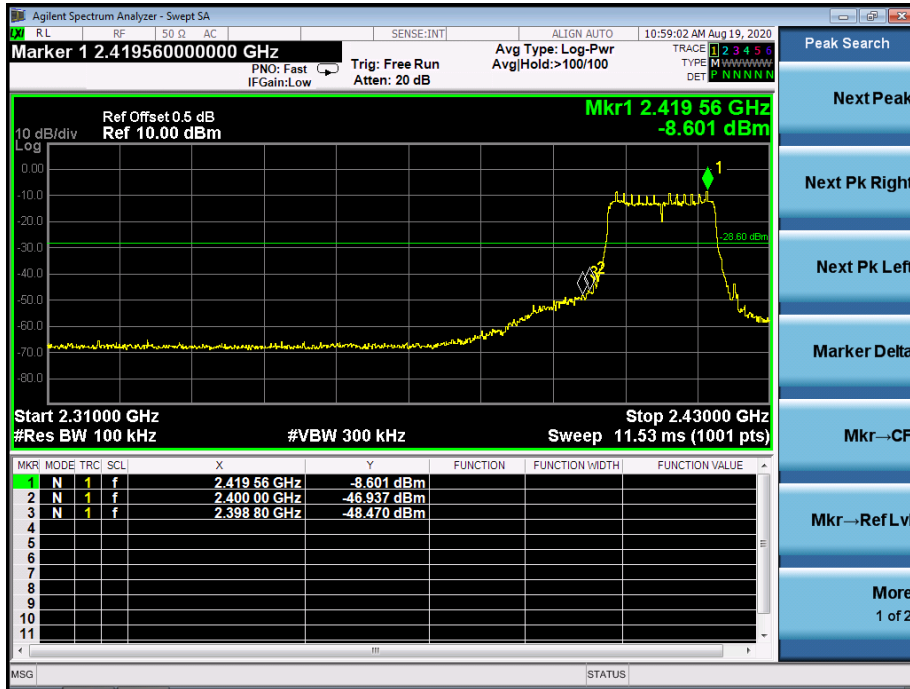

802.11n-HT20: Band Edge, Right Side

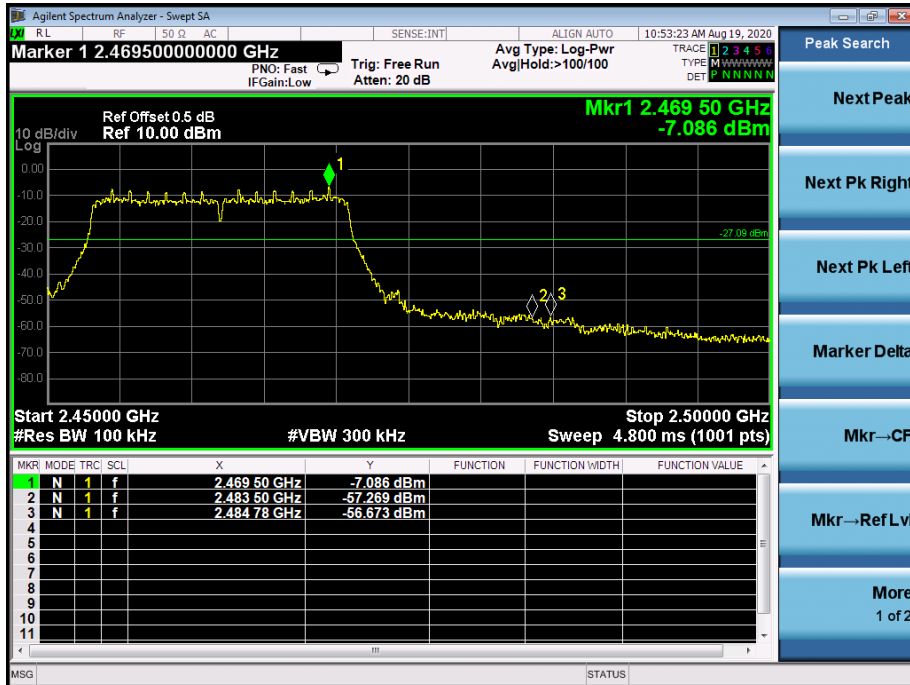



802.11n-HT40: Band Edge, Left Side



802.11n-HT40: Band Edge, Right Side

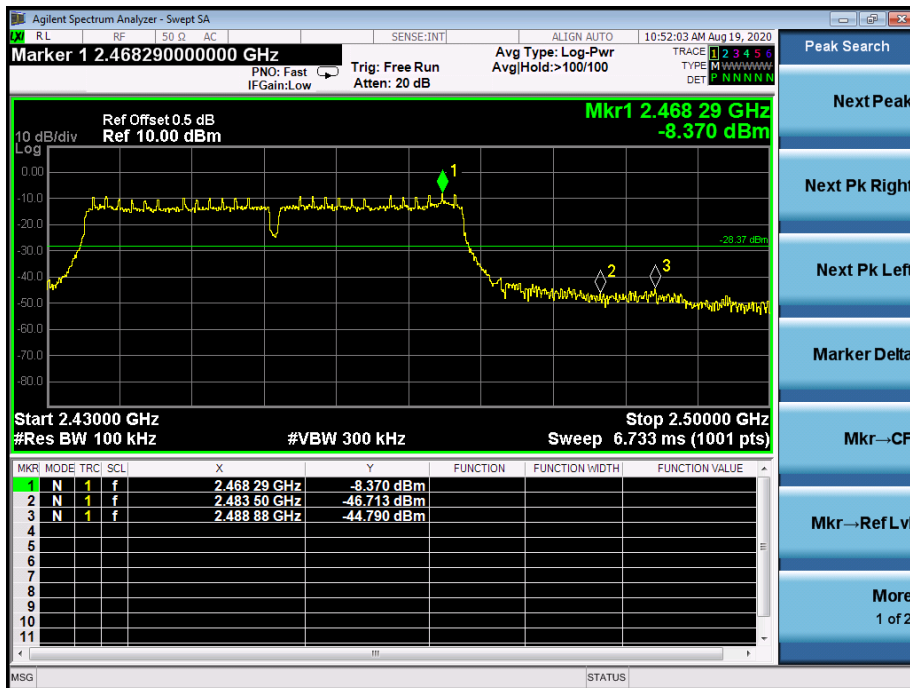



### CONDUCTED EMISSION MEASUREMENT

802.11b

#### Low Channel 2412MHz

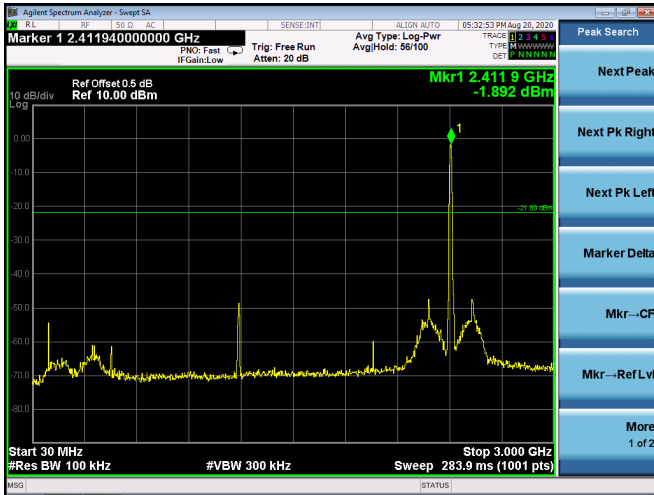

#### Middle Channel 2437MHz

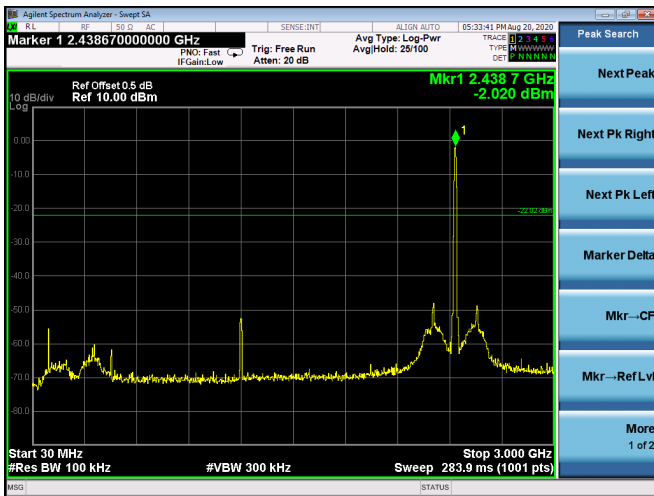

#### High Channel 2462MHz

