



DFS TEST REPORT

REPORT NO.: RF150820E01A-4

MODEL NO.: FWFE, FWFI

FCC ID: 2AD8UFZPFWFE01

RECEIVED: Mar. 26, 2015

TESTED: June 08, 2015

ISSUED: Jan. 15, 2016

APPLICANT: Nokia Solutions and Networks

ADDRESS: 1455 West Shure Drive, Arlington Heights, IL
60004, USA

ISSUED BY: Bureau Veritas Consumer Products Services (H.K.)
Ltd., Taoyuan Branch Hsin Chu Laboratory

LAB ADDRESS: E-2, No.1, Li Hsin 1st Road, Hsinchu Science Park,
Hsinchu City 300, Taiwan R.O.C.

TEST LOCATION (1): E-2, No.1, Li Hsin 1st Road, Hsinchu Science Park,
Hsinchu City 300, Taiwan R.O.C.

TEST LOCATION (2): No. 49, Ln. 206, Wende Rd., Shangshan Tsuen,
Chiung Lin Hsiang, Hsin Chu Hsien 307, Taiwan R.O.C.

This report is for your exclusive use. Any copying or replication of this report to or for any other person or entity, or use of our name or trademark, is permitted only with our prior written permission. This report sets forth our findings solely with respect to the test samples identified herein. The results set forth in this report are not indicative or representative of the quality or characteristics of the lot from which a test sample was taken or any similar or identical product unless specifically and expressly noted. Our report includes all of the tests requested by you and the results thereof based upon the information that you provided to us. You have 60 days from date of issuance of this report to notify us of any material error or omission caused by our negligence, provided, however, that such notice shall be in writing and shall specifically address the issue you wish to raise. A failure to raise such issue within the prescribed time shall constitute your unqualified acceptance of the completeness of this report, the tests conducted and the correctness of the report contents. Unless specific mention, the uncertainty of measurement has been explicitly taken into account to declare the compliance or non-compliance to the specification

This report should not be used by the client to claim product certification, approval, or endorsement by TAF or any government agencies.



Table of Contents

RELEASE CONTROL RECORD.....	3
1. CERTIFICATION	4
2. EUT INFORMATION	5
2.1 OPERATING FREQUENCY BANDS AND MODE OF EUT	5
2.2 EUT SOFTWARE AND FIRMWARE VERSION.....	5
2.3 DESCRIPTION OF AVAILABLE ANTENNAS TO THE EUT	6
2.4 EUT MAXIMUM CONDUCTED POWER	7
2.5 EUT MAXIMUM EIRP POWER.....	8
2.6 TRANSMIT POWER CONTROL (TPC) MECHANISM	9
2.7 STATEMENT OF MANUFACTURER	9
3. U-NII DFS RULE REQUIREMENTS	10
3.1 WORKING MODES AND REQUIRED TEST ITEMS	10
3.2 TEST LIMITS AND RADAR SIGNAL PARAMETERS.....	12
4. TEST & SUPPORT EQUIPMENT LIST.....	16
4.1 TEST INSTRUMENTS	16
4.2 DESCRIPTION OF SUPPORT UNITS.....	16
5. TEST PROCEDURE	17
5.1 DFS MEASUREMENT SYSTEM:.....	17
5.2 CALIBRATION OF DFS DETECTION THRESHOLD LEVEL:	18
5.3 DEVIATION FROM TEST STANDARD	18
5.4 CONDUCTED TEST SETUP CONFIGURATION	19
6. TEST RESULTS	20
6.1 SUMMARY OF TEST RESULT	20
6.2 DETAILED TEST RESULTS.....	21
6.2.1. TEST MODE: DEVICE OPERATING IN MASTER MODE.	21
6.2.1.1 DFS DETECTION THRESHOLD	21
6.2.1.2 CHANNEL AVAILABILITY CHECK TIME	29
6.2.1.3 CHANNEL CLOSING TRANSMISSION AND CHANNEL MOVE TIME.....	31
6.2.1.4 NON- OCCUPANCY PERIOD.....	67
6.2.1.6 U-NII DETECTION BANDWIDTH	69
6.2.1.7 NON-CO-CHANNEL TEST	76
7. INFORMATION ON THE TESTING LABORATORIES.....	77
8. APPENDIX A - MODIFICATIONS RECORDERS FOR ENGINEERING CHANGES TO THE EUT BY THE LAB	78
9. APPENDIX-B.....	79



A D T

RELEASE CONTROL RECORD

ISSUE NO.	REASON FOR CHANGE	DATE ISSUED
RF150820E01A-4	Original release	Jan. 15, 2016



A D T

1. CERTIFICATION

PRODUCT: Flexi Zone Indoor Pico BTS

BRAND NAME: Nokia

MODEL NO.: FWFE, FWFI

TEST SAMPLE S/N: EA152410016

HARDWARE VERSION: 473236A.101; 473771A.101

TEST SAMPLE: ENGINEERING SAMPLE

APPLICANT: Nokia Solutions and Networks

TESTED: June 08, 2015

STANDARDS: FCC Part 15, Subpart E (Section 15.407)

KDB 905462 D02 UNII DFS Compliance Procedures New Rules
v01r02

The above equipment (Model: FWFE) has been tested by **Bureau Veritas Consumer Products Services (H.K.) Ltd., Taoyuan Branch**, and was in compliance with the requirement of the above standards. The test record, data evaluation & Equipment Under Test (EUT) configurations represented herein are true and accurate accounts of the measurements of the sample's EMC characteristics under the conditions specified in this report.

Prepared by :  **Date:** Jan. 15, 2016
Lori Chung / Specialist

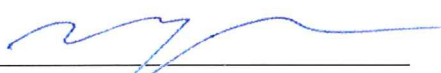
Approved by :  **Date:** Jan. 15, 2016
Max Chen / Manager



A D T

2. EUT INFORMATION

2.1 OPERATING FREQUENCY BANDS AND MODE OF EUT

Table 1: Operating frequency bands and mode of EUT

Operational Mode	Operating Frequency Range	
	5250~5350MHz	5470~5725MHz (5600~5650MHz will be disabled)
Master	✓	✓

2.2 EUT SOFTWARE AND FIRMWARE VERSION

Table 2: The EUT software/firmware version

No.	Product	Model No.	Software/Firmware Version
1	Flexi Zone Indoor Pico BTS	FWFE	9.8.2.0.14326748



A D T

2.3 DESCRIPTION OF AVAILABLE ANTENNAS TO THE EUT

Table 3: Antenna list

WLAN Antenna Spec.							
Antenna No	Brand	Model	Antenna Type	Antenna Connector	Gain(dBi) <Including cable loss>	Cable Length (mm)	Frequency (MHz)
Internal WIFI (Main)	TongDa	T-543-8141037-3	PIFA	i-pex(MHF)	3.3	90	2412~2472
					2.4		5150~5825
Internal WIFI (Aux)	TongDa	T-543-8141037-4	PIFA	i-pex(MHF)	3	70	2412~2472
					2.9		5150~5825



2.4 EUT MAXIMUM CONDUCTED POWER

Table 4: The Measured Conducted Output Power

802.11a

Frequency Band(MHz)	MAX. Power	
	Output Power(dBm)	Output Power(mW)
5250~5350	23.98	249.768
5470~5725	23.95	248.333

802.11ac (VHT20)

Frequency Band(MHz)	MAX. Power	
	Output Power(dBm)	Output Power(mW)
5250~5350	23.89	244.778
5470~5725	23.87	244.007

802.11ac (VHT40)

Frequency Band(MHz)	MAX. Power	
	Output Power(dBm)	Output Power(mW)
5250~5350	23.99	250.344
5470~5725	23.87	243.839

802.11ac (VHT80)

Frequency Band(MHz)	MAX. Power	
	Output Power(dBm)	Output Power(mW)
5250~5350	20.03	100.662
5470~5725	20.43	110.5



A D T

2.5 EUT MAXIMUM EIRP POWER

Table 5: The EIRP Output Power List

802.11a

Frequency Band(MHz)	MAX. Power	
	Output Power(dBm)	Output Power(mW)
5250~5350	26.88	487.009
5470~5725	26.85	484.211

802.11ac (VHT20)

Frequency Band(MHz)	MAX. Power	
	Output Power(dBm)	Output Power(mW)
5250~5350	26.79	477.279
5470~5725	26.77	475.776

802.11ac (VHT40)

Frequency Band(MHz)	MAX. Power	
	Output Power(dBm)	Output Power(mW)
5250~5350	26.89	488.132
5470~5725	26.77	475.448

802.11ac (VHT80)

Frequency Band(MHz)	MAX. Power	
	Output Power(dBm)	Output Power(mW)
5250~5350	22.93	196.275
5470~5725	23.33	215.458



A D T

2.6 TRANSMIT POWER CONTROL (TPC) MECHANISM

U-NII devices operating in the 5.25-5.35 GHz band and the 5.47-5.725 GHz band shall employ a TPC mechanism. The U-NII device is required to have the capability to operate at least 6 dB below the mean EIRP value of 30 dBm. A TPC mechanism is not required for systems with an EIRP of less than 500 mW.

Maximum EIRP of this device is 488.132 mW which less than 500mW, therefore it's not require TPC function.

2.7 STATEMENT OF MANUFACTURER

Manufacturer statement confirming that information regarding the parameters of the detected Radar Waveforms is not available to the end user.

3. U-NII DFS RULE REQUIREMENTS

3.1 WORKING MODES AND REQUIRED TEST ITEMS

The manufacturer shall state whether the UUT is capable of operating as a Master and/or a Client. If the UUT is capable of operating in more than one operating mode then each operating mode shall be tested separately. See tables 6 and 7 for the applicability of DFS requirements for each of the operational modes.

Table 6: Applicability OF DFS Requirements Prior TO Use a Channel

Requirement	Operational Mode		
	Master	Client without radar detection	Client with radar detection
Non-Occupancy Period	✓	Not required	✓
DFS Detection Threshold	✓	Not required	✓
Channel Availability Check Time	✓	Not required	Not required
U-NII Detection Bandwidth	✓	Not required	✓



Table 7: Applicability OF DFS Requirements During Normal Operation

Requirement	Operational Mode	
	Master or Client with radar detection	Client without radar detection
DFS Detection Threshold	✓	Not required
Channel Closing Transmission Time	✓	✓
Channel Move Time	✓	✓
U-NII Detection Bandwidth	✓	Not required

Additional requirements for devices with multiple bandwidth modes	Master or Client with radar detection	Client without radar detection
U-NII Detection Bandwidth and Statistical Performance Check	All BW modes must be tested	Not required
Channel Move Time and Channel Closing Transmission Time	Test using widest BW mode available	Test using the widest BW mode available for the link
All other tests	Any single BW mode	Not required

Note: Frequencies selected for statistical performance check (Section 7.8.4 of KDB) should include several frequencies within the radar detection bandwidth and frequencies near the edge of the radar detection bandwidth. For 802.11 devices it is suggested to select frequencies in each of the bonded 20 MHz channels and the channel center frequency.



A D T

3.2 TEST LIMITS AND RADAR SIGNAL PARAMETERS

DETECTION THRESHOLD VALUES

Table 8: DFS Detection Thresholds For Master Devices AND Client Devices With Radar Detection

Maximum Transmit Power	Value (See Notes 1, 2, and 3)
EIRP \geq 200 milliwatt	-64 dBm
EIRP < 200 milliwatt and power spectral density < 10 dBm/MHz	-62 dBm
EIRP < 200 milliwatt that do not meet the power spectral density requirement	-64 dBm

Note 1: This is the level at the input of the receiver assuming a 0 dBi receive antenna.
Note 2: Throughout these test procedures an additional 1 dB has been added to the amplitude of the test transmission waveforms to account for variations in measurement equipment. This will ensure that the test signal is at or above the detection threshold level to trigger a DFS response.
Note3: EIRP is based on the highest antenna gain. For MIMO devices refer to KDB Publication 662911 D01.



A D T

Table 9: DFS Response Requirement Values

Parameter	Value
Non-occupancy period	Minimum 30 minutes
Channel Availability Check Time	60 seconds
Channel Move Time	10 seconds See Note 1.
Channel Closing Transmission Time	200 milliseconds + an aggregate of 60 milliseconds over remaining 10 second period. See Notes 1 and 2.
U-NII Detection Bandwidth	Minimum 100% of the U-NII 99% transmission power bandwidth. See Note 3

Note 1: Channel Move Time and the Channel Closing Transmission Time should be performed with Radar Type 0. The measurement timing begins at the end of the Radar Type 0 burst.

Note 2: The Channel Closing Transmission Time is comprised of 200 milliseconds starting at the beginning of the Channel Move Time plus any additional intermittent control signals required to facilitate a Channel move (an aggregate of 60 milliseconds) during the remainder of the 10 second period. The aggregate duration of control signals will not count quiet periods in between transmissions.

Note 3: During the U-NII Detection Bandwidth detection test, radar type 0 should be used. For each frequency step the minimum percentage of detection is 90 percent. Measurements are performed with no data traffic.



PARAMETERS OF DFS TEST SIGNALS

Step intervals of 0.1 microsecond for Pulse Width, 1 microsecond for PRI, 1 MHz for chirp width and 1 for the number of pulses will be utilized for the random determination of specific test waveforms.

Table 10: Short Pulse Radar Test Waveforms

Radar Type	Pulse Width (μsec)	PRI (μsec)	Number of Pulses	Minimum Percentage of Successful Detection	Minimum Number of Trials
0	1	1428	18	See Note 1	See Note 1
1	1	Test A: 15 unique PRI values randomly selected from the list of 23 PRI values in Table 5a ----- Test B: 15 unique PRI values randomly selected within the range of 518-3066 μ sec, with a minimum increment of 1 μ sec, excluding PRI values selected in Test A	$\text{Roundup} \left\{ \begin{array}{l} \frac{1}{360} \\ \frac{19 \cdot 10^6}{\text{PRI}_{\mu\text{sec}}} \end{array} \right\}$	60%	30
2	1-5	150-230	23-29	60%	30
3	6-10	200-500	16-18	60%	30
4	11-20	200-500	12-16	60%	30
Aggregate (Radar Types 1-4)				80%	120
Note 1: Short Pulse Radar Type 0 should be used for the detection bandwidth test, channel move time, and channel closing time tests.					



A D T

Table 11: Long Pulse Radar Test Waveform

Radar Type	Pulse Width (μsec)	Chirp Width (MHz)	PRI (μsec)	Number of Pulses per Burst	Number of Bursts	Minimum Percentage of Successful Detection	Minimum Number of Trials
5	50-100	5-20	1000-2000	1-3	8-20	80%	30

Table 12: Frequency Hopping Radar Test Waveform

Radar Type	Pulse Width (μsec)	PRI (μsec)	Pulses per Hop	Hopping Rate (kHz)	Hopping Sequence Length (msec)	Minimum Percentage of Successful Detection	Minimum Number of Trials
6	1	333	9	0.333	300	70%	30



A D T

4. TEST & SUPPORT EQUIPMENT LIST

4.1 TEST INSTRUMENTS

Table 13: Test instruments list

DESCRIPTION & MANUFACTURER	MODEL NO.	SERIAL NO.	CALIBRATED DATE	CALIBRATED UNTIL
Spectrum Analyzer R&S	FSP 40	100037	Oct. 30, 2014	Oct. 29, 2015
Vector Signal Generator Agilent	SMJ100A	101878	Aug. 12, 2014	Aug. 11, 2015

4.2 DESCRIPTION OF SUPPORT UNITS

Table 14: Support Unit information

No.	Product	Brand	Model No.	FCC ID
1	Wireless LAN Unit	NEC	NP05LM	RRK-NECNP05LM

NOTE: This device was functioned as a Master Slave device during the DFS test.

Table 15: Software/Firmware information

No.	Product	Model No.	Software/Firmware Version
1	Wireless LAN Unit	NP05LM	Driver Version: 06/18/2014, 1026.12.606.2014

5. TEST PROCEDURE

5.1 DFS MEASUREMENT SYSTEM:

A complete DFS Measurement System consists of Radar signal generate system to generating the radar waveforms in Table 10, 11 and 12. The traffic monitoring system is specified to the type of unit under test (UUT).

Conducted setup configuration of DFS Measurement System

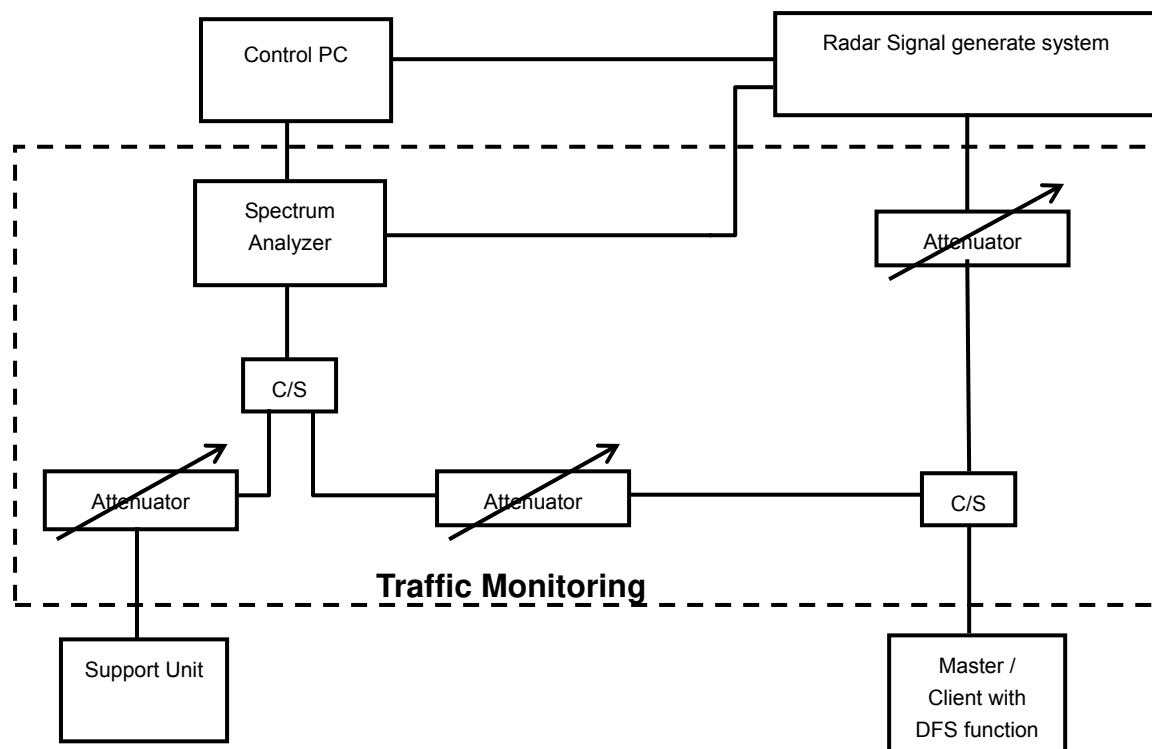

Channel Loading

System testing will be performed with channel-loading using means appropriate to the data types that are used by the unlicensed device. The following requirements apply:

a)	The data file must be of a type that is typical for the device (i.e., MPEG-2, MPEG-4, WAV, MP3, MP4, AVI, etc.) and must generally be transmitting in a streaming mode.	
b)	Software to ping the client is permitted to simulate data transfer but must have random ping intervals.	
c)	Timing plots are required with calculations demonstrating a minimum channel loading of approximately 17% or greater.	✓
d)	Unicast or Multicast protocols are preferable but other protocols may be used. The appropriate protocol used must be described in the test procedures.	

5.2 CALIBRATION OF DFS DETECTION THRESHOLD LEVEL:

The measured channel is 5500MHz in 20MHz and 5510MHz in 40MHz and 5530 in 80MHz. The radar signal was the same as transmitted channels, and injected into the antenna port of AP (master) or Client Device with Radar Detection, measured the channel closing transmission time and channel move time.

5.2.1 MASTER MODE

The Master antenna gain is 2.4dBi and required detection threshold is -60.6dBm (= -64+1+2.4)dBm. The calibrated conducted detection threshold level is -60.6dBm.

Conducted setup configuration of Calibration of DFS Detection Threshold Level

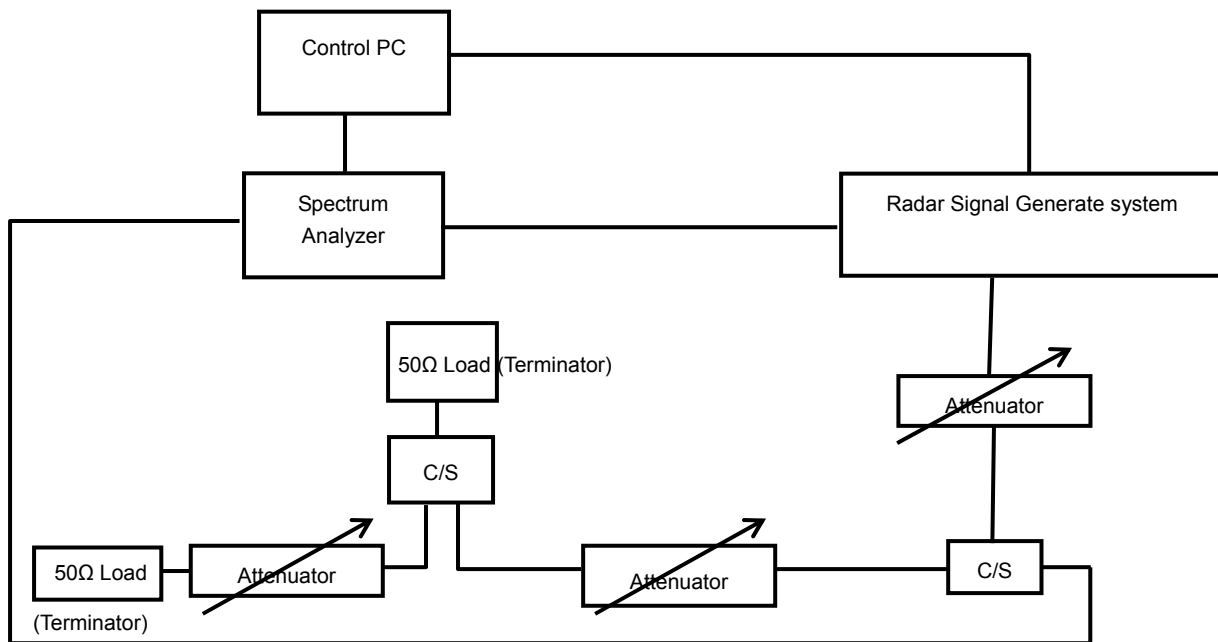

5.3 DEVIATION FROM TEST STANDARD

No deviation.

5.4 CONDUCTED TEST SETUP CONFIGURATION

MASTER MODE

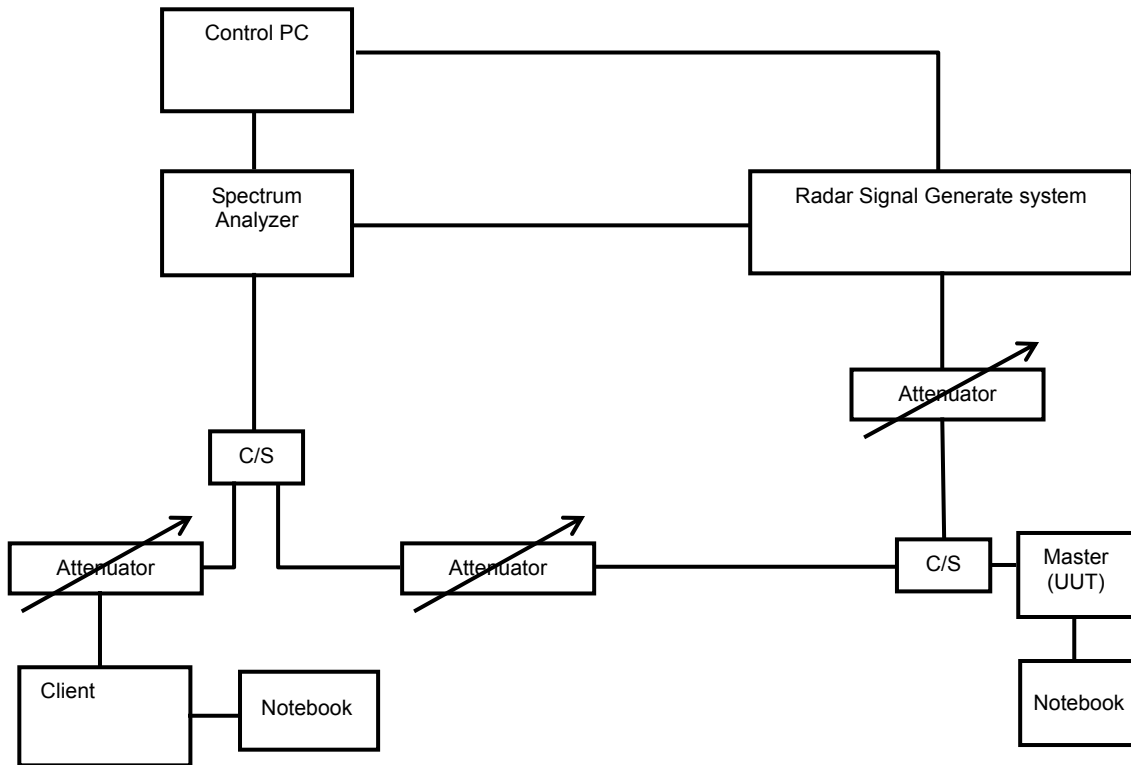

The UUT is a U-NII Device operating in Master mode. The radar test signals are injected into the Master Device.



A D T

6. TEST RESULTS

6.1 SUMMARY OF TEST RESULT

MASTER MODE

Clause	Test Parameter	Remarks	Pass/Fail
15.407	DFS Detection Threshold	Applicable	Pass
15.407	Channel Availability Check Time	Applicable	Pass
15.407	Channel Move Time	Applicable	Pass
15.407	Channel Closing Transmission Time	Applicable	Pass
15.407	Non- Occupancy Period	Applicable	Pass
15.407	U-NII Detection Bandwidth	Applicable	Pass
15.407	Non-Co-Channel test	Applicable	Pass

6.2 DETAILED TEST RESULTS

6.2.1. TEST MODE: DEVICE OPERATING IN MASTER MODE.

The radar test signals are injected into the Master Device.

6.2.1.1 DFS DETECTION THRESHOLD

The required detection threshold is -60.6dBm ($= -64+1+2.4$) dBm. The conducted radar burst level is lower than -60.6dBm .

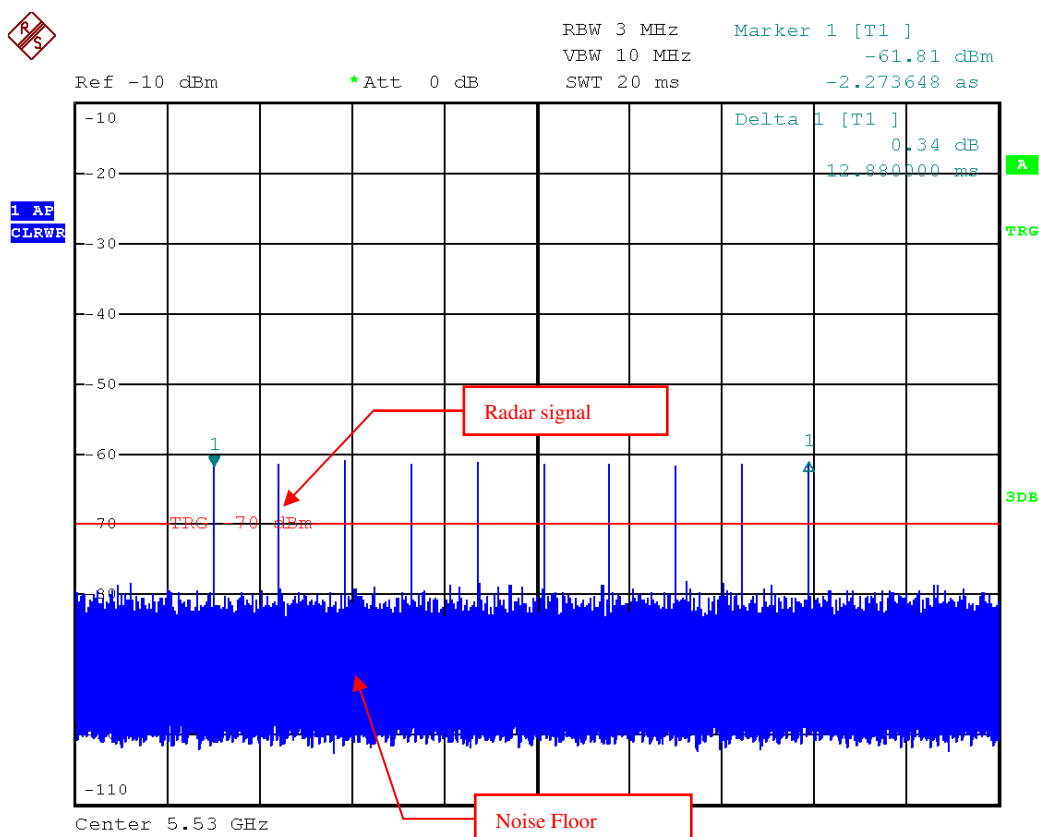

Radar Signal 0



A D T



Ref -10 dBm

*Att 0 dB

RBW 3 MHz
 VBW 10 MHz
 SWT 50 ms

Delta 1 [T1]

-0.40 dB
 24.400000 ms

1 AP
 CLRWR

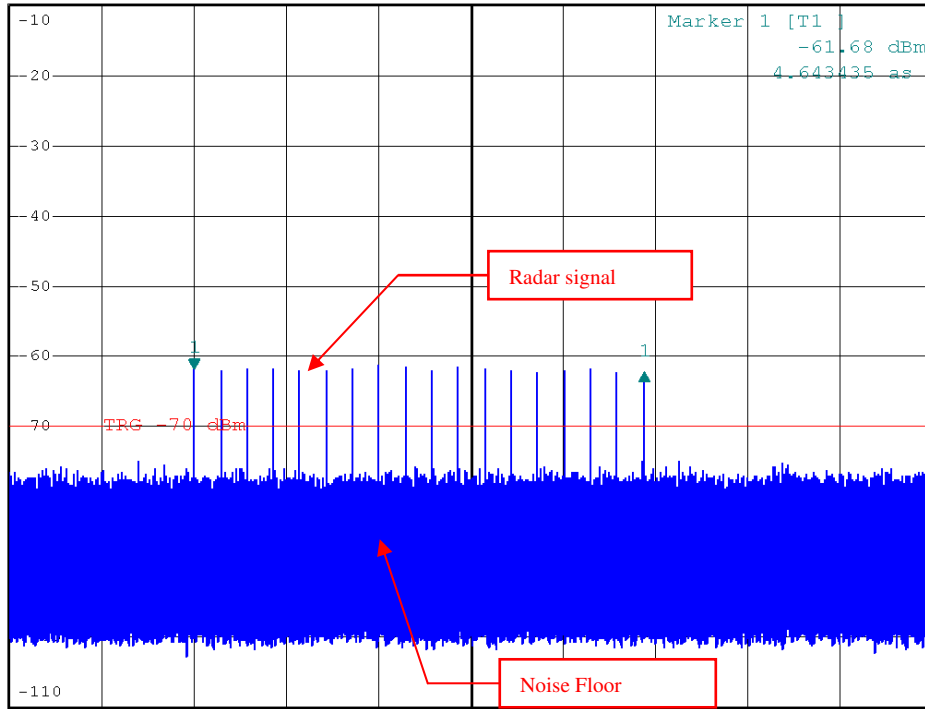

Center 5.53 GHz

5 ms/

Radar Signal 1



A D T



Ref -10 dBm *Att 0 dB RBW 3 MHz Delta 1 [T1]
VBW 10 MHz -0.46 dB
SWT 10 ms 4.501000 ms

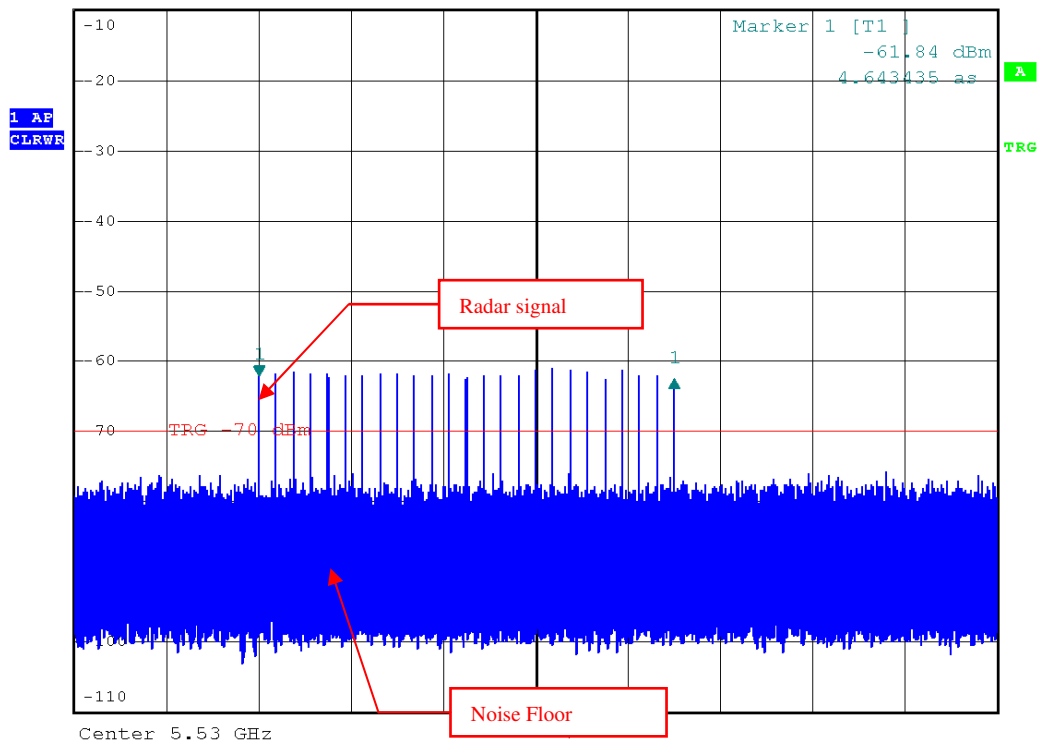

Radar Signal 2



A D T



RBW 3 MHz Delta 1 [T1]
VBW 10 MHz -0.06 dB
SWT 10 ms 6.740000 ms
Ref -10 dBm *Att 0 dB

I AF
CLRWR

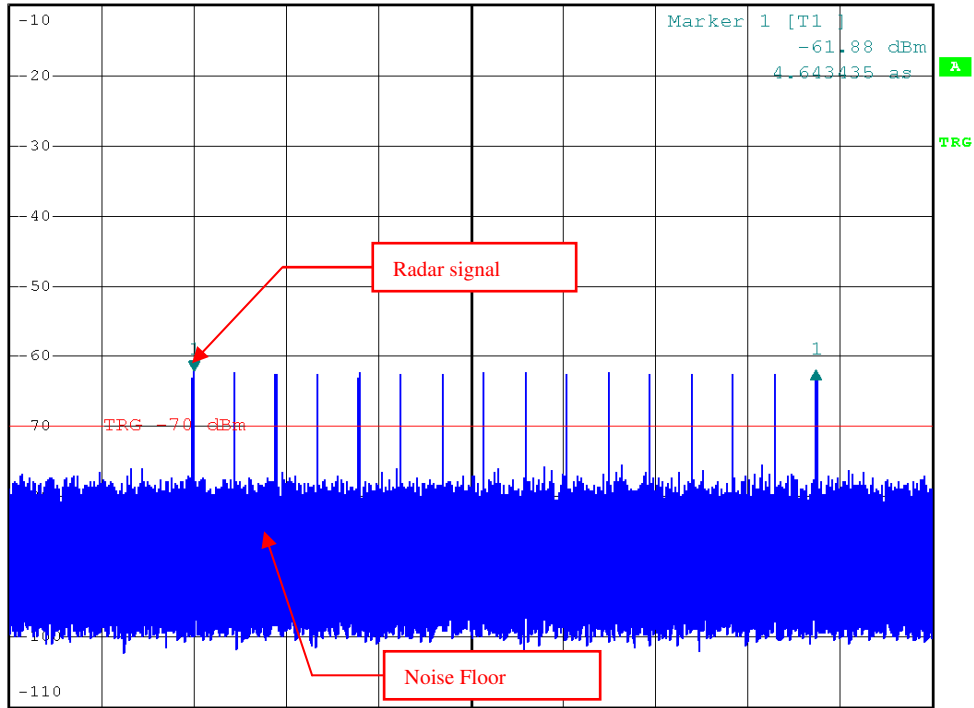

Center 5.53 GHz 1 ms/

Radar Signal 3



A D T



I AF
CLRWR

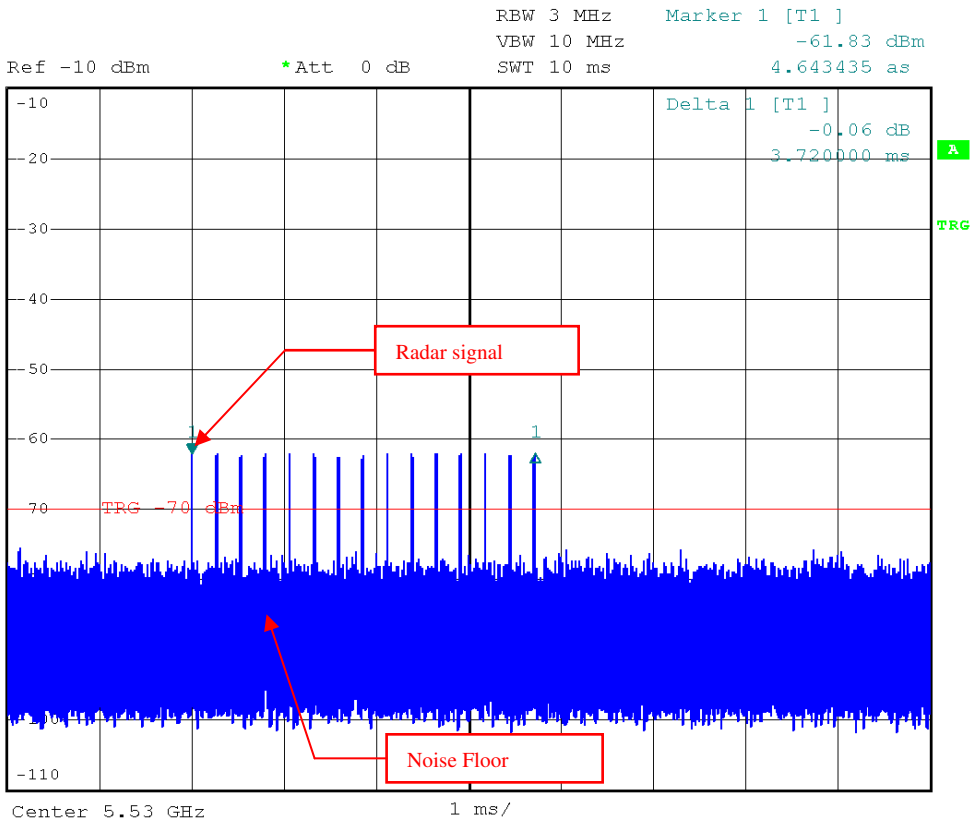

Radar Signal 4



A D T

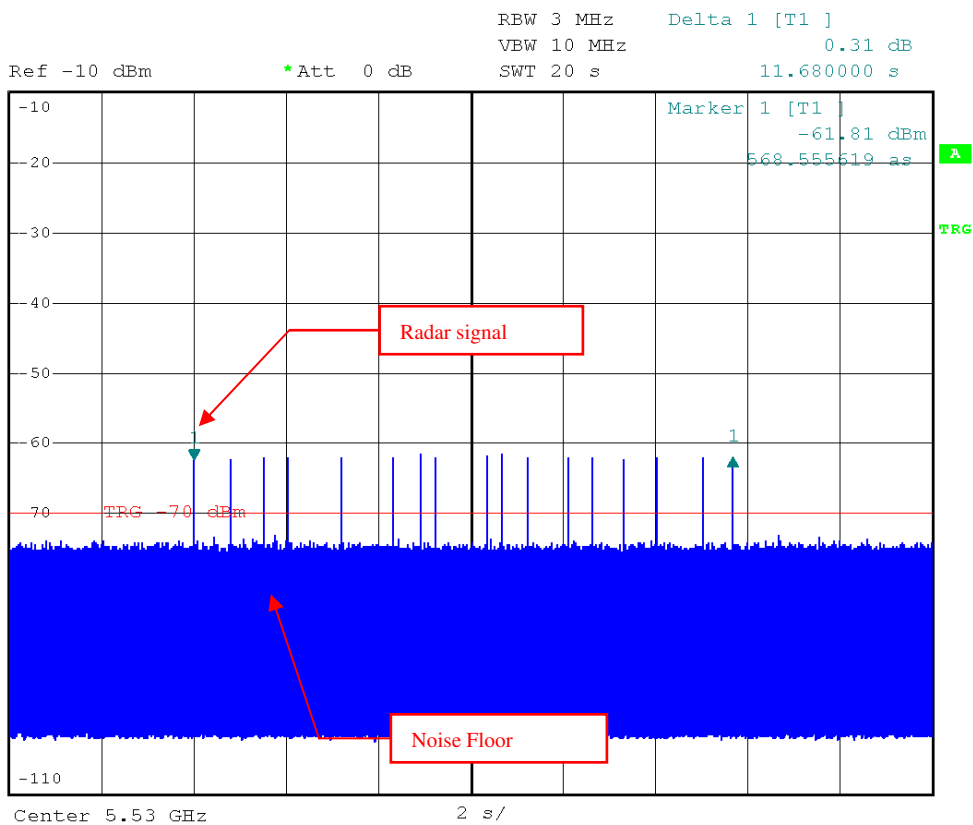

Radar Signal 5



A D T

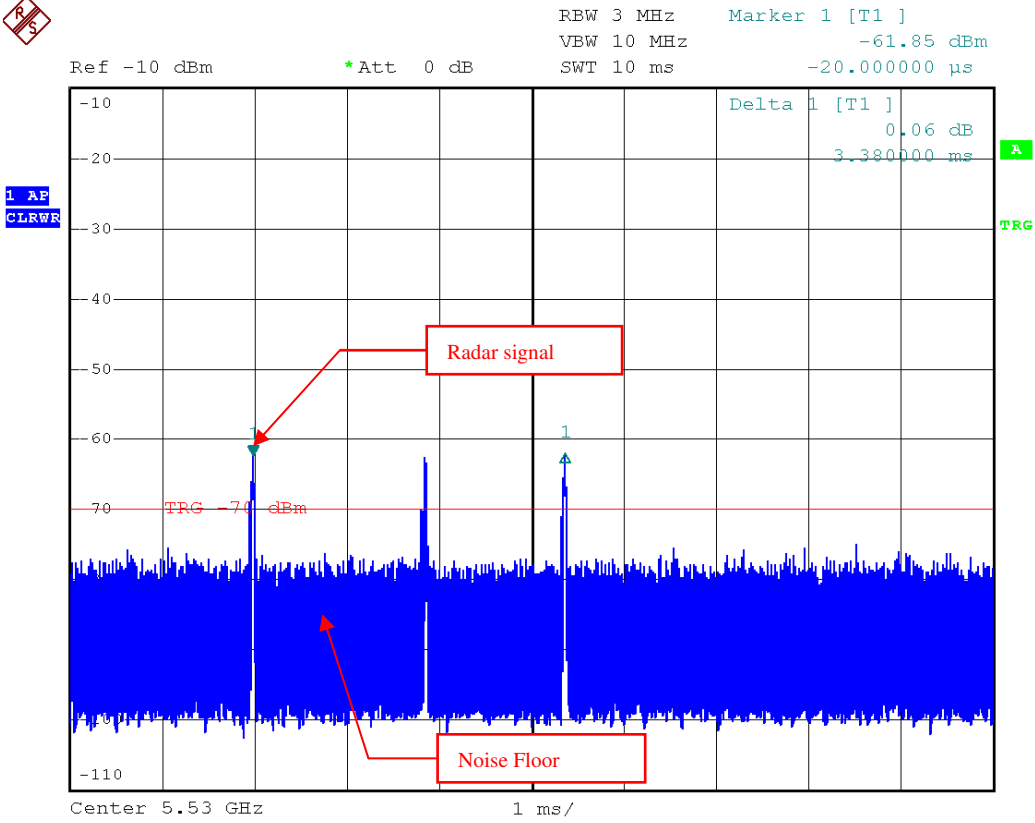

Single Burst of Radar Signal 5



A D T

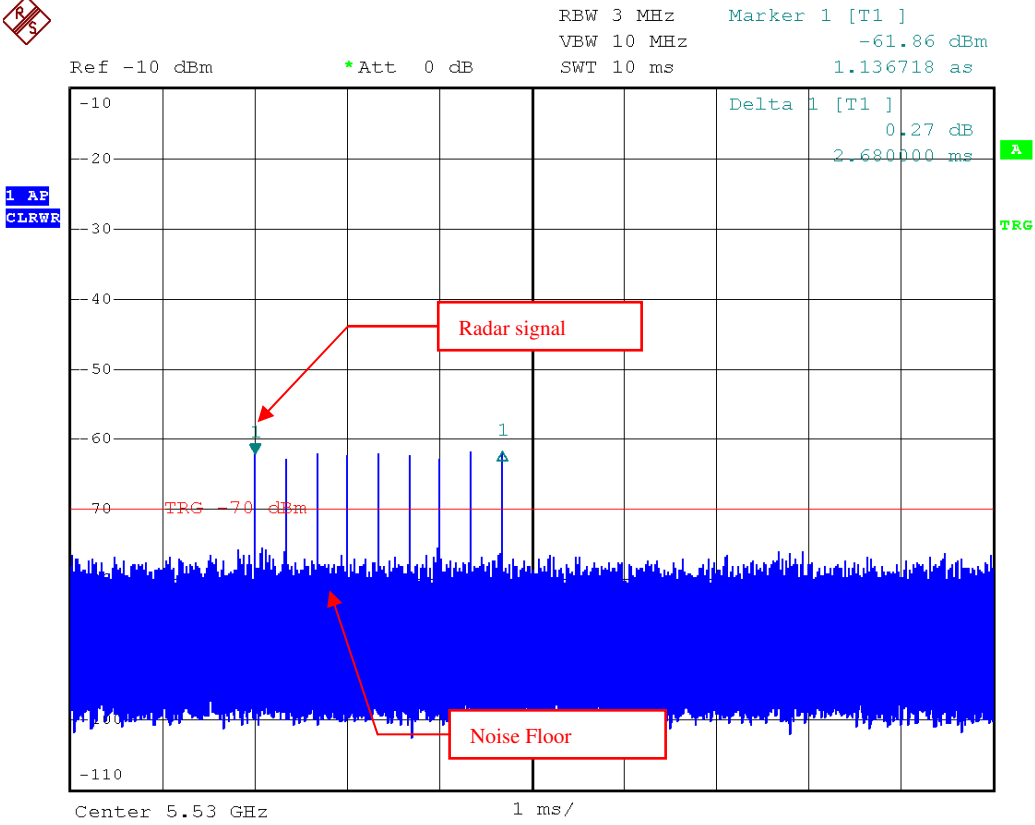

Radar Signal 6

6.2.1.2 CHANNEL AVAILABILITY CHECK TIME

If the EUT successfully detected the radar burst, it should be observed as the EUT has no transmissions occurred until the EUT starts transmitting on another channel.

Timing of Radar Signal	Observation	
	EUT	Spectrum Analyzer
Within 1 to 6 second	Detected	No transmissions
Within 54 to 60 second	Detected	No transmissions

Initial Channel Availability Check Time

Channel Availability Check

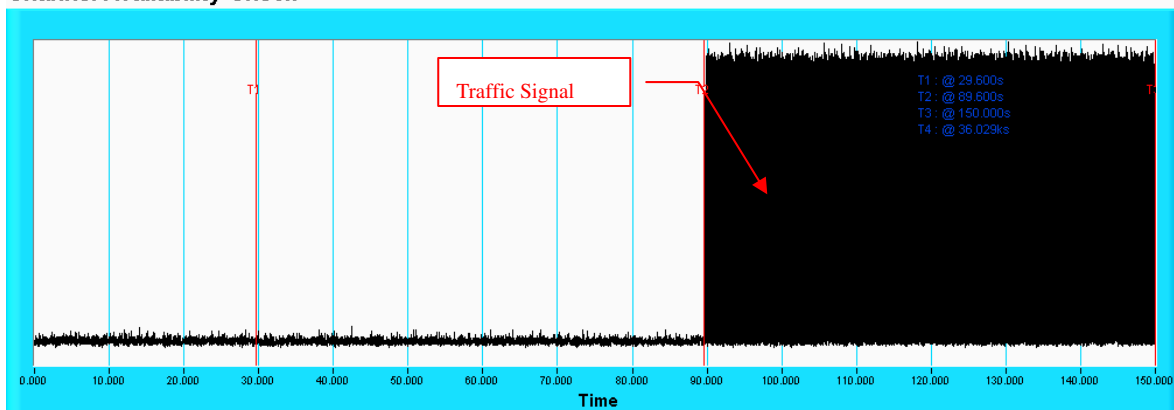

NOTE: T1 denotes the end of power-up time period is 29.6th second. T2 denotes the end of Channel Availability Check time is 89.6th second. Channel Availability Check time is equal to (T2 – T1) 60 seconds.

Radar Burst at the Beginning of the Channel Availability Check Time

Channel Availability Check

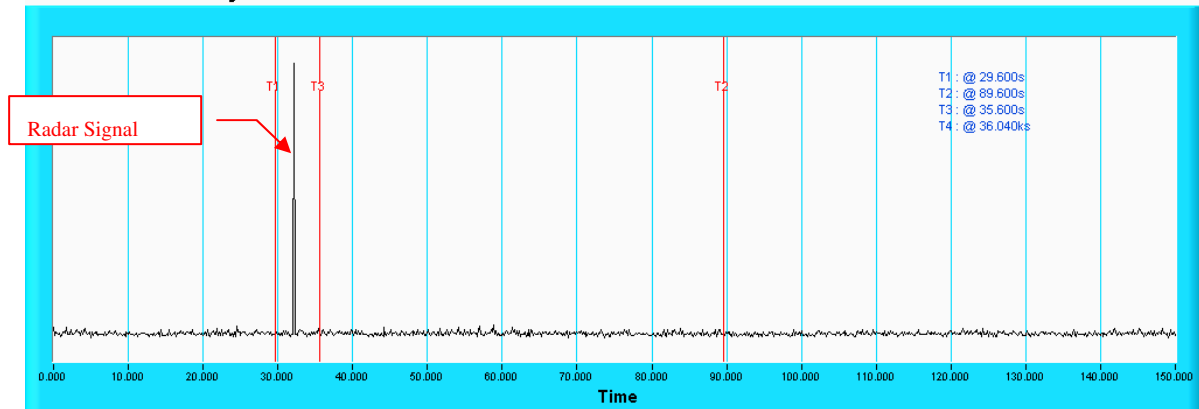

NOTE: T1 denotes the end of power up time period is 29.6th second. T3 denotes 35.6th second and the radar burst was commenced within a 6 second window starting from the end of power-up sequence. T2 denotes the 89.6th second.

Radar Burst at the End of the Channel Availability Check Time

Channel Availability Check

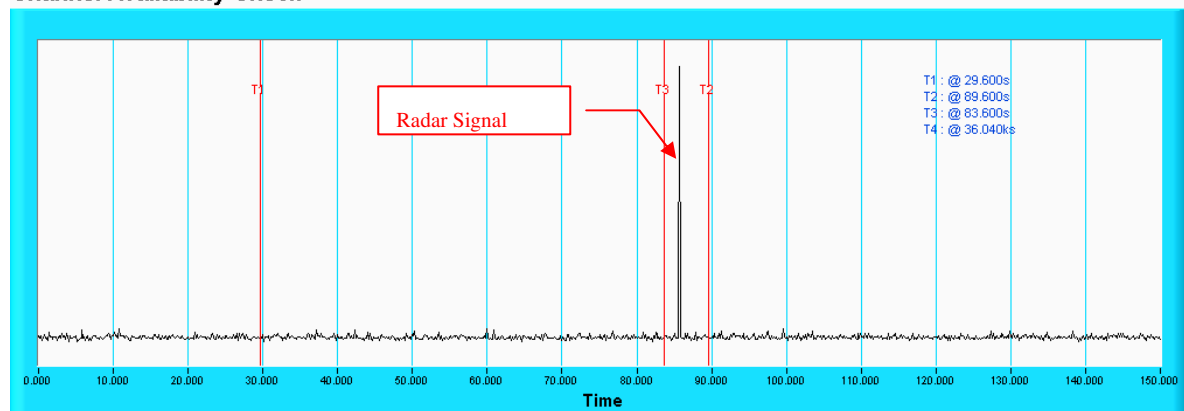

NOTE: T1 denotes the end of power up time period is 29.6th second. T3 denotes 83.6th second and the radar burst was commenced within 54th second to 60th second window starting from the end of power-up sequence. T2 denotes the 89.6th second.



A D T

6.2.1.3 CHANNEL CLOSING TRANSMISSION AND CHANNEL MOVE TIME

802.11ac (VHT20)

Short Pulse Radar Test Waveforms

Radar Type	Pulse Width (μsec)	PRI (μsec)	Number of Pulses	Number of Trials(Time s)	Percentage of Successful Detection (%)
1	<p>Test A: 15 unique PRI values randomly selected from the list of 23 PRI values in Table 5a</p> <p>-----</p> <p>Test B: 15 unique PRI values randomly selected within the range of 518-3066 μ sec, with a minimum increment of 1 μ sec, excluding PRI values selected in Test A</p>	$\text{Roundup} \left\{ \begin{array}{l} \left(\frac{1}{360} \right) \\ \left(\frac{19 \cdot 10^6}{\text{PRI}_{\mu\text{sec}}} \right) \end{array} \right\}$	18	30	80
2	1-5	150-230	23-29	30	86.7
3	6-10	200-500	16-18	30	93.3
4	11-20	200-500	12-16	30	86.7
Aggregate (Radar Types 1-4)				120	86.67



A D T

Long Pulse Radar Test Waveform

Radar Type	Pulse Width (μsec)	Chirp Width (MHz)	PRI (μsec)	Number of Pulses per Burst	Number of Bursts	Number of Trials(Times)	Percentage of Successful Detection (%)
5	50-100	5-20	1000-2000	1-3	8-20	30	80

Frequency Hopping Radar Test Waveform

Radar Type	Pulse Width (μsec)	PRI (μsec)	Pulses per Hop	Hopping Rate (kHz)	Hopping Sequence Length (msec)	Number of Trials(Times)	Percentage of Successful Detection (%)
6	1	333	9	0.333	300	30	83.3



802.11ac (VHT40)

Short Pulse Radar Test Waveforms

Radar Type	Pulse Width (μsec)	PRI (μsec)	Number of Pulses	Number of Trials(Time s)	Percentage of Successful Detection (%)
1	<p>Test A: 15 unique PRI values randomly selected from the list of 23 PRI values in Table 5a</p> <p>-----</p> <p>Test B: 15 unique PRI values randomly selected within the range of 518-3066 μ sec, with a minimum increment of 1 μ sec, excluding PRI values selected in Test A</p>	$\text{Roundup} \left\{ \begin{array}{l} \left(\frac{1}{360} \right) \\ \left(\frac{19 \cdot 10^6}{\text{PRI}_{\mu\text{sec}}} \right) \end{array} \right\}$	18	30	86.7
2	1-5	150-230	23-29	30	86.7
3	6-10	200-500	16-18	30	96.7
4	11-20	200-500	12-16	30	86.7
Aggregate (Radar Types 1-4)				120	89.17



A D T

Long Pulse Radar Test Waveform

Radar Type	Pulse Width (μ sec)	Chirp Width (MHz)	PRI (μ sec)	Number of Pulses per Burst	Number of Bursts	Number of Trials(Times)	Percentage of Successful Detection (%)
5	50-100	5-20	1000-2000	1-3	8-20	30	80

Frequency Hopping Radar Test Waveform

Radar Type	Pulse Width (μ sec)	PRI (μ sec)	Pulses per Hop	Hopping Rate (kHz)	Hopping Sequence Length (msec)	Number of Trials(Times)	Percentage of Successful Detection (%)
6	1	333	9	0.333	300	30	80



802.11ac (VHT80)

Short Pulse Radar Test Waveforms

Radar Type	Pulse Width (μsec)	PRI (μsec)	Number of Pulses	Number of Trials(Time s)	Percentage of Successful Detection (%)
1	<p>Test A: 15 unique PRI values randomly selected from the list of 23 PRI values in Table 5a</p> <p>-----</p> <p>Test B: 15 unique PRI values randomly selected within the range of 518-3066 μ sec, with a minimum increment of 1 μ sec, excluding PRI values selected in Test A</p>	$\text{Roundup} \left\{ \begin{array}{l} \left(\frac{1}{360} \right) \\ \left(\frac{19 \cdot 10^6}{\text{PRI}_{\mu\text{sec}}} \right) \end{array} \right\}$	18	30	83.3
2	1-5	150-230	23-29	30	86.7
3	6-10	200-500	16-18	30	93.3
4	11-20	200-500	12-16	30	90
Aggregate (Radar Types 1-4)				120	88.33



A D T

Long Pulse Radar Test Waveform

Radar Type	Pulse Width (μsec)	Chirp Width (MHz)	PRI (μsec)	Number of Pulses per Burst	Number of Bursts	Number of Trials(Times)	Percentage of Successful Detection (%)
5	50-100	5-20	1000-2000	1-3	8-20	30	90

Frequency Hopping Radar Test Waveform

Radar Type	Pulse Width (μsec)	PRI (μsec)	Pulses per Hop	Hopping Rate (kHz)	Hopping Sequence Length (msec)	Number of Trials(Times)	Percentage of Successful Detection (%)
6	1	333	9	0.333	300	30	83.3

Wireless Traffic Loading

802.11ac (VHT20)

Duty Cycle

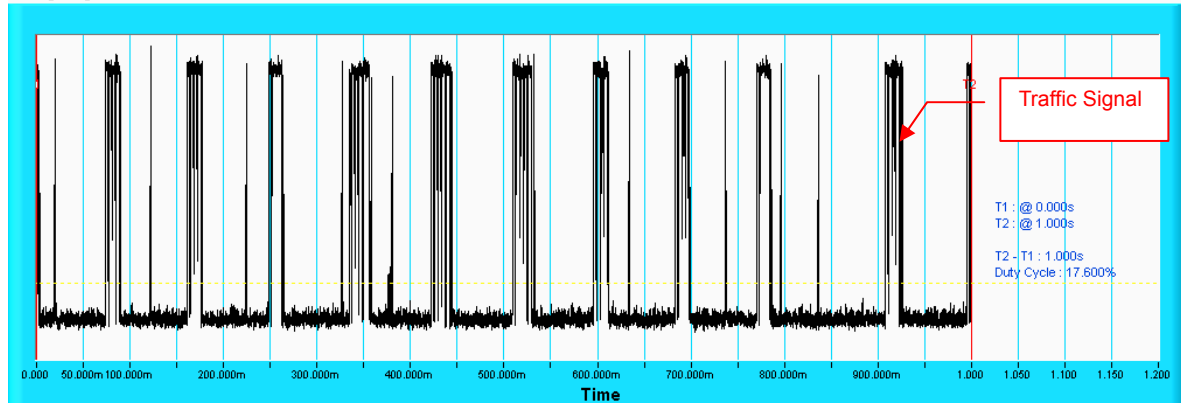

NOTE: T1 denotes the start of duty cycle period is 0th second. T2 denotes the end of duty cycle period is 1th second. $T2 - T1 = 1$ seconds. Duty Cycle = 17.6%
 Duty Cycle = $\text{Time On} / (\text{Time On} + \text{Off Time}) = 176\text{ms} / (1000\text{ms}) = 17.6\%$

802.11ac (VHT40)

Duty Cycle

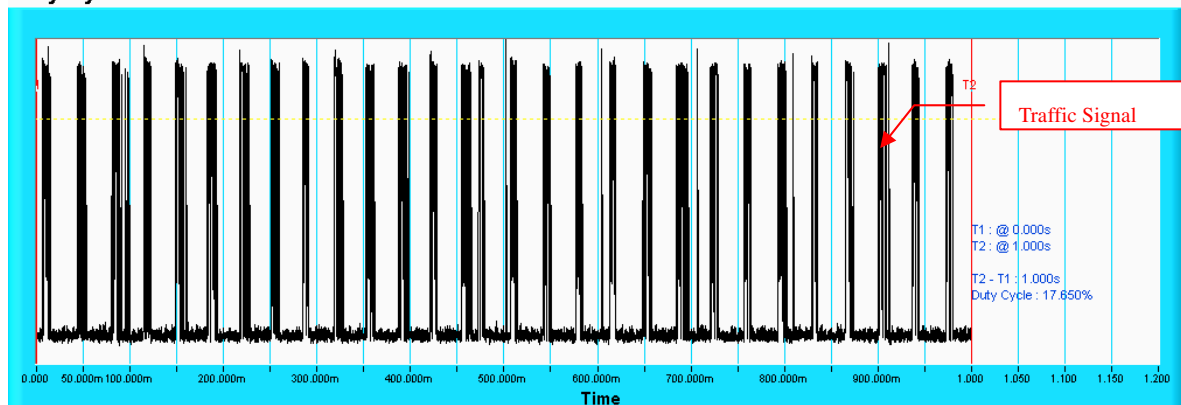

NOTE: T1 denotes the start of duty cycle period is 0th second. T2 denotes the end of duty cycle period is 1th second. $T2 - T1 = 1$ seconds. Duty Cycle = 17.65%
 Duty Cycle = $\text{Time On} / (\text{Time On} + \text{Off Time}) = 176.5\text{ms} / (1000\text{ms}) = 17.65\%$



A D T

802.11ac (VHT80)

Duty Cycle

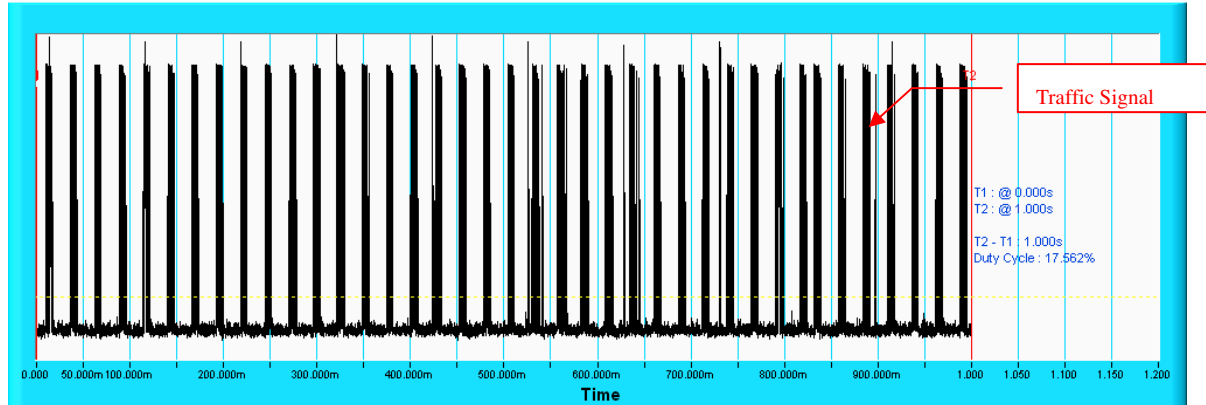

NOTE: T1 denotes the start of duty cycle period is 0th second. T2 denotes the end of duty cycle period is 1th second. T2 – T1= 1 seconds. Duty Cycle = 17.562%

Duty Cycle=Time On / (Time On + Off Time)=175.62ms / (1000ms)=17.562%



A D T

Radar signal 0

Aggregate Transmission Time (ms)	Limit (ms)	Margin (ms)
12.75	60	47.25

Channel Closing Transmission Time & Channel Move Time @ CH106 - AC80

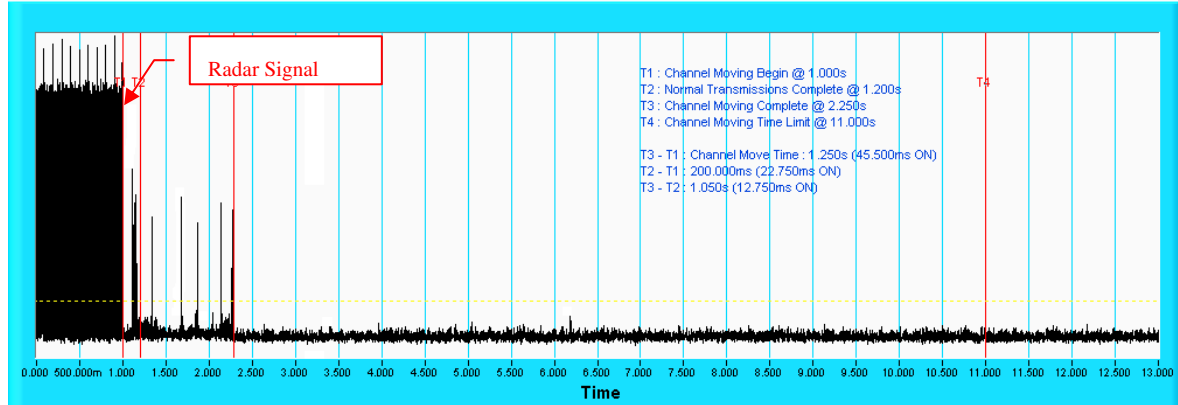

NOTE: T1 denotes the start of Channel Move Time upon the end of the last Radar burst. T2 denotes the data transmission time of 200ms from T1. T3 denotes the end of Channel Move Time. T4 denotes the 10 second from T1 to observe the aggregate duration of transmissions.

Channel Closing Transmission Time & Channel Move Time @ CH106 - AC80

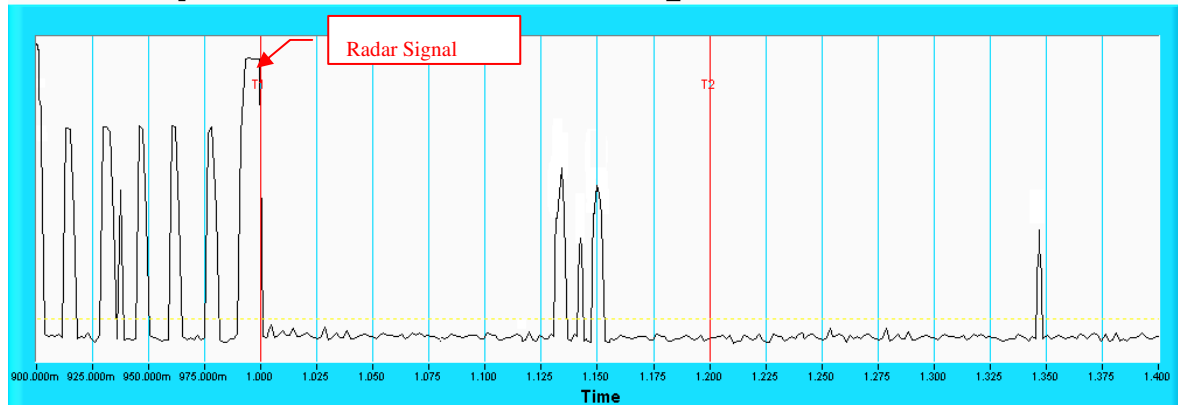

NOTE: An expanded plot for the device vacates the channel in the required 500ms.

Radar signal 1

Aggregate Transmission Time (ms)	Limit (ms)	Margin (ms)
0	60	60

Channel Closing Transmission Time & Channel Move Time @ CH106 - AC80

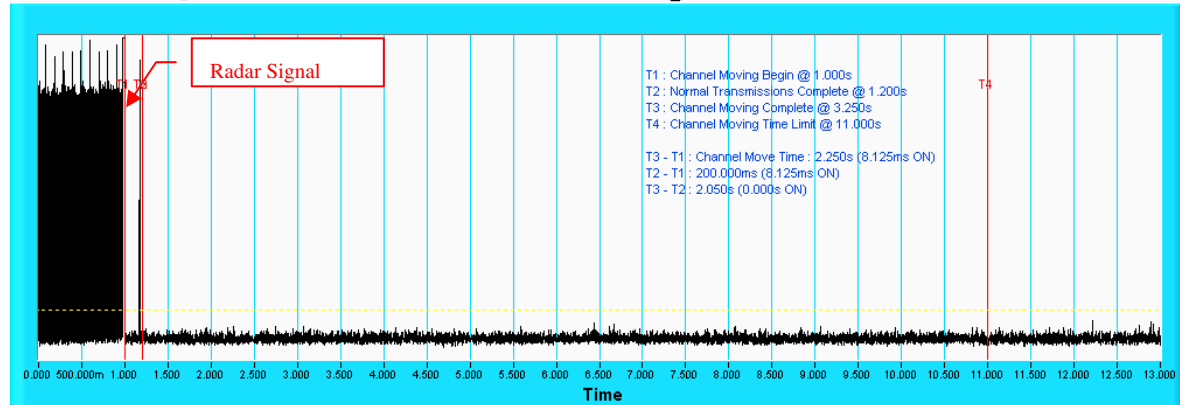

NOTE: T1 denotes the start of Channel Move Time upon the end of the last Radar burst. T2 denotes the data transmission time of 200ms from T1. T3 denotes the end of Channel Move Time. T4 denotes the 10 second from T1 to observe the aggregate duration of transmissions.

Channel Closing Transmission Time & Channel Move Time @ CH106 - AC80

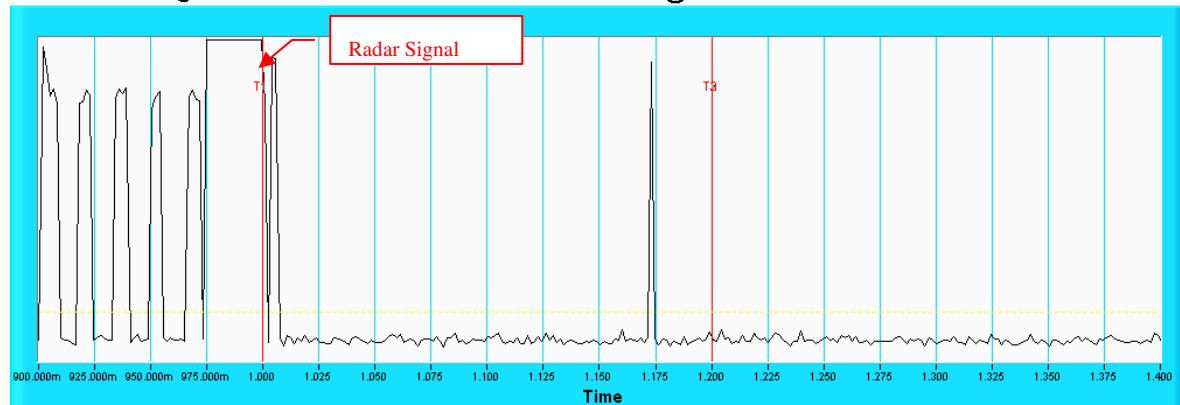

NOTE: An expanded plot for the device vacates the channel in the required 500ms.

Radar signal 2

Aggregate Transmission Time (ms)	Limit (ms)	Margin (ms)
0	60	60

Channel Closing Transmission Time & Channel Move Time @ CH106 - AC80

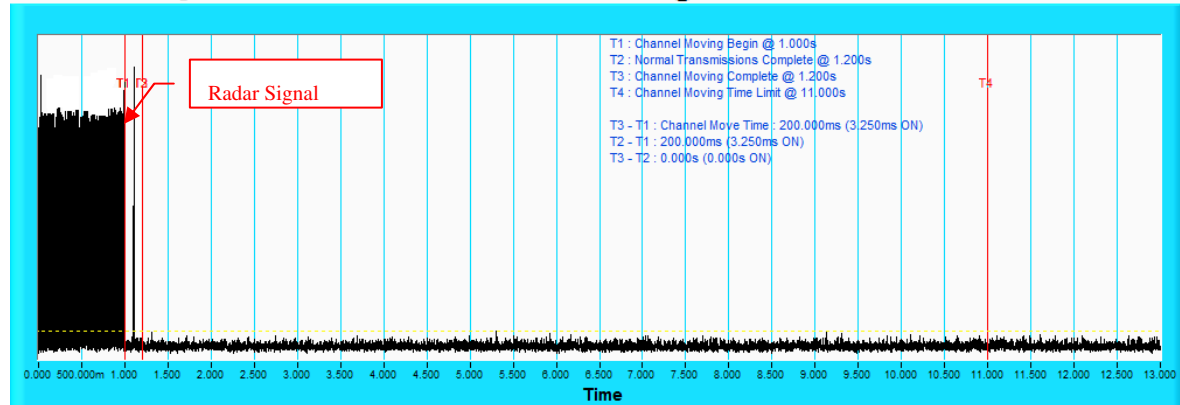

NOTE: T1 denotes the start of Channel Move Time upon the end of the last Radar burst. T2 denotes the data transmission time of 200ms from T1. T3 denotes the end of Channel Move Time. T4 denotes the 10 second from T1 to observe the aggregate duration of transmissions.

Channel Closing Transmission Time & Channel Move Time @ CH106 - AC80

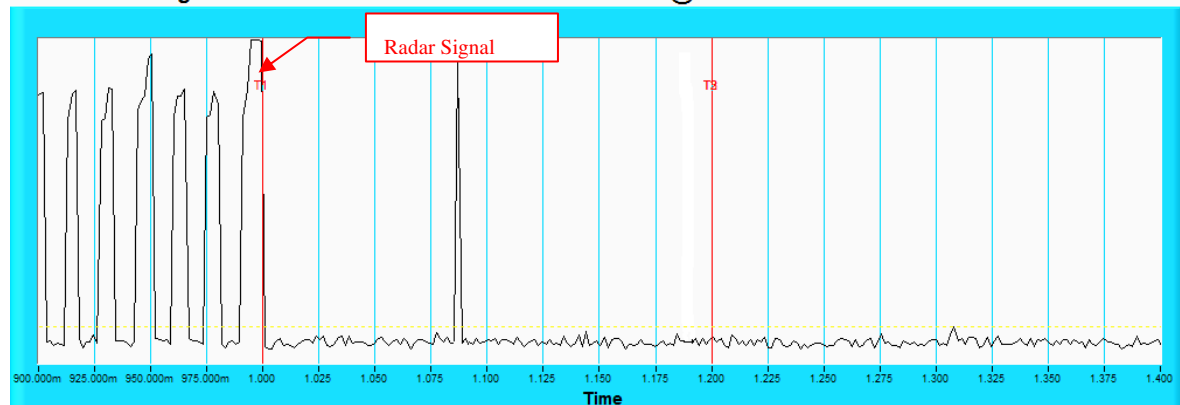

NOTE: An expanded plot for the device vacates the channel in the required 500ms.

Radar signal 3

Aggregate Transmission Time (ms)	Limit (ms)	Margin (ms)
0	60	60

Channel Closing Transmission Time & Channel Move Time @ CH106 - AC80

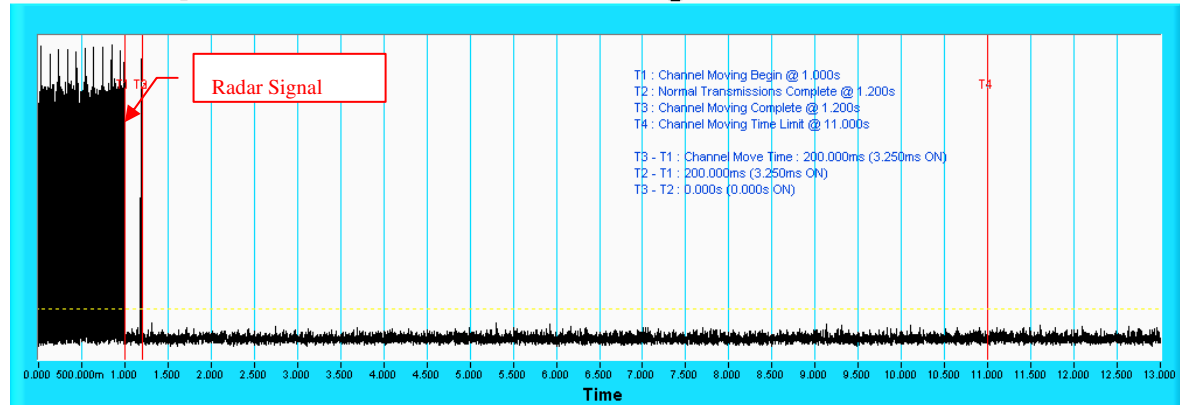

NOTE: T1 denotes the start of Channel Move Time upon the end of the last Radar burst. T2 denotes the data transmission time of 200ms from T1. T3 denotes the end of Channel Move Time. T4 denotes the 10 second from T1 to observe the aggregate duration of transmissions.

Channel Closing Transmission Time & Channel Move Time @ CH106 - AC80

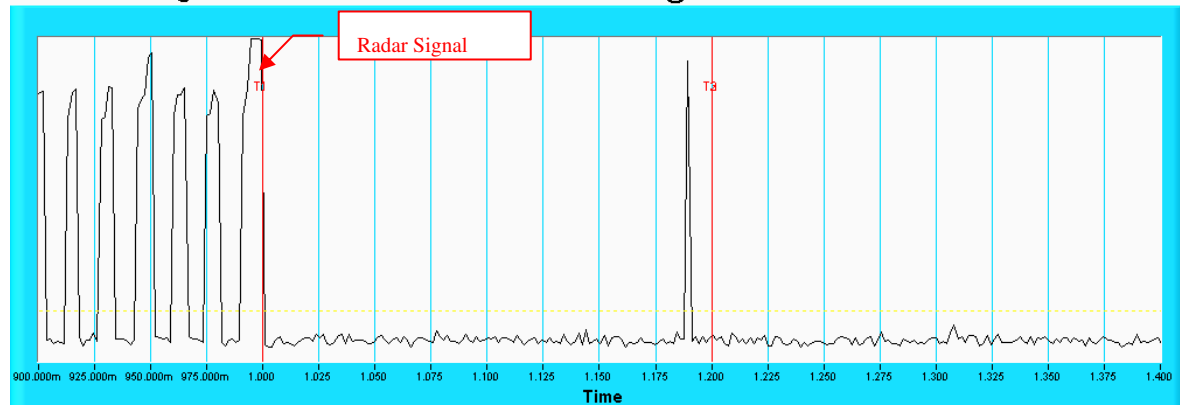

NOTE: An expanded plot for the device vacates the channel in the required 500ms.

Radar signal 4

Aggregate Transmission Time (ms)	Limit (ms)	Margin (ms)
22.75	60	37.25

Channel Closing Transmission Time & Channel Move Time @ CH106 - AC80

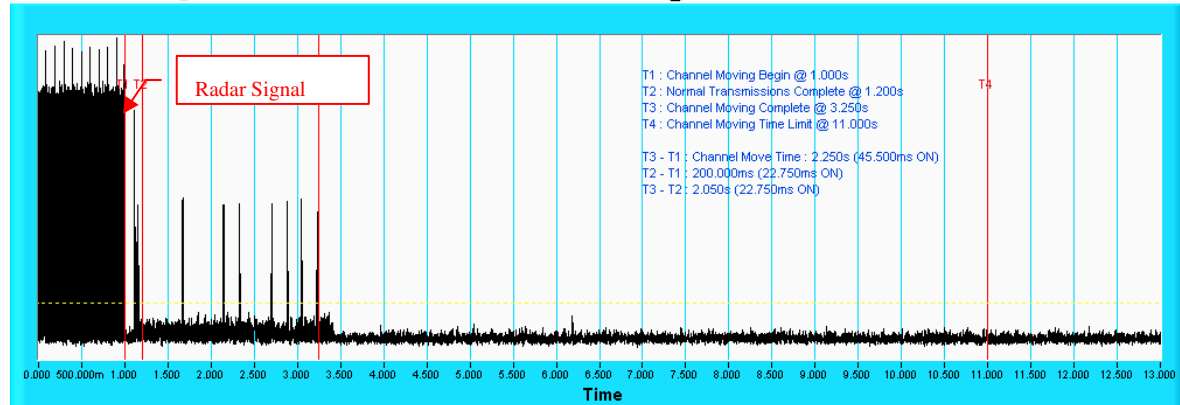

NOTE: T1 denotes the start of Channel Move Time upon the end of the last Radar burst. T2 denotes the data transmission time of 200ms from T1. T3 denotes the end of Channel Move Time. T4 denotes the 10 second from T1 to observe the aggregate duration of transmissions.

Channel Closing Transmission Time & Channel Move Time @ CH106 - AC80

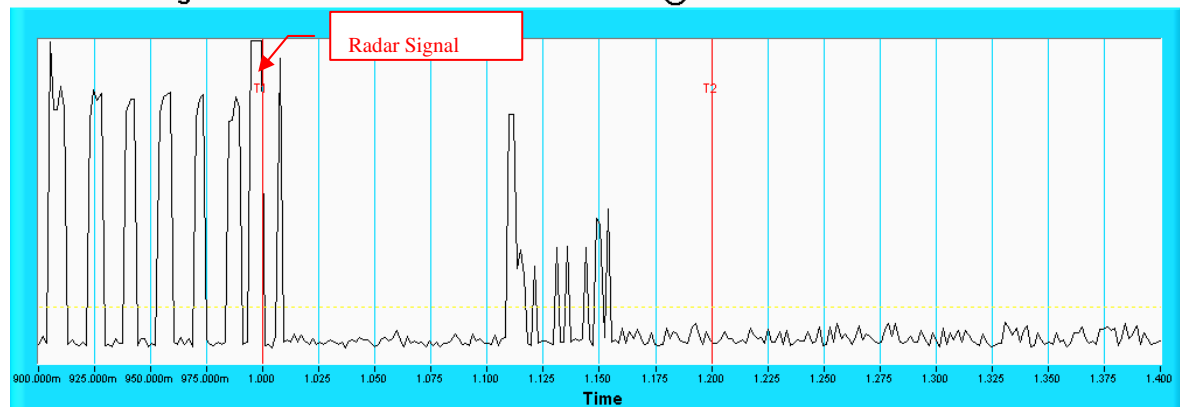

NOTE: An expanded plot for the device vacates the channel in the required 500ms.



A D T

Radar signal 5

Aggregate Transmission Time (ms)	Limit (ms)	Margin (ms)
0	60	60

Channel Closing Transmission Time & Channel Move Time @ CH106 - AC80

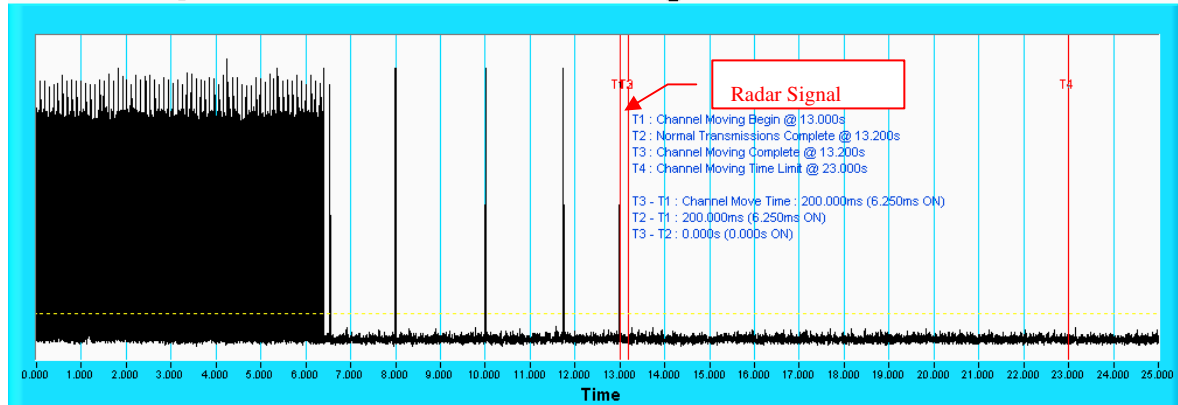

NOTE: T1 denotes the start of Channel Move Time upon the end of the last Radar burst. T2 denotes the data transmission time of 200ms from T1. T3 denotes the end of Channel Move Time. T4 denotes the 10 second from T1 to observe the aggregate duration of transmissions.

Channel Closing Transmission Time & Channel Move Time @ CH106 - AC80

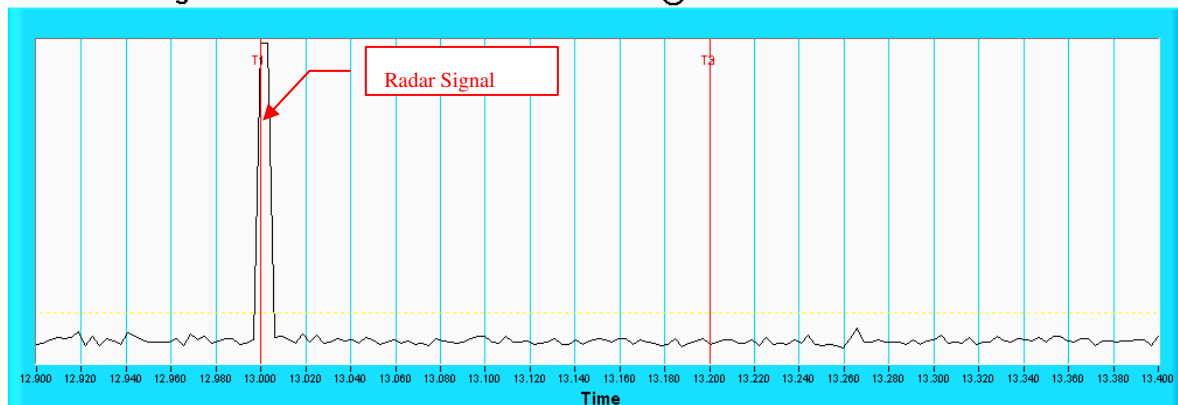

NOTE: An expanded plot for the device vacates the channel in the required 500ms.

Radar signal 6

Aggregate Transmission Time (ms)	Limit (ms)	Margin (ms)
0	60	60

Channel Closing Transmission Time & Channel Move Time @ CH106 - AC80

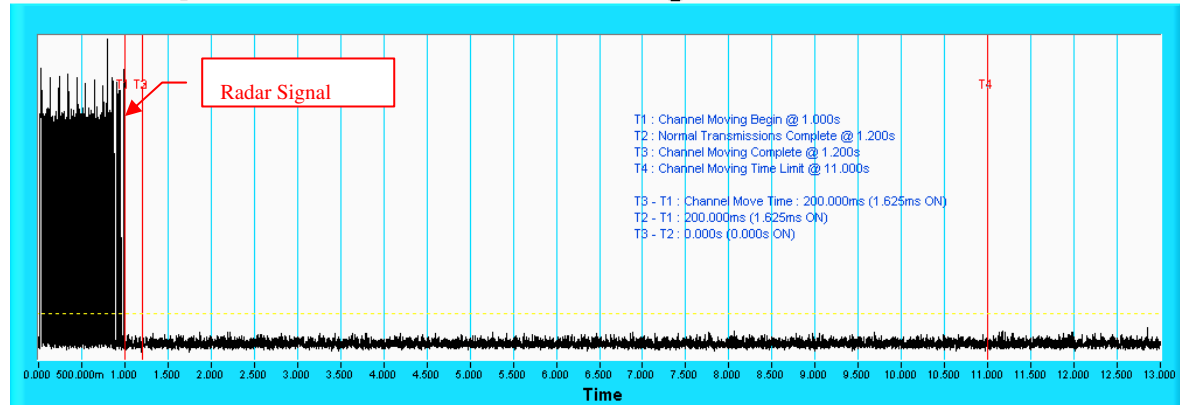

NOTE: T1 denotes the start of Channel Move Time upon the end of the last Radar burst. T2 denotes the data transmission time of 200ms from T1. T3 denotes the end of Channel Move Time. T4 denotes the 10 second from T1 to observe the aggregate duration of transmissions.

Channel Closing Transmission Time & Channel Move Time @ CH106 - AC80

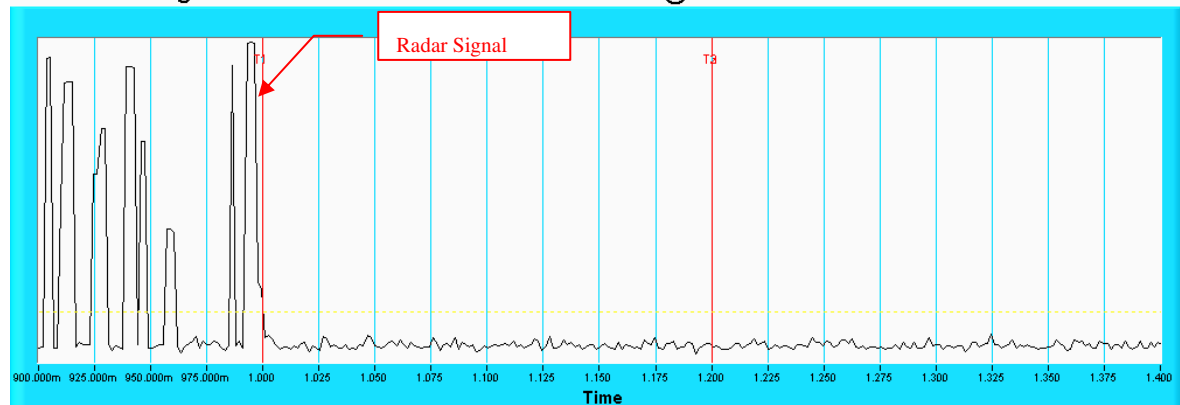

NOTE: An expanded plot for the device vacates the channel in the required 500ms.



A D T

802.11ac (VHT20)

Type 1 Radar Statistical Performances

Trial #	Test Frequency (MHz)	Pulse Repetition Frequency (Pulse per seconds)	Pulses per Burst	Pulse Repetition Interval (microseconds)	Detection
1	5500	1139	61	878	Yes
2	5506	1432.7	76	698	Yes
3	5508	1222.5	65	818	Yes
4	5503	1165.6	62	858	Yes
5	5498	1519.8	81	658	Yes
6	5504	1066.1	57	938	Yes
7	5492	1474.9	78	678	Yes
8	5508	1730.1	92	578	Yes
9	5505	1193.3	63	838	Yes
10	5501	326.2	18	3066	No
11	5506	1392.8	74	718	Yes
12	5505	1355	72	738	Yes
13	5500	1858.7	99	538	Yes
14	5495	1618.1	86	618	Yes
15	5497	1567.4	83	638	Yes
16	5494	379.4	21	2636	No
17	5494	885	47	1130	Yes
18	5501	435.2	23	2298	No
19	5504	841.8	45	1188	Yes
20	5508	757.6	40	1320	Yes
21	5493	689.2	37	1451	Yes
22	5498	335.8	18	2978	Yes
23	5502	529.4	28	1889	Yes
24	5498	327.3	18	3055	No
25	5498	660.9	35	1513	Yes
26	5509	755.9	40	1323	Yes
27	5495	347.9	19	2874	No
28	5506	1085.8	58	921	Yes
29	5507	1246.9	66	802	Yes
30	5494	433.7	23	2306	No

Detection Rate: 80 %

Minimum Percentage of Successful Detection: 60 %



A D T

802.11ac (VHT20)

Type 2 Radar Statistical Performances				
Trial #	Test Frequency(MHz)	Pulse Width(us)	PRI(us)	Detection
1	5500	3.7	150	Yes
2	5498	2.4	170	Yes
3	5503	2.3	193	Yes
4	5500	1.6	152	Yes
5	5495	1.6	157	No
6	5505	1.9	198	Yes
7	5497	1	213	Yes
8	5493	3.3	162	Yes
9	5494	1.2	185	Yes
10	5493	1.1	179	Yes
11	5508	4.9	173	Yes
12	5495	4.1	169	Yes
13	5503	3.9	217	Yes
14	5503	4.9	177	Yes
15	5506	5	218	Yes
16	5497	3.7	211	Yes
17	5508	1.6	212	Yes
18	5508	4.5	202	Yes
19	5491	4.2	214	No
20	5499	4.8	184	Yes
21	5493	1.2	194	Yes
22	5503	3.3	159	No
23	5497	1.1	159	Yes
24	5501	2.7	218	Yes
25	5504	4.2	224	Yes
26	5499	1.4	194	Yes
27	5499	4.6	188	No
28	5508	3.3	218	Yes
29	5493	3.2	225	Yes
30	5496	1.3	157	Yes

Detection Rate: 86.7%

Minimum Percentage of Successful Detection: 60 %



A D T

802.11ac (VHT20)

Type 3 Radar Statistical Performances				
Trial #	Test Frequency(MHz)	Pulse Width(us)	PRI(us)	Detection
1	5500	6.3	407	Yes
2	5500	8.1	457	Yes
3	5505	7	351	No
4	5506	7.2	238	Yes
5	5496	9	256	Yes
6	5498	6.6	466	Yes
7	5495	7.2	454	Yes
8	5494	6.2	215	Yes
9	5500	9.8	221	Yes
10	5496	6.8	291	Yes
11	5507	6.2	214	Yes
12	5507	6.3	486	Yes
13	5496	8.9	374	Yes
14	5492	8.6	304	Yes
15	5499	8.3	400	Yes
16	5499	7.1	291	No
17	5493	6.9	259	Yes
18	5493	9.9	497	Yes
19	5492	6.2	323	Yes
20	5499	9	311	Yes
21	5501	6.9	428	Yes
22	5507	9.9	226	Yes
23	5508	6.9	443	Yes
24	5507	6.3	493	Yes
25	5506	8.9	452	Yes
26	5498	7.9	464	Yes
27	5502	6.9	272	Yes
28	5501	7.2	317	Yes
29	5505	9.9	223	Yes
30	5501	7.3	477	Yes

Detection Rate: 93.3 %

Minimum Percentage of Successful Detection: 60 %



A D T

802.11ac (VHT20)

Type 4 Radar Statistical Performances				
Trial #	Test Frequency(MHz)	Pulse Width(us)	PRI(us)	Detection
1	5500	20	239	Yes
2	5499	12	465	No
3	5497	14.9	270	Yes
4	5502	15.7	233	Yes
5	5498	14.5	441	Yes
6	5499	17.5	231	No
7	5506	18	306	Yes
8	5502	17.7	389	Yes
9	5495	14	214	Yes
10	5498	16.1	415	Yes
11	5495	19.4	495	Yes
12	5499	19.3	343	Yes
13	5498	15.6	349	Yes
14	5493	16.9	393	No
15	5502	17.4	250	Yes
16	5495	14.8	425	Yes
17	5495	20	372	Yes
18	5500	11.3	476	Yes
19	5505	17.7	425	Yes
20	5492	17.5	347	Yes
21	5491	16.8	483	No
22	5495	17.4	350	Yes
23	5497	19.1	476	Yes
24	5492	19.3	365	Yes
25	5496	13	260	Yes
26	5502	19	303	Yes
27	5507	18	311	Yes
28	5508	19.8	493	Yes
29	5498	13.5	333	Yes
30	5500	13.6	478	Yes

Detection Rate: 86.7%

Minimum Percentage of Successful Detection: 60 %



A D T

802.11ac (VHT20)

Type 5 Radar Statistical Performances			
Trial #	Chirp Center Frequency(MHz)	Test Signal Name	Detection
1	5500	LP_Signal_01	Yes
2	5499	LP_Signal_02	Yes
3	5495	LP_Signal_03	Yes
4	5502	LP_Signal_04	Yes
5	5496	LP_Signal_05	Yes
6	5502	LP_Signal_06	Yes
7	5496	LP_Signal_07	No
8	5494	LP_Signal_08	Yes
9	5504	LP_Signal_09	Yes
10	5493	LP_Signal_10	Yes
11	5494	LP_Signal_11	Yes
12	5495	LP_Signal_12	Yes
13	5504	LP_Signal_13	No
14	5507	LP_Signal_14	Yes
15	5507	LP_Signal_15	Yes
16	5507	LP_Signal_16	Yes
17	5493	LP_Signal_17	Yes
18	5498	LP_Signal_18	Yes
19	5497	LP_Signal_19	No
20	5500	LP_Signal_20	Yes
21	5503	LP_Signal_21	Yes
22	5504	LP_Signal_22	No
23	5497	LP_Signal_23	Yes
24	5496	LP_Signal_24	No
25	5493	LP_Signal_25	Yes
26	5496	LP_Signal_26	Yes
27	5493	LP_Signal_27	Yes
28	5498	LP_Signal_28	Yes
29	5494	LP_Signal_29	No
30	5505	LP_Signal_30	Yes
			Detection Rate: 80.0 %
Minimum Percentage of Successful Detection: 80 %			

The Long Pulse Radar pattern shown in Appendix B.1



A D T

802.11ac (VHT20)

Type 6 Radar Statistical Performances

Trial #	Pulses per Burst	Pulse Width(us)	PRI(us)	Detection
1	9	1	333.3	Yes
2	9	1	333.3	Yes
3	9	1	333.3	No
4	9	1	333.3	Yes
5	9	1	333.3	Yes
6	9	1	333.3	Yes
7	9	1	333.3	Yes
8	9	1	333.3	Yes
9	9	1	333.3	Yes
10	9	1	333.3	Yes
11	9	1	333.3	Yes
12	9	1	333.3	No
13	9	1	333.3	Yes
14	9	1	333.3	Yes
15	9	1	333.3	Yes
16	9	1	333.3	Yes
17	9	1	333.3	Yes
18	9	1	333.3	Yes
19	9	1	333.3	Yes
20	9	1	333.3	Yes
21	9	1	333.3	Yes
22	9	1	333.3	Yes
23	9	1	333.3	Yes
24	9	1	333.3	No
25	9	1	333.3	No
26	9	1	333.3	Yes
27	9	1	333.3	No
28	9	1	333.3	Yes
29	9	1	333.3	Yes
30	9	1	333.3	Yes

Detection Rate: 83.3 %

Minimum Percentage of Successful Detection: 70 %



A D T

802.11ac (VHT20)

Type 6 Radar Statistical Performances		
Trial #	Hopping Frequency Sequence Name	Detection
1	HOP_FREQ_SEQ_01	Yes
2	HOP_FREQ_SEQ_02	Yes
3	HOP_FREQ_SEQ_03	No
4	HOP_FREQ_SEQ_04	Yes
5	HOP_FREQ_SEQ_05	Yes
6	HOP_FREQ_SEQ_06	Yes
7	HOP_FREQ_SEQ_07	Yes
8	HOP_FREQ_SEQ_08	Yes
9	HOP_FREQ_SEQ_09	Yes
10	HOP_FREQ_SEQ_10	Yes
11	HOP_FREQ_SEQ_11	Yes
12	HOP_FREQ_SEQ_12	No
13	HOP_FREQ_SEQ_13	Yes
14	HOP_FREQ_SEQ_14	Yes
15	HOP_FREQ_SEQ_15	Yes
16	HOP_FREQ_SEQ_16	Yes
17	HOP_FREQ_SEQ_17	Yes
18	HOP_FREQ_SEQ_18	Yes
19	HOP_FREQ_SEQ_19	Yes
20	HOP_FREQ_SEQ_20	Yes
21	HOP_FREQ_SEQ_21	Yes
22	HOP_FREQ_SEQ_22	Yes
23	HOP_FREQ_SEQ_23	Yes
24	HOP_FREQ_SEQ_24	No
25	HOP_FREQ_SEQ_25	No
26	HOP_FREQ_SEQ_26	Yes
27	HOP_FREQ_SEQ_27	No
28	HOP_FREQ_SEQ_28	Yes
29	HOP_FREQ_SEQ_29	Yes
30	HOP_FREQ_SEQ_30	Yes
		Detection Rate: 83.3 %
Minimum Percentage of Successful Detection: 70 %		

The Frequency Hopping Radar pattern shown in Appendix B.2



A D T

802.11ac (VHT40)

Type 1 Radar Statistical Performances

Trial #	Test Frequency(MHz)	Pulse Repetition Frequency (Pulse per seconds)	Pulses per Burst	Pulse Repetition Interval (microseconds)	Detection
1	5510	1139	61	878	Yes
2	5520	1432.7	76	698	Yes
3	5500	1222.5	65	818	Yes
4	5521	1165.6	62	858	Yes
5	5521	1519.8	81	658	Yes
6	5495	1066.1	57	938	Yes
7	5511	1474.9	78	678	Yes
8	5511	1730.1	92	578	Yes
9	5501	1193.3	63	838	Yes
10	5502	326.2	18	3066	No
11	5510	1392.8	74	718	Yes
12	5505	1355	72	738	Yes
13	5520	1858.7	99	538	Yes
14	5502	1618.1	86	618	Yes
15	5499	1567.4	83	638	Yes
16	5514	379.4	21	2636	Yes
17	5509	885	47	1130	Yes
18	5507	435.2	23	2298	Yes
19	5527	841.8	45	1188	Yes
20	5496	757.6	40	1320	Yes
21	5516	689.2	37	1451	Yes
22	5521	335.8	18	2978	No
23	5492	529.4	28	1889	Yes
24	5521	327.3	18	3055	No
25	5521	660.9	35	1513	Yes
26	5527	755.9	40	1323	Yes
27	5498	347.9	19	2874	Yes
28	5525	1085.8	58	921	Yes
29	5515	1246.9	66	802	Yes
30	5512	433.7	23	2306	No

Detection Rate: 86.7 %

Minimum Percentage of Successful Detection: 60 %



A D T

802.11ac (VHT40)

Type 2 Radar Statistical Performances				
Trial #	Test Frequency(MHz)	Pulse Width(us)	PRI(us)	Detection
1	5510	3.7	150	Yes
2	5520	2.4	170	Yes
3	5500	2.3	193	Yes
4	5492	1.6	152	Yes
5	5508	1.6	157	No
6	5498	1.9	198	Yes
7	5520	1	213	Yes
8	5519	3.3	162	Yes
9	5524	1.2	185	Yes
10	5504	1.1	179	Yes
11	5497	4.9	173	Yes
12	5497	4.1	169	Yes
13	5501	3.9	217	No
14	5507	4.9	177	Yes
15	5512	5	218	Yes
16	5499	3.7	211	Yes
17	5522	1.6	212	Yes
18	5513	4.5	202	Yes
19	5526	4.2	214	Yes
20	5504	4.8	184	Yes
21	5496	1.2	194	Yes
22	5501	3.3	159	No
23	5497	1.1	159	Yes
24	5527	2.7	218	Yes
25	5519	4.2	224	Yes
26	5524	1.4	194	Yes
27	5498	4.6	188	Yes
28	5526	3.3	218	Yes
29	5511	3.2	225	No
30	5498	1.3	157	Yes

Detection Rate: 86.7 %

Minimum Percentage of Successful Detection: 60 %



A D T

802.11ac (VHT40)

Type 3 Radar Statistical Performances				
Trial #	Test Frequency(MHz)	Pulse Width(us)	PRI(us)	Detection
1	5510	6.3	407	Yes
2	5520	8.1	457	Yes
3	5500	7	351	Yes
4	5503	7.2	238	Yes
5	5505	9	256	Yes
6	5493	6.6	466	Yes
7	5515	7.2	454	Yes
8	5513	6.2	215	Yes
9	5528	9.8	221	Yes
10	5499	6.8	291	Yes
11	5526	6.2	214	Yes
12	5507	6.3	486	Yes
13	5506	8.9	374	Yes
14	5510	8.6	304	Yes
15	5528	8.3	400	Yes
16	5514	7.1	291	No
17	5495	6.9	259	Yes
18	5496	9.9	497	Yes
19	5493	6.2	323	Yes
20	5511	9	311	Yes
21	5522	6.9	428	Yes
22	5506	9.9	226	Yes
23	5527	6.9	443	Yes
24	5507	6.3	493	Yes
25	5521	8.9	452	Yes
26	5502	7.9	464	Yes
27	5525	6.9	272	Yes
28	5496	7.2	317	Yes
29	5513	9.9	223	Yes
30	5518	7.3	477	Yes

Detection Rate: 96.7 %

Minimum Percentage of Successful Detection: 60 %



A D T

802.11ac (VHT40)

Type 4 Radar Statistical Performances				
Trial #	Test Frequency(MHz)	Pulse Width(us)	PRI(us)	Detection
1	5510	20	239	Yes
2	5520	12	465	Yes
3	5500	14.9	270	Yes
4	5519	15.7	233	No
5	5495	14.5	441	Yes
6	5506	17.5	231	Yes
7	5522	18	306	No
8	5509	17.7	389	No
9	5508	14	214	Yes
10	5515	16.1	415	Yes
11	5494	19.4	495	Yes
12	5524	19.3	343	Yes
13	5511	15.6	349	Yes
14	5492	16.9	393	Yes
15	5496	17.4	250	Yes
16	5508	14.8	425	Yes
17	5527	20	372	Yes
18	5526	11.3	476	Yes
19	5515	17.7	425	Yes
20	5515	17.5	347	Yes
21	5507	16.8	483	Yes
22	5514	17.4	350	Yes
23	5496	19.1	476	Yes
24	5522	19.3	365	No
25	5521	13	260	Yes
26	5498	19	303	Yes
27	5512	18	311	Yes
28	5526	19.8	493	Yes
29	5518	13.5	333	Yes
30	5503	13.6	478	Yes
				Detection Rate: 86.7 %
Minimum Percentage of Successful Detection: 60 %				



A D T

802.11ac (VHT40)

Type 5 Radar Statistical Performances

Trial #	Chirp Center Frequency(MHz)	Test Signal Name	Detection
1	5510	LP_Signal_01	Yes
2	5520	LP_Signal_02	Yes
3	5500	LP_Signal_03	Yes
4	5504	LP_Signal_04	Yes
5	5525	LP_Signal_05	Yes
6	5498	LP_Signal_06	Yes
7	5500	LP_Signal_07	No
8	5501	LP_Signal_08	Yes
9	5504	LP_Signal_09	Yes
10	5514	LP_Signal_10	Yes
11	5524	LP_Signal_11	Yes
12	5503	LP_Signal_12	Yes
13	5512	LP_Signal_13	No
14	5516	LP_Signal_14	Yes
15	5506	LP_Signal_15	Yes
16	5498	LP_Signal_16	Yes
17	5500	LP_Signal_17	Yes
18	5499	LP_Signal_18	Yes
19	5502	LP_Signal_19	No
20	5508	LP_Signal_20	Yes
21	5503	LP_Signal_21	Yes
22	5522	LP_Signal_22	Yes
23	5524	LP_Signal_23	Yes
24	5497	LP_Signal_24	Yes
25	5504	LP_Signal_25	No
26	5523	LP_Signal_26	No
27	5515	LP_Signal_27	Yes
28	5509	LP_Signal_28	Yes
29	5525	LP_Signal_29	No
30	5522	LP_Signal_30	Yes

Detection Rate: 80 %

Minimum Percentage of Successful Detection: 80 %

The Long Pulse Radar pattern shown in Appendix B.1



A D T

802.11ac (VHT40)

Type 6 Radar Statistical Performances

Trial #	Pulses per Burst	Pulse Width(us)	PRI(us)	Detection
1	9	1	333.3	Yes
2	9	1	333.3	Yes
3	9	1	333.3	Yes
4	9	1	333.3	Yes
5	9	1	333.3	Yes
6	9	1	333.3	No
7	9	1	333.3	Yes
8	9	1	333.3	Yes
9	9	1	333.3	No
10	9	1	333.3	No
11	9	1	333.3	Yes
12	9	1	333.3	Yes
13	9	1	333.3	Yes
14	9	1	333.3	Yes
15	9	1	333.3	Yes
16	9	1	333.3	Yes
17	9	1	333.3	Yes
18	9	1	333.3	Yes
19	9	1	333.3	Yes
20	9	1	333.3	Yes
21	9	1	333.3	Yes
22	9	1	333.3	Yes
23	9	1	333.3	Yes
24	9	1	333.3	No
25	9	1	333.3	Yes
26	9	1	333.3	Yes
27	9	1	333.3	Yes
28	9	1	333.3	No
29	9	1	333.3	Yes
30	9	1	333.3	No

Detection Rate: 80 %

Minimum Percentage of Successful Detection: 70 %



A D T

802.11ac (VHT40)

Type 6 Radar Statistical Performances

Trial #	Hopping Frequency Sequence Name	Detection
1	HOP_FREQ_SEQ_01	Yes
2	HOP_FREQ_SEQ_02	Yes
3	HOP_FREQ_SEQ_03	Yes
4	HOP_FREQ_SEQ_04	Yes
5	HOP_FREQ_SEQ_05	Yes
6	HOP_FREQ_SEQ_06	No
7	HOP_FREQ_SEQ_07	Yes
8	HOP_FREQ_SEQ_08	Yes
9	HOP_FREQ_SEQ_09	No
10	HOP_FREQ_SEQ_10	No
11	HOP_FREQ_SEQ_11	Yes
12	HOP_FREQ_SEQ_12	Yes
13	HOP_FREQ_SEQ_13	Yes
14	HOP_FREQ_SEQ_14	Yes
15	HOP_FREQ_SEQ_15	Yes
16	HOP_FREQ_SEQ_16	Yes
17	HOP_FREQ_SEQ_17	Yes
18	HOP_FREQ_SEQ_18	Yes
19	HOP_FREQ_SEQ_19	Yes
20	HOP_FREQ_SEQ_20	Yes
21	HOP_FREQ_SEQ_21	Yes
22	HOP_FREQ_SEQ_22	Yes
23	HOP_FREQ_SEQ_23	Yes
24	HOP_FREQ_SEQ_24	No
25	HOP_FREQ_SEQ_25	Yes
26	HOP_FREQ_SEQ_26	Yes
27	HOP_FREQ_SEQ_27	Yes
28	HOP_FREQ_SEQ_28	No
29	HOP_FREQ_SEQ_29	Yes
30	HOP_FREQ_SEQ_30	No

Detection Rate: 80 %

Minimum Percentage of Successful Detection: 70 %

The Frequency Hopping Radar pattern shown in Appendix B.2



A D T

802.11ac (VHT80)

Type 1 Radar Statistical Performances

Trial #	Test Frequency(MHz)	Pulse Repetition Frequency (Pulse per seconds)	Pulses per Burst	Pulse Repetition Interval (microseconds)	Detection
1	5530	1139	61	878	Yes
2	5540	1432.7	76	698	Yes
3	5560	1222.5	65	818	Yes
4	5520	1165.6	62	858	Yes
5	5500	1519.8	81	658	Yes
6	5502	1066.1	57	938	Yes
7	5525	1474.9	78	678	Yes
8	5547	1730.1	92	578	Yes
9	5551	1193.3	63	838	Yes
10	5514	326.2	18	3066	No
11	5537	1392.8	74	718	Yes
12	5554	1355	72	738	Yes
13	5545	1858.7	99	538	Yes
14	5518	1618.1	86	618	Yes
15	5527	1567.4	83	638	Yes
16	5544	379.4	21	2636	No
17	5550	885	47	1130	Yes
18	5554	435.2	23	2298	No
19	5519	841.8	45	1188	Yes
20	5514	757.6	40	1320	Yes
21	5517	689.2	37	1451	Yes
22	5507	335.8	18	2978	Yes
23	5547	529.4	28	1889	Yes
24	5547	327.3	18	3055	No
25	5526	660.9	35	1513	Yes
26	5516	755.9	40	1323	Yes
27	5547	347.9	19	2874	No
28	5524	1085.8	58	921	Yes
29	5536	1246.9	66	802	Yes
30	5553	433.7	23	2306	Yes

Detection Rate: 83.3 %

Minimum Percentage of Successful Detection: 60 %



A D T

802.11ac (VHT80)

Type 2 Radar Statistical Performances

Trial #	Test Frequency(MHz)	Pulse Width(us)	PRI(us)	Detection
1	5530	3.7	150	Yes
2	5540	2.4	170	Yes
3	5560	2.3	193	Yes
4	5520	1.6	152	Yes
5	5500	1.6	157	Yes
6	5522	1.9	198	Yes
7	5552	1	213	Yes
8	5524	3.3	162	No
9	5540	1.2	185	Yes
10	5522	1.1	179	Yes
11	5530	4.9	173	Yes
12	5527	4.1	169	Yes
13	5524	3.9	217	Yes
14	5553	4.9	177	Yes
15	5534	5	218	Yes
16	5545	3.7	211	Yes
17	5532	1.6	212	Yes
18	5526	4.5	202	No
19	5523	4.2	214	Yes
20	5538	4.8	184	Yes
21	5536	1.2	194	Yes
22	5555	3.3	159	Yes
23	5524	1.1	159	Yes
24	5525	2.7	218	Yes
25	5550	4.2	224	Yes
26	5523	1.4	194	Yes
27	5500	4.6	188	No
28	5514	3.3	218	Yes
29	5503	3.2	225	No
30	5542	1.3	157	Yes

Detection Rate: 86.7 %

Minimum Percentage of Successful Detection: 60 %



A D T

802.11ac (VHT80)

Type 3 Radar Statistical Performances				
Trial #	Test Frequency(MHz)	Pulse Width(us)	PRI(us)	Detection
1	5530	6.3	407	Yes
2	5540	8.1	457	No
3	5560	7	351	Yes
4	5520	7.2	238	Yes
5	5500	9	256	Yes
6	5546	6.6	466	Yes
7	5558	7.2	454	Yes
8	5543	6.2	215	Yes
9	5503	9.8	221	Yes
10	5515	6.8	291	Yes
11	5511	6.2	214	Yes
12	5524	6.3	486	Yes
13	5513	8.9	374	Yes
14	5500	8.6	304	Yes
15	5505	8.3	400	Yes
16	5501	7.1	291	Yes
17	5549	6.9	259	Yes
18	5501	9.9	497	Yes
19	5509	6.2	323	Yes
20	5513	9	311	Yes
21	5520	6.9	428	Yes
22	5533	9.9	226	Yes
23	5519	6.9	443	Yes
24	5556	6.3	493	Yes
25	5549	8.9	452	Yes
26	5528	7.9	464	Yes
27	5527	6.9	272	No
28	5508	7.2	317	Yes
29	5518	9.9	223	Yes
30	5503	7.3	477	Yes

Detection Rate: 93.3 %

Minimum Percentage of Successful Detection: 60 %



A D T

802.11ac (VHT80)

Type 4 Radar Statistical Performances

Trial #	Test Frequency(MHz)	Pulse Width(us)	PRI(us)	Detection
1	5530	20	239	Yes
2	5540	12	465	Yes
3	5560	14.9	270	No
4	5520	15.7	233	Yes
5	5500	14.5	441	Yes
6	5502	17.5	231	Yes
7	5550	18	306	Yes
8	5535	17.7	389	Yes
9	5537	14	214	Yes
10	5517	16.1	415	Yes
11	5524	19.4	495	Yes
12	5547	19.3	343	Yes
13	5533	15.6	349	No
14	5547	16.9	393	Yes
15	5520	17.4	250	Yes
16	5535	14.8	425	Yes
17	5530	20	372	Yes
18	5514	11.3	476	Yes
19	5545	17.7	425	No
20	5525	17.5	347	Yes
21	5512	16.8	483	Yes
22	5520	17.4	350	Yes
23	5505	19.1	476	Yes
24	5527	19.3	365	Yes
25	5557	13	260	Yes
26	5556	19	303	Yes
27	5559	18	311	Yes
28	5501	19.8	493	Yes
29	5523	13.5	333	Yes
30	5532	13.6	478	Yes

Detection Rate: 90 %

Minimum Percentage of Successful Detection: 60 %



A D T

802.11ac (VHT80)

Type 5 Radar Statistical Performances			
Trial #	Chirp Center Frequency(MHz)	Test Signal Name	Detection
1	5530	LP_Signal_01	Yes
2	5540	LP_Signal_02	Yes
3	5560	LP_Signal_03	No
4	5520	LP_Signal_04	Yes
5	5500	LP_Signal_05	Yes
6	5541	LP_Signal_06	Yes
7	5513	LP_Signal_07	Yes
8	5551	LP_Signal_08	Yes
9	5538	LP_Signal_09	Yes
10	5525	LP_Signal_10	Yes
11	5517	LP_Signal_11	Yes
12	5550	LP_Signal_12	Yes
13	5559	LP_Signal_13	Yes
14	5523	LP_Signal_14	Yes
15	5526	LP_Signal_15	Yes
16	5542	LP_Signal_16	Yes
17	5511	LP_Signal_17	Yes
18	5515	LP_Signal_18	Yes
19	5512	LP_Signal_19	No
20	5550	LP_Signal_20	Yes
21	5522	LP_Signal_21	Yes
22	5552	LP_Signal_22	Yes
23	5531	LP_Signal_23	Yes
24	5514	LP_Signal_24	Yes
25	5527	LP_Signal_25	No
26	5512	LP_Signal_26	Yes
27	5519	LP_Signal_27	Yes
28	5513	LP_Signal_28	Yes
29	5551	LP_Signal_29	Yes
30	5511	LP_Signal_30	Yes

Detection Rate: 90 %

Minimum Percentage of Successful Detection: 80 %

The Long Pulse Radar pattern shown in Appendix B.1



A D T

802.11ac (VHT80)

Type 6 Radar Statistical Performances

Trial #	Pulses per Burst	Pulse Width(us)	PRI(us)	Detection
1	9	1	333.3	Yes
2	9	1	333.3	No
3	9	1	333.3	Yes
4	9	1	333.3	No
5	9	1	333.3	Yes
6	9	1	333.3	Yes
7	9	1	333.3	Yes
8	9	1	333.3	Yes
9	9	1	333.3	Yes
10	9	1	333.3	Yes
11	9	1	333.3	Yes
12	9	1	333.3	Yes
13	9	1	333.3	Yes
14	9	1	333.3	Yes
15	9	1	333.3	Yes
16	9	1	333.3	Yes
17	9	1	333.3	Yes
18	9	1	333.3	Yes
19	9	1	333.3	Yes
20	9	1	333.3	Yes
21	9	1	333.3	Yes
22	9	1	333.3	Yes
23	9	1	333.3	Yes
24	9	1	333.3	Yes
25	9	1	333.3	Yes
26	9	1	333.3	No
27	9	1	333.3	No
28	9	1	333.3	Yes
29	9	1	333.3	No
30	9	1	333.3	Yes

Detection Rate: 83.3%

Minimum Percentage of Successful Detection: 70 %



A D T

802.11ac (VHT80)

Type 6 Radar Statistical Performances

Trial #	Hopping Frequency Sequence Name	Detection
1	HOP_FREQ_SEQ_01	Yes
2	HOP_FREQ_SEQ_02	No
3	HOP_FREQ_SEQ_03	Yes
4	HOP_FREQ_SEQ_04	No
5	HOP_FREQ_SEQ_05	Yes
6	HOP_FREQ_SEQ_06	Yes
7	HOP_FREQ_SEQ_07	Yes
8	HOP_FREQ_SEQ_08	Yes
9	HOP_FREQ_SEQ_09	Yes
10	HOP_FREQ_SEQ_10	Yes
11	HOP_FREQ_SEQ_11	Yes
12	HOP_FREQ_SEQ_12	Yes
13	HOP_FREQ_SEQ_13	Yes
14	HOP_FREQ_SEQ_14	Yes
15	HOP_FREQ_SEQ_15	Yes
16	HOP_FREQ_SEQ_16	Yes
17	HOP_FREQ_SEQ_17	Yes
18	HOP_FREQ_SEQ_18	Yes
19	HOP_FREQ_SEQ_19	Yes
20	HOP_FREQ_SEQ_20	Yes
21	HOP_FREQ_SEQ_21	Yes
22	HOP_FREQ_SEQ_22	Yes
23	HOP_FREQ_SEQ_23	Yes
24	HOP_FREQ_SEQ_24	Yes
25	HOP_FREQ_SEQ_25	Yes
26	HOP_FREQ_SEQ_26	No
27	HOP_FREQ_SEQ_27	No
28	HOP_FREQ_SEQ_28	Yes
29	HOP_FREQ_SEQ_29	No
30	HOP_FREQ_SEQ_30	Yes

Detection Rate: 83.3 %

Minimum Percentage of Successful Detection: 70 %

The Frequency Hopping Radar pattern shown in Appendix B.2

6.2.1.4 NON- OCCUPANCY PERIOD

1) Test results demonstrating an associated client link is established with the master on a test frequency.

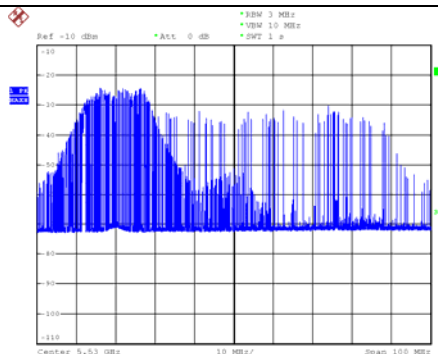

EUT (master) links with Client on 5530MHz

2) The master and DFS-certified client device are associated, and system testing will be performed with channel-loading for a non-occupancy period test.

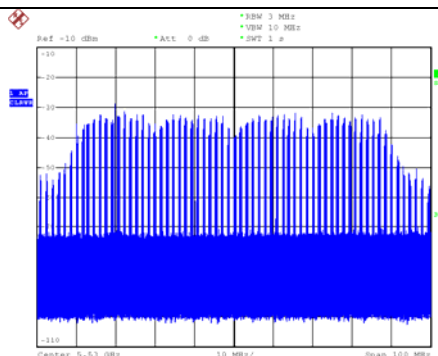

Client performed with channel-loading via master.

3). The device transmits one type of radar as specified in the DFS Order.

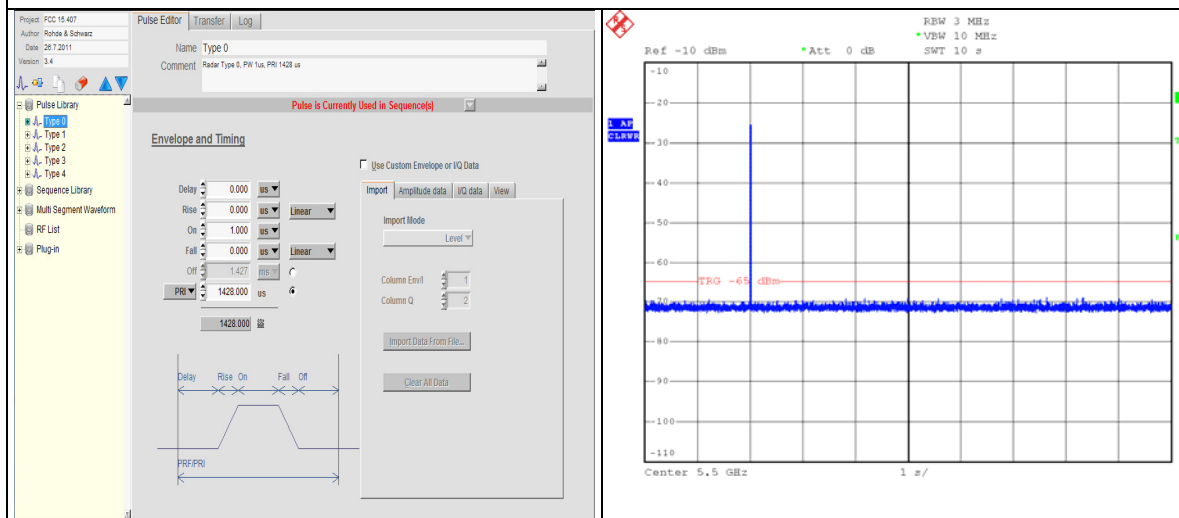

Radar 0 is used to test during DFS testing.

4) The test frequency has been monitored to ensure no transmission of any type has occurred for 30 minutes;

Note: If the client moves with the master, the device is considered compliant if nothing appears in the client non-occupancy period test. For devices that shut down (rather than moving channels), no beacons should appear;

5) An analyzer plot that contains a single 30-minute sweep on the original test frequency.

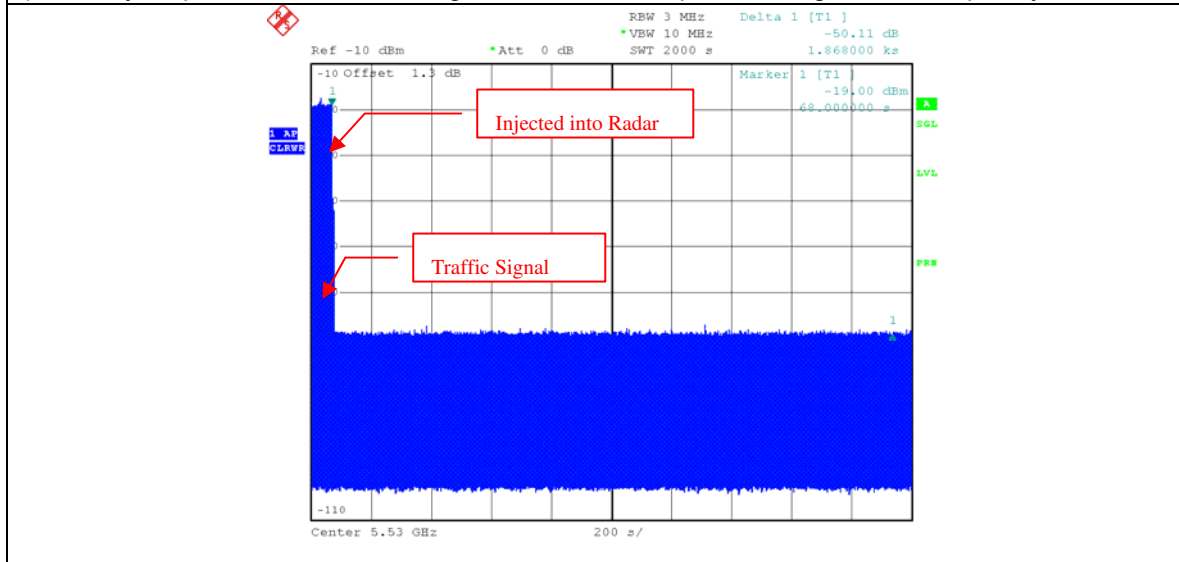



A D T

6.2.1.6 U-NII DETECTION BANDWIDTH

802.11ac (VHT20)



Ref -10 dBm *Att 0 dB *RBW 300 kHz Marker 1 [T1]
*VBW 1 MHz -42.62 dBm
*SWT 1 s 5.506922500 GHz

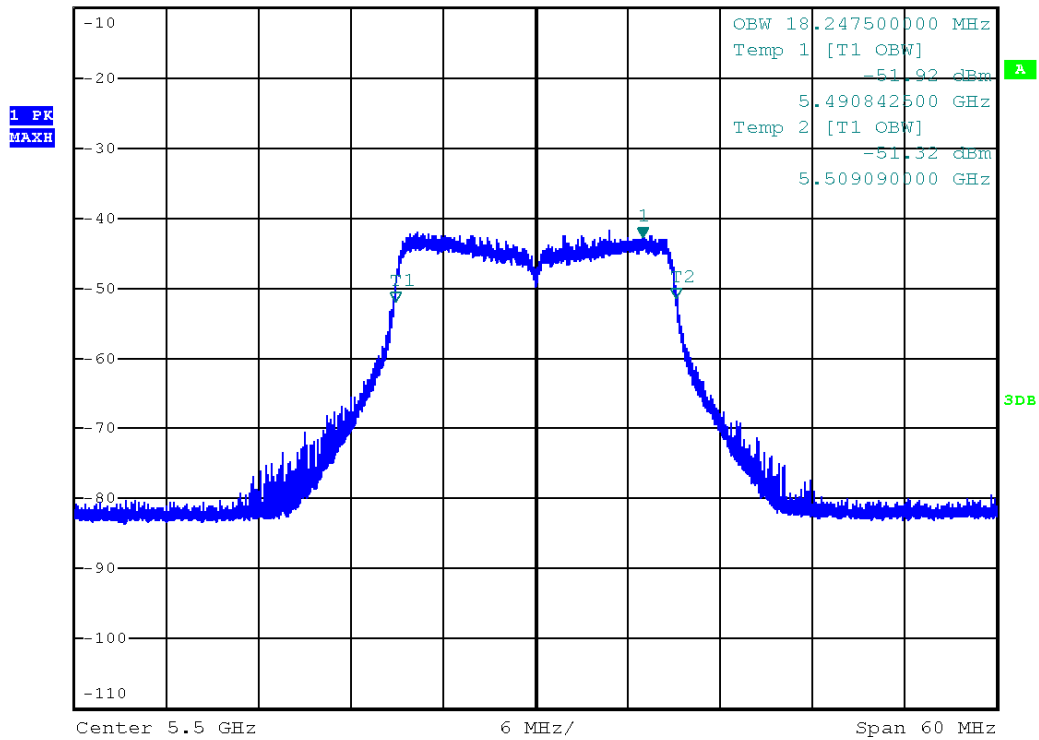

U-NII 99% Channel bandwidth



A D T

802.11ac (VHT20)

Detection Bandwidth Test											
EUT Frequency: 5.500GHz											
EUT 99% Power bandwidth: 18.24MHz											
Detection bandwidth limit (100% of EUT 99% Power bandwidth): 18.24MHz											
Detection Bandwidth (FH - FL): 20.00MHz											
Test Result : PASS											
Radar Frequency (Hz)	Trial Number / Detection										Detection Rate (%)
	1	2	3	4	5	6	7	8	9	10	
5.490G(FL)	Yes	Yes	Yes	Yes	No	Yes	Yes	Yes	Yes	Yes	90
5.491G	Yes	Yes	Yes	Yes	No	Yes	Yes	Yes	Yes	Yes	90
5.492G	Yes	Yes	Yes	Yes	Yes	Yes	Yes	Yes	Yes	Yes	100
5.493G	Yes	Yes	Yes	Yes	Yes	Yes	Yes	Yes	Yes	Yes	100
5.494G	Yes	Yes	Yes	Yes	Yes	Yes	Yes	Yes	Yes	Yes	100
5.495G	Yes	Yes	Yes	Yes	Yes	Yes	Yes	Yes	Yes	Yes	100
5.496G	Yes	Yes	Yes	Yes	Yes	Yes	Yes	Yes	Yes	Yes	100
5.497G	Yes	Yes	Yes	Yes	Yes	Yes	Yes	Yes	Yes	Yes	100
5.498G	Yes	Yes	Yes	Yes	Yes	Yes	Yes	Yes	Yes	Yes	100
5.499G	Yes	Yes	Yes	Yes	Yes	Yes	Yes	Yes	Yes	Yes	100
5.500G	Yes	Yes	Yes	Yes	Yes	Yes	Yes	Yes	Yes	Yes	100
5.501G	Yes	Yes	Yes	Yes	Yes	Yes	Yes	Yes	Yes	Yes	100
5.502G	Yes	Yes	Yes	Yes	Yes	Yes	Yes	Yes	Yes	Yes	100
5.503G	Yes	Yes	Yes	Yes	Yes	Yes	Yes	Yes	Yes	Yes	100
5.504G	Yes	Yes	Yes	Yes	Yes	Yes	Yes	Yes	Yes	Yes	100
5.505G	Yes	Yes	Yes	Yes	Yes	Yes	Yes	Yes	Yes	Yes	100
5.506G	Yes	Yes	Yes	Yes	Yes	Yes	Yes	Yes	Yes	Yes	100
5.507G	Yes	Yes	Yes	Yes	Yes	Yes	Yes	Yes	Yes	Yes	100
5.508G	Yes	Yes	Yes	Yes	Yes	Yes	Yes	Yes	Yes	Yes	100
5.509G	Yes	Yes	Yes	Yes	Yes	Yes	Yes	Yes	Yes	Yes	100
5.510G(FH)	Yes	Yes	Yes	Yes	Yes	Yes	Yes	Yes	Yes	Yes	100



A D T

802.11ac (VHT40)



*RBW 1 MHz Marker 1 [T1]
VBW 3 MHz -19.49 dBm
SWT 40 ms 5.502312500 GHz

Ref -10 dBm

*Att 0 dB

1 PK
MAXH

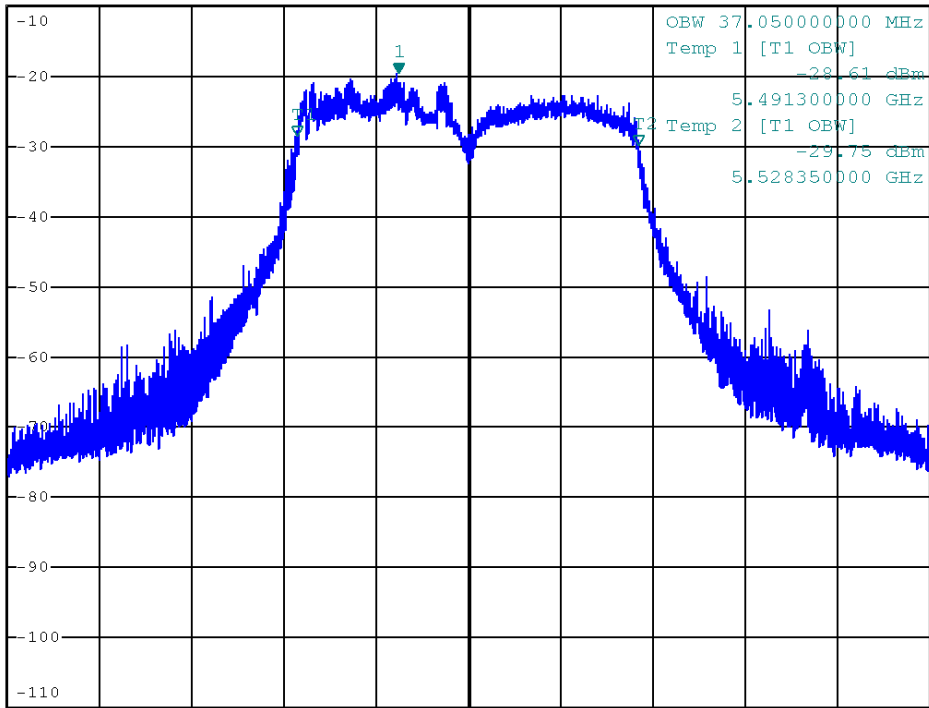

Center 5.51 GHz

10 MHz/

Span 100 MHz

U-NII 99% Channel bandwidth



A D T

802.11ac (VHT40)

Detection Bandwidth Test											
EUT Frequency: 5.510GHz											
EUT 99% Power bandwidth: 37.05MHz											
Detection bandwidth limit (100% of EUT 99% Power bandwidth): 37.05MHz											
Detection Bandwidth (FH - FL): 38MHz											
Test Result : PASS											
Radar Frequency (Hz)	Trial Number / Detection										Detection Rate (%)
	1	2	3	4	5	6	7	8	9	10	
5.490G	No	No	No	No	No	No	No	No	No	No	0
5.491G(FL)	Yes	Yes	Yes	Yes	Yes	Yes	Yes	Yes	Yes	Yes	100
5.492G	Yes	Yes	Yes	Yes	Yes	Yes	Yes	Yes	Yes	Yes	100
5.493G	Yes	Yes	Yes	Yes	Yes	Yes	Yes	Yes	Yes	Yes	100
5.494G	Yes	Yes	Yes	Yes	Yes	Yes	Yes	Yes	Yes	Yes	100
5.495G	Yes	Yes	Yes	Yes	Yes	Yes	Yes	Yes	Yes	Yes	100
5.496G	Yes	Yes	Yes	Yes	Yes	Yes	Yes	Yes	Yes	Yes	100
5.497G	Yes	Yes	Yes	Yes	Yes	Yes	Yes	Yes	Yes	Yes	100
5.498G	Yes	Yes	Yes	Yes	Yes	Yes	Yes	Yes	Yes	Yes	100
5.499G	Yes	Yes	Yes	Yes	Yes	Yes	Yes	Yes	Yes	Yes	100
5.500G	Yes	Yes	Yes	Yes	Yes	Yes	Yes	Yes	Yes	Yes	100
5.501G	Yes	Yes	Yes	Yes	Yes	Yes	Yes	Yes	Yes	Yes	100
5.502G	Yes	Yes	Yes	Yes	Yes	Yes	Yes	Yes	Yes	Yes	100
5.503G	Yes	Yes	Yes	Yes	Yes	Yes	Yes	Yes	Yes	Yes	100
5.504G	Yes	Yes	Yes	Yes	Yes	Yes	Yes	Yes	Yes	Yes	100
5.505G	Yes	Yes	Yes	Yes	Yes	Yes	Yes	Yes	Yes	Yes	100
5.506G	Yes	Yes	Yes	Yes	Yes	Yes	Yes	Yes	Yes	Yes	100
5.507G	Yes	Yes	Yes	Yes	Yes	Yes	Yes	Yes	Yes	Yes	100
5.508G	Yes	Yes	Yes	Yes	Yes	Yes	Yes	Yes	Yes	Yes	100
5.509G	Yes	Yes	Yes	Yes	Yes	Yes	Yes	Yes	Yes	Yes	100
5.510G	Yes	Yes	Yes	Yes	Yes	Yes	Yes	Yes	Yes	Yes	100
5.511G	Yes	Yes	Yes	Yes	Yes	Yes	Yes	Yes	Yes	Yes	100
5.512G	Yes	Yes	Yes	Yes	Yes	Yes	Yes	Yes	Yes	Yes	100
5.513G	Yes	Yes	Yes	Yes	Yes	Yes	Yes	Yes	Yes	Yes	100
5.514G	Yes	Yes	Yes	Yes	Yes	Yes	Yes	Yes	Yes	Yes	100
5.515G	Yes	Yes	Yes	Yes	Yes	Yes	Yes	Yes	Yes	Yes	100
5.516G	Yes	Yes	Yes	Yes	Yes	Yes	Yes	Yes	Yes	Yes	100
5.517G	Yes	Yes	Yes	Yes	Yes	Yes	Yes	Yes	Yes	Yes	100
5.518G	Yes	Yes	Yes	Yes	Yes	Yes	Yes	Yes	Yes	Yes	100
5.519G	Yes	Yes	Yes	Yes	Yes	Yes	Yes	Yes	Yes	Yes	100
5.520G	Yes	Yes	Yes	Yes	Yes	Yes	Yes	Yes	Yes	Yes	100
5.521G	Yes	Yes	Yes	Yes	Yes	Yes	Yes	Yes	Yes	Yes	100
5.522G	Yes	Yes	Yes	Yes	Yes	Yes	Yes	Yes	Yes	Yes	100
5.523G	Yes	Yes	Yes	Yes	Yes	Yes	Yes	Yes	Yes	Yes	100
5.524G	Yes	Yes	Yes	Yes	Yes	Yes	Yes	Yes	Yes	Yes	100
5.525G	No	Yes	Yes	Yes	Yes	Yes	Yes	Yes	Yes	Yes	90
5.526G	Yes	Yes	Yes	Yes	Yes	Yes	Yes	Yes	Yes	Yes	100
5.527G	Yes	Yes	Yes	Yes	Yes	Yes	Yes	Yes	Yes	Yes	100
5.528G	Yes	Yes	No	Yes	Yes	Yes	Yes	Yes	Yes	Yes	90
5.529G(FH)	No	Yes	Yes	Yes	Yes	Yes	Yes	Yes	Yes	Yes	90
5.530G	No	No	No	No	No	No	No	No	No	No	0



A D T

802.11ac (VHT80)



*RBW 1 MHz Marker 1 [T1]
*VBW 3 MHz -19.35 dBm
Ref -10 dBm *Att 0 dB SWT 40 ms 5.505540000 GHz

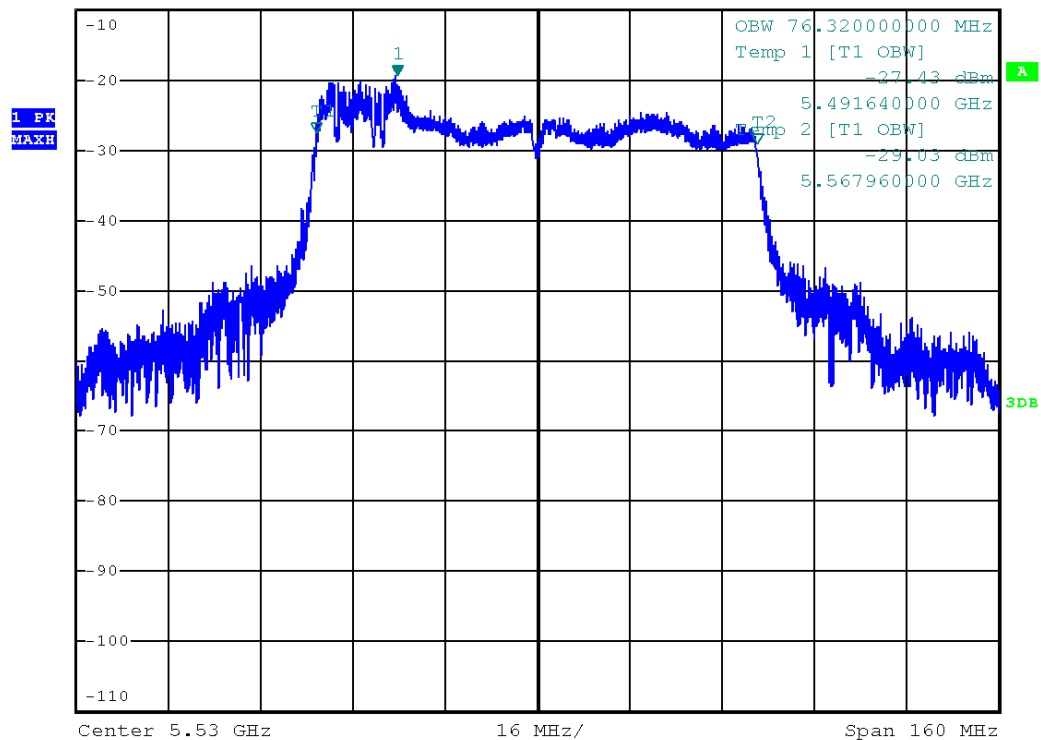

U-NII 99% Channel bandwidth



A D T

802.11ac (VHT80)

Detection Bandwidth Test											
EUT Frequency: 5.530GHz											
EUT 99% Power bandwidth: 76.32MHz											
Detection bandwidth limit (100% of EUT 99% Power bandwidth): 76.32MHz											
Detection Bandwidth (FH - FL): 77MHz											
Test Result : PASS											
Radar Frequency (Hz)	Trial Number / Detection										Detection Rate (%)
	1	2	3	4	5	6	7	8	9	10	
5.490G	No	No	No	No	No	No	No	No	No	No	0
5.491G	No	No	No	No	No	No	No	No	No	No	0
5.492G (FL)	Yes	Yes	No	Yes	Yes	Yes	Yes	Yes	Yes	Yes	90
5.493G	Yes	Yes	Yes	Yes	Yes	Yes	Yes	Yes	Yes	Yes	100
5.494G	Yes	Yes	Yes	Yes	Yes	Yes	Yes	Yes	Yes	Yes	100
5.495G	Yes	Yes	Yes	Yes	Yes	Yes	Yes	Yes	Yes	Yes	100
5.496G	Yes	Yes	Yes	Yes	Yes	Yes	Yes	Yes	Yes	Yes	100
5.497G	Yes	Yes	Yes	Yes	Yes	Yes	Yes	Yes	Yes	Yes	100
5.498G	Yes	Yes	Yes	Yes	Yes	Yes	Yes	Yes	Yes	Yes	100
5.499G	Yes	Yes	Yes	Yes	Yes	Yes	Yes	Yes	Yes	Yes	100
5.500G	Yes	Yes	Yes	Yes	Yes	Yes	Yes	Yes	Yes	Yes	100
5.501G	Yes	Yes	Yes	Yes	Yes	Yes	Yes	Yes	Yes	Yes	100
5.502G	Yes	Yes	Yes	Yes	Yes	Yes	Yes	Yes	Yes	Yes	100
5.503G	Yes	Yes	Yes	Yes	Yes	Yes	Yes	Yes	Yes	Yes	100
5.504G	Yes	Yes	Yes	Yes	Yes	Yes	Yes	Yes	Yes	Yes	100
5.505G	Yes	Yes	Yes	Yes	Yes	Yes	Yes	Yes	Yes	Yes	100
5.506G	Yes	Yes	Yes	Yes	Yes	Yes	Yes	Yes	Yes	Yes	100
5.507G	Yes	Yes	Yes	Yes	Yes	Yes	Yes	Yes	Yes	Yes	100
5.508G	Yes	Yes	Yes	Yes	Yes	Yes	Yes	Yes	Yes	Yes	100
5.509G	Yes	Yes	Yes	Yes	Yes	Yes	Yes	Yes	Yes	Yes	100
5.510G	Yes	Yes	Yes	Yes	Yes	Yes	Yes	Yes	Yes	Yes	100
5.511G	Yes	Yes	Yes	Yes	Yes	Yes	Yes	Yes	Yes	Yes	100
5.512G	Yes	Yes	Yes	Yes	Yes	Yes	Yes	Yes	Yes	Yes	100
5.513G	Yes	Yes	Yes	Yes	Yes	Yes	Yes	Yes	Yes	Yes	100
5.514G	Yes	Yes	Yes	Yes	Yes	Yes	Yes	Yes	Yes	Yes	100
5.515G	Yes	Yes	Yes	Yes	Yes	Yes	Yes	Yes	Yes	Yes	100
5.516G	Yes	Yes	Yes	Yes	Yes	Yes	Yes	Yes	Yes	Yes	100
5.517G	Yes	Yes	Yes	Yes	Yes	Yes	Yes	Yes	Yes	Yes	100
5.518G	Yes	Yes	Yes	Yes	Yes	Yes	Yes	Yes	Yes	Yes	100
5.519G	Yes	Yes	Yes	Yes	Yes	Yes	Yes	Yes	Yes	Yes	100
5.520G	Yes	Yes	Yes	Yes	Yes	Yes	Yes	Yes	Yes	Yes	100
5.521G	Yes	Yes	Yes	Yes	Yes	Yes	Yes	Yes	Yes	Yes	100
5.522G	Yes	Yes	Yes	Yes	Yes	Yes	Yes	Yes	Yes	Yes	100
5.523G	Yes	Yes	Yes	Yes	Yes	Yes	Yes	Yes	Yes	Yes	100
5.524G	Yes	Yes	Yes	Yes	Yes	Yes	Yes	Yes	Yes	Yes	100
5.525G	Yes	Yes	Yes	Yes	Yes	Yes	Yes	Yes	Yes	Yes	100
5.526G	Yes	Yes	Yes	Yes	Yes	Yes	Yes	Yes	Yes	Yes	100
5.527G	Yes	Yes	Yes	Yes	Yes	Yes	Yes	Yes	Yes	Yes	100
5.528G	Yes	Yes	Yes	Yes	Yes	Yes	Yes	Yes	Yes	Yes	100
5.529G	Yes	Yes	Yes	Yes	Yes	Yes	Yes	Yes	Yes	Yes	100
5.530G	Yes	Yes	Yes	Yes	Yes	Yes	Yes	Yes	Yes	Yes	100
5.531G	Yes	Yes	Yes	Yes	Yes	Yes	Yes	Yes	Yes	Yes	100



A D T

5.532G	Yes	Yes	Yes	Yes	Yes	Yes	Yes	Yes	Yes	Yes	100
5.533G	Yes	Yes	Yes	Yes	Yes	Yes	Yes	Yes	Yes	Yes	100
5.534G	Yes	Yes	Yes	Yes	Yes	Yes	Yes	Yes	Yes	Yes	100
5.535G	Yes	Yes	Yes	Yes	Yes	Yes	Yes	Yes	Yes	Yes	100
5.536G	Yes	Yes	Yes	Yes	Yes	Yes	Yes	Yes	Yes	Yes	100
5.537G	Yes	Yes	Yes	Yes	Yes	Yes	Yes	Yes	Yes	Yes	100
5.538G	Yes	Yes	Yes	Yes	Yes	Yes	Yes	Yes	Yes	Yes	100
5.539G	Yes	Yes	Yes	Yes	Yes	Yes	Yes	Yes	Yes	Yes	100
5.540G	Yes	Yes	Yes	Yes	Yes	Yes	Yes	Yes	Yes	Yes	100
5.541G	Yes	Yes	Yes	Yes	Yes	Yes	Yes	Yes	Yes	Yes	100
5.542G	Yes	Yes	Yes	Yes	Yes	Yes	Yes	Yes	Yes	Yes	100
5.543G	Yes	Yes	Yes	Yes	Yes	Yes	Yes	Yes	Yes	Yes	100
5.544G	Yes	Yes	Yes	Yes	Yes	Yes	Yes	Yes	Yes	Yes	100
5.545G	Yes	Yes	Yes	Yes	Yes	Yes	Yes	Yes	Yes	Yes	100
5.546G	Yes	Yes	Yes	Yes	Yes	Yes	Yes	Yes	Yes	Yes	100
5.547G	Yes	Yes	Yes	Yes	Yes	Yes	Yes	Yes	Yes	Yes	100
5.548G	Yes	Yes	Yes	Yes	Yes	Yes	Yes	Yes	Yes	Yes	100
5.549G	Yes	Yes	Yes	Yes	Yes	Yes	Yes	Yes	Yes	Yes	100
5.550G	Yes	Yes	Yes	Yes	Yes	Yes	Yes	Yes	Yes	Yes	100
5.551G	Yes	Yes	Yes	Yes	Yes	Yes	Yes	Yes	Yes	Yes	100
5.552G	Yes	Yes	Yes	Yes	Yes	Yes	Yes	Yes	Yes	Yes	100
5.553G	Yes	Yes	Yes	Yes	Yes	Yes	Yes	Yes	Yes	Yes	100
5.554G	Yes	Yes	Yes	Yes	Yes	Yes	Yes	Yes	Yes	Yes	100
5.555G	Yes	Yes	Yes	Yes	Yes	Yes	Yes	Yes	Yes	Yes	100
5.556G	Yes	Yes	Yes	Yes	Yes	Yes	Yes	Yes	Yes	Yes	100
5.557G	Yes	Yes	Yes	Yes	Yes	Yes	Yes	Yes	Yes	Yes	100
5.558G	Yes	Yes	Yes	Yes	Yes	Yes	Yes	Yes	Yes	Yes	100
5.559G	Yes	Yes	Yes	Yes	Yes	Yes	Yes	Yes	Yes	Yes	100
5.560G	Yes	Yes	Yes	Yes	Yes	Yes	Yes	Yes	Yes	Yes	100
5.561G	Yes	Yes	Yes	Yes	Yes	Yes	Yes	Yes	Yes	Yes	100
5.562G	Yes	Yes	Yes	Yes	Yes	Yes	Yes	Yes	Yes	Yes	100
5.563G	Yes	Yes	Yes	Yes	Yes	Yes	Yes	Yes	Yes	Yes	100
5.564G	Yes	Yes	Yes	Yes	Yes	Yes	Yes	Yes	Yes	Yes	100
5.565G	Yes	Yes	Yes	Yes	Yes	Yes	Yes	Yes	Yes	Yes	100
5.566G	Yes	Yes	Yes	Yes	Yes	Yes	Yes	Yes	Yes	Yes	100
5.567G	Yes	Yes	Yes	Yes	Yes	Yes	Yes	Yes	Yes	Yes	100
5.568G	Yes	Yes	Yes	Yes	Yes	Yes	Yes	Yes	Yes	Yes	100
5.569G(FH)	Yes	Yes	Yes	Yes	Yes	Yes	Yes	Yes	Yes	Yes	100
5.570G	No	No	No	No	No	No	No	No	No	No	0



A D T

6.2.1.7 NON-CO-CHANNEL TEST

The UUT was investigated after radar was detected the channel and made sure no co-channel operation with radars.



A D T

7. INFORMATION ON THE TESTING LABORATORIES

We, Bureau Veritas Consumer Products Services (H.K.) Ltd., Taoyuan Branch, were founded in 1988 to provide our best service in EMC, Radio, Telecom and Safety consultation. Our laboratories are accredited and approved according to ISO/IEC 17025:

If you have any comments, please feel free to contact us at the following:

Linko EMC/RF Lab:

Tel: 886-2-26052180

Fax: 886-2-26052943

Hsin Chu EMC/RF/Telecom Lab:

Tel: 886-3-6668565

Fax: 886-3-6668323

Hwa Ya EMC/RF/Safety Lab:

Tel: 886-3-3183232

Fax: 886-3-3270892

Email: service.adt@tw.bureauveritas.com

Web Site: www.bureauveritas-adt.com

The address and road map of all our labs can be found in our web site also.



A D T

8. APPENDIX A - MODIFICATIONS RECORDERS FOR ENGINEERING CHANGES TO THE EUT BY THE LAB

Modifications or adding components during the test

No any modifications are made to the EUT by the lab during the test.



9. APPENDIX-B

RADAR TEST SIGNAL

Long Pulse Radar Test Signal						
Test Signal Name: LP_Signal_01						
Bursts in Trial: 8						
Burst	Number of Pulses	Pulse Width (µsec)	Chirp Width (MHz)	Pulse 1-to-2 Spacing (µsec)	Pulse 2-to-3 Spacing (µsec)	Start Location Within Interval (msec)
1	3	68	5	1679	958	692
2	2	77.6	9	1832		20
3	2	50.2	19	1726		1096
4	1	92.6	19			607
5	2	72.6	8	1005		1373
6	2	79.8	7	1916		862
7	3	94.6	5	1497	1875	660
8	1	66.2	19			1122

Long Pulse Radar Test Signal						
Test Signal Name: LP_Signal_02						
Bursts in Trial: 9						
Burst	Number of Pulses	Pulse Width (µsec)	Chirp Width (MHz)	Pulse 1-to-2 Spacing (µsec)	Pulse 2-to-3 Spacing (µsec)	Start Location Within Interval (msec)
1	3	51.4	18	1075	1711	595
2	1	75.9	8			1196
3	2	71.6	9	1396		519
4	2	87.3	7	1475		594
5	2	69.8	6	1840		867
6	2	88.7	14	1175		496
7	2	54.1	10	1248		10
8	2	99.9	9	1609		394
9	1	87.2	13			1109

Long Pulse Radar Test Signal						
Test Signal Name: LP_Signal_03						
Bursts in Trial: 10						
Burst	Number of Pulses	Pulse Width (µsec)	Chirp Width (MHz)	Pulse 1-to-2 Spacing (µsec)	Pulse 2-to-3 Spacing (µsec)	Start Location Within Interval (msec)
1	1	54.1	14			395
2	1	97.5	8			365
3	2	61.8	7	1892		1097
4	1	100	11			492
5	2	77.9	5	1631		17
6	3	72.6	19	1160	1507	99
7	2	66.3	15	1624		118
8	3	78	17	1018	1247	781
9	2	79.6	19	963		179
10	1	63.7	20			1146



A D T

Long Pulse Radar Test Signal
Test Signal Name: LP_Signal_04

Bursts in Trial: 11

Burst	Number of Pulses	Pulse Width (µsec)	Chirp Width (MHz)	Pulse 1-to-2 Spacing (µsec)	Pulse 2-to-3 Spacing (µsec)	Start Location Within Interval (msec)
1	1	50.4	6			78
2	2	81.5	8	1789		332
3	2	91.4	13	1307		526
4	2	64.9	19	1404		915
5	2	68.8	18	1329		658
6	1	95.4	13			1056
7	2	68.5	15	941		894
8	1	93.1	15			635
9	1	97.5	14			749
10	2	64.3	17	1665		1077
11	3	84.2	5	1548	1338	771

Long Pulse Radar Test Signal
Test Signal Name: LP_Signal_05

Bursts in Trial: 12

Burst	Number of Pulses	Pulse Width (µsec)	Chirp Width (MHz)	Pulse 1-to-2 Spacing (µsec)	Pulse 2-to-3 Spacing (µsec)	Start Location Within Interval (msec)
1	2	72.4	13	1488		465
2	3	54.5	12	1682	1341	300
3	2	64.4	7	1111		269
4	2	68.5	15	1917		85
5	1	76.4	15			687
6	3	51	12	1789	1245	60
7	1	85.4	8			367
8	3	91.2	6	984	1348	504
9	3	98.1	20	1155	978	602
10	3	61.1	8	1878	1851	654
11	3	90.7	15	948	1642	522
12	2	96.3	14	1056		731

Long Pulse Radar Test Signal
Test Signal Name: LP_Signal_06

Bursts in Trial: 8

Burst	Number of Pulses	Pulse Width (µsec)	Chirp Width (MHz)	Pulse 1-to-2 Spacing (µsec)	Pulse 2-to-3 Spacing (µsec)	Start Location Within Interval (msec)
1	2	98	12	1486		495
2	3	88.3	13	1014	1136	940
3	3	96.9	6	927	1201	198
4	3	64.6	13	969	1070	128
5	3	96	12	1839	1566	1327
6	2	68.7	6	995		949
7	2	62	7	1162		77
8	2	83.2	9	1846		1000

**A D T**

Long Pulse Radar Test Signal
Test Signal Name: LP_Signal_07

Bursts in Trial: 14

Burst	Number of Pulses	Pulse Width (µsec)	Chirp Width (MHz)	Pulse 1-to-2 Spacing (µsec)	Pulse 2-to-3 Spacing (µsec)	Start Location Within Interval (msec)
1	1	52.9	14			681
2	1	93.4	17			340
3	2	62.6	15	1831		628
4	2	67	5	1018		484
5	2	74.9	15	1847		611
6	3	95	9	1021	1894	108
7	3	88.2	6	1818	1149	735
8	2	60.9	6	959		665
9	2	57.6	14	1121		365
10	2	50.8	6	1624		490
11	1	68.2	5			275
12	3	92.3	13	994	964	401
13	1	58.6	11			182
14	2	98.2	10	1642		627

Long Pulse Radar Test Signal
Test Signal Name: LP_Signal_08

Bursts in Trial: 15

Burst	Number of Pulses	Pulse Width (µsec)	Chirp Width (MHz)	Pulse 1-to-2 Spacing (µsec)	Pulse 2-to-3 Spacing (µsec)	Start Location Within Interval (msec)
1	2	88.5	11	1384		538
2	2	74.9	14	1156		693
3	2	78.9	19	987		702
4	3	81.4	13	1887	1130	640
5	1	64.7	13			446
6	2	52.6	20	1269		701
7	2	87.1	14	1146		120
8	1	51	9			695
9	3	73.8	18	998	1423	652
10	2	90.8	8	1486		30
11	1	73.7	6			313
12	3	96.4	12	1132	1556	384
13	2	50.1	6	1012		326
14	2	94.5	12	1348		618
15	1	72.8	7			752



A D T

Long Pulse Radar Test Signal
Test Signal Name: LP_Signal_09

Bursts in Trial: 16

Burst	Number of Pulses	Pulse Width (µsec)	Chirp Width (MHz)	Pulse 1-to-2 Spacing (µsec)	Pulse 2-to-3 Spacing (µsec)	Start Location Within Interval (msec)
1	3	89.9	8	1223	1312	112
2	3	92.1	6	1852	1536	211
3	1	97	20			548
4	2	53.6	19	1440		556
5	2	78.1	20	1740		115
6	2	68.8	8	1704		737
7	2	55	8	1135		269
8	1	80.3	14			399
9	2	64.6	10	1344		54
10	2	93.7	19	1106		615
11	2	85.2	5	989		553
12	2	50.4	20	1619		723
13	3	66.1	8	1212	974	692
14	1	67.6	17			253
15	1	57	12			733
16	1	82.8	15			487

Long Pulse Radar Test Signal
Test Signal Name: LP_Signal_10

Bursts in Trial: 17

Burst	Number of Pulses	Pulse Width (µsec)	Chirp Width (MHz)	Pulse 1-to-2 Spacing (µsec)	Pulse 2-to-3 Spacing (µsec)	Start Location Within Interval (msec)
1	2	95	5	1373		448
2	2	74.3	12	1242		644
3	2	57	19	1693		623
4	1	63	15			16
5	3	78.2	9	996	1807	64
6	1	65.4	18			318
7	2	63.6	18	1631		57
8	3	77.4	13	1596	1822	674
9	1	83.9	14			517
10	2	96.4	19	1237		197
11	3	57.4	5	1196	1555	139
12	2	94.2	5	1564		99
13	3	50	5	1923	1273	484
14	3	85.7	17	953	1606	356
15	2	70.3	11	1248		516
16	1	83.4	12			468
17	1	73.4	9			298



A D T

Long Pulse Radar Test Signal
Test Signal Name: LP_Signal_11

Bursts in Trial: 18

Burst	Number of Pulses	Pulse Width (µsec)	Chirp Width (MHz)	Pulse 1-to-2 Spacing (µsec)	Pulse 2-to-3 Spacing (µsec)	Start Location Within Interval (msec)
1	3	93.5	14	1182	960	602
2	1	55.6	19			361
3	2	55.5	6	946		425
4	2	69.5	13	1892		72
5	3	74.3	7	1550	1667	601
6	2	72.3	5	1783		133
7	2	61.2	15	1704		546
8	3	91.2	12	1462	1378	304
9	2	96.8	19	1766		56
10	2	89.5	8	1458		442
11	1	71.1	6			399
12	3	67.9	13	1541	1133	306
13	2	62.8	6	994		464
14	2	78	11	1304		163
15	1	54.3	11			305
16	1	52.1	20			199
17	1	74.9	18			397
18	2	91.9	14	1645		458

Long Pulse Radar Test Signal
Test Signal Name: LP_Signal_12

Bursts in Trial: 19

Burst	Number of Pulses	Pulse Width (µsec)	Chirp Width (MHz)	Pulse 1-to-2 Spacing (µsec)	Pulse 2-to-3 Spacing (µsec)	Start Location Within Interval (msec)
1	2	65.6	7	984		319
2	2	63.9	17	1137		462
3	2	52.9	17	1318		483
4	3	58.3	9	1901	1223	532
5	3	60.7	19	1891	1289	290
6	2	86.3	12	930		341
7	2	59	14	1076		401
8	2	95.8	18	1214		243
9	2	91	13	1788		437
10	2	97.5	17	1226		251
11	3	62	12	1066	1261	46
12	2	52.5	9	1424		286
13	3	87.5	8	1789	1822	463
14	2	63.5	15	1852		38
15	2	59.9	13	1618		444
16	1	91.4	13			423
17	1	62.3	10			266
18	2	77.7	10	1489		545
19	2	70.8	10	930		343



A D T

Long Pulse Radar Test Signal
Test Signal Name: LP_Signal_13

Bursts in Trial: 20

Burst	Number of Pulses	Pulse Width (µsec)	Chirp Width (MHz)	Pulse 1-to-2 Spacing (µsec)	Pulse 2-to-3 Spacing (µsec)	Start Location Within Interval (msec)
1	2	85.7	6	1066		429
2	3	69.6	13	1514	1504	391
3	3	80.9	9	1866	1839	62
4	1	73.8	14			161
5	1	62.3	12			359
6	1	74.6	18			221
7	2	58.3	7	1109		513
8	1	67.8	12			509
9	2	94.2	12	1753		343
10	2	83.6	9	1588		407
11	1	87.9	19			108
12	1	99.3	7			517
13	3	91.4	7	912	1742	418
14	1	79.1	8			309
15	3	84.1	18	1572	1521	378
16	2	87.4	7	1474		188
17	1	51.6	20			480
18	2	66.1	10	1639		135
19	3	63.4	9	1372	1349	26
20	3	92	10	1885	1853	384

Long Pulse Radar Test Signal
Test Signal Name: LP_Signal_14

Bursts in Trial: 8

Burst	Number of Pulses	Pulse Width (µsec)	Chirp Width (MHz)	Pulse 1-to-2 Spacing (µsec)	Pulse 2-to-3 Spacing (µsec)	Start Location Within Interval (msec)
1	2	72	20	1054		1059
2	2	64	8	1909		117
3	2	93	14	1276		1131
4	2	72.4	19	1673		458
5	3	95.2	12	1802	1413	796
6	3	74.2	14	1829	1192	984
7	3	79.8	6	1009	1424	778
8	2	63.9	8	963		483



A D T

Long Pulse Radar Test Signal
Test Signal Name: LP_Signal_15

Bursts in Trial: 9

Burst	Number of Pulses	Pulse Width (µsec)	Chirp Width (MHz)	Pulse 1-to-2 Spacing (µsec)	Pulse 2-to-3 Spacing (µsec)	Start Location Within Interval (msec)
1	2	72.9	11	1448		196
2	2	92.7	9	1327		512
3	2	87.4	7	1454		766
4	3	76.6	9	1384	1359	1278
5	2	53.1	15	1053		96
6	3	53.5	8	1693	1727	1181
7	2	70.7	18	1762		880
8	2	92.5	10	1592		317
9	2	84.5	12	1861		1076

Long Pulse Radar Test Signal
Test Signal Name: LP_Signal_16

Bursts in Trial: 10

Burst	Number of Pulses	Pulse Width (µsec)	Chirp Width (MHz)	Pulse 1-to-2 Spacing (µsec)	Pulse 2-to-3 Spacing (µsec)	Start Location Within Interval (msec)
1	2	80.6	19	1471		89
2	3	61.8	10	1310	1789	1176
3	2	64.1	20	1236		795
4	2	77.1	20	1378		797
5	3	91.4	20	1886	1004	408
6	2	63.1	7	1271		960
7	2	59.8	18	1667		791
8	3	90.8	18	1628	916	997
9	2	82.8	10	1049		826
10	3	80.3	19	1383	1422	74

Long Pulse Radar Test Signal
Test Signal Name: LP_Signal_17

Bursts in Trial: 11

Burst	Number of Pulses	Pulse Width (µsec)	Chirp Width (MHz)	Pulse 1-to-2 Spacing (µsec)	Pulse 2-to-3 Spacing (µsec)	Start Location Within Interval (msec)
1	1	77.5	6			80
2	2	92.8	18	1840		145
3	2	63.1	7	1832		521
4	2	75.4	13	1251		146
5	3	86.8	19	1007	1315	354
6	1	83.4	7			277
7	2	86.4	17	1394		778
8	1	65.4	12			501
9	1	51.5	18			509
10	1	90.9	6			356
11	2	90.5	18	1388		584



A D T

Long Pulse Radar Test Signal

Test Signal Name: LP_Signal_18

Bursts in Trial: 12

Burst	Number of Pulses	Pulse Width (µsec)	Chirp Width (MHz)	Pulse 1-to-2 Spacing (µsec)	Pulse 2-to-3 Spacing (µsec)	Start Location Within Interval (msec)
1	1	73.3	20			417
2	2	99.5	15	1797		439
3	2	76.5	7	1642		496
4	2	78.9	10	1520		370
5	3	54.4	17	984	1009	211
6	2	90.5	12	1137		948
7	3	94.3	9	1018	1312	410
8	1	97.7	10			225
9	2	74.7	18	1275		461
10	1	65.9	11			638
11	2	74.3	13	1769		381
12	2	83.4	9	1775		119

Long Pulse Radar Test Signal

Test Signal Name: LP_Signal_19

Bursts in Trial: 14

Burst	Number of Pulses	Pulse Width (µsec)	Chirp Width (MHz)	Pulse 1-to-2 Spacing (µsec)	Pulse 2-to-3 Spacing (µsec)	Start Location Within Interval (msec)
1	1	95.7	12			398
2	3	53	6	1541	1891	408
3	3	92.4	8	996	1454	428
4	1	58.4	17			322
5	2	97.9	5	1514		225
6	3	72	9	1813	1018	501
7	1	77.1	20			216
8	2	65.6	15	1328		275
9	3	84.9	8	1788	1254	407
10	1	79	20			78
11	3	89.1	13	989	1365	638
12	3	51.4	10	1716	1055	522
13	2	75	6	1768		627
14	2	88.6	11	1041		473



A D T

Long Pulse Radar Test Signal						
Test Signal Name: LP_Signal_20						
Bursts in Trial: 15						
Burst	Number of Pulses	Pulse Width (µsec)	Chirp Width (MHz)	Pulse 1-to-2 Spacing (µsec)	Pulse 2-to-3 Spacing (µsec)	Start Location Within Interval (msec)
1	3	96.2	6	1240	1650	544
2	1	89	19			278
3	1	91.2	17			418
4	3	86.2	8	1374	1021	706
5	2	88.6	20	1668		570
6	3	57.6	8	1370	978	424
7	2	51	18	1208		102
8	3	86.9	6	1392	1661	9
9	3	62.2	15	1023	1727	770
10	3	82.5	5	965	1332	596
11	2	94.1	18	1243		282
12	2	55.7	5	1167		775
13	3	81.3	7	1313	1439	586
14	1	64.3	13			333
15	2	88.9	18	956		647

Long Pulse Radar Test Signal						
Test Signal Name: LP_Signal_21						
Bursts in Trial: 16						
Burst	Number of Pulses	Pulse Width (µsec)	Chirp Width (MHz)	Pulse 1-to-2 Spacing (µsec)	Pulse 2-to-3 Spacing (µsec)	Start Location Within Interval (msec)
1	2	64.5	11	1472		80
2	1	69.7	11			207
3	2	85	8	1358		544
4	2	88.6	5	1674		501
5	2	88.7	14	1459		76
6	3	90.1	17	1896	1753	189
7	2	74.2	14	1108		546
8	1	95.1	19			437
9	2	52.5	13	999		360
10	2	53.8	18	1873		621
11	2	53.6	15	1105		531
12	3	52	6	1587	1562	175
13	3	83	8	1030	1018	689
14	1	77	13			217
15	2	69.9	14	1904		282
16	2	76.9	13	1684		608



A D T

Long Pulse Radar Test Signal
Test Signal Name: LP_Signal_22

Bursts in Trial: 17

Burst	Number of Pulses	Pulse Width (µsec)	Chirp Width (MHz)	Pulse 1-to-2 Spacing (µsec)	Pulse 2-to-3 Spacing (µsec)	Start Location Within Interval (msec)
1	1	71.7	18			222
2	2	57	18	1373		330
3	2	67.6	15	1193		183
4	3	81	14	1041	1183	185
5	2	58.1	20	1913		182
6	1	98.8	6			113
7	1	60	14			195
8	3	98.6	15	978	1411	102
9	1	67.9	10			67
10	1	85.4	20			490
11	2	67.6	10	1683		75
12	1	55.6	12			35
13	3	63	5	1663	938	539
14	2	73.9	8	1567		542
15	2	86.8	20	1040		307
16	2	96.7	18	994		294
17	3	89	9	1790	1144	554

Long Pulse Radar Test Signal
Test Signal Name: LP_Signal_23

Bursts in Trial: 18

Burst	Number of Pulses	Pulse Width (µsec)	Chirp Width (MHz)	Pulse 1-to-2 Spacing (µsec)	Pulse 2-to-3 Spacing (µsec)	Start Location Within Interval (msec)
1	2	73.9	20	1691		532
2	2	58.3	18	1689		419
3	3	68.9	7	1540	943	304
4	2	51.5	13	1647		368
5	3	68.6	13	1699	960	593
6	2	81.1	15	1805		264
7	3	87.6	17	1099	1473	466
8	2	81	17	1385		213
9	3	53.5	13	1069	1670	458
10	2	67.8	11	1790		392
11	2	59.3	11	1935		206
12	2	67.9	19	1780		163
13	1	52.8	15			570
14	1	78.9	6			314
15	3	92.9	6	1079	952	23
16	2	54.2	7	1494		457
17	2	86.9	9	933		87
18	3	72.4	7	1607	1625	506



A D T

Long Pulse Radar Test Signal
Test Signal Name: LP_Signal_24

Bursts in Trial: 19

Burst	Number of Pulses	Pulse Width (µsec)	Chirp Width (MHz)	Pulse 1-to-2 Spacing (µsec)	Pulse 2-to-3 Spacing (µsec)	Start Location Within Interval (msec)
1	3	70.1	5	1231	1505	5
2	2	95.3	6	1510		581
3	2	76.3	13	1488		415
4	3	97.8	9	996	1065	616
5	1	75.7	13			565
6	1	89.7	12			476
7	3	75.7	5	1197	1051	36
8	2	72.8	10	1719		158
9	2	94.1	13	1116		301
10	2	69.2	10	1579		110
11	2	86	13	1558		570
12	1	63.5	13			469
13	3	57.2	19	1439	1771	304
14	3	95.2	5	980	1333	294
15	1	95.6	10			114
16	2	70.8	7	1509		208
17	1	59.7	17			194
18	3	56	19	1362	993	506
19	2	70.7	13	1877		212

Long Pulse Radar Test Signal
Test Signal Name: LP_Signal_25

Bursts in Trial: 20

Burst	Number of Pulses	Pulse Width (µsec)	Chirp Width (MHz)	Pulse 1-to-2 Spacing (µsec)	Pulse 2-to-3 Spacing (µsec)	Start Location Within Interval (msec)
1	3	65.8	19	1785	1491	37
2	1	52.9	14			275
3	2	81.6	19	1439		219
4	1	52.9	20			324
5	1	95.3	15			342
6	3	98.3	9	963	1372	548
7	2	67.8	20	1080		452
8	1	88.3	8			35
9	2	94.3	15	1767		76
10	2	88.9	14	974		376
11	2	89.2	10	1393		38
12	2	91.5	13	1117		501
13	1	58.5	9			227
14	1	89.7	19			36
15	3	99.9	13	1613	1463	535
16	1	72.1	8			167
17	2	75.5	5	1341		522
18	1	57.3	12			63
19	3	93.9	13	1888	1183	21
20	2	97.9	18	1752		359



A D T

Long Pulse Radar Test Signal
Test Signal Name: LP_Signal_26

Bursts in Trial: 8						
Burst	Number of Pulses	Pulse Width (µsec)	Chirp Width (MHz)	Pulse 1-to-2 Spacing (µsec)	Pulse 2-to-3 Spacing (µsec)	Start Location Within Interval (msec)
1	1	52.8	20			3
2	1	68.1	7			1296
3	2	65.1	6	1207		1272
4	2	56.7	8	1034		83
5	2	98.2	7	1405		618
6	1	54.1	19			929
7	2	83.4	14	1822		564
8	2	58.3	12	1269		897

Long Pulse Radar Test Signal
Test Signal Name: LP_Signal_27

Bursts in Trial: 9						
Burst	Number of Pulses	Pulse Width (µsec)	Chirp Width (MHz)	Pulse 1-to-2 Spacing (µsec)	Pulse 2-to-3 Spacing (µsec)	Start Location Within Interval (msec)
1	3	95.6	5	1081	1377	39
2	2	69.3	19	1334		791
3	1	92.3	14			488
4	1	54.1	19			315
5	3	90.9	8	920	1382	416
6	2	73.9	13	1406		1088
7	1	83.7	19			785
8	2	75.2	7	1050		1006
9	2	77.3	14	1066		183

Long Pulse Radar Test Signal
Test Signal Name: LP_Signal_28

Bursts in Trial: 10						
Burst	Number of Pulses	Pulse Width (µsec)	Chirp Width (MHz)	Pulse 1-to-2 Spacing (µsec)	Pulse 2-to-3 Spacing (µsec)	Start Location Within Interval (msec)
1	2	76.2	15	1260		428
2	2	81.3	11	926		542
3	1	70.2	20			543
4	2	87.3	11	1881		1076
5	1	56.5	8			748
6	2	94.8	11	1029		687
7	1	62.1	13			302
8	1	76.2	20			1122
9	2	95.3	9	1157		1083
10	1	59	13			827



A D T

Long Pulse Radar Test Signal
Test Signal Name: LP_Signal_29

Bursts in Trial: 11

Burst	Number of Pulses	Pulse Width (µsec)	Chirp Width (MHz)	Pulse 1-to-2 Spacing (µsec)	Pulse 2-to-3 Spacing (µsec)	Start Location Within Interval (msec)
1	1	61.5	7			462
2	2	62.2	20	1061		1002
3	2	64	11	1554		604
4	2	87.2	12	1168		714
5	2	51.7	11	1059		1081
6	2	75.9	8	1165		831
7	2	52.8	10	1792		772
8	1	67	9			604
9	2	50.1	6	1462		115
10	2	68.8	20	1053		176
11	2	96.7	20	1139		959

Long Pulse Radar Test Signal
Test Signal Name: LP_Signal_30

Bursts in Trial: 12

Burst	Number of Pulses	Pulse Width (µsec)	Chirp Width (MHz)	Pulse 1-to-2 Spacing (µsec)	Pulse 2-to-3 Spacing (µsec)	Start Location Within Interval (msec)
1	1	69.2	7			175
2	2	70.8	10	1821		539
3	2	50	13	1298		140
4	2	61.1	13	1197		496
5	1	55.4	17			544
6	2	81.8	12	918		663
7	2	63.4	15	1138		123
8	2	57.6	13	1686		389
9	2	91.4	17	1711		885
10	3	76.7	6	1716	1557	487
11	3	90.2	8	1606	1188	5
12	1	75.1	13			634



A D T

B.2 The Frequency Hopping Radar pattern

Hopping Frequency Sequence Name: HOP_FREQ_SEQ_01							
SEQ#	Frequency (Hz)	SEQ#	Frequency (Hz)	SEQ#	Frequency (Hz)	SEQ#	Frequency (Hz)
1	5.536G	2	5.602G	3	5.399G	4	5.685G
5	5.671G	6	5.381G	7	5.406G	8	5.549G
9	5.599G	10	5.607G	11	5.694G	12	5.577G
13	5.254G	14	5.687G	15	5.372G	16	5.533G
17	5.431G	18	5.508G	19	5.718G	20	5.604G
21	5.435G	22	5.433G	23	5.392G	24	5.382G
25	5.384G	26	5.375G	27	5.501G	28	5.697G
29	5.344G	30	5.472G	31	5.337G	32	5.460G
33	5.348G	34	5.676G	35	5.647G	36	5.374G
37	5.307G	38	5.699G	39	5.520G	40	5.447G
41	5.521G	42	5.628G	43	5.310G	44	5.437G
45	5.271G	46	5.722G	47	5.534G	48	5.724G
49	5.606G	50	5.458G	51	5.415G	52	5.666G
53	5.571G	54	5.414G	55	5.649G	56	5.643G
57	5.609G	58	5.630G	59	5.617G	60	5.570G
61	5.293G	62	5.530G	63	5.370G	64	5.481G
65	5.326G	66	5.667G	67	5.479G	68	5.484G
69	5.506G	70	5.464G	71	5.360G	72	5.715G
73	5.646G	74	5.668G	75	5.708G	76	5.555G
77	5.566G	78	5.635G	79	5.594G	80	5.454G
81	5.422G	82	5.315G	83	5.338G	84	5.639G
85	5.638G	86	5.474G	87	5.446G	88	5.704G
89	5.658G	90	5.659G	91	5.711G	92	5.425G
93	5.551G	94	5.509G	95	5.717G	96	5.365G
97	5.448G	98	5.515G	99	5.644G	100	5.559G



A D T

Hopping Frequency Sequence Name: HOP_FREQ_SEQ_02							
SEQ#	Frequency (Hz)	SEQ#	Frequency (Hz)	SEQ#	Frequency (Hz)	SEQ#	Frequency (Hz)
1	5.568G	2	5.314G	3	5.563G	4	5.471G
5	5.584G	6	5.719G	7	5.372G	8	5.689G
9	5.662G	10	5.691G	11	5.369G	12	5.482G
13	5.425G	14	5.331G	15	5.698G	16	5.445G
17	5.499G	18	5.713G	19	5.396G	20	5.574G
21	5.416G	22	5.557G	23	5.652G	24	5.659G
25	5.692G	26	5.556G	27	5.581G	28	5.586G
29	5.421G	30	5.611G	31	5.324G	32	5.509G
33	5.597G	34	5.672G	35	5.311G	36	5.638G
37	5.477G	38	5.670G	39	5.485G	40	5.456G
41	5.468G	42	5.419G	43	5.722G	44	5.620G
45	5.305G	46	5.524G	47	5.716G	48	5.368G
49	5.618G	50	5.708G	51	5.341G	52	5.608G
53	5.617G	54	5.533G	55	5.645G	56	5.686G
57	5.520G	58	5.564G	59	5.426G	60	5.342G
61	5.696G	62	5.440G	63	5.703G	64	5.447G
65	5.577G	66	5.656G	67	5.605G	68	5.442G
69	5.387G	70	5.514G	71	5.335G	72	5.344G
73	5.377G	74	5.417G	75	5.680G	76	5.353G
77	5.683G	78	5.493G	79	5.385G	80	5.613G
81	5.479G	82	5.411G	83	5.512G	84	5.644G
85	5.299G	86	5.497G	87	5.439G	88	5.528G
89	5.588G	90	5.361G	91	5.681G	92	5.536G
93	5.362G	94	5.518G	95	5.642G	96	5.480G
97	5.334G	98	5.423G	99	5.438G	100	5.504G



A D T

Hopping Frequency Sequence Name: HOP_FREQ_SEQ_03							
SEQ#	Frequency (Hz)	SEQ#	Frequency (Hz)	SEQ#	Frequency (Hz)	SEQ#	Frequency (Hz)
1	5.543G	2	5.664G	3	5.630G	4	5.500G
5	5.670G	6	5.525G	7	5.635G	8	5.599G
9	5.563G	10	5.451G	11	5.387G	12	5.425G
13	5.685G	14	5.350G	15	5.482G	16	5.551G
17	5.393G	18	5.682G	19	5.714G	20	5.424G
21	5.293G	22	5.428G	23	5.379G	24	5.496G
25	5.665G	26	5.508G	27	5.380G	28	5.382G
29	5.430G	30	5.462G	31	5.584G	32	5.547G
33	5.408G	34	5.645G	35	5.633G	36	5.383G
37	5.503G	38	5.570G	39	5.498G	40	5.706G
41	5.593G	42	5.394G	43	5.412G	44	5.406G
45	5.296G	46	5.707G	47	5.446G	48	5.385G
49	5.703G	50	5.492G	51	5.717G	52	5.429G
53	5.640G	54	5.308G	55	5.439G	56	5.560G
57	5.448G	58	5.481G	59	5.432G	60	5.647G
61	5.323G	62	5.632G	63	5.582G	64	5.427G
65	5.390G	66	5.569G	67	5.328G	68	5.530G
69	5.561G	70	5.368G	71	5.463G	72	5.578G
73	5.668G	74	5.326G	75	5.376G	76	5.548G
77	5.366G	78	5.680G	79	5.501G	80	5.540G
81	5.322G	82	5.674G	83	5.686G	84	5.473G
85	5.588G	86	5.610G	87	5.417G	88	5.591G
89	5.456G	90	5.616G	91	5.497G	92	5.470G
93	5.723G	94	5.618G	95	5.373G	96	5.607G
97	5.477G	98	5.418G	99	5.712G	100	5.545G



A D T

Hopping Frequency Sequence Name: HOP_FREQ_SEQ_04							
SEQ#	Frequency (Hz)	SEQ#	Frequency (Hz)	SEQ#	Frequency (Hz)	SEQ#	Frequency (Hz)
1	5.459G	2	5.429G	3	5.549G	4	5.450G
5	5.431G	6	5.657G	7	5.482G	8	5.332G
9	5.255G	10	5.311G	11	5.574G	12	5.625G
13	5.524G	14	5.309G	15	5.583G	16	5.408G
17	5.444G	18	5.723G	19	5.492G	20	5.584G
21	5.336G	22	5.697G	23	5.327G	24	5.722G
25	5.712G	26	5.617G	27	5.344G	28	5.394G
29	5.663G	30	5.587G	31	5.711G	32	5.475G
33	5.669G	34	5.427G	35	5.527G	36	5.369G
37	5.380G	38	5.687G	39	5.695G	40	5.356G
41	5.487G	42	5.528G	43	5.624G	44	5.357G
45	5.432G	46	5.396G	47	5.613G	48	5.578G
49	5.404G	50	5.315G	51	5.346G	52	5.596G
53	5.498G	54	5.651G	55	5.690G	56	5.595G
57	5.582G	58	5.345G	59	5.420G	60	5.674G
61	5.522G	62	5.592G	63	5.714G	64	5.604G
65	5.516G	66	5.589G	67	5.337G	68	5.517G
69	5.696G	70	5.440G	71	5.702G	72	5.481G
73	5.377G	74	5.322G	75	5.678G	76	5.558G
77	5.303G	78	5.470G	79	5.619G	80	5.615G
81	5.629G	82	5.411G	83	5.581G	84	5.443G
85	5.593G	86	5.313G	87	5.565G	88	5.548G
89	5.368G	90	5.340G	91	5.618G	92	5.512G
93	5.647G	94	5.699G	95	5.682G	96	5.608G
97	5.644G	98	5.541G	99	5.416G	100	5.476G



A D T

Hopping Frequency Sequence Name: HOP_FREQ_SEQ_05							
SEQ#	Frequency (Hz)	SEQ#	Frequency (Hz)	SEQ#	Frequency (Hz)	SEQ#	Frequency (Hz)
1	5.657G	2	5.355G	3	5.698G	4	5.618G
5	5.483G	6	5.349G	7	5.539G	8	5.525G
9	5.334G	10	5.434G	11	5.476G	12	5.634G
13	5.565G	14	5.677G	15	5.477G	16	5.421G
17	5.439G	18	5.459G	19	5.405G	20	5.337G
21	5.359G	22	5.702G	23	5.569G	24	5.330G
25	5.711G	26	5.341G	27	5.362G	28	5.700G
29	5.661G	30	5.495G	31	5.360G	32	5.499G
33	5.266G	34	5.379G	35	5.675G	36	5.400G
37	5.656G	38	5.567G	39	5.347G	40	5.550G
41	5.610G	42	5.605G	43	5.631G	44	5.412G
45	5.723G	46	5.587G	47	5.670G	48	5.343G
49	5.396G	50	5.543G	51	5.444G	52	5.585G
53	5.644G	54	5.417G	55	5.708G	56	5.505G
57	5.683G	58	5.703G	59	5.608G	60	5.676G
61	5.384G	62	5.399G	63	5.427G	64	5.684G
65	5.435G	66	5.514G	67	5.721G	68	5.403G
69	5.535G	70	5.511G	71	5.579G	72	5.590G
73	5.418G	74	5.558G	75	5.576G	76	5.471G
77	5.487G	78	5.528G	79	5.572G	80	5.707G
81	5.338G	82	5.372G	83	5.549G	84	5.611G
85	5.308G	86	5.685G	87	5.602G	88	5.510G
89	5.346G	90	5.531G	91	5.614G	92	5.351G
93	5.424G	94	5.452G	95	5.339G	96	5.612G
97	5.382G	98	5.348G	99	5.554G	100	5.473G



A D T

Hopping Frequency Sequence Name: HOP_FREQ_SEQ_06							
SEQ#	Frequency (Hz)	SEQ#	Frequency (Hz)	SEQ#	Frequency (Hz)	SEQ#	Frequency (Hz)
1	5.430G	2	5.333G	3	5.446G	4	5.634G
5	5.532G	6	5.286G	7	5.691G	8	5.615G
9	5.545G	10	5.404G	11	5.537G	12	5.355G
13	5.317G	14	5.573G	15	5.495G	16	5.575G
17	5.273G	18	5.465G	19	5.308G	20	5.508G
21	5.668G	22	5.590G	23	5.576G	24	5.340G
25	5.499G	26	5.397G	27	5.657G	28	5.660G
29	5.437G	30	5.705G	31	5.478G	32	5.369G
33	5.473G	34	5.455G	35	5.667G	36	5.527G
37	5.580G	38	5.365G	39	5.506G	40	5.337G
41	5.712G	42	5.339G	43	5.616G	44	5.658G
45	5.502G	46	5.553G	47	5.600G	48	5.613G
49	5.589G	50	5.480G	51	5.563G	52	5.692G
53	5.595G	54	5.466G	55	5.494G	56	5.709G
57	5.593G	58	5.638G	59	5.642G	60	5.524G
61	5.699G	62	5.361G	63	5.542G	64	5.669G
65	5.279G	66	5.382G	67	5.511G	68	5.598G
69	5.436G	70	5.534G	71	5.345G	72	5.581G
73	5.416G	74	5.353G	75	5.409G	76	5.460G
77	5.654G	78	5.403G	79	5.554G	80	5.548G
81	5.584G	82	5.375G	83	5.371G	84	5.461G
85	5.358G	86	5.517G	87	5.636G	88	5.644G
89	5.362G	90	5.501G	91	5.587G	92	5.497G
93	5.328G	94	5.643G	95	5.518G	96	5.388G
97	5.451G	98	5.650G	99	5.469G	100	5.424G



A D T

Hopping Frequency Sequence Name: HOP_FREQ_SEQ_07							
SEQ#	Frequency (Hz)	SEQ#	Frequency (Hz)	SEQ#	Frequency (Hz)	SEQ#	Frequency (Hz)
1	5.603G	2	5.344G	3	5.451G	4	5.558G
5	5.421G	6	5.723G	7	5.409G	8	5.602G
9	5.545G	10	5.384G	11	5.528G	12	5.561G
13	5.333G	14	5.567G	15	5.377G	16	5.470G
17	5.597G	18	5.695G	19	5.579G	20	5.443G
21	5.473G	22	5.694G	23	5.554G	24	5.565G
25	5.539G	26	5.600G	27	5.531G	28	5.480G
29	5.289G	30	5.542G	31	5.434G	32	5.581G
33	5.329G	34	5.334G	35	5.677G	36	5.708G
37	5.319G	38	5.658G	39	5.680G	40	5.551G
41	5.299G	42	5.483G	43	5.718G	44	5.709G
45	5.370G	46	5.552G	47	5.610G	48	5.385G
49	5.478G	50	5.368G	51	5.420G	52	5.624G
53	5.514G	54	5.573G	55	5.331G	56	5.615G
57	5.376G	58	5.488G	59	5.699G	60	5.543G
61	5.416G	62	5.359G	63	5.585G	64	5.438G
65	5.428G	66	5.595G	67	5.399G	68	5.635G
69	5.516G	70	5.454G	71	5.317G	72	5.462G
73	5.515G	74	5.487G	75	5.697G	76	5.688G
77	5.413G	78	5.330G	79	5.583G	80	5.371G
81	5.523G	82	5.555G	83	5.604G	84	5.522G
85	5.327G	86	5.363G	87	5.479G	88	5.532G
89	5.659G	90	5.656G	91	5.572G	92	5.536G
93	5.593G	94	5.627G	95	5.720G	96	5.405G
97	5.313G	98	5.513G	99	5.576G	100	5.401G



A D T

Hopping Frequency Sequence Name: HOP_FREQ_SEQ_08							
SEQ#	Frequency (Hz)	SEQ#	Frequency (Hz)	SEQ#	Frequency (Hz)	SEQ#	Frequency (Hz)
1	5.652G	2	5.476G	3	5.602G	4	5.501G
5	5.348G	6	5.280G	7	5.538G	8	5.582G
9	5.317G	10	5.397G	11	5.674G	12	5.331G
13	5.278G	14	5.486G	15	5.407G	16	5.513G
17	5.613G	18	5.377G	19	5.570G	20	5.442G
21	5.341G	22	5.670G	23	5.450G	24	5.675G
25	5.301G	26	5.712G	27	5.610G	28	5.462G
29	5.593G	30	5.611G	31	5.418G	32	5.661G
33	5.464G	34	5.639G	35	5.369G	36	5.547G
37	5.609G	38	5.580G	39	5.458G	40	5.520G
41	5.424G	42	5.363G	43	5.535G	44	5.416G
45	5.724G	46	5.595G	47	5.660G	48	5.529G
49	5.719G	50	5.299G	51	5.562G	52	5.687G
53	5.322G	54	5.697G	55	5.474G	56	5.401G
57	5.354G	58	5.640G	59	5.516G	60	5.394G
61	5.378G	62	5.545G	63	5.681G	64	5.659G
65	5.347G	66	5.695G	67	5.380G	68	5.627G
69	5.503G	70	5.491G	71	5.607G	72	5.481G
73	5.273G	74	5.543G	75	5.606G	76	5.398G
77	5.455G	78	5.721G	79	5.375G	80	5.534G
81	5.683G	82	5.308G	83	5.346G	84	5.716G
85	5.588G	86	5.641G	87	5.666G	88	5.679G
89	5.662G	90	5.473G	91	5.430G	92	5.445G
93	5.549G	94	5.715G	95	5.417G	96	5.557G
97	5.564G	98	5.571G	99	5.619G	100	5.710G



A D T

Hopping Frequency Sequence Name: HOP_FREQ_SEQ_09							
SEQ#	Frequency (Hz)	SEQ#	Frequency (Hz)	SEQ#	Frequency (Hz)	SEQ#	Frequency (Hz)
1	5.651G	2	5.662G	3	5.403G	4	5.661G
5	5.693G	6	5.455G	7	5.712G	8	5.513G
9	5.295G	10	5.504G	11	5.689G	12	5.390G
13	5.266G	14	5.680G	15	5.528G	16	5.545G
17	5.591G	18	5.673G	19	5.407G	20	5.392G
21	5.448G	22	5.719G	23	5.361G	24	5.585G
25	5.293G	26	5.508G	27	5.502G	28	5.578G
29	5.702G	30	5.366G	31	5.418G	32	5.495G
33	5.480G	34	5.298G	35	5.464G	36	5.549G
37	5.414G	38	5.290G	39	5.381G	40	5.400G
41	5.315G	42	5.620G	43	5.718G	44	5.444G
45	5.394G	46	5.539G	47	5.710G	48	5.461G
49	5.652G	50	5.419G	51	5.531G	52	5.487G
53	5.681G	54	5.640G	55	5.690G	56	5.634G
57	5.660G	58	5.668G	59	5.582G	60	5.615G
61	5.716G	62	5.543G	63	5.611G	64	5.427G
65	5.307G	66	5.379G	67	5.384G	68	5.496G
69	5.649G	70	5.612G	71	5.462G	72	5.454G
73	5.536G	74	5.411G	75	5.479G	76	5.526G
77	5.382G	78	5.670G	79	5.663G	80	5.424G
81	5.412G	82	5.553G	83	5.641G	84	5.345G
85	5.650G	86	5.338G	87	5.348G	88	5.510G
89	5.421G	90	5.610G	91	5.340G	92	5.552G
93	5.374G	94	5.715G	95	5.468G	96	5.642G
97	5.355G	98	5.364G	99	5.700G	100	5.709G



A D T

Hopping Frequency Sequence Name: HOP_FREQ_SEQ_10							
SEQ#	Frequency (Hz)	SEQ#	Frequency (Hz)	SEQ#	Frequency (Hz)	SEQ#	Frequency (Hz)
1	5.321G	2	5.277G	3	5.537G	4	5.432G
5	5.643G	6	5.644G	7	5.614G	8	5.712G
9	5.613G	10	5.558G	11	5.361G	12	5.453G
13	5.583G	14	5.633G	15	5.625G	16	5.414G
17	5.273G	18	5.503G	19	5.689G	20	5.440G
21	5.258G	22	5.628G	23	5.679G	24	5.494G
25	5.655G	26	5.693G	27	5.632G	28	5.418G
29	5.267G	30	5.561G	31	5.502G	32	5.511G
33	5.543G	34	5.718G	35	5.688G	36	5.399G
37	5.630G	38	5.490G	39	5.546G	40	5.634G
41	5.297G	42	5.413G	43	5.357G	44	5.515G
45	5.485G	46	5.492G	47	5.586G	48	5.465G
49	5.344G	50	5.422G	51	5.400G	52	5.692G
53	5.395G	54	5.454G	55	5.703G	56	5.549G
57	5.461G	58	5.319G	59	5.571G	60	5.533G
61	5.599G	62	5.668G	63	5.388G	64	5.476G
65	5.524G	66	5.597G	67	5.656G	68	5.660G
69	5.447G	70	5.474G	71	5.430G	72	5.477G
73	5.510G	74	5.331G	75	5.701G	76	5.629G
77	5.517G	78	5.487G	79	5.666G	80	5.516G
81	5.405G	82	5.489G	83	5.353G	84	5.618G
85	5.572G	86	5.457G	87	5.673G	88	5.427G
89	5.568G	90	5.636G	91	5.563G	92	5.496G
93	5.505G	94	5.642G	95	5.720G	96	5.649G
97	5.381G	98	5.451G	99	5.449G	100	5.473G



A D T

Hopping Frequency Sequence Name: HOP_FREQ_SEQ_11							
SEQ#	Frequency (Hz)	SEQ#	Frequency (Hz)	SEQ#	Frequency (Hz)	SEQ#	Frequency (Hz)
1	5.497G	2	5.671G	3	5.375G	4	5.496G
5	5.266G	6	5.570G	7	5.638G	8	5.459G
9	5.578G	10	5.319G	11	5.383G	12	5.560G
13	5.612G	14	5.340G	15	5.513G	16	5.561G
17	5.326G	18	5.348G	19	5.697G	20	5.522G
21	5.656G	22	5.714G	23	5.640G	24	5.626G
25	5.704G	26	5.476G	27	5.498G	28	5.589G
29	5.601G	30	5.329G	31	5.702G	32	5.460G
33	5.571G	34	5.651G	35	5.398G	36	5.689G
37	5.555G	38	5.627G	39	5.577G	40	5.480G
41	5.668G	42	5.411G	43	5.388G	44	5.477G
45	5.452G	46	5.312G	47	5.637G	48	5.468G
49	5.592G	50	5.334G	51	5.481G	52	5.588G
53	5.409G	54	5.598G	55	5.605G	56	5.536G
57	5.400G	58	5.643G	59	5.331G	60	5.345G
61	5.442G	62	5.512G	63	5.358G	64	5.520G
65	5.703G	66	5.330G	67	5.343G	68	5.433G
69	5.644G	70	5.545G	71	5.628G	72	5.556G
73	5.712G	74	5.691G	75	5.582G	76	5.690G
77	5.369G	78	5.609G	79	5.621G	80	5.586G
81	5.499G	82	5.528G	83	5.333G	84	5.581G
85	5.381G	86	5.551G	87	5.686G	88	5.387G
89	5.413G	90	5.464G	91	5.664G	92	5.462G
93	5.550G	94	5.620G	95	5.518G	96	5.700G
97	5.544G	98	5.654G	99	5.695G	100	5.474G



A D T

Hopping Frequency Sequence Name: HOP_FREQ_SEQ_12							
SEQ#	Frequency (Hz)	SEQ#	Frequency (Hz)	SEQ#	Frequency (Hz)	SEQ#	Frequency (Hz)
1	5.437G	2	5.478G	3	5.328G	4	5.385G
5	5.668G	6	5.613G	7	5.674G	8	5.578G
9	5.255G	10	5.465G	11	5.616G	12	5.450G
13	5.542G	14	5.401G	15	5.455G	16	5.556G
17	5.296G	18	5.632G	19	5.709G	20	5.466G
21	5.269G	22	5.561G	23	5.343G	24	5.679G
25	5.376G	26	5.530G	27	5.371G	28	5.608G
29	5.308G	30	5.571G	31	5.511G	32	5.390G
33	5.716G	34	5.307G	35	5.391G	36	5.604G
37	5.590G	38	5.526G	39	5.363G	40	5.369G
41	5.623G	42	5.330G	43	5.368G	44	5.699G
45	5.607G	46	5.295G	47	5.688G	48	5.549G
49	5.340G	50	5.594G	51	5.479G	52	5.467G
53	5.545G	54	5.575G	55	5.382G	56	5.381G
57	5.377G	58	5.454G	59	5.415G	60	5.615G
61	5.646G	62	5.353G	63	5.680G	64	5.442G
65	5.412G	66	5.321G	67	5.364G	68	5.628G
69	5.492G	70	5.347G	71	5.481G	72	5.498G
73	5.703G	74	5.490G	75	5.355G	76	5.691G
77	5.366G	78	5.641G	79	5.342G	80	5.585G
81	5.711G	82	5.504G	83	5.463G	84	5.588G
85	5.626G	86	5.362G	87	5.587G	88	5.474G
89	5.394G	90	5.695G	91	5.569G	92	5.675G
93	5.651G	94	5.630G	95	5.444G	96	5.546G
97	5.441G	98	5.649G	99	5.341G	100	5.516G



A D T

Hopping Frequency Sequence Name: HOP_FREQ_SEQ_13							
SEQ#	Frequency (Hz)	SEQ#	Frequency (Hz)	SEQ#	Frequency (Hz)	SEQ#	Frequency (Hz)
1	5.267G	2	5.446G	3	5.414G	4	5.722G
5	5.545G	6	5.439G	7	5.431G	8	5.598G
9	5.388G	10	5.372G	11	5.575G	12	5.589G
13	5.622G	14	5.667G	15	5.325G	16	5.347G
17	5.415G	18	5.640G	19	5.607G	20	5.465G
21	5.315G	22	5.314G	23	5.405G	24	5.336G
25	5.697G	26	5.397G	27	5.362G	28	5.679G
29	5.452G	30	5.495G	31	5.477G	32	5.616G
33	5.700G	34	5.322G	35	5.564G	36	5.462G
37	5.502G	38	5.492G	39	5.368G	40	5.683G
41	5.459G	42	5.724G	43	5.392G	44	5.429G
45	5.385G	46	5.476G	47	5.713G	48	5.629G
49	5.353G	50	5.547G	51	5.623G	52	5.641G
53	5.716G	54	5.342G	55	5.524G	56	5.441G
57	5.634G	58	5.569G	59	5.410G	60	5.566G
61	5.313G	62	5.427G	63	5.653G	64	5.560G
65	5.308G	66	5.652G	67	5.424G	68	5.349G
69	5.310G	70	5.709G	71	5.563G	72	5.373G
73	5.537G	74	5.506G	75	5.382G	76	5.631G
77	5.436G	78	5.717G	79	5.674G	80	5.613G
81	5.694G	82	5.487G	83	5.442G	84	5.688G
85	5.455G	86	5.695G	87	5.425G	88	5.466G
89	5.403G	90	5.572G	91	5.421G	92	5.625G
93	5.654G	94	5.311G	95	5.639G	96	5.413G
97	5.399G	98	5.603G	99	5.478G	100	5.574G



A D T

Hopping Frequency Sequence Name: HOP_FREQ_SEQ_14							
SEQ#	Frequency (Hz)	SEQ#	Frequency (Hz)	SEQ#	Frequency (Hz)	SEQ#	Frequency (Hz)
1	5.507G	2	5.540G	3	5.689G	4	5.606G
5	5.268G	6	5.353G	7	5.454G	8	5.607G
9	5.492G	10	5.435G	11	5.400G	12	5.334G
13	5.724G	14	5.313G	15	5.369G	16	5.398G
17	5.455G	18	5.671G	19	5.349G	20	5.503G
21	5.284G	22	5.700G	23	5.670G	24	5.475G
25	5.356G	26	5.657G	27	5.526G	28	5.629G
29	5.666G	30	5.615G	31	5.708G	32	5.511G
33	5.304G	34	5.674G	35	5.645G	36	5.570G
37	5.403G	38	5.530G	39	5.487G	40	5.664G
41	5.533G	42	5.627G	43	5.651G	44	5.499G
45	5.333G	46	5.588G	47	5.604G	48	5.360G
49	5.274G	50	5.576G	51	5.423G	52	5.504G
53	5.421G	54	5.518G	55	5.667G	56	5.694G
57	5.715G	58	5.451G	59	5.326G	60	5.682G
61	5.685G	62	5.381G	63	5.695G	64	5.437G
65	5.569G	66	5.490G	67	5.393G	68	5.510G
69	5.295G	70	5.448G	71	5.373G	72	5.692G
73	5.450G	74	5.673G	75	5.354G	76	5.444G
77	5.406G	78	5.419G	79	5.617G	80	5.701G
81	5.392G	82	5.357G	83	5.552G	84	5.534G
85	5.638G	86	5.440G	87	5.686G	88	5.350G
89	5.723G	90	5.529G	91	5.712G	92	5.367G
93	5.341G	94	5.572G	95	5.447G	96	5.630G
97	5.586G	98	5.414G	99	5.329G	100	5.525G



A D T

Hopping Frequency Sequence Name: HOP_FREQ_SEQ_15							
SEQ#	Frequency (Hz)	SEQ#	Frequency (Hz)	SEQ#	Frequency (Hz)	SEQ#	Frequency (Hz)
1	5.704G	2	5.453G	3	5.538G	4	5.392G
5	5.257G	6	5.662G	7	5.560G	8	5.701G
9	5.290G	10	5.665G	11	5.707G	12	5.678G
13	5.497G	14	5.516G	15	5.372G	16	5.541G
17	5.337G	18	5.456G	19	5.388G	20	5.485G
21	5.270G	22	5.702G	23	5.563G	24	5.616G
25	5.583G	26	5.596G	27	5.501G	28	5.692G
29	5.433G	30	5.629G	31	5.367G	32	5.694G
33	5.304G	34	5.353G	35	5.633G	36	5.656G
37	5.573G	38	5.449G	39	5.365G	40	5.559G
41	5.632G	42	5.504G	43	5.708G	44	5.679G
45	5.467G	46	5.451G	47	5.366G	48	5.631G
49	5.322G	50	5.298G	51	5.519G	52	5.407G
53	5.635G	54	5.525G	55	5.484G	56	5.360G
57	5.610G	58	5.398G	59	5.574G	60	5.549G
61	5.581G	62	5.690G	63	5.499G	64	5.687G
65	5.293G	66	5.498G	67	5.531G	68	5.565G
69	5.278G	70	5.617G	71	5.639G	72	5.608G
73	5.470G	74	5.615G	75	5.620G	76	5.401G
77	5.333G	78	5.621G	79	5.359G	80	5.355G
81	5.331G	82	5.604G	83	5.634G	84	5.724G
85	5.646G	86	5.532G	87	5.625G	88	5.543G
89	5.394G	90	5.439G	91	5.488G	92	5.533G
93	5.603G	94	5.592G	95	5.598G	96	5.652G
97	5.500G	98	5.599G	99	5.472G	100	5.611G



A D T

Hopping Frequency Sequence Name: HOP_FREQ_SEQ_16							
SEQ#	Frequency (Hz)	SEQ#	Frequency (Hz)	SEQ#	Frequency (Hz)	SEQ#	Frequency (Hz)
1	5.686G	2	5.436G	3	5.564G	4	5.632G
5	5.435G	6	5.282G	7	5.597G	8	5.447G
9	5.645G	10	5.415G	11	5.469G	12	5.519G
13	5.457G	14	5.413G	15	5.642G	16	5.590G
17	5.378G	18	5.517G	19	5.344G	20	5.353G
21	5.363G	22	5.649G	23	5.380G	24	5.540G
25	5.352G	26	5.663G	27	5.497G	28	5.588G
29	5.658G	30	5.546G	31	5.310G	32	5.706G
33	5.449G	34	5.543G	35	5.418G	36	5.595G
37	5.296G	38	5.379G	39	5.697G	40	5.671G
41	5.262G	42	5.324G	43	5.718G	44	5.558G
45	5.421G	46	5.617G	47	5.524G	48	5.668G
49	5.587G	50	5.725G	51	5.648G	52	5.423G
53	5.466G	54	5.647G	55	5.573G	56	5.659G
57	5.520G	58	5.312G	59	5.585G	60	5.708G
61	5.450G	62	5.332G	63	5.432G	64	5.535G
65	5.389G	66	5.470G	67	5.337G	68	5.495G
69	5.420G	70	5.382G	71	5.410G	72	5.638G
73	5.612G	74	5.654G	75	5.611G	76	5.357G
77	5.586G	78	5.496G	79	5.521G	80	5.395G
81	5.270G	82	5.594G	83	5.709G	84	5.419G
85	5.651G	86	5.539G	87	5.398G	88	5.516G
89	5.548G	90	5.664G	91	5.335G	92	5.355G
93	5.428G	94	5.467G	95	5.401G	96	5.499G
97	5.278G	98	5.567G	99	5.636G	100	5.620G



A D T

Hopping Frequency Sequence Name: HOP_FREQ_SEQ_17							
SEQ#	Frequency (Hz)	SEQ#	Frequency (Hz)	SEQ#	Frequency (Hz)	SEQ#	Frequency (Hz)
1	5.528G	2	5.705G	3	5.608G	4	5.690G
5	5.491G	6	5.604G	7	5.558G	8	5.639G
9	5.290G	10	5.706G	11	5.504G	12	5.642G
13	5.510G	14	5.464G	15	5.401G	16	5.408G
17	5.395G	18	5.460G	19	5.419G	20	5.382G
21	5.258G	22	5.697G	23	5.474G	24	5.426G
25	5.447G	26	5.696G	27	5.552G	28	5.437G
29	5.478G	30	5.566G	31	5.362G	32	5.485G
33	5.266G	34	5.583G	35	5.455G	36	5.567G
37	5.560G	38	5.529G	39	5.405G	40	5.711G
41	5.369G	42	5.412G	43	5.431G	44	5.610G
45	5.586G	46	5.400G	47	5.628G	48	5.440G
49	5.433G	50	5.482G	51	5.589G	52	5.383G
53	5.489G	54	5.380G	55	5.614G	56	5.541G
57	5.349G	58	5.502G	59	5.357G	60	5.717G
61	5.335G	62	5.715G	63	5.484G	64	5.526G
65	5.693G	66	5.653G	67	5.339G	68	5.632G
69	5.534G	70	5.714G	71	5.629G	72	5.678G
73	5.525G	74	5.689G	75	5.389G	76	5.377G
77	5.679G	78	5.515G	79	5.643G	80	5.704G
81	5.331G	82	5.317G	83	5.415G	84	5.376G
85	5.387G	86	5.296G	87	5.650G	88	5.396G
89	5.289G	90	5.545G	91	5.406G	92	5.627G
93	5.716G	94	5.725G	95	5.681G	96	5.634G
97	5.350G	98	5.527G	99	5.446G	100	5.467G



A D T

Hopping Frequency Sequence Name: HOP_FREQ_SEQ_18							
SEQ#	Frequency (Hz)	SEQ#	Frequency (Hz)	SEQ#	Frequency (Hz)	SEQ#	Frequency (Hz)
1	5.632G	2	5.673G	3	5.563G	4	5.686G
5	5.725G	6	5.703G	7	5.534G	8	5.664G
9	5.701G	10	5.290G	11	5.584G	12	5.574G
13	5.338G	14	5.695G	15	5.427G	16	5.656G
17	5.395G	18	5.447G	19	5.323G	20	5.614G
21	5.567G	22	5.489G	23	5.306G	24	5.388G
25	5.552G	26	5.294G	27	5.637G	28	5.349G
29	5.720G	30	5.503G	31	5.437G	32	5.616G
33	5.499G	34	5.451G	35	5.592G	36	5.496G
37	5.491G	38	5.424G	39	5.576G	40	5.359G
41	5.646G	42	5.363G	43	5.387G	44	5.501G
45	5.650G	46	5.307G	47	5.353G	48	5.520G
49	5.536G	50	5.548G	51	5.318G	52	5.715G
53	5.484G	54	5.564G	55	5.613G	56	5.358G
57	5.615G	58	5.587G	59	5.602G	60	5.504G
61	5.635G	62	5.684G	63	5.560G	64	5.453G
65	5.439G	66	5.472G	67	5.505G	68	5.555G
69	5.680G	70	5.657G	71	5.497G	72	5.485G
73	5.633G	74	5.524G	75	5.528G	76	5.639G
77	5.557G	78	5.676G	79	5.455G	80	5.426G
81	5.473G	82	5.390G	83	5.675G	84	5.699G
85	5.636G	86	5.674G	87	5.384G	88	5.589G
89	5.585G	90	5.586G	91	5.526G	92	5.593G
93	5.515G	94	5.352G	95	5.374G	96	5.511G
97	5.570G	98	5.488G	99	5.644G	100	5.517G



A D T

Hopping Frequency Sequence Name: HOP_FREQ_SEQ_19							
SEQ#	Frequency (Hz)	SEQ#	Frequency (Hz)	SEQ#	Frequency (Hz)	SEQ#	Frequency (Hz)
1	5.430G	2	5.678G	3	5.387G	4	5.594G
5	5.404G	6	5.306G	7	5.451G	8	5.654G
9	5.487G	10	5.383G	11	5.355G	12	5.456G
13	5.263G	14	5.511G	15	5.388G	16	5.362G
17	5.579G	18	5.320G	19	5.535G	20	5.554G
21	5.547G	22	5.577G	23	5.596G	24	5.722G
25	5.537G	26	5.720G	27	5.536G	28	5.474G
29	5.520G	30	5.576G	31	5.684G	32	5.473G
33	5.524G	34	5.510G	35	5.496G	36	5.335G
37	5.633G	38	5.416G	39	5.573G	40	5.482G
41	5.389G	42	5.373G	43	5.326G	44	5.674G
45	5.578G	46	5.645G	47	5.597G	48	5.637G
49	5.461G	50	5.468G	51	5.360G	52	5.595G
53	5.380G	54	5.453G	55	5.400G	56	5.519G
57	5.458G	58	5.602G	59	5.399G	60	5.386G
61	5.695G	62	5.328G	63	5.589G	64	5.498G
65	5.514G	66	5.352G	67	5.626G	68	5.563G
69	5.681G	70	5.428G	71	5.346G	72	5.406G
73	5.679G	74	5.414G	75	5.437G	76	5.707G
77	5.361G	78	5.369G	79	5.627G	80	5.703G
81	5.499G	82	5.422G	83	5.425G	84	5.687G
85	5.371G	86	5.612G	87	5.395G	88	5.682G
89	5.609G	90	5.318G	91	5.459G	92	5.546G
93	5.299G	94	5.685G	95	5.556G	96	5.515G
97	5.624G	98	5.516G	99	5.588G	100	5.713G



A D T

Hopping Frequency Sequence Name: HOP_FREQ_SEQ_20							
SEQ#	Frequency (Hz)	SEQ#	Frequency (Hz)	SEQ#	Frequency (Hz)	SEQ#	Frequency (Hz)
1	5.373G	2	5.492G	3	5.424G	4	5.447G
5	5.490G	6	5.359G	7	5.584G	8	5.515G
9	5.535G	10	5.396G	11	5.659G	12	5.438G
13	5.697G	14	5.607G	15	5.349G	16	5.421G
17	5.456G	18	5.711G	19	5.709G	20	5.430G
21	5.366G	22	5.571G	23	5.699G	24	5.590G
25	5.384G	26	5.414G	27	5.387G	28	5.614G
29	5.303G	30	5.478G	31	5.319G	32	5.391G
33	5.692G	34	5.402G	35	5.710G	36	5.572G
37	5.467G	38	5.441G	39	5.586G	40	5.395G
41	5.431G	42	5.302G	43	5.591G	44	5.472G
45	5.558G	46	5.725G	47	5.463G	48	5.682G
49	5.690G	50	5.465G	51	5.322G	52	5.545G
53	5.637G	54	5.419G	55	5.377G	56	5.551G
57	5.680G	58	5.363G	59	5.542G	60	5.685G
61	5.290G	62	5.488G	63	5.375G	64	5.654G
65	5.557G	66	5.529G	67	5.565G	68	5.678G
69	5.500G	70	5.410G	71	5.516G	72	5.700G
73	5.593G	74	5.631G	75	5.401G	76	5.594G
77	5.274G	78	5.412G	79	5.604G	80	5.361G
81	5.640G	82	5.509G	83	5.347G	84	5.459G
85	5.550G	86	5.566G	87	5.360G	88	5.413G
89	5.451G	90	5.491G	91	5.328G	92	5.513G
93	5.667G	94	5.723G	95	5.352G	96	5.433G
97	5.469G	98	5.646G	99	5.473G	100	5.527G



A D T

Hopping Frequency Sequence Name: HOP_FREQ_SEQ_21							
SEQ#	Frequency (Hz)	SEQ#	Frequency (Hz)	SEQ#	Frequency (Hz)	SEQ#	Frequency (Hz)
1	5.489G	2	5.555G	3	5.406G	4	5.400G
5	5.291G	6	5.478G	7	5.349G	8	5.377G
9	5.505G	10	5.444G	11	5.617G	12	5.522G
13	5.518G	14	5.462G	15	5.397G	16	5.581G
17	5.577G	18	5.361G	19	5.379G	20	5.667G
21	5.475G	22	5.416G	23	5.650G	24	5.447G
25	5.450G	26	5.525G	27	5.610G	28	5.451G
29	5.512G	30	5.375G	31	5.494G	32	5.706G
33	5.668G	34	5.480G	35	5.609G	36	5.665G
37	5.558G	38	5.662G	39	5.334G	40	5.630G
41	5.672G	42	5.655G	43	5.686G	44	5.344G
45	5.357G	46	5.327G	47	5.643G	48	5.676G
49	5.424G	50	5.389G	51	5.486G	52	5.674G
53	5.718G	54	5.441G	55	5.439G	56	5.442G
57	5.720G	58	5.297G	59	5.325G	60	5.699G
61	5.532G	62	5.661G	63	5.434G	64	5.704G
65	5.433G	66	5.485G	67	5.495G	68	5.642G
69	5.421G	70	5.395G	71	5.548G	72	5.396G
73	5.455G	74	5.715G	75	5.463G	76	5.691G
77	5.278G	78	5.497G	79	5.353G	80	5.602G
81	5.464G	82	5.401G	83	5.473G	84	5.680G
85	5.303G	86	5.407G	87	5.385G	88	5.578G
89	5.571G	90	5.412G	91	5.600G	92	5.579G
93	5.312G	94	5.469G	95	5.582G	96	5.575G
97	5.697G	98	5.671G	99	5.468G	100	5.541G



A D T

Hopping Frequency Sequence Name: HOP_FREQ_SEQ_22							
SEQ#	Frequency (Hz)	SEQ#	Frequency (Hz)	SEQ#	Frequency (Hz)	SEQ#	Frequency (Hz)
1	5.718G	2	5.283G	3	5.648G	4	5.562G
5	5.603G	6	5.546G	7	5.474G	8	5.612G
9	5.520G	10	5.538G	11	5.516G	12	5.660G
13	5.379G	14	5.307G	15	5.572G	16	5.381G
17	5.337G	18	5.372G	19	5.672G	20	5.588G
21	5.384G	22	5.329G	23	5.511G	24	5.703G
25	5.551G	26	5.373G	27	5.380G	28	5.593G
29	5.509G	30	5.634G	31	5.712G	32	5.465G
33	5.591G	34	5.430G	35	5.357G	36	5.506G
37	5.567G	38	5.301G	39	5.364G	40	5.619G
41	5.290G	42	5.514G	43	5.441G	44	5.396G
45	5.689G	46	5.709G	47	5.455G	48	5.495G
49	5.631G	50	5.345G	51	5.467G	52	5.486G
53	5.530G	54	5.497G	55	5.358G	56	5.645G
57	5.279G	58	5.469G	59	5.686G	60	5.655G
61	5.602G	62	5.429G	63	5.376G	64	5.436G
65	5.443G	66	5.332G	67	5.333G	68	5.652G
69	5.479G	70	5.523G	71	5.466G	72	5.483G
73	5.605G	74	5.320G	75	5.503G	76	5.400G
77	5.431G	78	5.674G	79	5.476G	80	5.407G
81	5.449G	82	5.367G	83	5.577G	84	5.702G
85	5.715G	86	5.661G	87	5.545G	88	5.507G
89	5.428G	90	5.658G	91	5.327G	92	5.363G
93	5.710G	94	5.610G	95	5.549G	96	5.508G
97	5.440G	98	5.356G	99	5.542G	100	5.515G



A D T

Hopping Frequency Sequence Name: HOP_FREQ_SEQ_23							
SEQ#	Frequency (Hz)	SEQ#	Frequency (Hz)	SEQ#	Frequency (Hz)	SEQ#	Frequency (Hz)
1	5.390G	2	5.476G	3	5.627G	4	5.687G
5	5.455G	6	5.293G	7	5.539G	8	5.657G
9	5.525G	10	5.668G	11	5.723G	12	5.523G
13	5.325G	14	5.469G	15	5.582G	16	5.601G
17	5.650G	18	5.406G	19	5.446G	20	5.506G
21	5.673G	22	5.620G	23	5.535G	24	5.676G
25	5.512G	26	5.678G	27	5.543G	28	5.454G
29	5.626G	30	5.656G	31	5.327G	32	5.700G
33	5.342G	34	5.584G	35	5.320G	36	5.689G
37	5.721G	38	5.323G	39	5.493G	40	5.722G
41	5.597G	42	5.664G	43	5.565G	44	5.344G
45	5.720G	46	5.669G	47	5.530G	48	5.570G
49	5.401G	50	5.649G	51	5.363G	52	5.611G
53	5.628G	54	5.318G	55	5.609G	56	5.564G
57	5.665G	58	5.310G	59	5.698G	60	5.671G
61	5.319G	62	5.608G	63	5.339G	64	5.471G
65	5.537G	66	5.474G	67	5.470G	68	5.399G
69	5.459G	70	5.502G	71	5.699G	72	5.685G
73	5.335G	74	5.593G	75	5.322G	76	5.475G
77	5.386G	78	5.387G	79	5.423G	80	5.587G
81	5.507G	82	5.302G	83	5.340G	84	5.481G
85	5.551G	86	5.644G	87	5.404G	88	5.599G
89	5.463G	90	5.362G	91	5.606G	92	5.621G
93	5.349G	94	5.637G	95	5.696G	96	5.413G
97	5.505G	98	5.499G	99	5.538G	100	5.351G



A D T

Hopping Frequency Sequence Name: HOP_FREQ_SEQ_24							
SEQ#	Frequency (Hz)	SEQ#	Frequency (Hz)	SEQ#	Frequency (Hz)	SEQ#	Frequency (Hz)
1	5.349G	2	5.299G	3	5.352G	4	5.450G
5	5.262G	6	5.518G	7	5.564G	8	5.566G
9	5.586G	10	5.693G	11	5.663G	12	5.401G
13	5.452G	14	5.600G	15	5.713G	16	5.434G
17	5.269G	18	5.331G	19	5.403G	20	5.553G
21	5.412G	22	5.603G	23	5.540G	24	5.455G
25	5.669G	26	5.432G	27	5.596G	28	5.386G
29	5.520G	30	5.690G	31	5.641G	32	5.569G
33	5.443G	34	5.613G	35	5.530G	36	5.422G
37	5.644G	38	5.521G	39	5.705G	40	5.370G
41	5.449G	42	5.507G	43	5.356G	44	5.410G
45	5.399G	46	5.678G	47	5.688G	48	5.718G
49	5.640G	50	5.587G	51	5.590G	52	5.498G
53	5.581G	54	5.353G	55	5.717G	56	5.658G
57	5.495G	58	5.698G	59	5.620G	60	5.639G
61	5.409G	62	5.568G	63	5.341G	64	5.707G
65	5.684G	66	5.307G	67	5.704G	68	5.485G
69	5.330G	70	5.499G	71	5.394G	72	5.482G
73	5.671G	74	5.382G	75	5.668G	76	5.435G
77	5.484G	78	5.664G	79	5.522G	80	5.384G
81	5.682G	82	5.309G	83	5.357G	84	5.565G
85	5.324G	86	5.597G	87	5.647G	88	5.719G
89	5.651G	90	5.576G	91	5.502G	92	5.389G
93	5.497G	94	5.697G	95	5.694G	96	5.395G
97	5.368G	98	5.574G	99	5.492G	100	5.702G



A D T

Hopping Frequency Sequence Name: HOP_FREQ_SEQ_25							
SEQ#	Frequency (Hz)	SEQ#	Frequency (Hz)	SEQ#	Frequency (Hz)	SEQ#	Frequency (Hz)
1	5.689G	2	5.620G	3	5.691G	4	5.561G
5	5.256G	6	5.352G	7	5.581G	8	5.477G
9	5.635G	10	5.503G	11	5.562G	12	5.664G
13	5.254G	14	5.382G	15	5.556G	16	5.696G
17	5.712G	18	5.301G	19	5.423G	20	5.623G
21	5.336G	22	5.661G	23	5.680G	24	5.587G
25	5.279G	26	5.681G	27	5.408G	28	5.331G
29	5.272G	30	5.299G	31	5.706G	32	5.364G
33	5.534G	34	5.573G	35	5.325G	36	5.598G
37	5.309G	38	5.365G	39	5.504G	40	5.449G
41	5.532G	42	5.346G	43	5.667G	44	5.486G
45	5.349G	46	5.419G	47	5.652G	48	5.609G
49	5.411G	50	5.610G	51	5.397G	52	5.622G
53	5.266G	54	5.371G	55	5.579G	56	5.654G
57	5.462G	58	5.482G	59	5.502G	60	5.531G
61	5.666G	62	5.655G	63	5.376G	64	5.700G
65	5.497G	66	5.392G	67	5.693G	68	5.509G
69	5.286G	70	5.355G	71	5.433G	72	5.460G
73	5.338G	74	5.305G	75	5.572G	76	5.603G
77	5.388G	78	5.690G	79	5.546G	80	5.378G
81	5.508G	82	5.653G	83	5.431G	84	5.631G
85	5.553G	86	5.520G	87	5.436G	88	5.628G
89	5.490G	90	5.430G	91	5.381G	92	5.402G
93	5.389G	94	5.606G	95	5.633G	96	5.600G
97	5.357G	98	5.671G	99	5.640G	100	5.450G



A D T

Hopping Frequency Sequence Name: HOP_FREQ_SEQ_26							
SEQ#	Frequency (Hz)	SEQ#	Frequency (Hz)	SEQ#	Frequency (Hz)	SEQ#	Frequency (Hz)
1	5.669G	2	5.577G	3	5.652G	4	5.392G
5	5.470G	6	5.694G	7	5.653G	8	5.340G
9	5.355G	10	5.672G	11	5.473G	12	5.656G
13	5.274G	14	5.619G	15	5.610G	16	5.639G
17	5.666G	18	5.579G	19	5.474G	20	5.641G
21	5.560G	22	5.667G	23	5.519G	24	5.692G
25	5.643G	26	5.590G	27	5.494G	28	5.491G
29	5.273G	30	5.502G	31	5.405G	32	5.452G
33	5.598G	34	5.416G	35	5.390G	36	5.707G
37	5.447G	38	5.344G	39	5.661G	40	5.685G
41	5.418G	42	5.404G	43	5.671G	44	5.534G
45	5.552G	46	5.426G	47	5.354G	48	5.724G
49	5.638G	50	5.353G	51	5.558G	52	5.450G
53	5.375G	54	5.327G	55	5.460G	56	5.356G
57	5.574G	58	5.691G	59	5.606G	60	5.479G
61	5.593G	62	5.583G	63	5.420G	64	5.540G
65	5.484G	66	5.516G	67	5.586G	68	5.709G
69	5.325G	70	5.695G	71	5.435G	72	5.369G
73	5.562G	74	5.647G	75	5.713G	76	5.539G
77	5.508G	78	5.561G	79	5.512G	80	5.439G
81	5.486G	82	5.636G	83	5.510G	84	5.595G
85	5.607G	86	5.547G	87	5.637G	88	5.403G
89	5.527G	90	5.358G	91	5.541G	92	5.487G
93	5.465G	94	5.723G	95	5.571G	96	5.373G
97	5.285G	98	5.442G	99	5.466G	100	5.421G



A D T

Hopping Frequency Sequence Name: HOP_FREQ_SEQ_27							
SEQ#	Frequency (Hz)	SEQ#	Frequency (Hz)	SEQ#	Frequency (Hz)	SEQ#	Frequency (Hz)
1	5.417G	2	5.606G	3	5.561G	4	5.388G
5	5.352G	6	5.290G	7	5.596G	8	5.398G
9	5.346G	10	5.522G	11	5.445G	12	5.550G
13	5.373G	14	5.696G	15	5.405G	16	5.722G
17	5.457G	18	5.600G	19	5.517G	20	5.435G
21	5.694G	22	5.437G	23	5.356G	24	5.705G
25	5.504G	26	5.334G	27	5.312G	28	5.503G
29	5.575G	30	5.671G	31	5.495G	32	5.588G
33	5.585G	34	5.444G	35	5.456G	36	5.418G
37	5.359G	38	5.626G	39	5.659G	40	5.531G
41	5.291G	42	5.465G	43	5.704G	44	5.472G
45	5.609G	46	5.328G	47	5.450G	48	5.706G
49	5.604G	50	5.427G	51	5.447G	52	5.656G
53	5.496G	54	5.288G	55	5.535G	56	5.389G
57	5.581G	58	5.555G	59	5.322G	60	5.345G
61	5.301G	62	5.622G	63	5.676G	64	5.554G
65	5.614G	66	5.324G	67	5.539G	68	5.679G
69	5.295G	70	5.687G	71	5.371G	72	5.538G
73	5.310G	74	5.708G	75	5.365G	76	5.566G
77	5.568G	78	5.326G	79	5.698G	80	5.392G
81	5.414G	82	5.678G	83	5.633G	84	5.422G
85	5.357G	86	5.384G	87	5.621G	88	5.420G
89	5.718G	90	5.369G	91	5.442G	92	5.485G
93	5.339G	94	5.393G	95	5.403G	96	5.481G
97	5.390G	98	5.315G	99	5.343G	100	5.578G



A D T

Hopping Frequency Sequence Name: HOP_FREQ_SEQ_28							
SEQ#	Frequency (Hz)	SEQ#	Frequency (Hz)	SEQ#	Frequency (Hz)	SEQ#	Frequency (Hz)
1	5.477G	2	5.352G	3	5.394G	4	5.488G
5	5.438G	6	5.634G	7	5.563G	8	5.370G
9	5.593G	10	5.610G	11	5.702G	12	5.552G
13	5.493G	14	5.377G	15	5.376G	16	5.497G
17	5.577G	18	5.355G	19	5.609G	20	5.652G
21	5.448G	22	5.526G	23	5.499G	24	5.398G
25	5.538G	26	5.385G	27	5.391G	28	5.524G
29	5.406G	30	5.600G	31	5.345G	32	5.671G
33	5.395G	34	5.375G	35	5.387G	36	5.622G
37	5.611G	38	5.687G	39	5.407G	40	5.401G
41	5.555G	42	5.489G	43	5.426G	44	5.344G
45	5.431G	46	5.619G	47	5.324G	48	5.417G
49	5.342G	50	5.535G	51	5.356G	52	5.343G
53	5.562G	54	5.292G	55	5.674G	56	5.710G
57	5.315G	58	5.682G	59	5.369G	60	5.400G
61	5.531G	62	5.612G	63	5.392G	64	5.569G
65	5.361G	66	5.308G	67	5.436G	68	5.596G
69	5.657G	70	5.444G	71	5.483G	72	5.533G
73	5.621G	74	5.606G	75	5.566G	76	5.508G
77	5.353G	78	5.548G	79	5.681G	80	5.433G
81	5.360G	82	5.482G	83	5.418G	84	5.720G
85	5.721G	86	5.339G	87	5.712G	88	5.643G
89	5.451G	90	5.613G	91	5.576G	92	5.381G
93	5.525G	94	5.680G	95	5.678G	96	5.688G
97	5.373G	98	5.357G	99	5.487G	100	5.574G



A D T

Hopping Frequency Sequence Name: HOP_FREQ_SEQ_29							
SEQ#	Frequency (Hz)	SEQ#	Frequency (Hz)	SEQ#	Frequency (Hz)	SEQ#	Frequency (Hz)
1	5.431G	2	5.632G	3	5.318G	4	5.578G
5	5.399G	6	5.555G	7	5.537G	8	5.342G
9	5.543G	10	5.600G	11	5.679G	12	5.623G
13	5.705G	14	5.336G	15	5.364G	16	5.608G
17	5.627G	18	5.312G	19	5.660G	20	5.725G
21	5.703G	22	5.595G	23	5.550G	24	5.333G
25	5.378G	26	5.416G	27	5.430G	28	5.698G
29	5.634G	30	5.657G	31	5.400G	32	5.386G
33	5.347G	34	5.382G	35	5.403G	36	5.590G
37	5.457G	38	5.337G	39	5.510G	40	5.684G
41	5.582G	42	5.319G	43	5.408G	44	5.651G
45	5.448G	46	5.546G	47	5.674G	48	5.701G
49	5.517G	50	5.443G	51	5.390G	52	5.508G
53	5.305G	54	5.551G	55	5.394G	56	5.397G
57	5.693G	58	5.564G	59	5.645G	60	5.509G
61	5.624G	62	5.317G	63	5.480G	64	5.495G
65	5.676G	66	5.723G	67	5.530G	68	5.572G
69	5.427G	70	5.442G	71	5.688G	72	5.682G
73	5.358G	74	5.428G	75	5.652G	76	5.710G
77	5.672G	78	5.418G	79	5.521G	80	5.707G
81	5.528G	82	5.376G	83	5.349G	84	5.619G
85	5.637G	86	5.639G	87	5.518G	88	5.506G
89	5.617G	90	5.549G	91	5.324G	92	5.685G
93	5.567G	94	5.539G	95	5.692G	96	5.665G
97	5.602G	98	5.523G	99	5.675G	100	5.711G



A D T

Hopping Frequency Sequence Name: HOP_FREQ_SEQ_30							
SEQ#	Frequency (Hz)	SEQ#	Frequency (Hz)	SEQ#	Frequency (Hz)	SEQ#	Frequency (Hz)
1	5.274G	2	5.312G	3	5.655G	4	5.530G
5	5.586G	6	5.422G	7	5.632G	8	5.640G
9	5.323G	10	5.534G	11	5.393G	12	5.722G
13	5.505G	14	5.344G	15	5.584G	16	5.444G
17	5.280G	18	5.679G	19	5.575G	20	5.431G
21	5.317G	22	5.401G	23	5.633G	24	5.529G
25	5.436G	26	5.642G	27	5.614G	28	5.446G
29	5.425G	30	5.430G	31	5.494G	32	5.411G
33	5.615G	34	5.406G	35	5.365G	36	5.409G
37	5.296G	38	5.517G	39	5.509G	40	5.421G
41	5.538G	42	5.623G	43	5.572G	44	5.478G
45	5.358G	46	5.405G	47	5.376G	48	5.606G
49	5.335G	50	5.346G	51	5.359G	52	5.489G
53	5.520G	54	5.375G	55	5.563G	56	5.581G
57	5.637G	58	5.672G	59	5.461G	60	5.598G
61	5.361G	62	5.697G	63	5.541G	64	5.573G
65	5.432G	66	5.523G	67	5.647G	68	5.456G
69	5.608G	70	5.596G	71	5.464G	72	5.678G
73	5.404G	74	5.316G	75	5.695G	76	5.459G
77	5.308G	78	5.443G	79	5.415G	80	5.548G
81	5.539G	82	5.696G	83	5.559G	84	5.718G
85	5.603G	86	5.676G	87	5.337G	88	5.357G
89	5.291G	90	5.413G	91	5.412G	92	5.620G
93	5.662G	94	5.501G	95	5.399G	96	5.635G
97	5.452G	98	5.613G	99	5.597G	100	5.395G

---END---