

Power Spectral Density - Chain D (64QAM)

2488.5MHz

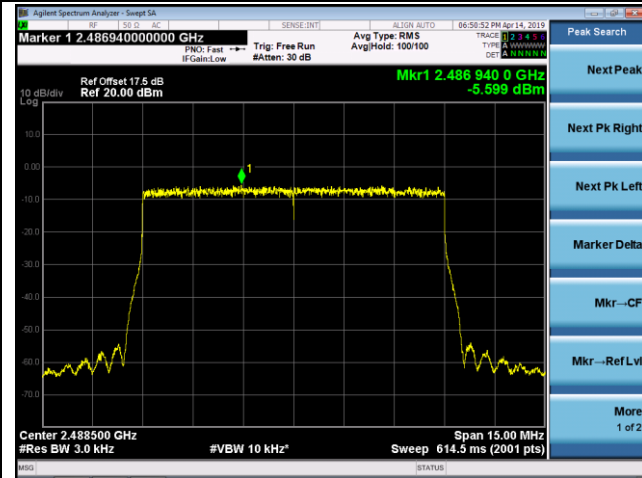

2489.0MHz

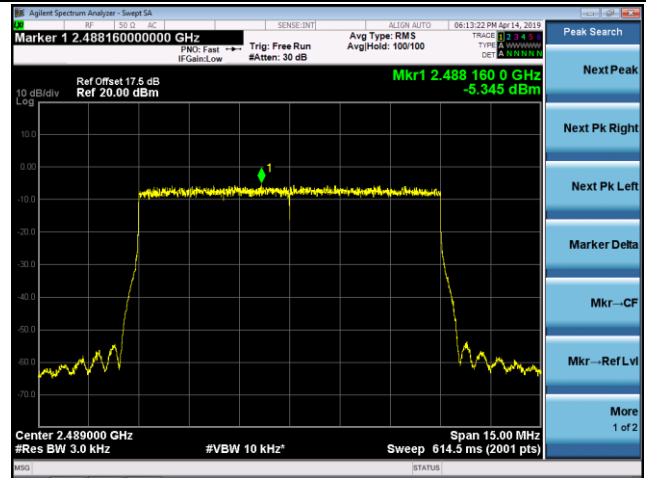

2490.0MHz

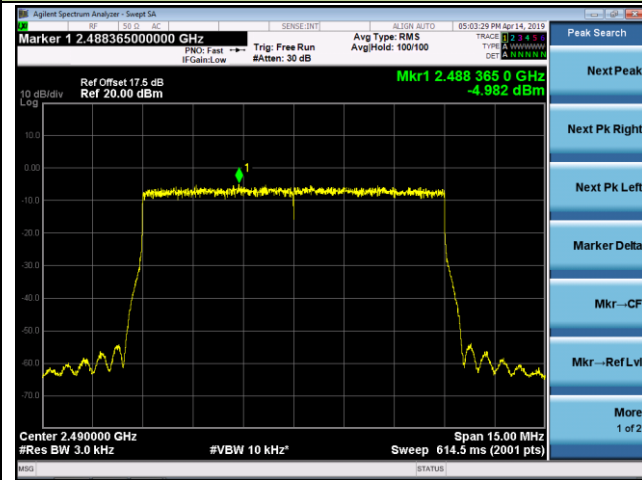

Power Spectral Density - Chain D (256QAM)

2488.5MHz

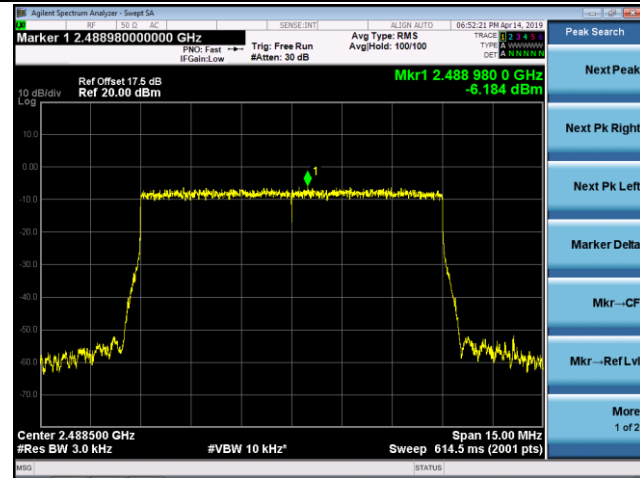

2489.0MHz

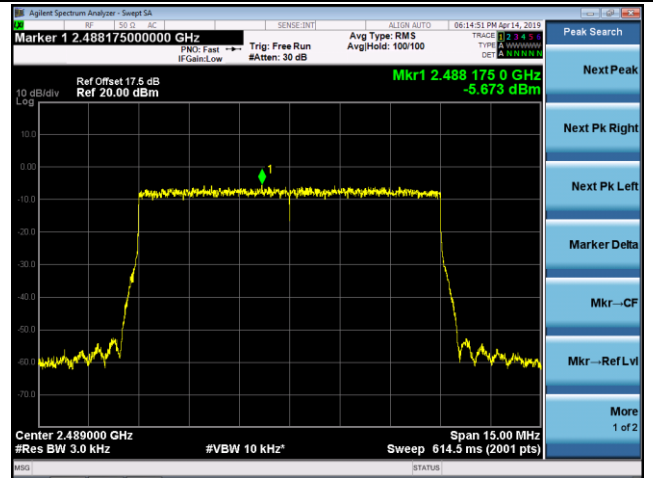

2490.0MHz

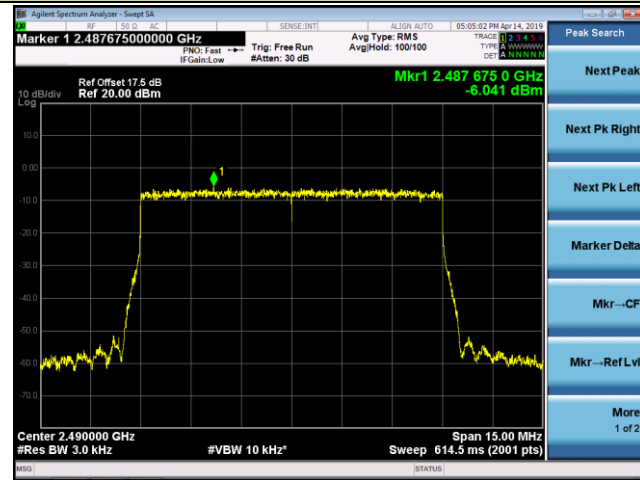

Power Spectral Density - Chain M (QPSK)

2488.5MHz

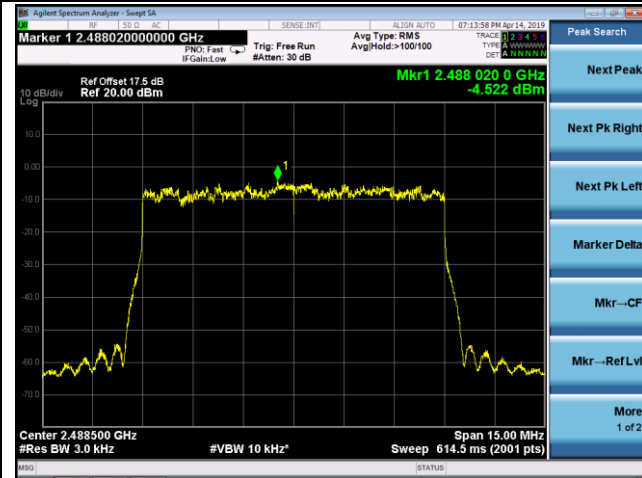

2489.0MHz

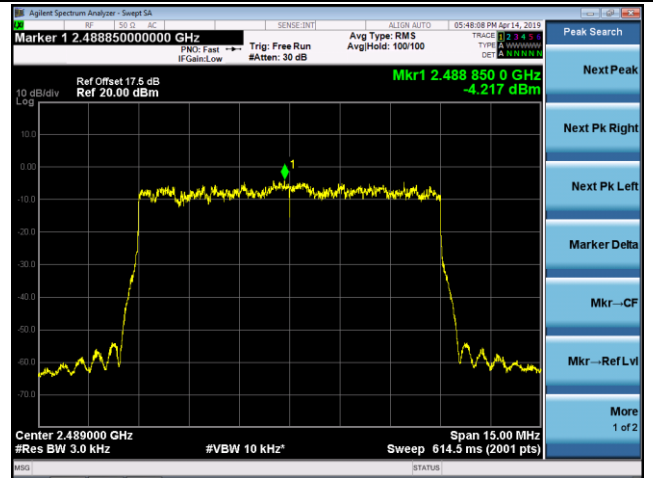

2490.0MHz

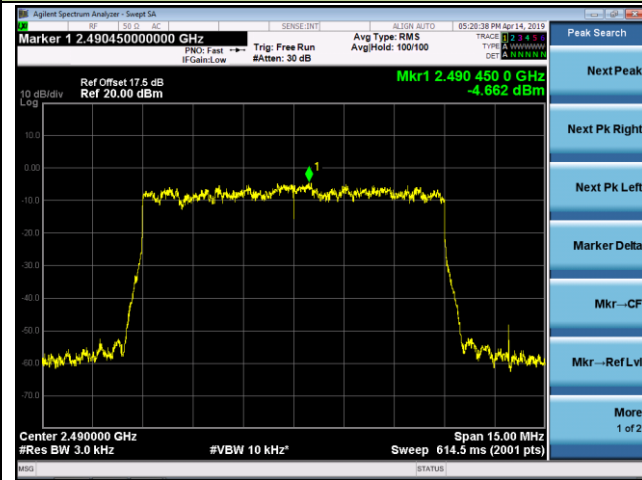

Power Spectral Density - Chain M (16QAM)

2488.5MHz

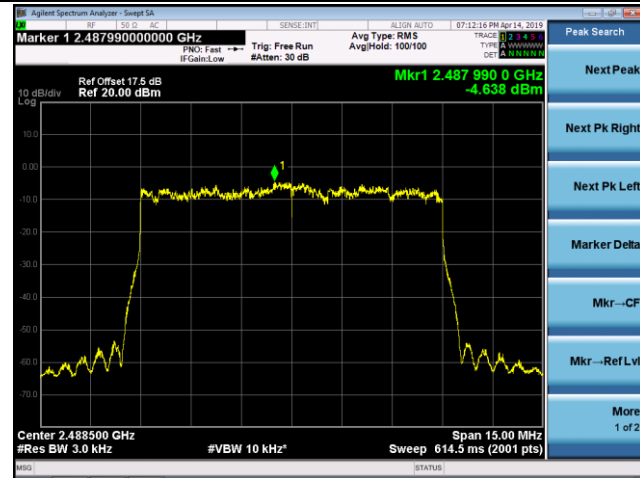

2489.0MHz

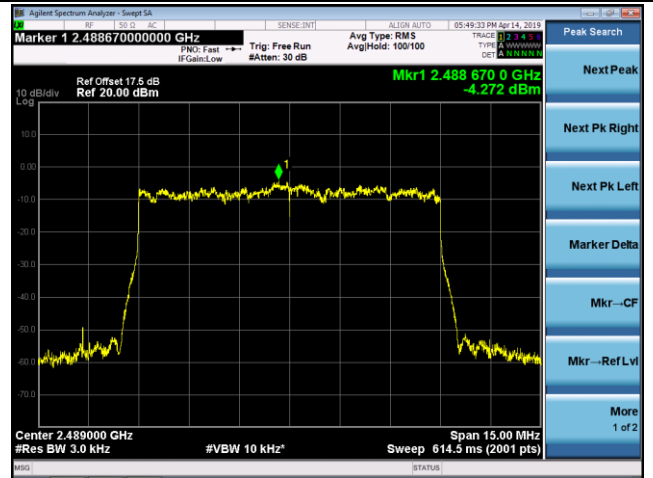

2490.0MHz

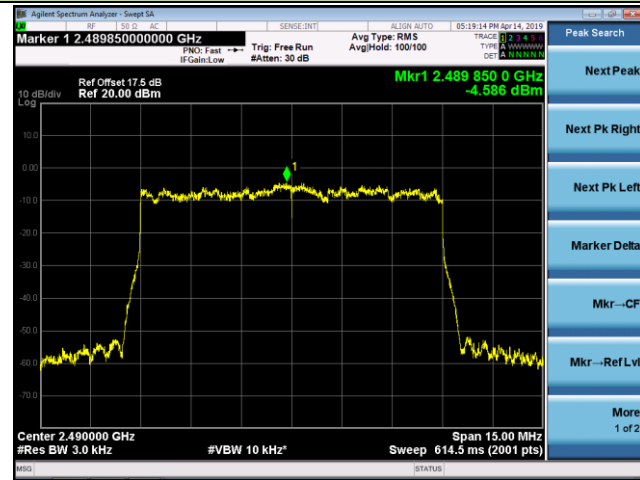

Power Spectral Density - Chain M (64QAM)

2488.5MHz

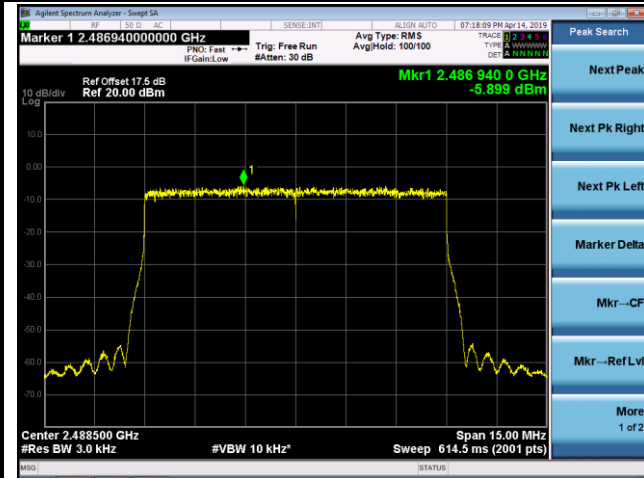

2489.0MHz

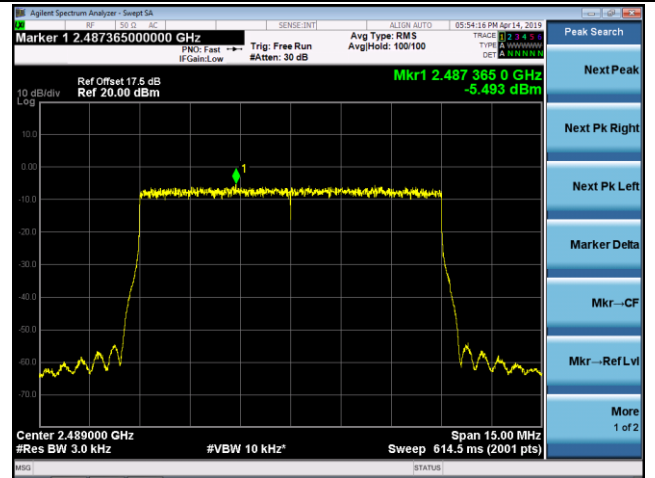

2490.0MHz

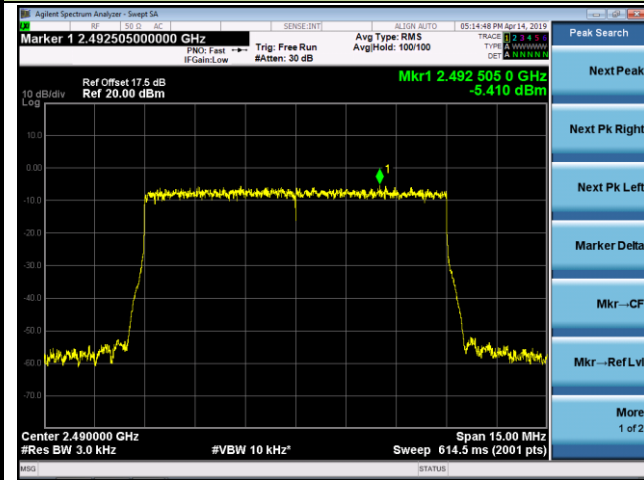

Power Spectral Density - Chain M (256QAM)

2488.5MHz

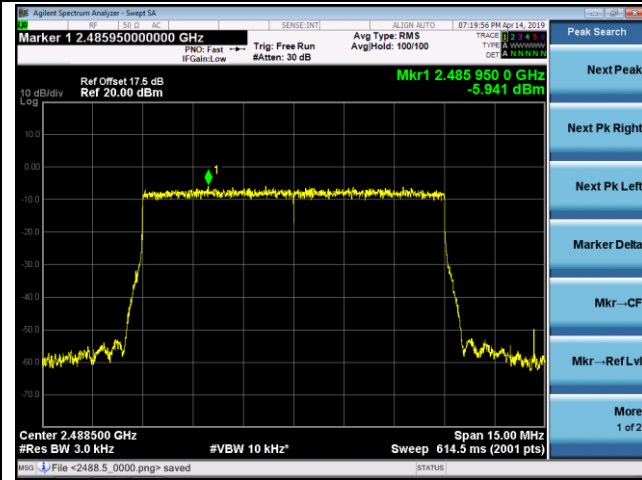

2489.0MHz

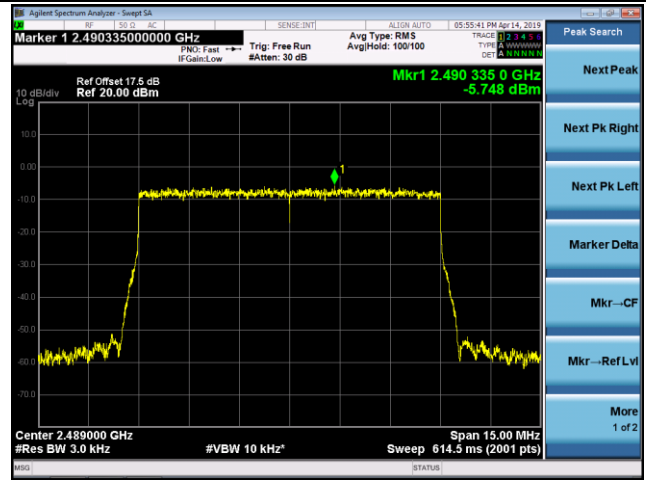

2490.0MHz

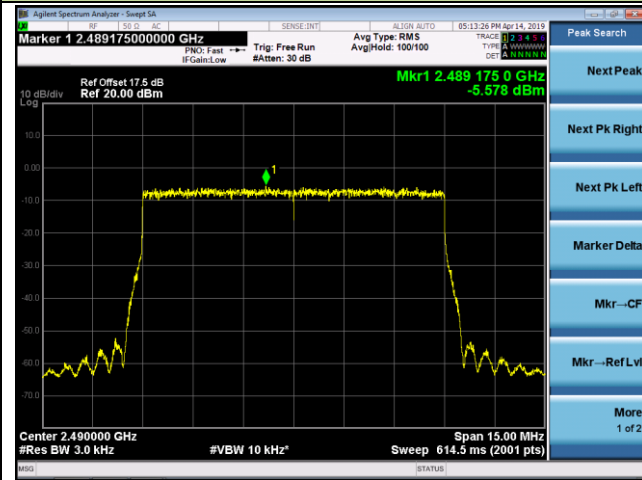

## **5.5. Frequency Stability Measurement**

### **5.5.1. Test Limit**

N/A

### **5.5.2. Test Procedure Used**

ANSI C63.26-2015 - Section 5.6

### **5.5.3. Test Setting**

#### **Frequency Stability Under Temperature Variations:**

The equipment under test was connected to an external AC or DC power supply and input rated voltage. RF output was connected to a frequency counter or spectrum analyzer via feed through attenuators. The EUT was placed inside the temperature chamber. Set the spectrum analyzer RBW low enough to obtain the desired frequency resolution and measure EUT 20°C operating frequency as reference frequency. Turn EUT off and set the chamber temperature to highest. After the temperature stabilized for approximately 30 minutes recorded the frequency. Repeat step measure with 10°C decreased per stage until the lowest temperature reached.

#### **Frequency Stability Under Voltage Variations:**

Set chamber temperature to 20°C. Use a variable AC power supply / DC power source to power the EUT and set the voltage to rated voltage. Set the spectrum analyzer RBW low enough to obtain the desired frequency resolution and recorded the frequency.

Reduce the input voltage to specify extreme voltage variation ( $\pm 15\%$ ) and endpoint, record the maximum frequency change.

### 5.5.4. Test Setup

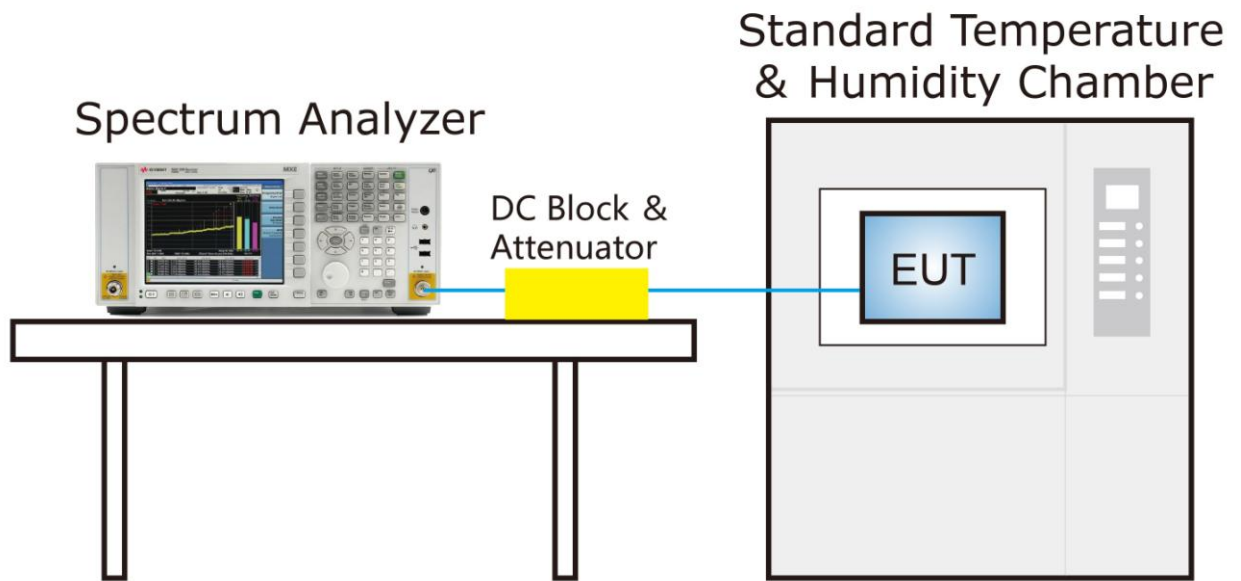



**5.5.5. Test Result**

Product	Flexi Zone 2400	Temperature	25°C
Test Engineer	Kevin Ker	Relative Humidity	54%
Test Site	SR2	Test Date	2019/04/10

Voltage (%)	Power (VAC)	Temp (°C)	Frequency Tolerance (ppm)			
			0 minutes	2 minutes	5 minutes	10 minutes
100%	120	- 30	-6.39	-4.89	-3.17	-2.66
		- 20	-5.34	-3.04	-1.31	0.50
		- 10	3.24	3.94	5.87	5.91
		0	2.59	2.86	3.55	4.95
		+ 10	4.24	5.49	7.77	6.87
		+ 20 (Ref)	3.58	5.44	7.20	7.67
		+ 30	3.55	5.22	6.91	7.74
		+ 40	6.23	6.52	8.25	7.63
		+ 50	5.29	6.58	6.46	5.25
115%	138	+ 20	5.12	6.73	6.93	7.06
85%	102	+ 20	5.92	8.33	6.79	5.19

## 5.6. Band Edge Measurement

### 5.6.1. Test Limit

Emissions below 2483.5 MHz are attenuated below the transmitter power (P) measured in watts by a factor of at least  $40 + 10 \log (P)$  dB at the channel edge at 2483.5 MHz,  $43 + 10 \log (P)$  dB at 5 MHz from the channel edge, and  $55 + 10 \log (P)$  dB at X MHz from the channel edge where X is the greater of 6 MHz or the actual emission bandwidth.

Emissions above 2495 MHz are attenuated below the transmitter power (P) measured in watts by a factor of at least  $43 + 10 \log (P)$  dB on all frequencies between the channel edge at 2495 MHz and X MHz from this channel edge and  $55 + 10 \log (P)$  dB on all frequencies more than X MHz from this channel edge, where X is the greater of 6 MHz or the actual emission bandwidth.

Note:

This device can be implement MIMO function, so the limit of spurious emissions needs to be reduced by  $10 \cdot \log(\text{Numbers}_{\text{Ant}})$  according to FCC KDB 662911 D01 guidance.

Eg.: The limit is adjusted to  $40 + 10 \log (P)$  dB -  $10 \cdot \log(2) = -13$  dBm

### 5.6.2. Test Procedure Used

KDB 971168 D01v03r01 - Section 6.1

ANSI C63.26-2015 - Section 5.7

### 5.6.3. Test Setting

1. Set the analyzer frequency to low or high channel.
2. RBW = 100kHz
3. VBW  $\geq 3 \cdot$ RBW
4. Sweep time = auto
5. Detector = power averaging (rms)
6. Set sweep trigger to "free run."
7. Trace average at least 100 traces in power averaging (rms) mode if sweep is set to auto-couple.

To accurately determine the average power over the on and off time of the transmitter, it can be necessary to increase the number of traces to be averaged above 100, or if using a manually configured sweep time, increase the sweep time.

### 5.6.4. Test Setup

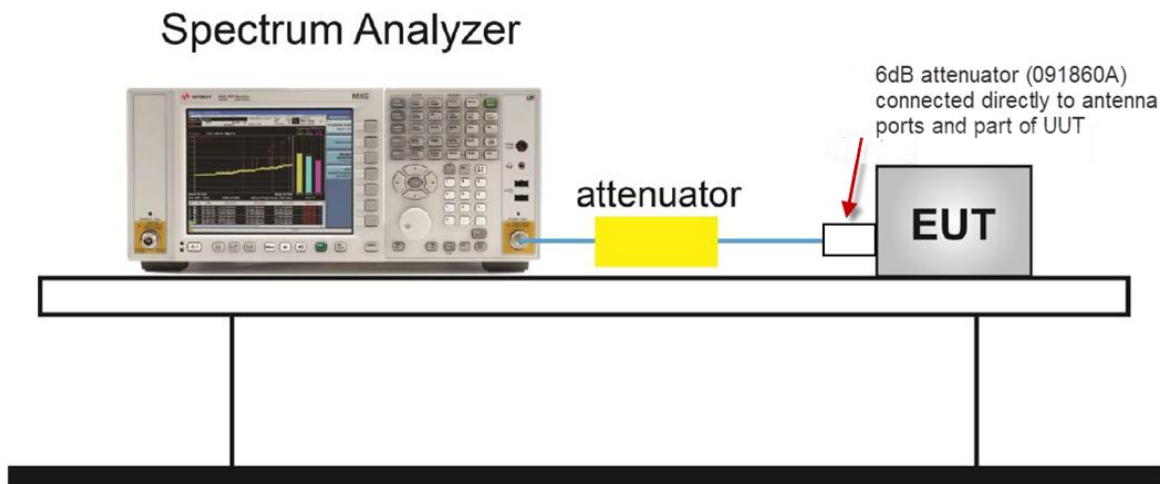

**5.6.5. Test Result**

Product	Flexi Zone 2400	Temperature	25°C
Test Engineer	Kevin Ker	Relative Humidity	54%
Test Site	SR2	Test Date	2019/04/14

Test Mode	Modulation	Frequency (MHz)	Max Band Edge (dBm)		Limit (dBm)	Result
			Chain D	Chain M		
Band 53	16QAM	2488.5	-39.90	-37.48	≤ -13.00	Pass
		2490.0	-35.89	-33.45	≤ -16.00	Pass

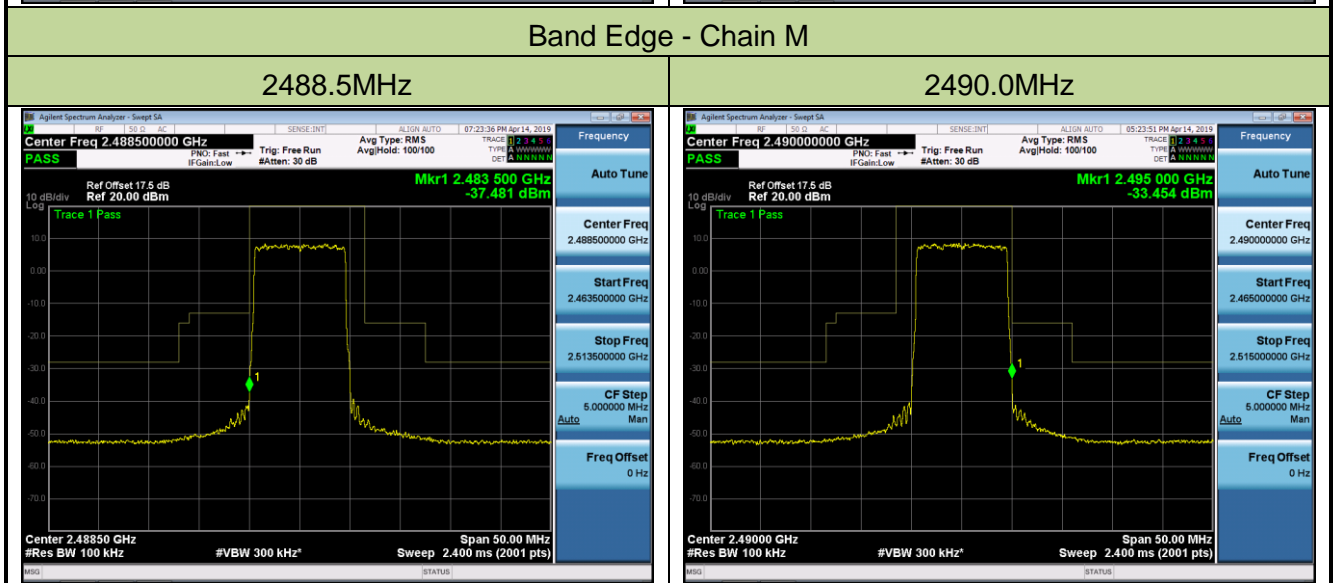
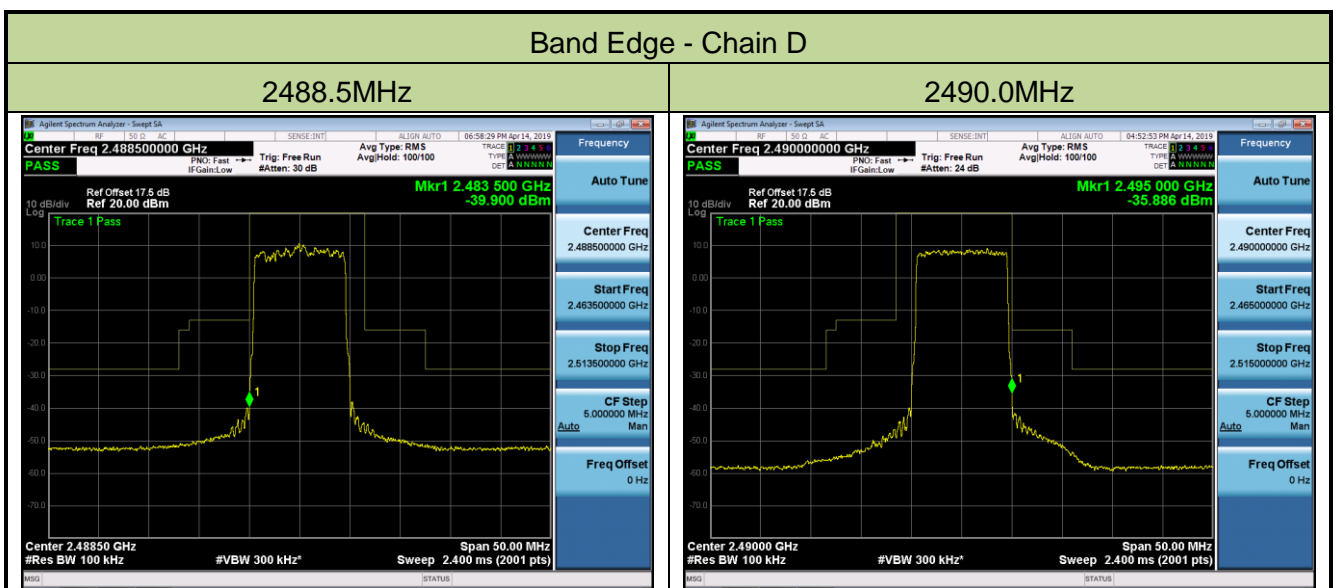

## 5.7. Conducted Spurious Emissions Measurement

### 5.7.1. Test Limit

Emissions below 2483.5 MHz are attenuated below the transmitter power (P) measured in watts by a factor of at least  $40 + 10 \log (P)$  dB at the channel edge at 2483.5 MHz,  $43 + 10 \log (P)$  dB at 5 MHz from the channel edge, and  $55 + 10 \log (P)$  dB at X MHz from the channel edge where X is the greater of 6 MHz or the actual emission bandwidth.

Emissions above 2495 MHz are attenuated below the transmitter power (P) measured in watts by a factor of at least  $43 + 10 \log (P)$  dB on all frequencies between the channel edge at 2495 MHz and X MHz from this channel edge and  $55 + 10 \log (P)$  dB on all frequencies more than X MHz from this channel edge, where X is the greater of 6 MHz or the actual emission bandwidth.

Note:

This device can be implement MIMO function, so the limit of spurious emissions needs to be reduced by  $10 \cdot \log(\text{Numbers}_{\text{Ant}})$  according to FCC KDB 662911 D01 guidance.

Eg.: The limit is adjusted to  $55 + 10 \log (P)$  dB -  $10 \cdot \log(2) = -28$  dBm

### 5.7.2. Test Procedure Used

KDB 971168 D01v03r01 - Section 6.1

ANSI C63.26-2015 - Section 5.7

### 5.7.3. Test Setting

1. Set the analyzer frequency to low or high channel.
2. RBW = 100kHz or 1MHz
3. VBW  $\geq 3 \cdot$ RBW
4. Sweep time = auto
5. Detector = power averaging (rms)
6. Set sweep trigger to "free run."
7. Trace average at least 100 traces in power averaging (rms) mode if sweep is set to auto-couple.

To accurately determine the average power over the on and off time of the transmitter, it can be necessary to increase the number of traces to be averaged above 100, or if using a manually configured sweep time, increase the sweep time.

### 5.7.4. Test Setup

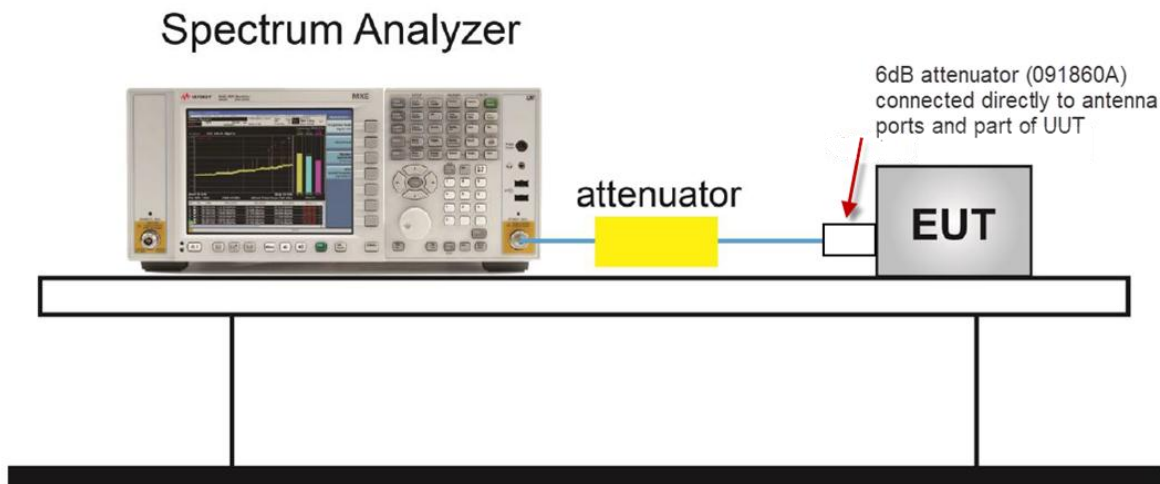

**5.7.5. Test Result**

Product	Flexi Zone 2400	Temperature	25°C
Test Engineer	Kevin Ker	Relative Humidity	54%
Test Site	SR2	Test Date	2019/04/14

Test Mode	Modulation	Frequency (MHz)	Conducted Spurious Emissions (dBm)		Limit (dBm)	Result
			Chain D	Chain M		
9kHz ~ 1GHz						
Band 53	16QAM	2488.5	-60.14	-59.64	≤ -28.00	Pass
		2489.0	-60.04	-59.94	≤ -28.00	Pass
		2490.0	-59.99	-54.08	≤ -28.00	Pass
1GHz ~ 26.5GHz						
Band 53	16QAM	2488.5	-35.29	-34.88	≤ -28.00	Pass
		2489.0	-34.81	-35.05	≤ -28.00	Pass
		2490.0	-35.31	-35.63	≤ -28.00	Pass

### Conducted Spurious Emissions - Chain D

2488.5MHz (9kHz ~ 1GHz)

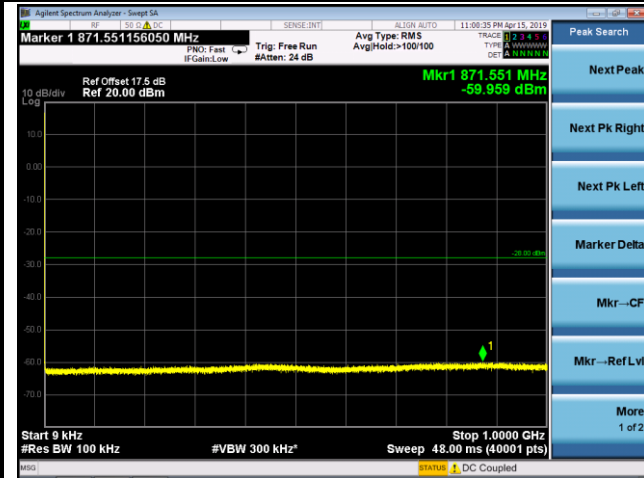

2488.5MHz (1GHz ~ 26.5GHz)



2489.0MHz (9kHz ~ 1GHz)

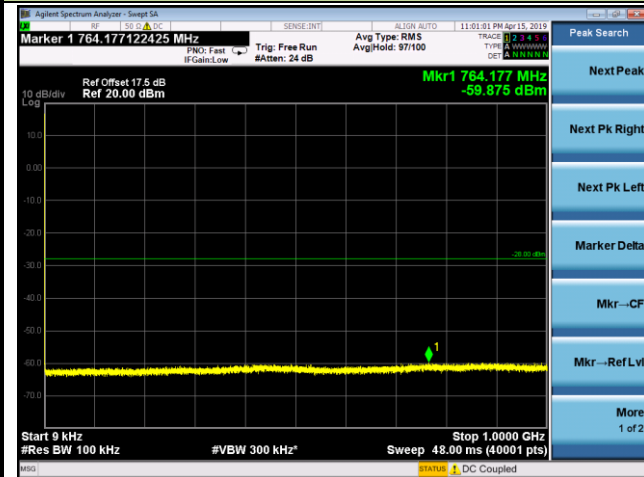

2489.0MHz (1GHz ~ 26.5GHz)



2490.0MHz (9kHz ~ 1GHz)

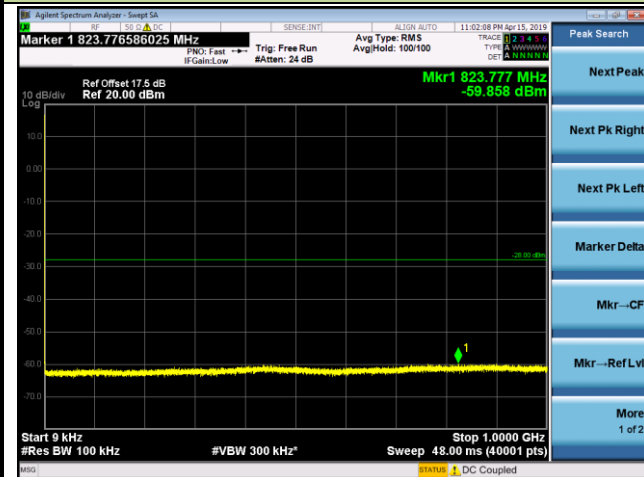

2490.0MHz (1GHz ~ 26.5GHz)





Conducted Spurious Emissions - Chain M

2488.5MHz (9kHz ~ 1GHz)

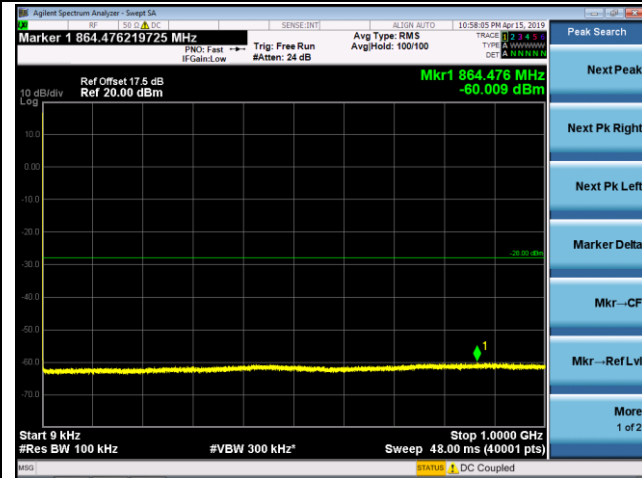

2488.5MHz (1GHz ~ 26.5GHz)



2489.0MHz (9kHz ~ 1GHz)

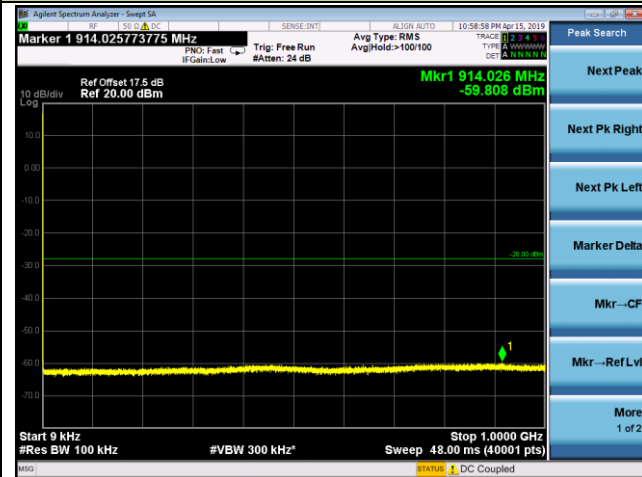

2489.0MHz (1GHz ~ 26.5GHz)



2490.0MHz (9kHz ~ 1GHz)

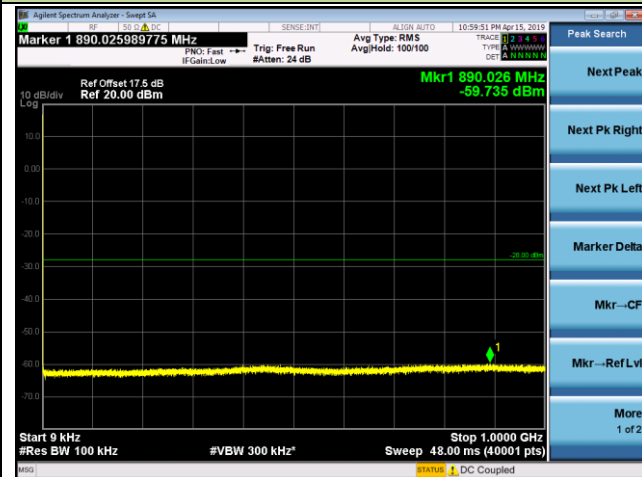

2490.0MHz (1GHz ~ 26.5GHz)

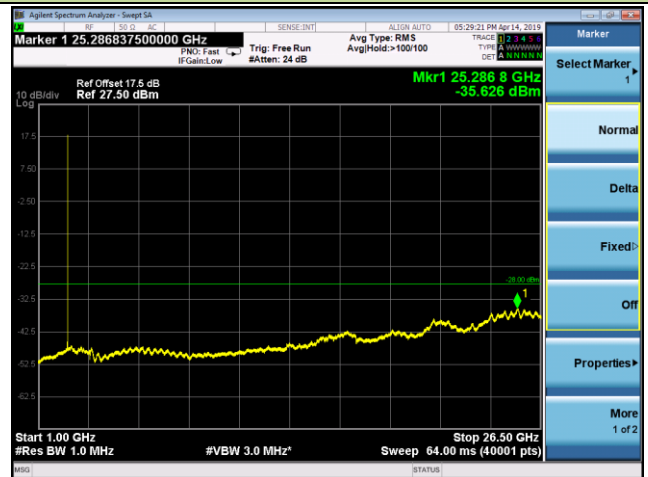

## **5.8. Radiated Spurious Emissions Measurement**

### **5.8.1. Test Limit**

Emissions below 2483.5 MHz are attenuated below the transmitter power (P) measured in watts by a factor of at least  $40 + 10 \log (P)$  dB at the channel edge at 2483.5 MHz,  $43 + 10 \log (P)$  dB at 5 MHz from the channel edge, and  $55 + 10 \log (P)$  dB at X MHz from the channel edge where X is the greater of 6 MHz or the actual emission bandwidth.

Emissions above 2495 MHz are attenuated below the transmitter power (P) measured in watts by a factor of at least  $43 + 10 \log (P)$  dB on all frequencies between the channel edge at 2495 MHz and X MHz from this channel edge and  $55 + 10 \log (P)$  dB on all frequencies more than X MHz from this channel edge, where X is the greater of 6 MHz or the actual emission bandwidth.

### **5.8.2. Test Procedure Used**

KDB 971168 D01v03r01 - Section 5.8

ANSI C63.26-2015 - Section 5.2.7

### **5.8.3. Test Setting**

1. RBW = 100kHz or 1MHz
2. VBW  $\geq 3 \times$  RBW
3. Sweep time = auto
4. Detector = power averaging (rms)
5. Set sweep trigger to "free run."
6. Trace average at least 100 traces in power averaging (rms) mode if sweep is set to auto-couple.

To accurately determine the average power over the on and off time of the transmitter, it can be necessary to increase the number of traces to be averaged above 100, or if using a manually configured sweep time, increase the sweep time

7. The trace was allowed to stabilize

### 5.8.4. Test Setup

#### Below 1GHz Test Setup:

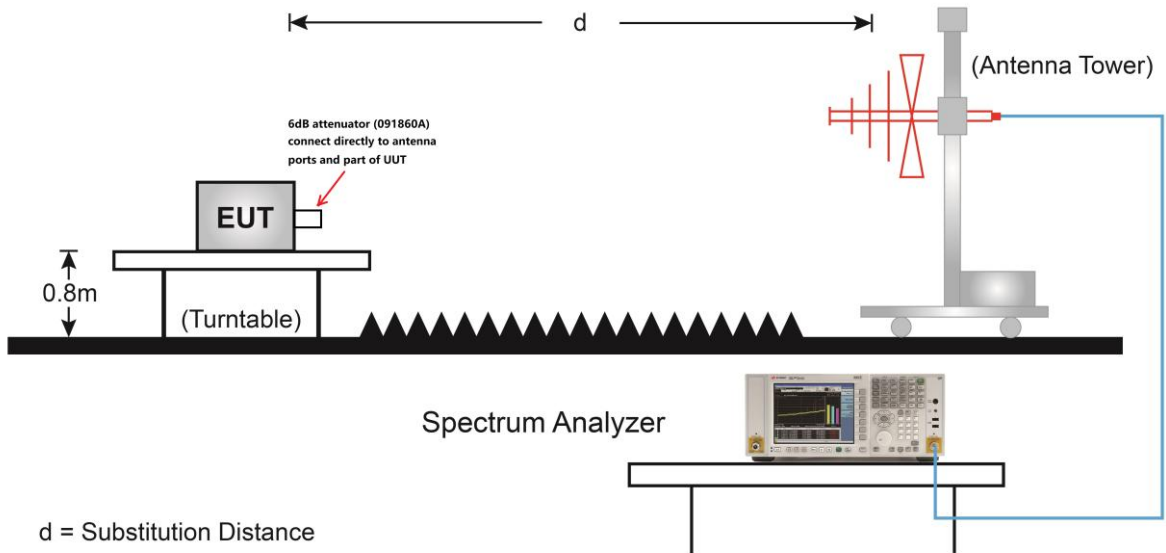

#### Above 1GHz Test Setup:

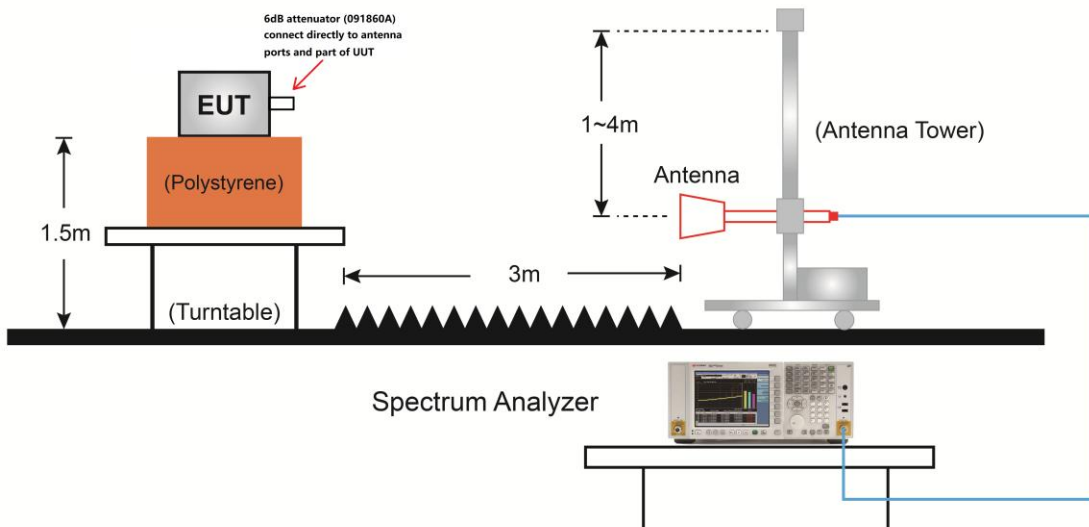

### 5.8.5. Test Result

Product	Flexi Zone 2400	Temperature	25°C
Test Engineer	Kevin Ker	Relative Humidity	54%
Test Site	AC1	Test Date	2019/04/14

Frequency (MHz)	Ant. Pol. (H/V)	SG Reading (dBm)	Cable Loss (dB)	Substitute Antenna Gain (dBi)	EIRP (dBm)	Limit (dBm)	Margin (dB)
<b>2488.5MHz</b>							
166.8	H	-69.8	0.2	-0.2	-70.2	-28.0	-42.2
215.3	H	-69.3	0.2	-2.8	-72.3	-28.0	-44.3
4978.0	H	-66.5	1.1	12.6	-55.0	-28.0	-27.0
7465.5	H	-60.7	1.3	11.2	-50.8	-28.0	-22.8
31.0	V	-61.2	0.1	0.1	-61.2	-28.0	-33.2
100.3	V	-60.9	0.1	0.9	-60.1	-28.0	-32.1
4969.5	V	-65.6	1.1	12.6	-54.1	-28.0	-26.1
7465.5	V	-61.1	1.3	11.2	-51.2	-28.0	-23.2
<b>2489.0MHz</b>							
210.9	H	-65.4	0.2	-2.7	-68.3	-28.0	-40.3
749.3	H	-69.2	0.4	0.7	-68.9	-28.0	-40.9
4978.0	H	-62.1	1.1	12.6	-50.6	-28.0	-22.6
7467.0	H	-59.8	1.3	11.2	-49.9	-28.0	-21.9
30.0	V	-60.6	0.1	0.6	-60.1	-28.0	-32.1
89.7	V	-59.3	0.1	-2.5	-61.9	-28.0	-33.9
4978.0	V	-63.2	1.1	12.6	-51.7	-28.0	-23.7
7467.0	V	-60.1	1.3	11.2	-50.2	-28.0	-22.2
<b>2490.0MHz</b>							
167.7	H	-68.0	0.2	-0.4	-68.6	-28.0	-40.6
211.4	H	-66.4	0.2	-2.7	-69.3	-28.0	-41.3
4986.5	H	-65.8	1.1	12.6	-54.3	-28.0	-26.3
7470.0	H	-60.8	1.3	11.2	-50.9	-28.0	-22.9
31.0	V	-62.3	0.1	0.1	-62.3	-28.0	-34.3
100.3	V	-60.6	0.1	-2.9	-63.6	-28.0	-35.6
4978.0	V	-65.7	1.1	12.6	-54.2	-28.0	-26.2
7470.0	V	-60.1	1.3	11.2	-50.2	-28.0	-22.2

Note: EIRP (dBm) = SG Reading (dBm) - Cable Loss (dB) + Substitute Antenna Gain (dBi)

## 6. CONCLUSION

The data collected relate only the item(s) tested and show that the **Flexi Zone 2400, FCC ID: 2AD8UFZMFWH201** is in compliance with Part 25 of the FCC Rules.

\_\_\_\_\_ The End \_\_\_\_\_