

MEASUREMENT REPORT

FCC PART 15 Subpart E WLAN 802.11a/n/ac

FCC ID: 2AD8UFZCWO4A1

APPLICANT: Nokia Solutions and Networks

Application Type: Certification

Product: Wi-Fi AP 4X4 OD ext. antenna US;
Wi-Fi AP 4x4 OD omni antenna US;
Wi-Fi AP 4x4 OD direct. antenna US

Model No.: WO4A-AC400, WO4B-AC400, WO4C-AC400

Brand Name: Nokia

FCC Classification: Unlicensed National Information Infrastructure (UNII)

FCC Rule Part(s): Part 15 Subpart E (Section 15.407)

Test Procedure(s): ANSI C63.10-2013, KDB 789033 D02v01r03,
KDB 662911 D01v02r01, KDB 644545 D03v01

Test Date: July 28 ~ December 10, 2016

Reviewed By : Paddy Chen
(Paddy Chen)

Approved By : Chenz Ker
(Chenz Ker)



The test results relate only to the samples tested.

This equipment has been shown to be capable of compliance with the applicable technical standards as indicated in the measurement report and was tested in accordance with the measurement procedures specified in KDB 789033 D02v01r03. Test results reported herein relate only to the item(s) tested.

The test report shall not be reproduced except in full without the written approval of MRT Technology (Taiwan) Co., Ltd.

Revision History

Report No.	Version	Description	Issue Date	Note
1608TW0110-U2	Rev. 01	Initial report	03-02-2017	Invalid
1608TW0110-U2	Rev. 02	Added the connector type of each antenna	03-13-2017	Valid

CONTENTS

Description	Page
§2.1033 General Information.....	6
1. INTRODUCTION	7
1.1. Scope	7
1.2. MRT Test Location	7
2. PRODUCT INFORMATION.....	8
2.1. Equipment Description	8
2.2. Operation Frequencies and Channel List.....	10
2.3. Description of Available Antennas	11
2.4. Description of Antenna RF Port.....	15
2.5. Test Mode	15
2.6. Test Software.....	15
2.7. Device Capabilities.....	16
2.8. Test Configuration	16
2.9. EMI Suppression Device(s)/Modifications.....	16
2.10. Labeling Requirements	16
3. DESCRIPTION OF TEST	17
3.1. Evaluation Procedure	17
3.2. AC Line Conducted Emissions.....	17
3.3. Radiated Emissions.....	18
4. ANTENNA REQUIREMENTS	19
5. TEST EQUIPMENT CALIBRATION DATE	20
6. MEASUREMENT UNCERTAINTY	21
7. TEST RESULT	22
7.1. Summary	22
7.2. 26dB Bandwidth Measurement	37
7.2.1. Test Limit	37
7.2.2. Test Procedure used	37
7.2.3. Test Setting.....	37
7.2.4. Test Setup	37
7.2.5. Test Result.....	37
7.3. 6dB Bandwidth Measurement	38
7.3.1. Test Limit	38
7.3.2. Test Procedure used	38

7.3.3. Test Setting.....	38
7.3.4. Test Setup	38
7.3.5. Test Result.....	38
7.4. Output Power Measurement	39
7.4.1. Test Limit	39
7.4.2. Test Procedure Used.....	39
7.4.3. Test Setting.....	39
7.4.4. Test Setup	39
7.4.5. Test Rate Assessment.....	40
7.4.6. Test Result.....	43
7.5. Transmit Power Control.....	44
7.5.1. Test Limit	44
7.5.2. Test Procedure Used.....	44
7.5.3. Test Setting.....	44
7.5.4. Test Setup	44
7.5.5. Test Result.....	44
7.6. Power Spectral Density Measurement	45
7.6.1. Test Limit	45
7.6.2. Test Procedure Used.....	45
7.6.3. Test Setting.....	45
7.6.4. Test Setup	46
7.6.5. Test Result.....	46
7.7. Frequency Stability Measurement	47
7.7.1. Test Limit	47
7.7.2. Test Procedure Used.....	47
7.7.3. Test Setup	47
7.7.4. Test Result.....	48
7.8. Radiated Spurious Emission Measurement	49
7.8.1. Test Limit	49
7.8.2. Test Procedure Used.....	49
7.8.3. Test Setting.....	49
7.8.4. Test Setup	51
7.8.5. Test Result.....	52
7.9. Radiated Restricted Band Edge Measurement	53
7.9.1. Test Limit	53
7.9.2. Test Result.....	55
7.10. AC Conducted Emissions Measurement.....	56
7.10.1. Test Limit	56
7.10.2. Test Procedure	56

7.10.3. Test Setup	57
7.10.4. Test Result.....	58
8. CONCLUSION.....	60
Annex A.....	26dB & 6dB Bandwidth Test Result
Annex B.....	Maximum Conducted Output Power Test Result
Annex C.....	Power Spectral Density Test Result
Annex D.....	Radiated Spurious Emission Test Result
Annex E.....	Radiated Bandedge Test Result

§2.1033 General Information

Applicant:	Nokia Solutions and Networks
Applicant Address:	Karaportti 3, FI-02610 Espoo, Finland
Manufacturer:	Nokia Solutions and Networks
Manufacturer Address:	Karaportti 3, FI-02610 Espoo, Finland
Test Site:	MRT Technology (Taiwan) Co., Ltd
Test Site Address:	No. 38, Fuxing Second Rd., Guishan Dist., Taoyuan City 333, Taiwan (R.O.C)
MRT FCC Registration No.:	153292
FCC Rule Part(s):	Part 15 Subpart E (Section 15.407)
Model No.:	WO4A-AC400, WO4B-AC400, WO4C-AC400
Test Device Serial No.:	N/A <input type="checkbox"/> Production <input checked="" type="checkbox"/> Pre-Production <input type="checkbox"/> Engineering
FCC Classification:	Unlicensed National Information Infrastructure (UNII)

Test Facility / Accreditations

Measurements were performed at MRT Laboratory located in Fuxing Rd., Taoyuan, Taiwan (R.O.C)

- MRT facility is a FCC registered (Reg. No. 153292) test facility with the site description report on file and is designated by the FCC as an Accredited Test Film.
- MRT facility is an IC registered (MRT Reg. No. 21723-1) test laboratory with the site description on file at Industry Canada.
- MRT Lab is accredited to ISO 17025 by the American Association for Laboratory Accreditation (TAF) under the American Association for Laboratory Accreditation Program (TAF Cert. No. 3261) in EMC, Telecommunications and Radio testing for FCC, Industry Taiwan, EU and TELEC Rules.

1. INTRODUCTION

1.1. Scope

Measurement and determination of electromagnetic emissions (EMC) of radio frequency devices including intentional and/or unintentional radiators for compliance with the technical rules and regulations of the Federal Communications Commission and the Industry Canada Certification and Engineering Bureau.

1.2. MRT Test Location

The map below shows the location of the MRT LABORATORY, its proximity to the Taoyuan City. These measurement tests were conducted at the MRT Technology (Taiwan) Co., Ltd. Facility located at No.38, Fuxing 2nd Rd., Guishan Dist., Taoyuan City 33377, Taiwan (R.O.C).

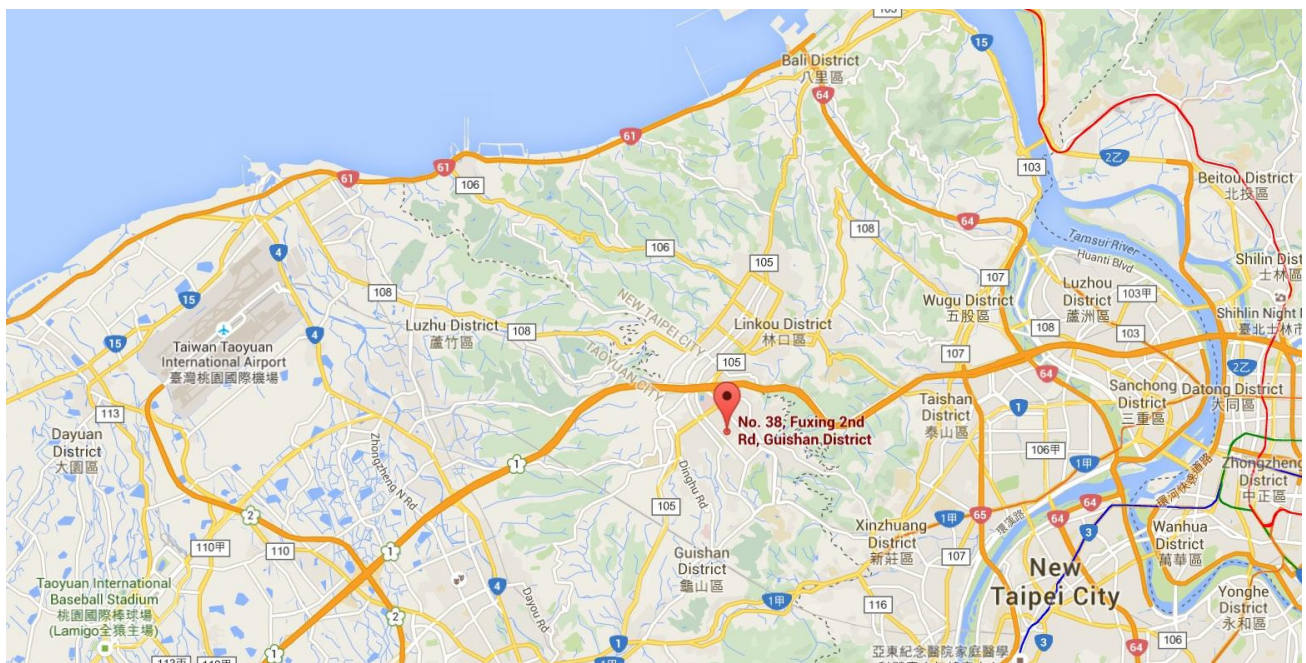

2. PRODUCT INFORMATION

2.1. Equipment Description

Product Name	Wi-Fi AP 4X4 OD ext. antenna US; Wi-Fi AP 4x4 OD omni antenna US; Wi-Fi AP 4x4 OD direct. antenna US
Model No.	WO4A-AC400, WO4B-AC400, WO4C-AC400
Brand Name	Nokia
Hardware Version:	AM3
Frequency Range	<p><u>2.4GHz:</u> For 802.11b/g/n-HT20: 2412 ~ 2462 MHz For 802.11n-HT40: 2422 ~ 2452 MHz</p> <p><u>5GHz:</u> For 802.11a/n-HT20/ac-VHT20 5180~5240MHz, 5745~5825MHz For 802.11n-HT40/ac-VHT40: 5190~5230MHz, 5755~5795MHz For 802.11ac-VHT80: 5210MHz, 5775MHz For 802.11ac-VHT80+80: 5210 MHz + 5775 MHz</p>
Maximum Output Power	<p><u>CDD Mode:</u> 802.11a: 26.29dBm</p> <p><u>Beam-Forming Mode:</u> 802.11n-HT20: 26.09dBm, 802.11n-HT40: 25.98dBm, 802.11ac-VHT20: 26.18dBm, 802.11ac-VHT40: 26.00dBm, 802.11ac-VHT80: 21.15dBm 802.11ac-VHT80+80: 5210MHz - 22.00dBm, 5775MHz - 19.01dBm</p>
Modulation Type	16QAM, 64QAM, QPSK, BPSK for OFDM 802.11a/n/ac: OFDM

Note 1: We select the POE adapter (M/N: PoE35-54A) to perform all RF testing.

Note 2: The change of the measured voltage at the radio part of the EUT is below $\pm 1\%$, when input voltage from external power supply to the equipment under test, thus the RF items are tested with AC adapter only.

Note 3: The model difference as below:

- when the device has been connected the Galtronics Omni antenna, the model number is "WO4A-AC400";

- when the device has been connected the Galtronics Directional antenna, the model number is “WO4B-AC400”;
- when the device has been connected the PCTEL antenna & HUBER+SUHNER, the model number is “WO4C-AC400”;

2.2. Operation Frequencies and Channel List

802.11a/n-HT20/ ac-VHT20

Channel	Frequency	Channel	Frequency	Channel	Frequency
36	5180 MHz	40	5200 MHz	44	5220 MHz
48	5240 MHz	149	5745 MHz	153	5765 MHz
157	5785 MHz	161	5805 MHz	165	5825 MHz

802.11n-HT40/ ac-VHT40

Channel	Frequency	Channel	Frequency	Channel	Frequency
38	5190 MHz	46	5230 MHz	151	5755 MHz
159	5795 MHz	--	--	--	--







802.11ac-VHT80

Channel	Frequency	Channel	Frequency	Channel	Frequency
42	5210 MHz	155	5775 MHz	--	--

802.11ac-VHT80+80

Channel	Frequency	Channel	Frequency
42 + 155	5210 MHz + 5775 MHz	--	--

2.3. Description of Available Antennas

Antenna	Manufacturer	Frequency Band (GHz)	Product Number	Tx Paths
	PCTEL, Inc.	2.4	FPMI2458-DP4RPSMA	4
		5		4
		2.4	FPMI2458-DP2RPSMA	2
		5		2
	Galtronics	2.4	Galtronics Omni Antenna	2
		5		2
		2.4	Galtronics Directional Antenna	2
		5		2
	HUBER+SUHNER	5	Sector-Antenna 1356.17.0011	1
		5	Directional Antenna 1356.17.0077	1

Note 1: This device make the transmission with two “FPMI2458-DP2RPSMA” directional antenna, there is not any superposition of transmit signal between two antennas.

Note 2: For “FPMI2458-DP2RPSMA” directional antenna, one antenna port be connected with device’s Ant 0 & Ant 1, the other antenna port be connect with device’s Ant 2 & Ant 3, and this installation has been showed in the professional installation manual.

Note 3: For HUBER+SUHNER antenna, this device make the transmission with four antenna, they were installed by the four sides of the perpendicular. So the antenna was Independent of each other and had no MIMO, CDD or Beamforming mode.



Product Number	Frequency Band (MHz)	Tx Paths	Per Chain Max Antenna Gain (dBi)				Beam Forming Directional Gain (dBi)	CDD Directional Gain (dBi)
			Ant 0	Ant 1	Ant 2	Ant 3		
FPMI2458- DP4RPSMA	2412 ~2462	4	6.70	6.40	6.80	6.80	12.70	12.70
	5150 ~ 5250	4	5.79	5.57	5.89	5.05	11.60	11.60
	5150 ~ 5250 30°elevation angle	4	5.10	2.27	4.94	4.06	N/A	N/A
	5725 ~ 5850	4	5.24	5.09	6.73	5.62	11.71	11.71
FPMI2458- DP2RPSMA	2412 ~2462	2	6.70	6.40	--	--	9.56	9.56
			--	--	6.70	6.40	9.56	9.56
	5150 ~ 5250	2	5.79	5.57	--	--	8.69	8.69
			--	--	5.79	5.57	8.69	8.69
	5150 ~ 5250 30°elevation angle	2	5.10	2.27	--	--	N/A	N/A
			--	--	5.10	2.27	N/A	N/A
	5725 ~ 5850	2	5.24	5.09	--	--	8.18	8.18
			--	--	5.24	5.09	8.18	8.18

Product Number	Frequency Band (MHz)	Tx Paths	Per Chain Max Antenna Gain (dBi)				Beam Forming Directional Gain (dBi)	CDD Directional Gain (dBi)
			Ant 0	Ant 1	Ant 2	Ant 3		
Galtronics Omni Antenna	2412 ~2462	2	2.93	3.02	2.93	3.02	9.00	9.00
	5150 ~ 5250	2	6.68	6.53	6.68	6.53	12.63	12.63
	5150 ~ 5250 30°elevation angle	2	-1.32	-1.53	-1.32	-1.53	N/A	N/A
	5725 ~ 5850	2	6.78	6.55	6.78	6.55	12.69	12.69
Galtronics Directional Antenna	2412 ~2462	2	6.75	6.75	6.75	6.75	12.77	12.77
	5150 ~ 5250	2	8.39	8.16	8.39	8.16	14.30	14.30
	5150 ~ 5250 30°elevation angle	2	-1.54	-2.86	-1.54	-2.86	N/A	N/A
	5725 ~ 5850	2	8.92	8.82	8.92	8.82	14.89	14.89

Product Number	Frequency Band (MHz)	Tx Paths	Per Chain Max Antenna Gain (dBi)				Beam Forming Directional Gain (dBi)	CDD Directional Gain (dBi)
			Ant 0	Ant 1	Ant 2	Ant 3		
Sector-Antenna 1356.17.0011	5150 ~ 5250	1	16.00	16.00	16.00	16.00	N/A	N/A
	5150 ~ 5250 30°elevation angle	1	-1.22	-1.22	-1.22	-1.22	N/A	N/A
	5725 ~ 5850	1	17.00	17.00	17.00	17.00	N/A	N/A
Directional Antenna 1356.17.0077	5150 ~ 5250	1	14.00	14.00	14.00	14.00	N/A	N/A
	5150 ~ 5250 30°elevation angle	1	1.52	1.52	1.52	1.52	N/A	N/A
	5725 ~ 5850	1	14.00	14.00	14.00	14.00	N/A	N/A

Note

- The EUT supports Cyclic Delay Diversity (CDD) technology for 802.11a/b/g mode, and CDD signals are correlated.
- The EUT supports Beam Forming technology for 802.11n/ac mode, and exclude 802.11b/g mode. Correlated signals include, but are not limited to, signals transmitted in any of the following modes:
 - Any transmit Beam Forming mode, whether fixed or adaptive (e.g., phased array modes, closed loop MIMO modes, Transmitter Adaptive Antenna modes, Maximum Ratio Transmission (MRT) modes, and Statistical Eigen Beam Forming (EBF) modes).
 - CDD signals are correlated and create unintended array gain that varies with signal bandwidth, antenna geometry, and cyclic delay values. Consequently, depending on system parameters, it may be appropriate to use different values of array gain for compliance with power limits versus compliance with powerspectral density limits.
- Unequal Antenna gains, with equal transmit powers. For Antenna gains given by G_1, G_2, \dots, G_N dBi transmit signals are correlated, then
 - Directional gain = $10 \cdot \log[(10^{G_1/20} + 10^{G_2/20} + \dots + 10^{G_N/20})^2 / N_{ANT}]$ dBi [Note the “20”s in the denominator of each exponent and the square of the sum of terms; the object is to combine the signal levels coherently.]
 - For example (FPMI2458-DP4RPSMA Antenna): 5150 ~ 5250MHz Directional Gain = $10 \cdot \log[(10^{5.79/20} + 10^{5.57/20} + 10^{5.89/20} + 10^{5.05/20})^2 / 4] = 11.60$ dBi

2.4. Description of Antenna RF Port

Antenna RF Port								
---	2.4GHz RF Port				5GHz RF Port			
Software Control Port	Ant 0	Ant 1	Ant 2	Ant 3	Ant 0	Ant 1	Ant 2	Ant 3

2.5. Test Mode

Test Mode	Mode 1: Transmit by 802.11a
	Mode 2: Transmit by 802.11n-HT20
	Mode 3: Transmit by 802.11n-HT40
	Mode 4: Transmit by 802.11ac-VHT20
	Mode 5: Transmit by 802.11ac-VHT40
	Mode 6: Transmit by 802.11ac-VHT80
	Mode 7: Transmit by 802.11ac-VHT80+80

2.6. Test Software

The test utility software used during testing was “QCARCT 3.0.174.0”.

2.7. Device Capabilities

This device contains the following capabilities:

2.4GHz WLAN (DTS) and 5GHz WLAN (NII).

Note: 5GHz (NII) operation is possible in 20MHz, 40MHz and 80MHz channel bandwidths. The maximum achievable duty cycles for all modes were determined based on measurements performed on a spectrum analyzer in zero-span mode with RBW = 8MHz, VBW = 50MHz, and detector = average per the guidance of Section B)2)b) of KDB 789033 D02v01r03. The RBW and VBW were both greater than $50/T$, where T is the minimum transmission duration, and the number of sweep points across T was greater than 100. The duty cycles are as follows:

Test Mode	Duty Cycle
802.11a	97.18 %
802.11n-HT20	98.81 %
802.11n-HT40	97.55 %
802.11ac-VHT20	98.82 %
802.11ac-VHT40	97.40 %
802.11ac-VHT80	94.30 %
802.11ac-VHT80+80	94.30 %

2.8. Test Configuration

The **US Wi-Fi AP 4X4 OD ext. antenna FCC ID: 2AD8UFZCWO4A1** was tested per the guidance of KDB 789033 D02v01r03. ANSI C63.10-2013 was used to reference the appropriate EUT setup for radiated spurious emissions testing and AC line conducted testing.

2.9. EMI Suppression Device(s)/Modifications

No EMI suppression device(s) were added and/or no modifications were made during testing.

2.10. Labeling Requirements

Per 2.1074 & 15.19; Docket 95-19

The label shall be permanently affixed at a conspicuous location on the device; instruction manual or pamphlet supplied to the user and be readily visible to the purchaser at the time of purchase.

However, when the device is so small wherein placement of the label with specified statement is not practical, only the FCC ID must be displayed on the device per Section 15.19(a)(5). Please see attachment for FCC ID label and label location.

3. DESCRIPTION OF TEST

3.1. Evaluation Procedure

The measurement procedures described in the American National Standard for Testing Unlicensed Wireless Devices (ANSI C63.10-2013), and the guidance provided in KDB 789033 D02v01r03 were used in the measurement of the **US Wi-Fi AP 4X4 OD ext. antenna FCC ID: 2AD8UFZCWO4A1.**

Deviation from measurement procedure.....None

3.2. AC Line Conducted Emissions

The line-conducted facility is located inside an 8'x4'x4' shielded enclosure. A 1 m x 2m wooden table 80cm high is placed 40cm away from the vertical wall and 80cm away from the sidewall of the shielded room. Two 10kHz-30MHz, 50Ω/50uH Line-Impedance Stabilization Networks (LISNs) are bonded to the shielded room floor. Power to the LISNs is filtered by external high-current high-insertion loss power line filters. These filters attenuate ambient signal noise from entering the measurement lines. These filters are also bonded to the shielded enclosure.

The EUT is powered from one LISN and the support equipment is powered from the second LISN. All interconnecting cables more than 1 meter were shortened to a 1 meter length by non-inductive bundling (serpentine fashion) and draped over the back edge of the test table. All cables were at least 40cm above the horizontal reference ground-plane. Power cables for support equipment were routed down to the second LISN while ensuring that that cables were not draped over the second LISN.

Sufficient time for the EUT, support equipment, and test equipment was allowed in order for them to warm up to their normal operating condition. The RF output of the LISN was connected to the receiver and exploratory measurements were made to determine the frequencies producing the maximum emission from the EUT. The receiver was scanned from 150kHz to 30MHz. The detector function was set to peak mode for exploratory measurements while the bandwidth of the analyzer was set to 9kHz. The EUT, support equipment, and interconnecting cables were arranged and manipulated to maximize each emission. Each emission was also maximized by varying: power lines, the mode of operation or data exchange speed, or support equipment whichever determined the worst-case emission. Once the worst case emissions have been identified, the one EUT cable configuration/arrangement and mode of operation that produced these emissions are used for final measurements on the same test site. The analyzer is set to CISPR quasi-peak and average detectors with a 9kHz resolution bandwidth for final measurements.

An extension cord was used to connect to a single LISN which powered by EUT. The extension cord was calibrated with LISN, the impedance and insertion loss are compliance with the requirements as stated in ANSI C63.10-2013.

Line conducted emissions test results are shown in Section 7.10.

3.3. Radiated Emissions

The radiated test facilities consisted of an indoor 3 meter semi-anechoic chamber used for final measurements and exploratory measurements, when necessary. The measurement area is contained within the semi-anechoic chamber which is shielded from any ambient interference. For measurements above 1GHz absorbers are arranged on the floor between the turn table and the antenna mast in such a way so as to maximize the reduction of reflections. For measurements below 1GHz, the absorbers are removed. A turntable is used for radiated measurement. It is a continuously rotatable, remote controlled, metallic turntable and 2 meters (6.56 ft.) in diameter. The turn table is flush with the raised floor of the chamber in order to maintain its function as a ground plane. An 80cm high PVC support structure is placed on top of the turntable.

For all measurements, the spectrum was scanned through all EUT azimuths and from 1 to 4 meter receive antenna height using a broadband antenna from 30MHz up to the upper frequency shown in 15.33(b)(1) depending on the highest frequency generated or used in the device or on which the device operates or tunes. For frequencies above 1GHz, linearly polarized double ridge horn antennas were used. For frequencies below 30MHz, a calibrated loop antenna was used. When exploratory measurements were necessary, they were performed at 1 meter test distance inside the semi-anechoic chamber using broadband antennas, broadband amplifiers, and spectrum analyzers to determine the frequencies and modes producing the maximum emissions. Sufficient time for the EUT, support equipment, and test equipment was allowed in order for them to warm up to their normal operating condition. The test set-up for frequencies below 1GHz was placed on top of the 0.8 meter high, 1 x 1.5 meter table; and test set-up for frequencies 1-40GHz was placed on top of the 1.5 meter high, 1 x 1.5 meter table. The EUT, support equipment, and interconnecting cables were arranged and manipulated to maximize each emission. Appropriate precaution was taken to ensure that all emissions from the EUT were maximized and investigated. The system configuration, clock speed, mode of operation or video resolution, if applicable, turntable azimuth, and receive antenna height was noted for each frequency found.

Final measurements were made in the semi-anechoic chamber using calibrated, linearly polarized broadband and horn antennas. The test setup was configured to the setup that produced the worst case emissions. The spectrum analyzer was set to investigate all frequencies required for testing to compare the highest radiated disturbances with respect to the specified limits. The turntable containing the EUT was rotated through 360 degrees and the height of the receive antenna was varied 1 to 4 meters and stopped at the azimuth and height producing the maximum emission. Each emission was maximized by changing the orientation of the EUT through three orthogonal planes and changing the polarity of the receive antenna, whichever produced the worst-case emissions. According to 3dB Beam-Width of horn antenna, the horn antenna should be always directed to the EUT when rising height.

4. ANTENNA REQUIREMENTS

Excerpt from §15.203 of the FCC Rules/Regulations:

“An intentional radiator antenna shall be designed to ensure that no antenna other than that furnished by the responsible party can be used with the device. The use of a permanently attached antenna or of an antenna that uses a unique coupling to the intentional radiator shall be considered sufficient to comply with the provisions of this section.”

- There are provisions for reverse connector to an external antenna.

The connector of each antenna as below:

FPMI2458-DP4RPSMA: reverse SMA connector.

FPMI2458-DP2RPSMA: reverse SMA connector.

Galtronics Omni Antenna: reverse SMA connector.

Galtronics Directional Antenna: reverse SMA connector.

Sector-Antenna 1356.17.0011: N Type connector

Directional Antenna 1356.17.007: N Type connector

Conclusion:

The **US Wi-Fi AP 4X4 OD ext. antenna FCC ID: 2AD8UFZCWO4A1** unit complies with the requirement of §15.203.

5. TEST EQUIPMENT CALIBRATION DATE

Conducted Emissions

Instrument	Manufacturer	Type No.	Asset No.	Cali. Interval	Cali. Due Date
EMI Test Receiver	R&S	ESR3	MRTTWA00045	1 year	2017/03/17
Two-Line V-Network	R&S	ENV216	MRTTWA00019	1 year	2017/03/23
Two-Line V-Network	R&S	ENV216	MRTTWA00020	1 year	2017/03/23
AC Power Source	T-power	TFC-1001	MRTTWA00030	N/A	N/A
Temperature/Humidity Meter	TFA	35.1078.10.IT	MRTTWA00033	1 year	2017/06/09

Radiated Emissions

Instrument	Manufacturer	Type No.	Asset No.	Cali. Interval	Cali. Due Date
Signal Analyzer	R&S	FSV40	MRTTWA00007	1 year	2017/03/02
EMI Test Receiver	R&S	ESR3	MRTTWA00009	1 year	2017/03/16
Broadband Preamplifier	SCHWARZBECK	BBV 9718	MRTTWA00005	1 year	2017/04/06
Broadband Amplifier	SCHWARZBECK	BBV 9721	MRTTWA00006	1 year	2017/04/06
Active Loop Antenna	SCHWARZBECK	FMZB 1519B	MRTTWA00002	1 year	2017/04/06
Broadband TRILOG Antenna	SCHWARZBECK	VULB 9162	MRTTWA00001	1 year	2017/04/06
Broadband Hornantenna	SCHWARZBECK	BBHA 9120D	MRTTWA00003	1 year	2017/04/06
Breitband Hornantenna	SCHWARZBECK	BBHA 9170	MRTTWA00004	1 year	2017/04/06
Temperature/Humidity Meter	TFA	35.1078.10.IT	MRTTWA00033	1 year	2017/06/09

Conducted Test Equipment

Instrument	Manufacturer	Type No.	Asset No.	Cali. Interval	Cali. Due Date
EXA Signal Analyzer	KEYSIGHT	N9010A	MRTTWA00012	1 year	2017/07/11
X-Series USB Peak and Average Power Sensor	KEYSIGHT	U2021XA	MRTTWA00014	1 year	2017/03/18
X-Series USB Peak and Average Power Sensor	KEYSIGHT	U2021XA	MRTTWA00015	1 year	2017/03/18
Programmable Temperature & Humidity Chamber	TEN BILLION	TTH-B3UP	MRTTWA00036	1 year	2017/05/11
Temperature/Humidity Meter	TFA	35.1078.10.IT	MRTTWA00033	1 year	2017/06/09

Software	Version	Function
EMI Software	V3	EMI Test Software

6. MEASUREMENT UNCERTAINTY

Where relevant, the following test uncertainty levels have been estimated for tests performed on the EUT as specified in CISPR 16-4-2. This uncertainty represents an expanded uncertainty expressed at approximately the 95% confidence level using a coverage factor of $k = 2$.

AC Conducted Emission Measurement
Measuring Uncertainty for a Level of Confidence of 95% ($U=2Uc(y)$): 150kHz~30MHz: 3.46dB
Radiated Emission Measurement
Measuring Uncertainty for a Level of Confidence of 95% ($U=2Uc(y)$): 9kHz ~ 1GHz: 4.18dB 1GHz ~ 40GHz: 4.76dB
Frequency Stability - TR3
Measuring Uncertainty for a Level of Confidence of 95% ($U=2Uc(y)$): 0.21%
Output Power - TR3
Measuring Uncertainty for a Level of Confidence of 95% ($U=2Uc(y)$): 1.13dB
Power Spectrum Density - TR3
Measuring Uncertainty for a Level of Confidence of 95% ($U=2Uc(y)$): 1.15dB
Occupied Bandwidth - TR3
Measuring Uncertainty for a Level of Confidence of 95% ($U=2Uc(y)$): 0.28%

7. TEST RESULT

7.1. Summary

Company Name: Nokia Solutions and Networks
FCC ID: 2AD8UFZCWO4A1
Model No.: WO4A-AC400, WO4B-AC400, WO4C-AC400
Data Rate(s) Tested: 6Mbps ~ 54Mbps (a):
6.5/7.2Mbps ~ 260/288.8Mbps (n-HT20):
13.5/15.0Mbps ~ 540/600Mbps (n-HT40):
6.5/7.2Mbps ~ 312/346.7Mbps (ac-VHT20MHz):
13.5/15.0Mbps ~ 720/800Mbps (ac-VHT40MHz):
29.3/32.5Mbps ~ 1560/1733.2Mbps (ac-VHT80MHz)
29.3/32.5Mbps ~ 780/866.6Mbps (ac-VHT80+80MHz BW)

FCC Section(s)	Test Description	Test Limit	Test Condition	Test Result	Reference
15.407(a)	26dB Bandwidth	N/A	Conducted	Pass	Section 7.2
15.407(e)	6dB Bandwidth	≥ 500kHz		Pass	Section 7.3
15.407(a)(1)(ii), (3)	Maximum Conducted Output Power	Refer to Section 7.5		Pass	Section 7.4
15.407(h)(1)	Transmit Power Control	≤ 24 dBm		N/A	Section 7.5
15.407(a)(1)(ii), (3), (5)	Power Spectral Density	Refer to Section 7.6		Pass	Section 7.6
15.407(g)	Frequency Stability	N/A		Pass	Section 7.7
15.407(b)(1), (4)	Undesirable Emissions	≤ -27dBm/MHz EIRP ≤ -17dBm/MHz EIRP	Radiated	Pass	Section 7.8 & 7.9
15.205, 15.209 15.407(b)(5), (6), (7)	General Field Strength Limits (Restricted Bands and Radiated Emission Limits)	Emissions in restricted bands must meet the radiated limits detailed in 15.209		Pass	
15.207	AC Conducted Emissions 150kHz - 30MHz	< FCC 15.207 limits	Line Conducted	Pass	Section 7.10

Notes:

- 1) All channels, modes, and modulations/data rates were investigated among all UNII bands. The test results shown in the following sections represent the worst case emissions.
- 2) The analyzer plots shown in this section were all taken with a correction table loaded into the analyzer. The correction table was used to account for the losses of the cables and attenuators used as part of the system to connect the EUT to the analyzer at all frequencies of interest.
- 3) Test Items “26dB Bandwidth”, “6dB Bandwidth” have been assessed SISO and MIMO transmission, and showed the worst test data in this report.

General Detail Test Summary

Mode	Ant Port	Frequency	Measurement	Limit	Margin	Refer Page
26dB Bandwidth Measurement						
802.11a	Ant 0	5825 MHz	23.70 MHz	N/A	N/A	Annex A, 6
802.11n-HT20	Ant 0	5825 MHz	22.40 MHz	N/A	N/A	Annex A, 7
802.11n-HT40	Ant 0	5795 MHz	59.93 MHz	N/A	N/A	Annex A, 8
802.11ac-VHT20	Ant 0	5825 MHz	22.96 MHz	N/A	N/A	Annex A, 9
802.11ac-VHT40	Ant 0	5795 MHz	52.68 MHz	N/A	N/A	Annex A, 10
802.11ac-VHT80	Ant 0	5775 MHz	85.19 MHz	N/A	N/A	Annex A, 11
802.11ac-VHT80+80	Ant 0	5210 MHz	86.24 MHz	N/A	N/A	Annex A, 29
	Ant 2	5775 MHz	87.86 MHz	N/A	N/A	Annex A, 29
6dB Bandwidth Measurement						
802.11a	Ant 3	5785 MHz	16.36 MHz	≥ 0.5 MHz	N/A	Annex A, 45
802.11n-HT20	Ant 0	5825 MHz	17.57 MHz	≥ 0.5 MHz	N/A	Annex A, 34
802.11n-HT40	Ant 2	5755 MHz	35.15 MHz	≥ 0.5 MHz	N/A	Annex A, 42
802.11ac-VHT20	Ant 0	5785 MHz	17.64 MHz	≥ 0.5 MHz	N/A	Annex A, 35
802.11ac-VHT40	Ant 0	5755 MHz	35.45 MHz	≥ 0.5 MHz	N/A	Annex A, 35
802.11ac-VHT80	Ant 3	5775 MHz	75.48 MHz	≥ 0.5 MHz	N/A	Annex A, 48
802.11ac-VHT80+80	Ant 2	5775 MHz	74.22 MHz	≥ 0.5 MHz	N/A	Annex A, 48

FPMI2458-DP4RPSMA Antenna Detail Test Summary

Mode	Ant Port	Frequency	Measurement	Limit	Margin	Refer Page
Maximum Conducted Output Power Measurement						
802.11a	Ant 0+1+2+3	5745 MHz	24.12 dBm	≤ 24.29 dBm	-0.17 dB	Annex B, 5
802.11n-HT20	Ant 0+1+2+3	5785 MHz	24.09 dBm	≤ 24.29 dBm	-0.20 dB	Annex B, 5
802.11n-HT40	Ant 0+1+2+3	5795 MHz	24.03 dBm	≤ 24.29 dBm	-0.26 dB	Annex B, 5
802.11ac-VHT20	Ant 0+1+2+3	5785 MHz	24.11 dBm	≤ 24.29 dBm	-0.18 dB	Annex B, 5
802.11ac-VHT40	Ant 0+1+2+3	5795 MHz	24.04 dBm	≤ 24.29 dBm	-0.25 dB	Annex B, 5
802.11ac-VHT80	Ant 0+1+2+3	5775 MHz	23.99 dBm	≤ 24.29 dBm	-0.30 dB	Annex B, 5
802.11ac-VHT80+80	Ant 0+1+2+3	5210 MHz	16.75 dBm	≤ 27.82 dBm	-11.07 dB	Annex B, 6
		5775 MHz	13.96 dBm	≤ 26.80 dBm	-12.84 dB	
Power Spectral Density Measurement						
802.11a	Ant 0+1+2+3	5745 MHz	11.38 dBm/500kHz	≤ 24.29 dBm/500kHz	-12.91 dB	Annex C, 6
802.11n-HT20	Ant 0+1+2+3	5785 MHz	11.31 dBm/500kHz	≤ 24.29 dBm/500kHz	-12.98 dB	Annex C, 6
802.11n-HT40	Ant 0+1+2+3	5795 MHz	8.24 dBm/500kHz	≤ 24.29 dBm/500kHz	-16.05 dB	Annex C, 6
802.11ac-VHT20	Ant 0+1+2+3	5785 MHz	11.37 dBm/500kHz	≤ 24.29 dBm/500kHz	-12.92 dB	Annex C, 6
802.11ac-VHT40	Ant 0+1+2+3	5755 MHz	12.95 dBm/500kHz	≤ 24.29 dBm/500kHz	-11.34 dB	Annex C, 6
802.11ac-VHT80	Ant 0+1+2+3	5775 MHz	5.37 dBm/500kHz	≤ 24.29 dBm/500kHz	-18.92 dB	Annex C, 6
802.11ac-VHT80+80	Ant 0+1+2+3	5210 MHz	-1.81 dBm/MHz	≤ 14.31 dBm/MHz	-16.21 dB	Annex C, 3
		5775 MHz	-4.21 dBm/500kHz	≤ 26.80 dBm/500kHz	-31.01 dB	Annex C, 6

Mode	Ant Port	Frequency	Measurement	Limit	Margin	Refer Page
Radiated Spurious Emission Measurement						
802.11a	Ant 0+1+2+3	5745 MHz	53.1 dB μ V/m	74.0 dB μ V/m	-20.9 dB	Annex D, 116
802.11n-HT20	Ant 0+1+2+3	5785 MHz	52.6 dB μ V/m	74.0 dB μ V/m	-21.4 dB	Annex D, 123
802.11n-HT40	Ant 3	5755 MHz	44.6 dB μ V/m	68.2 dB μ V/m	-23.6 dB	Annex D, 99
802.11ac-VHT20	Ant 0+1+2+3	5745 MHz	51.2 dB μ V/m	54.0 dB μ V/m	-2.8 dB	Annex D, 132
802.11ac-VHT40	Ant 1	5190 MHz	44.8 dB μ V/m	68.2 dB μ V/m	-23.4 dB	Annex D, 23
802.11ac-VHT80	Ant 2	5775 MHz	44.5 dB μ V/m	68.2 dB μ V/m	-23.7 dB	Annex D, 84
802.11ac-VHT80+80	Ant 0+1+2+3	5210 + 5775 MHz	45.2 dB μ V/m	68.2 dB μ V/m	-23.0 dB	Annex D, 141
Radiated Restricted Band Edge Measurement						
802.11a	Ant 0+1+2+3	5180 MHz	53.362 dB μ V/m	54.000 dB μ V/m	-0.638 dB	Annex E, 192
802.11n-HT20	Ant 0+1+2+3	5180 MHz	53.480 dB μ V/m	54.000 dB μ V/m	-0.520 dB	Annex E, 200
802.11n-HT40	Ant 0+1+2+3	5190 MHz	53.478 dB μ V/m	54.000 dB μ V/m	-0.522 dB	Annex E, 208
802.11ac-VHT20	Ant 0+1+2+3	5180 MHz	52.723 dB μ V/m	54.000 dB μ V/m	-1.277 dB	Annex E, 216
802.11ac-VHT40	Ant 0+1+2+3	5190 MHz	52.211 dB μ V/m	54.000 dB μ V/m	-1.789 dB	Annex E, 224
802.11ac-VHT80	Ant 0+1+2+3	5210 MHz	53.200 dB μ V/m	54.000 dB μ V/m	-0.800 dB	Annex E, 232
802.11ac-VHT80+80	Ant 0+1+2+3	5180 MHz	53.244 dB μ V/m	54.000 dB μ V/m	-0.756 dB	Annex E, 238



FPMI2458-DP2RPSMA Antenna Detail Test Summary

Mode	Ant Port	Frequency	Measurement	Limit	Margin	Refer Page
Maximum Conducted Output Power Measurement						
802.11a	Ant 0+1+2+3	5785 MHz	27.63 dBm	≤ 27.82 dBm	-0.19 dB	Annex B, 11
802.11n-HT20	Ant 0+1+2+3	5745 MHz	25.11 dBm	≤ 27.82 dBm	-2.71 dB	Annex B, 11
802.11n-HT40	Ant 0+1+2+3	5755 MHz	25.18 dBm	≤ 27.82 dBm	-2.64 dB	Annex B, 11
802.11ac-VHT20	Ant 0+1+2+3	5745 MHz	25.22 dBm	≤ 27.82 dBm	-2.60 dB	Annex B, 12
802.11ac-VHT40	Ant 0+1+2+3	5755 MHz	25.13 dBm	≤ 27.82 dBm	-2.69 dB	Annex B, 12
802.11ac-VHT80	Ant 0+1+2+3	5775 MHz	24.76 dBm	≤ 27.82 dBm	-3.06 dB	Annex B, 12
802.11ac-VHT80+80	Ant 0+1+2+3	5210 MHz	16.75 dBm	≤ 27.31 dBm	-10.56 dB	Annex B, 13
		5775 MHz	13.96 dBm	≤ 27.82 dBm	-13.86 dB	
Power Spectral Density Measurement						
802.11a	Ant 0+1+2+3	5745 MHz	13.04 dBm/500kHz	≤ 27.82 dBm/500kHz	-14.78 dB	Annex C, 63
802.11n-HT20	Ant 0+1+2+3	5745 MHz	11.95 dBm/500kHz	≤ 27.82 dBm/500kHz	-15.87 dB	Annex C, 63
802.11n-HT40	Ant 0+1+2+3	5755 MHz	9.30 dBm/500kHz	≤ 27.82 dBm/500kHz	-18.52 dB	Annex C, 63
802.11ac-VHT20	Ant 0+1+2+3	5745 MHz	12.66 dBm/500kHz	≤ 27.82 dBm/500kHz	-15.16 dB	Annex C, 63
802.11ac-VHT40	Ant 0+1+2+3	5755 MHz	9.13 dBm/500kHz	≤ 27.82 dBm/500kHz	-18.69 dB	Annex C, 63
802.11ac-VHT80	Ant 0+1+2+3	5775 MHz	5.75 dBm/500kHz	≤ 27.82 dBm/500kHz	-22.07 dB	Annex C, 63
802.11ac-VHT80+80	Ant 0+1+2+3	5210 MHz	-1.81 dBm/MHz	≤ 14.31 dBm/MHz	-16.02 dB	Annex C, 60
		5775 MHz	-4.21 dBm/500kHz	≤ 27.82 dBm/500kHz	-32.03 dB	Annex C, 64

Mode	Ant Port	Frequency	Measurement	Limit	Margin	Refer Page
Radiated Spurious Emission Measurement						
802.11a	Ant 0+1+2+3	5745 MHz	51.6 dB μ V/m	74.0 dB μ V/m	-22.4 dB	Annex D, 257
802.11n-HT20	Ant 0+1+2+3	5745 MHz	42.7 dB μ V/m	54.0 dB μ V/m	-11.3 dB	Annex D, 263
802.11n-HT40	Ant 2	5190 MHz	45.8 dB μ V/m	68.2 dB μ V/m	-22.4 dB	Annex D, 210
802.11ac-VHT20	Ant 0+1+2+3	5745 MHz	42.4 dB μ V/m	54.0 dB μ V/m	-11.6 dB	Annex D, 273
802.11ac-VHT40	Ant 3	5795 MHz	44.9 dB μ V/m	68.2 dB μ V/m	-23.3 dB	Annex D, 251
802.11ac-VHT80	Ant 1	5210 MHz	45.9 dB μ V/m	68.2 dB μ V/m	-22.3 dB	Annex D, 196
802.11ac-VHT80+80	Ant 0+1+2+3	5210 + 5775 MHz	44.9 dB μ V/m	68.2 dB μ V/m	-23.3 dB	Annex D, 282
Radiated Restricted Band Edge Measurement						
802.11a	Ant 0+1+2+3	5180 MHz	52.159 dB μ V/m	54.000 dB μ V/m	-1.841 dB	Annex E, 426
802.11n-HT20	Ant 0+1+2+3	5180 MHz	51.479 dB μ V/m	54.000 dB μ V/m	-2.521 dB	Annex E, 434
802.11n-HT40	Ant 0+1+2+3	5190 MHz	52.979 dB μ V/m	54.000 dB μ V/m	-1.021 dB	Annex E, 444
802.11ac-VHT20	Ant 0+1+2+3	5180 MHz	50.635 dB μ V/m	54.000 dB μ V/m	-3.365 dB	Annex E, 450
802.11ac-VHT40	Ant 0+1+2+3	5190 MHz	53.338 dB μ V/m	54.000 dB μ V/m	-0.662 dB	Annex E, 460
802.11ac-VHT80	Ant 0+1+2+3	5210 MHz	52.393 dB μ V/m	54.000 dB μ V/m	-1.607 dB	Annex E, 468
802.11ac-VHT80+80	Ant 0+1+2+3	5210 MHz	53.401 dB μ V/m	54.000 dB μ V/m	-0.599 dB	Annex E, 472



Galtronics Omni Antenna Detail Test Summary

Mode	Ant Port	Frequency	Measurement	Limit	Margin	Refer Page
Maximum Conducted Output Power Measurement						
802.11a	Ant 0	5745 MHz	23.28 dBm	≤ 29.22 dBm	-5.94 dB	Annex B, 14
802.11n-HT20	Ant 0	5745 MHz	23.02 dBm	≤ 29.22 dBm	-6.20 dB	Annex B, 14
802.11n-HT40	Ant 2	5755 MHz	22.94 dBm	≤ 29.22 dBm	-7.06 dB	Annex B, 16
802.11ac-VHT20	Ant 0+1+2+3	5745 MHz	22.97 dBm	≤ 23.31 dBm	-0.34 dB	Annex B, 18
802.11ac-VHT40	Ant 0	5755 MHz	22.96 dBm	≤ 29.22 dBm	-7.04 dB	Annex B, 14
802.11ac-VHT80	Ant 0+1+2+3	5775 MHz	22.68 dBm	≤ 23.31 dBm	-0.63 dB	Annex B, 18
802.11ac-VHT80+80	Ant 0+1+2+3	5210 MHz	22.00 dBm	≤ 29.38 dBm	-7.38 dB	Annex B, 18
		5775 MHz	19.01 dBm	≤ 29.32 dBm	-10.31 dB	
Power Spectral Density Measurement						
802.11a	Ant 0+1+2+3	5220 MHz	9.96 dBm/MHz	≤ 10.37 dBm/MHz	-0.41 dB	Annex C, 117
802.11n-HT20	Ant 3	5240 MHz	10.09 dBm/MHz	≤ 16.47 dBm/MHz	-6.38 dB	Annex C, 116
802.11n-HT40	Ant 0	5755 MHz	6.89 dBm/500kHz	≤ 29.22 dBm/500kHz	-22.56 dB	Annex C, 118
802.11ac-VHT20	Ant 3	5240 MHz	10.13 dBm/MHz	≤ 16.47 dBm/MHz	-6.34 dB	Annex C, 116
802.11ac-VHT40	Ant 3	5190 MHz	6.92 dBm/MHz	≤ 16.47 dBm/MHz	-9.55 dB	Annex C, 116
802.11ac-VHT80	Ant 0	5775 MHz	3.61 dBm/500kHz	≤ 29.22 dBm/500kHz	-25.61 dB	Annex C, 118
802.11ac-VHT80+80	Ant 0+1+2+3	5210 MHz	3.18 dBm/MHz	≤ 13.38 dBm/MHz	-10.20 dB	Annex C, 117
		5775 MHz	0.62 dBm/500kHz	≤ 26.32 dBm/500kHz	-25.70 dB	Annex C, 120



Mode	Ant Port	Frequency	Measurement	Limit	Margin	Refer Page
Radiated Spurious Emission Measurement						
802.11a	Ant 3	5825 MHz	50.5 dBμV/m	68.2 dBμV/m	-17.7 dB	Annex D, 373
802.11n-HT20	Ant 3	5180 MHz	50.8 dBμV/m	68.2 dBμV/m	-17.4 dB	Annex D, 374
802.11n-HT40	Ant 3	5795 MHz	50.3 dBμV/m	68.2 dBμV/m	-17.9 dB	Annex D, 383
802.11ac-VHT20	Ant 0+1+2+3	5745 MHz	44.5 dBμV/m	54.0 dBμV/m	-9.5 dB	Annex D, 415
802.11ac-VHT40	Ant 3	5795 MHz	50.9 dBμV/m	68.2 dBμV/m	-17.3 dB	Annex D, 393
802.11ac-VHT80	Ant 2	5775 MHz	50.3 dBμV/m	68.2 dBμV/m	-17.9 dB	Annex D, 367
802.11ac-VHT80+80	Ant 0+1+2+3	5210 + 5775 MHz	44.8 dBμV/m	68.2 dBμV/m	-23.4 dB	Annex D, 424
Radiated Restricted Band Edge Measurement						
802.11a	Ant 0+1+2+3	5180 MHz	50.443 dBμV/m	54.000 dBμV/m	-3.557 dB	Annex E, 662
802.11n-HT20	Ant 0+1+2+3	5180 MHz	49.340 dBμV/m	54.000 dBμV/m	-4.660 dB	Annex E, 670
802.11n-HT40	Ant 0+1+2+3	5190 MHz	50.199 dBμV/m	54.000 dBμV/m	-3.801 dB	Annex E, 678
802.11ac-VHT20	Ant 0+1+2+3	5180 MHz	51.014 dBμV/m	54.000 dBμV/m	-2.986 dB	Annex E, 686
802.11ac-VHT40	Ant 0+1+2+3	5190 MHz	51.906 dBμV/m	54.000 dBμV/m	-2.094 dB	Annex E, 694
802.11ac-VHT80	Ant 0+1+2+3	5210 MHz	52.615 dBμV/m	54.000 dBμV/m	-1.385 dB	Annex E, 702
802.11ac-VHT80+80	Ant 0+1+2+3	5210 MHz	52.072 dBμV/m	54.000 dBμV/m	-1.928 dB	Annex E, 708

Galtronics Directional Antenna Detail Test Summary

Mode	Ant Port	Frequency	Measurement	Limit	Margin	Refer Page
Maximum Conducted Output Power Measurement						
802.11a	Ant 3	5240 MHz	23.71 dBm	≤ 27.84 dBm	-4.13 dB	Annex B, 23
802.11n-HT20	Ant 0	5745 MHz	22.40 dBm	≤ 27.08 dBm	-4.68 dB	Annex B, 20
802.11n-HT40	Ant 1	5190 MHz	23.63 dBm	≤ 27.18 dBm	-3.55 dB	Annex B, 21
802.11ac-VHT20	Ant 1	5220 MHz	23.71 dBm	≤ 27.18 dBm	-3.47 dB	Annex B, 21
802.11ac-VHT40	Ant 3	5230 MHz	23.52 dBm	≤ 27.84 dBm	-4.32 dB	Annex B, 23
802.11ac-VHT80	Ant 1	5210 MHz	23.48 dBm	≤ 27.84 dBm	-4.36 dB	Annex B, 21
802.11ac-VHT80+80	Ant 0+1+2+3	5210 MHz	21.46 dBm	≤ 27.72 dBm	-6.26 dB	Annex B, 25
		5775 MHz	18.54 dBm	≤ 27.13 dBm	-8.59 dB	
Power Spectral Density Measurement						
802.11a	Ant 3	5240 MHz	12.06 dBm/MHz	≤ 14.84 dBm/MHz	-2.78 dB	Annex C, 172
802.11n-HT20	Ant 2	5240 MHz	11.72 dBm/MHz	≤ 14.61 dBm/MHz	-2.89 dB	Annex C, 172
802.11n-HT40	Ant 3	5230 MHz	8.75 dBm/MHz	≤ 14.84 dBm/MHz	-6.09 dB	Annex C, 172
802.11ac-VHT20	Ant 3	5220 MHz	11.70 dBm/MHz	≤ 14.84 dBm/MHz	-3.14 dB	Annex C, 172
802.11ac-VHT40	Ant 3	5230 MHz	8.89 dBm/MHz	≤ 14.84 dBm/MHz	-5.95 dB	Annex C, 172
802.11ac-VHT80	Ant 1	5210 MHz	5.45 dBm/MHz	≤ 14.84 dBm/MHz	-9.39 dB	Annex C, 171
802.11ac-VHT80+80	Ant 0+1+2+3	5210 MHz	3.05 dBm/MHz	≤ 11.71 dBm/MHz	-9.66 dB	Annex C, 173
		5775 MHz	-0.32 dBm/500kHz	≤ 24.12 dBm/500kHz	-24.44 dB	Annex C, 176

Mode	Ant Port	Frequency	Measurement	Limit	Margin	Refer Page
Radiated Spurious Emission Measurement						
802.11a	Ant 0+1+2+3	5825 MHz	53.3 dB μ V/m	68.2 dB μ V/m	-14.9 dB	Annex D, 542
802.11n-HT20	Ant 0+1+2+3	5220 MHz	53.4 dB μ V/m	68.2 dB μ V/m	-14.8 dB	Annex D, 544
802.11n-HT40	Ant 0	5230 MHz	52.7 dB μ V/m	68.2 dB μ V/m	-15.5 dB	Annex D, 438
802.11ac-VHT20	Ant 0	5180 MHz	52.5 dB μ V/m	68.2 dB μ V/m	-15.7 dB	Annex D, 441
802.11ac-VHT40	Ant 0	5230 MHz	53.1 dB μ V/m	68.2 dB μ V/m	-15.1 dB	Annex D, 448
802.11ac-VHT80	Ant 0	5775 MHz	53.0 dB μ V/m	68.2 dB μ V/m	-15.2 dB	Annex D, 452
802.11ac-VHT80+80	Ant 0+1+2+3	5210 + 5775 MHz	44.9 dB μ V/m	68.2 dB μ V/m	-23.3 dB	Annex D, 565
Radiated Restricted Band Edge Measurement						
802.11a	Ant 0+1+2+3	5180 MHz	53.109 dB μ V/m	54.000 dB μ V/m	-0.891 dB	Annex E, 898
802.11n-HT20	Ant 0+1+2+3	5180 MHz	53.407 dB μ V/m	54.000 dB μ V/m	-0.593 dB	Annex E, 906
802.11n-HT40	Ant 0+1+2+3	5190 MHz	53.280 dB μ V/m	54.000 dB μ V/m	-0.720 dB	Annex E, 914
802.11ac-VHT20	Ant 0+1+2+3	5180 MHz	53.356 dB μ V/m	54.000 dB μ V/m	-0.644 dB	Annex E, 922
802.11ac-VHT40	Ant 0+1+2+3	5190 MHz	53.320 dB μ V/m	54.000 dB μ V/m	-0.680 dB	Annex E, 930
802.11ac-VHT80	Ant 0+1+2+3	5210 MHz	53.192 dB μ V/m	54.000 dB μ V/m	-0.808 dB	Annex E, 938
802.11ac-VHT80+80	Ant 0+1+2+3	5210 MHz	52.756 dB μ V/m	54.000 dB μ V/m	-1.244 dB	Annex E, 944

Sector-Antenna 1356.17.0011 Detail Test Summary

Mode	Ant Port	Frequency	Measurement	Limit	Margin	Refer Page
Maximum Conducted Output Power Measurement						
802.11a	Ant 1	5240 MHz	19.64 dBm	≤ 20.00 dBm	-0.36 dB	Annex B, 27
802.11n-HT20	Ant 0+1+2+3	5240 MHz	19.58 dBm	≤ 20.00 dBm	-0.42 dB	Annex B, 30
802.11n-HT40	Ant 1	5230 MHz	19.60 dBm	≤ 20.00 dBm	-0.40 dB	Annex B, 27
802.11ac-VHT20	Ant 0+1+2+3	5240 MHz	19.54 dBm	≤ 20.00 dBm	-0.46 dB	Annex B, 30
802.11ac-VHT40	Ant 0	5230 MHz	19.65 dBm	≤ 20.00 dBm	-0.35 dB	Annex B, 26
802.11ac-VHT80	Ant 3	5775 MHz	18.60 dBm	≤ 19.00 dBm	-0.40 dB	Annex B, 29
802.11ac-VHT80+80	Ant 0+1+2+3	5210 MHz	19.21 dBm	≤ 20.00 dBm	-0.79 dB	Annex B, 31
		5775 MHz	16.62 dBm	≤ 19.00 dBm	-2.38 dB	
Power Spectral Density Measurement						
802.11a	Ant 0+1+2+3	5220 MHz	6.69 dBm/MHz	≤ 7.00 dBm/MHz	-0.31 dB	Annex C, 229
802.11n-HT20	Ant 0+1+2+3	5240 MHz	6.83 dBm/MHz	≤ 7.00 dBm/MHz	-0.17 dB	Annex C, 229
802.11n-HT40	Ant 2	5230 MHz	3.99 dBm/MHz	≤ 7.00 dBm/MHz	-3.01 dB	Annex C, 228
802.11ac-VHT20	Ant 0+1+2+3	5240 MHz	6.69 dBm/MHz	≤ 7.00 dBm/MHz	-0.31 dB	Annex C, 229
802.11ac-VHT40	Ant 2	5230 MHz	3.89 dBm/MHz	≤ 7.00 dBm/MHz	-3.11 dB	Annex C, 228
802.11ac-VHT80	Ant 2	5775 MHz	0.24 dBm/500kHz	≤ 19.00 dBm/500kHz	-18.76 dB	Annex C, 231
802.11ac-VHT80+80	Ant 0+1+2+3	5210 MHz	0.98 dBm/MHz	≤ 7.00 dBm/MHz	-6.02 dB	Annex C, 229
		5775 MHz	-1.94 dBm/500kHz	≤ 19.00 dBm/500kHz	-20.94 dB	Annex C, 232



Mode	Ant Port	Frequency	Measurement	Limit	Margin	Refer Page
Radiated Spurious Emission Measurement						
802.11a	Ant 0+1+2+3	5745 MHz	49.4 dBμV/m	54.0 dBμV/m	-4.6 dB	Annex D, 681
802.11n-HT20	Ant 0+1+2+3	5745 MHz	47.1 dBμV/m	54.0 dBμV/m	-6.9 dB	Annex D, 687
802.11n-HT40	Ant 0+1+2+3	5755 MHz	44.6 dBμV/m	54.0 dBμV/m	-9.4 dB	Annex D, 692
802.11ac-VHT20	Ant 0+1+2+3	5825 MHz	47.5 dBμV/m	54.0 dBμV/m	-6.5 dB	Annex D, 699
802.11ac-VHT40	Ant 0+1+2+3	5755 MHz	47.5 dBμV/m	54.0 dBμV/m	-6.5 dB	Annex D, 702
802.11ac-VHT80	Ant 1	5775 MHz	45.8 dBμV/m	68.2 dBμV/m	-22.4 dB	Annex D, 621
802.11ac-VHT80+80	Ant 0+1+2+3	5210 + 5775 MHz	45.0 dBμV/m	68.2 dBμV/m	-23.2 dB	Annex D, 706
Radiated Restricted Band Edge Measurement						
802.11a	Ant 0+1+2+3	5180 MHz	53.579 dBμV/m	54.000 dBμV/m	-0.421 dB	Annex E, 1044
802.11n-HT20	Ant 0+1+2+3	5180 MHz	53.491 dBμV/m	54.000 dBμV/m	-0.509 dB	Annex E, 1052
802.11n-HT40	Ant 0+1+2+3	5190 MHz	53.395 dBμV/m	54.000 dBμV/m	-0.605 dB	Annex E, 960
802.11ac-VHT20	Ant 0+1+2+3	5180 MHz	53.563 dBμV/m	54.000 dBμV/m	-0.437 dB	Annex E, 1068
802.11ac-VHT40	Ant 0+1+2+3	5190 MHz	53.669 dBμV/m	54.000 dBμV/m	-0.331 dB	Annex E, 984
802.11ac-VHT80	Ant 0+1+2+3	5210 MHz	53.599 dBμV/m	54.000 dBμV/m	-0.401 dB	Annex E, 1130
802.11ac-VHT80+80	Ant 0+1+2+3	5210 MHz	53.405 dBμV/m	54.000 dBμV/m	-0.595 dB	Annex E, 1182



Directional Antenna 1356.17.0077 Detail Test Summary

Mode	Ant Port	Frequency	Measurement	Limit	Margin	Refer Page
Maximum Conducted Output Power Measurement						
802.11a	Ant 0+1+2+3	5745 MHz	21.58 dBm	≤ 22.00 dBm	-0.42 dB	Annex B, 36
802.11n-HT20	Ant 0+1+2+3	5825 MHz	21.63 dBm	≤ 22.00 dBm	-0.37 dB	Annex B, 36
802.11n-HT40	Ant 0	5755 MHz	21.43 dBm	≤ 22.00 dBm	-0.57 dB	Annex B, 32
802.11ac-VHT20	Ant 0+1+2+3	5825 MHz	21.63 dBm	≤ 22.00 dBm	-0.37 dB	Annex B, 5
802.11ac-VHT40	Ant 3	5795 MHz	21.67 dBm	≤ 22.00 dBm	-0.33 dB	Annex B, 35
802.11ac-VHT80	Ant 0+1+2+3	5775 MHz	21.55 dBm	≤ 22.00 dBm	-0.45 dB	Annex B, 36
802.11ac-VHT80+80	Ant 0+1+2+3	5210 MHz	17.91 dBm	≤ 22.00 dBm	-4.09 dB	Annex B, 37
		5775 MHz	14.48 dBm	≤ 22.00 dBm	-7.52 dB	
Power Spectral Density Measurement						
802.11a	Ant 3	5825 MHz	9.09 dBm/500kHz	≤ 22.00 dBm/500kHz	-12.91 dB	Annex C, 287
802.11n-HT20	Ant 1	5240 MHz	8.75 dBm/MHz	≤ 9.00 dBm/MHz	-0.25 dB	Annex C, 283
802.11n-HT40	Ant 1	5230 MHz	6.00 dBm/MHz	≤ 9.00 dBm/MHz	-3.00 dB	Annex C, 283
802.11ac-VHT20	Ant 1	5240 MHz	8.85 dBm/MHz	≤ 9.00 dBm/MHz	-0.15 dB	Annex C, 283
802.11ac-VHT40	Ant 1	5230 MHz	6.15 dBm/MHz	≤ 9.00 dBm/MHz	-2.85 dB	Annex C, 283
802.11ac-VHT80	Ant 1	5210 MHz	2.88 dBm/MHz	≤ 9.00 dBm/MHz	-6.12 dB	Annex C, 283
802.11ac-VHT80+80	Ant 0+1+2+3	5210 MHz	-0.43 dBm/MHz	≤ 9.00 dBm/MHz	-9.43 dB	Annex C, 285
		5775 MHz	-3.57 dBm/500kHz	≤ 22.00 dBm/500kHz	-25.57 dB	Annex C, 288



Mode	Ant Port	Frequency	Measurement	Limit	Margin	Refer Page
Radiated Spurious Emission Measurement						
802.11a	Ant 0+1+2+3	5745 MHz	43.1 dB μ V/m	54.0 dB μ V/m	-10.9 dB	Annex D, 822
802.11n-HT20	Ant 3	5745 MHz	44.1 dB μ V/m	54.0 dB μ V/m	-9.9 dB	Annex D, 800
802.11n-HT40	Ant 0+1+2+3	5755 MHz	52.4 dB μ V/m	74.0 dB μ V/m	-21.6 dB	Annex D, 833
802.11ac-VHT20	Ant 3	5745 MHz	43.2 dB μ V/m	54.0 dB μ V/m	-10.8 dB	Annex D, 810
802.11ac-VHT40	Ant 0+1+2+3	5755 MHz	53.4 dB μ V/m	74.0 dB μ V/m	-20.6 dB	Annex D, 843
802.11ac-VHT80	Ant 0+1+2+3	5775 MHz	46.6 dB μ V/m	68.2 dB μ V/m	-21.6 dB	Annex D, 846
802.11ac-VHT80+80	Ant 0+1+2+3	5210 + 5775 MHz	44.4 dB μ V/m	68.2 dB μ V/m	-23.8 dB	Annex D, 847
Radiated Restricted Band Edge Measurement						
802.11a	Ant 0+1+2+3	5180 MHz	50.948 dB μ V/m	54.000 dB μ V/m	-3.052 dB	Annex E, 1372
802.11n-HT20	Ant 0+1+2+3	5180 MHz	52.952 dB μ V/m	54.000 dB μ V/m	-1.048 dB	Annex E, 1380
802.11n-HT40	Ant 0+1+2+3	5190 MHz	52.929 dB μ V/m	54.000 dB μ V/m	-1.071 dB	Annex E, 1388
802.11ac-VHT20	Ant 0+1+2+3	5180 MHz	51.974 dB μ V/m	54.000 dB μ V/m	-2.026 dB	Annex E, 1396
802.11ac-VHT40	Ant 0+1+2+3	5190 MHz	53.228 dB μ V/m	54.000 dB μ V/m	-0.772 dB	Annex E, 1404
802.11ac-VHT80	Ant 0+1+2+3	5210 MHz	52.998 dB μ V/m	54.000 dB μ V/m	-1.002 dB	Annex E, 1412
802.11ac-VHT80+80	Ant 0+1+2+3	5190 MHz	53.187 dB μ V/m	54.000 dB μ V/m	-0.813 dB	Annex E, 1418

7.2. 26dB Bandwidth Measurement

7.2.1. Test Limit

N/A

7.2.2. Test Procedure used

KDB 789033 D02v01r03 – Section C.1

7.2.3. Test Setting

1. The analyzers' automatic bandwidth measurement capability was used to perform the 26dB bandwidth measurement. The "X" dB bandwidth parameter was set to $X = 26$. The automatic bandwidth measurement function also has the capability of simultaneously measuring the 99% occupied bandwidth. The bandwidth measurement was not influenced by any intermediated power nulls in the fundamental emission.
2. RBW = approximately 1% of the emission bandwidth.
3. VBW $\geq 3 \times$ RBW.
4. Detector = Peak.
5. Trace mode = max hold.

7.2.4. Test Setup

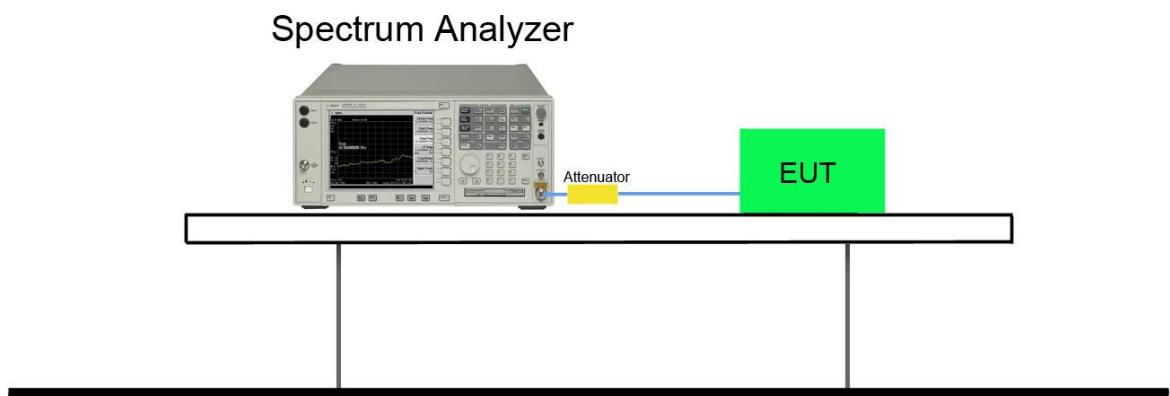

7.2.5. Test Result

Refer to "Annex A - 26dB & 6dB Measurement test result" File.

7.3. 6dB Bandwidth Measurement

7.3.1. Test Limit

The minimum 6dB bandwidth shall be at least 500 kHz.

7.3.2. Test Procedure used

KDB 789033 D02v01r03 – Section C.2

7.3.3. Test Setting

6. Set center frequency to the nominal EUT channel center frequency.
7. RBW = 100 kHz.
8. VBW $\geq 3 \times$ RBW.
9. Detector = Peak.
10. Trace mode = max hold.
11. Sweep = auto couple.
12. Allow the trace to stabilize.
13. Measure the maximum width of the emission that is constrained by the frequencies associated with the two outermost amplitude points (upper and lower frequencies) that are attenuated by 6 dB relative to the maximum level measured in the fundamental emission.

7.3.4. Test Setup

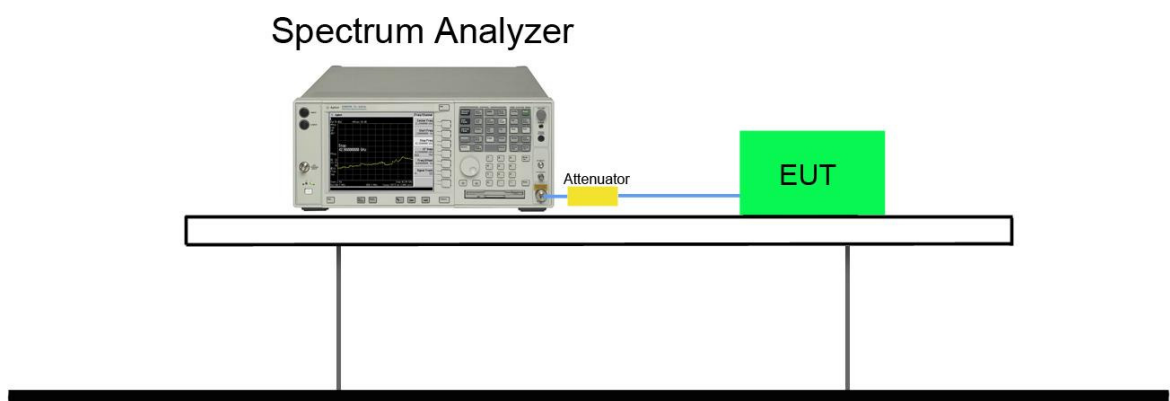

7.3.5. Test Result

Refer to “Annex A - 26dB & 6dB Measurement test result” File.

7.4. Output Power Measurement

7.4.1. Test Limit

For an indoor access point operating in the band 5.15-5.25 GHz, the maximum conducted output power over the frequency band of operation shall not exceed 1 W provided the maximum antenna gain does not exceed 6 dBi.

For the band 5.725-5.85 GHz, the maximum conducted output power over the frequency band of operation shall not exceed 1 W (30dBm).

If transmitting antennas of directional gain greater than 6dBi are used, the maximum conducted output power shall be reduced by the amount in dB that the directional gain of the antenna exceeds 6dBi.

7.4.2. Test Procedure Used

KDB 789033 D02v01r03 - Section E) 3) b) Method PM-G

7.4.3. Test Setting

Average power measurements were performed only when the EUT was transmitting at its maximum power control level using a broadband power meter with a pulse sensor. The power meter implemented triggering and gating capabilities which were set up such that power measurements were recorded only during the ON time of the transmitter. The trace was averaged over 100 traces to obtain the final measured average power.

7.4.4. Test Setup

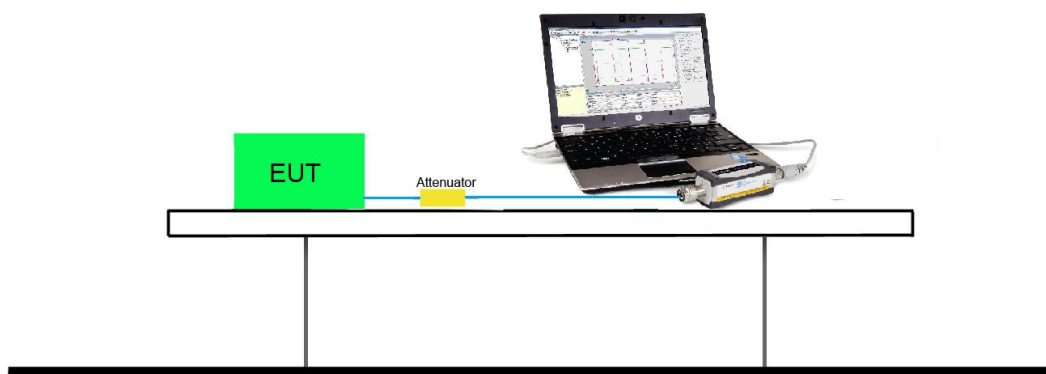

7.4.5. Test Rate Assessment

Power output test was verified over all data rates of each mode shown as below, and then choose the maximum power output (yellow marker) for final test of each channel.

N _{Tx}	802.11a	MCS Index for 802.11n	Data Rate (Mbps)			
			20MHz Bandwidth		40MHz Bandwidth	
			800ns GI	400ns GI	800ns GI	400ns GI
1	6	0	6.5	7.2	13.5	15.0
1	9	1	13.0	14.4	27.0	30.0
1	12	2	19.5	21.7	40.5	45.0
1	18	3	26.0	28.9	54.0	60.0
1	24	4	39.0	43.3	81.0	90.0
1	36	5	52.0	57.8	108.0	120.0
1	48	6	58.5	65.0	121.5	135.0
1	54	7	65.0	72.2	135.0	150.0

N _{Tx}	802.11a	MCS Index for 802.11n	Data Rate (Mbps)			
			20MHz Bandwidth		40MHz Bandwidth	
			800ns GI	400ns GI	800ns GI	400ns GI
4	6	24	26	28.8	54	60
4	9	25	52	57.8	108	120
4	12	26	78	86.6	162	180
4	18	27	104	115.6	216	240
4	24	28	156	173.4	324	360
4	36	29	208	231.2	432	480
4	48	30	234	260	486	540
4	54	31	260	288	540	600

N _{Tx}	MCS Index for 802.11ac	Data Rate (Mbps)					
		20MHz Bandwidth		40MHz Bandwidth		80MHz Bandwidth	
		800ns GI	400ns GI	800ns GI	400ns GI	800ns GI	400ns GI
1	0	6.5	7.2	13.5	15.0	29.3	32.5
1	1	13.0	14.4	27.0	30.0	58.5	65.0
1	2	19.5	21.7	40.5	45.0	87.8	97.5
1	3	26.0	28.9	54.0	60.0	117.0	130.0
1	4	39.0	43.3	81.0	90.0	175.5	195.0
1	5	52.0	57.8	108.0	120.0	234.0	260.0
1	6	58.5	65.0	121.5	135.0	263.3	292.5
1	7	65.0	72.2	135.0	150.0	292.5	325.0
1	8	78.0	86.7	162.0	180.0	351.0	390.0
1	9	--	--	180.0	200.0	390.0	433.3

N _{Tx}	MCS Index for 802.11ac	Data Rate (Mbps)					
		20MHz Bandwidth		40MHz Bandwidth		80MHz Bandwidth	
		800ns GI	400ns GI	800ns GI	400ns GI	800ns GI	400ns GI
4	0	26	28.8	54	60	117.2	130
4	1	52	57.6	108	120	234	260
4	2	78	86.8	162	180	351.2	390
4	3	104	115.6	216	240	468	520
4	4	156	173.2	324	360	702	780
4	5	208	231.2	432	480	936	1040
4	6	234	260	486	540	1053.2	1170
4	7	260	288.8	540	600	1170	1300
4	8	312	346.8	648	720	1404	1560
4	9	--	--	720	800	1560	1733.2

Note: Power output test was verified over all data rates of each mode shown as above, and then choose the maximum power output (yellow marker) for final test of each channel.

Output power at various data rates for Ant 0:

Test Mode	Bandwidth	Channel	Frequency (MHz)	Data Rate (Mbps)	Average Power (dBm)
802.11a	20	60	5180	6	15.78
				24	15.64
				54	15.52
802.11n	20	60	5180	6.5	15.58
				7.2	15.47
				26	15.41
				28.9	15.32
				65	15.26
				72.2	15.13
802.11n	40	62	5190	13.5	15.57
				15	15.44
				54	15.32
				60	15.26
				135	15.11
				150	15.01
802.11ac	20	60	5180	6.5	15.56
				7.2	15.46
				39	15.38
				78	15.32
				81	15.24
				86.7	15.12
802.11ac	40	62	5190	13.5	15.57
				15	15.43
				108	15.36
				120	15.27
				180	15.18
				200	15.04

802.11ac	80	58	5210	29.3	15.62
				32.5	15.52
				260	15.43
				234	15.31
				390	15.25
				433.3	15.19

7.4.6. Test Result

Refer to "Annex B-Maximum Conducted Output Power Test Result" File.

7.5. Transmit Power Control

7.5.1. Test Limit

The U-NII device is required to have the capability to operate at least 6 dB below the mean EIRP value of 30 dBm.

7.5.2. Test Procedure Used

KDB 789033 D02v01r03 - Section E) 3) b) Method PM-G

7.5.3. Test Setting

Average power measurements were performed only when the EUT was transmitting at its maximum power control level using a broadband power meter with a pulse sensor. The power meter implemented triggering and gating capabilities which were set up such that power measurements were recorded only during the ON time of the transmitter. The trace was averaged over 100 traces to obtain the final measured average power.

7.5.4. Test Setup

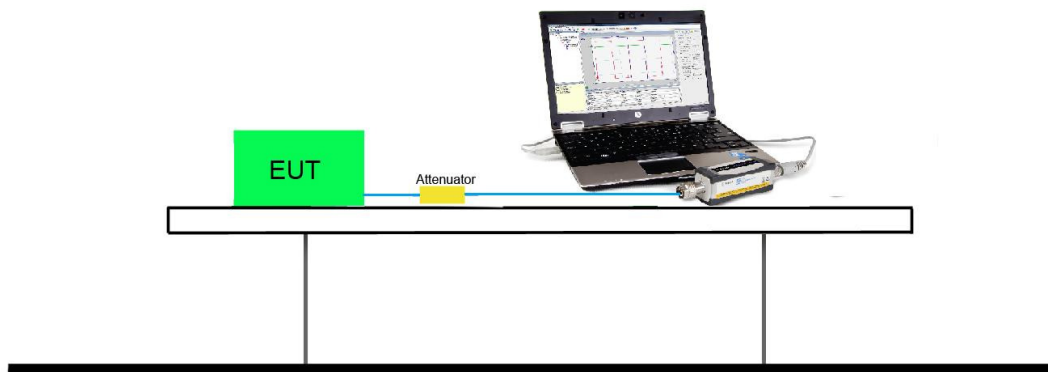

7.5.5. Test Result

TPC is not required for 5150 ~ 5250MHz & 5725 ~ 5850MHz.

7.6. Power Spectral Density Measurement

7.6.1. Test Limit

For FCC

For an indoor access point operating in the band 5.15-5.25 GHz, the maximum power spectral density shall not exceed 17 dBm in any 1 megahertz band.

For the band 5.725-5.85 GHz, the maximum power spectral density shall not exceed 30 dBm in any 500-kHz band.

If transmitting antennas of directional gain greater than 6dBi are used, the peak power spectral density shall be reduced by the amount in dB that the directional gain of the antenna exceeds 6dBi.

7.6.2. Test Procedure Used

KDB 789033 D02v01r03 - Section F

7.6.3. Test Setting

14. Analyzer was set to the center frequency of the UNII channel under investigation
15. Span was set to encompass the entire 26dB EBW of the signal.
16. RBW = 1MHz, if measurement bandwidth of Maximum PSD is specified in 500 kHz,
17. RBW = 100 kHz
18. VBW = 3MHz
19. Number of sweep points $\geq 2 \times (\text{span} / \text{RBW})$
20. Detector = power averaging (Average)
21. Sweep time = auto
22. Trigger = free run
23. Use the peak search function on the instrument to find the peak of the spectrum and record its value.
24. Add $10 \cdot \log(1/x)$, where x is the duty cycle, to the measured power in order to compute the average power during the actual transmission times (because the measurement represents an average over both the on and off times of the transmission). For example, add $10 \cdot \log(1/0.25) = 6$ dB if the duty cycle is 25 percent.
25. When the measurement bandwidth of Maximum PSD is specified in 500 kHz, add a constant factor $10 \cdot \log(500\text{kHz}/100\text{kHz}) = 7$ dB to the measured result

7.6.4. Test Setup

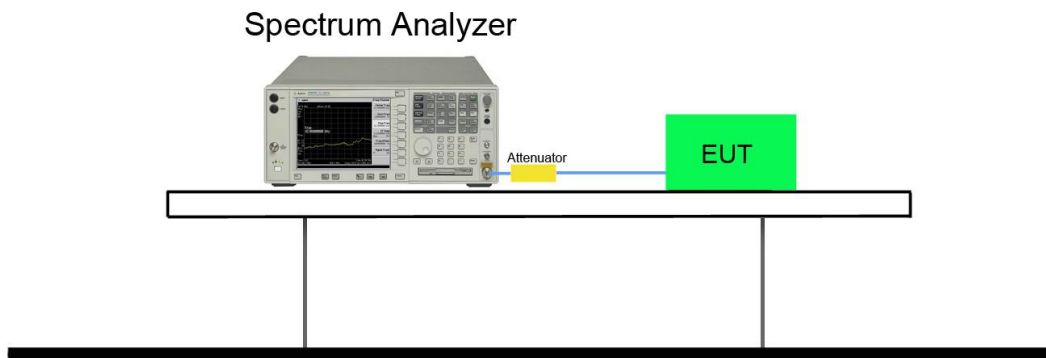

7.6.5. Test Result

Refer to "Annex C-Power Spectral Density Test Result" File.

7.7. Frequency Stability Measurement

7.7.1. Test Limit

Manufactures of U-NII devices are responsible for ensuring frequency stability such that an emission is maintained within the band of operation under all conditions of normal operation as specified in the user's manual.

7.7.2. Test Procedure Used

Frequency Stability Under Temperature Variations:

The equipment under test was connected to an external AC or DC power supply and input rated voltage. RF output was connected to a frequency counter or spectrum analyzer via feed through attenuators. The EUT was placed inside the temperature chamber. Set the spectrum analyzer RBW low enough to obtain the desired frequency resolution and measure EUT 20°C operating frequency as reference frequency. Turn EUT off and set the chamber temperature to highest. After the temperature stabilized for approximately 30 minutes recorded the frequency. Repeat step measure with 10°C decreased per stage until the lowest temperature reached.

Frequency Stability Under Voltage Variations:

Set chamber temperature to 20°C. Use a variable AC power supply / DC power source to power the EUT and set the voltage to rated voltage. Set the spectrum analyzer RBW low enough to obtain the desired frequency resolution and recorded the frequency.

Reduce the input voltage to specify extreme voltage variation ($\pm 15\%$) and endpoint, record the maximum frequency change.

7.7.3. Test Setup

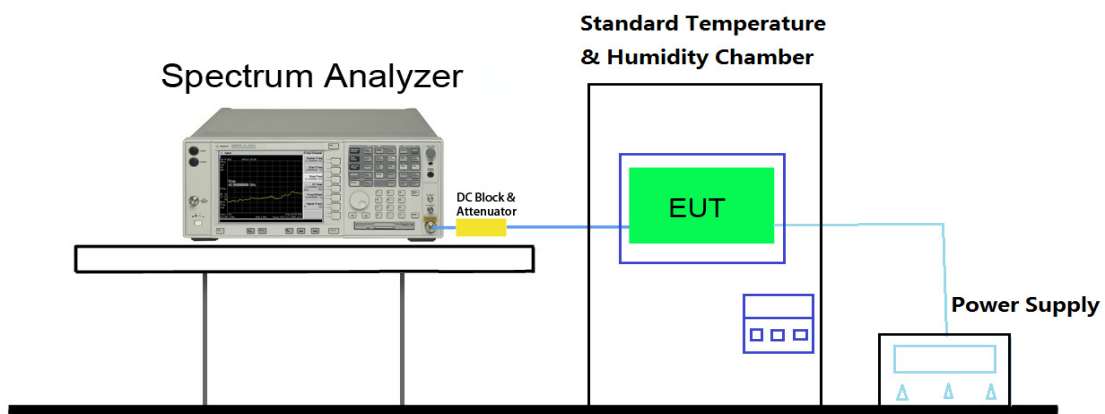

7.7.4. Test Result

Test Engineer	Kevin Ke	Temperature	-30 ~ 50°C
Test Time	10-05-2016	Relative Humidity	52%RH

Voltage (%)	Power (VAC)	Temp (°C)	Frequency Tolerance (ppm)			
			0 minutes	2 minutes	5 minutes	10 minutes
100%	120	- 30	5.49	4.54	2.18	3.27
		- 20	3.39	4.43	4.26	2.58
		- 10	4.10	3.76	2.09	2.43
		0	4.26	5.68	6.02	2.52
		+ 10	3.78	1.54	3.86	3.81
		+ 20 (Ref)	3.19	4.50	2.40	3.69
		+ 30	5.54	5.84	2.10	2.13
		+ 40	3.84	2.71	1.93	5.32
		+ 50	4.23	1.98	-2.39	2.37
115%	138	+ 20	3.34	3.36	3.39	3.24
85%	102	+ 20	3.37	3.09	2.69	0.69

Note: Frequency Tolerance (ppm) = $\frac{\{[\text{Measured Frequency (Hz)} - \text{Declared Frequency (Hz)}]\}}{\text{Declared Frequency (Hz)}} * 10^6$.

7.8. Radiated Spurious Emission Measurement

7.8.1. Test Limit

All out of band emissions appearing in a restricted band as specified in Section 15.205 of the Title 47 CFR must not exceed the limits shown in Table per Section 15.209.

FCC Part 15 Subpart C Paragraph 15.209		
Frequency [MHz]	Field Strength [V/m]	Measured Distance [Meters]
0.009 – 0.490	2400/F (kHz)	300
0.490 – 1.705	24000/F (kHz)	30
1.705 - 30	30	30
30 - 88	100	3
88 - 216	150	3
216 - 960	200	3
Above 960	500	3

7.8.2. Test Procedure Used

KDB 789033 D02v01r03 – Section G

7.8.3. Test Setting

Peak Measurements above 1GHz

1. Analyzer center frequency was set to the frequency of the radiated spurious emission of interest
2. RBW = 1MHz
3. VBW = 3MHz
4. Detector = peak
5. Sweep time = auto couple
6. Trace mode = max hold
7. Trace was allowed to stabilize

Quasi-Peak Measurements below 1GHz

1. Analyzer center frequency was set to the frequency of the radiated spurious emission of interest
2. Span was set greater than 1MHz
3. RBW = 120 kHz
4. Detector = CISPR quasi-peak
5. Sweep time = auto couple
6. Trace was allowed to stabilize

Average Measurements above 1GHz (Method AD)

1. Analyzer center frequency was set to the frequency of the radiated spurious emission of interest
2. RBW = 1MHz
3. VBW = 3MHz
4. Detector = power average (Average)
5. Number of measurement points = 1001 (Number of points must be $> 2 \times \text{span/RBW}$)
6. Sweep time = auto
7. Trace was averaged over at 100 sweeps

Quasi-Peak & Average Measurements below 30MHz

1. Analyzer center frequency was set to the frequency of the radiated spurious emission of interest
2. Span was set greater than 1MHz
3. RBW = 200Hz for 9kHz to 150kHz frequency; RBW = 9kHz for 0.15MHz to 30MHz frequency
4. Detector = CISPR quasi-peak or power average (Average)
5. Sweep time = auto couple
6. Trace was allowed to stabilize

7.8.4. Test Setup

9kHz ~ 30MHz Test Setup:

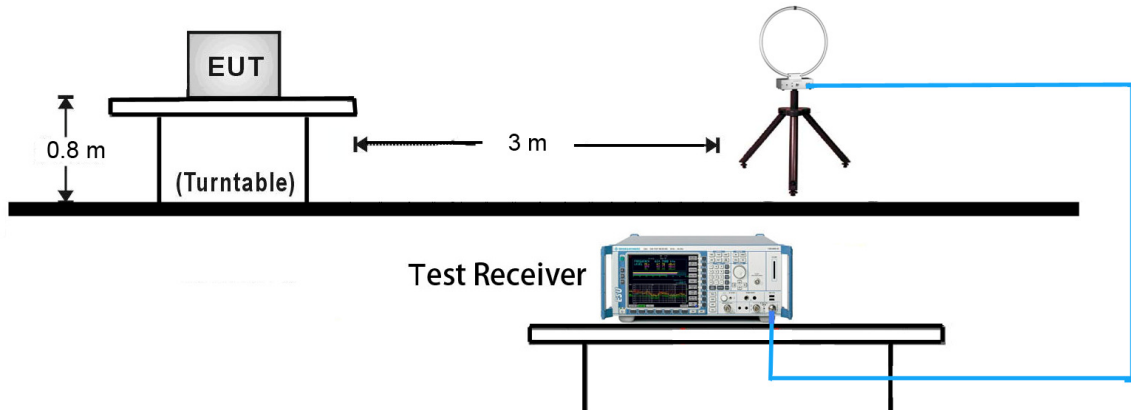

30MHz ~ 1GHz Test Setup:

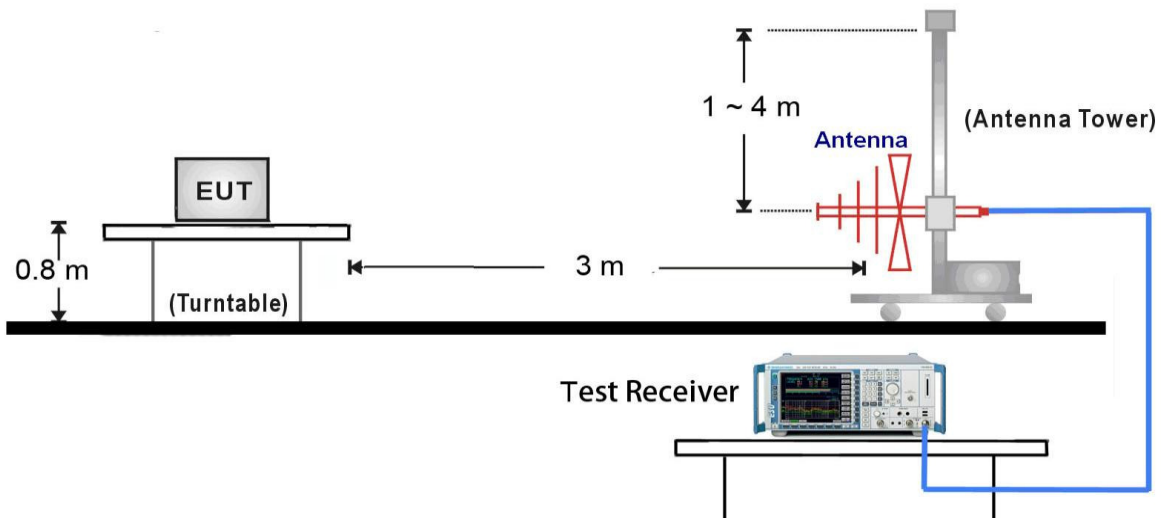

1GHz ~18GHz Test Setup:

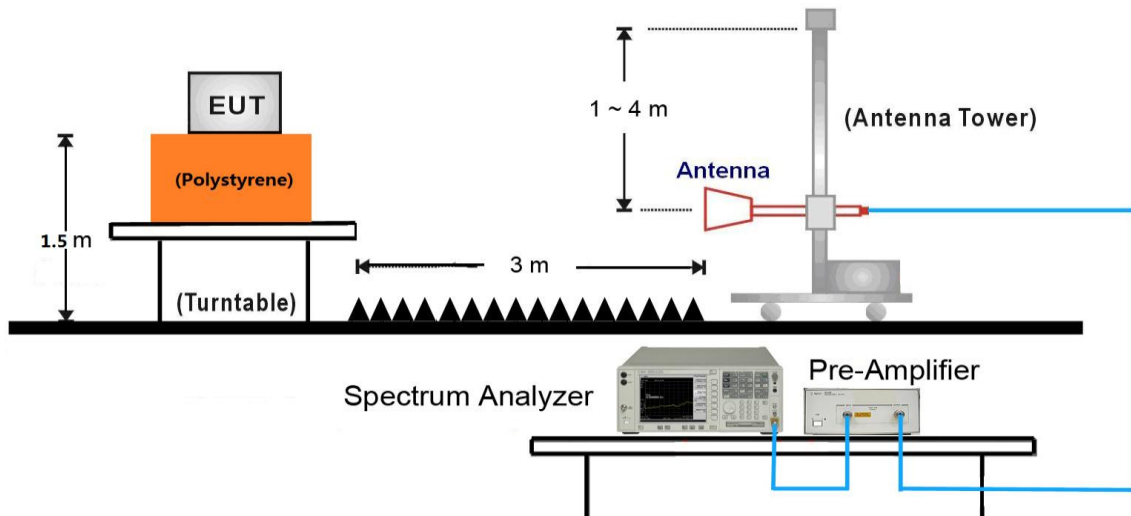

18GHz ~40GHz Test Setup:

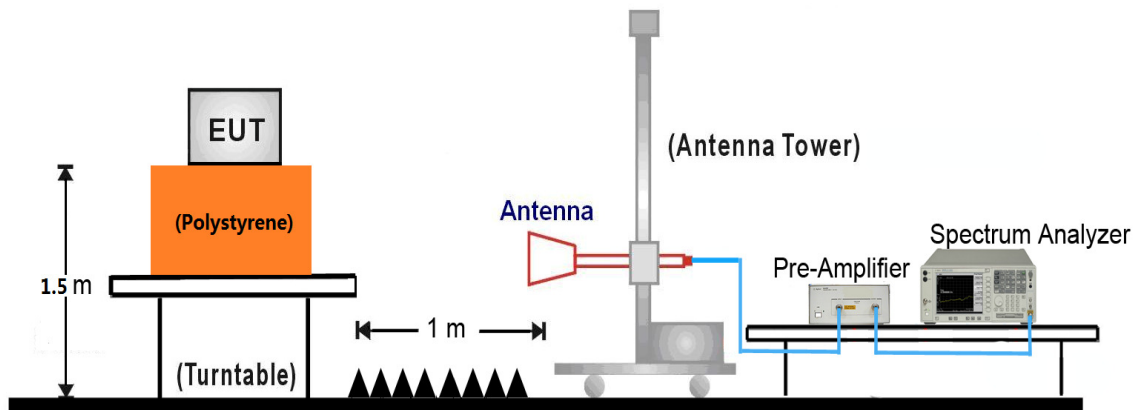

7.8.5. Test Result

Refer to "Annex D-Radiated Spurious Emission Test Result" File.

7.9. Radiated Restricted Band Edge Measurement

7.9.1. Test Limit

For 15.205 requirement:

Radiated emissions which fall in the restricted bands, as defined in Section 15.205(a) of FCC part 15, must also comply with the radiated emission limits specified in Section 15.209(a).

Frequency (MHz)	Frequency (MHz)	Frequency (MHz)	Frequency (GHz)
0.090 - 0.110	16.42 - 16.423	399.9 - 410	4.5 - 5.15
¹ 0.495 - 0.505	16.69475 - 16.69525	608 - 614	5.35 - 5.46
2.1735 - 2.1905	16.80425 - 16.80475	960 - 1240	7.25 - 7.75
4.125 - 4.128	25.5 - 25.67	1300 - 1427	8.25 - 8.5
4.17725 - 4.17775	37.5 - 38.25	1435 - 1626.5	9.0 - 9.2
4.20725 - 4.20775	73 - 74.6	1645.5 - 1646.5	9.3 - 9.5
6.215 - 6.218	74.8 - 75.2	1660 - 1710	10.6 - 12.7
6.26775 - 6.26825	108 - 121.94	1718.8 - 1722.2	13.25 - 13.4
6.31175 - 6.31225	123 - 138	2200 - 2300	14.47 - 14.5
8.291 - 8.294	149.9 - 150.05	2310 - 2390	15.35 - 16.2
8.362 - 8.366	156.52475 - 156.525	2483.5 - 2500	17.7 - 21.4
8.37625 - 8.38675	156.7 - 156.9	2690 - 2900	22.01 - 23.12
8.41425 - 8.41475	162.0125 - 167.17	3260 - 3267	23.6 - 24.0
12.29 - 12.293	167.72 - 173.2	3332 - 3339	31.2 - 31.8
12.51975 - 12.52025	240 - 285	3345.8 - 3358	36.43 - 36.5
12.57675 - 12.57725	322 - 335.4	3600 - 4400	(²)
13.36 - 13.41	--	--	--

For RSS-Gen Section 8.10 Requirement:

Radiated emissions which fall in the restricted bands, as defined in Section 8.10 of RSS-Gen, must also comply with the radiated emission limits specified in Section 8.9.

Frequency (MHz)	Frequency (MHz)	Frequency (GHz)
0.009 ~ 0.110	240 ~ 285	9.0 ~ 9.2

2.1735 ~ 2.1905	322 ~ 335.4	9.3 ~ 9.5
3.020 ~ 3.026	399.9 ~ 410	10.6 ~ 12.7
4.125 ~ 4.128	608 ~ 614	13.25 ~ 13.4
4.17725 ~ 4.17775	960 ~ 1427	14.47 ~ 14.5
4.20725 ~ 4.20775	1435 ~ 1626.5	15.35 ~ 16.2
5.677 ~ 5.683	1645.5 ~ 1646.5	17.7 ~ 21.4
6.215 ~ 6.218	1660 ~ 1710	22.01 ~ 23.12
6.26775 ~ 6.26825	1718.8 ~ 1722.2	23.6 ~ 24.0
6.31175 ~ 6.31225	2200 ~ 2300	31.2 ~ 31.8
8.291 ~ 8.294	2310 ~ 2390	36.43 ~ 36.5
8.362 ~ 8.366	2655 ~ 2900	Above 38.6
8.37625 ~ 8.38675	3260 ~ 3267	--
8.41425 ~ 8.41475	3332 ~ 3339	
12.29 ~ 12.293	334.5 ~ 3358	
12.51975 ~ 12.52025	3500 ~ 4400	
12.57675 ~ 12.57725	4500 ~ 5150	
13.36 ~ 13.41	5350 ~ 5460	
16.42 ~ 16.423	7250 ~ 7750	
16.69475 ~ 16.69525	8025 ~ 8500	
16.80425 ~ 16.80475	--	
25.5 ~ 25.67		
37.5 ~ 38.25		
73 ~ 74.6		
74.8 ~ 75.2		
108 ~ 138		
156.52475 ~ 156.525225		
156.7 ~ 156.9		

Note: *Certain frequency bands listed in Table 6 and in bands above 38.6 GHz are designated for licence-exempt applications. These frequency bands and the requirements that apply to the devices are set out in the 200- and 300-series of RSSs, such as RSS-210 and RSS-310, which contain the requirements that apply to licence-exempt radio apparatus.

For 15.407(b) requirement:

For transmitters operating in the 5.15-5.25 GHz band: All emissions outside of the 5.15-5.35 GHz band shall not exceed an e.i.r.p. of -27 dBm/MHz.

For transmitters operating in the 5.25-5.35 GHz band: All emissions outside of the 5.15-5.35 GHz band shall not exceed an e.i.r.p. of -27 dBm/MHz.

For transmitters operating in the 5.47-5.725 GHz band: All emissions outside of the 5.47-5.725 GHz band shall not exceed an e.i.r.p. of -27 dBm/MHz.

For transmitters operating in the 5.725-5.85 GHz band: All emissions within the frequency range from the band edge to 10 MHz above or below the band edge shall not exceed an e.i.r.p. of -17 dBm/MHz; for frequencies 10 MHz or greater above or below the band edge, emissions shall not exceed an e.i.r.p. of -27 dBm/MHz.

Refer to KDB 789033 D02v01r03 G)2)c), as specified in § 15.407(b), emissions above 1000 MHz that are outside of the restricted bands are subject to a maximum emission limit of -27 dBm/MHz (or -17 dBm/MHz as specified in § 15.407(b)(4)). However, an out-of-band emission that complies with both the peak and average limits of § 15.209 is not required to satisfy the -27 dBm/MHz or -17 dBm/MHz maximum emission limit.

All out of band emissions appearing in a restricted band as specified in Section 15.205 of the Title 47 CFR must not exceed the limits shown in Table per Section 15.209.

FCC Part 15 Subpart C Paragraph 15.209		
Frequency [MHz]	Field Strength [V/m]	Measured Distance [Meters]
0.009 ~ 0.490	2400/F (kHz)	300
0.490 ~ 1.705	24000/F (kHz)	30
1.705 ~ 30	30	30
30 ~ 88	100	3
88 ~ 216	150	3
216 ~ 960	200	3
Above 960	500	3

7.9.2. Test Result

Refer to “Annex E-Radiated Bandedge Test Result” File.

7.10. AC Conducted Emissions Measurement

7.10.1. Test Limit

FCC Part 15.207 Limits		
Frequency (MHz)	QP (dB μ V)	AV (dB μ V)
0.15 ~ 0.50	66 ~ 56	56 ~ 46
0.50 ~ 5.0	56	46
5.0 ~ 30	60	50

Note 1: The lower limit shall apply at the transition frequencies.

Note 2: The limit decreases linearly with the logarithm of the frequency in the range 0.15MHz to 0.5MHz.

7.10.2. Test Procedure

The EUT was setup according to ANSI C63.4, 2009 and tested according to KDB 789033 for compliance to FCC 47CFR 15.247 requirements. The EUT was placed on a platform of nominal size, 1 m by 1.5 m, raised 80 cm above the conducting ground plane. The vertical conducting plane was located 40 cm to the rear of the EUT. All other surfaces of EUT were at least 80 cm from any other grounded conducting surface. The EUT and simulators are connected to the main power through a line impedance stabilization network (LISN). The LISN provides a 50 ohm /50uH coupling impedance for the measuring equipment. The peripheral devices are also connected to the main power through a LISN. (Please refer to the block diagram of the test setup and photographs) Each current-carrying conductor of the EUT power cord, except the ground (safety) conductor, was individually connected through a LISN to the input power source.

The excess length of the power cord between the EUT and the LISN receptacle were folded back and forth at the center of the lead to form a bundle not exceeding 40 cm in length.

Conducted emissions were investigated over the frequency range from 0.15MHz to 30MHz using a receiver bandwidth of 9 kHz.

7.10.3. Test Setup

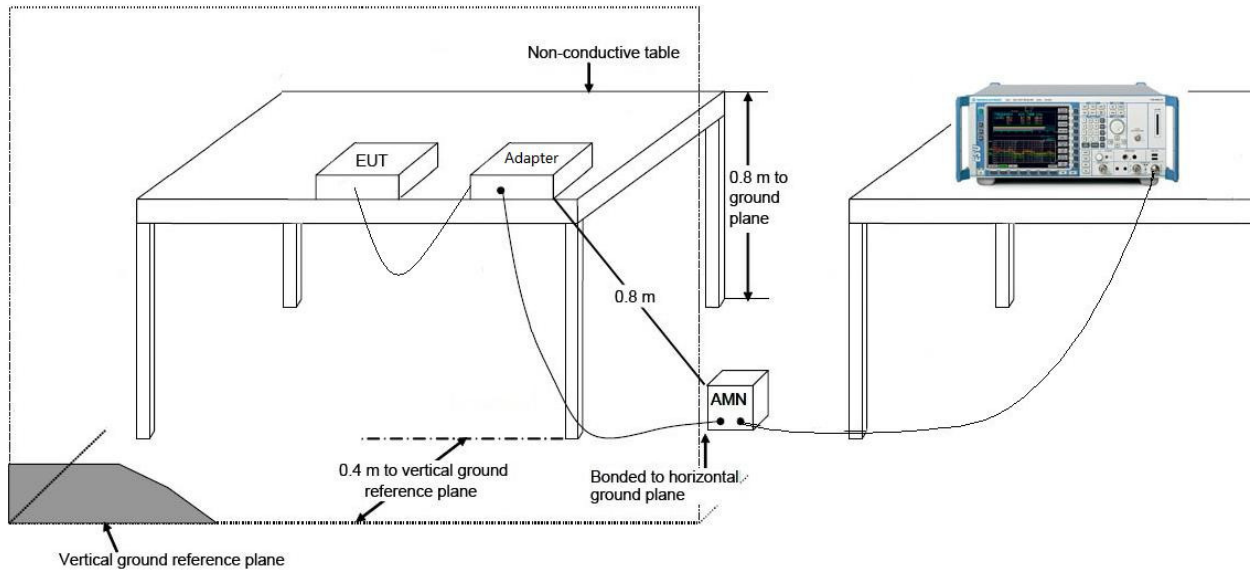

7.10.4. Test Result

Site: SR2	Time: 2016/12/16 - 10:15
Limit: FCC_Part15.207_CE_AC Power	Engineer: Kevin Ke
Probe: ENV216_101683_Filter On	Polarity: Line
EUT: US Wi-Fi AP 4X4 OD ext. antenna	Power: AC 120V/60Hz
Test Mode 1	

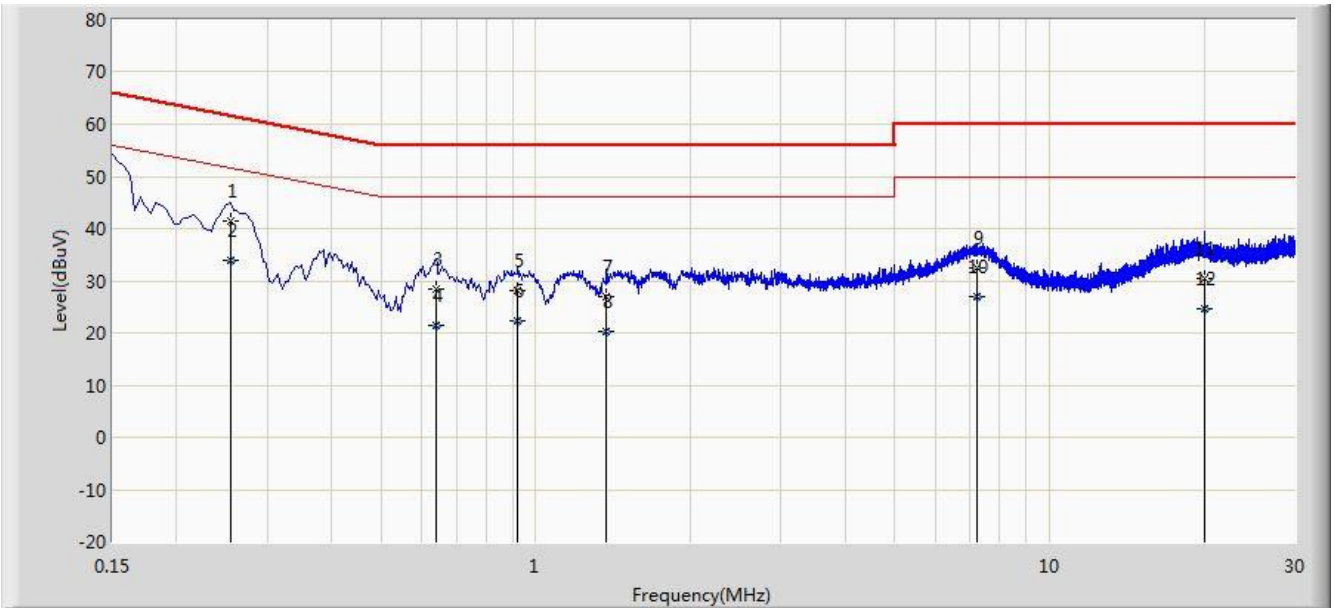

No	Flag	Mark	Frequency (MHz)	Measure Level (dBuV)	Reading Level (dBuV)	Over Limit (dB)	Limit (dBuV)	Factor	Type
1			0.254	41.553	31.585	-20.073	61.625	9.967	QP
2		*	0.254	33.973	24.005	-17.653	51.625	9.967	AV
3			0.638	28.470	18.375	-27.530	56.000	10.095	QP
4			0.638	21.541	11.446	-24.459	46.000	10.095	AV
5			0.922	28.101	18.153	-27.899	56.000	9.948	QP
6			0.922	22.386	12.437	-23.614	46.000	9.948	AV
7			1.374	27.032	17.138	-28.968	56.000	9.894	QP
8			1.374	20.315	10.421	-25.685	46.000	9.894	AV
9			7.218	32.493	22.332	-27.507	60.000	10.161	QP
10			7.218	26.973	16.811	-23.027	50.000	10.161	AV
11			20.038	30.371	20.232	-29.629	60.000	10.139	QP
12			20.038	24.541	14.401	-25.459	50.000	10.139	AV

Note: Measure Level (dBμV) = Reading Level (dBμV) + Factor (dB)

Factor (dB) = Cable Loss (dB) + LISN Factor (dB)

Site: SR2	Time: 2016/12/16 - 10:26
Limit: FCC_Part15.207_CE_AC Power	Engineer: Kevin Ke
Probe: ENV216_101683_Filter On	Polarity: Neutral
EUT: US Wi-Fi AP 4X4 OD ext. antenna	Power: AC 120V/60Hz
Test Mode 1	

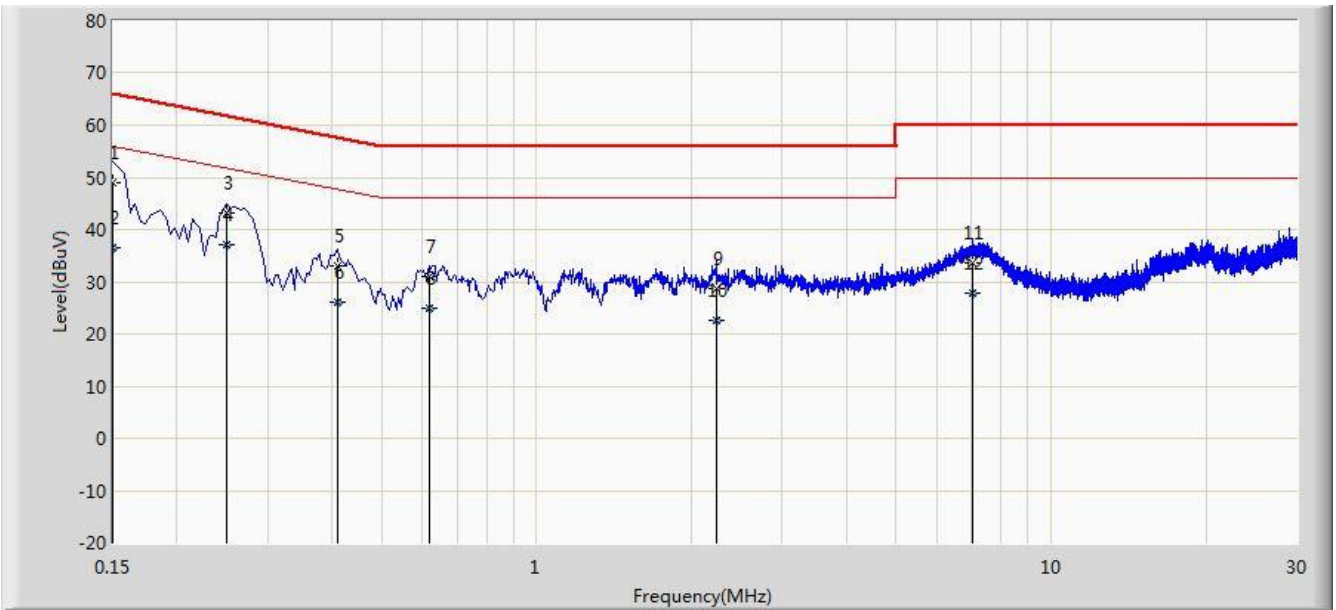

No	Flag	Mark	Frequency (MHz)	Measure Level (dBuV)	Reading Level (dBuV)	Over Limit (dB)	Limit (dBuV)	Factor	Type
1			0.150	49.097	37.955	-16.903	66.000	11.142	QP
2			0.150	36.546	25.404	-19.454	56.000	11.142	AV
3			0.250	43.182	33.181	-18.575	61.757	10.001	QP
4		*	0.250	37.161	27.160	-14.596	51.757	10.001	AV
5			0.410	32.995	22.876	-24.653	57.648	10.119	QP
6			0.410	26.069	15.950	-21.579	47.648	10.119	AV
7			0.618	30.985	20.863	-25.015	56.000	10.121	QP
8			0.618	24.815	14.693	-21.185	46.000	10.121	AV
9			2.230	28.552	18.684	-27.448	56.000	9.868	QP
10			2.230	22.567	12.699	-23.433	46.000	9.868	AV
11			7.018	33.551	23.384	-26.449	60.000	10.167	QP
12			7.018	27.939	17.772	-22.061	50.000	10.167	AV

Note: Measure Level (dBμV) = Reading Level (dBμV) + Factor (dB)

Factor (dB) = Cable Loss (dB) + LISN Factor (dB)

8. CONCLUSION

The data collected relate only the item(s) tested and show that the **US Wi-Fi AP 4X4 OD ext. antenna FCC ID: 2AD8UFZCWO4A1** is in compliance with Part 15E of the FCC Rules.

————— The End —————