

DFS MEASUREMENT REPORT

FCC PART 15 Subpart E WLAN 802.11a/n/ac

FCC ID: 2AD8UFZCWMBOM2

APPLICANT: Nokia Solutions and Networks, OY

Application Type: Certification

Product: AC220m Wi-Fi module OD US

Model No.: FZCWMBOM2

Brand Name: NOKIA

FCC Classification: Unlicensed National Information Infrastructure (NII)

FCC Rule Part(s): Part 15 Subpart E - 15.407 Section (h)(2)
KDB 905462 D02v02, KDB 905462 D04v01

Type of Device: Master Device
 Client Device (No radar detection)
 Client Device with radar detection

Test Date: December 10 ~ 23, 2017

Reviewed By : Paddy Chen
(Paddy Chen)

Approved By : Chenz Ker
(Chenz Ker)



The test results relate only to the samples tested.

This equipment has been shown to be capable of compliance with the applicable technical standards as indicated in the measurement report and was tested in accordance with the measurement procedures specified in KDB 905462 D02v02. Test results reported herein relate only to the item(s) tested.

The test report shall not be reproduced except in full without the written approval of MRT Technology (Taiwan) Co., Ltd.

Revision History

Report No.	Version	Description	Issue Date	Note
1712TW0104-U7	Rev. 01	Initial Report	05-17-2018	Valid

CONTENTS

Description	Page
§2.1033 General Information	5
1. INTRODUCTION	6
1.1. Scope	6
1.2. MRT Test Location	6
2. PRODUCT INFORMATION	7
2.1. Equipment Description.....	7
2.2. Description of Available Antennas.....	8
2.3. Description of Antenna RF Port	9
2.4. DFS Band Carrier Frequencies Operation	10
2.5. Test Mode	10
3. DFS DETECTION THRESHOLDS AND RADAR TEST WAVEFORMS.....	11
3.1. Applicability	11
3.2. DFS Devices Requirements.....	12
3.3. DFS Detection Threshold Values	13
3.4. Parameters of DFS Test Signals	14
3.5. Conducted Test Setup	17
4. TEST EQUIPMENT CALIBRATION DATE	18
5. TEST RESULT	19
5.1. Summary	19
5.2. Radar Waveform Calibration.....	20
5.2.1. Calibration Setup	20
5.2.2. Calibration Procedure	20
5.2.3. Calibration Result	21
5.2.4. Channel Loading Test Result	23
5.3. NII Detection Bandwidth Measurement.....	24
5.3.1. Test Limit	24
5.3.2. Test Procedure	24
5.3.3. Test Result.....	25
5.4. Initial Channel Availability Check Time Measurement	28
5.4.1. Test Limit	28
5.4.2. Test Procedure	28
5.4.3. Test Result.....	29
5.5. Radar Burst at the Beginning of the Channel Availability Check Time Measurement ..	30
5.5.1. Test Limit	30

5.5.2. Test Procedure	30
5.5.3. Test Result.....	31
5.6. Radar Burst at the End of the Channel Availability Check Time Measurement	32
5.6.1. Test Limit	32
5.6.2. Test Procedure	32
5.6.3. Test Result.....	33
5.7. In-Service Monitoring for Channel Move Time, Channel Closing Transmission Time and Non-Occupancy Period Measurement	34
5.7.1. Test Limit	34
5.7.2. Test Procedure Used	34
5.7.3. Test Result.....	35
5.8. Statistical Performance Check Measurement.....	37
5.8.1. Test Limit	37
5.8.2. Test Procedure	37
5.8.3. Test Result.....	38
6. CONCLUSION.....	119

§2.1033 General Information

Applicant:	Nokia Solutions and Networks, OY
Applicant Address:	2000 W. Lucent Lane, Naperville, Illinois, United States, 60563
Manufacturer:	Nokia Solutions and Networks, OY
Manufacturer Address:	2000 W. Lucent Lane, Naperville, Illinois, United States, 60563
Test Site:	MRT Technology (Taiwan) Co., Ltd
Test Site Address:	No. 38, Fuxing Second Rd., Guishan Dist., Taoyuan City 333, Taiwan (R.O.C)
FCC Registration No.:	153292
FCC Rule Part(s):	Part 15 Subpart E - 15.407 Section (h)(2)
Test Device Serial No.:	N/A <input type="checkbox"/> Production <input checked="" type="checkbox"/> Pre-Production <input type="checkbox"/> Engineering

Test Facility / Accreditations

Measurements were performed at MRT Laboratory located in Fuxing Rd., Taoyuan, Taiwan (R.O.C)

- MRT facility is a FCC registered (Reg. No. 153292) test facility with the site description report on file and is designated by the FCC as an Accredited Test Film.
- MRT facility is an IC registered (MRT Reg. No. 21723-1) test laboratory with the site description on file at Industry Canada.
- MRT Lab is accredited to ISO 17025 by the American Association for Laboratory Accreditation (TAF) under the American Association for Laboratory Accreditation Program (TAF Cert. No. 3261) in EMC, Telecommunications and Radio testing for FCC, Industry Taiwan, EU and TELEC Rules.

1. INTRODUCTION

1.1. Scope

Measurement and determination of electromagnetic emissions (EMC) of radio frequency devices including intentional and/or unintentional radiators for compliance with the technical rules and regulations of the Federal Communications Commission and the Industry Canada Certification and Engineering Bureau.

1.2. MRT Test Location

The map below shows the location of the MRT LABORATORY, its proximity to the Taoyuan City. These measurement tests were conducted at the MRT Technology (Taiwan) Co., Ltd. Facility located at No.38, Fuxing 2nd Rd., Guishan Dist., Taoyuan City 33377, Taiwan (R.O.C).

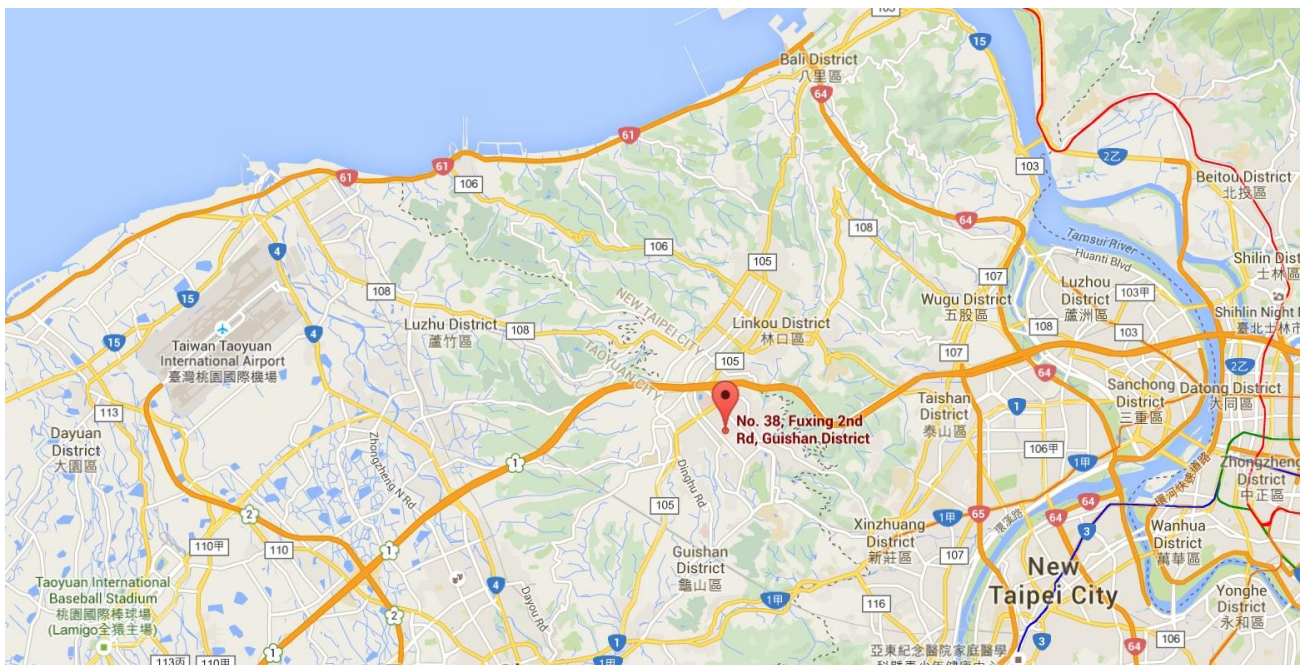



2. PRODUCT INFORMATION

2.1. Equipment Description

Product Name:	AC220m Wi-Fi module OD US
Model No.:	FZCWMBOM2
Brand Name:	NOKIA
Wi-Fi Specification:	802.11a/b/g/n/ac
Frequency Range	<p><u>2.4GHz:</u> For 802.11b/g/n-HT20: 2412 ~ 2462 MHz For 802.11n-HT40: 2422 ~ 2452 MHz</p> <p><u>5GHz:</u> For 802.11a/n-HT20/ac-VHT20:5180~5320MHz, 5500~5720MHz, 5745~5825MHz For 802.11n-HT40/ac-VHT40:5190~5310MHz, 5510~5710MHz, 5755~5795MHz For 802.11ac-VHT80:5210MHz, 5290MHz, 5530MHz, 5610MHz, 5690MHz, 5775MHz</p>
Type of Modulation	802.11b: DSSS, 802.11a/g/n/ac: OFDM
Modulation Type	CCK, DQPSK, DBPSK for DSSS 16QAM, 64QAM, 256QAM, QPSK, BPSK for OFDM
Power-on cycle	Requires 78.8 seconds to complete its power-on cycle
Uniform Spreading (For DFS Frequency Band)	For the 5250-5350MHz, 5470-5725 MHz bands, the Master device provides, on aggregate, uniform loading of the spectrum across all devices by selecting an operating channel among the available channels using a random algorithm.

2.2. Description of Available Antennas

Antenna	Manufacturer	Frequency Band (GHz)	Antenna Name	Tx Paths
	Nokia	2.4	473171A / FAWH (WiFi Omni Antenna)	2
		5		2
	Nokia	2.4	474073A / FA2NB (WiFi Directional Antenna)	2
		5		2

Note: The manufacture has provided an antenna cable to connect WiFi Omni Antenna with EUT, and the cable loss is: 0.45dB Max @ 0~3 GHz; 0.75dB Max @ 0~6 GHz

Frequency Band (MHz)	TX Paths	Per Chain Max Antenna Gain (dBi)		Beam Forming Directional Gain (dBi)	CDD Directional Gain(dBi)	
		Ant 0	Ant 1		For Power	For PSD
WiFi Omni Antenna (execute the DFS test)						
2412 ~ 2462	2	4.0	4.0	7.01	4.00	7.01
5150 ~ 5250	2	7.0	7.0	10.01	7.00	10.01
5150 ~ 5250 (30 Degree)	2	7.0	7.0	10.01	N/A	N/A
5250 ~ 5350	2	7.0	7.0	10.01	7.00	10.01
5470 ~ 5725	2	7.0	7.0	10.01	7.00	10.01
5725 ~ 5850	2	7.0	7.0	10.01	7.00	10.01
WiFi Directional Antenna						
2412 ~2462	2	7.7	8.5	11.12	8.5	11.51
5150 ~ 5250	2	8.3	9.5	11.93	9.5	12.51
5150 ~ 5250 (30 Degree)	2	-2.7	-3.6	-0.13	N/A	N/A
5250 ~ 5350	2	8.1	9.5	11.84	9.5	12.51
5470 ~ 5725	2	9.9	9.6	12.76	9.9	12.91
5725 ~ 5850	2	9.0	8.8	11.91	9.0	12.01

Note1: The EUT supports Cyclic Delay Diversity (CDD) technology for 802.11a/b/g mode, and CDD signals are correlated.

Note 2: The EUT supports Beam Forming technology for 802.11n/ac mode.

Note 3: For CDD transmissions, directional gain is calculated as follows, $N_{ANT} = 2$, $N_{SS} = 1$.

Two antennas have the same gain, G_{ANT} , Directional gain = G_{ANT} + Array Gain, where Array Gain is as follows.

- For power spectral density (PSD) measurements on all devices,

Array Gain = $10 \log (N_{ANT} / N_{SS})$ dB = 3.01;

- For power measurements on IEEE 802.11 devices,

Array Gain = 0 dB for $N_{ANT} \leq 4$;

Note 4: For Beam Forming transmissions, directional gain = $10 \cdot \log [(10^{G1/20} + 10^{G2/20} + \dots + 10^{GN/20})^2 / N_{ANT}]$ dBi.

2.3. Description of Antenna RF Port

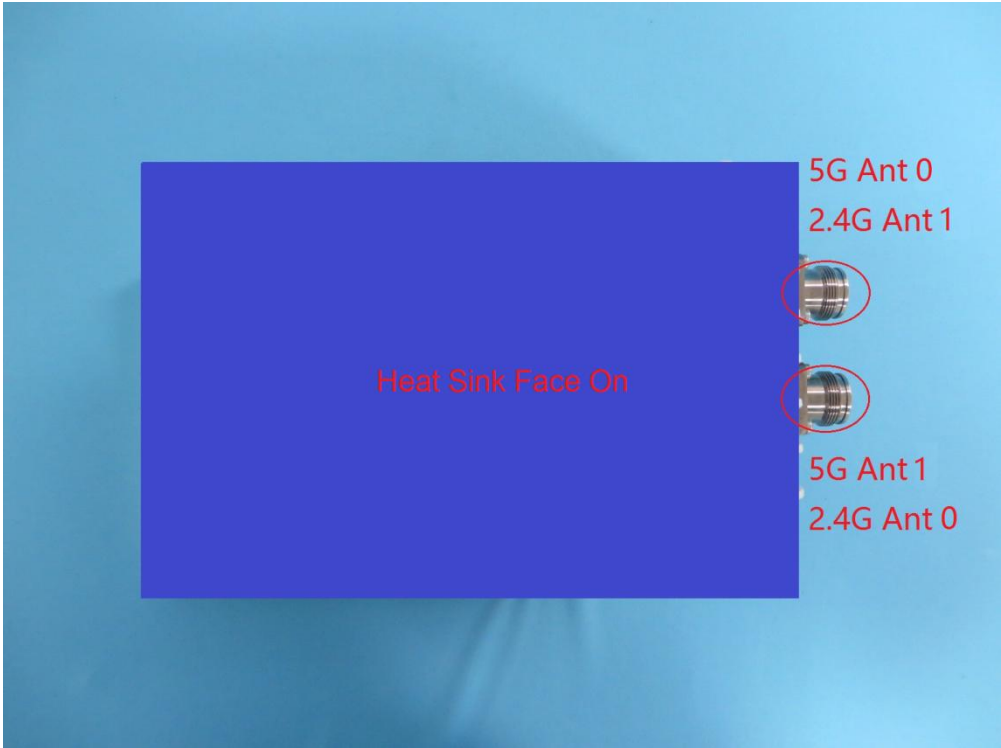
Antenna RF Port				
--	2.4GHz RF Port		5GHz RF Port	
Software Control Port	Ant 0	Ant 1	Ant 0	Ant 1
				

2.4. DFS Band Carrier Frequencies Operation

802.11 a/n-HT20/ac-VHT20

Channel	Frequency	Channel	Frequency	Channel	Frequency
52	5260 MHz	56	5280 MHz	60	5300 MHz
64	5320 MHz	100	5500 MHz	104	5520 MHz
108	5540 MHz	112	5560 MHz	116	5580 MHz
120	5600 MHz	124	5620 MHz	128	5640 MHz
132	5660 MHz	136	5680 MHz	140	5700 MHz
144	5720 MHz	--	--	--	--

802.11n-HT40/ ac-VHT40

Channel	Frequency	Channel	Frequency	Channel	Frequency
54	5270 MHz	62	5310 MHz	102	5510 MHz
110	5550 MHz	118	5590 MHz	126	5630 MHz
134	5670 MHz	--	--	--	--

802.11ac-VHT80

Channel	Frequency	Channel	Frequency	Channel	Frequency
58	5290 MHz	106	5530 MHz	122	5610 MHz
138	5690 MHz	--	--	--	--

2.5. Test Mode

Test Mode	Mode 1: Communication with Notebook
-----------	-------------------------------------

3. DFS DETECTION THRESHOLDS AND RADAR TEST WAVEFORMS

3.1. Applicability

The following table from FCC KDB 905462 D02 NII DFS Compliance Procedures New Rules v02 lists the applicable requirements for the DFS testing.

Requirement	Operational Mode		
	Master	Client Without Radar Detection	Client With Radar Detection
Non-Occupancy Period	Yes	Not required	Yes
DFS Detection Threshold	Yes	Not required	Yes
Channel Availability Check Time	Yes	Not required	Not required
U-NII Detection Bandwidth	Yes	Not required	Yes

Table 3-1: Applicability of DFS Requirements Prior to Use of a Channel

Requirement	Operational Mode	
	Master Device or Client With Radar Detection	Client Without Radar Detection
DFS Detection Threshold	Yes	Not required
Channel Closing Transmission Time	Yes	Yes
Channel Move Time	Yes	Yes
U-NII Detection Bandwidth	Yes	Not required

Additional requirements for devices with multiple bandwidth modes	Master Device or Client with Radar Detection	Client Without Radar Detection
U-NII Detection Bandwidth and Statistical Performance Check	All BW modes must be tested	Not required
Channel Move Time and Channel Closing Transmission Time	Test using widest BW mode available	Test using the widest BW mode available for the link
All other tests	Any single BW mode	Not required

Note: Frequencies selected for statistical performance check should include several frequencies within the radar detection bandwidth and frequencies near the edge of the radar detection bandwidth. For 802.11 devices it is suggested to select frequencies in each of the bonded 20 MHz channels and the channel center frequency.

Table 3-2: Applicability of DFS Requirements during normal operation

3.2. DFS Devices Requirements

Per FCC KDB 905462 D02 NII DFS Compliance Procedures New Rules v02 the following are the requirements for Master Devices:

- (a) The Master Device will use DFS in order to detect Radar Waveforms with received signal strength above the DFS Detection Threshold in the 5250 ~ 5350 MHz and 5470 ~ 5725 MHz bands. DFS is not required in the 5150 ~ 5250 MHz or 5725 ~ 5825 MHz bands.
- (b) Before initiating a network on a Channel, the Master Device will perform a Channel Availability Check for a specified time duration (Channel Availability Check Time) to ensure that there is no radar system operating on the Channel, using DFS described under subsection a) above.
- (c) The Master Device initiates a U-NII network by transmitting control signals that will enable other U-NII devices to Associate with the Master Device.
- (d) During normal operation, the Master Device will monitor the Channel (In-Service Monitoring) to ensure that there is no radar system operating on the Channel, using DFS described under a).
- (e) If the Master Device has detected a Radar Waveform during In-Service Monitoring as described under d), the Operating Channel of the U-NII network is no longer an Available Channel. The Master Device will instruct all associated Client Device(s) to stop transmitting on this Channel within the Channel Move Time. The transmissions during the Channel Move Time will be limited to the Channel Closing Transmission Time.
- (f) Once the Master Device has detected a Radar Waveform it will not utilize the Channel for the duration of the Non-Occupancy Period.
- (g) If the Master Device delegates the In-Service Monitoring to a Client Device, then the combination will be tested to the requirements described under d) through f) above.

Channel Move Time and Channel Closing Transmission Time requirements are listed in the following table.

Parameter	Value
Non-occupancy period	Minimum 30 minutes
Channel Availability Check Time	60 seconds
Channel Move Time	10 seconds See Note 1.
Channel Closing Transmission Time	200 milliseconds + an aggregate of 60 milliseconds over remaining 10 second period. See Notes 1 and 2.
U-NII Detection Bandwidth	Minimum 100% of the U-NII 99% transmission power bandwidth. See Note 3.

Note 1: Channel Move Time and the Channel Closing Transmission Time should be performed with Radar Type 0. The measurement timing begins at the end of the Radar Type 0 burst.

Note 2: The Channel Closing Transmission Time is comprised of 200 milliseconds starting at the beginning of the Channel Move Time plus any additional intermittent control signals required to facilitate a Channel move (an aggregate of 60 milliseconds) during the remainder of the 10 second period. The aggregate duration of control signals will not count quiet periods in between transmissions.

Note 3: During the U-NII Detection Bandwidth detection test, radar type 0 should be used. For each frequency step the minimum percentage of detection is 90 percent. Measurements are performed with no data traffic.

Table 3-3: DFS Response Requirements

3.3. DFS Detection Threshold Values

The DFS detection thresholds are defined for Master devices and Client Devices with In-service monitoring. These detection thresholds are listed in the following table.

Maximum Transmit Power	Value (See Notes 1, 2, and 3)
EIRP ≥ 200 milliwatt	-64 dBm
EIRP < 200 milliwatt and power spectral density < 10 dBm/MHz	-62 dBm
EIRP < 200 milliwatt that do not meet the power spectral density requirement	-64 dBm

Note 1: This is the level at the input of the receiver assuming a 0 dBi receive antenna.

Note 2: Throughout these test procedures an additional 1 dB has been added to the amplitude of the test transmission waveforms to account for variations in measurement equipment. This will ensure that the test signal is at or above the detection threshold level to trigger a DFS response.

Note 3: EIRP is based on the highest antenna gain. For MIMO devices refer to KDB Publication 662911 D01.

Table 3-4: Detection Thresholds for Master Devices and Client Devices with Radar Detection

3.4. Parameters of DFS Test Signals

This section provides the parameters for required test waveforms, minimum percentage of successful detections, and the minimum number of trials that must be used for determining DFS conformance. Step intervals of 0.1 microsecond for Pulse Width, 1 microsecond for PRI, 1 MHz for chirp width and 1 for the number of pulses will be utilized for the random determination of specific test waveforms.

Short Pulse Radar Test Waveforms

Radar Type	Pulse Width (μsec)	PRI (μsec)	Number of Pulses	Minimum Percentage of Successful Detection	Minimum Number of Trials
0	1	1428	18	See Note 1	See Note 1
1	1	Test A: 15 unique PRI values randomly selected from the list of 23 PRI values in Table 3-6	$\text{Roundup} \left\{ \left(\frac{1}{360} \right), \left(\frac{19 \cdot 10^6}{\text{PRI}_{\mu\text{sec}}} \right) \right\}$	60%	30
		Test B: 15 unique PRI values randomly selected within the range of 518-3066 μsec, with a minimum increment of 1 μsec, excluding PRI values selected in Test A			
2	1-5	150-230	23-29	60%	30
3	6-10	200-500	16-18	60%	30
4	11-20	200-500	12-16	60%	30
Aggregate (Radar Types 1-4)				80%	120
Note 1: Short Pulse Radar Type 0 should be used for the detection bandwidth test, channel move time, and channel closing time tests.					

Table 3-5: Parameters for Short Pulse Radar Waveforms

A minimum of 30 unique waveforms are required for each of the Short Pulse Radar Types 2 through 4. If more than 30 waveforms are used for Short Pulse Radar Types 2 through 4, then each additional waveform must also be unique and not repeated from the previous waveforms.

Pulse Repetition Frequency Number	Pulse Repetition Frequency (Pulses Per Second)	Pulse Repetition Interval (Microseconds)
1	1930.5	518
2	1858.7	538
3	1792.1	558
4	1730.1	578
5	1672.2	598
6	1618.1	618
7	1567.4	638
8	1519.8	658
9	1474.9	678
10	1432.7	698
11	1392.8	718
12	1355	738
13	1319.3	758
14	1285.3	778
15	1253.1	798
16	1222.5	818
17	1193.3	838
18	1165.6	858
19	1139	878
20	1113.6	898
21	1089.3	918
22	1066.1	938
23	326.2	3066

Table 3-6: Pulse Repetition Intervals Values for Test A

Long Pulse Radar Test Waveform

Radar Type	Pulse Width (μsec)	Chirp Width (MHz)	PRI (μsec)	Number of Pulses per Burst	Number of Bursts	Minimum Percentage of Successful Detection	Minimum Number of Trials
5	50 - 100	5 - 20	1000 - 2000	1 - 3	8 - 20	80%	30

Table 3-7: Parameters for Long Pulse Radar Waveforms

The parameters for this waveform are randomly chosen. Thirty unique waveforms are required for the Long Pulse Radar Type waveforms. If more than 30 waveforms are used for the Long Pulse Radar Type waveforms, then each additional waveform must also be unique and not repeated from the previous waveforms.

Frequency Hopping Radar Test Waveform

Radar Type	Pulse Width (μsec)	PRI (μsec)	Pulses Per Hop	Hopping Rate (kHz)	Hopping Sequence Length (msec)	Minimum Percentage of Successful Detection	Minimum Number of Trials
6	1	333	9	0.333	300	70%	30

Table 3-8: Parameters for Frequency Hopping Radar Waveforms

For the Frequency Hopping Radar Type, the same Burst parameters are used for each waveform. The hopping sequence is different for each waveform and a 100-length segment is selected from the hopping sequence defined by the following algorithm:

The first frequency in a hopping sequence is selected randomly from the group of 475 integer frequencies from 5250 – 5724MHz. Next, the frequency that was just chosen is removed from the group and a frequency is randomly selected from the remaining 474 frequencies in the group. This process continues until all 475 frequencies are chosen for the set. For selection of a random frequency, the frequencies remaining within the group are always treated as equally likely.

3.5. Conducted Test Setup

The FCC KDB 905462 D02 NII DFS Compliance Procedures New Rules v02 describes a radiated test setup and a conducted test setup. The conducted test setup was used for this testing. Figure 3-1 shows the typical test setup.

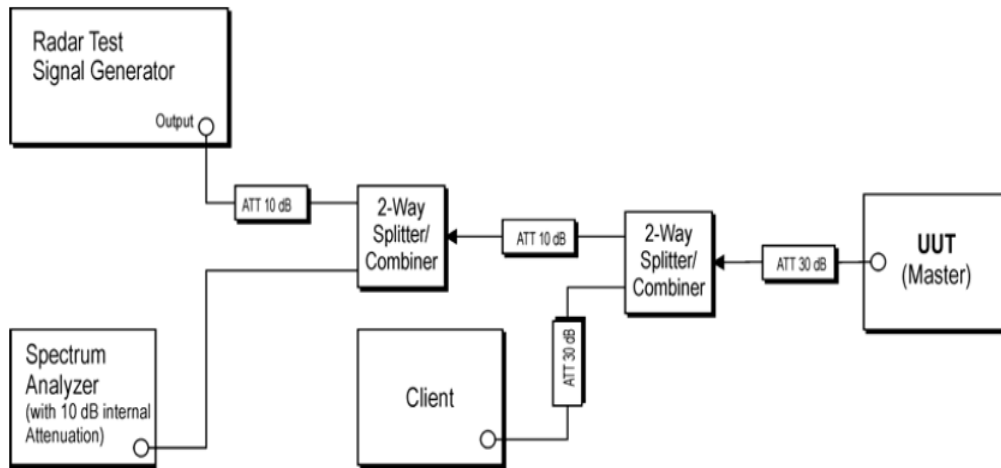

Figure 3-1: Conducted Test Setup where UUT is a Master and Radar Test Waveforms are injected into the Masters

4. TEST EQUIPMENT CALIBRATION DATE

Dynamic Frequency Selection (DFS)

Instrument	Manufacturer	Type No.	Asset No.	Cali. Interval	Cali. Due Date
EXA Signal Analyzer	KEYSIGHT	N9010A	MRTTWA00012	1 year	2018/07/10
MXG X-Series Microwave Analog Signal Generator	KEYSIGHT	N5183B	MRTTWA00013	1 year	2018/04/17
Temperature/Humidity Meter	TFA	35.1078.10.IT	MRTTWA00033	1 year	2018/06/08
Combiner	WOKEN	0120N02208001D	MRTTWA00040	1 year	N/A
Broadband Hornantenna	SCHWARZBECK	BBHA 9120D	MRTTWA00003	1 year	2019/04/05

Client Information

Instrument	Manufacturer	Type No.
Wireless Network Adapter	Intel	7260HMW

Software	Version	Manufacturer	Function
Pulse Building	N/A	Agilent	Radar Signal Generation Software
DFS Tool	V 6.9.2	Agilent	DFS Test Software

5. TEST RESULT

5.1. Summary

Company Name: Nokia Solutions and Networks, OY
FCC ID: 2AD8UFZCWMBOM2

Parameter	Limit	Test Result	Reference
NII Detection Bandwidth Measurement	Refer Table 3-3	Pass	Section 5.4
Initial Channel Availability Check Time	Refer Table 3-3	Pass	Section 5.5
Radar Burst at the Beginning of the Channel Availability Check Time	Refer Table 3-3	Pass	Section 5.6
Radar Burst at the End of the Channel Availability Check Time	Refer Table 3-3	Pass	Section 5.7
In-Service Monitoring for Channel Move Time, Channel Closing Transmission Time	Refer Table 3-3	Pass	Section 5.8
Non-Occupancy Period	Refer Table 3-3	Pass	Section 5.8
Statistical Performance Check	Refer Table 3-3	Pass	Section 5.9

5.2. Radar Waveform Calibration

5.2.1. Calibration Setup

The conducted test setup was used for this calibration testing. Figure 3-2 shows the typical test setup.

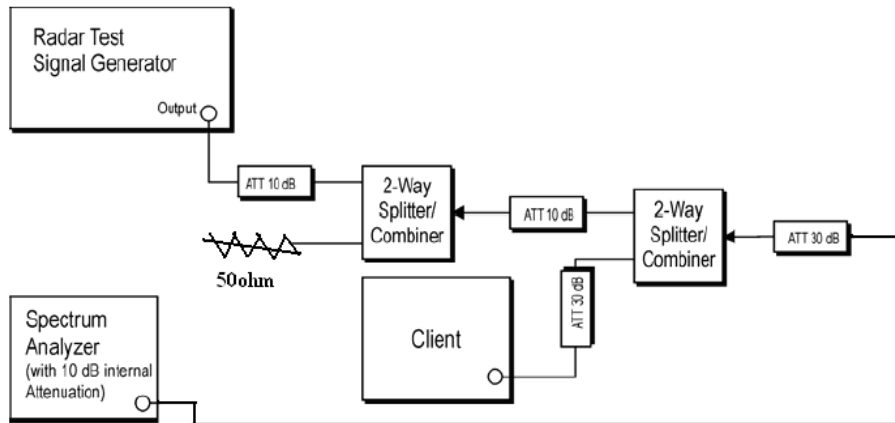

Figure 3-2: Conducted Test Setup

5.2.2. Calibration Procedure

The Interference Radar Detection Threshold Level is $(-64\text{dBm}) + (0) [\text{dBi}] + 1 \text{ dB} = -63 \text{ dBm}$ that had been taken into account the output power range and antenna gain. The above equipment setup was used to calibrate the conducted Radar Waveform. A vector signal generator was utilized to establish the test signal level for each radar type. During this process there were replace 50ohm terminal form Master and Client device and no transmissions by either the Master or Client Device. The spectrum analyzer was switched to the zero span (Time Domain) at the frequency of the Radar Waveform generator. Peak detection was used. The spectrum analyzer resolution bandwidth (RBW) and video bandwidth (VBW) were set to at least 3MHz. The vector signal generator amplitude was set so that the power level measured at the spectrum analyzer was $(-64\text{dBm}) + (0) [\text{dBi}] + 1 \text{ dB} = -63\text{dBm}$. Capture the spectrum analyzer plots on short pulse radar types, long pulse radar type and hopping radar waveform.

5.2.3. Cablibration Result

Product	AC220m Wi-Fi module OD US	Temperature	27°C
Test Engineer	Paddy Chen	Relative Humidity	65%
Test Site	TR5	Test Date	2017/12/15
Test Item	Radar Waveform Calibration		



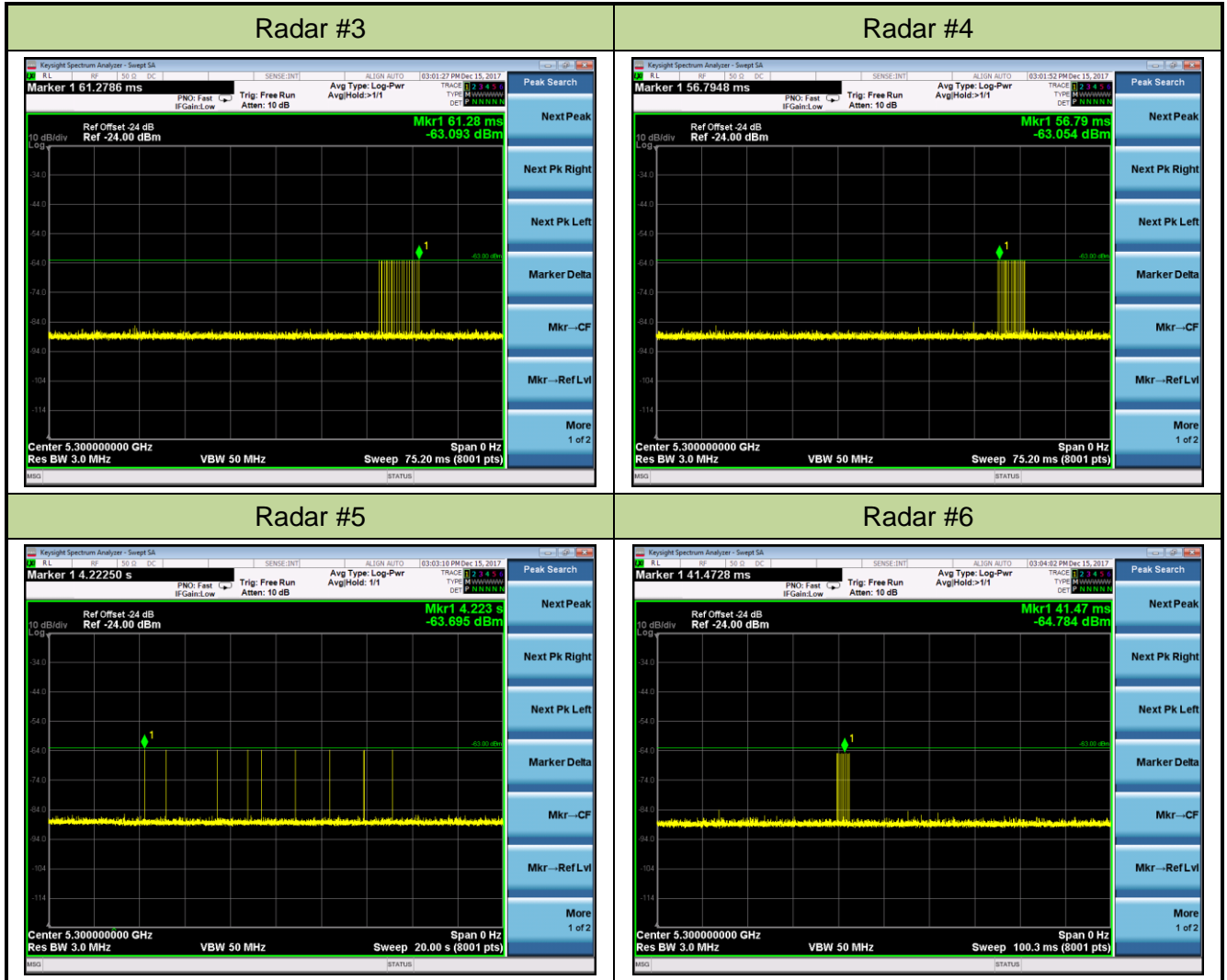

5.2.4. Channel Loading Test Result

Product	AC220m Wi-Fi module OD US	Temperature	27°C
Test Engineer	Paddy Chen	Relative Humidity	65%
Test Site	TR5	Test Date	2017/12/15
Test Item	Channel Loading		

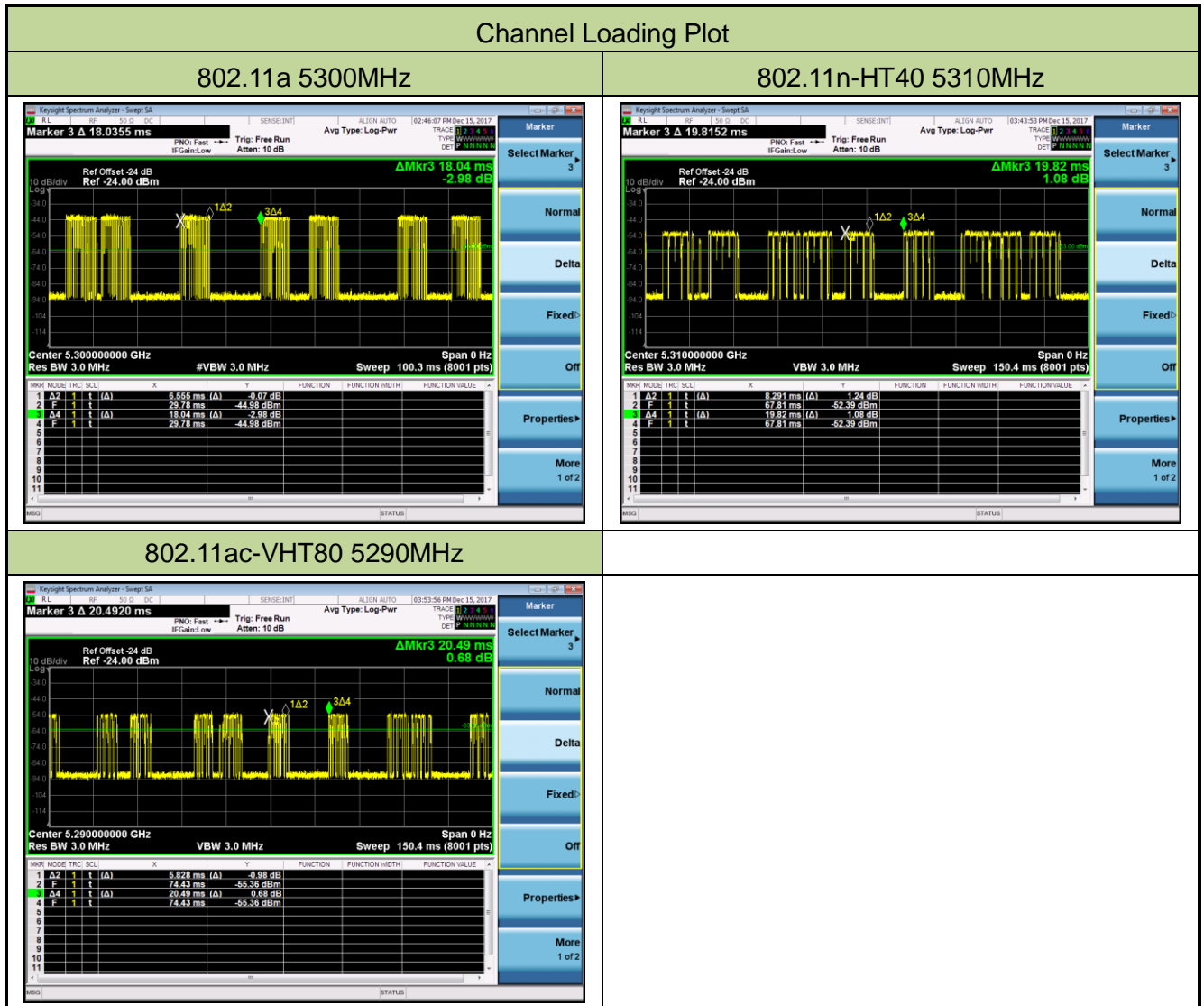

Test Mode	Test Frequency	Packet ratio	Requirement ratio	Test Result
802.11a	5300 MHz	36.34%	≥ 17%	Pass
802.11n-HT40	5310 MHz	41.83%	≥ 17%	Pass
802.11ac-VHT80	5290 MHz	28.44%	≥ 17%	Pass

Note: System testing was performed with the designated iperf test file. This file is used by IP and Frame based systems for loading the test channel during the In-service compliance testing of the U-NII device. Packet ratio = Time On / (Time On + Off Time).

5.3. NII Detection Bandwidth Measurement

5.3.1. Test Limit

Minimum 100% of the NII 99% transmission power bandwidth. During the U-NII Detection Bandwidth detection test, each frequency step the minimum percentage of detection is 90 percent.

Measurements are performed with no data traffic.

5.3.2. Test Procedure

1. Adjust the equipment to produce a single Burst of any one of the Short Pulse Radar Types 0-4 in Table 3-5 at the center frequency of the EUT Operating Channel at the specified DFS Detection Threshold level.
2. The generating equipment is configured as shown in the Conducted Test Setup above section 3.5.
3. The EUT is set up as a stand-alone device (no associated Client or Master, as appropriate) and no traffic. Frame based systems will be set to a talk/listen ratio reflecting the worst case (maximum) that is user configurable during this test.
4. Generate a single radar Burst, and note the response of the EUT. Repeat for a minimum of 10 trials. The EUT must detect the Radar Waveform using the specified U-NII Detection Bandwidth criterion shown in Table 3-5. In cases where the channel bandwidth may exceed past the DFS band edge on specific channels (i.e., 802.11ac or wideband frame based systems) select a channel that has the entire emission bandwidth within the DFS band. If this is not possible, test the detection BW to the DFS band edge.
5. Starting at the center frequency of the UUT operating Channel, increase the radar frequency in 5 MHz steps, repeating the above test sequence, until the detection rate falls below the U-NII Detection Bandwidth criterion specified in Table 3-3. Repeat this measurement in 1MHz steps at frequencies 5 MHz below where the detection rate begins to fall. Record the highest frequency (denote as FH) at which detection is greater than or equal to the U-NII Detection Bandwidth criterion. Recording the detection rate at frequencies above FH is not required to demonstrate compliance.
6. Starting at the center frequency of the EUT operating Channel, decrease the radar frequency in 1 MHz steps, repeating the above item 4 test sequence, until the detection rate falls below the U-NII Detection Bandwidth criterion. Record the lowest frequency (denote as FL) at which detection is greater than or equal to the U-NII Detection Bandwidth criterion. Recording the detection rate at frequencies below FL is not required to demonstrate compliance.
7. The U-NII Detection Bandwidth is calculated as follows: $U\text{-NII Detection Bandwidth} = FH - FL$
8. The U-NII Detection Bandwidth must be at least 100% of the EUT transmitter 99% power, otherwise, the EUT does not comply with DFS requirements.

5.3.3. Test Result

Product	AC220m Wi-Fi module OD US	Temperature	27°C
Test Engineer	Paddy Chen	Relative Humidity	65%
Test Site	TR5	Test Date	2017/12/15
Test Item	Detection Bandwidth (802.11a mode – 5300MHz)		

Radar Frequency (MHz)	DFS Detection Trials (1=Detection, 0= No Detection)										Detection Rate (%)
	1	2	3	4	5	6	7	8	9	10	
5290	0	0	0	0	0	0	0	0	0	0	0%
5291 FL	1	1	1	1	1	1	1	1	1	1	100%
5292	1	1	1	1	1	1	1	1	1	1	100%
5293	1	1	1	1	1	1	1	1	1	1	100%
5294	1	1	1	1	1	1	1	1	1	1	100%
5295	1	1	1	1	1	1	1	1	1	1	100%
5300	1	1	1	1	1	1	1	1	1	1	100%
5305	1	1	1	1	1	1	1	1	1	1	100%
5306	1	1	1	1	1	1	1	1	1	1	100%
5307	1	1	1	1	1	1	1	1	1	1	100%
5308	1	1	1	1	1	1	1	1	1	1	100%
5309 FH	1	1	1	1	1	1	1	1	1	1	100%
5310	0	0	0	0	0	0	0	0	0	0	0%

Note 1: All NII channels for this device have identical Channel bandwidths. Therefore, all DFS testing was done at 5300MHz. The 99% channel bandwidth is 16.74MHz. (See the 99% BW section of the RF report for further measurement details).

Note 2: Detection Bandwidth = FH - FL = 5309MHz - 5291MHz = 18MHz.

Note 3: NII Detection Bandwidth Min. Limit (MHz): 16.74MHz x 100% = 16.74MHz.

Product	AC220m Wi-Fi module OD US	Temperature	27°C
Test Engineer	Paddy Chen	Relative Humidity	65%
Test Site	TR5	Test Date	2017/12/15
Test Item	Detection Bandwidth (802.11n-HT40 mode – 5310MHz)		

Radar Frequency (MHz)	DFS Detection Trials (1=Detection, 0= No Detection)										Detection Rate (%)
	1	2	3	4	5	6	7	8	9	10	
5290	0	0	0	0	0	0	0	0	0	0	0%
5291	0	0	0	0	0	0	0	0	0	0	0%
5292 FL	1	1	1	1	1	1	1	1	1	1	100%
5293	1	1	1	1	1	1	1	1	1	1	100%
5294	1	1	1	1	1	1	1	1	1	1	100%
5295	1	1	1	1	1	1	1	1	1	1	100%
5300	1	1	1	1	1	1	1	1	1	1	100%
5305	1	1	1	1	1	1	1	1	1	1	100%
5310	1	1	1	1	1	1	1	1	1	1	100%
5315	1	1	1	1	1	1	1	1	1	1	100%
5320	1	1	1	1	1	1	1	1	1	1	100%
5325	1	1	1	1	1	1	1	1	1	1	100%
5326	1	1	1	1	1	1	1	1	1	1	100%
5327	1	1	1	1	1	1	1	1	1	1	100%
5328	1	1	1	1	1	1	1	1	1	1	100%
5329 FH	1	1	1	1	1	1	1	1	1	1	100%
5330	0	0	0	0	0	0	0	0	0	0	0%

Note 1: All NII channels for this device have identical Channel bandwidths. Therefore, all DFS testing was done at 5310MHz. The 99% channel bandwidth is 35.93MHz. (See the 99% BW section of the RF report for further measurement details).

Note 2: Detection Bandwidth = FH - FL = 5329MHz - 5292MHz = 37MHz.

Note 3: NII Detection Bandwidth Min. Limit (MHz): 35.93MHz x 100% = 35.93MHz.



Product	AC220m Wi-Fi module OD US	Temperature	27°C
Test Engineer	Paddy Chen	Relative Humidity	65%
Test Site	TR5	Test Date	2017/12/15
Test Item	Detection Bandwidth (802.11ac-VHT80 mode – 5290MHz)		

Radar Frequency (MHz)	DFS Detection Trials (1=Detection, 0= No Detection)										Detection Rate (%)
	1	2	3	4	5	6	7	8	9	10	
5250	0	0	0	0	0	0	0	0	0	0	0%
5251 FL	1	1	1	1	1	1	1	1	1	1	100%
5252	1	1	1	1	1	1	1	1	1	1	100%
5253	1	1	1	1	1	1	1	1	1	1	100%
5254	1	1	1	1	1	1	1	1	1	1	100%
5255	1	1	1	1	1	1	1	1	1	1	100%
5260	1	1	1	1	1	1	1	1	1	1	100%
5265	1	1	1	1	1	1	1	1	1	1	100%
5270	1	1	1	1	1	1	1	1	1	1	100%
5275	1	1	1	1	1	1	1	1	1	1	100%
5280	1	1	1	1	1	1	1	1	1	1	100%
5285	1	1	1	1	1	1	1	1	1	1	100%
5290	1	1	1	1	1	1	1	1	1	1	100%
5295	1	1	1	1	1	1	1	1	1	1	100%
5300	1	1	1	1	1	1	1	1	1	1	100%
5305	1	1	1	1	1	1	1	1	1	1	100%
5310	1	1	1	1	1	1	1	1	1	1	100%
5315	1	1	1	1	1	1	1	1	1	1	100%
5320	1	1	1	1	1	1	1	1	1	1	100%
5325	1	1	1	1	1	1	1	1	1	1	100%
5326	1	1	1	1	1	1	1	1	1	1	100%
5327	1	1	1	1	1	1	1	1	1	1	100%
5328	1	1	1	1	1	1	1	1	1	1	100%
5329 FH	1	1	1	1	1	1	1	1	1	1	100%
5330	0	0	0	0	0	0	0	0	0	0	0%

Note 1: All NII channels for this device have identical Channel bandwidths. Therefore, all DFS testing was done at 5290MHz. The 99% channel bandwidth is 75.75MHz. (See the 99% BW section of the RF report for further measurement details).

Note 2: Detection Bandwidth = FH - FL = 5329MHz - 5251MHz = 78MHz.

Note 3: NII Detection Bandwidth Min. Limit (MHz): 75.75MHz x 100% = 75.75MHz.

5.4. Initial Channel Availability Check Time Measurement

5.4.1. Test Limit

The EUT shall perform a Channel Availability Check to ensure that there is no radar operating on the channel. After power-up sequence, receive at least 1 minute on the intended operating frequency.

5.4.2. Test Procedure

1. The U-NII devices will be powered on and be instructed to operate on the appropriate U-NII Channel that must incorporate DFS functions. At the same time the EUT is powered on, the spectrum analyzer will be set to zero span mode with a 3 MHz RBW and 3 MHz VBW on the Channel occupied by the radar (Chr) with a 2.5 minute sweep time. The spectrum analyzer's sweep will be started at the same time power is applied to the U-NII device.
2. The EUT should not transmit any beacon or data transmissions until at least 1 minute after the completion of the power-on cycle.
3. Confirm that the EUT initiates transmission on the channel. Measurement system showing its nominal noise floor is marker1.

5.4.3. Test Result

Product	AC220m Wi-Fi module OD US	Temperature	27°C
Test Engineer	Paddy Chen	Relative Humidity	65%
Test Site	TR5	Test Date	2017/12/15
Test Item	Initial Channel Availability Check Time (802.11a mode – 5300MHz)		

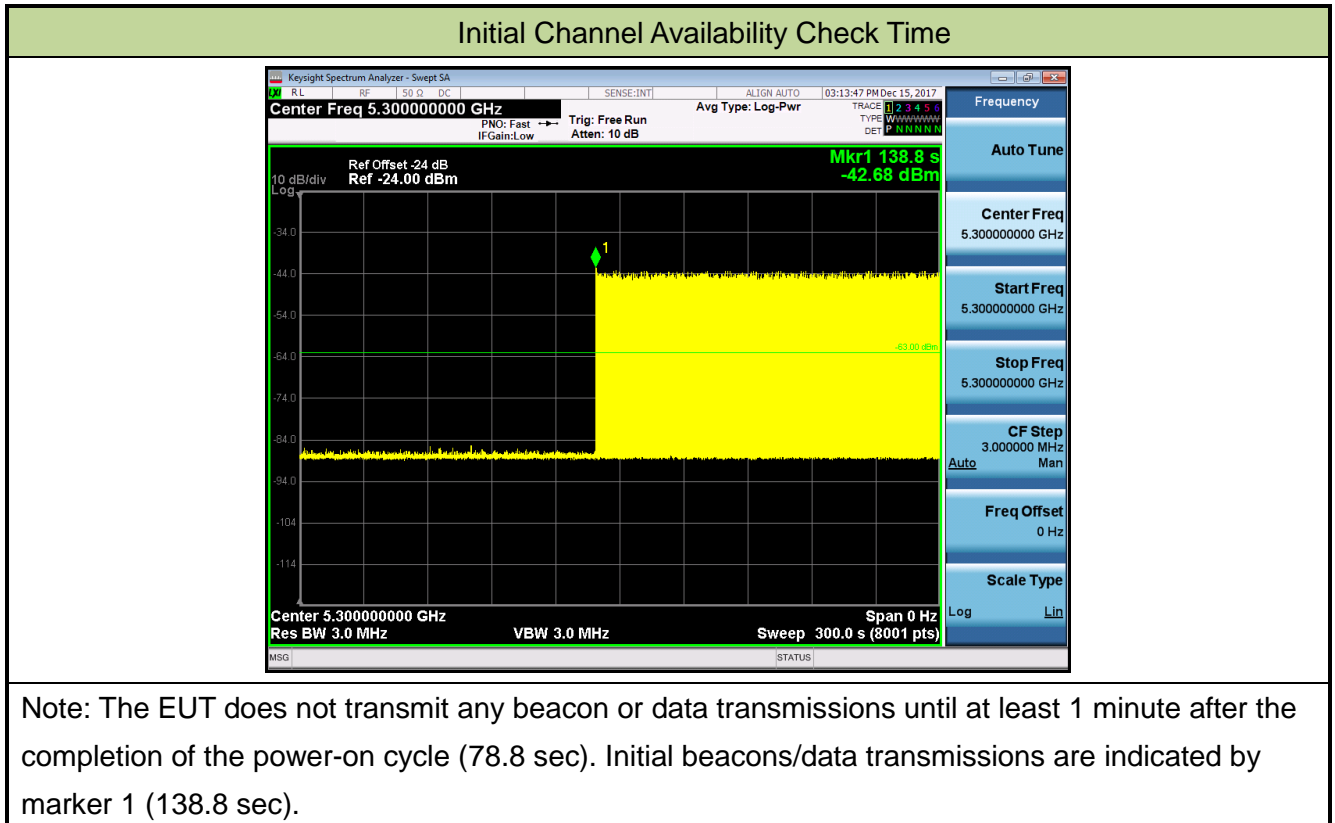

5.5. Radar Burst at the Beginning of the Channel Availability Check Time Measurement

5.5.1. Test Limit

In beginning of the Channel Availability Check (CAC) Time, radar is detected on this channel, select another intended channel and perform a CAC on that channel.

5.5.2. Test Procedure

1. The steps below define the procedure to verify successful radar detection on the selected Channel during a period equal to the Channel Availability Check Time and avoidance of operation on that Channel when a radar Burst with a level equal to the DFS Detection Threshold + 1 dB occurs at the beginning of the Channel Availability Check Time.
2. The EUT is in completion power-up cycle (from T0 to T1). T1 denotes the instant when the EUT has completed its power-up sequence. The Channel Availability Check Time commences at instant T1 and will end no sooner than T1 + 60 seconds. A single Burst of one of Short Pulse Radar Types 0-4 at DFS Detection Threshold + 1 dB will commence within a 6 second window starting at T1.
3. Visual indication on the EUT of successful detection of the radar Burst will be recorded and reported. Observation of emissions will continue for 2.5 minutes after the radar Burst has been generated. Verify that during the 2.5 minutes measurement window no EUT transmissions occurred.

5.5.3. Test Result

Product	AC220m Wi-Fi module OD US	Temperature	27°C
Test Engineer	Paddy Chen	Relative Humidity	65%
Test Site	TR5	Test Date	2017/12/15
Test Item	Beginning of the Channel Availability Check Time (802.11a mode – 5300MHz)		

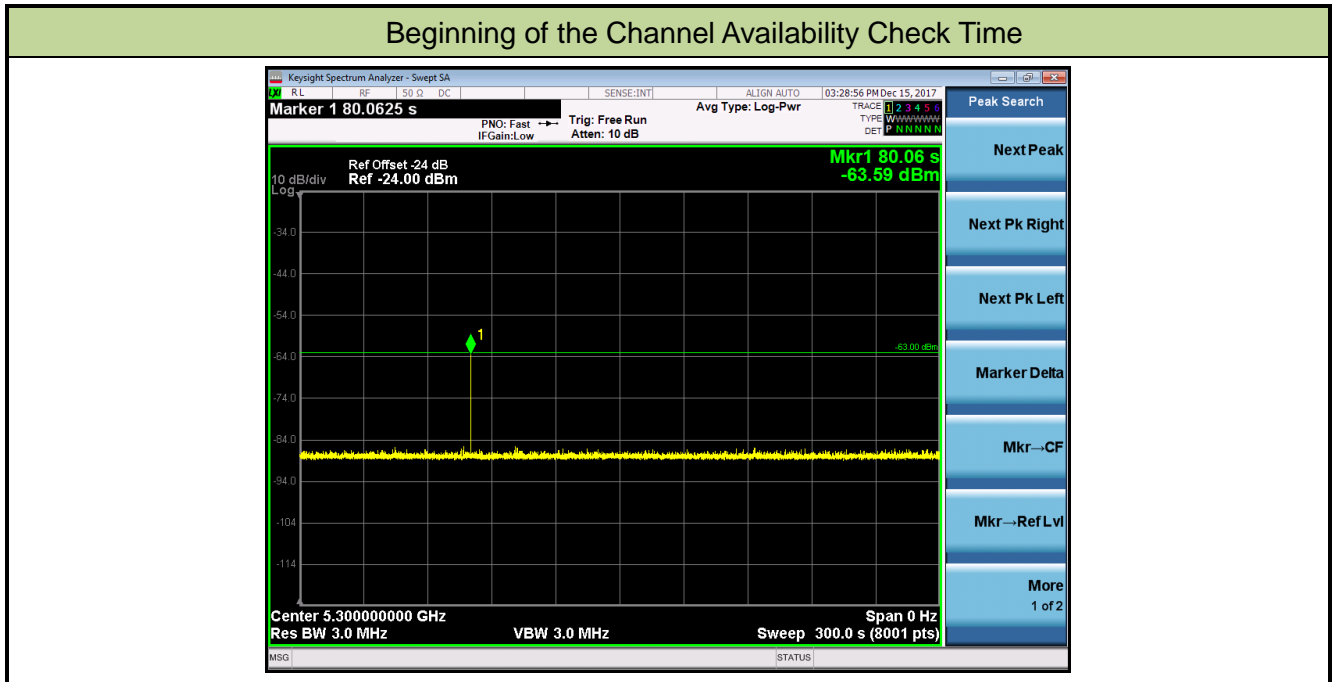

5.6. Radar Burst at the End of the Channel Availability Check Time Measurement

5.6.1. Test Limit

In the end of Channel Availability Check (CAC) Time, radar is detected on this channel, select another intended channel and perform a CAC on that channel.

5.6.2. Test Procedure

1. The steps below define the procedure to verify successful radar detection on the selected Channel during a period equal to the Channel Availability Check Time and avoidance of operation on that Channel when a radar Burst with a level equal to the DFS Detection Threshold + 1 dB occurs at the beginning of the Channel Availability Check Time.
2. The EUT is powered on at T0. T1 denotes the instant when the EUT has completed its power-up sequence. The Channel Availability Check Time commences at instant T1 and will end no sooner than T1 + 60 seconds. A single Burst of one of Short Pulse Radar Types 0-4 at DFS Detection Threshold + 1 dB will commence within a 6 second window starting at T1+ 54 seconds.
3. Visual indication on the EUT of successful detection of the radar Burst will be recorded and reported. Observation of emissions will continue for 2.5 minutes after the radar Burst has been generated. Verify that during the 2.5 minutes measurement window no EUT transmissions occurred.

5.6.3. Test Result

Product	AC220m Wi-Fi module OD US	Temperature	27°C
Test Engineer	Paddy Chen	Relative Humidity	65%
Test Site	TR5	Test Date	2017/12/15
Test Item	End of the Channel Availability Check Time (802.11a mode – 5300MHz)		

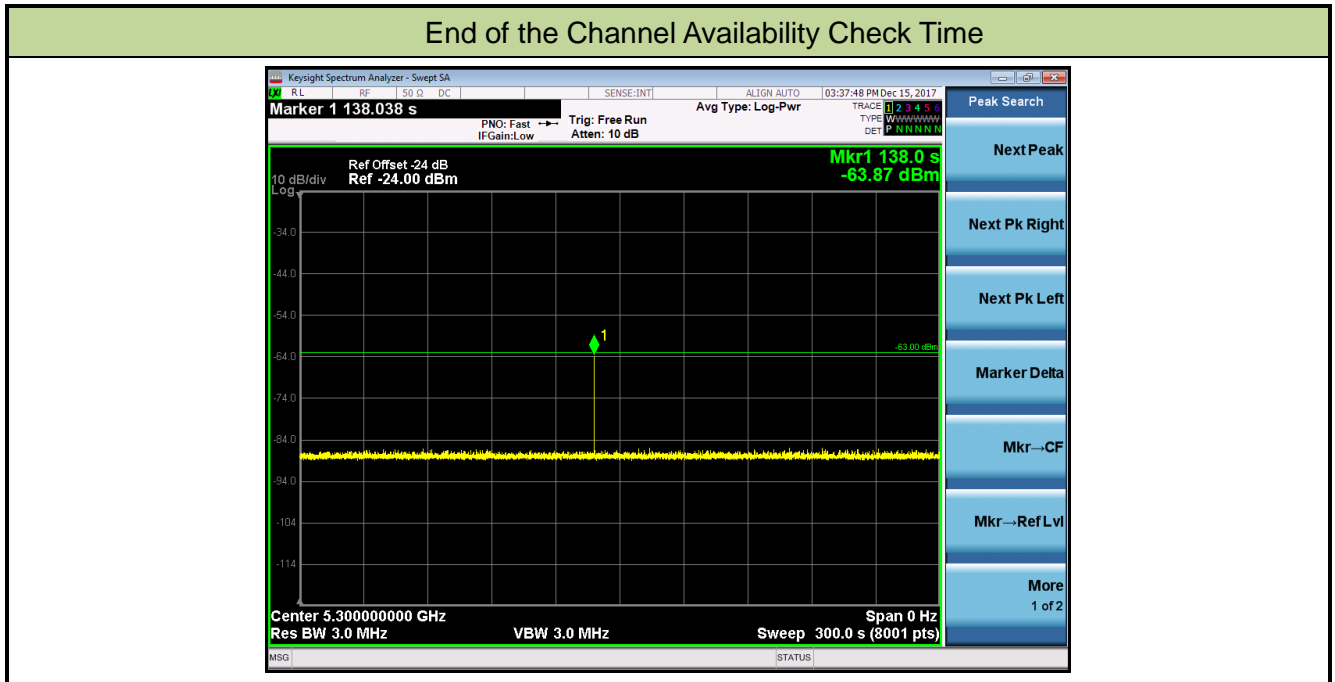

5.7. In-Service Monitoring for Channel Move Time, Channel Closing Transmission Time and Non-Occupancy Period Measurement

5.7.1. Test Limit

The EUT has In-Service Monitoring function to continuously monitor the radar signals. If the radar is detected, must leave the channel (Shutdown). The Channel Move Time to cease all transmissions on the current channel upon detection of a Radar Waveform above the DFS Detection Threshold within 10 sec. The total duration of Channel Closing Transmission Time is 260ms, consisting of data signals and the aggregate of control signals, by a U-NII device during the Channel Move Time. The Non-Occupancy Period time is 30 minute during which a Channel will not be utilized after a Radar Waveform is detected on that Channel.

5.7.2. Test Procedure Used

1. The test should be performed with Radar Type 0. The measurement timing begins at the end of the Radar Type 0.
2. When the radar burst with a level equal to the DFS Detection Threshold + 1dB is generated on the Operating Channel of the U-NII device. A U-NII device operating as a Master Device will associate with the Client Device at Channel. Stream the MPEG test file from the Master Device to the Client Device on the selected Channel for the entire period of the test. At time T0 the Radar Waveform generator sends a Burst of pulses for each of the radar types at Detection Threshold + 1dB.
3. Observe the transmissions of the EUT at the end of the radar Burst on the Operating Channel. Measure and record the transmissions from the EUT during the observation time (Channel Move Time).
4. Measurement of the aggregate duration of the Channel Closing Transmission Time method. With the spectrum analyzer set to zero span tuned to the center frequency of the EUT operating channel at the radar simulated frequency, peak detection, and max hold, the dwell time per bin is given by: $Dwell (1.5ms) = S (12 \text{ sec}) / B (8000)$; where Dwell is the dwell time per spectrum analyzer sampling bin, S is the sweep time and B is the number of spectrum analyzer sampling bins. An upper bound of the aggregate duration of the intermittent control signals of Channel Closing Transmission Time is calculated by: $C = N \times Dwell$; where C is the Closing Time, N is the number of spectrum analyzer sampling bins showing a U-NII transmission and Dwell is the dwell time per bin.
5. Measure the EUT for more than 30 minutes following the channel close/move time to verify that the EUT does not resume any transmissions on this Channel.

5.7.3. Test Result

Product	AC220m Wi-Fi module OD US	Temperature	27°C
Test Engineer	Paddy Chen	Relative Humidity	65%
Test Site	TR5	Test Date	2017/12/15
Test Item	Channel Move Time and Channel Closing Transmission Time (802.11ac-VHT80 mode – 5290MHz)		

Channel Move Time and Channel Closing Transmission Time

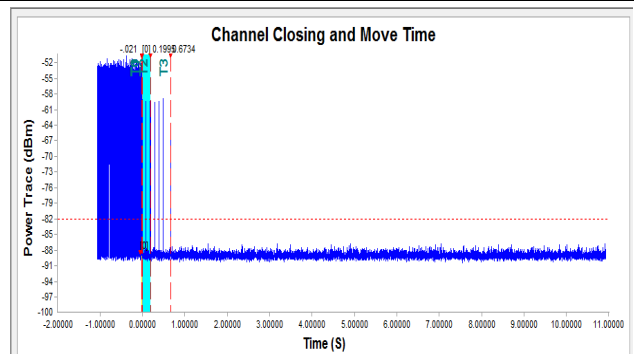
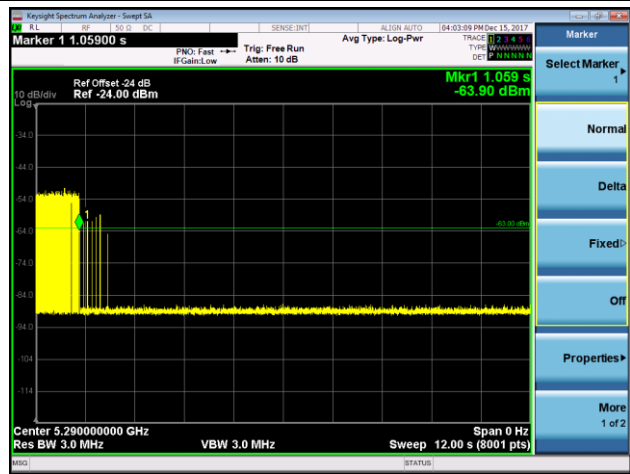

Time Index Info:

T0 : -0.0210 S	Time Per Bin: 1.4998125 ms	Channel Move Time: 0.6734158 S
T1 : 0.0000 S	T2-T3 Bins Over Threshold:	Channel Close Time: 0.0089989 S
T2 : 0.1995 S	= 6 Bins	
T3 : 0.6734 S		

Non-Occupancy Period

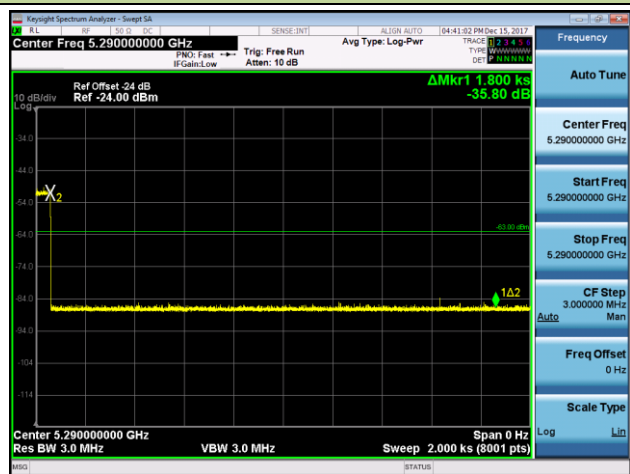

Frequency

Auto Tune
Center Freq 5.290000000 GHz
Start Freq 5.290000000 GHz
Stop Freq 5.290000000 GHz
CF Step 3.000000 MHz Auto Man
Freq Offset 0 Hz
Scale Type Log Lin

Parameter	Test Result	Limit
	Type 0	
Channel Move Time (s)	0.673s	<10s
Channel Closing Transmission Time (ms) (Note)	9.0ms	< 60ms
Non-Occupancy Period (min)	≥ 30min	≥ 30 min
<p>Note: The Channel Closing Transmission Time is comprised of 200 milliseconds starting at the beginning of the Channel Move Time plus any additional intermittent control signals required to facilitate a Channel move (an aggregate of 60 milliseconds) during the remainder of the 10 seconds period. The aggregate duration of control signals will not count quiet periods in between transmissions.</p>		

5.8. Statistical Performance Check Measurement

5.8.1. Test Limit

The minimum percentage of successful detection requirements found in below table when a radar burst with a level equal to the DFS Detection Threshold + 1dB is generated on the Operating Channel of the U-NII device (In- Service Monitoring).

Radar Type	Minimum Number of Trails	Detection Probability
0	30	Pd > 60%
1	30(15 of test A and 15 of test B)	Pd > 60%
2	30	Pd > 60%
3	30	Pd > 60%
4	30	Pd > 60%
Aggregate (Radar Types 1-4)	120	Pd > 80%
5	30	Pd > 80%
6	30	Pd > 70%

Note: The percentage of successful detection is calculated by:
 $(\text{Total Waveform Detections} / \text{Total Waveform Trails}) * 100 = \text{Probability of Detection Radar}$
 Waveform In addition an aggregate minimum percentage of successful detection across all Short Pulse Radar Types 1-4 is required and is calculated as follows: $(Pd1 + Pd2 + Pd3 + Pd4) / 4$.

5.8.2. Test Procedure

1. Stream the MPEG test file from the Master Device to the Client Device on the test Channel for the entire period of the test.
2. At time T0 the Radar Waveform generator sends the individual waveform for each of the Radar Types 1-6, at levels equal to the DFS Detection Threshold + 1dB, on the Operating Channel.
3. Observe the transmissions of the EUT at the end of the Burst on the Operating Channel for duration greater than 10 seconds for Short Pulse Radar Types 0 to ensure detection occurs.
4. Observe the transmissions of the EUT at the end of the Burst on the Operating Channel for duration greater than 22 seconds for Long Pulse Radar Type 5 to ensure detection occurs.
5. The device can utilize a test mode to demonstrate when detection occurs to prevent the need to reset the device between trial runs.
6. The Minimum number of trails, minimum percentage of successful detection and the average minimum percentage of successful detection are found in below table.

5.8.3. Test Result

Product	AC220m Wi-Fi module OD US	Temperature	27°C
Test Engineer	Paddy Chen	Relative Humidity	65%
Test Site	TR5	Test Date	2017/12/16
Test Item	Radar Statistical Performance Check (802.11a mode – 5300MHz)		

Radar Type 1 - Radar Statistical Performance

Trail #	Test Freq. (MHz)	Pulse Width (us)	PRI (us)	Pulses / Burst	1=Detection 0=No Detection
1	5292	1	3066	18	1
2	5292	1	638	83	1
3	5293	1	558	95	1
4	5293	1	698	76	1
5	5294	1	538	99	1
6	5294	1	678	78	1
7	5295	1	818	65	1
8	5295	1	918	58	1
9	5296	1	878	61	1
10	5296	1	858	62	1
11	5297	1	898	59	1
12	5297	1	798	67	1
13	5298	1	778	68	1
14	5299	1	658	81	1
15	5300	1	838	63	1
16	5301	1	1139	47	1
17	5302	1	2496	22	1
18	5302	1	2950	18	1
19	5303	1	2402	22	1
20	5303	1	2773	20	1
21	5304	1	2191	25	1
22	5304	1	520	102	1
23	5305	1	1483	36	1
24	5305	1	825	64	1
25	5306	1	665	80	1
26	5306	1	1889	28	1



Trail #	Test Freq. (MHz)	Pulse Width (us)	PRI (us)	Pulses / Burst	1=Detection 0=No Detection
27	5307	1	2779	19	1
28	5307	1	1244	43	1
29	5308	1	1426	38	1
30	5308	1	2490	22	1
Detection Percentage (%)					100%



Radar Type 2 - Radar Statistical Performance

Trail #	Test Freq. (MHz)	Pulse Width (us)	PRI (us)	Pulses / Burst	1=Detection 0=No Detection
1	5292	3.6	164	29	1
2	5292	3.6	169	27	1
3	5293	4.1	212	28	1
4	5293	4.9	217	24	1
5	5294	4.1	151	27	1
6	5294	1.7	212	25	1
7	5295	2.7	172	26	1
8	5295	3.5	224	26	1
9	5296	1.3	159	29	1
10	5296	1.6	190	29	1
11	5297	2.1	191	24	1
12	5297	4.8	167	26	1
13	5298	1.9	186	25	1
14	5299	3.3	213	24	1
15	5300	2.7	160	28	1
16	5301	4.9	220	29	1
17	5302	3.2	186	25	1
18	5302	3.9	227	23	1
19	5303	3.6	212	25	1
20	5303	1.8	201	29	1
21	5304	4.7	189	26	1
22	5304	3.1	190	24	1
23	5305	4.6	174	28	1
24	5305	1.5	197	27	1
25	5306	1.7	221	27	1
26	5306	1.3	201	24	1
27	5307	5.0	155	29	1
28	5307	1.1	228	29	1
29	5308	3.9	229	29	1
30	5308	3.7	225	28	1
Detection Percentage (%)					100%



Radar Type 3 - Radar Statistical Performance

Trail #	Test Freq. (MHz)	Pulse Width (us)	PRI (us)	Pulses / Burst	1=Detection 0=No Detection
1	5292	8.3	492	16	1
2	5292	8.3	379	18	1
3	5293	8.3	493	18	1
4	5293	10.0	497	17	1
5	5294	9.6	256	17	1
6	5294	8.3	287	17	1
7	5295	9.8	494	17	1
8	5295	6.9	488	16	1
9	5296	6.5	253	16	1
10	5296	6.1	477	18	1
11	5297	7.2	326	16	1
12	5297	6.6	259	17	1
13	5298	7.5	471	17	1
14	5299	8.9	465	17	1
15	5300	7.3	447	18	1
16	5301	8.8	399	16	1
17	5302	9.8	464	17	1
18	5302	9.3	288	18	1
19	5303	7.0	296	18	1
20	5303	9.3	298	16	1
21	5304	6.0	317	18	1
22	5304	9.2	377	17	1
23	5305	7.9	305	16	1
24	5305	6.2	434	17	1
25	5306	8.8	451	17	1
26	5306	7.4	326	17	1
27	5307	6.3	493	16	1
28	5307	7.3	377	16	1
29	5308	7.3	410	16	1
30	5308	7.4	379	18	1
Detection Percentage (%)					100%



Radar Type 4 - Radar Statistical Performance

Trail #	Test Freq. (MHz)	Pulse Width (us)	PRI (us)	Pulses / Burst	1=Detection 0=No Detection
1	5292	15.2	356	15	1
2	5292	15.2	318	13	1
3	5293	12.1	354	13	1
4	5293	14.9	336	16	1
5	5294	12.8	351	12	1
6	5294	19.8	436	14	1
7	5295	18.4	330	13	1
8	5295	12.0	359	12	1
9	5296	13.6	256	12	1
10	5296	19.9	370	16	1
11	5297	15.2	401	14	1
12	5297	13.5	278	13	1
13	5298	13.3	374	14	1
14	5299	14.9	426	12	1
15	5300	16.3	461	16	1
16	5301	13.3	422	15	1
17	5302	13.5	307	14	1
18	5302	13.9	424	12	1
19	5303	11.5	382	12	1
20	5303	14.7	253	12	1
21	5304	19.5	357	13	1
22	5304	18.4	427	13	1
23	5305	16.8	496	16	1
24	5305	13.7	495	12	1
25	5306	20.0	264	15	1
26	5306	19.3	341	12	1
27	5307	14.6	314	13	1
28	5307	19.6	497	16	1
29	5308	14.4	293	13	1
30	5308	15.9	269	16	1
Detection Percentage (%)					100%
Note: In addition an average minimum percentage of successful detection across all four Short pulse radar test waveforms is as follows: $\frac{P_d1+P_d2+P_d3+P_d4}{4} = (100\%+100\%+100\%+100\%)/4 = 100\% (>80\%)$					



Radar Type 5 - Radar Statistical Performance

Trail #	Test Freq. (MHz)	1=Detection 0=No Detection	Trail #	Test Freq. (MHz)	1=Detection 0=No Detection
1	5299.2	1	16	5300.0	1
2	5297.6	1	17	5300.0	1
3	5296.0	1	18	5300.0	1
4	5296.8	1	19	5300.0	1
5	5295.6	1	20	5300.0	1
6	5294.4	1	21	5303.2	1
7	5298.8	1	22	5304.4	1
8	5294.0	1	23	5306.0	1
9	5295.2	1	24	5304.0	1
10	5299.6	1	25	5302.4	1
11	5300.0	1	26	5305.6	1
12	5300.0	1	27	5304.8	1
13	5300.0	1	28	5300.4	1
14	5300.0	1	29	5300.8	1
15	5300.0	1	30	5301.2	1
Detection Percentage (%)					100%

Type 5 Radar Waveform_1										
Num of Bursts = 12										
Burst Interval (us)= 1000000										
Burst #	Off Time (us)	# Pulses	Chirp (MHz)	PW (us)	Pulse 1 Pri (us)	Pulse 2 Pri (us)	Pulse 3 Pri (us)	Start Loc (us)	Start Burst Interval (us)	End Burst Interval (us)
1	60952	1	18	75	1460	0	0	60952	0	999999
2	1221461	3	18	100	1208	1222	1672	1283873	1000000	1999999
3	944542	1	18	75	1409	0	0	2232517	2000000	2999999
4	869383	1	18	55	1190	0	0	3103309	3000000	3999999
5	1013926	1	18	50	1381	0	0	4118425	4000000	4999999
6	1524282	1	18	55	1678	0	0	5644088	5000000	5999999
7	531145	1	18	90	1291	0	0	6176911	6000000	6999999
8	1375040	3	18	60	1683	1246	1257	7553242	7000000	7999999
9	824581	2	18	55	1548	1646	0	8382009	8000000	8999999
10	623524	1	18	80	1243	0	0	9008727	9000000	9999999
11	1954225	3	18	100	1607	1863	1369	10964195	10000000	10999999
12	210365	3	18	50	1000	1874	1578	11179399	11000000	11999999
Total number of pulses in waveform = 21										



Type 5 Radar Waveform_2

Num of Bursts = 14
Burst Interval (us)= 857143

Burst #	Off Time (us)	# Pulses	Chirp (MHz)	PW (us)	Pulse 1 Pri (us)	Pulse 2 Pri (us)	Pulse 3 Pri (us)	Start Loc (us)	Start Burst Interval (us)	End Burst Interval (us)
1	546281	2	14	75	1467	1276	0	546281	0	857142
2	546379	1	14	50	1229	0	0	1095403	857143	1714285
3	867324	1	14	55	1736	0	0	1963956	1714286	2571428
4	1334350	1	14	90	1864	0	0	3300042	2571429	3428571
5	817547	2	14	95	1729	1721	0	4119453	3428572	4285714
6	668719	2	14	70	1321	1347	0	4791622	4285715	5142857
7	590876	2	14	95	1119	1848	0	5385166	5142858	6000000
8	1337864	1	14	85	1973	0	0	6725997	6000001	6857143
9	424029	2	14	70	1736	1549	0	7151999	6857144	7714286
10	978190	1	14	55	1109	0	0	8133474	7714287	8571429
11	831567	3	14	100	1179	1841	1663	8966150	8571430	9428572
12	633819	1	14	50	1725	0	0	9604652	9428573	10285715
13	969862	2	14	75	1491	1551	0	10576239	10285716	11142858
14	641434	3	14	75	1309	1330	1178	11220715	11142859	12000001

Total number of pulses in waveform = 24

Type 5 Radar Waveform_3

Num of Bursts = 10
Burst Interval (us)= 1200000

Burst #	Off Time (us)	# Pulses	Chirp (MHz)	PW (us)	Pulse 1 Pri (us)	Pulse 2 Pri (us)	Pulse 3 Pri (us)	Start Loc (us)	Start Burst Interval (us)	End Burst Interval (us)
1	737252	2	10	95	1049	1189	0	737252	0	1199999
2	1257996	3	10	75	1445	1862	1889	1997486	1200000	2399999
3	1388532	3	10	85	1102	1833	1206	3391214	2400000	3599999
4	1252372	2	10	65	1816	1371	0	4647727	3600000	4799999
5	703449	1	10	90	1796	0	0	5354363	4800000	5999999
6	1297866	2	10	60	1024	1749	0	6654025	6000000	7199999
7	1389923	1	10	95	1840	0	0	8046721	7200000	8399999
8	1312070	3	10	100	1647	1770	1879	9360631	8400000	9599999
9	919523	1	10	90	1552	0	0	10285450	9600000	10799999
10	882765	3	10	100	1787	1684	1882	11169767	10800000	11999999

Total number of pulses in waveform = 21

Type 5 Radar Waveform_4

Num of Bursts = 19
Burst Interval (us)= 631579

Burst #	Off Time (us)	# Pulses	Chirp (MHz)	PW (us)	Pulse 1 Pri (us)	Pulse 2 Pri (us)	Pulse 3 Pri (us)	Start Loc (us)	Start Burst Interval (us)	End Burst Interval (us)
1	138778	3	12	100	1853	1606	1263	138778	0	631578
2	699530	2	12	90	1031	1502	0	843030	631579	1263157
3	478808	2	12	85	1983	1344	0	1324371	1263158	1894736
4	944956	1	12	50	1697	0	0	2272654	1894737	2526315
5	252228	2	12	85	1033	1460	0	2526579	2526316	3157894
6	983969	2	12	60	1721	1648	0	3513041	3157895	3789473
7	814509	3	12	95	1797	1120	1927	4330919	3789474	4421052
8	564903	3	12	90	1053	1327	1434	4900666	4421053	5052631
9	221179	2	12	80	1267	1612	0	5125659	5052632	5684210
10	816846	1	12	85	1008	0	0	5946384	5684211	6315789
11	913482	2	12	60	1628	1415	0	6859874	6315790	6947368
12	616236	1	12	100	1277	0	0	7479153	6947369	7578947
13	573200	3	12	70	1396	1408	1054	8053630	7578948	8210526
14	648113	2	12	95	1134	1366	0	8705601	8210527	8842105
15	537100	2	12	75	1454	1463	0	9245191	8842106	9473684
16	412614	2	12	80	1993	1775	0	9660722	9473685	10105263
17	733591	2	12	100	1274	1054	0	10398081	10105264	10736842
18	573588	3	12	65	1127	1711	1215	10973997	10736843	11368421
19	470736	2	12	50	1177	1370	0	11448786	11368422	12000000

Total number of pulses in waveform = 40



Type 5 Radar Waveform_5

Num of Bursts = 18
Burst Interval (us)= 666667

Burst #	Off Time (us)	# Pulses	Chirp (MHz)	PW (us)	Pulse 1 Pri (us)	Pulse 2 Pri (us)	Pulse 3 Pri (us)	Start Loc (us)	Start Burst Interval (us)	End Burst Interval (us)
1	35363	2	9	75	1017	1538	0	35363	0	666666
2	1268513	2	9	95	1418	1432	0	1306431	666667	1333333
3	656710	1	9	70	1413	0	0	1965991	1333334	2000000
4	651047	3	9	85	1716	1259	1634	2618451	2000001	2666667
5	363942	2	9	60	1481	1022	0	2987002	2666668	3333334
6	773949	1	9	95	1044	0	0	3763454	3333335	4000001
7	699392	2	9	90	1583	1301	0	4463890	4000002	4666668
8	772934	3	9	55	1658	1911	1751	5239708	4666669	5333335
9	149629	1	9	50	1232	0	0	5394657	5333336	6000002
10	654365	3	9	90	1001	1887	1543	6050254	6000003	6666669
11	630253	2	9	70	1459	1839	0	6684938	6666670	7333336
12	1286123	3	9	55	1573	1915	1425	7974359	7333337	8000003
13	428275	1	9	90	1708	0	0	8407547	8000004	8666670
14	451202	1	9	60	1054	0	0	8860457	8666671	9333337
15	779064	2	9	90	1461	1691	0	9640575	9333338	10000004
16	453722	3	9	100	1725	1082	1113	10097449	10000005	10666671
17	651386	2	9	90	1610	1971	0	10752755	10666672	11333338
18	958144	1	9	80	1487	0	0	11714480	11333339	12000005

Total number of pulses in waveform = 35

Type 5 Radar Waveform_6

Num of Bursts = 12
Burst Interval (us)= 1000000

Burst #	Off Time (us)	# Pulses	Chirp (MHz)	PW (us)	Pulse 1 Pri (us)	Pulse 2 Pri (us)	Pulse 3 Pri (us)	Start Loc (us)	Start Burst Interval (us)	End Burst Interval (us)
1	473926	3	6	70	1616	1044	1073	473926	0	999999
2	576053	2	6	65	1998	1360	0	1053712	1000000	1999999
3	1502599	3	6	70	1766	1291	1429	2559669	2000000	2999999
4	1241315	2	6	90	1638	1930	0	3805470	3000000	3999999
5	748304	2	6	95	1655	1508	0	4557342	4000000	4999999
6	1110380	2	6	65	1063	1272	0	5670885	5000000	5999999
7	359468	3	6	80	1580	1409	1579	6032688	6000000	6999999
8	1941390	3	6	80	1725	1167	1545	7978646	7000000	7999999
9	189197	3	6	60	1420	1063	1971	8172280	8000000	8999999
10	1069438	2	6	85	1358	1495	0	9246172	9000000	9999999
11	902226	3	6	70	1985	1070	1036	10151251	10000000	10999999
12	892105	3	6	95	1822	1190	1843	11047447	11000000	11999999

Total number of pulses in waveform = 31

Type 5 Radar Waveform_7

Num of Bursts = 16
Burst Interval (us)= 750000

Burst #	Off Time (us)	# Pulses	Chirp (MHz)	PW (us)	Pulse 1 Pri (us)	Pulse 2 Pri (us)	Pulse 3 Pri (us)	Start Loc (us)	Start Burst Interval (us)	End Burst Interval (us)
1	361406	1	17	60	1088	0	0	512918	0	749999
2	812918	2	17	90	1904	1263	0	875412	750000	1499999
3	840676	3	17	65	1271	1665	1819	1719255	1500000	2249999
4	954339	1	17	55	1250	0	0	2678349	2250000	2999999
5	1023003	2	17	65	1081	1054	0	3702602	3000000	3749999
6	411642	3	17	70	1359	1019	1024	4116379	3750000	4499999
7	920455	2	17	80	1341	1983	0	5040236	4500000	5249999
8	881909	3	17	100	1554	1263	1996	5925469	5250000	5999999
9	287938	3	17	95	1235	1603	1891	6218220	6000000	6749999
10	705028	3	17	50	1615	1057	1063	6927977	6750000	7499999
11	689265	2	17	95	1758	1253	0	7620977	7500000	8249999
12	1043667	1	17	55	1687	0	0	8667555	8250000	8999999
13	829817	2	17	85	1060	1559	0	9499059	9000000	9749999
14	749424	1	17	60	1593	0	0	10251102	9750000	10499999
15	282641	1	17	100	1713	0	0	10535336	10500000	11249999
16	942001	1	17	75	1520	0	0	11479050	11250000	11999999

Total number of pulses in waveform = 31



Type 5 Radar Waveform_8

Num of Bursts = 14
Burst Interval (us)= 857143

Burst #	Off Time (us)	# Pulses	Chirp (MHz)	PW (us)	Pulse 1 Pri (us)	Pulse 2 Pri (us)	Pulse 3 Pri (us)	Start Loc (us)	Start Burst Interval (us)	End Burst Interval (us)
1	733935	2	5	70	1746	1135	0	733935	0	857142
2	400136	2	5	95	1454	1224	0	1136952	857143	1714285
3	884728	3	5	100	1352	1243	1503	2024358	1714286	2571428
4	914595	2	5	80	1440	1508	0	2943051	2571429	3428571
5	656579	2	5	50	1633	1069	0	3602578	3428572	4285714
6	1479759	1	5	90	1570	0	0	5085039	4285715	5142857
7	857748	2	5	60	1805	1408	0	5944357	5142858	6000000
8	74322	3	5	75	1563	1768	1334	6021892	6000001	6857143
9	1279994	3	5	70	1096	1211	1679	7306551	6857144	7714286
10	715909	1	5	65	1115	0	0	8026446	7714287	8571429
11	1375945	2	5	80	1827	1192	0	9403506	8571430	9428572
12	421545	3	5	55	1809	1474	1315	9828070	9428573	10285715
13	1086846	2	5	90	1124	1857	0	10919516	10285716	11142858
14	1030632	3	5	100	1760	1274	1901	11953129	11142859	12000001

Total number of pulses in waveform = 31

Type 5 Radar Waveform_9

Num of Bursts = 12
Burst Interval (us)= 1000000

Burst #	Off Time (us)	# Pulses	Chirp (MHz)	PW (us)	Pulse 1 Pri (us)	Pulse 2 Pri (us)	Pulse 3 Pri (us)	Start Loc (us)	Start Burst Interval (us)	End Burst Interval (us)
1	607525	2	8	100	1730	1117	0	607525	0	999999
2	1024571	2	8	55	1285	1675	0	1634943	1000000	1999999
3	873477	1	8	100	1092	0	0	2511380	2000000	2999999
4	835124	3	8	85	1806	1842	1013	3347596	3000000	3999999
5	1557887	3	8	65	1940	1987	1004	4910144	4000000	4999999
6	186616	3	8	90	1382	1583	1756	5101691	5000000	5999999
7	1004519	3	8	90	1469	1930	1452	6110931	6000000	6999999
8	1319531	2	8	50	1692	1068	0	7435313	7000000	7999999
9	1256036	2	8	70	1209	1061	0	8694109	8000000	8999999
10	879796	2	8	70	1958	1938	0	9576175	9000000	9999999
11	750067	2	8	65	1124	1874	0	10330138	10000000	10999999
12	935076	1	8	100	1263	0	0	11268212	11000000	11999999

Total number of pulses in waveform = 26

Type 5 Radar Waveform_10

Num of Bursts = 19
Burst Interval (us)= 631579

Burst #	Off Time (us)	# Pulses	Chirp (MHz)	PW (us)	Pulse 1 Pri (us)	Pulse 2 Pri (us)	Pulse 3 Pri (us)	Start Loc (us)	Start Burst Interval (us)	End Burst Interval (us)
1	23805	2	19	95	1656	1563	0	23805	0	631578
2	1145189	3	19	85	1342	1969	1301	1172213	631579	1263157
3	312396	3	19	60	1025	1771	1900	1489221	1263158	1894736
4	536827	2	19	65	1773	1400	0	2030744	1894737	2526315
5	774140	2	19	75	1767	1349	0	2808057	2526316	3157894
6	681274	3	19	60	1413	1449	1905	3492447	3157895	3789473
7	385715	2	19	90	1006	1195	0	3882929	3789474	4421052
8	1054021	1	19	95	1715	0	0	4939151	4421053	5052631
9	610189	2	19	80	1157	1955	0	5551035	5052632	5684210
10	395250	3	19	85	1335	1434	1196	5949397	5684211	6315789
11	646608	1	19	100	1270	0	0	6599970	6315790	6947368
12	535908	3	19	75	1578	1861	1201	7137148	6947369	7578947
13	454269	2	19	55	1130	1072	0	7596057	7578948	8210526
14	1091174	1	19	75	2000	0	0	8689433	8210527	8842105
15	260331	2	19	80	1330	1174	0	8951764	8842106	9473684
16	1074597	3	19	80	1770	1591	1592	10028865	9473685	10105263
17	109677	1	19	60	1115	0	0	10143495	10105264	10736842
18	836614	3	19	90	1694	1344	1502	10981224	10736843	11368421
19	429725	2	19	55	1595	1242	0	11415489	11368422	12000000

Total number of pulses in waveform = 41



Type 5 Radar Waveform_11

Num of Bursts = 17
Burst Interval (us) = 705882

Burst #	Off Time (us)	# Pulses	Chirp (MHz)	PW (us)	Pulse 1 Pri (us)	Pulse 2 Pri (us)	Pulse 3 Pri (us)	Start Loc (us)	Start Burst Interval (us)	End Burst Interval (us)
1	270868	1	17	90	1805	0	0	270868	0	705881
2	919001	3	17	55	1547	1115	1264	1191674	705882	1411763
3	631743	2	17	85	1545	1449	0	1827343	1411764	2117645
4	507446	3	17	95	1377	1392	1318	2337783	2117646	2823527
5	670167	3	17	75	1563	1113	1380	3012037	2823528	3529409
6	760874	1	17	90	1144	0	0	3776967	3529410	4235291
7	1057702	1	17	55	1409	0	0	4835813	4235292	4941173
8	213872	1	17	75	1939	0	0	5051094	4941174	5647055
9	985420	1	17	55	1010	0	0	6038453	5647056	6352937
10	450955	1	17	55	1530	0	0	6490418	6352938	7058819
11	1130138	3	17	90	1661	1049	1888	7622086	7058820	7764701
12	487887	2	17	90	1799	1627	0	8114571	7764702	8470583
13	741955	1	17	65	1792	0	0	8859952	8470584	9176465
14	716738	3	17	70	1655	1873	1128	9578482	9176466	9882347
15	682251	3	17	90	1252	1021	1670	10265389	9882348	10588229
16	875025	2	17	55	1747	1269	0	11144357	10588230	11294111
17	580411	2	17	55	1901	1297	0	11272784	11294112	11999993

Total number of pulses in waveform = 33

Type 5 Radar Waveform_12

Num of Bursts = 17
Burst Interval (us) = 705882

Burst #	Off Time (us)	# Pulses	Chirp (MHz)	PW (us)	Pulse 1 Pri (us)	Pulse 2 Pri (us)	Pulse 3 Pri (us)	Start Loc (us)	Start Burst Interval (us)	End Burst Interval (us)
1	526417	2	18	95	1647	1458	0	526417	0	705881
2	663704	2	18	75	1091	1612	0	1193226	705882	1411763
3	799540	3	18	60	1366	1619	1059	1995469	1411764	2117645
4	719611	1	18	80	1357	0	0	2719124	2117646	2823527
5	375378	3	18	60	1263	1392	1098	3095859	2823528	3529409
6	945779	1	18	80	1834	0	0	4045391	3529410	4235291
7	245178	3	18	60	1246	1739	1921	4292403	4235292	4941173
8	714710	2	18	65	1644	1957	0	5012019	4941174	5647055
9	813798	3	18	90	1058	1266	1882	5829418	5647056	6352937
10	671250	2	18	50	1201	1799	0	6504874	6352938	7058819
11	947892	1	18	55	1605	0	0	7455566	7058820	7764701
12	930091	3	18	90	1540	1368	1060	8387262	7764702	8470583
13	503707	2	18	80	1438	1817	0	8894937	8470584	9176465
14	744543	2	18	90	1005	1935	0	9642735	9176466	9882347
15	251513	2	18	95	1838	1605	0	9897188	9882348	10588229
16	1342675	3	18	80	1975	1516	1196	11243306	10588230	11294111
17	53056	1	18	60	1777	0	0	11301049	11294112	11999993

Total number of pulses in waveform = 36

Type 5 Radar Waveform_13

Num of Bursts = 16
Burst Interval (us) = 750000

Burst #	Off Time (us)	# Pulses	Chirp (MHz)	PW (us)	Pulse 1 Pri (us)	Pulse 2 Pri (us)	Pulse 3 Pri (us)	Start Loc (us)	Start Burst Interval (us)	End Burst Interval (us)
1	473638	1	5	65	1845	0	0	473638	0	749999
2	304105	3	5	55	1370	1992	1351	779588	750000	1499999
3	800301	2	5	75	1563	1127	0	1584602	1500000	2249999
4	1249142	1	5	60	1429	0	0	2836434	2250000	2999999
5	721284	1	5	85	1354	0	0	3559147	3000000	3749999
6	609604	1	5	70	1770	0	0	4170105	3750000	4499999
7	956432	2	5	75	1436	1269	0	5128307	4500000	5249999
8	792055	2	5	60	1630	1197	0	5923067	5250000	5999999
9	706465	2	5	70	1896	1538	0	6632359	6000000	6749999
10	688264	2	5	95	1490	1225	0	7304057	6750000	7499999
11	222085	3	5	75	1409	1552	1886	7528857	7500000	8249999
12	996906	3	5	65	1970	1919	1956	8530610	8250000	8999999
13	1195217	3	5	75	1078	1094	1476	9731672	9000000	9749999
14	697966	3	5	60	1559	1848	1452	10433286	9750000	10499999
15	745582	2	5	95	1856	1669	0	11183727	10500000	11249999
16	287621	2	5	75	1207	1973	0	11474873	11250000	11999999

Total number of pulses in waveform = 33



Type 5 Radar Waveform_14

Num of Bursts = 17
Burst Interval (us)= 705882

Burst #	Off Time (us)	# Pulses	Chirp (MHz)	PW (us)	Pulse 1 Pri (us)	Pulse 2 Pri (us)	Pulse 3 Pri (us)	Start Loc (us)	Start Burst Interval (us)	End Burst Interval (us)
1	549525	1	12	75	1971	0	0	549525	0	705881
2	344226	3	12	55	1724	1726	1951	895722	705882	1411763
3	956048	1	12	95	1701	0	0	1857171	1411764	2117645
4	341899	3	12	65	1433	1440	1029	2200771	2117646	2823527
5	904692	1	12	90	1656	0	0	3109365	2823528	3529409
6	468422	1	12	60	1427	0	0	3579443	3529410	4235291
7	684988	1	12	55	1935	0	0	4265858	4235292	4941173
8	1218478	2	12	70	1972	1320	0	5486271	4941174	5647055
9	580077	1	12	90	1412	0	0	6069640	5647056	6352937
10	869783	1	12	75	1024	0	0	6940835	6352938	7058819
11	691961	1	12	60	1314	0	0	7633820	7058820	7764701
12	306381	3	12	85	1833	1749	1887	7941515	7764702	8470583
13	921966	2	12	90	1155	1204	0	8868950	8470584	9176465
14	452942	1	12	100	1821	0	0	9324251	9176466	9882347
15	1138794	2	12	95	1702	1476	0	10464866	9882348	10588229
16	820374	3	12	50	1084	1590	1085	11288418	10588230	11294111
17	47309	3	12	60	1435	1401	1368	11339486	11294112	11999993

Total number of pulses in waveform = 30

Type 5 Radar Waveform_15

Num of Bursts = 10
Burst Interval (us)= 1200000

Burst #	Off Time (us)	# Pulses	Chirp (MHz)	PW (us)	Pulse 1 Pri (us)	Pulse 2 Pri (us)	Pulse 3 Pri (us)	Start Loc (us)	Start Burst Interval (us)	End Burst Interval (us)
1	219016	3	9	90	1438	1443	1774	219016	0	1199999
2	1290061	2	9	85	1449	1898	0	1513732	1200000	2399999
3	1968465	1	9	65	1576	0	0	3485544	2400000	3599999
4	435008	3	9	60	1573	1739	1921	3922128	3600000	4799999
5	1782648	3	9	75	1279	1095	1231	5710009	4800000	5999999
6	1131718	1	9	100	1146	0	0	6845332	6000000	7199999
7	1235752	3	9	60	1046	1552	1342	8082230	7200000	8399999
8	1172109	1	9	50	1003	0	0	9258279	8400000	9599999
9	1328299	3	9	55	1546	1954	1182	10587581	9600000	10799999
10	721738	3	9	85	1355	1157	1746	11314001	10800000	11999999

Total number of pulses in waveform = 23

Type 5 Radar Waveform_16

Num of Bursts = 18
Burst Interval (us)= 666667

Burst #	Off Time (us)	# Pulses	Chirp (MHz)	PW (us)	Pulse 1 Pri (us)	Pulse 2 Pri (us)	Pulse 3 Pri (us)	Start Loc (us)	Start Burst Interval (us)	End Burst Interval (us)
1	327787	1	6	90	1704	0	0	327787	0	666666
2	591446	2	6	55	1533	1929	0	920937	666667	1333333
3	539846	1	6	85	1938	0	0	1464245	1333334	2000000
4	599315	2	6	65	1641	1325	0	2065498	2000001	2666667
5	694796	3	6	95	1066	1698	1909	2763200	2666668	3333334
6	741154	1	6	95	1954	0	0	3509027	3333335	4000001
7	687131	1	6	90	1356	0	0	4198112	4000002	4666668
8	874880	2	6	75	1336	1873	0	5074348	4666669	5333335
9	740992	3	6	50	1669	1554	1913	5818549	5333336	6000002
10	449579	3	6	1339	1176	1959	0	6273264	6000003	6666669
11	548917	2	6	55	1225	1143	0	6826655	6666670	7333336
12	780795	3	6	60	1416	1427	1197	7608818	7333337	8000003
13	791829	2	6	65	1961	1510	0	8405687	8000004	8666670
14	341124	3	6	75	1612	1069	1271	8750282	8666671	9333337
15	964540	2	6	50	1719	1450	0	9718774	9333338	10000004
16	627629	1	6	80	1049	0	0	10349572	10000005	10666671
17	491203	2	6	80	1701	1542	0	10841824	10666672	11333338
18	587790	1	6	75	1024	0	0	11432857	11333339	12000005

Total number of pulses in waveform = 35



Type 5 Radar Waveform_17

Num of Bursts = 19
Burst Interval (us) = 631579

Burst #	Off Time (us)	# Pulses	Chirp (MHz)	PW (us)	Pulse 1 Pri (us)	Pulse 2 Pri (us)	Pulse 3 Pri (us)	Start Loc (us)	Start Burst Interval (us)	End Burst Interval (us)
1	305814	1	8	100	1307	0	0	305814	0	631578
2	681808	3	8	95	1097	1218	1318	988929	631579	1263157
3	501187	2	8	75	1004	1318	0	1493749	1263158	1894736
4	789109	3	8	85	1648	1534	1158	2285180	1894737	2526315
5	642778	2	8	90	1495	1443	0	2932298	2526316	3157894
6	757716	3	8	70	1912	1735	1516	3692952	3157895	3789473
7	264937	2	8	75	1677	1180	0	3963052	3789474	4421052
8	878296	2	8	95	1561	1933	0	4844205	4421053	5052631
9	812449	2	8	55	1263	1143	0	5660148	5052632	5684210
10	107685	1	8	90	1777	0	0	5770239	5684211	6315789
11	1068281	1	8	80	1686	0	0	6840297	6315790	6947368
12	723269	3	8	100	1879	1494	1325	7565242	6947369	7578947
13	386040	3	8	50	1297	1497	1103	7955980	7578948	8210526
14	850593	2	8	95	1123	1417	0	8810470	8210527	8842105
15	369487	3	8	85	1145	1471	1308	9182497	8842106	9473684
16	834672	1	8	75	1182	0	0	10021093	9473685	10105263
17	384237	1	8	70	1994	0	0	10406512	10105264	10736842
18	850161	2	8	85	1454	1786	0	11258667	10736843	11368421
19	344511	1	8	70	1715	0	0	11606418	11368422	12000000

Total number of pulses in waveform = 35

Type 5 Radar Waveform_18

Num of Bursts = 19
Burst Interval (us) = 631579

Burst #	Off Time (us)	# Pulses	Chirp (MHz)	PW (us)	Pulse 1 Pri (us)	Pulse 2 Pri (us)	Pulse 3 Pri (us)	Start Loc (us)	Start Burst Interval (us)	End Burst Interval (us)
1	513013	2	19	65	1468	1246	0	513013	0	631578
2	345811	2	19	65	1044	1185	0	861538	631579	1263157
3	685266	2	19	50	1243	1769	0	1549033	1263158	1894736
4	798373	2	19	90	1622	1719	0	2350418	1894737	2526315
5	485985	1	19	50	1847	0	0	2829744	2526316	3157894
6	680328	2	19	60	1890	1100	0	3521919	3157895	3789473
7	866544	3	19	90	1042	1159	1728	4391453	3789474	4421052
8	402337	2	19	65	1710	1524	0	4797719	4421053	5052631
9	626022	1	19	100	1782	0	0	5426975	5052632	5684210
10	302754	3	19	75	1922	1365	1267	5731511	5684211	6315789
11	1120202	2	19	1518	1622	0	0	6856258	6315790	6947368
12	137996	2	19	90	1737	1153	0	6997384	6947369	7578947
13	905202	1	19	55	1112	0	0	7905476	7578948	8210526
14	686781	3	19	65	1991	1700	1078	8593369	8210527	8842105
15	460743	2	19	70	1230	1222	0	9058881	8842106	9473684
16	724606	2	19	75	1851	1663	0	9785939	9473685	10105263
17	333160	2	19	55	1695	1203	0	10122613	10105264	10736842
18	693204	2	19	95	1413	1672	0	10818715	10736843	11368421
19	854880	2	19	60	1972	1003	0	11676680	11368422	12000000

Total number of pulses in waveform = 38

Type 5 Radar Waveform_19

Num of Bursts = 20
Burst Interval (us) = 600000

Burst #	Off Time (us)	# Pulses	Chirp (MHz)	PW (us)	Pulse 1 Pri (us)	Pulse 2 Pri (us)	Pulse 3 Pri (us)	Start Loc (us)	Start Burst Interval (us)	End Burst Interval (us)
1	481971	1	10	80	1189	0	0	481971	0	600000
2	240913	3	10	100	1166	1663	1597	724073	600000	1199999
3	587660	1	10	55	1702	0	0	1316059	1200000	1799999
4	986238	2	10	95	1690	1460	0	2303999	1800000	2399999
5	546267	1	10	75	1198	0	0	2853416	2400000	2999999
6	615936	2	10	90	1384	1481	0	3470550	3000000	3599999
7	405324	2	10	95	1988	1024	0	3878739	3600000	4199999
8	461704	2	10	95	1357	1571	0	4343455	4200000	4799999
9	983943	3	10	85	1866	1833	1467	5330326	4800000	5399999
10	433830	3	10	60	1558	1710	1791	5769322	5400000	5999999
11	617900	3	10	70	1528	1903	1964	6392281	6000000	6599999
12	249484	2	10	80	1338	1887	0	6647160	6600000	7199999
13	880238	1	10	70	1603	0	0	7530623	7200000	7799999
14	612665	2	10	60	1415	1990	0	8144791	7800000	8399999
15	260321	3	10	95	1986	1834	1759	8408517	8400000	8999999
16	1063955	3	10	65	1105	1801	1186	9478051	9000000	9599999
17	686232	1	10	60	1905	0	0	10188375	9600000	10199999
18	296506	2	10	55	1841	1280	0	10466786	10200000	10799999
19	391424	3	10	80	1490	1957	1424	10861331	10800000	11399999
20	1069070	3	10	70	1466	1683	1336	11935272	11400000	11999999

Total number of pulses in waveform = 43



Type 5 Radar Waveform_20

Num of Bursts = 14
Burst Interval (us)= 857143

Burst #	Off Time (us)	# Pulses	Chirp (MHz)	PW (us)	Pulse 1 Pri (us)	Pulse 2 Pri (us)	Pulse 3 Pri (us)	Start Loc (us)	Start Burst Interval (us)	End Burst Interval (us)
1	846542	3	14	90	1572	1848	1960	846542	0	857142
2	405846	1	14	50	1171	0	0	1257768	857143	1714285
3	814594	2	14	100	1187	1305	0	2073533	1714286	2571428
4	609096	3	14	90	1048	1366	1179	2685121	2571429	3428571
5	1471379	1	14	70	1408	0	0	4160093	3428572	4285714
6	294132	1	14	60	1766	0	0	4455633	4285715	5142857
7	788401	2	14	70	1679	1879	0	5245800	5142858	6000000
8	892719	3	14	85	1548	1316	1051	6142077	6000001	6857143
9	827245	2	14	55	1136	1304	0	6973237	6857144	7714286
10	1537614	3	14	60	1242	1982	1998	8513291	7714287	8571429
11	185186	1	14	50	1331	0	0	8703699	8571430	9428572
12	1538569	1	14	60	1453	0	0	10243599	9428573	10285715
13	227129	1	14	70	1834	0	0	10472181	10285716	11142858
14	941925	3	14	95	1138	1050	1393	11415940	11142859	12000001

Total number of pulses in waveform = 27

Type 5 Radar Waveform_21

Num of Bursts = 20
Burst Interval (us)= 600000

Burst #	Off Time (us)	# Pulses	Chirp (MHz)	PW (us)	Pulse 1 Pri (us)	Pulse 2 Pri (us)	Pulse 3 Pri (us)	Start Loc (us)	Start Burst Interval (us)	End Burst Interval (us)
1	545294	2	12	85	1433	1052	0	545294	0	599999
2	187413	2	12	85	1556	1712	0	735192	600000	1199999
3	655406	3	12	90	1302	1925	1612	1393866	1200000	1799999
4	810672	2	12	90	1143	1203	0	2209377	1800000	2399999
5	628824	2	12	75	1457	1535	0	2840547	2400000	2999999
6	687863	2	12	65	1435	1522	0	3531392	3000000	3599999
7	238277	1	12	65	1012	0	0	3772626	3600000	4199999
8	701615	3	12	70	1825	1400	1939	4475253	4200000	4799999
9	766830	2	12	90	1235	1616	0	5247247	4800000	5399999
10	410553	1	12	75	1437	0	0	5660651	5400000	5999999
11	408678	3	12	95	1204	1483	1141	6070766	6000000	6599999
12	874199	1	12	75	1088	0	0	6948793	6600000	7199999
13	594909	3	12	70	1482	1490	1346	7544790	7200000	7799999
14	337906	1	12	80	1825	0	0	7887014	7800000	8399999
15	993234	2	12	60	1424	1293	0	8882073	8400000	8999999
16	680857	2	12	60	1243	1103	0	9565647	9000000	9599999
17	273002	1	12	65	1337	0	0	9840995	9600000	10199999
18	935838	3	12	100	1604	1954	1658	10778170	10200000	10799999
19	418046	3	12	65	1900	1224	1437	11201432	10800000	11399999
20	633340	1	12	75	1046	0	0	11839333	11400000	11999999

Total number of pulses in waveform = 40

Type 5 Radar Waveform_22

Num of Bursts = 11
Burst Interval (us)= 1090909

Burst #	Off Time (us)	# Pulses	Chirp (MHz)	PW (us)	Pulse 1 Pri (us)	Pulse 2 Pri (us)	Pulse 3 Pri (us)	Start Loc (us)	Start Burst Interval (us)	End Burst Interval (us)
1	580607	2	9	70	1017	1354	0	580607	0	1090908
2	1418734	1	9	50	1605	0	0	2001712	1090909	2181817
3	424500	1	9	75	1597	0	0	2427817	2181818	3272726
4	1498617	2	9	95	1829	1627	0	3928031	3272727	4363635
5	938870	1	9	60	1825	0	0	4870357	4363636	5454544
6	1315929	2	9	100	1530	1948	0	6188111	5454545	6545453
7	1418170	3	9	100	1875	1309	1781	7609759	6545454	7636362
8	818915	3	9	95	1483	1243	1513	8433639	7636363	8727271
9	526791	3	9	60	1746	1572	1242	8964669	8727272	9818180
10	1267094	1	9	55	1692	0	0	10236323	9818181	10909089
11	1613839	1	9	60	1634	0	0	11851854	10909090	11999998

Total number of pulses in waveform = 20



Type 5 Radar Waveform_23

Num of Bursts = 12
Burst Interval (us)= 1000000

Burst #	Off Time (us)	# Pulses	Chirp (MHz)	PW (us)	Pulse 1 Pri(us)	Pulse 2 Pri(us)	Pulse 3 Pri(us)	Start Loc (us)	Start Burst Interval(us)	End Burst Interval(us)
1	198393	3	5	80	1535	1405	1819	198393	0	999999
2	1016570	1	5	65	1282	0	0	1219722	1000000	1999999
3	1121262	1	5	95	1810	0	0	2342266	2000000	2999999
4	802589	2	5	85	1168	1683	0	3146665	3000000	3999999
5	1666498	3	5	50	1022	1771	1301	4816014	4000000	4999999
6	684079	2	5	65	1272	1080	0	5504187	5000000	5999999
7	1101471	3	5	60	1986	1270	1827	6608010	6000000	6999999
8	1298607	3	5	70	1333	1423	1850	7911700	7000000	7999999
9	1074731	2	5	60	1508	1687	0	8991037	8000000	8999999
10	527721	3	5	75	1144	1996	1296	9521953	9000000	9999999
11	654287	2	5	60	1976	1611	0	10180676	10000000	10999999
12	1102217	2	5	95	1446	1951	0	11286480	11000000	11999999

Total number of pulses in waveform = 27

Type 5 Radar Waveform_24

Num of Bursts = 12
Burst Interval (us)= 1000000

Burst #	Off Time (us)	# Pulses	Chirp (MHz)	PW (us)	Pulse 1 Pri(us)	Pulse 2 Pri(us)	Pulse 3 Pri(us)	Start Loc (us)	Start Burst Interval(us)	End Burst Interval(us)
1	536287	3	10	85	1502	1890	1650	536287	0	999999
2	584963	2	10	65	1545	1714	0	1126292	1000000	1999999
3	1122810	3	10	70	1142	1865	1725	2252361	2000000	2999999
4	1230883	3	10	100	1558	1044	1467	3487976	3000000	3999999
5	1343135	3	10	75	1512	1235	1550	4835180	4000000	4999999
6	797655	1	10	80	1130	0	0	5637132	5000000	5999999
7	949342	2	10	95	1841	1360	0	6587604	6000000	6999999
8	1340547	1	10	75	1355	0	0	7931352	7000000	7999999
9	542931	2	10	90	1578	1658	0	8475638	8000000	8999999
10	1201562	1	10	75	1844	0	0	9680436	9000000	9999999
11	950976	1	10	100	1061	0	0	10633256	10000000	10999999
12	756886	3	10	65	1482	1373	1053	11391203	11000000	11999999

Total number of pulses in waveform = 25

Type 5 Radar Waveform_25

Num of Bursts = 16
Burst Interval (us)= 750000

Burst #	Off Time (us)	# Pulses	Chirp (MHz)	PW (us)	Pulse 1 Pri(us)	Pulse 2 Pri(us)	Pulse 3 Pri(us)	Start Loc (us)	Start Burst Interval(us)	End Burst Interval(us)
1	479916	2	14	50	1409	1624	0	479916	0	749999
2	460530	1	14	55	1760	0	0	943479	750000	1499999
3	696559	2	14	85	1691	1662	0	1641798	1500000	2249999
4	1156732	3	14	60	1136	1007	1481	2801883	2250000	2999999
5	690420	1	14	50	1639	0	0	3495927	3000000	3749999
6	399364	3	14	55	1160	1263	1479	3896930	3750000	4499999
7	1242646	1	14	85	1298	0	0	5143478	4500000	5249999
8	258085	2	14	60	1156	1607	0	5402861	5250000	5999999
9	843118	2	14	60	1466	1351	0	6248742	6000000	6749999
10	523426	3	14	90	1642	1424	1682	6774985	6750000	7499999
11	1432835	3	14	50	1185	1606	1517	8212568	7500000	8249999
12	296786	1	14	75	1865	0	0	8513662	8250000	8999999
13	921101	3	14	80	1038	1654	1298	9436628	9000000	9749999
14	678193	3	14	55	1749	1917	1387	10118811	9750000	10499999
15	399746	1	14	85	1699	0	0	10523610	10500000	11249999
16	1422711	2	14	100	1728	1983	0	11948020	11250000	11999999

Total number of pulses in waveform = 33



Type 5 Radar Waveform_26

Num of Bursts = 10
Burst Interval (us)= 1200000

Burst #	Off Time (us)	# Pulses	Chirp (MHz)	PW (us)	Pulse 1 Pri(us)	Pulse 2 Pri(us)	Pulse 3 Pri(us)	Start Loc (us)	Start Burst Interval(us)	End Burst Interval(us)
1	371298	1	6	60	1171	0	0	371298	0	1199999
2	928347	2	6	75	1935	1043	0	1300816	1200000	2399999
3	1449506	3	6	55	1259	1316	1905	2753302	2400000	3599999
4	1913787	2	6	65	1231	1911	0	4671569	3600000	4799999
5	896711	1	6	75	1336	0	0	5571422	4800000	5999999
6	1129900	2	6	65	1764	1466	0	6702658	6000000	7199999
7	925162	2	6	50	1797	1850	0	7631050	7200000	8399999
8	1712396	1	6	85	1455	0	0	9347093	8400000	9599999
9	799757	1	6	90	1867	0	0	10148305	9600000	10799999
10	1578212	2	6	90	1405	1701	0	11728384	10800000	11999999

Total number of pulses in waveform = 17

Type 5 Radar Waveform_27

Num of Bursts = 9
Burst Interval (us)= 1333333

Burst #	Off Time (us)	# Pulses	Chirp (MHz)	PW (us)	Pulse 1 Pri(us)	Pulse 2 Pri(us)	Pulse 3 Pri(us)	Start Loc (us)	Start Burst Interval(us)	End Burst Interval(us)
1	1050522	1	8	60	1670	0	0	1050522	0	1333332
2	1360247	1	8	60	1442	0	0	2412439	1333333	2666665
3	682390	2	8	95	1660	1134	0	3096271	2666666	3999998
4	1530826	2	8	80	1532	1447	0	4629891	3999999	5333331
5	778621	1	8	80	1392	0	0	5411491	5333332	6666664
6	2293383	3	8	100	1808	1519	1373	7706266	6666665	7999997
7	1369077	3	8	80	1316	1736	1303	9080043	7999998	9333330
8	295749	2	8	60	1270	1026	0	9380147	9333331	10666663
9	2221804	2	8	85	1197	1254	0	11604247	10666664	11999996

Total number of pulses in waveform = 17

Type 5 Radar Waveform_28

Num of Bursts = 12
Burst Interval (us)= 1000000

Burst #	Off Time (us)	# Pulses	Chirp (MHz)	PW (us)	Pulse 1 Pri(us)	Pulse 2 Pri(us)	Pulse 3 Pri(us)	Start Loc (us)	Start Burst Interval(us)	End Burst Interval(us)
1	189925	3	19	55	1457	1384	1341	189925	0	999999
2	1606235	2	19	65	1636	1840	0	1800342	1000000	1999999
3	1098987	3	19	60	1915	1687	1090	2902805	2000000	2999999
4	889492	3	19	50	1070	1448	1685	3796989	3000000	3999999
5	991795	1	19	70	1157	0	0	4792987	4000000	4999999
6	786350	2	19	70	1118	1518	0	5580494	5000000	5999999
7	1228816	2	19	50	1953	1458	0	6811946	6000000	6999999
8	635397	2	19	90	1697	1113	0	7450754	7000000	7999999
9	779291	3	19	95	1781	1075	1400	8232755	8000000	8999999
10	1092281	1	19	55	1286	0	0	9329292	9000000	9999999
11	1570058	2	19	85	1443	1791	0	10900636	10000000	10999999
12	104739	2	19	65	1110	1834	0	11008609	11000000	11999999

Total number of pulses in waveform = 26



Type 5 Radar Waveform_29

Num of Bursts = 10
Burst Interval (us)= 1200000

Burst #	Off Time (us)	# Pulses	Chirp (MHz)	PW (us)	Pulse 1 Pri(us)	Pulse 2 Pri(us)	Pulse 3 Pri(us)	Start Loc (us)	Start Burst Interval(us)	End Burst Interval(us)
1	1125170	3	18	100	1396	1267	1902	1125170	0	1199999
2	72306	3	18	55	1211	1809	1382	1202041	1200000	2399999
3	1983771	3	18	55	1046	1007	1984	3190214	2400000	3599999
4	991484	1	18	80	1602	0	0	4185735	3600000	4799999
5	1805448	2	18	75	1012	1848	0	5992785	4800000	5999999
6	1145563	3	18	65	1782	1237	1611	7141208	6000000	7199999
7	1055725	2	18	60	1497	1303	0	8201563	7200000	8399999
8	658021	3	18	100	1352	1109	1679	8862384	8400000	9599999
9	1012063	1	18	90	1005	0	0	9878587	9600000	10799999
10	1206742	3	18	50	1779	1426	1687	11086334	10800000	11999999

Total number of pulses in waveform = 24

Type 5 Radar Waveform_30

Num of Bursts = 10
Burst Interval (us)= 1200000

Burst #	Off Time (us)	# Pulses	Chirp (MHz)	PW (us)	Pulse 1 Pri(us)	Pulse 2 Pri(us)	Pulse 3 Pri(us)	Start Loc (us)	Start Burst Interval(us)	End Burst Interval(us)
1	201624	1	17	55	1449	0	0	201624	0	1199999
2	1032571	2	17	70	1833	1268	0	1235644	1200000	2399999
3	1585588	3	17	80	1477	1376	1951	2824333	2400000	3599999
4	1693652	3	17	55	1202	1325	1552	4522789	3600000	4799999
5	888456	2	17	90	1493	1071	0	5415324	4800000	5999999
6	1214251	1	17	85	1780	0	0	6632139	6000000	7199999
7	1177539	2	17	90	1357	1036	0	7811458	7200000	8399999
8	837697	3	17	70	1799	1537	1410	8651548	8400000	9599999
9	1655716	2	17	95	1311	1915	0	10312010	9600000	10799999
10	1672332	2	17	100	1258	1156	0	11987568	10800000	11999999

Total number of pulses in waveform = 21



Radar Type 6 - Radar Statistical Performance

Trail #	Test Freq. (MHz)	1=Detection 0=No Detection	Trail #	Test Freq. (MHz)	1=Detection 0=No Detection
1	5292	1	16	5301	1
2	5292	1	17	5302	1
3	5293	1	18	5302	1
4	5293	1	19	5303	1
5	5294	1	20	5303	1
6	5294	1	21	5304	1
7	5295	1	22	5304	1
8	5295	1	23	5305	1
9	5296	1	24	5305	1
10	5296	1	25	5306	1
11	5297	1	26	5306	1
12	5297	1	27	5307	1
13	5298	1	28	5307	1
14	5299	1	29	5308	1
15	5300	1	30	5308	1
Detection Percentage (%)					100%



Radar waveform #1			Radar waveform #2		
Hopping Number	Frequency (MHz)	Pulse Start (ms)	Hopping Number	Frequency (MHz)	Pulse Start (ms)
2	5317	6	1	5312	3
31	5283	93	5	5303	15
43	5271	129	12	5290	36
59	5305	177	23	5265	69
61	5269	183	25	5320	75
62	5274	186	33	5298	99
72	5308	216	36	5294	108
82	5318	246	38	5314	114
85	5275	255	50	5292	150
92	5313	276	52	5282	156
93	5312	279	60	5284	180
--	--	--	76	5296	228
--	--	--	96	5274	288

Radar waveform #3			Radar waveform #4		
Hopping Number	Frequency (MHz)	Pulse Start (ms)	Hopping Number	Frequency (MHz)	Pulse Start (ms)
12	5315	36	2	5290	6
35	5278	105	6	5296	18
37	5314	111	26	5267	78
42	5266	126	30	5315	90
56	5262	168	42	5318	126
61	5286	183	49	5282	147
65	5298	195	68	5304	204
68	5275	204	75	5298	225
70	5280	210	78	5321	234
77	5268	231	83	5309	249
78	5304	234	91	5295	273
89	5305	267	97	5279	291

Radar waveform #5			Radar waveform #6		
Hopping Number	Frequency (MHz)	Pulse Start (ms)	Hopping Number	Frequency (MHz)	Pulse Start (ms)
3	5293	9	11	5301	33
4	5316	12	27	5296	81
10	5277	30	58	5271	174
11	5286	33	59	5289	177
18	5264	54	81	5291	243
27	5297	81	85	5305	255
28	5302	84	--	--	--
37	5317	111	--	--	--
41	5314	123	--	--	--
53	5275	159	--	--	--
61	5296	183	--	--	--
66	5280	198	--	--	--
68	5304	204	--	--	--
75	5313	225	--	--	--
80	5270	240	--	--	--
86	5289	258	--	--	--
91	5282	273	--	--	--
95	5320	285	--	--	--
97	5315	291	--	--	--
99	5266	297	--	--	--

Radar waveform #7			Radar waveform #8		
Hopping Number	Frequency (MHz)	Pulse Start (ms)	Hopping Number	Frequency (MHz)	Pulse Start (ms)
3	5289	9	1	5263	3
6	5276	18	15	5289	45
8	5295	24	23	5318	69
17	5308	51	24	5308	72
21	5306	63	25	5281	75
22	5284	66	39	5309	117
24	5285	72	53	5312	159
37	5282	111	93	5292	279
42	5314	126	--	--	--
49	5294	147	--	--	--
53	5290	159	--	--	--
66	5309	198	--	--	--
71	5283	213	--	--	--
75	5264	225	--	--	--
79	5262	237	--	--	--



Radar waveform #9			Radar waveform #10		
Hopping Number	Frequency (MHz)	Pulse Start (ms)	Hopping Number	Frequency (MHz)	Pulse Start (ms)
0	5313	0	1	5317	3
11	5270	33	6	5305	18
17	5302	51	14	5267	42
31	5295	93	22	5270	66
37	5272	111	29	5294	87
42	5291	126	37	5278	111
46	5275	138	39	5266	117
53	5285	159	42	5313	126
55	5286	165	43	5281	129
59	5278	177	57	5312	171
64	5287	192	66	5295	198
71	5265	213	71	5303	213
73	5308	219	74	5316	222
76	5318	228	77	5293	231
78	5300	234	78	5315	234
80	5307	240	93	5269	279
82	5301	246	95	5272	285
88	5267	264	--	--	--

Radar waveform #11			Radar waveform #12		
Hopping Number	Frequency (MHz)	Pulse Start (ms)	Frequency (MHz)	Hopping Number	Pulse Start (ms)
1	5309	3	0	5323	0
21	5274	63	2	5325	6
33	5283	99	12	5330	36
63	5325	189	17	5298	51
75	5304	225	33	5280	99
78	5296	234	38	5306	114
81	5285	243	42	5315	126
83	5303	249	45	5301	135
91	5330	273	59	5283	177
92	5271	276	62	5312	186
--	--	--	98	5316	294



Radar waveform #13			Radar waveform #14		
Hopping Number	Frequency (MHz)	Pulse Start (ms)	Hopping Number	Frequency (MHz)	Pulse Start (ms)
2	5299	6	1	5292	3
15	5279	45	10	5324	30
16	5316	48	16	5310	48
18	5287	54	17	5326	51
19	5273	57	20	5294	60
22	5304	66	34	5300	102
24	5313	72	38	5287	114
32	5286	96	39	5306	117
38	5289	114	40	5322	120
41	5307	123	42	5274	126
53	5308	159	44	5297	132
55	5284	165	55	5311	165
59	5292	177	62	5303	186
75	5323	225	66	5305	198
86	5280	258	70	5304	210
88	5278	264	71	5323	213
--	--	--	93	5290	279
--	--	--	95	5330	285

Radar waveform #15			Radar waveform #16		
Hopping Number	Frequency (MHz)	Pulse Start (ms)	Hopping Number	Frequency (MHz)	Pulse Start (ms)
5	5305	15	3	5309	9
16	5289	48	10	5277	30
24	5328	72	12	5319	36
28	5283	84	13	5308	39
29	5276	87	22	5285	66
31	5322	93	24	5322	72
34	5274	102	34	5293	102
35	5279	105	35	5316	105
36	5313	108	47	5284	141
44	5324	132	58	5287	174
47	5314	141	81	5317	243
62	5330	186	95	5302	285
65	5318	195	99	5274	297
75	5306	225	--	--	--
77	5272	231	--	--	--
79	5300	237	--	--	--
83	5298	249	--	--	--
86	5275	258	--	--	--
87	5316	261	--	--	--
89	5293	267	--	--	--

Radar waveform #17			Radar waveform #18		
Hopping Number	Frequency (MHz)	Pulse Start (ms)	Hopping Number	Frequency (MHz)	Pulse Start (ms)
2	5270	6	2	5288	6
3	5300	9	5	5295	15
18	5320	54	9	5279	27
22	5288	66	27	5299	81
29	5313	87	68	5289	204
32	5312	96	76	5310	228
41	5280	123	78	5293	234
51	5321	153	86	5323	258
56	5316	168	94	5284	282
64	5292	192	--	--	--
66	5305	198	--	--	--
67	5307	201	--	--	--
72	5293	216	--	--	--
84	5291	252	--	--	--
85	5294	255	--	--	--
88	5326	264	--	--	--
96	5308	288	--	--	--



Radar waveform #19			Radar waveform #20		
Hopping Number	Frequency (MHz)	Pulse Start (ms)	Hopping Number	Frequency (MHz)	Pulse Start (ms)
2	5283	6	1	5294	3
12	5325	36	3	5299	9
14	5312	42	14	5300	42
26	5279	78	18	5283	54
30	5321	90	19	5273	57
33	5297	99	23	5327	69
34	5293	102	28	5289	84
36	5290	108	41	5275	123
39	5300	117	47	5319	141
41	5288	123	60	5291	180
49	5282	147	72	5285	216
60	5301	180	86	5286	258
66	5307	198	87	5320	261
77	5322	231	--	--	--
79	5303	237	--	--	--
93	5276	279	--	--	--

Radar waveform #21			Radar waveform #22		
Hopping Number	Frequency (MHz)	Pulse Start (ms)	Hopping Number	Frequency (MHz)	Pulse Start (ms)
6	5300	18	5	5288	15
10	5326	30	14	5295	42
26	5283	78	15	5324	45
37	5315	111	28	5317	84
41	5306	123	41	5287	123
43	5313	129	56	5299	168
47	5305	141	60	5337	180
49	5287	147	87	5336	261
63	5314	189	90	5332	270
68	5334	204	92	5306	276
73	5290	219	93	5322	279
94	5308	282	94	5328	282



Radar waveform #23			Radar waveform #24		
Hopping Number	Frequency (MHz)	Pulse Start (ms)	Hopping Number	Frequency (MHz)	Pulse Start (ms)
12	5307	36	23	5289	69
22	5315	66	42	5287	126
23	5305	69	46	5336	138
44	5323	132	47	5326	141
45	5333	135	54	5339	162
48	5281	144	75	5304	225
57	5321	171	85	5281	255
61	5283	183	92	5298	276
63	5296	189	95	5317	285
73	5299	219	--	--	--
79	5318	237	--	--	--
81	5310	243	--	--	--
91	5284	273	--	--	--
94	5298	282	--	--	--
97	5335	291	--	--	--

Radar waveform #25			Radar waveform #26		
Hopping Number	Frequency (MHz)	Pulse Start (ms)	Hopping Number	Frequency (MHz)	Pulse Start (ms)
2	5281	6	8	5288	24
8	5333	24	12	5337	36
9	5315	27	20	5325	60
14	5325	42	23	5334	69
20	5324	60	31	5297	93
24	5291	72	33	5310	99
27	5326	81	37	5304	111
30	5302	90	39	5313	117
59	5332	177	46	5292	138
62	5289	186	70	5280	210
89	5322	267	71	5294	213
92	5314	276	74	5281	222
--	--	--	78	5317	234
--	--	--	80	5322	240
--	--	--	87	5327	261



Radar waveform #27			Radar waveform #28		
Hopping Number	Frequency (MHz)	Pulse Start (ms)	Hopping Number	Frequency (MHz)	Pulse Start (ms)
2	5334	6	18	5322	54
8	5287	24	19	5319	57
20	5302	60	22	5289	66
25	5303	75	23	5292	69
26	5305	78	25	5312	75
35	5313	105	31	5284	93
44	5288	132	36	5281	108
45	5319	135	41	5336	123
46	5331	138	48	5302	144
49	5306	147	49	5300	147
57	5339	171	52	5296	156
60	5324	180	58	5295	174
62	5284	186	65	5338	195
77	5304	231	83	5305	249
--	--	--	85	5328	255
--	--	--	95	5316	285

Radar waveform #29			Radar waveform #30		
Hopping Number	Frequency (MHz)	Pulse Start (ms)	Hopping Number	Frequency (MHz)	Pulse Start (ms)
2	5282	6	0	5339	0
7	5297	21	8	5313	24
22	5314	66	12	5335	36
23	5307	69	24	5323	72
25	5285	75	36	5333	108
27	5306	81	62	5322	186
35	5325	105	67	5281	201
43	5295	129	86	5337	258
52	5301	156	94	5307	282
61	5322	183	97	5308	291
65	5300	195	--	--	--
80	5312	240	--	--	--
88	5304	264	--	--	--
93	5331	279	--	--	--



Product	AC220m Wi-Fi module OD US	Temperature	27°C
Test Engineer	Paddy Chen	Relative Humidity	65%
Test Site	TR5	Test Date	2017/12/19
Test Item	Radar Statistical Performance Check (802.11n-HT40 mode – 5310MHz)		

Radar Type 1 - Radar Statistical Performance

Trail #	Test Freq. (MHz)	Pulse Width (us)	PRI (us)	Pulses / Burst	1=Detection 0=No Detection
1	5292	1	758	70	1
2	5293	1	598	89	1
3	5294	1	938	57	1
4	5295	1	738	72	1
5	5296	1	558	95	1
6	5299	1	538	99	1
7	5300	1	698	76	1
8	5301	1	3066	18	1
9	5302	1	818	65	1
10	5303	1	678	78	1
11	5304	1	578	92	1
12	5306	1	798	67	1
13	5307	1	518	102	1
14	5308	1	618	86	1
15	5309	1	658	81	1
16	5310	1	1751	31	1
17	5311	1	1944	28	1
18	5312	1	1509	35	1
19	5316	1	1799	30	1
20	5317	1	1337	40	1
21	5318	1	2564	21	1
22	5319	1	2141	25	1
23	5320	1	1255	43	1
24	5321	1	2394	23	1
25	5322	1	2387	23	1
26	5323	1	1643	33	1



Trail #	Test Freq. (MHz)	Pulse Width (us)	PRI (us)	Pulses / Burst	1=Detection 0=No Detection
27	5324	1	2805	19	1
28	5325	1	2240	24	1
29	5326	1	1908	28	1
30	5327	1	1351	40	1
Detection Percentage (%)					100%



Radar Type 2 - Radar Statistical Performance

Trail #	Test Freq. (MHz)	Pulse Width (us)	PRI (us)	Pulses / Burst	1=Detection 0=No Detection
1	5292	1.6	225	26	1
2	5293	2.1	194	28	1
3	5294	3.2	216	26	1
4	5295	1.1	185	24	1
5	5296	3.5	228	28	1
6	5299	5.0	163	24	1
7	5300	4.3	218	29	1
8	5301	1.3	226	26	1
9	5302	3.1	177	24	1
10	5303	1.8	219	24	1
11	5304	3.7	215	29	1
12	5306	4.1	154	25	1
13	5307	4.9	183	26	1
14	5308	3.1	158	27	1
15	5309	1.9	219	25	1
16	5310	4.1	199	29	1
17	5311	3.3	210	28	1
18	5312	4.4	182	27	1
19	5316	1.1	218	29	1
20	5317	2.7	168	29	1
21	5318	1.2	218	27	1
22	5319	3.0	180	28	1
23	5320	3.7	170	25	1
24	5321	1.1	229	27	1
25	5322	1.1	228	28	1
26	5323	4.3	158	25	1
27	5324	4.8	163	25	1
28	5325	1.5	199	28	1
29	5326	2.4	203	27	1
30	5327	4.7	228	29	1
Detection Percentage (%)					100%



Radar Type 3 - Radar Statistical Performance

Trail #	Test Freq. (MHz)	Pulse Width (us)	PRI (us)	Pulses / Burst	1=Detection 0=No Detection
1	5292	7.0	389	18	1
2	5293	7.5	356	17	1
3	5294	9.8	265	17	1
4	5295	7.3	370	18	1
5	5296	7.6	362	16	1
6	5299	6.3	333	16	1
7	5300	7.5	498	18	1
8	5301	7.8	391	16	1
9	5302	9.1	361	17	1
10	5303	8.2	398	17	1
11	5304	7.0	468	16	1
12	5306	8.7	396	18	1
13	5307	8.0	367	17	1
14	5308	9.7	427	16	1
15	5309	6.3	264	17	1
16	5310	10.0	270	17	1
17	5311	8.3	284	18	1
18	5312	8.6	425	16	1
19	5316	6.8	471	17	1
20	5317	7.7	396	17	1
21	5318	8.8	453	16	1
22	5319	9.9	337	16	1
23	5320	9.7	360	16	1
24	5321	7.5	321	16	1
25	5322	8.7	386	18	1
26	5323	7.4	287	18	1
27	5324	7.0	303	17	1
28	5325	7.6	268	16	1
29	5326	8.3	381	17	1
30	5327	7.2	483	16	1
Detection Percentage (%)					100%



Radar Type 4 - Radar Statistical Performance

Trail #	Test Freq. (MHz)	Pulse Width (us)	PRI (us)	Pulses / Burst	1=Detection 0=No Detection
1	5292	15.0	263	13	1
2	5293	16.0	485	13	1
3	5294	17.0	251	14	1
4	5295	12.6	265	13	1
5	5296	14.3	438	15	1
6	5299	18.2	446	16	1
7	5300	17.7	475	13	1
8	5301	15.1	329	12	1
9	5302	13.6	430	13	1
10	5303	11.0	490	15	1
11	5304	15.5	387	13	1
12	5306	12.4	463	13	1
13	5307	19.7	493	14	1
14	5308	11.7	419	14	1
15	5309	15.7	298	16	1
16	5310	14.1	367	15	1
17	5311	15.4	376	13	1
18	5312	19.9	299	16	1
19	5316	19.4	377	12	1
20	5317	15.1	296	12	1
21	5318	17.8	473	13	1
22	5319	14.4	446	15	1
23	5320	12.8	320	15	1
24	5321	14.1	394	14	1
25	5322	17.7	312	12	1
26	5323	20.0	385	13	1
27	5324	14.2	296	15	1
28	5325	12.0	356	13	1
29	5326	11.8	487	13	1
30	5327	14.2	280	13	1
Detection Percentage (%)					100%
Note: In addition an average minimum percentage of successful detection across all four Short pulse radar test waveforms is as follows: $\frac{P_d1+P_d2+P_d3+P_d4}{4} = (100\%+100\%+100\%+100\%)/4 = 100\% (>80\%)$					



Radar Type 5 - Radar Statistical Performance

Trail #	Test Freq. (MHz)	1=Detection 0=No Detection	Trail #	Test Freq. (MHz)	1=Detection 0=No Detection
1	5299.2	1	16	5310.0	1
2	5297.6	1	17	5310.0	1
3	5296.0	1	18	5310.0	1
4	5296.8	1	19	5310.0	1
5	5295.6	1	20	5310.0	1
6	5294.4	1	21	5323.2	1
7	5298.8	1	22	5324.4	1
8	5294.0	1	23	5326.0	1
9	5295.2	1	24	5324.0	1
10	5299.6	1	25	5322.4	1
11	5310.0	1	26	5325.6	1
12	5310.0	1	27	5324.8	1
13	5310.0	1	28	5320.4	1
14	5310.0	1	29	5320.8	1
15	5310.0	1	30	5321.2	1
Detection Percentage (%)					5296.8

Type 5 Radar Waveform_1										
<pre> ----- Num of Bursts = 19 Burst Interval (us) = 631579 Burst # Off Time (us) # Pulses Chirp (MHz) PW (us) Pulse 1 Pri (us) Pulse 2 Pri (us) Pulse 3 Pri (us) Start Loc (us) Start Burst Interval (us) End Burst Interval (us) 1 102763 2 18 106 1066 1400 0 102763 0 631578 2 787941 1 18 60 1222 0 0 893160 631579 1263157 3 801358 1 18 65 1914 1578 0 1695740 1263158 1894736 4 242473 2 18 85 1908 1418 0 1941705 1894737 2526315 5 607528 2 18 50 1829 1606 0 2552559 2526316 3157894 6 827685 3 18 65 1359 1798 1484 3383679 3157895 3789473 7 560733 1 18 95 1103 0 0 3949053 3789474 4421052 8 1052621 3 18 100 1660 1134 1509 5002777 4421053 5052631 9 188514 1 18 50 1667 0 0 5195594 5052632 5684210 10 919687 3 18 75 1802 1387 1463 6110948 5684211 6315789 11 283033 3 18 70 1441 1212 1577 6398633 6315790 6947368 12 1168042 2 18 90 1965 1201 0 7570905 6947369 7578947 13 360407 2 18 65 1287 1184 0 7934478 7578948 8210526 14 795172 1 18 100 1046 0 0 8732121 8210527 8842105 15 167621 1 18 85 1246 0 0 8900788 8842106 9473684 16 897128 2 18 75 1711 1724 0 9799162 9473685 10105263 17 818240 2 18 100 1339 1126 0 10620837 10105264 10736842 18 619245 1 18 90 1624 0 0 11242547 10736843 11368421 19 442739 2 18 60 1528 1989 0 11686910 11368422 12000000 Total number of pulses in waveform = 36 ***** </pre>										



Type 5 Radar Waveform_2

Num of Bursts = 14
Burst Interval (us)= 857143

Burst #	Off Time (us)	# Pulses	Chirp (MHz)	PW (us)	Pulse 1 Pri (us)	Pulse 2 Pri (us)	Pulse 3 Pri (us)	Start Loc (us)	Start Burst Interval (us)	End Burst Interval (us)
1	546281	2	14	75	1467	1276	0	546281	0	857142
2	546379	1	14	50	1229	0	0	1095403	857143	1714285
3	867324	1	14	55	1736	0	0	1963956	1714286	2571428
4	1334350	1	14	90	1864	0	0	3300042	2571429	3428571
5	817547	2	14	95	1729	1721	0	4119453	3428572	4285714
6	668719	2	14	70	1321	1347	0	4791622	4285715	5142857
7	590876	2	14	95	1119	1848	0	5385166	5142858	6000000
8	1337864	1	14	85	1973	0	0	6725997	6000001	6857143
9	424029	2	14	70	1736	1549	0	7151999	6857144	7714286
10	978190	1	14	55	1109	0	0	8133474	7714287	8571429
11	831567	3	14	100	1179	1841	1663	8966150	8571430	9428572
12	633819	1	14	50	1725	0	0	9604652	9428573	10285715
13	969862	2	14	75	1491	1551	0	10576239	10285716	11142858
14	641434	3	14	75	1309	1330	1178	11220715	11142859	12000001

Total number of pulses in waveform = 24

Type 5 Radar Waveform_3

Num of Bursts = 13
Burst Interval (us)= 923077

Burst #	Off Time (us)	# Pulses	Chirp (MHz)	PW (us)	Pulse 1 Pri (us)	Pulse 2 Pri (us)	Pulse 3 Pri (us)	Start Loc (us)	Start Burst Interval (us)	End Burst Interval (us)
1	89563	1	10	95	1926	0	0	89563	0	923076
2	1627327	3	10	80	1004	1028	1355	1718816	923077	1846153
3	422039	3	10	100	1921	1531	1160	2144242	1846154	2769230
4	826388	2	10	100	1929	1560	0	2975242	2769231	3692307
5	1097646	3	10	50	1980	1702	1795	4076377	3692308	4615384
6	1380047	3	10	95	1871	1959	1294	5461901	4615385	5538461
7	897358	3	10	75	1283	1163	1669	6364383	5538462	6461538
8	615535	2	10	95	1541	1053	0	6984033	6461539	7384615
9	610758	3	10	75	1528	1924	1838	7597385	7384616	8307692
10	1567350	1	10	75	1326	0	0	9170025	8307693	9230769
11	951410	3	10	95	1816	1069	1120	10122761	9230770	10153846
12	84862	1	10	80	1426	0	0	10211628	10153847	11076923
13	1213459	3	10	70	1806	1206	1138	11426513	11076924	12000000

Total number of pulses in waveform = 31

Type 5 Radar Waveform_4

Num of Bursts = 15
Burst Interval (us)= 800000

Burst #	Off Time (us)	# Pulses	Chirp (MHz)	PW (us)	Pulse 1 Pri (us)	Pulse 2 Pri (us)	Pulse 3 Pri (us)	Start Loc (us)	Start Burst Interval (us)	End Burst Interval (us)
1	313179	2	12	50	1749	1332	0	313179	0	799999
2	1121712	1	12	85	1248	0	0	1437972	800000	1599999
3	806431	2	12	95	1960	1874	0	2245651	1600000	2399999
4	573848	1	12	95	1433	0	0	2823333	2400000	3199999
5	643512	2	12	75	1422	1728	0	3468278	3200000	3999999
6	936374	3	12	50	1163	1135	1598	4407802	4000000	4799999
7	469092	2	12	100	1395	1089	0	4880790	4800000	5599999
8	1379020	3	12	55	1543	1005	1146	6262294	5600000	6399999
9	585712	2	12	65	1156	1859	0	6851700	6400000	7199999
10	719456	2	12	50	1273	1762	0	7574171	7200000	7999999
11	488982	3	12	65	1492	1721	1124	8066188	8000000	8799999
12	829236	2	12	70	1367	1627	0	8899761	8800000	9599999
13	703916	3	12	55	1140	1966	1009	9606671	9600000	10399999
14	1387462	2	12	70	1162	1319	0	10998248	10400000	11199999
15	512146	1	12	70	1009	0	0	11512875	11200000	11999999

Total number of pulses in waveform = 31



Type 5 Radar Waveform_5

Num of Bursts = 18
Burst Interval (us)= 666667

Burst #	Off Time (us)	# Pulses	Chirp (MHz)	PW (us)	Pulse 1 Pri (us)	Pulse 2 Pri (us)	Pulse 3 Pri (us)	Start Loc (us)	Start Burst Interval (us)	End Burst Interval (us)
1	328412	3	9	85	1221	1475	1853	328412	0	666666
2	745614	3	9	95	1537	1850	1320	1078575	666667	1333333
3	492784	3	9	95	1717	1752	1104	1576066	1333334	2000000
4	1078390	2	9	95	1742	1910	0	2659029	2000001	2666667
5	122337	2	9	75	1825	1151	0	2785018	2666668	3333334
6	1196360	1	9	55	1040	0	0	3984354	3333335	4000001
7	140000	2	9	75	1441	1902	0	4125394	4000002	4666668
8	1191172	1	9	85	1954	0	0	5319909	4666669	5333335
9	111732	3	9	65	1858	1029	1985	5433595	5333336	6000002
10	802568	1	9	55	1678	0	0	6241035	6000003	6666669
11	807425	3	9	95	1806	1918	1872	7050138	6666670	7333336
12	281463	2	9	90	1923	1605	0	7337197	7333337	8000003
13	1269263	2	9	80	1727	1393	0	8609988	8000004	8666670
14	655874	2	9	85	1444	1631	0	9268982	8666671	9333337
15	581190	3	9	75	1234	1899	1063	9853247	9333338	10000004
16	474614	3	9	75	1961	1494	1020	10332057	10000005	10666671
17	534812	2	9	100	1155	1205	0	10871344	10666672	11333338
18	497907	2	9	50	1750	1168	0	11371611	11333339	12000005

Total number of pulses in waveform = 40

Type 5 Radar Waveform_6

Num of Bursts = 9
Burst Interval (us)= 1333333

Burst #	Off Time (us)	# Pulses	Chirp (MHz)	PW (us)	Pulse 1 Pri (us)	Pulse 2 Pri (us)	Pulse 3 Pri (us)	Start Loc (us)	Start Burst Interval (us)	End Burst Interval (us)
1	225474	3	6	100	1791	1352	1215	225474	0	1333332
2	1133832	1	6	70	1638	0	0	1363664	1333333	2666665
3	2264424	1	6	55	1830	0	0	3629726	2666666	3999998
4	1533988	2	6	100	1549	1303	0	5165544	3999999	5333331
5	373497	1	6	90	1045	0	0	5541893	5333332	6666664
6	2445157	2	6	85	1153	1136	0	7988095	6666665	7999997
7	56364	1	6	70	1511	0	0	8046748	7999998	9333330
8	1414614	1	6	55	1371	0	0	9462873	9333331	10666663
9	1235759	1	6	95	1089	0	0	10700003	10666664	11999996

Total number of pulses in waveform = 13

Type 5 Radar Waveform_7

Num of Bursts = 12
Burst Interval (us)= 1000000

Burst #	Off Time (us)	# Pulses	Chirp (MHz)	PW (us)	Pulse 1 Pri (us)	Pulse 2 Pri (us)	Pulse 3 Pri (us)	Start Loc (us)	Start Burst Interval (us)	End Burst Interval (us)
1	689434	3	17	50	1496	1882	1563	689434	0	999999
2	346730	3	17	80	1559	1789	1612	1041105	1000000	1999999
3	1515940	3	17	70	1505	1317	1243	2562005	2000000	2999999
4	941205	3	17	75	1906	1369	1894	3507275	3000000	3999999
5	521227	1	17	85	1422	0	0	4033671	4000000	4999999
6	1504767	1	17	95	1564	0	0	5539860	5000000	5999999
7	1445666	3	17	55	1970	1163	1486	6987090	6000000	6999999
8	797934	2	17	60	1622	1394	0	7789643	7000000	7999999
9	589942	2	17	70	1071	1016	0	8382601	8000000	8999999
10	1535187	1	17	75	1394	0	0	9919875	9000000	9999999
11	442112	2	17	65	1863	1428	0	10363381	10000000	10999999
12	1342470	3	17	75	1887	1963	1813	11709142	11000000	11999999

Total number of pulses in waveform = 27



Type 5 Radar Waveform_8

Num of Bursts = 12
Burst Interval (us)= 1000000

Burst #	Off Time (us)	# Pulses	Chirp (MHz)	PW (us)	Pulse 1 Pri(us)	Pulse 2 Pri(us)	Pulse 3 Pri(us)	Start Loc (us)	Start Burst Interval(us)	End Burst Interval(us)
1	485946	3	5	50	1512	1760	1905	485946	0	999999
2	1125333	2	5	50	1523	1134	0	1616456	1000000	1999999
3	1336344	2	5	80	1882	1603	0	2955457	2000000	2999999
4	808360	1	5	60	1606	0	0	3767302	3000000	3999999
5	404950	3	5	75	1990	1366	1464	4173858	4000000	4999999
6	1792165	3	5	50	1285	1715	1776	5970843	5000000	5999999
7	438523	3	5	60	1390	1625	1682	6414142	6000000	6999999
8	1034537	3	5	70	1902	1754	1868	7453376	7000000	7999999
9	1333194	1	5	65	1911	0	0	8792094	8000000	8999999
10	1150596	2	5	70	1100	1067	0	9944601	9000000	9999999
11	352933	3	5	55	1758	1396	1791	10299701	10000000	10999999
12	696855	3	5	75	1371	1982	1717	11001441	11000000	11999999

Total number of pulses in waveform = 29

Type 5 Radar Waveform_9

Num of Bursts = 16
Burst Interval (us)= 750000

Burst #	Off Time (us)	# Pulses	Chirp (MHz)	PW (us)	Pulse 1 Pri(us)	Pulse 2 Pri(us)	Pulse 3 Pri(us)	Start Loc (us)	Start Burst Interval(us)	End Burst Interval(us)
1	380086	3	8	75	1572	1900	1525	380086	0	749999
2	515272	3	8	100	1312	1243	1864	900355	750000	1499999
3	829567	1	8	75	1070	0	0	1734341	1500000	2249999
4	1073883	3	8	65	1820	1980	1626	2809294	2250000	2999999
5	819921	3	8	75	1845	1668	1586	3634641	3000000	3749999
6	469718	2	8	50	1197	1749	0	4109458	3750000	4499999
7	807323	1	8	85	1157	0	0	4919727	4500000	5249999
8	1017206	2	8	80	2000	1317	0	5938090	5250000	5999999
9	326190	1	8	50	1220	0	0	6267597	6000000	6749999
10	1032918	2	8	80	1103	1244	0	7301735	6750000	7499999
11	940143	3	8	50	1820	1863	1946	8244225	7500000	8249999
12	722612	1	8	80	1143	0	0	8972466	8250000	8999999
13	519843	1	8	75	1248	0	0	9493452	9000000	9749999
14	281552	1	8	75	1821	0	0	9776252	9750000	10499999
15	1417745	3	8	50	1458	1711	1498	11195818	10500000	11249999
16	621885	3	8	85	1072	1394	1178	11822370	11250000	11999999

Total number of pulses in waveform = 33

Type 5 Radar Waveform_10

Num of Bursts = 9
Burst Interval (us)= 1333333

Burst #	Off Time (us)	# Pulses	Chirp (MHz)	PW (us)	Pulse 1 Pri(us)	Pulse 2 Pri(us)	Pulse 3 Pri(us)	Start Loc (us)	Start Burst Interval(us)	End Burst Interval(us)
1	792653	2	19	95	1840	1434	0	792653	0	1333332
2	1069121	1	19	100	1193	0	0	1865048	1333333	2666665
3	1158469	3	19	60	1527	1786	1361	3024710	2666666	3999998
4	2190493	2	19	75	1298	1546	0	5219877	3999999	5333331
5	1168567	3	19	90	1260	1708	1672	6391288	5333332	6666664
6	888737	2	19	80	1849	1828	0	7284665	6666665	7999997
7	1077119	2	19	95	1534	1811	0	8365461	7999998	9333330
8	2107284	1	19	80	1493	0	0	10476090	9333331	10666663
9	862630	1	19	100	1094	0	0	11340213	10666664	11999996

Total number of pulses in waveform = 17



Type 5 Radar Waveform_11

Num of Bursts = 8
Burst Interval (us)= 1500000

Burst #	Off Time (us)	# Pulses	Chirp (MHz)	PW (us)	Pulse 1 Pri(us)	Pulse 2 Pri(us)	Pulse 3 Pri(us)	Start Loc (us)	Start Burst Interval(us)	End Burst Interval(us)
1	1300312	2	17	80	1072	1341	0	1300312	0	1499999
2	850754	3	17	75	1339	1301	1580	2153479	1500000	2999999
3	953638	1	17	95	1353	0	0	3111337	3000000	4499999
4	2553793	2	17	90	1917	1527	0	5666483	4500000	5999999
5	760450	3	17	80	1625	1896	1068	6430377	6000000	7499999
6	2089604	2	17	50	1925	1688	0	8524570	7500000	8999999
7	1439865	1	17	95	1682	0	0	9968048	9000000	10499999
8	939532	2	17	55	1058	1983	0	10909262	10500000	11999999

Total number of pulses in waveform = 16

Type 5 Radar Waveform_12

Num of Bursts = 10
Burst Interval (us)= 1200000

Burst #	Off Time (us)	# Pulses	Chirp (MHz)	PW (us)	Pulse 1 Pri(us)	Pulse 2 Pri(us)	Pulse 3 Pri(us)	Start Loc (us)	Start Burst Interval(us)	End Burst Interval(us)
1	315149	3	18	60	1613	1983	1849	315149	0	1199999
2	1794859	1	18	60	1774	0	0	2115453	1200000	2399999
3	1010176	2	18	70	1424	1930	0	3127403	2400000	3599999
4	1256211	3	18	85	1421	1644	1728	4386968	3600000	4799999
5	716772	1	18	85	1785	0	0	5108533	4800000	5999999
6	1020964	1	18	55	1387	0	0	6131282	6000000	7199999
7	1784730	3	18	65	1990	1205	1676	7917399	7200000	8399999
8	1203319	3	18	50	1953	1191	1165	9125589	8400000	9599999
9	1354529	3	18	95	1244	1902	1588	10484427	9600000	10799999
10	677094	1	18	85	1634	0	0	11166255	10800000	11999999

Total number of pulses in waveform = 21

Type 5 Radar Waveform_13

Num of Bursts = 8
Burst Interval (us)= 1500000

Burst #	Off Time (us)	# Pulses	Chirp (MHz)	PW (us)	Pulse 1 Pri(us)	Pulse 2 Pri(us)	Pulse 3 Pri(us)	Start Loc (us)	Start Burst Interval(us)	End Burst Interval(us)
1	1423704	1	5	65	1468	0	0	1423704	0	1499999
2	784180	1	5	55	1335	0	0	2209352	1500000	2999999
3	1480851	3	5	100	1812	1944	1790	3691538	3000000	4499999
4	1415388	3	5	50	1321	1044	1408	5112472	4500000	5999999
5	1462592	1	5	70	1173	0	0	6578837	6000000	7499999
6	1565226	3	5	70	1222	1642	1466	8145236	7500000	8999999
7	972461	1	5	75	1979	0	0	9122027	9000000	10499999
8	2838344	1	5	55	1029	0	0	11962350	10500000	11999999

Total number of pulses in waveform = 14



Type 5 Radar Waveform_14

Num of Bursts = 13
Burst Interval (us)= 923077

Burst #	Off Time (us)	# Pulses	Chirp (MHz)	PW (us)	Pulse 1 Pri (us)	Pulse 2 Pri (us)	Pulse 3 Pri (us)	Start Loc (us)	Start Burst Interval (us)	End Burst Interval (us)
1	841876	2	12	65	1352	1392	0	841876	0	923076
2	165695	2	12	60	1836	1950	0	1010315	923077	1846153
3	1045707	3	12	80	1203	1706	1132	2059808	1846154	2769230
4	1219668	1	12	55	1346	0	0	3283517	2769231	3692307
5	528514	1	12	90	1491	0	0	3813377	3692308	4615384
6	1091681	3	12	90	1903	1890	1916	4906549	4615385	5538461
7	956338	2	12	90	1301	1604	0	5868596	5538462	6461538
8	956058	1	12	65	1009	0	0	6827559	6461539	7384615
9	1416144	1	12	85	1277	0	0	8244712	7384616	8307692
10	832079	2	12	75	1033	1259	0	9078068	8307693	9230769
11	564388	2	12	80	1049	1778	0	9644748	9230770	10153846
12	1141558	2	12	75	1643	1494	0	10789133	10153847	11076923
13	982496	1	12	80	1256	0	0	11774766	11076924	12000000

Total number of pulses in waveform = 23

Type 5 Radar Waveform_15

Num of Bursts = 17
Burst Interval (us)= 705882

Burst #	Off Time (us)	# Pulses	Chirp (MHz)	PW (us)	Pulse 1 Pri (us)	Pulse 2 Pri (us)	Pulse 3 Pri (us)	Start Loc (us)	Start Burst Interval (us)	End Burst Interval (us)
1	210059	3	9	65	1850	1618	1336	210059	0	705881
2	502876	2	9	75	1212	1888	0	717739	705882	1411763
3	1256908	1	9	60	1571	0	0	1977747	1411764	2117645
4	591871	3	9	90	1469	1823	1159	2571189	2117646	2823527
5	591314	2	9	80	1597	1086	0	3166954	2823528	3529409
6	485024	1	9	95	1727	0	0	3654661	3529410	4235291
7	712494	1	9	70	1184	0	0	4368882	4235292	4941173
8	623290	1	9	95	1864	0	0	4993356	4941174	5647055
9	980631	1	9	50	1580	0	0	5975851	5647056	6352937
10	384515	1	9	85	1588	0	0	6361946	6352938	7058819
11	1294881	2	9	65	1447	1553	0	7658415	7058820	7764701
12	172013	1	9	65	1631	0	0	7833428	7764702	8470583
13	955259	3	9	60	1120	1335	1912	8790318	8470584	9176465
14	899412	1	9	85	1458	0	0	9694097	9176466	9882347
15	250221	1	9	95	1075	0	0	9945776	9882348	10588229
16	1307968	2	9	50	1093	1192	0	11254819	10588230	11294111
17	719778	3	9	70	1174	1666	1257	11976882	11294112	11999993

Total number of pulses in waveform = 29

Type 5 Radar Waveform_16

Num of Bursts = 18
Burst Interval (us)= 666667

Burst #	Off Time (us)	# Pulses	Chirp (MHz)	PW (us)	Pulse 1 Pri (us)	Pulse 2 Pri (us)	Pulse 3 Pri (us)	Start Loc (us)	Start Burst Interval (us)	End Burst Interval (us)
1	487415	3	6	85	1893	1705	1675	487415	0	666666
2	522374	1	6	75	1027	0	0	1015062	666667	1333333
3	333031	1	6	65	1593	0	0	1349120	1333334	2000000
4	1009096	1	6	50	1152	0	0	2359809	2000001	2666667
5	752738	2	6	100	1000	1857	0	3113699	2666668	3333334
6	740986	3	6	85	1359	1766	1866	3857542	3333335	4000001
7	752947	3	6	75	1893	1513	1941	4615480	4000002	4666668
8	447748	1	6	95	1415	0	0	5068375	4666669	5333335
9	367997	3	6	95	1881	1989	1147	5437787	5333336	6000002
10	1001797	3	6	70	1534	1601	1404	6444601	6000003	6666669
11	810109	3	6	75	1301	1207	1927	7259249	6666670	7333336
12	604958	1	6	95	1669	0	0	7868642	7333337	8000003
13	509374	2	6	70	1806	1301	0	8379685	8000004	8666670
14	519776	3	6	100	1450	1933	1366	8902568	8666671	9333337
15	452698	3	6	95	1153	1339	1402	9360015	9333338	10000004
16	781632	2	6	65	1243	1579	0	10145541	10000005	10666671
17	1172572	3	6	55	1795	1571	1678	11320935	10666672	11333338
18	184201	2	6	70	1480	1914	0	11510180	11333339	12000005

Total number of pulses in waveform = 40



Type 5 Radar Waveform_17

Num of Bursts = 18
Burst Interval (us) = 666667

Burst #	Off Time (us)	# Pulses	Chirp (MHz)	PW (us)	Pulse 1 Pri (us)	Pulse 2 Pri (us)	Pulse 3 Pri (us)	Start Loc (us)	Start Burst Interval (us)	End Burst Interval (us)
1	216861	1	8	55	1770	0	0	216861	0	666666
2	1107126	1	8	50	1557	0	0	1325757	666667	1333333
3	455345	3	8	60	1591	1467	1635	1782659	1333334	2000000
4	828941	1	8	65	1453	0	0	2616293	2000001	2666667
5	237057	3	8	100	1972	1497	1781	2854803	2666668	3333334
6	948082	3	8	90	1488	1714	1645	3808135	3333335	4000001
7	206300	3	8	55	1560	1528	1173	4019282	4000002	4666668
8	954587	3	8	70	1888	1141	1856	4978130	4666669	5333335
9	577827	3	8	85	1737	1811	1759	5560842	5333336	6000002
10	631993	2	8	70	1886	1467	0	6198142	6000003	6666669
11	980169	3	8	70	1031	1356	1524	7181664	6666670	7333336
12	351218	1	8	85	1068	0	0	7536793	7333337	8000003
13	477870	1	8	95	1266	0	0	8015731	8000004	8666670
14	663671	1	8	80	1156	0	0	8680668	8666671	9333337
15	938955	2	8	60	1064	1301	0	9620779	9333338	10000004
16	739019	1	8	80	1919	0	0	10362163	10000005	10666671
17	413791	1	8	90	1093	0	0	10777873	10666672	11333338
18	1108981	1	8	85	1288	0	0	11887947	11333339	12000005

Total number of pulses in waveform = 34

Type 5 Radar Waveform_18

Num of Bursts = 15
Burst Interval (us) = 800000

Burst #	Off Time (us)	# Pulses	Chirp (MHz)	PW (us)	Pulse 1 Pri (us)	Pulse 2 Pri (us)	Pulse 3 Pri (us)	Start Loc (us)	Start Burst Interval (us)	End Burst Interval (us)
1	678170	2	19	100	1595	1655	0	678170	0	799999
2	584312	2	19	100	1999	1323	0	1265732	800000	1599999
3	769697	1	19	85	1002	0	0	2038751	1600000	2399999
4	439399	2	19	100	1409	1465	0	2479152	2400000	3199999
5	902776	2	19	75	1959	1264	0	3384802	3200000	3999999
6	1181254	3	19	60	1380	1930	1320	4569279	4000000	4799999
7	969711	3	19	60	1335	1271	1740	5543620	4800000	5599999
8	271674	1	19	90	1721	0	0	5819640	5600000	6399999
9	781628	2	19	95	1180	1209	0	6602989	6400000	7199999
10	1246840	1	19	90	1867	0	0	7852218	7200000	7999999
11	370174	3	19	85	1323	1634	1982	8224259	8000000	8799999
12	902283	3	19	70	1845	1449	1956	9131481	8800000	9599999
13	859845	1	19	75	1595	0	0	9996576	9600000	10399999
14	772085	3	19	95	1054	1578	1046	10770256	10400000	11199999
15	552886	3	19	100	1041	1605	1818	11326820	11200000	11999999

Total number of pulses in waveform = 32

Type 5 Radar Waveform_19

Num of Bursts = 9
Burst Interval (us) = 1333333

Burst #	Off Time (us)	# Pulses	Chirp (MHz)	PW (us)	Pulse 1 Pri (us)	Pulse 2 Pri (us)	Pulse 3 Pri (us)	Start Loc (us)	Start Burst Interval (us)	End Burst Interval (us)
1	775719	3	10	95	1676	1333	1237	775719	0	1333332
2	705383	1	10	80	1236	0	0	1485348	1333333	2666665
3	2149143	2	10	50	1711	1157	0	3635727	2666666	3999998
4	1331082	3	10	55	1466	1078	1283	4969677	3999999	5333331
5	1436301	2	10	75	1244	1249	0	6409805	5333332	6666664
6	806634	2	10	60	1751	1117	0	7218932	6666665	7999997
7	879922	3	10	50	1910	1789	1336	8101722	7999998	9333330
8	1627698	3	10	100	1834	1664	1580	9734455	9333331	10666663
9	1126300	2	10	50	1527	1039	0	10865833	10666664	11999996

Total number of pulses in waveform = 21



Type 5 Radar Waveform_20

Num of Bursts = 13
Burst Interval (us)= 923077

Burst #	Off Time (us)	# Pulses	Chirp (MHz)	PW (us)	Pulse 1 Pri (us)	Pulse 2 Pri (us)	Pulse 3 Pri (us)	Start Loc (us)	Start Burst Interval (us)	End Burst Interval (us)
1	758098	2	14	70	1059	1138	0	758098	0	923076
2	860601	1	14	65	1305	0	0	1620896	923077	1846153
3	264984	3	14	55	1704	1708	1420	1887185	1846154	2769230
4	1278903	1	14	65	1812	0	0	3168920	2769231	3692307
5	1178498	3	14	65	1176	1927	1607	4349230	3692308	4615384
6	603179	1	14	60	1593	0	0	4957119	4615385	5538461
7	809256	1	14	95	1303	0	0	5767968	5538462	6461538
8	816273	1	14	100	1451	0	0	6585544	6461539	7384615
9	1002164	3	14	75	1245	1673	1881	7589159	7384616	8307692
10	1544882	3	14	100	1825	1013	1934	9138840	8307693	9230769
11	275503	1	14	70	1770	0	0	9419115	9230770	10153846
12	1435540	3	14	70	1857	1159	1531	10856425	10153847	11076923
13	592825	2	14	100	1878	1407	0	11453797	11076924	12000000

Total number of pulses in waveform = 25

Type 5 Radar Waveform_21

Num of Bursts = 11
Burst Interval (us)= 1090909

Burst #	Off Time (us)	# Pulses	Chirp (MHz)	PW (us)	Pulse 1 Pri (us)	Pulse 2 Pri (us)	Pulse 3 Pri (us)	Start Loc (us)	Start Burst Interval (us)	End Burst Interval (us)
1	663554	3	12	85	1165	1336	1311	663554	0	1090908
2	573865	3	12	85	1244	1959	1925	1241231	1090909	2181817
3	1368064	3	12	100	1605	1092	1192	2614423	2181818	3272726
4	1199512	3	12	95	1126	1686	1503	3817824	3272727	4363635
5	1044570	2	12	75	1376	1453	0	4866709	4363636	5454544
6	711050	2	12	55	1679	1370	0	5580588	5454545	6545453
7	1147755	2	12	95	1791	1339	0	6731392	6545454	7636362
8	1327634	3	12	90	1463	1598	1434	8062156	7636363	8727271
9	1149434	2	12	80	1144	1501	0	9216085	8727272	9818180
10	1103864	2	12	70	1339	1436	0	10322594	9818181	10909089
11	1123980	3	12	100	1363	1906	1799	11449349	10909090	11999998

Total number of pulses in waveform = 28

Type 5 Radar Waveform_22

Num of Bursts = 8
Burst Interval (us)= 1500000

Burst #	Off Time (us)	# Pulses	Chirp (MHz)	PW (us)	Pulse 1 Pri (us)	Pulse 2 Pri (us)	Pulse 3 Pri (us)	Start Loc (us)	Start Burst Interval (us)	End Burst Interval (us)
1	768227	1	9	55	1840	0	0	768227	0	1499999
2	2166861	3	9	95	1976	1006	1498	2936928	1500000	2999999
3	1014397	3	9	80	1362	1057	1777	3955805	3000000	4499999
4	644361	3	9	95	1343	1735	1199	4604362	4500000	5999999
5	2480829	1	9	70	1665	0	0	7089468	6000000	7499999
6	1187787	3	9	100	1167	1871	1713	8278920	7500000	8999999
7	773271	2	9	75	1782	1321	0	9056942	9000000	10499999
8	2563416	3	9	50	1437	1467	1644	11623461	10500000	11999999

Total number of pulses in waveform = 19



Type 5 Radar Waveform_23

Num of Bursts = 20
Burst Interval (us) = 600000

Burst #	Off Time (us)	# Pulses	Chirp (MHz)	PW (us)	Pulse 1 Pri (us)	Pulse 2 Pri (us)	Pulse 3 Pri (us)	Start Loc (us)	Start Burst Interval (us)	End Burst Interval (us)
1	354547	3	5	95	1833	1871	1595	354547	0	599999
2	409088	1	5	55	1728	0	0	768934	600000	1199999
3	752397	1	5	70	1534	0	0	1523059	1200000	1799999
4	628955	1	5	95	1616	0	0	2153548	1800000	2399999
5	549080	3	5	55	1792	1625	1315	2913251	2400000	2999999
6	401581	3	5	85	1257	1397	1055	3467063	3000000	3599999
7	865062	3	5	85	1887	1396	1205	3872353	3600000	4199999
8	450149	2	5	80	1444	1787	0	4741903	4200000	4799999
9	759948	2	5	85	1577	1858	0	5195283	4800000	5399999
10	457736	1	5	55	1964	0	0	5958666	5400000	5999999
11	434386	1	5	90	1451	0	0	6418366	6000000	6599999
12	848952	3	5	100	1081	1262	1692	6854203	6600000	7199999
13	547143	2	5	55	1340	1151	0	7707190	7200000	7799999
14	683384	1	5	50	1868	0	0	8256824	7800000	8399999
15	340741	1	5	65	1977	0	0	8942076	8400000	8999999
16	681459	3	5	60	1106	1931	1276	9284794	9000000	9599999
17	357763	1	5	80	1325	0	0	9970566	9600000	10199999
18	854334	1	5	100	1407	0	0	10329654	10200000	10799999
19	615499	2	5	90	1833	1895	0	11185395	10800000	11399999
20		2	5	50	1864	1071	0	11804622	11400000	11999999

Total number of pulses in waveform = 37

Type 5 Radar Waveform_24

Num of Bursts = 15
Burst Interval (us) = 800000

Burst #	Off Time (us)	# Pulses	Chirp (MHz)	PW (us)	Pulse 1 Pri (us)	Pulse 2 Pri (us)	Pulse 3 Pri (us)	Start Loc (us)	Start Burst Interval (us)	End Burst Interval (us)
1	332394	1	10	80	1186	0	0	332394	0	799999
2	1065876	3	10	80	1373	1770	1596	1399456	800000	1599999
3	871995	1	10	70	1964	0	0	2276190	1600000	2399999
4	428723	3	10	80	1151	1871	1931	2706877	2400000	3199999
5	1077991	1	10	75	1933	0	0	3789621	3200000	3999999
6	675135	2	10	65	1604	1008	0	4466689	4000000	4799999
7	886257	1	10	95	1450	0	0	5355558	4800000	5599999
8	698448	3	10	95	1313	1634	1758	6055456	5600000	6399999
9	766578	1	10	85	1789	0	0	6826739	6400000	7199999
10	449006	2	10	65	1174	1744	0	7277534	7200000	7999999
11	1194955	1	10	90	1045	0	0	8475407	8000000	8799999
12	688181	2	10	60	1212	1554	0	9164633	8800000	9599999
13	541785	1	10	90	1543	0	0	9709184	9600000	10399999
14	1477621	3	10	80	1309	1254	1193	11188348	10400000	11199999
15	479589	3	10	65	1293	1061	1310	11671693	11200000	11999999

Total number of pulses in waveform = 28

Type 5 Radar Waveform_25

Num of Bursts = 20
Burst Interval (us) = 600000

Burst #	Off Time (us)	# Pulses	Chirp (MHz)	PW (us)	Pulse 1 Pri (us)	Pulse 2 Pri (us)	Pulse 3 Pri (us)	Start Loc (us)	Start Burst Interval (us)	End Burst Interval (us)
1	288795	1	14	50	1921	0	0	288795	0	599999
2	353133	3	14	90	1081	1979	1583	643849	600000	1199999
3	906910	1	14	100	1497	0	0	1555402	1200000	1799999
4	243894	3	14	60	1599	1155	1622	1800793	1800000	2399999
5	752062	3	14	85	1931	1948	1442	2557231	2400000	2999999
6	951435	1	14	70	1525	0	0	3513987	3000000	3599999
7	339575	2	14	60	1008	1126	0	3855087	3600000	4199999
8	438875	2	14	50	1264	1349	0	4293096	4200000	4799999
9	544055	3	14	60	1765	1959	1375	4839764	4800000	5399999
10	570238	2	14	50	1270	1059	0	5415101	5400000	5999999
11	723625	3	14	75	1569	1104	1952	6140955	6000000	6599999
12	999488	2	14	90	1878	1574	0	7145068	6800000	7199999
13	630102	2	14	85	1660	1454	0	7778622	7200000	7799999
14	27156	1	14	100	1796	0	0	7808892	7800000	8399999
15	958616	3	14	85	1114	1674	1115	8769304	8400000	8999999
16	317700	1	14	70	1858	0	0	9090907	9000000	9599999
17	1090906	1	14	60	1689	0	0	10183671	9600000	10199999
18	315059	3	14	75	1346	1009	1204	10500419	10200000	10799999
19	628693	2	14	80	1160	1449	0	11132671	10800000	11399999
20	773356	2	14	85	1044	1553	0	11908636	11400000	11999999

Total number of pulses in waveform = 41



Type 5 Radar Waveform_26

Num of Bursts = 14
Burst Interval (us) = 857143

Burst #	Off Time (us)	# Pulses	Chirp (MHz)	PW (us)	Pulse 1 Pri (us)	Pulse 2 Pri (us)	Pulse 3 Pri (us)	Start Loc (us)	Start Burst Interval (us)	End Burst Interval (us)
1	379065	3	6	85	1062	1772	1999	379065	0	857142
2	770499	1	6	95	1841	0	0	1154397	857143	1714285
3	1284500	1	6	60	1357	0	0	2440738	1714286	2571428
4	304641	2	6	85	1853	1917	0	2746736	2571429	3428571
5	1389528	1	6	75	1835	0	0	4140034	3428572	4285714
6	313206	1	6	70	1510	0	0	4455075	4285715	5142857
7	868085	1	6	50	1162	0	0	5324670	5142858	6000000
8	978552	2	6	80	1855	1336	0	6304384	6000001	6857143
9	967797	2	6	100	1179	1306	0	7275372	6857144	7714286
10	464216	2	6	60	1420	1168	0	7742073	7714287	8571429
11	1139526	2	6	65	1050	1738	1812	8884187	8571430	9428572
12	816104	3	6	80	1076	1984	1670	9704891	9428573	10285715
13	825646	2	6	55	1571	1939	0	10535267	10285716	11142858
14	1143447	2	6	70	1089	1752	0	11682224	11142859	12000001

Total number of pulses in waveform = 26

Type 5 Radar Waveform_27

Num of Bursts = 10
Burst Interval (us) = 1200000

Burst #	Off Time (us)	# Pulses	Chirp (MHz)	PW (us)	Pulse 1 Pri (us)	Pulse 2 Pri (us)	Pulse 3 Pri (us)	Start Loc (us)	Start Burst Interval (us)	End Burst Interval (us)
1	88623	2	8	65	1809	1024	0	88623	0	1199999
2	2294317	3	8	60	1655	1837	1966	2385773	1200000	2399999
3	159577	2	8	95	1887	1181	0	2550808	2400000	3599999
4	1247996	3	8	55	1997	1556	1765	3801872	3600000	4799999
5	1699387	3	8	90	1491	1344	1647	5506577	4800000	5999999
6	971263	3	8	55	1128	1500	1287	6482322	6000000	7199999
7	1041060	1	8	80	1422	0	0	7527297	7200000	8399999
8	1296678	2	8	80	1326	1817	0	8825397	8400000	9599999
9	1096733	3	8	50	1245	1063	1486	9925273	9600000	10799999
10	985854	3	8	65	1525	1221	1080	10914921	10800000	11999999

Total number of pulses in waveform = 25

Type 5 Radar Waveform_28

Num of Bursts = 19
Burst Interval (us) = 631579

Burst #	Off Time (us)	# Pulses	Chirp (MHz)	PW (us)	Pulse 1 Pri (us)	Pulse 2 Pri (us)	Pulse 3 Pri (us)	Start Loc (us)	Start Burst Interval (us)	End Burst Interval (us)
1	388686	2	19	65	1101	1694	0	388686	0	631578
2	364230	3	19	70	1499	1310	1213	745611	631579	1263157
3	839017	1	19	60	1118	0	0	1588650	1263158	1894736
4	921052	2	19	100	1736	1119	0	2510820	1894737	2526315
5	81931	1	19	85	1031	0	0	2696906	2526316	3157894
6	979799	1	19	55	1649	0	0	3576436	3157895	3789473
7	680579	3	19	50	1255	1922	1494	4258664	3789474	4421052
8	400551	1	19	70	1700	0	0	4663886	4421053	5052631
9	492253	3	19	50	1217	1743	1650	5157839	5052632	5684210
10	880886	3	19	85	1705	1472	1969	6043335	5684211	6315789
11	687575	1	19	65	1796	0	0	6736046	6315790	6947368
12	455951	1	19	85	1651	0	0	7193793	6947369	7578947
13	427776	3	19	65	1957	1318	1053	7623220	7578948	8210526
14	696505	1	19	50	1007	0	0	8324053	8210527	8842105
15	621769	2	19	55	1078	1408	0	8946819	8842106	9473684
16	752829	2	19	75	1596	1077	0	9702134	9473685	10105263
17	743782	2	19	95	1535	1452	0	10448689	10105264	10736842
18	365101	2	19	65	1572	1611	0	10816677	10736843	11368421
19	769901	3	19	60	1159	1636	1571	11589761	11368422	12000000

Total number of pulses in waveform = 37



Type 5 Radar Waveform_29

```

-----
Num of Bursts = 16
Burst Interval (us)= 750000

```

Burst #	Off Time (us)	# Pulses	Chirp (MHz)	PW (us)	Pulse 1 Pri (us)	Pulse 2 Pri (us)	Pulse 3 Pri (us)	Start Loc (us)	Start Burst Interval (us)	End Burst Interval (us)
1	380731	3	18	90	1110	1823	1139	380731	0	749999
2	606853	2	18	85	1389	1217	0	991656	750000	1499999
3	863578	3	18	70	1501	1370	1772	1857840	1500000	2249999
4	609405	3	18	50	1124	1461	1426	2471888	2250000	2999999
5	621365	1	18	85	1863	0	0	3097264	3000000	3749999
6	1234347	3	18	60	1509	1627	1721	4333474	3750000	4499999
7	873221	2	18	100	1167	1612	0	5211552	4500000	5249999
8	543450	2	18	70	1327	1980	0	5757781	5250000	5999999
9	689891	2	18	85	1249	1672	0	6450979	6000000	6749999
10	491251	2	18	50	1773	1506	0	6945151	6750000	7499999
11	690029	1	18	75	1964	0	0	7638459	7500000	8249999
12	1166231	3	18	65	1038	1613	1290	8806654	8250000	8999999
13	559456	3	18	55	1812	1079	1601	9370051	9000000	9749999
14	494707	1	18	100	1052	0	0	9869250	9750000	10499999
15	1008118	1	18	90	1557	0	0	10878420	10500000	11249999
16	686848	1	18	75	1749	0	0	11566825	11250000	11999999

Total number of pulses in waveform = 33

Type 5 Radar Waveform_30

```

-----
Num of Bursts = 15
Burst Interval (us)= 800000

```

Burst #	Off Time (us)	# Pulses	Chirp (MHz)	PW (us)	Pulse 1 Pri (us)	Pulse 2 Pri (us)	Pulse 3 Pri (us)	Start Loc (us)	Start Burst Interval (us)	End Burst Interval (us)
1	741	1	17	90	1482	0	0	741	0	799999
2	888687	1	17	55	1989	0	0	890910	800000	1599999
3	1167402	3	17	50	1131	1660	1113	2060301	1600000	2399999
4	974014	3	17	95	1676	1480	1105	3038219	2400000	3199999
5	624329	3	17	70	1711	1978	1863	3666809	3200000	3999999
6	988516	3	17	100	1995	1042	1236	4660877	4000000	4799999
7	609096	3	17	95	1942	1030	1345	5274246	4800000	5599999
8	511095	2	17	55	1834	1346	0	5789658	5600000	6399999
9	1150371	3	17	90	1532	1416	1409	6943209	6400000	7199999
10	896166	2	17	65	1467	1708	0	7843732	7200000	7999999
11	717740	3	17	80	1959	1655	1077	8564647	8000000	8799999
12	829714	3	17	80	1128	1976	1933	9399052	8800000	9599999
13	660522	2	17	55	1029	1777	0	10064611	9600000	10399999
14	522955	3	17	80	1295	1342	1166	10590372	10400000	11199999
15	622296	1	17	70	1121	0	0	11216471	11200000	11999999

Total number of pulses in waveform = 36



Radar Type 6 - Radar Statistical Performance

Trail #	Test Freq. (MHz)	1=Detection 0=No Detection	Trail #	Test Freq. (MHz)	1=Detection 0=No Detection
1	5292	1	16	5310	1
2	5293	1	17	5311	1
3	5294	1	18	5312	1
4	5295	1	19	5316	1
5	5296	1	20	5317	1
6	5299	1	21	5318	1
7	5300	1	22	5319	1
8	5301	1	23	5320	1
9	5302	1	24	5321	1
10	5303	1	25	5322	1
11	5304	1	26	5323	1
12	5306	1	27	5324	1
13	5307	1	28	5325	1
14	5308	1	29	5326	1
15	5309	1	30	5327	1
Detection Percentage (%)					100%



Radar waveform #1			Radar waveform #2		
Hopping Number	Frequency (MHz)	Pulse Start (ms)	Hopping Number	Frequency (MHz)	Pulse Start (ms)
3	5312	9	9	5292	27
9	5269	27	15	5282	45
18	5299	54	20	5305	60
42	5285	126	24	5298	72
47	5265	141	33	5296	99
58	5305	174	37	5269	111
68	5310	204	47	5284	141
72	5306	216	57	5304	171
93	5313	279	63	5311	189
94	5273	282	64	5280	192
97	5272	291	78	5318	234
99	5283	297	83	5303	249
--	--	--	90	5291	270
--	--	--	92	5309	276
--	--	--	96	5306	288
--	--	--	97	5265	291

Radar waveform #3			Radar waveform #4		
Hopping Number	Frequency (MHz)	Pulse Start (ms)	Hopping Number	Frequency (MHz)	Pulse Start (ms)
4	5312	12	0	5275	0
9	5277	27	1	5288	3
42	5287	126	10	5284	30
44	5273	132	35	5282	105
51	5321	153	37	5279	111
53	5303	159	41	5266	123
54	5284	162	56	5290	168
72	5317	216	62	5302	186
78	5300	234	67	5318	201
80	5294	240	77	5270	231
90	5306	270	78	5322	234
93	5307	279	96	5264	288
98	5283	294	--	--	--
99	5289	297	--	--	--

Radar waveform #5			Radar waveform #6		
Hopping Number	Frequency (MHz)	Pulse Start (ms)	Hopping Number	Frequency (MHz)	Pulse Start (ms)
6	5283	18	9	5307	27
7	5324	21	25	5289	75
9	5271	27	27	5299	81
21	5299	63	33	5276	99
23	5280	69	34	5292	102
27	5310	81	42	5302	126
49	5279	147	44	5279	132
53	5316	159	47	5297	141
54	5312	162	48	5291	144
61	5323	183	56	5273	168
63	5286	189	58	5271	174
72	5315	216	63	5294	189
81	5326	243	64	5281	192
94	5285	282	66	5310	198
97	5325	291	80	5293	240
--	--	--	90	5323	270
--	--	--	95	5318	285



Radar waveform #7			Radar waveform #8		
Hopping Number	Frequency (MHz)	Pulse Start (ms)	Hopping Number	Frequency (MHz)	Pulse Start (ms)
3	5271	9	12	5273	36
6	5300	18	34	5306	102
19	5320	57	43	5298	129
21	5306	63	56	5315	168
22	5313	66	58	5283	174
25	5301	75	59	5290	177
44	5302	132	64	5288	192
47	5292	141	66	5277	198
53	5316	159	78	5285	234
56	5325	168	79	5287	237
57	5290	171	81	5296	243
87	5328	261	85	5312	255
92	5298	276	86	5317	258
--	--	--	90	5308	270
--	--	--	92	5295	276

Radar waveform #9			Radar waveform #10		
Hopping Number	Frequency (MHz)	Pulse Start (ms)	Hopping Number	Frequency (MHz)	Pulse Start (ms)
2	5284	6	9	5332	27
26	5306	78	29	5338	87
32	5294	96	35	5286	105
34	5291	102	37	5323	111
50	5279	150	53	5302	159
68	5288	204	70	5336	210
72	5321	216	78	5281	234
74	5335	222	94	5298	282
77	5324	231	99	5314	297
81	5299	243	--	--	--
89	5329	267	--	--	--
97	5298	291	--	--	--
98	5311	294	--	--	--

Radar waveform #11			Radar waveform #12		
Hopping Number	Frequency (MHz)	Pulse Start (ms)	Hopping Number	Frequency (MHz)	Pulse Start (ms)
11	5308	33	4	5307	12
29	5306	87	6	5278	18
51	5316	153	11	5319	33
52	5314	156	26	5303	78
54	5278	162	28	5310	84
59	5328	177	34	5336	102
64	5335	192	47	5292	141
66	5293	198	54	5296	162
67	5325	201	57	5323	171
72	5301	216	79	5287	237
87	5309	261	80	5301	240
97	5319	291	82	5288	246
--	--	--	85	5284	255
--	--	--	97	5329	291
--	--	--	98	5328	294



Radar waveform #13			Radar waveform #14		
Hopping Number	Frequency (MHz)	Pulse Start (ms)	Hopping Number	Frequency (MHz)	Pulse Start (ms)
4	5313	12	0	5299	0
7	5331	21	1	5331	3
12	5335	36	7	5334	21
18	5282	54	11	5286	33
21	5321	63	27	5298	81
23	5287	69	33	5302	99
27	5289	81	39	5281	117
45	5291	135	42	5328	126
53	5304	159	45	5335	135
90	5337	270	53	5295	159
92	5284	276	54	5296	162
93	5306	279	57	5287	171
--	--	--	62	5293	186
--	--	--	78	5303	234
--	--	--	84	5312	252
--	--	--	97	5321	291
--	--	--	99	5283	297

Radar waveform #15			Radar waveform #16		
Hopping Number	Frequency (MHz)	Pulse Start (ms)	Hopping Number	Frequency (MHz)	Pulse Start (ms)
1	5322	3	3	5321	9
4	5332	12	8	5318	24
9	5315	27	20	5322	60
25	5320	75	31	5286	93
33	5326	99	47	5320	141
42	5293	126	76	5340	228
55	5309	165	93	5325	279
56	5300	168	98	5296	294
67	5285	201	--	--	--
75	5292	225	--	--	--
80	5339	240	--	--	--
81	5325	243	--	--	--



Radar waveform #17			Radar waveform #18		
Hopping Number	Frequency (MHz)	Pulse Start (ms)	Hopping Number	Frequency (MHz)	Pulse Start (ms)
7	5319	21	1	5306	3
11	5325	33	12	5319	36
13	5318	39	15	5303	45
24	5306	72	18	5315	54
29	5301	87	23	5340	69
43	5327	129	28	5305	84
51	5336	153	42	5284	126
62	5320	186	49	5302	147
65	5335	195	52	5325	156
88	5297	264	59	5309	177
89	5288	267	60	5310	180
--	--	--	71	5337	213
--	--	--	73	5311	219
--	--	--	75	5324	225
--	--	--	77	5297	231
--	--	--	79	5314	237
--	--	--	89	5323	267



Radar waveform #19			Radar waveform #20		
Hopping Number	Frequency (MHz)	Pulse Start (ms)	Hopping Number	Frequency (MHz)	Pulse Start (ms)
0	5325	0	24	5334	72
2	5313	6	27	5308	81
10	5306	30	30	5307	90
13	5320	39	34	5320	102
26	5298	78	39	5294	117
27	5317	81	44	5303	132
47	5328	141	49	5330	147
55	5284	165	51	5318	153
59	5289	177	57	5317	171
60	5327	180	60	5310	180
65	5316	195	61	5287	183
71	5305	213	62	5283	186
73	5318	219	65	5284	195
85	5329	255	75	5337	225
89	5341	267	95	5325	285
93	5300	279	--	--	--
95	5297	285	--	--	--
98	5286	294	--	--	--

Radar waveform #21			Radar waveform #22		
Hopping Number	Frequency (MHz)	Pulse Start (ms)	Hopping Number	Frequency (MHz)	Pulse Start (ms)
2	5288	6	2	5299	6
12	5301	36	8	5335	24
13	5317	39	11	5341	33
36	5299	108	12	5300	36
43	5289	129	30	5311	90
50	5282	150	50	5334	150
51	5314	153	65	5330	195
60	5307	180	66	5282	198
64	5297	192	67	5314	201
69	5308	207	68	5304	204
74	5336	222	74	5285	222
81	5302	243	77	5295	231
90	5283	270	79	5305	237
--	--	--	83	5289	249
--	--	--	84	5313	252
--	--	--	99	5323	297



Radar waveform #23			Radar waveform #24		
Hopping Number	Frequency (MHz)	Pulse Start (ms)	Hopping Number	Frequency (MHz)	Pulse Start (ms)
1	5322	3	1	5345	3
7	5296	21	20	5347	60
8	5349	24	22	5298	66
33	5332	99	23	5335	69
41	5304	123	26	5310	78
55	5331	165	27	5334	81
69	5324	207	29	5306	87
70	5339	210	33	5315	99
71	5343	213	39	5322	117
82	5303	246	40	5339	120
89	5298	267	56	5331	168
90	5299	270	64	5333	192
--	--	--	68	5341	204
--	--	--	82	5349	246
--	--	--	88	5325	264
--	--	--	94	5326	282
--	--	--	96	5290	288



Radar waveform #25			Radar waveform #26		
Hopping Number	Frequency (MHz)	Pulse Start (ms)	Hopping Number	Frequency (MHz)	Pulse Start (ms)
3	5303	9	0	5290	0
29	5337	87	1	5335	3
32	5309	96	2	5293	6
46	5322	138	10	5307	30
47	5312	141	16	5331	48
48	5297	144	21	5318	63
57	5345	171	22	5326	66
71	5308	213	23	5339	69
72	5293	216	26	5344	78
74	5298	222	35	5310	105
87	5329	261	41	5336	123
3	5303	9	46	5292	138
--	--	--	63	5328	189
--	--	--	69	5302	207
--	--	--	71	5298	213
--	--	--	72	5309	216
--	--	--	81	5304	243
--	--	--	83	5305	249

Radar waveform #27			Radar waveform #28		
Hopping Number	Frequency (MHz)	Pulse Start (ms)	Hopping Number	Frequency (MHz)	Pulse Start (ms)
2	5308	6	9	5317	27
10	5335	30	20	5300	60
14	5355	42	24	5302	72
17	5306	51	31	5353	93
20	5313	60	33	5316	99
34	5351	102	35	5335	105
48	5319	144	37	5322	111
50	5341	150	42	5355	126
55	5316	165	61	5301	183
71	5330	213	64	5356	192
73	5353	219	91	5315	273
88	5338	264	96	5337	288



Radar waveform #29			Radar waveform #30		
Hopping Number	Frequency (MHz)	Pulse Start (ms)	Hopping Number	Frequency (MHz)	Pulse Start (ms)
2	5346	6	5	5320	15
4	5333	12	8	5323	24
5	5298	15	24	5310	72
21	5338	63	36	5322	108
40	5347	120	41	5326	123
57	5344	171	50	5309	150
65	5358	195	54	5336	162
67	5319	201	61	5350	183
73	5324	219	65	5345	195
77	5354	231	66	5339	198
82	5340	246	76	5328	228
95	5331	285	77	5358	231
98	5357	294	80	5347	240
--	--	--	94	5318	282
--	--	--	95	5305	285



Product	AC220m Wi-Fi module OD US	Temperature	27°C
Test Engineer	Paddy Chen	Relative Humidity	65%
Test Site	TR5	Test Date	2017/12/22
Test Item	Radar Statistical Performance Check (802.11ac-VHT80 mode – 5290MHz)		

Radar Type 1 - Radar Statistical Performance

Trail #	Test Freq. (MHz)	Pulse Width (us)	PRI (us)	Pulses / Burst	1=Detection 0=No Detection
1	5252	1	898	59	1
2	5252	1	918	58	1
3	5260	1	858	62	1
4	5260	1	718	74	1
5	5268	1	738	72	1
6	5268	1	798	67	1
7	5270	1	938	57	1
8	5270	1	878	61	1
9	5272	1	538	99	1
10	5272	1	598	89	1
11	5280	1	778	68	1
12	5280	1	838	63	1
13	5288	1	818	65	1
14	5288	1	558	95	1
15	5290	1	698	76	1
16	5290	1	689	77	1
17	5292	1	2398	23	1
18	5292	1	2807	19	1
19	5300	1	2712	20	1
20	5300	1	889	60	1
21	5308	1	1293	41	1
22	5308	1	2641	20	1
23	5310	1	2573	21	1
24	5310	1	1617	33	1
25	5312	1	2175	25	1
26	5312	1	2779	19	1



Trail #	Test Freq. (MHz)	Pulse Width (us)	PRI (us)	Pulses / Burst	1=Detection 0=No Detection
27	5320	1	2929	19	1
28	5320	1	1516	35	1
29	5328	1	978	54	1
30	5328	1	2051	26	1
Detection Percentage (%)					100%



Radar Type 2 - Radar Statistical Performance

Trail #	Test Freq. (MHz)	Pulse Width (us)	PRI (us)	Pulses / Burst	1=Detection 0=No Detection
1	5253	1.6	216	25	1
2	5256	4.6	168	28	1
3	5259	2.0	219	27	1
4	5262	1.2	182	24	1
5	5265	4.1	196	23	1
6	5268	2.4	150	28	1
7	5271	1.3	151	23	1
8	5274	4.4	205	25	1
9	5277	2.0	213	24	1
10	5280	2.6	194	28	1
11	5283	2.2	172	23	1
12	5286	1.6	174	25	1
13	5289	4.4	151	24	1
14	5292	5.0	178	26	1
15	5295	4.4	228	23	1
16	5298	3.0	188	23	1
17	5301	4.6	203	28	1
18	5304	2.5	211	24	1
19	5307	2.7	172	27	1
20	5310	2.9	193	27	1
21	5313	3.5	198	25	1
22	5316	4.7	175	29	1
23	5319	2.3	167	27	1
24	5322	2.9	174	28	1
25	5325	1.5	165	29	1
26	5328	4.1	228	23	1
27	5271	1.6	180	29	1
28	5290	3.9	166	29	1
29	5311	2.6	223	29	1
30	5327	1.7	211	25	1
Detection Percentage (%)					100%



Radar Type 3 - Radar Statistical Performance

Trail #	Test Freq. (MHz)	Pulse Width (us)	PRI (us)	Pulses / Burst	1=Detection 0=No Detection
1	5253	6.3	409	18	1
2	5256	7.8	258	16	1
3	5259	7.6	372	16	1
4	5262	8.8	449	16	1
5	5265	7.6	321	18	1
6	5268	8.3	469	18	1
7	5271	9.7	313	18	1
8	5274	9.2	426	18	1
9	5277	9.0	354	18	1
10	5280	8.2	385	18	1
11	5283	10.0	374	17	1
12	5286	8.8	284	17	1
13	5289	9.2	359	18	1
14	5292	8.9	398	17	1
15	5295	8.6	485	17	1
16	5298	7.8	368	18	1
17	5301	7.8	430	16	1
18	5304	6.0	478	18	1
19	5307	6.7	287	16	1
20	5310	7.7	459	17	1
21	5313	6.0	275	17	1
22	5316	7.6	308	16	1
23	5319	7.6	395	16	1
24	5322	7.4	494	16	1
25	5325	9.9	395	18	1
26	5328	7.4	303	17	1
27	5271	7.5	458	18	1
28	5290	7.1	468	18	1
29	5311	6.2	382	18	1
30	5327	9.9	427	18	1
Detection Percentage (%)					100%



Radar Type 4 - Radar Statistical Performance

Trail #	Test Freq. (MHz)	Pulse Width (us)	PRI (us)	Pulses / Burst	1=Detection 0=No Detection
1	5253	19.7	328	14	1
2	5256	11.2	426	12	1
3	5259	17.8	310	13	1
4	5262	17.6	461	16	1
5	5265	17.8	367	12	1
6	5268	12.6	388	14	1
7	5271	17.9	317	15	1
8	5274	16.8	283	15	1
9	5277	11.5	339	15	1
10	5280	11.9	305	16	1
11	5283	16.9	438	14	1
12	5286	18.7	264	16	1
13	5289	14.1	371	13	1
14	5292	17.5	314	15	1
15	5295	13.8	360	12	1
16	5298	18.6	434	15	1
17	5301	16.7	460	13	1
18	5304	11.0	316	16	1
19	5307	16.5	447	12	1
20	5310	17.3	333	12	1
21	5313	11.0	319	12	1
22	5316	11.8	449	15	1
23	5319	14.4	468	14	1
24	5322	15.1	498	12	1
25	5325	18.2	301	12	1
26	5328	15.7	492	15	1
27	5271	13.3	338	14	1
28	5290	14.9	475	15	1
29	5311	16.7	287	15	1
30	5327	16.9	491	12	1
Detection Percentage (%)					100%
Note: In addition an average minimum percentage of successful detection across all four Short pulse radar test waveforms is as follows: $\frac{P_d1+P_d2+P_d3+P_d4}{4} = (100\%+100\%+100\%+100\%)/4 = 100\% (>80\%)$					



Radar Type 5 - Radar Statistical Performance

Trail #	Test Freq. (MHz)	1=Detection 0=No Detection	Trail #	Test Freq. (MHz)	1=Detection 0=No Detection
1	5259.2	1	16	5290.0	1
2	5257.6	1	17	5290.0	1
3	5256.0	1	18	5290.0	1
4	5256.8	1	19	5290.0	1
5	5255.6	1	20	5290.0	1
6	5254.4	1	21	5323.2	1
7	5258.8	1	22	5324.4	1
8	5254.0	1	23	5326.0	1
9	5255.2	1	24	5324.0	1
10	5259.6	1	25	5322.4	1
11	5290.0	1	26	5325.6	1
12	5290.0	1	27	5324.8	1
13	5290.0	1	28	5320.4	1
14	5290.0	1	29	5320.8	1
15	5290.0	1	30	5321.2	1
Detection Percentage (%)					100%

Type 5 Radar Waveform_1										
Num of Bursts = 8										
Burst Interval (us)= 1500000										
Burst #	Off Time (us)	# Pulses	Chirp (MHz)	PW (us)	Pulse 1 Pri(us)	Pulse 2 Pri(us)	Pulse 3 Pri(us)	Start Loc (us)	Start Burst Interval(us)	End Burst Interval(us)
1	953616	3	18	90	1112	1212	1285	953616	0	1499999
2	1268163	3	18	80	1390	1672	1090	2225388	1500000	2999999
3	1478471	1	18	95	1150	0	0	3708011	3000000	4499999
4	2046444	3	18	85	1989	1033	1279	5755605	4500000	5999999
5	1308894	3	18	55	1977	1787	1180	7068800	6000000	7499999
6	961958	2	18	75	1079	1864	0	8035702	7500000	8999999
7	1943553	1	18	65	1201	0	0	9982198	9000000	10499999
8	1600463	3	18	90	1612	1281	1124	11583862	10500000	11999999
Total number of pulses in waveform = 19										



Type 5 Radar Waveform_2

Num of Bursts = 17
Burst Interval (us)= 705882

Burst #	Off Time (us)	# Pulses	Chirp (MHz)	PW (us)	Pulse 1 Pri (us)	Pulse 2 Pri (us)	Pulse 3 Pri (us)	Start Loc (us)	Start Burst Interval (us)	End Burst Interval (us)
1	214004	3	14	85	1254	1274	1820	214004	0	705881
2	1069905	3	14	90	1717	1232	1723	1288257	705882	1411763
3	570845	3	14	70	1942	1092	1599	1863774	1411764	2117645
4	753478	2	14	50	1198	1740	0	2621885	2117646	2823527
5	674231	1	14	55	1378	0	0	3299054	2823528	3529409
6	431434	2	14	90	1775	1082	0	3731866	3529410	4235291
7	808380	1	14	80	1861	0	0	4543103	4235292	4941173
8	424584	3	14	100	1584	1886	1248	4969548	4941174	5647055
9	1312773	3	14	75	1550	1192	1779	6287039	5647056	6352937
10	664430	2	14	95	1146	1837	0	6959990	6352938	7058819
11	728185	3	14	100	1883	1700	1927	7687158	7058820	7764701
12	130248	3	14	80	1399	1176	1483	7822916	7764702	8470583
13	764715	2	14	90	1290	1776	0	8691689	8470584	9176465
14	819537	2	14	60	1957	1395	0	9414292	9176466	9882347
15	465804	2	14	50	1883	1709	0	9883448	9882348	10588229
16	1088973	3	14	75	1680	1685	1839	10976013	10588230	11294111
17	872636	3	14	50	1754	1716	1055	11853853	11294112	11999993

Total number of pulses in waveform = 41

Type 5 Radar Waveform_3

Num of Bursts = 12
Burst Interval (us)= 1000000

Burst #	Off Time (us)	# Pulses	Chirp (MHz)	PW (us)	Pulse 1 Pri (us)	Pulse 2 Pri (us)	Pulse 3 Pri (us)	Start Loc (us)	Start Burst Interval (us)	End Burst Interval (us)
1	262326	2	10	80	1297	1063	0	262326	0	999999
2	1388183	3	10	95	1663	1691	1084	1652869	1000000	1999999
3	877955	1	10	60	1810	0	0	2535262	2000000	2999999
4	553741	1	10	75	1016	0	0	3090813	3000000	3999999
5	1229000	1	10	70	1332	0	0	4320829	4000000	4999999
6	782016	2	10	70	1590	1442	0	5104177	5000000	5999999
7	924495	1	10	75	1972	0	0	6031704	6000000	6999999
8	1775075	1	10	90	1577	0	0	7808751	7000000	7999999
9	1144837	1	10	55	1638	0	0	8955165	8000000	8999999
10	149417	2	10	85	1109	1319	0	9106220	9000000	9999999
11	1528117	2	10	55	1915	1085	0	10636765	10000000	10999999
12	476038	1	10	85	1311	0	0	11115803	11000000	11999999

Total number of pulses in waveform = 18

Type 5 Radar Waveform_4

Num of Bursts = 10
Burst Interval (us)= 1200000

Burst #	Off Time (us)	# Pulses	Chirp (MHz)	PW (us)	Pulse 1 Pri (us)	Pulse 2 Pri (us)	Pulse 3 Pri (us)	Start Loc (us)	Start Burst Interval (us)	End Burst Interval (us)
1	564625	1	12	95	1756	0	0	564625	0	1199999
2	1092181	2	12	85	1845	1972	0	1658562	1200000	2399999
3	1458691	2	12	50	1582	1810	0	3121070	2400000	3599999
4	1312194	3	12	55	1197	1008	1747	4436656	3600000	4799999
5	1477263	1	12	80	1662	0	0	5917871	4800000	5999999
6	759010	1	12	85	1298	0	0	6678543	6000000	7199999
7	1548329	1	12	95	1470	0	0	8228170	7200000	8399999
8	687698	3	12	60	1629	1834	1783	8917338	8400000	9599999
9	1078794	2	12	55	1578	1744	0	10001378	9600000	10799999
10	1046092	1	12	60	1723	0	0	11050792	10800000	11999999

Total number of pulses in waveform = 17



Type 5 Radar Waveform_5

Num of Bursts = 13
Burst Interval (us)= 923077

Burst #	Off Time (us)	# Pulses	Chirp (MHz)	PW (us)	Pulse 1 Pri (us)	Pulse 2 Pri (us)	Pulse 3 Pri (us)	Start Loc (us)	Start Burst Interval (us)	End Burst Interval (us)
1	221935	2	9	55	1661	1178	0	221935	0	923076
2	716518	1	9	70	1747	0	0	941292	923077	1846153
3	1663344	3	9	85	1081	1161	1621	2606383	1846154	2769230
4	1034013	2	9	50	1096	1427	0	3644259	2769231	3692307
5	950694	1	9	100	1732	0	0	4697476	3692308	4615384
6	593813	1	9	50	1769	0	0	5193021	4615385	5538461
7	896247	1	9	85	1676	0	0	6091037	5538462	6461538
8	1205650	3	9	95	1129	1836	1887	7298363	6461539	7384615
9	305462	1	9	100	1745	0	0	7608677	7384616	8307692
10	1326692	3	9	60	1946	1742	1858	8937114	8307693	9230769
11	993082	2	9	90	1978	1052	0	9935742	9230770	10153846
12	1128577	1	9	50	1344	0	0	11067349	10153847	11076923
13	267334	1	9	75	1000	0	0	11336027	11076924	12000000

Total number of pulses in waveform = 22

Type 5 Radar Waveform_6

Num of Bursts = 13
Burst Interval (us)= 923077

Burst #	Off Time (us)	# Pulses	Chirp (MHz)	PW (us)	Pulse 1 Pri (us)	Pulse 2 Pri (us)	Pulse 3 Pri (us)	Start Loc (us)	Start Burst Interval (us)	End Burst Interval (us)
1	361875	2	6	80	1303	1939	0	361875	0	923076
2	1289722	3	6	60	1405	1302	1676	1654839	923077	1846153
3	686624	2	6	95	1696	1607	0	2345846	1846154	2769230
4	510795	3	6	65	1391	1551	1491	2859944	2769231	3692307
5	892955	3	6	55	1135	1786	1446	3757332	3692308	4615384
6	1659685	1	6	80	1701	0	0	5421384	4615385	5538461
7	782041	1	6	50	1090	0	0	6205126	5538462	6461538
8	837529	3	6	60	1828	1086	1849	7043745	6461539	7384615
9	1070283	1	6	80	1137	0	0	8118791	7384616	8307692
10	188548	3	6	80	1159	1168	1123	8308476	8307693	9230769
11	1334915	1	6	80	1606	0	0	9646841	9230770	10153846
12	756414	2	6	75	1268	1939	0	10404861	10153847	11076923
13	996116	3	6	50	1447	1851	1061	11404184	11076924	12000000

Total number of pulses in waveform = 28

Type 5 Radar Waveform_7

Num of Bursts = 10
Burst Interval (us)= 1200000

Burst #	Off Time (us)	# Pulses	Chirp (MHz)	PW (us)	Pulse 1 Pri (us)	Pulse 2 Pri (us)	Pulse 3 Pri (us)	Start Loc (us)	Start Burst Interval (us)	End Burst Interval (us)
1	737115	1	17	85	1595	0	0	737115	0	1199999
2	968269	2	17	65	1547	1829	0	1706979	1200000	2399999
3	1322166	1	17	80	1443	0	0	3032521	2400000	3599999
4	1425071	1	17	50	1537	0	0	4459035	3600000	4799999
5	581652	2	17	75	1054	1104	0	5042224	4800000	5999999
6	1744219	3	17	70	1994	1511	1187	6788601	6000000	7199999
7	1467105	1	17	90	1381	0	0	8260398	7200000	8399999
8	713657	1	17	50	1491	0	0	8975436	8400000	9599999
9	717217	2	17	55	1109	1553	0	9694144	9600000	10799999
10	1104115	2	17	80	1689	1426	0	10800921	10800000	11999999

Total number of pulses in waveform = 16



Type 5 Radar Waveform_8

Num of Bursts = 20
Burst Interval (us) = 600000

Burst #	Off Time (us)	# Pulses	Chirp (MHz)	PW (us)	Pulse 1 Pri (us)	Pulse 2 Pri (us)	Pulse 3 Pri (us)	Start Loc (us)	Start Burst Interval (us)	End Burst Interval (us)
1	173531	1	5	65	1307	0	0	173531	0	599999
2	603616	2	5	70	1979	1952	0	778454	600000	1199999
3	421253	1	5	55	1636	0	0	1203638	1200000	1799999
4	1071826	3	5	85	1160	1940	1051	2277100	1800000	2399999
5	351578	3	5	60	1116	1783	1699	2632829	2400000	2999999
6	864670	2	5	95	1891	1525	0	3502097	3000000	3599999
7	647791	1	5	85	2000	0	0	4153304	3600000	4199999
8	93705	3	5	50	1686	1025	1741	4249009	4200000	4799999
9	992094	2	5	90	1528	1438	0	5245555	4800000	5399999
10	745709	1	5	100	1921	0	0	5994230	5400000	5999999
11	368227	1	5	85	1454	0	0	6364378	6000000	6599999
12	623962	3	5	90	1646	1481	1430	6989794	6600000	7199999
13	662452	2	5	95	1436	1959	0	7656803	7200000	7799999
14	568242	2	5	95	1264	1537	0	8228440	7800000	8399999
15	382907	3	5	85	1975	1130	1641	8614148	8400000	8999999
16	896036	3	5	90	1331	1845	1705	9514930	9000000	9599999
17	145796	2	5	55	1019	1881	0	9665607	9600000	10199999
18	1082101	3	5	60	1663	1264	1888	10750608	10200000	10799999
19	396940	2	5	70	1106	1911	0	11152363	10800000	11399999
20	529840	1	5	65	1313	0	0	11685220	11400000	11999999

Total number of pulses in waveform = 41

Type 5 Radar Waveform_9

Num of Bursts = 9
Burst Interval (us) = 1333333

Burst #	Off Time (us)	# Pulses	Chirp (MHz)	PW (us)	Pulse 1 Pri (us)	Pulse 2 Pri (us)	Pulse 3 Pri (us)	Start Loc (us)	Start Burst Interval (us)	End Burst Interval (us)
1	845211	1	8	90	1555	0	0	845211	0	1333332
2	1613289	3	8	70	1371	1335	1784	2460055	1333333	2666665
3	616424	1	8	50	1673	0	0	3080969	2666666	3999998
4	1677946	2	8	50	1026	1344	0	4760588	3999999	5333331
5	1554368	3	8	55	1419	1128	1716	6317326	5333332	6666664
6	583606	2	8	95	1319	1670	0	6905195	6666665	7999997
7	1378502	2	8	50	1562	1111	0	8286886	7999998	9333330
8	1240559	3	8	100	1745	1307	1265	9529918	9333331	10666663
9	1449121	1	8	100	1879	0	0	10983356	10666664	11999996

Total number of pulses in waveform = 18

Type 5 Radar Waveform_10

Num of Bursts = 10
Burst Interval (us) = 1200000

Burst #	Off Time (us)	# Pulses	Chirp (MHz)	PW (us)	Pulse 1 Pri (us)	Pulse 2 Pri (us)	Pulse 3 Pri (us)	Start Loc (us)	Start Burst Interval (us)	End Burst Interval (us)
1	111479	1	19	65	1570	0	0	111479	0	1199999
2	1380067	1	19	95	1370	0	0	1493116	1200000	2399999
3	1758022	3	19	85	1268	1175	1473	3252508	2400000	3599999
4	1196508	1	19	55	1986	0	0	4452932	3600000	4799999
5	1270212	2	19	65	1800	1454	0	5725130	4800000	5999999
6	1253145	1	19	55	1542	0	0	6981529	6000000	7199999
7	785945	3	19	95	1157	1020	1964	7769016	7200000	8399999
8	862361	1	19	95	1193	0	0	8635518	8400000	9599999
9	1984222	2	19	70	1415	1611	0	10620933	9600000	10799999
10	239779	2	19	55	1506	1336	0	10863738	10800000	11999999

Total number of pulses in waveform = 17



Type 5 Radar Waveform_11

Num of Bursts = 13
Burst Interval (us)= 923077

Burst #	Off Time (us)	# Pulses	Chirp (MHz)	PW (us)	Pulse 1 Pri (us)	Pulse 2 Pri (us)	Pulse 3 Pri (us)	Start Loc (us)	Start Burst Interval (us)	End Burst Interval (us)
1	280866	2	17	95	1537	1291	0	280866	0	923076
2	885348	3	17	95	1583	1338	1980	1169042	923077	1846153
3	900986	3	17	90	1513	1488	1518	2074929	1846154	2769230
4	733316	2	17	95	1720	1601	0	2812764	2769231	3692307
5	1536691	3	17	100	1645	1314	1817	4352776	3692308	4615384
6	655087	3	17	60	1995	1727	1005	5012639	4615385	5538461
7	675927	1	17	55	1308	0	0	5693293	5538462	6461538
8	1362151	2	17	90	1084	1777	0	7056752	6461539	7384615
9	931732	3	17	70	1403	1607	1668	7991345	7384616	8307692
10	619648	2	17	70	1205	1720	0	8615671	8307693	9230769
11	1095750	3	17	55	1778	1464	1103	9714346	9230770	10153846
12	538830	3	17	85	1029	1566	1528	10257521	10153847	11076923
13	1546128	2	17	100	1486	1765	0	11807772	11076924	12000000

Total number of pulses in waveform = 32

Type 5 Radar Waveform_12

Num of Bursts = 19
Burst Interval (us)= 631579

Burst #	Off Time (us)	# Pulses	Chirp (MHz)	PW (us)	Pulse 1 Pri (us)	Pulse 2 Pri (us)	Pulse 3 Pri (us)	Start Loc (us)	Start Burst Interval (us)	End Burst Interval (us)
1	16549	2	18	85	1887	1427	0	16549	0	631578
2	1001009	1	18	80	1616	0	0	1020872	631579	1263157
3	384108	1	18	95	1229	0	0	1406596	1263158	1894736
4	509353	2	18	85	1166	1339	0	1917178	1894737	2526315
5	980027	3	18	90	1422	1660	1683	2899710	2526316	3157894
6	838711	2	18	90	1460	1323	0	3743186	3157895	3789473
7	652449	2	18	60	1529	1108	0	4398418	3789474	4421052
8	613123	1	18	75	1095	0	0	5014178	4421053	5052631
9	192544	1	18	55	1528	0	0	5207818	5052632	5684210
10	791437	3	18	65	1619	1687	1689	6000783	5684211	6315789
11	919146	1	18	80	1047	0	0	6924924	6315790	6947368
12	301598	2	18	95	1516	1173	0	7227569	6947369	7578947
13	452190	1	18	85	1870	0	0	7682448	7578948	8210526
14	572321	3	18	80	1300	1561	1627	8256639	8210527	8842105
15	918339	1	18	65	1043	0	0	9179466	8842106	9473684
16	425396	2	18	85	1574	1178	0	9605905	9473685	10105263
17	1042684	3	18	70	1132	1542	1876	10651341	10105264	10736842
18	425933	3	18	70	1316	1516	1437	11081824	10736843	11368421
19	331956	1	18	50	1008	0	0	11418049	11368422	12000000

Total number of pulses in waveform = 35

Type 5 Radar Waveform_13

Num of Bursts = 18
Burst Interval (us)= 666667

Burst #	Off Time (us)	# Pulses	Chirp (MHz)	PW (us)	Pulse 1 Pri (us)	Pulse 2 Pri (us)	Pulse 3 Pri (us)	Start Loc (us)	Start Burst Interval (us)	End Burst Interval (us)
1	66690	2	5	95	1641	1179	0	66690	0	666666
2	927359	3	5	95	1248	1202	1364	997069	666667	1333333
3	593849	1	5	50	1048	0	0	1594732	1333334	2000000
4	956770	1	5	80	1044	0	0	2552550	2000001	2666667
5	294117	1	5	80	1070	0	0	2847711	2666668	3333334
6	769614	1	5	50	1679	0	0	3618395	3333335	4000001
7	707391	1	5	70	1792	0	0	4327465	4000002	4666668
8	576671	1	5	90	1019	0	0	4905928	4666669	5333335
9	563655	2	5	90	1286	1996	0	5470602	5333336	6000002
10	956288	2	5	75	1553	1418	0	6430172	6000003	6666669
11	555934	3	5	70	1713	1058	1739	6989077	6666670	7333336
12	441419	1	5	60	1251	0	0	7435006	7333337	8000003
13	839754	1	5	50	1960	0	0	8276011	8000004	8666670
14	625657	1	5	50	1319	0	0	8903628	8666671	9333337
15	583745	2	5	65	1662	1948	0	9488692	9333338	10000004
16	904721	2	5	95	1566	1594	0	10397023	10000005	10666671
17	774715	1	5	95	1535	0	0	11174898	10666672	11333338
18	546626	1	5	90	1492	0	0	11723059	11333339	12000005

Total number of pulses in waveform = 27



Type 5 Radar Waveform_14

Num of Bursts = 16
Burst Interval (us) = 750000

Burst #	Off Time (us)	# Pulses	Chirp (MHz)	PW (us)	Pulse 1 Pri (us)	Pulse 2 Pri (us)	Pulse 3 Pri (us)	Start Loc (us)	Start Burst Interval (us)	End Burst Interval (us)
1	744505	3	12	50	1389	1501	1051	744505	0	749999
2	342726	1	12	65	1898	0	0	1091152	750000	1499999
3	1062713	3	12	65	1492	1279	1029	2155763	1500000	2249999
4	343532	3	12	100	1188	1007	1705	2503095	2250000	2999999
5	979666	3	12	55	1986	1018	1020	3486661	3000000	3749999
6	386413	1	12	50	1660	0	0	3877098	3750000	4499999
7	951910	3	12	85	1917	1361	1332	4830668	4500000	5249999
8	639146	1	12	55	1210	0	0	5474424	5250000	5999999
9	1224012	3	12	75	1667	1316	1609	6699646	6000000	6749999
10	106851	2	12	100	1405	1255	0	6811089	6750000	7499999
11	1264477	1	12	70	1305	0	0	8078236	7500000	8249999
12	242044	3	12	55	1610	1550	1837	8321585	8250000	8999999
13	688416	2	12	70	1560	1314	0	9014998	9000000	9749999
14	924398	1	12	100	1127	0	0	9942270	9750000	10499999
15	682575	1	12	95	1843	0	0	10625972	10500000	11249999
16	922060	1	12	50	1842	0	0	11549875	11250000	11999999

Total number of pulses in waveform = 32

Type 5 Radar Waveform_15

Num of Bursts = 17
Burst Interval (us) = 705882

Burst #	Off Time (us)	# Pulses	Chirp (MHz)	PW (us)	Pulse 1 Pri (us)	Pulse 2 Pri (us)	Pulse 3 Pri (us)	Start Loc (us)	Start Burst Interval (us)	End Burst Interval (us)
1	224962	1	9	75	1668	0	0	224962	0	705881
2	1017732	2	9	65	1886	1222	0	1244262	705882	1411763
3	794106	1	9	70	1192	0	0	2041476	1411764	2117645
4	458824	3	9	100	1612	1034	1660	2501492	2117646	2823527
5	839890	1	9	65	1252	0	0	3345688	2823528	3529409
6	446437	3	9	65	1852	1244	1999	3793377	3529410	4235291
7	1003202	1	9	90	1508	0	0	4801674	4235292	4941173
8	216316	1	9	100	1008	0	0	5019498	4941174	5647055
9	701093	1	9	90	1876	0	0	5721599	5647056	6352937
10	827817	1	9	90	1736	0	0	6551292	6352938	7058819
11	736149	1	9	70	1730	0	0	7289177	7058820	7764701
12	801304	1	9	50	1021	0	0	8092211	7764702	8470583
13	407615	1	9	50	1653	0	0	8500847	8470584	9176465
14	870549	3	9	60	1230	1728	1310	9373049	9176466	9882347
15	781619	2	9	65	1985	1219	0	10158936	9882348	10588229
16	894528	3	9	65	1783	1052	1082	11056668	10588230	11294111
17	279439	1	9	95	1222	0	0	11340024	11294112	11999993

Total number of pulses in waveform = 27

Type 5 Radar Waveform_16

Num of Bursts = 12
Burst Interval (us) = 1000000

Burst #	Off Time (us)	# Pulses	Chirp (MHz)	PW (us)	Pulse 1 Pri (us)	Pulse 2 Pri (us)	Pulse 3 Pri (us)	Start Loc (us)	Start Burst Interval (us)	End Burst Interval (us)
1	721952	2	6	100	1088	1778	0	721952	0	999999
2	459161	1	6	80	1050	0	0	1183979	1000000	1999999
3	1222827	2	6	95	1458	1079	0	2407856	2000000	2999999
4	1153407	3	6	90	1304	1244	1175	3563800	3000000	3999999
5	560616	2	6	95	1290	1993	0	4128139	4000000	4999999
6	890885	1	6	95	1847	0	0	5022307	5000000	5999999
7	1785142	3	6	90	1231	1850	1331	6809296	6000000	6999999
8	268467	3	6	55	1878	1355	1288	7082175	7000000	7999999
9	1434572	3	6	70	1691	1470	1344	8521268	8000000	8999999
10	1326746	1	6	75	1842	0	0	9852519	9000000	9999999
11	204531	3	6	95	1407	1529	1291	10058892	10000000	10999999
12	1834969	1	6	95	1405	0	0	11898088	11000000	11999999

Total number of pulses in waveform = 25



Type 5 Radar Waveform_17

Num of Bursts = 20
Burst Interval (us) = 600000

Burst #	Off Time (us)	# Pulses	Chirp (MHz)	PW (us)	Pulse 1 Pri (us)	Pulse 2 Pri (us)	Pulse 3 Pri (us)	Start Loc (us)	Start Burst Interval (us)	End Burst Interval (us)
1	277222	1	S	80	1384	0	0	277222	0	599999
2	564885	1	S	55	1122	0	0	843491	600000	1199999
3	463920	3	S	70	1974	1876	1428	1308533	1200000	1799999
4	892858	1	S	65	1404	0	0	2206669	1800000	2399999
5	641267	1	S	50	1459	0	0	2849340	2400000	2999999
6	465547	2	S	50	1560	1677	0	3316346	3000000	3599999
7	686640	3	S	65	1251	1118	1033	4006223	3600000	4199999
8	763804	3	S	85	1118	1183	1649	4773429	4200000	4799999
9	374384	3	S	90	1432	1119	1275	5151763	4800000	5399999
10	527456	3	S	100	1449	1110	1485	5683045	5400000	5999999
11	711976	2	S	60	1439	1189	0	6399065	6000000	6599999
12	582083	3	S	75	1825	1159	1748	6983776	6600000	7199999
13	520807	2	S	90	1966	1373	0	7509315	7200000	7799999
14	395430	1	S	90	1287	0	0	7908084	7800000	8399999
15	701334	2	S	60	1503	1562	0	8610705	8400000	8999999
16	679251	1	S	50	1233	0	0	9293021	9000000	9599999
17	825488	2	S	95	1705	1851	0	10119742	9600000	10199999
18	335516	1	S	90	1455	0	0	10458814	10200000	10799999
19	603358	2	S	75	1514	1260	0	11063627	10800000	11399999
20	568049	1	S	55	1275	0	0	11634450	11400000	11999999

Total number of pulses in waveform = 38

Type 5 Radar Waveform_18

Num of Bursts = 11
Burst Interval (us) = 1090909

Burst #	Off Time (us)	# Pulses	Chirp (MHz)	PW (us)	Pulse 1 Pri (us)	Pulse 2 Pri (us)	Pulse 3 Pri (us)	Start Loc (us)	Start Burst Interval (us)	End Burst Interval (us)
1	367224	3	19	70	1283	1822	1087	367224	0	1090908
2	1504897	2	19	100	1947	1898	0	1876313	1090909	2181817
3	1215272	2	19	95	1691	1157	0	3095430	2181818	3272726
4	274096	2	19	65	1670	1544	0	3372374	3272727	4363635
5	1122143	2	19	75	1678	1254	0	4497731	4363636	5454544
6	1399644	2	19	80	1424	1317	0	5900307	5454545	6545453
7	1020342	1	19	85	1105	0	0	6923390	6545454	7636362
8	1238069	2	19	70	1956	1935	0	8162564	7636363	8727271
9	1079846	2	19	80	1495	1939	0	9246301	8727272	9818180
10	575477	3	19	75	1712	1652	1126	9825212	9818181	10909089
11	2159574	3	19	75	1517	1561	1983	11989276	10909090	11999998

Total number of pulses in waveform = 24

Type 5 Radar Waveform_19

Num of Bursts = 13
Burst Interval (us) = 923077

Burst #	Off Time (us)	# Pulses	Chirp (MHz)	PW (us)	Pulse 1 Pri (us)	Pulse 2 Pri (us)	Pulse 3 Pri (us)	Start Loc (us)	Start Burst Interval (us)	End Burst Interval (us)
1	417801	2	10	55	1613	1402	0	417801	0	923076
2	503966	2	10	90	1790	1107	0	924782	923077	1846153
3	979322	3	10	70	1341	1254	1535	1907001	1846154	2769230
4	1185851	1	10	100	1865	0	0	3096982	2769231	3692307
5	826267	2	10	85	1246	1235	0	3925114	3692308	4615384
6	1133242	3	10	50	1153	1019	1755	5060837	4615385	5538461
7	1262202	3	10	50	1676	1297	1203	6326966	5538462	6461538
8	807902	3	10	90	1892	1956	1371	7139044	6461539	7384615
9	1024979	2	10	55	1142	1385	0	8169242	7384616	8307692
10	279189	1	10	85	1570	0	0	8450958	8307693	9230769
11	985992	1	10	55	1521	0	0	9438520	9230770	10153846
12	1145941	1	10	65	1414	0	0	10585982	10153847	11076923
13	648342	3	10	100	1887	1454	1176	11235738	11076924	12000000

Total number of pulses in waveform = 27



Type 5 Radar Waveform_20

Num of Bursts = 20
Burst Interval (us)= 600000

Burst #	Off Time (us)	# Pulses	Chirp (MHz)	PW (us)	Pulse 1 Pri (us)	Pulse 2 Pri (us)	Pulse 3 Pri (us)	Start Loc (us)	Start Burst Interval (us)	End Burst Interval (us)
1	338072	2	14	90	1071	1768	0	338072	0	599999
2	537406	1	14	100	1167	0	0	878317	600000	1199999
3	861392	2	14	90	1348	1848	0	1740876	1200000	1799999
4	192968	2	14	80	1126	1689	0	1937040	1800000	2399999
5	815118	3	14	100	1340	1712	1553	2754973	2400000	2999999
6	350065	2	14	95	1742	1389	0	3109643	3000000	3599999
7	868201	3	14	75	1890	1714	1782	3980975	3600000	4199999
8	574798	3	14	80	1295	1737	1055	4561159	4200000	4799999
9	586710	1	14	55	1815	0	0	5151956	4800000	5399999
10	775416	2	14	85	1981	1861	0	5929187	5400000	5999999
11	572405	1	14	70	1684	0	0	6505434	6000000	6599999
12	253466	1	14	90	1701	0	0	6760584	6600000	7199999
13	611086	2	14	50	1223	1263	0	7373371	7200000	7799999
14	700682	1	14	55	1039	0	0	8076539	7800000	8399999
15	681453	1	14	85	1473	0	0	8759031	8400000	8999999
16	513338	2	14	75	1481	1682	0	9273842	9000000	9599999
17	705897	2	14	65	1706	1711	0	9982902	9600000	10199999
18	739454	3	14	85	1884	1848	1593	10725773	10200000	10799999
19	292235	1	14	85	1110	0	0	11023333	10800000	11399999
20	491712	3	14	55	1057	1983	1963	11516155	11400000	11999999

Total number of pulses in waveform = 38

Type 5 Radar Waveform_21

Num of Bursts = 9
Burst Interval (us)= 1333333

Burst #	Off Time (us)	# Pulses	Chirp (MHz)	PW (us)	Pulse 1 Pri (us)	Pulse 2 Pri (us)	Pulse 3 Pri (us)	Start Loc (us)	Start Burst Interval (us)	End Burst Interval (us)
1	854275	1	12	90	1274	0	0	854275	0	1333332
2	726033	2	12	80	1673	1919	0	1581582	1333333	2666665
3	1689460	1	12	70	1281	0	0	3274634	2666666	3999998
4	1260437	3	12	85	1263	1503	1430	4536352	3999999	5333331
5	1955872	1	12	60	1583	0	0	6496420	5333332	6666664
6	1032129	2	12	95	1871	1180	0	7530132	6666665	7999997
7	581561	3	12	55	1722	1301	1139	8114744	7999998	9333330
8	2243863	1	12	95	1955	0	0	10362769	9333331	10666663
9	393303	3	12	60	1478	1630	1106	10758027	10666664	11999996

Total number of pulses in waveform = 17

Type 5 Radar Waveform_22

Num of Bursts = 11
Burst Interval (us)= 1090909

Burst #	Off Time (us)	# Pulses	Chirp (MHz)	PW (us)	Pulse 1 Pri (us)	Pulse 2 Pri (us)	Pulse 3 Pri (us)	Start Loc (us)	Start Burst Interval (us)	End Burst Interval (us)
1	647565	3	9	95	1443	2000	1267	647565	0	1090908
2	697775	2	9	85	1171	1715	0	1350050	1090909	2181817
3	862904	3	9	85	1612	1500	1433	2216840	2181818	3272726
4	2124169	2	9	70	1336	1249	0	4344554	3272727	4363635
5	185323	1	9	70	1325	0	0	4532462	4363636	5454544
6	1750391	1	9	55	1210	0	0	6284178	5454545	6545453
7	1054755	1	9	75	1034	0	0	7340143	6545454	7636362
8	1333432	3	9	70	1666	1752	1193	8674609	7636363	8727271
9	943964	3	9	60	1716	1612	1143	9623184	8727272	9818180
10	458134	1	9	100	1797	0	0	10085789	9818181	10909089
11	995585	2	9	90	1212	1489	0	11083171	10909090	11999998

Total number of pulses in waveform = 22



Type 5 Radar Waveform_23

Num of Bursts = 11
Burst Interval (us)= 1090909

Burst #	Off Time (us)	# Pulses	Chirp (MHz)	PW (us)	Pulse 1 Pri (us)	Pulse 2 Pri (us)	Pulse 3 Pri (us)	Start Loc (us)	Start Burst Interval (us)	End Burst Interval (us)
1	845816	2	5	95	1090	1652	0	845816	0	1090908
2	1113682	3	5	95	1146	1218	1259	1962240	1090909	2181817
3	786711	3	5	55	1092	1790	1624	2752574	2181818	3272726
4	1364154	1	5	50	1765	0	0	4121234	3272727	4363635
5	248435	1	5	50	1439	0	0	4371434	4363636	5454544
6	1869842	3	5	90	1349	1419	1721	6242715	5454545	6545453
7	1110654	3	5	60	1770	1387	1441	7357858	6545454	7636362
8	1106439	3	5	75	1950	1105	1079	8468895	7636363	8727271
9	707463	1	5	95	1736	0	0	9180492	8727272	9818180
10	920045	3	5	55	1902	1507	1854	10102273	9818181	10909089
11	1762012	3	5	85	1451	1219	1441	11869548	10909090	11999998

Total number of pulses in waveform = 26

Type 5 Radar Waveform_24

Num of Bursts = 11
Burst Interval (us)= 1090909

Burst #	Off Time (us)	# Pulses	Chirp (MHz)	PW (us)	Pulse 1 Pri (us)	Pulse 2 Pri (us)	Pulse 3 Pri (us)	Start Loc (us)	Start Burst Interval (us)	End Burst Interval (us)
1	509844	1	10	60	1795	0	0	509844	0	1090908
2	1447352	3	10	100	1942	1140	1438	1958991	1090909	2181817
3	669824	1	10	50	1004	0	0	2633335	2181818	3272726
4	1225075	1	10	55	1997	0	0	3859414	3272727	4363635
5	931447	1	10	65	1210	0	0	4792858	4363636	5454544
6	1731188	2	10	55	1960	1252	0	6525256	5454545	6545453
7	86716	2	10	65	1742	1127	0	6615184	6545454	7636362
8	2071893	3	10	65	1670	1176	1794	8689946	7636363	8727271
9	356920	1	10	100	1020	0	0	9051506	8727272	9818180
10	1832740	1	10	85	1203	0	0	10685266	9818181	10909089
11	295159	3	10	55	1427	1151	1565	11181628	10909090	11999998

Total number of pulses in waveform = 19

Type 5 Radar Waveform_25

Num of Bursts = 18
Burst Interval (us)= 666667

Burst #	Off Time (us)	# Pulses	Chirp (MHz)	PW (us)	Pulse 1 Pri (us)	Pulse 2 Pri (us)	Pulse 3 Pri (us)	Start Loc (us)	Start Burst Interval (us)	End Burst Interval (us)
1	5511	1	14	60	1257	0	0	5511	0	666666
2	1049358	1	14	65	1623	0	0	1056126	666667	1333333
3	575154	1	14	80	1037	0	0	1632903	1333334	2000000
4	752717	3	14	95	1822	1744	1903	2386657	2000001	2666667
5	382202	1	14	65	1868	0	0	2774328	2666668	3333334
6	1037904	3	14	90	1401	1690	1751	3814100	3333335	4000001
7	387888	2	14	75	1879	1350	0	4206830	4000002	4666668
8	648168	3	14	95	1190	1178	1414	4858227	4666669	5333335
9	602299	2	14	75	1282	1481	0	5554308	5333336	6000002
10	607545	2	14	100	1330	1652	0	6164616	6000003	6666669
11	1055020	1	14	95	1757	0	0	7222618	6666670	7333336
12	115549	3	14	65	1240	1345	1461	7339924	7333337	8000003
13	1231864	1	14	65	1592	0	0	8575834	8000004	8666670
14	165840	3	14	85	1456	1463	1558	8743266	8666671	9333337
15	1237387	2	14	95	1354	1806	0	9985130	9333338	10000004
16	528771	3	14	70	1386	1273	1263	10517061	10000005	10666671
17	381673	2	14	65	1685	1529	0	10902656	10666672	11333338
18	557823	3	14	95	1721	1793	1320	11463693	11333339	12000005

Total number of pulses in waveform = 37



Type 5 Radar Waveform_26

Num of Bursts = 13
Burst Interval (us)= 923077

Burst #	Off Time (us)	# Pulses	Chirp (MHz)	PW (us)	Pulse 1 Pri (us)	Pulse 2 Pri (us)	Pulse 3 Pri (us)	Start Loc (us)	Start Burst Interval (us)	End Burst Interval (us)
1	880709	2	6	50	1429	1083	0	880709	0	923076
2	674985	2	6	100	1439	1926	0	1558206	923077	1846153
3	309922	3	6	70	1599	1346	1602	1871493	1846154	2769230
4	901632	1	6	80	1957	0	0	2777672	2769231	3692307
5	1007290	2	6	100	1349	1763	0	3786919	3692308	4615384
6	1231301	1	6	60	1602	0	0	5021332	4615385	5538461
7	1334730	2	6	90	1879	1389	0	6357664	5538462	6461538
8	193793	3	6	60	1663	1478	1673	6554725	6461539	7384615
9	1702098	3	6	95	1137	1165	1094	8261637	7384616	8307692
10	275071	2	6	65	1536	1217	0	8540104	8307693	9230769
11	872104	2	6	70	1881	1271	0	9414961	9230770	10153846
12	900300	1	6	55	1108	0	0	10318413	10153847	11076923
13	1151050	1	6	95	1248	0	0	11470571	11076924	12000000

Total number of pulses in waveform = 25

Type 5 Radar Waveform_27

Num of Bursts = 9
Burst Interval (us)= 1333333

Burst #	Off Time (us)	# Pulses	Chirp (MHz)	PW (us)	Pulse 1 Pri (us)	Pulse 2 Pri (us)	Pulse 3 Pri (us)	Start Loc (us)	Start Burst Interval (us)	End Burst Interval (us)
1	993790	3	8	55	1231	1500	1605	993790	0	1333332
2	1102894	2	8	90	1094	1304	0	2101020	1333333	2666665
3	1285228	3	8	80	1226	1112	1919	3388646	2666666	3999998
4	1408871	1	8	65	1794	0	0	4801774	3999999	5333331
5	939520	1	8	70	1485	0	0	5743088	5333332	6666664
6	1007853	1	8	95	1137	0	0	6752426	6666665	7999997
7	1473730	2	8	85	1317	1330	0	8227293	7999998	9333330
8	1834236	3	8	70	1082	1614	1957	10064176	9333331	10666663
9	1648977	2	8	90	1318	1172	0	11717806	10666664	11999996

Total number of pulses in waveform = 18

Type 5 Radar Waveform_28

Num of Bursts = 11
Burst Interval (us)= 1090909

Burst #	Off Time (us)	# Pulses	Chirp (MHz)	PW (us)	Pulse 1 Pri (us)	Pulse 2 Pri (us)	Pulse 3 Pri (us)	Start Loc (us)	Start Burst Interval (us)	End Burst Interval (us)
1	538159	1	19	90	1205	0	0	538159	0	1090908
2	707117	3	19	70	1901	1546	1752	1246481	1090909	2181817
3	1984431	2	19	100	1831	1666	0	3236111	2181818	3272726
4	831508	3	19	90	1090	1324	1559	4071116	3272727	4363635
5	733279	2	19	100	1744	1880	0	4808368	4363636	5454544
6	1150510	2	19	75	1385	1637	0	5962502	5454545	6545453
7	1652453	1	19	75	1414	0	0	7617977	6545454	7636362
8	497825	2	19	75	1669	1559	0	8117216	7636363	8727271
9	1052769	3	19	100	1437	1671	1740	9173213	8727272	9818180
10	1242341	1	19	75	1300	0	0	10420402	9818181	10909089
11	1492159	1	19	80	1395	0	0	11913861	10909090	11999998

Total number of pulses in waveform = 21



Type 5 Radar Waveform_29

Num of Bursts = 20
Burst Interval (us) = 600000

Burst #	Off Time (us)	# Pulses	Chirp (MHz)	PW (us)	Pulse 1 Pri (us)	Pulse 2 Pri (us)	Pulse 3 Pri (us)	Start Loc (us)	Start Burst Interval (us)	End Burst Interval (us)
1	512038	3	18	55	1251	1254	1716	512038	0	599999
2	452891	1	18	80	1829	0	0	969150	600000	1199999
3	657650	1	18	70	1802	0	0	1628629	1200000	1799999
4	193456	3	18	95	1721	1154	1033	1823887	1800000	2399999
5	772284	2	18	75	1821	1213	0	2600079	2400000	2999999
6	578221	1	18	55	1961	0	0	3181334	3000000	3599999
7	917515	3	18	85	1097	1193	1028	4100810	3600000	4199999
8	266375	2	18	50	1082	1851	0	4370503	4200000	4799999
9	710288	1	18	70	1462	0	0	5083724	4800000	5399999
10	634412	2	18	60	1543	1711	0	5719598	5400000	5999999
11	462052	1	18	55	1698	0	0	6184904	6000000	6599999
12	573590	2	18	55	1931	1144	0	6760192	6600000	7199999
13	612901	2	18	60	1482	1041	0	7376168	7200000	7799999
14	778347	1	18	75	1213	0	0	8157038	7800000	8399999
15	740766	3	18	100	1682	1742	1852	8899017	8400000	8999999
16	329553	2	18	65	1806	1561	0	9233846	9000000	9599999
17	635171	2	18	85	1200	1853	0	9872384	9600000	10199999
18	576090	2	18	100	1139	1680	0	10451527	10200000	10799999
19	490604	1	18	50	1604	0	0	10944950	10800000	11399999
20	784723	1	18	70	1180	0	0	11731277	11400000	11999999

Total number of pulses in waveform = 36

Type 5 Radar Waveform_30

Num of Bursts = 10
Burst Interval (us) = 1200000

Burst #	Off Time (us)	# Pulses	Chirp (MHz)	PW (us)	Pulse 1 Pri (us)	Pulse 2 Pri (us)	Pulse 3 Pri (us)	Start Loc (us)	Start Burst Interval (us)	End Burst Interval (us)
1	337722	2	17	55	1333	1464	0	337722	0	1199999
2	1848874	3	17	95	1458	1244	1350	2189393	1200000	2399999
3	1188957	2	17	70	1630	1002	0	3382402	2400000	3599999
4	1174542	2	17	50	1018	1819	0	4559576	3600000	4799999
5	981272	1	17	50	1415	0	0	5543685	4800000	5999999
6	496310	3	17	65	1725	1554	1602	6041410	6000000	7199999
7	1196431	2	17	95	1245	1795	0	7242722	7200000	8399999
8	1853713	2	17	70	1035	1579	0	9099475	8400000	9599999
9	767462	1	17	90	1532	0	0	9869551	9600000	10799999
10	1719626	2	17	75	1604	1974	0	11590709	10800000	11999999

Total number of pulses in waveform = 20



Radar Type 6 - Radar Statistical Performance

Trail #	Test Freq. (MHz)	1=Detection 0=No Detection	Trail #	Test Freq. (MHz)	1=Detection 0=No Detection
1	5253	1	16	5298	1
2	5256	1	17	5301	1
3	5259	1	18	5304	1
4	5262	1	19	5307	1
5	5265	1	20	5310	1
6	5268	1	21	5313	1
7	5271	1	22	5316	1
8	5274	1	23	5319	1
9	5277	1	24	5322	1
10	5280	1	25	5325	1
11	5283	1	26	5328	1
12	5286	1	27	5271	1
13	5289	1	28	5290	1
14	5292	1	29	5311	1
15	5295	1	30	5327	1
Detection Percentage (%)					100%

Radar waveform #1			Radar waveform #2		
Hopping Number	Frequency (MHz)	Pulse Start (ms)	Hopping Number	Frequency (MHz)	Pulse Start (ms)
27	5267	81	6	5253	18
38	5270	114	9	5269	27
45	5255	135	10	5282	30
50	5271	150	11	5256	33
69	5250	207	17	5251	51
73	5256	219	61	5262	183
86	5254	258	81	5270	243
--	--	--	88	5272	264
--	--	--	91	5281	273

Radar waveform #3			Radar waveform #4		
Hopping Number	Frequency (MHz)	Pulse Start (ms)	Hopping Number	Frequency (MHz)	Pulse Start (ms)
0	5286	0	3	5256	9
24	5252	72	17	5268	51
25	5264	75	49	5275	147
44	5290	132	58	5258	174
48	5257	144	67	5278	201
52	5270	156	68	5257	204
61	5265	183	85	5276	255
66	5284	198	96	5262	288
85	5271	255	--	--	--
90	5278	270	--	--	--

Radar waveform #5			Radar waveform #6		
Hopping Number	Frequency (MHz)	Pulse Start (ms)	Hopping Number	Frequency (MHz)	Pulse Start (ms)
11	5258	33	4	5264	12
29	5274	87	14	5253	42
38	5286	114	36	5275	108
72	5251	216	37	5251	111
84	5270	252	41	5250	123
88	5291	264	43	5274	129
--	--	--	44	5298	132
--	--	--	47	5278	141
--	--	--	63	5276	189
--	--	--	71	5269	213
--	--	--	84	5258	252
--	--	--	90	5286	270

Radar waveform #7			Radar waveform #8		
Hopping Number	Frequency (MHz)	Pulse Start (ms)	Hopping Number	Frequency (MHz)	Pulse Start (ms)
12	5299	36	23	5264	69
27	5293	81	37	5278	111
30	5264	90	44	5251	132
33	5298	99	46	5281	138
39	5294	117	75	5262	225
43	5286	129	83	5294	249
44	5295	132	88	5274	264
50	5262	150	90	5279	270
58	5284	174	--	--	--
64	5255	192	--	--	--
71	5292	213	--	--	--
99	5275	297	--	--	--



Radar waveform #9			Radar waveform #10		
Hopping Number	Frequency (MHz)	Pulse Start (ms)	Hopping Number	Frequency (MHz)	Pulse Start (ms)
1	5275	3	16	5258	48
10	5270	30	18	5259	54
18	5255	54	27	5299	81
41	5261	123	29	5294	87
46	5300	138	33	5250	99
49	5260	147	41	5261	123
71	5277	213	54	5290	162
76	5287	228	62	5268	186
77	5272	231	71	5282	213
83	5269	249	77	5281	231
84	5274	252	85	5251	255
87	5289	261	--	--	--
88	5276	264	--	--	--

Radar waveform #11			Radar waveform #12		
Hopping Number	Frequency (MHz)	Pulse Start (ms)	Hopping Number	Frequency (MHz)	Pulse Start (ms)
2	5276	6	11	5256	33
9	5299	27	50	5298	150
17	5298	51	51	5257	153
18	5291	54	66	5274	198
25	5262	75	72	5262	216
36	5308	108	87	5279	261
37	5288	111	89	5302	267
43	5279	129	92	5303	276
44	5286	132	95	5291	285
50	5309	150	--	--	--
58	5258	174	--	--	--
93	5282	279	--	--	--
99	5294	297	--	--	--

Radar waveform #13			Radar waveform #14		
Hopping Number	Frequency (MHz)	Pulse Start (ms)	Hopping Number	Frequency (MHz)	Pulse Start (ms)
15	5260	45	2	5271	6
22	5279	66	8	5276	24
28	5311	84	10	5279	30
34	5276	102	17	5259	51
41	5261	123	25	5305	75
46	5292	138	36	5286	108
47	5288	141	38	5315	114
49	5297	147	61	5287	183
63	5265	189	63	5300	189
66	5301	198	68	5308	204
69	5289	207	85	5302	255
75	5259	225	96	5277	288
80	5284	240	--	--	--
82	5281	246	--	--	--
84	5293	252	--	--	--
85	5274	255	--	--	--
86	5309	258	--	--	--
89	5267	267	--	--	--
95	5273	285	--	--	--



Radar waveform #15			Radar waveform #16		
Hopping Number	Frequency (MHz)	Pulse Start (ms)	Hopping Number	Frequency (MHz)	Pulse Start (ms)
1	5266	3	0	5295	0
7	5267	21	16	5273	48
12	5269	36	17	5303	51
18	5309	54	20	5313	60
24	5264	72	34	5308	102
32	5310	96	39	5307	117
33	5315	99	75	5297	225
37	5290	111	77	5306	231
44	5288	132	89	5279	267
48	5301	144	95	5309	285
51	5308	153	--	--	--
52	5274	156	--	--	--
54	5299	162	--	--	--
74	5279	222	--	--	--
75	5275	225	--	--	--
76	5261	228	--	--	--
88	5304	264	--	--	--



Radar waveform #17			Radar waveform #18		
Hopping Number	Frequency (MHz)	Pulse Start (ms)	Hopping Number	Frequency (MHz)	Pulse Start (ms)
5	5264	15	2	5301	6
9	5321	27	3	5269	9
20	5296	60	5	5275	15
28	5275	84	16	5296	48
31	5302	93	18	5314	54
43	5291	129	19	5319	57
58	5318	174	31	5310	93
72	5298	216	42	5305	126
74	5288	222	54	5278	162
76	5311	228	55	5292	165
77	5303	231	63	5286	189
86	5284	258	76	5277	228
90	5262	270	87	5317	261
95	5292	285	93	5266	279
99	5312	297	95	5282	285

Radar waveform #19			Radar waveform #20		
Hopping Number	Frequency (MHz)	Pulse Start (ms)	Hopping Number	Frequency (MHz)	Pulse Start (ms)
4	5318	12	5	5292	15
16	5311	48	10	5275	30
47	5302	141	13	5330	39
50	5279	150	20	5309	60
51	5324	153	33	5308	99
58	5307	174	34	5279	102
59	5314	177	36	5314	108
63	5285	189	40	5327	120
74	5277	222	41	5276	123
75	5280	225	50	5318	150
78	5298	234	65	5270	195
81	5313	243	89	5326	267
88	5301	264	90	5317	270
89	5312	267	91	5278	273
91	5291	273	95	5291	285



Radar waveform #21			Radar waveform #22		
Hopping Number	Frequency (MHz)	Pulse Start (ms)	Hopping Number	Frequency (MHz)	Pulse Start (ms)
5	5289	15	0	5294	0
10	5284	30	10	5298	30
17	5317	51	21	5285	63
32	5302	96	38	5321	114
38	5296	114	59	5319	177
40	5337	120	60	5303	180
48	5301	144	71	5320	213
74	5281	222	--	--	--
90	5313	270	--	--	--

Radar waveform #23			Radar waveform #24		
Hopping Number	Frequency (MHz)	Pulse Start (ms)	Hopping Number	Frequency (MHz)	Pulse Start (ms)
0	5298	0	0	5323	0
7	5337	21	6	5292	18
10	5319	30	7	5337	21
16	5282	48	9	5286	27
35	5316	105	12	5326	36
36	5310	108	17	5308	51
37	5325	111	21	5284	63
38	5324	114	23	5318	69
39	5314	117	28	5296	84
49	5286	147	35	5288	105
72	5334	216	41	5281	123
75	5328	225	55	5310	165
90	5330	270	66	5327	198
97	5284	291	73	5304	219
--	--	--	77	5321	231
--	--	--	78	5330	234
--	--	--	95	5306	285
--	--	--	98	5311	294



Radar waveform #25			Radar waveform #26		
Hopping Number	Frequency (MHz)	Pulse Start (ms)	Hopping Number	Frequency (MHz)	Pulse Start (ms)
3	5324	9	14	5320	42
11	5340	33	19	5330	57
19	5286	57	20	5313	60
54	5323	162	22	5327	66
64	5336	192	24	5319	72
83	5339	249	34	5317	102
86	5303	258	39	5332	117
--	--	--	40	5328	120
--	--	--	43	5297	129
--	--	--	45	5290	135
--	--	--	52	5341	156
--	--	--	55	5300	165
--	--	--	70	5312	210
--	--	--	75	5325	225
--	--	--	92	5295	276
--	--	--	94	5324	282

Radar waveform #27			Radar waveform #28		
Hopping Number	Frequency (MHz)	Pulse Start (ms)	Hopping Number	Frequency (MHz)	Pulse Start (ms)
3	5319	9	23	5311	69
7	5339	21	26	5327	78
13	5341	39	33	5291	99
18	5343	54	34	5349	102
31	5296	93	41	5309	123
39	5318	117	43	5342	129
58	5326	174	51	5345	153
69	5337	207	53	5323	159
70	5345	210	59	5297	177
78	5295	234	65	5343	195
95	5305	285	66	5315	198
--	--	--	74	5340	222
--	--	--	94	5348	282

Radar waveform #29			Radar waveform #30		
Hopping Number	Frequency (MHz)	Pulse Start (ms)	Hopping Number	Frequency (MHz)	Pulse Start (ms)
3	5311	9	0	5343	0
7	5307	21	16	5329	48
13	5356	39	28	5326	84
25	5322	75	41	5308	123
29	5314	87	52	5318	156
48	5337	144	55	5303	165
53	5354	159	61	5322	183
70	5313	210	62	5325	186
72	5347	216	74	5312	222
74	5332	222	75	5340	225
87	5317	261	77	5333	231
90	5355	270	79	5321	237
92	5334	276	83	5327	249
--	--	--	85	5299	255
--	--	--	96	5302	288

6. CONCLUSION

The data collected relate only the item(s) tested and show that the **AC220m Wi-Fi module OD US**
FCC ID: 2AD8UFZCWMBOM2 is in compliance with FCC Rules.

_____ The End _____