

FCC Test Report (15.407, WLAN)

Report No.: RF151022E06-1

FCC ID: 2AD8UFZCWM2A1

Test Model: WM2A-AC210m

Received Date: Oct. 22, 2015

Test Date: Dec. 02 to 16, 2015

Issued Date: Jan. 21, 2016

Applicant: Nokia Solutions and Networks.OY

Address: Karaportti 3, P.O. Box 226, Nokia Group, Finland.

Issued By: Bureau Veritas Consumer Products Services (H.K.) Ltd., Taoyuan Branch
Hsin Chu Laboratory

Lab Address: E-2, No.1, Li Hsin 1st Road, Hsinchu Science Park, Hsinchu City 300,
Taiwan R.O.C.

Test Location (1): E-2, No.1, Li Hsin 1st Road, Hsinchu Science Park, Hsinchu City 300,
Taiwan R.O.C.

Test Location (2): No. 49, Ln. 206, Wende Rd., Shangshan Tsuen, Chiung Lin Hsiang, Hsin
Chu Hsien 307, Taiwan R.O.C.



This report is for your exclusive use. Any copying or replication of this report to or for any other person or entity, or use of our name or trademark, is permitted only with our prior written permission. This report sets forth our findings solely with respect to the test samples identified herein. The results set forth in this report are not indicative or representative of the quality or characteristics of the lot from which a test sample was taken or any similar or identical product unless specifically and expressly noted. Our report includes all of the tests requested by you and the results thereof based upon the information that you provided to us. You have 60 days from date of issuance of this report to notify us of any material error or omission caused by our negligence, provided, however, that such notice shall be in writing and shall specifically address the issue you wish to raise. A failure to raise such issue within the prescribed time shall constitute your unqualified acceptance of the completeness of this report, the tests conducted and the correctness of the report contents. Unless specific mention, the uncertainty of measurement has been explicitly taken into account to declare the compliance or non-compliance to the specification. The report must not be used by the client to claim product certification, approval, or endorsement by TAF or any government agencies.

Table of Contents

Release Control Record **4**

1 Certificate of Conformity **5**

2 Summary of Test Results **6**

 2.1 Measurement Uncertainty 6

 2.2 Modification Record 6

3 General Information **7**

 3.1 General Description of EUT (WLAN, 15.407) 7

 3.2 Description of Test Modes 10

 3.2.1 Test Mode Applicability and Tested Channel Detail 11

 3.3 Duty Cycle of Test Signal 14

 3.4 Description of Support Units 15

 3.4.1 Configuration of System under Test 15

 3.5 General Description of Applied Standard 16

4 Test Types and Results **17**

 4.1 Radiated Emission and Bandedge Measurement 17

 4.1.1 Limits of Radiated Emission and Bandedge Measurement 17

 4.1.2 Test Instruments 18

 4.1.3 Test Procedure 20

 4.1.4 Deviation from Test Standard 20

 4.1.5 Test Setup 21

 4.1.6 EUT Operating Condition 21

 4.1.7 Test Results (Mode 1) 22

 4.1.8 Test Results (Mode 2) 40

 4.1.9 Test Results (Mode 3) 58

 4.2 Conducted Emission Measurement 77

 4.2.1 Limits of Conducted Emission Measurement 77

 4.2.2 Test Procedure 78

 4.2.3 Deviation from Test Standard 78

 4.2.4 Test Setup 78

 4.2.5 EUT Operating Condition 78

 4.2.6 Test Results 79

 4.3 Transmit Power Measurement 81

 4.3.1 Limits of Transmit Power Measurement 81

 4.3.2 Test Setup 81

 4.3.3 Test Instruments 81

 4.3.4 Test Procedure 82

 4.3.5 Deviation from Test Standard 82

 4.3.6 EUT Operating Condition 82

 4.3.7 Test Result (Mode 1) 83

 4.3.8 Test Result (Mode 2) 85

 4.3.9 Test Result (Mode 3) 86

 4.4 Peak Power Spectral Density Measurement 88

 4.4.1 Limits of Peak Power Spectral Density Measurement 88

 4.4.2 Test Setup 88

 4.4.3 Test Instruments 88

 4.4.4 Test Procedure 89

 4.4.5 Deviation from Test Standard 89

 4.4.6 EUT Operating Condition 89

 4.4.7 Test Results (Mode 1) 90

 4.4.8 Test Results (Mode 2) 94

 4.4.9 Test Results (Mode 3) 98

 4.5 Frequency Stability Measurement 103

 4.5.1 Limits of Frequency Stability Measurement 103

4.5.2	Test Setup.....	103
4.5.3	Test Instruments	103
4.5.4	Test Procedure	103
4.5.5	Deviation from Test Standard	103
4.5.6	EUT Operating Condition	103
4.5.7	Test Results	104
4.6	6dB Bandwidth Measurement.....	105
4.6.1	Limits of 6dB Bandwidth Measurement.....	105
4.6.2	Test Setup.....	105
4.6.3	Test Instruments	105
4.6.4	Test Procedure	105
4.6.5	Deviation from Test Standard	105
4.6.6	EUT Operating Condition	105
4.6.7	Test Results (Mode 1).....	106
4.6.8	Test Results (Mode 2).....	108
4.6.9	Test Results (Mode 3).....	110
4.7	Occupied Bandwidth Measurement.....	112
4.7.1	Test Setup.....	112
4.7.2	Test Instruments	112
4.7.3	Test Procedure	112
4.7.4	Deviation from Test Standard	112
4.7.5	EUT Operating Conditions.....	112
4.7.6	Test Results (Mode 1).....	113
4.7.7	Test Results (Mode 2).....	115
4.7.8	Test Results (Mode 3).....	117
4.8	26dB Bandwidth Measurement.....	119
4.8.1	Test Setup.....	119
4.8.2	Test Instruments	119
4.8.3	Test Procedure	119
4.8.4	Deviation from Test Standard	119
4.8.5	EUT Operating Condition	119
4.8.6	Test Results (Mode 1).....	120
4.8.7	Test Results (Mode 2).....	122
4.8.8	Test Results (Mode 3).....	124
5	Pictures of Test Arrangements.....	126
	Appendix – Information on the Testing Laboratories	127



Release Control Record

Issue No.	Description	Date Issued
RF151022E06-1	Original release.	Jan. 21, 2016

2 Summary of Test Results

47 CFR FCC Part 15, Subpart E (SECTION 15.407)				
FCC Clause	FCC KDB 789033	Test Item	Result	Remarks
15.407(b)(6)	-	AC Power Conducted Emissions	Pass	Meet the requirement of limit. Minimum passing margin is -12.85dB at 0.23203MHz.
15.407(b)(1/2/3/4/6)	Section G	Radiated Emissions & Band Edge Measurement	PASS	Meet the requirement of limit. Minimum passing margin is -0.5dB at 5725.00MHz, 5715.00MHz, 5850.00MHz & 5150.00MHz.
15.407(b)(1/2/3/4/6)	Section G	Conducted Emissions	PASS	Meet the requirement of limit.
15.407(a)(1/2/3)	Section E.3	Max Average Transmit Power	PASS	Meet the requirement of limit.
15.407(a)(1/2/3)	Section F	Peak Power Spectral Density	PASS	Meet the requirement of limit.
15.407(e)	Section C.2	6dB bandwidth	PASS	Meet the requirement of limit. (U-NII-3 Band only)
-	Section D	Occupied Bandwidth Measurement	PASS	Meet the requirement.
15.407(g)	-	Frequency Stability	PASS	Meet the requirement of limit.
15.203	-	Antenna Requirement	PASS	Antenna connector is MMCX not a standard connector.

2.1 Measurement Uncertainty

Where relevant, the following measurement uncertainty levels have been estimated for tests performed on the EUT as specified in CISPR 16-4-2:

Measurement	Frequency	Expanded Uncertainty (k=2) (\pm)
Conducted Emissions at mains ports	150kHz ~ 30MHz	2.86 dB
Radiated Emissions up to 1 GHz	30MHz ~ 1GHz	5.31 dB
Radiated Emissions above 1 GHz	1GHz ~ 6GHz	3.40 dB
	6GHz ~ 18GHz	3.73 dB
	18GHz ~ 40GHz	4.11 dB

2.2 Modification Record

There were no modifications required for compliance.

3 General Information

3.1 General Description of EUT (WLAN, 15.407)

Product	Wi-Fi AP Module 802.11 ac
Brand	Nokia
Test Model	WM2A-AC210m
Test Sample S/N	F3406027
Hardware Version	AM2
Status of EUT	MASS-PRODUCTION
Power Supply Rating	5.1Vdc from host equipment
Modulation Type	64QAM, 16QAM, QPSK, BPSK for OFDM 256QAM for OFDM in 11ac mode
Modulation Technology	OFDM
Transfer Rate	802.11a: up to 54Mbps 802.11n: up to 300Mbps 802.11ac: up to 866.7Mbps
Operating Frequency	5.18 ~ 5.24GHz, 5.745 ~ 5.825GHz
Number of Channel	9 for 802.11a, 802.11n (HT20), 802.11ac (VHT20) 4 for 802.11n (HT40), 802.11ac (VHT40) 2 for 802.11ac (VHT80)
Output Power	<p>1TX (Chain 0) Mode: 5.18 ~ 5.24GHz: 802.11a: 182.81mW 802.11ac (VHT20): 180.717mW 802.11ac (VHT40): 159.221mW 802.11ac (VHT80): 96.605mW 5.745 ~ 5.825GHz: 802.11a: 162.93mW 802.11ac (VHT20): 163.682mW 802.11ac (VHT40): 160.694mW 802.11ac (VHT80): 51.523mW</p> <p>1TX (Chain 1) Mode: 5.18 ~ 5.24GHz: 802.11a: 195.884mW 802.11ac (VHT20): 196.789mW 802.11ac (VHT40): 190.108mW 802.11ac (VHT80): 63.387mW 5.745 ~ 5.825GHz: 802.11a: 163.305mW 802.11ac (VHT20): 161.065mW 802.11ac (VHT40): 162.181mW 802.11ac (VHT80): 38.282mW</p> <p>2TX Mode: 5.18 ~ 5.24GHz: 802.11a: 356.661mW 802.11ac (VHT20): 368.481mW 802.11ac (VHT40): 365.945mW 802.11ac (VHT80): 83.213mW 5.745 ~ 5.825GHz: 802.11a: 384.025mW 802.11ac (VHT20): 367.675mW 802.11ac (VHT40): 324.995mW 802.11ac (VHT80): 31.311mW</p>
Antenna Type	Refer to note as below
Antenna Connector	Refer to note as below
Accessory Device	NA
Data Cable Supplied	NA

Note:

1. 2.4GHz and 5GHz technology can transmit at same time.
2. The emission of the simultaneous operation (2.4GHz and 5GHz) has been evaluated and no non-compliance was found.
3. The antennas provided to the EUT, please refer to the following table:

WLAN – 5GHz Antenna spec.						
Antenna No	PCB Chain No.	Brand	Model	Antenna Type	Gain(dBi)	Frequency (GHz to GHz)
1	U20	Galtronics	NA	PIFA	6.03	5.15~5.25
					6.17	5.25~5.35
					5.57	5.47~5.725
					5.18	5.725~5.85
2	U21	Galtronics	NA	PIFA	5.1	5.15~5.25
					4.91	5.25~5.35
					5.23	5.47~5.725
					5.73	5.725~5.85

Cable Spec.					
Antenna No	Brand	Model	Connector Type	Cable Loss(dB)	Cable Length (cm)
1	NA	NA	MMCX	0	30.6
2	NA	NA	MMCX	0	9.1

4. The EUT incorporates a MIMO function.

5GHz Band			
MODULATION MODE	DATA RATE (MCS)	TX & RX CONFIGURATION	
802.11a	6 ~ 54Mbps	2TX	2RX
802.11n (HT20)	MCS 0~7	2TX	2RX
	MCS 8~15	2TX	2RX
802.11n (HT40)	MCS 0~7	2TX	2RX
	MCS 8~15	2TX	2RX
802.11ac (VHT20)	MCS 0~8, Nss=1	2TX	2RX
	MCS 0~8, Nss=2	2TX	2RX
802.11ac (VHT40)	MCS 0~9, Nss=1	2TX	2RX
	MCS 0~9, Nss=2	2TX	2RX
802.11ac (VHT80)	MCS 0~9, Nss=1	2TX	2RX
	MCS 0~9, Nss=2	2TX	2RX

The modulation and bandwidth are similar for 802.11n mode for 20MHz (40MHz) and 802.11ac mode for 20MHz (40MHz), therefore investigated worst case to representative mode in test report. (Final test mode refer section 3.2.1)

5. The above EUT information is declared by manufacturer and for more detailed features description, please refer to the manufacturer's specifications or user's manual.

3.2 Description of Test Modes

FOR 5180 ~ 5240MHz

4 channels are provided for 802.11a, 802.11n (HT20), 802.11ac (VHT20):

Channel	Frequency	Channel	Frequency
36	5180 MHz	44	5220 MHz
40	5200 MHz	48	5240 MHz

2 channels are provided for 802.11n (40MHz), 802.11ac (VHT40):

Channel	Frequency	Channel	Frequency
38	5190 MHz	46	5230 MHz

1 channel is provided for 802.11ac (VHT80):

Channel	Frequency
42	5210MHz

FOR 5745 ~ 5825MHz:

5 channels are provided for 802.11a, 802.11n (20MHz), 802.11ac (VHT20):

Channel	Frequency	Channel	Frequency
149	5745MHz	161	5805MHz
153	5765MHz	165	5825MHz
157	5785MHz		

2 channels are provided for 802.11n (40MHz), 802.11ac (VHT40):

Channel	Frequency	Channel	Frequency
151	5755MHz	159	5795MHz

1 channel is provided for 802.11ac (VHT80):

Channel	Frequency
155	5775MHz

3.2.1 Test Mode Applicability and Tested Channel Detail

EUT CONFIGURE MODE	APPLICABLE TO				DESCRIPTION
	RE \geq 1G	RE $<$ 1G	PLC	APCM	
1	√	-	√	√	1TX (Chain 0)
2	√	-	√	√	1TX (Chain 1)
3	√	√	√	√	2TX

Where **RE \geq 1G**: Radiated Emission above 1GHz **RE $<$ 1G**: Radiated Emission below 1GHz
PLC: Power Line Conducted Emission **APCM**: Antenna Port Conducted Measurement

NOTE: 1. "-" means no effect.

2. The EUT had been pre-tested on the positioned of each 3 axis. The worst case was found when positioned on Z-plane (for below 1GHz) and Y-plane (for above 1GHz).

Radiated Emission Test (Above 1GHz):

- Pre-Scan has been conducted to determine the worst-case mode from all possible combinations between available modulations, data rates and antenna ports (if EUT with antenna diversity architecture).
- Following channel(s) was (were) selected for the final test as listed below.

EUT CONFIGURE MODE	MODE	FREQ. BAND (MHz)	AVAILABLE CHANNEL	TESTED CHANNEL	MODULATION TECHNOLOGY	MODULATION TYPE	DATA RATE (Mbps)
1	802.11a	5180-5240	36 to 48	36, 40, 48	OFDM	BPSK	6
	802.11ac (VHT20)		36 to 48	36, 40, 48	OFDM	BPSK	6.5
	802.11ac (VHT40)		38 to 46	38, 46	OFDM	BPSK	13.5
	802.11ac (VHT80)		42	42	OFDM	BPSK	29.3
	802.11a	5745-5825	149 to 165	149, 157, 165	OFDM	BPSK	6
	802.11ac (VHT20)		149 to 165	149, 157, 165	OFDM	BPSK	6.5
	802.11ac (VHT40)		151 to 159	151, 159	OFDM	BPSK	13.5
	802.11ac (VHT80)		155	155	OFDM	BPSK	29.3
EUT CONFIGURE MODE	MODE	FREQ. BAND (MHz)	AVAILABLE CHANNEL	TESTED CHANNEL	MODULATION TECHNOLOGY	MODULATION TYPE	DATA RATE (Mbps)
2	802.11a	5180-5240	36 to 48	36, 40, 48	OFDM	BPSK	6
	802.11ac (VHT20)		36 to 48	36, 40, 48	OFDM	BPSK	6.5
	802.11ac (VHT40)		38 to 46	38, 46	OFDM	BPSK	13.5
	802.11ac (VHT80)		42	42	OFDM	BPSK	29.3
	802.11a	5745-5825	149 to 165	149, 157, 165	OFDM	BPSK	6
	802.11ac (VHT20)		149 to 165	149, 157, 165	OFDM	BPSK	6.5
	802.11ac (VHT40)		151 to 159	151, 159	OFDM	BPSK	13.5
	802.11ac (VHT80)		155	155	OFDM	BPSK	29.3

EUT CONFIGURE MODE	MODE	FREQ. BAND (MHz)	AVAILABLE CHANNEL	TESTED CHANNEL	MODULATION TECHNOLOGY	MODULATION TYPE	DATA RATE (Mbps)
3	802.11a	5180-5240	36 to 48	36, 40, 48	OFDM	BPSK	6
	802.11ac (VHT20)		36 to 48	36, 40, 48	OFDM	BPSK	6.5
	802.11ac (VHT40)		38 to 46	38, 46	OFDM	BPSK	13.5
	802.11ac (VHT80)		42	42	OFDM	BPSK	29.3
	802.11a	5745-5825	149 to 165	149, 157, 165	OFDM	BPSK	6
	802.11ac (VHT20)		149 to 165	149, 157, 165	OFDM	BPSK	6.5
	802.11ac (VHT40)		151 to 159	151, 159	OFDM	BPSK	13.5
	802.11ac (VHT80)		155	155	OFDM	BPSK	29.3

Radiated Emission Test (Below 1GHz):

- Pre-Scan has been conducted to determine the worst-case mode from all possible combinations between available modulations, data rates and antenna ports (if EUT with antenna diversity architecture).
- Following channel(s) was (were) selected for the final test as listed below.

EUT CONFIGURE MODE	MODE	Freq. BAND (MHz)	AVAILABLE CHANNEL	TESTED CHANNEL	MODULATION TECHNOLOGY	MODULATION TYPE	DATA RATE (Mbps)
3	802.11a	5180-5240, 5745-5825	36 to 48, 149 to 165	165	OFDM	BPSK	6

Power Line Conducted Emission Test:

- Pre-Scan has been conducted to determine the worst-case mode from all possible combinations between available modulations, data rates and antenna ports (if EUT with antenna diversity architecture).
- Following channel(s) was (were) selected for the final test as listed below.

EUT CONFIGURE MODE	MODE	Freq. BAND (MHz)	AVAILABLE CHANNEL	TESTED CHANNEL	MODULATION TECHNOLOGY	MODULATION TYPE	DATA RATE (Mbps)
3	802.11a	5180-5240, 5745-5825	36 to 48, 149 to 165	165	OFDM	BPSK	6

Antenna Port Conducted Measurement:

- This item includes all test value of each mode, but only includes spectrum plot of worst value of each mode.
- Pre-Scan has been conducted to determine the worst-case mode from all possible combinations between available modulations, data rates and antenna ports (if EUT with antenna diversity architecture).
- Following channel(s) was (were) selected for the final test as listed below.

EUT CONFIGURE MODE	MODE	FREQ. BAND (MHz)	AVAILABLE CHANNEL	TESTED CHANNEL	MODULATION TECHNOLOGY	MODULATION TYPE	DATA RATE (Mbps)
1	802.11a	5180-5240	36 to 48	36, 40, 48	OFDM	BPSK	6
	802.11ac (VHT20)		36 to 48	36, 40, 48	OFDM	BPSK	6.5
	802.11ac (VHT40)		38 to 46	38, 46	OFDM	BPSK	13.5
	802.11ac (VHT80)		42	42	OFDM	BPSK	29.3
	802.11a	5745-5825	149 to 165	149, 157, 165	OFDM	BPSK	6
	802.11ac (VHT20)		149 to 165	149, 157, 165	OFDM	BPSK	6.5
	802.11ac (VHT40)		151 to 159	151, 159	OFDM	BPSK	13.5
	802.11ac (VHT80)		155	155	OFDM	BPSK	29.3
EUT CONFIGURE MODE	MODE	FREQ. BAND (MHz)	AVAILABLE CHANNEL	TESTED CHANNEL	MODULATION TECHNOLOGY	MODULATION TYPE	DATA RATE (Mbps)
2	802.11a	5180-5240	36 to 48	36, 40, 48	OFDM	BPSK	6
	802.11ac (VHT20)		36 to 48	36, 40, 48	OFDM	BPSK	6.5
	802.11ac (VHT40)		38 to 46	38, 46	OFDM	BPSK	13.5
	802.11ac (VHT80)		42	42	OFDM	BPSK	29.3
	802.11a	5745-5825	149 to 165	149, 157, 165	OFDM	BPSK	6
	802.11ac (VHT20)		149 to 165	149, 157, 165	OFDM	BPSK	6.5
	802.11ac (VHT40)		151 to 159	151, 159	OFDM	BPSK	13.5
	802.11ac (VHT80)		155	155	OFDM	BPSK	29.3
EUT CONFIGURE MODE	MODE	FREQ. BAND (MHz)	AVAILABLE CHANNEL	TESTED CHANNEL	MODULATION TECHNOLOGY	MODULATION TYPE	DATA RATE (Mbps)
3	802.11a	5180-5240	36 to 48	36, 40, 48	OFDM	BPSK	6
	802.11ac (VHT20)		36 to 48	36, 40, 48	OFDM	BPSK	6.5
	802.11ac (VHT40)		38 to 46	38, 46	OFDM	BPSK	13.5
	802.11ac (VHT80)		42	42	OFDM	BPSK	29.3
	802.11a	5745-5825	149 to 165	149, 157, 165	OFDM	BPSK	6
	802.11ac (VHT20)		149 to 165	149, 157, 165	OFDM	BPSK	6.5
	802.11ac (VHT40)		151 to 159	151, 159	OFDM	BPSK	13.5
	802.11ac (VHT80)		155	155	OFDM	BPSK	29.3

Test Condition:

APPLICABLE TO	ENVIRONMENTAL CONDITIONS	INPUT POWER (SYSTEM)	TESTED BY
RE≥1G	26deg. C, 65%RH	120Vac, 60Hz	Jyunchun Lin
RE<1G	25deg. C, 65%RH	120Vac, 60Hz	Weiwei Lo
PLC	23deg. C, 67%RH	120Vac, 60Hz	Andy Ho
APCM	25deg. C, 60%RH	120Vac, 60Hz	Anderson Chen

3.3 Duty Cycle of Test Signal

If duty cycle of test signal is $\geq 98\%$, duty factor is not required.
 If duty cycle of test signal is $< 98\%$, duty factor shall be considered.

802.11a: Duty cycle = $5.343 \text{ ms} / 5.438 \text{ ms} = 0.983$

802.11ac (VHT20): Duty cycle = $4.953 \text{ ms} / 5.035 \text{ ms} = 0.984$

802.11ac (VHT40): Duty cycle = $2.398 \text{ ms} / 2.48 \text{ ms} = 0.967$, Duty factor = $10 * \log(1/0.967) = 0.15$

802.11ac (VHT80): Duty cycle = $1.135 \text{ ms} / 1.212 \text{ ms} = 0.936$, Duty factor = $10 * \log(1/0.936) = 0.29$

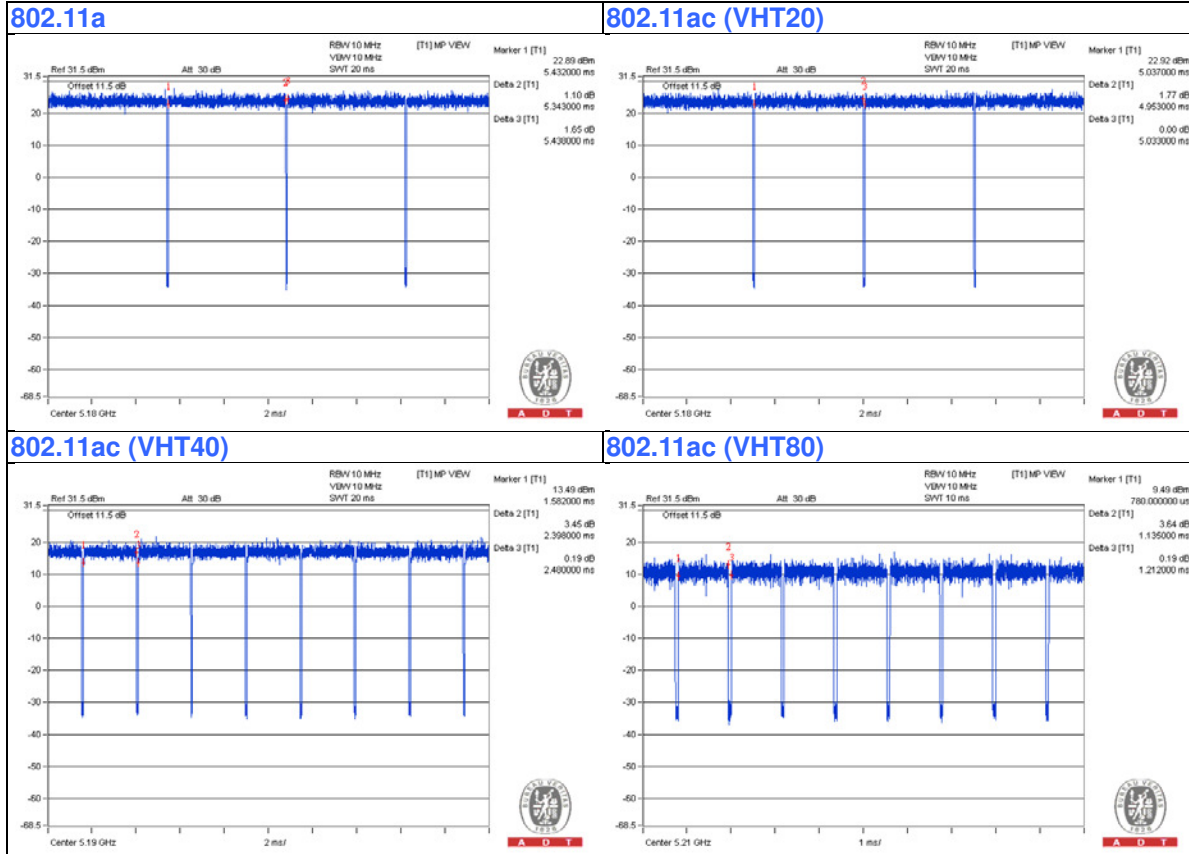

3.4 Description of Support Units

The EUT has been tested as an independent unit together with other necessary accessories or support units. The following support units or accessories were used to form a representative test configuration during the tests.

No.	Product	Brand	Model No.	Serial No.	FCC ID	Remark
A	Notebook Computer	DELL	E5430	4YV4VY1	FCC DoC	Provided by Lab
B	Test tool	CIG SHANGHAI	NA	NA	NA	Supplied by Client

NOTE:

1. All power cords of the above support units are non-shielded (1.8 m).

No.	Cable	Qty.	Length (m)	Shielded (Yes/ No)	Cores (Number)	Remark
1	DC	1	1.5	No	0	Supplied by Client
2	RJ-45	1	10	No	0	Provided by Lab
3	Console	1	0.7	No	0	Provided by Lab

3.4.1 Configuration of System under Test

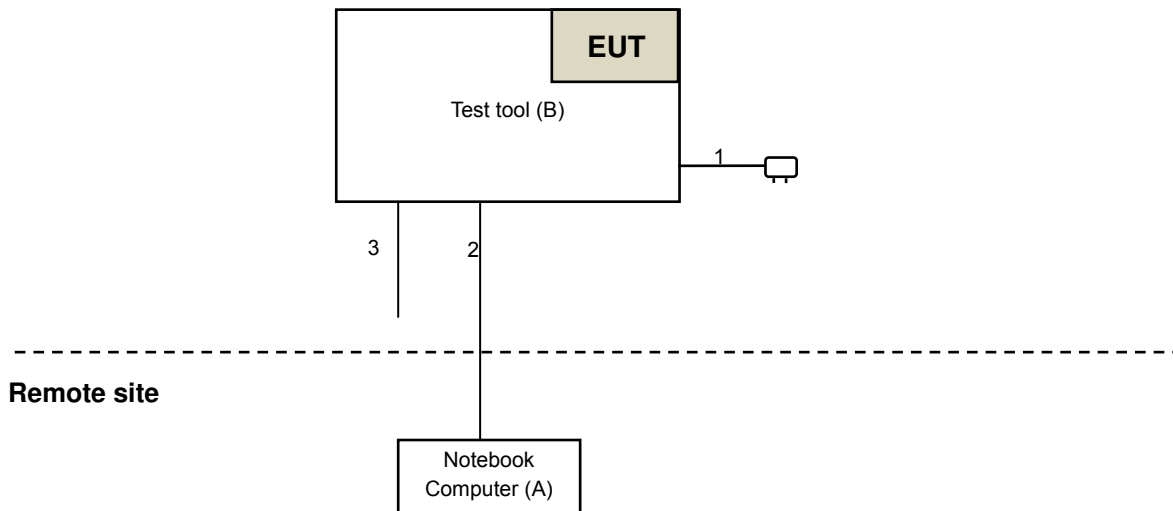

3.5 General Description of Applied Standard

The EUT is a RF Product. According to the specifications of the manufacturer, it must comply with the requirements of the following standards:

FCC Part 15, Subpart E (15.407)

KDB 789033 D02 General UNII Test Procedure New Rules v01r01

KDB 662911 D01 Multiple Transmitter Output v02r01

ANSI C63.10-2013

All test items have been performed and recorded as per the above standards.

4 Test Types and Results

4.1 Radiated Emission and Bandedge Measurement

4.1.1 Limits of Radiated Emission and Bandedge Measurement

Radiated emissions which fall in the restricted bands must comply with the radiated emission limits specified as below table.

Frequencies (MHz)	Field Strength (microvolts/meter)	Measurement Distance (meters)
0.009 ~ 0.490	2400/F(kHz)	300
0.490 ~ 1.705	24000/F(kHz)	30
1.705 ~ 30.0	30	30
30 ~ 88	100	3
88 ~ 216	150	3
216 ~ 960	200	3
Above 960	500	3

NOTE:

1. The lower limit shall apply at the transition frequencies.
2. Emission level (dBuV/m) = 20 log Emission level (uV/m).
3. For frequencies above 1000MHz, the field strength limits are based on average detector, however, the peak field strength of any emission shall not exceed the maximum permitted average limits, specified above by more than 20dB under any condition of modulation.

LIMITS OF UNWANTED EMISSION OUT OF THE RESTRICTED BANDS

APPLICABLE TO	LIMIT	
789033 D02 General UNII Test Procedure New Rules v01r01	FIELD STRENGTH AT 3m	
	PK:74 (dBuV/m)	AV:54 (dBuV/m)
APPLICABLE TO	EIRP LIMIT	EQUIVALENT FIELD STRENGTH AT 3m
15.407(b)(1)	PK:-27 (dBm/MHz)	PK:68.2(dBuV/m)
15.407(b)(2)		
15.407(b)(3)		
15.407(b)(4)	PK:-27 (dBm/MHz) ^{*1} PK:-17 (dBm/MHz) ^{*2}	PK: 68.2(dBuV/m) ^{*1} PK:78.2 (dBuV/m) ^{*2}

NOTE: ^{*1} beyond 10MHz of the band edge ^{*2} within 10 MHz of band edge

The following formula is used to convert the equipment isotropic radiated power (eirp) to field strength:

$$E = \frac{1000000\sqrt{30P}}{3} \mu\text{V/m, where } P \text{ is the eirp (Watts).}$$

4.1.2 Test Instruments

DESCRIPTION & MANUFACTURER	MODEL NO.	SERIAL NO.	CALIBRATED DATE	CALIBRATED UNTIL
Test Receiver Agilent	N9038A	MY50010156	Aug. 12, 2015	Aug. 11, 2016
Pre-Amplifier ^(*) EMCI	EMC001340	980142	Jan. 13, 2014	Jan. 12, 2016
Loop Antenna ^(*) Electro-Metrics	EM-6879	264	Dec. 16, 2014	Dec. 15, 2016
RF Cable	NA	LOOPCAB-001 LOOPCAB-002	Jan. 18, 2015	Jan. 17, 2016
Pre-Amplifier Mini-Circuits	ZFL-1000VH2 B	AMP-ZFL-07	May 08, 2015	May 07, 2016
Trilog Broadband Antenna SCHWARZBECK	VULB 9168	138	Feb. 03, 2015	Feb. 02, 2016
RF Cable	8D	966-3-1 966-3-2 966-3-3	Apr. 03, 2015	Apr. 02, 2016
Horn_Antenna SCHWARZBECK	BBHA9120-D	9120D-406	Feb. 05, 2015	Feb. 04, 2016
Pre-Amplifier Agilent	8449B	3008A02465	Apr. 06, 2015	Apr. 05, 2016
RF Cable	EMC104-SM- SM-2000 EMC104-SM- SM-5000 EMC104-SM- SM-5000	150317 150321 150322	Mar. 31, 2015	Mar. 30, 2016
Spectrum Analyzer Keysight	N9030A	MY54490520	July 26, 2015	July 25, 2016
Pre-Amplifier EMCI	EMC184045	980143	Jan. 16, 2015	Jan. 15, 2016
Horn_Antenna SCHWARZBECK	BBHA 9170	BBHA9170608	Feb. 05, 2015	Feb. 04, 2016
RF Cable	SUCOFLEX 102	36432/2 36441/2	Jan. 17, 2015	Jan. 16, 2016
Power Meter Anritsu	ML2495A	1014008	Apr. 28, 2015	Apr. 27, 2016
Power Sensor Anritsu	MA2411B	0917122	Apr. 28, 2015	Apr. 27, 2016
Spectrum Analyzer R&S	FSP40	100060	May 08, 2015	May 07, 2016
Software	ADT_Radiated _V8.7.07	NA	NA	NA
Antenna Tower & Turn Table CT	NA	NA	NA	NA
Spectrum Analyzer R&S	FSP40	100060	May 08, 2015	May 07, 2016
Power Meter Anritsu	ML2495A	1014008	Apr. 28, 2015	Apr. 27, 2016
Power Sensor Anritsu	MA2411B	0917122	Apr. 28, 2015	Apr. 27, 2016

**Note:**

1. The calibration interval of the above test instruments is 12 months and the calibrations are traceable to NML/ROC and NIST/USA.
2. *The calibration interval of the above test instruments is 24 months and the calibrations are traceable to NML/ROC and NIST/USA.
3. Loop antenna was used for all emissions below 30 MHz.
4. The test was performed in 966 Chamber No. 3.
- 5 The FCC Site Registration No. is 147459
6. The CANADA Site Registration No. is 20331-1
7. Tested Date: Dec. 02 to 15, 2015

4.1.3 Test Procedure

- a. The EUT was placed on the top of a rotating table 0.8 meters (for below 1GHz) / 1.5 meters (for above 1GHz) above the ground at 3 meter chamber room for test. The table was rotated 360 degrees to determine the position of the highest radiation.
- b. The EUT was set 3 meters away from the interference-receiving antenna, which was mounted on the top of a variable-height antenna tower.
- c. The height of antenna is varied from one meter to four meters above the ground to determine the maximum value of the field strength. Both horizontal and vertical polarizations of the antenna are set to make the measurement.
- d. For each suspected emission, the EUT was arranged to its worst case and then the antenna was tuned to heights from 1 meter to 4 meters and the rotatable table was turned from 0 degrees to 360 degrees to find the maximum reading.
- e. The test-receiver system was set to quasi-peak detect function and specified bandwidth with maximum hold mode when the test frequency is below 1 GHz.
- f. The test-receiver system was set to peak and average detect function and specified bandwidth with maximum hold mode when the test frequency is above 1 GHz. If the peak reading value also meets average limit, measurement with the average detector is unnecessary.

Note:

1. The resolution bandwidth and video bandwidth of test receiver/spectrum analyzer is 120kHz for Quasi-peak detection (QP) at frequency below 1GHz.
2. The resolution bandwidth of test receiver/spectrum analyzer is 1 MHz and the video bandwidth is 3 MHz for Peak detection (PK) at frequency above 1GHz.
3. The resolution bandwidth of test receiver/spectrum analyzer is 1MHz and the video bandwidth is 3MHz for RMS Average (Duty cycle < 98%) for Average detection (AV) at frequency above 1GHz, then the measurement results was added to a correction factor ($10 \log(1/\text{duty cycle})$).
4. The resolution bandwidth of test receiver/spectrum analyzer is 1MHz and the video bandwidth is 10Hz (Duty cycle $\geq 98\%$) for Average detection (AV) at frequency above 1GHz.
5. All modes of operation were investigated and the worst-case emissions are reported.

4.1.4 Deviation from Test Standard

No deviation.

4.1.5 Test Setup

<Frequency Range below 1GHz>

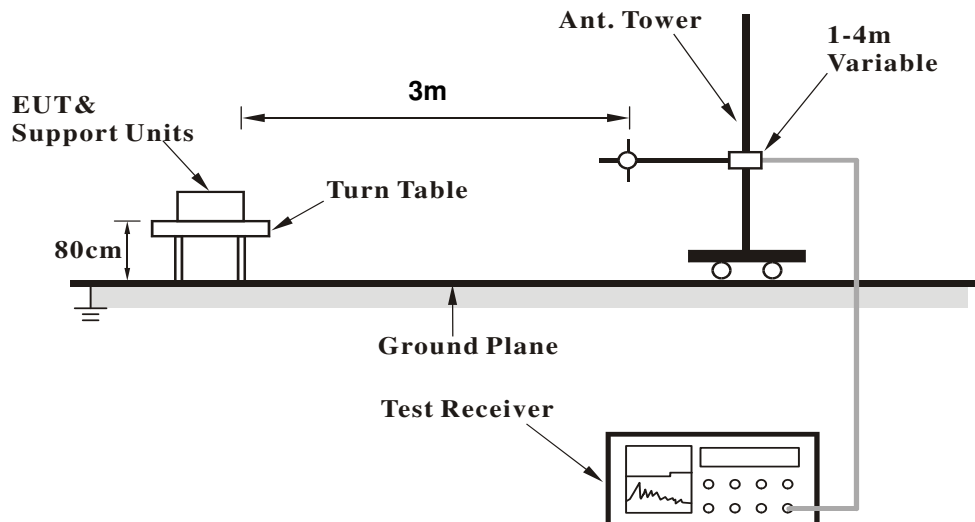

<Frequency Range above 1GHz>

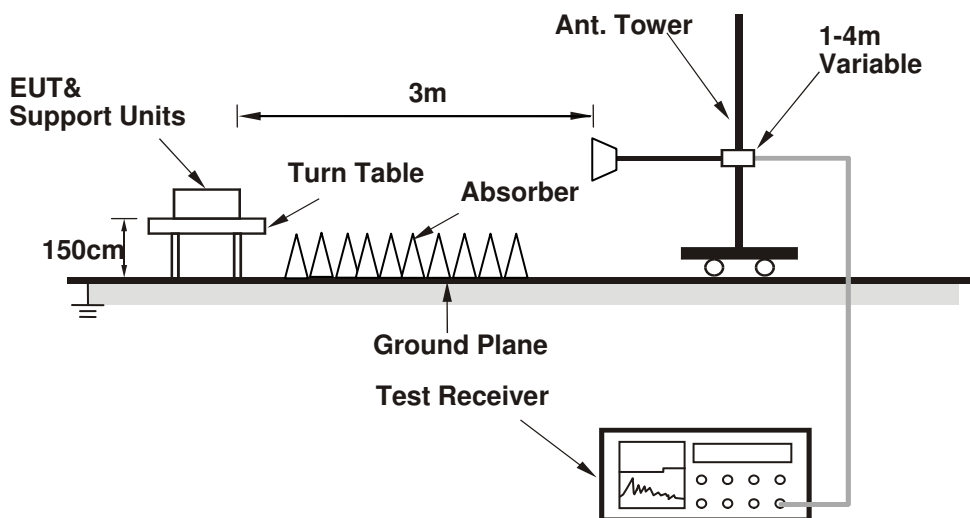

For the actual test configuration, please refer to the attached file (Test Setup Photo).

4.1.6 EUT Operating Condition

1. Connect the EUT with the support unit A (Notebook Computer) which is placed in remote site.
2. The communication partner run test program "art2_v_4_9_815" to enable EUT under transmission/receiving condition continuously at specific channel frequency.

4.1.7 Test Results (Mode 1)

Above 1GHz Data:

802.11a

CHANNEL	TX Channel 36	DETECTOR FUNCTION	Peak (PK)
FREQUENCY RANGE	1GHz ~ 40GHz		Average (AV)

ANTENNA POLARITY & TEST DISTANCE: HORIZONTAL AT 3 M

NO.	FREQ. (MHz)	EMISSION LEVEL (dBuV/m)	LIMIT (dBuV/m)	MARGIN (dB)	ANTENNA HEIGHT (m)	TABLE ANGLE (Degree)	RAW VALUE (dBuV)	CORRECTION FACTOR (dB/m)
1	5150.00	64.3 PK	74.0	-9.7	3.28 H	14	54.33	9.97
2	5150.00	47.6 AV	54.0	-6.4	3.28 H	14	37.63	9.97
3	*5180.00	109.2 PK			3.28 H	14	99.04	10.16
4	*5180.00	98.8 AV			3.28 H	14	88.64	10.16
5	#10360.00	49.3 PK	74.0	-24.7	1.66 H	205	32.32	16.98
6	#10360.00	36.6 AV	54.0	-17.4	1.66 H	205	19.62	16.98
7	15540.00	51.1 PK	74.0	-22.9	1.50 H	301	29.17	21.93
8	15540.00	40.1 AV	54.0	-13.9	1.50 H	301	18.17	21.93

ANTENNA POLARITY & TEST DISTANCE: VERTICAL AT 3 M

NO.	FREQ. (MHz)	EMISSION LEVEL (dBuV/m)	LIMIT (dBuV/m)	MARGIN (dB)	ANTENNA HEIGHT (m)	TABLE ANGLE (Degree)	RAW VALUE (dBuV)	CORRECTION FACTOR (dB/m)
1	5150.00	67.1 PK	74.0	-6.9	1.55 V	321	57.13	9.97
2	5150.00	50.2 AV	54.0	-3.8	1.55 V	321	40.23	9.97
3	*5180.00	113.1 PK			1.55 V	321	102.94	10.16
4	*5180.00	102.0 AV			1.55 V	321	91.84	10.16
5	#10360.00	50.4 PK	74.0	-23.6	1.69 V	228	33.42	16.98
6	#10360.00	37.1 AV	54.0	-16.9	1.69 V	228	20.12	16.98
7	15540.00	51.1 PK	74.0	-22.9	1.59 V	165	29.17	21.93
8	15540.00	41.1 AV	54.0	-12.9	1.59 V	165	19.17	21.93

REMARKS:

1. Emission Level(dBuV/m) = Raw Value(dBuV) + Correction Factor(dB/m)
2. Correction Factor(dB/m) = Antenna Factor(dB/m) + Cable Factor(dB) – Pre-Amplifier Factor(dB)
3. The other emission levels were very low against the limit.
4. Margin value = Emission Level – Limit value
5. " * ": Fundamental frequency.
6. " # ": The radiated frequency is out of the restricted band.

CHANNEL	TX Channel 40	DETECTOR FUNCTION	Peak (PK)
FREQUENCY RANGE	1GHz ~ 40GHz		Average (AV)

ANTENNA POLARITY & TEST DISTANCE: HORIZONTAL AT 3 M

NO.	FREQ. (MHz)	EMISSION LEVEL (dBuV/m)	LIMIT (dBuV/m)	MARGIN (dB)	ANTENNA HEIGHT (m)	TABLE ANGLE (Degree)	RAW VALUE (dBuV)	CORRECTION FACTOR (dB/m)
1	*5200.00	109.3 PK			3.32 H	30	99.04	10.26
2	*5200.00	98.9 AV			3.32 H	30	88.64	10.26
3	#10400.00	49.6 PK	74.0	-24.4	1.68 H	215	32.54	17.06
4	#10400.00	36.7 AV	54.0	-17.3	1.68 H	215	19.64	17.06
5	15600.00	51.2 PK	74.0	-22.8	1.52 H	313	28.92	22.28
6	15600.00	40.2 AV	54.0	-13.8	1.52 H	313	17.92	22.28

ANTENNA POLARITY & TEST DISTANCE: VERTICAL AT 3 M

NO.	FREQ. (MHz)	EMISSION LEVEL (dBuV/m)	LIMIT (dBuV/m)	MARGIN (dB)	ANTENNA HEIGHT (m)	TABLE ANGLE (Degree)	RAW VALUE (dBuV)	CORRECTION FACTOR (dB/m)
1	*5200.00	113.0 PK			1.71 V	312	102.74	10.26
2	*5200.00	101.9 AV			1.71 V	312	91.64	10.26
3	#10400.00	50.6 PK	74.0	-23.4	1.69 V	228	33.54	17.06
4	#10400.00	37.4 AV	54.0	-16.6	1.69 V	228	20.34	17.06
5	15600.00	51.1 PK	74.0	-22.9	1.59 V	165	28.82	22.28
6	15600.00	40.9 AV	54.0	-13.1	1.59 V	165	18.62	22.28

REMARKS:

1. Emission Level(dBuV/m) = Raw Value(dBuV) + Correction Factor(dB/m)
2. Correction Factor(dB/m) = Antenna Factor(dB/m) + Cable Factor(dB) – Pre-Amplifier Factor(dB)
3. The other emission levels were very low against the limit.
4. Margin value = Emission Level – Limit value
5. " * ": Fundamental frequency.
6. " # ": The radiated frequency is out of the restricted band.

CHANNEL	TX Channel 48	DETECTOR FUNCTION	Peak (PK)
FREQUENCY RANGE	1GHz ~ 40GHz		Average (AV)

ANTENNA POLARITY & TEST DISTANCE: HORIZONTAL AT 3 M

NO.	FREQ. (MHz)	EMISSION LEVEL (dBuV/m)	LIMIT (dBuV/m)	MARGIN (dB)	ANTENNA HEIGHT (m)	TABLE ANGLE (Degree)	RAW VALUE (dBuV)	CORRECTION FACTOR (dB/m)
1	*5240.00	109.7 PK			3.22 H	27	99.37	10.33
2	*5240.00	99.2 AV			3.22 H	27	88.87	10.33
3	5368.00	58.6 PK	74.0	-15.4	3.22 H	27	47.98	10.62
4	5368.00	44.7 AV	54.0	-9.3	3.22 H	27	34.08	10.62
5	#10480.00	49.2 PK	74.0	-24.8	1.70 H	212	32.47	16.73
6	#10480.00	36.6 AV	54.0	-17.4	1.70 H	212	19.87	16.73
7	15720.00	50.8 PK	74.0	-23.2	1.54 H	312	28.17	22.63
8	15720.00	39.8 AV	54.0	-14.2	1.54 H	312	17.17	22.63

ANTENNA POLARITY & TEST DISTANCE: VERTICAL AT 3 M

NO.	FREQ. (MHz)	EMISSION LEVEL (dBuV/m)	LIMIT (dBuV/m)	MARGIN (dB)	ANTENNA HEIGHT (m)	TABLE ANGLE (Degree)	RAW VALUE (dBuV)	CORRECTION FACTOR (dB/m)
1	*5240.00	113.3 PK			1.73 V	314	102.97	10.33
2	*5240.00	102.2 AV			1.73 V	314	91.87	10.33
3	5368.00	61.9 PK	74.0	-12.1	1.73 V	314	51.28	10.62
4	5368.00	48.1 AV	54.0	-5.9	1.73 V	314	37.48	10.62
5	#10480.00	49.7 PK	74.0	-24.3	1.70 V	226	32.97	16.73
6	#10480.00	36.6 AV	54.0	-17.4	1.70 V	226	19.87	16.73
7	15720.00	51.3 PK	74.0	-22.7	1.59 V	170	28.67	22.63
8	15720.00	41.5 AV	54.0	-12.5	1.59 V	170	18.87	22.63

REMARKS:

1. Emission Level(dBuV/m) = Raw Value(dBuV) + Correction Factor(dB/m)
2. Correction Factor(dB/m) = Antenna Factor(dB/m) + Cable Factor(dB) – Pre-Amplifier Factor(dB)
3. The other emission levels were very low against the limit.
4. Margin value = Emission Level – Limit value
5. " * ": Fundamental frequency.
6. " # ": The radiated frequency is out of the restricted band.

CHANNEL	TX Channel 149	DETECTOR FUNCTION	Peak (PK)
FREQUENCY RANGE	1GHz ~ 40GHz		Average (AV)

ANTENNA POLARITY & TEST DISTANCE: HORIZONTAL AT 3 M

NO.	FREQ. (MHz)	EMISSION LEVEL (dBuV/m)	LIMIT (dBuV/m)	MARGIN (dB)	ANTENNA HEIGHT (m)	TABLE ANGLE (Degree)	RAW VALUE (dBuV)	CORRECTION FACTOR (dB/m)
1	#5715.00	59.8 PK	74.0	-14.2	3.23 H	37	48.27	11.53
2	#5715.00	37.1 AV	54.0	-16.9	3.23 H	37	25.57	11.53
3	#5725.00	74.2 PK	78.2	-4.0	3.23 H	37	62.65	11.55
4	*5745.00	109.8 PK			3.23 H	37	98.17	11.63
5	*5745.00	99.5 AV			3.23 H	37	87.87	11.63
6	11490.00	49.8 PK	74.0	-24.2	1.68 H	214	32.50	17.30
7	11490.00	36.9 AV	54.0	-17.1	1.68 H	214	19.60	17.30
8	#17235.00	51.8 PK	74.0	-22.2	1.55 H	311	24.99	26.81
9	#17235.00	39.6 AV	54.0	-14.4	1.55 H	311	12.79	26.81

ANTENNA POLARITY & TEST DISTANCE: VERTICAL AT 3 M

NO.	FREQ. (MHz)	EMISSION LEVEL (dBuV/m)	LIMIT (dBuV/m)	MARGIN (dB)	ANTENNA HEIGHT (m)	TABLE ANGLE (Degree)	RAW VALUE (dBuV)	CORRECTION FACTOR (dB/m)
1	#5715.00	63.3 PK	74.0	-10.7	1.89 V	263	51.77	11.53
2	#5715.00	48.0 AV	54.0	-6.0	1.89 V	263	36.47	11.53
3	#5725.00	77.7 PK	78.2	-0.5	1.89 V	263	66.15	11.55
4	*5745.00	113.6 PK			1.89 V	263	101.97	11.63
5	*5745.00	102.6 AV			1.89 V	263	90.97	11.63
6	11490.00	50.5 PK	74.0	-23.5	1.74 V	218	33.20	17.30
7	11490.00	37.3 AV	54.0	-16.7	1.74 V	218	20.00	17.30
8	#17235.00	51.4 PK	74.0	-22.6	1.58 V	155	24.59	26.81
9	#17235.00	41.3 AV	54.0	-12.7	1.58 V	155	14.49	26.81

REMARKS:

1. Emission Level(dBuV/m) = Raw Value(dBuV) + Correction Factor(dB/m)
2. Correction Factor(dB/m) = Antenna Factor(dB/m) + Cable Factor(dB) – Pre-Amplifier Factor(dB)
3. The other emission levels were very low against the limit.
4. Margin value = Emission Level – Limit value
5. " * ": Fundamental frequency.
6. " # ": The radiated frequency is out of the restricted band.

CHANNEL	TX Channel 157	DETECTOR FUNCTION	Peak (PK)
FREQUENCY RANGE	1GHz ~ 40GHz		Average (AV)

ANTENNA POLARITY & TEST DISTANCE: HORIZONTAL AT 3 M

NO.	FREQ. (MHz)	EMISSION LEVEL (dBuV/m)	LIMIT (dBuV/m)	MARGIN (dB)	ANTENNA HEIGHT (m)	TABLE ANGLE (Degree)	RAW VALUE (dBuV)	CORRECTION FACTOR (dB/m)
1	#5715.00	52.9 PK	74.0	-21.1	3.19 H	34	41.37	11.53
2	#5715.00	40.1 AV	54.0	-13.9	3.19 H	34	28.57	11.53
3	#5725.00	53.8 PK	78.2	-24.4	3.19 H	34	42.25	11.55
4	*5785.00	110.1 PK			3.19 H	34	98.36	11.74
5	*5785.00	99.8 AV			3.19 H	34	88.06	11.74
6	#5850.00	51.4 PK	78.2	-26.8	3.19 H	34	39.65	11.75
7	#5860.00	50.6 PK	74.0	-23.4	3.19 H	34	38.85	11.75
8	#5860.00	38.8 AV	54.0	-15.2	3.19 H	34	27.05	11.75
9	11570.00	49.8 PK	74.0	-24.2	1.73 H	203	31.89	17.91
10	11570.00	37.1 AV	54.0	-16.9	1.73 H	203	19.19	17.91
11	#17355.00	51.9 PK	74.0	-22.1	1.61 H	314	24.76	27.14
12	#17355.00	39.9 AV	54.0	-14.1	1.61 H	314	12.76	27.14

ANTENNA POLARITY & TEST DISTANCE: VERTICAL AT 3 M

NO.	FREQ. (MHz)	EMISSION LEVEL (dBuV/m)	LIMIT (dBuV/m)	MARGIN (dB)	ANTENNA HEIGHT (m)	TABLE ANGLE (Degree)	RAW VALUE (dBuV)	CORRECTION FACTOR (dB/m)
1	#5715.00	56.3 PK	74.0	-17.7	1.94 V	262	44.77	11.53
2	#5715.00	43.0 AV	54.0	-11.0	1.94 V	262	31.47	11.53
3	#5725.00	57.2 PK	78.2	-21.0	1.94 V	262	45.65	11.55
4	*5785.00	113.8 PK			1.94 V	262	102.06	11.74
5	*5785.00	102.7 AV			1.94 V	262	90.96	11.74
6	#5850.00	54.8 PK	78.2	-23.4	1.94 V	262	43.05	11.75
7	#5860.00	54.1 PK	74.0	-19.9	1.94 V	262	42.35	11.75
8	#5860.00	41.8 AV	54.0	-12.2	1.94 V	262	30.05	11.75
9	11570.00	50.2 PK	74.0	-23.8	1.79 V	229	32.29	17.91
10	11570.00	37.1 AV	54.0	-16.9	1.79 V	229	19.19	17.91
11	#17355.00	51.6 PK	74.0	-22.4	1.57 V	141	24.46	27.14
12	#17355.00	41.7 AV	54.0	-12.3	1.57 V	141	14.56	27.14

REMARKS:

1. Emission Level(dBuV/m) = Raw Value(dBuV) + Correction Factor(dB/m)
2. Correction Factor(dB/m) = Antenna Factor(dB/m) + Cable Factor(dB) – Pre-Amplifier Factor(dB)
3. The other emission levels were very low against the limit.
4. Margin value = Emission Level – Limit value
5. " * ": Fundamental frequency.
6. " # ": The radiated frequency is out of the restricted band.

CHANNEL	TX Channel 165	DETECTOR FUNCTION	Peak (PK)
FREQUENCY RANGE	1GHz ~ 40GHz		Average (AV)

ANTENNA POLARITY & TEST DISTANCE: HORIZONTAL AT 3 M

NO.	FREQ. (MHz)	EMISSION LEVEL (dBuV/m)	LIMIT (dBuV/m)	MARGIN (dB)	ANTENNA HEIGHT (m)	TABLE ANGLE (Degree)	RAW VALUE (dBuV)	CORRECTION FACTOR (dB/m)
1	*5825.00	109.6 PK			3.17 H	48	97.82	11.78
2	*5825.00	99.4 AV			3.17 H	48	87.62	11.78
3	#5850.00	62.1 PK	78.2	-16.1	3.17 H	48	50.35	11.75
4	#5860.00	55.2 PK	74.0	-18.8	3.17 H	48	43.45	11.75
5	#5860.00	41.3 AV	54.0	-12.7	3.17 H	48	29.55	11.75
6	11650.00	49.3 PK	74.0	-24.7	1.65 H	209	31.14	18.16
7	11650.00	36.5 AV	54.0	-17.5	1.65 H	209	18.34	18.16
8	#17475.00	51.6 PK	74.0	-22.4	1.51 H	319	23.68	27.92
9	#17475.00	40.2 AV	54.0	-13.8	1.51 H	319	12.28	27.92

ANTENNA POLARITY & TEST DISTANCE: VERTICAL AT 3 M

NO.	FREQ. (MHz)	EMISSION LEVEL (dBuV/m)	LIMIT (dBuV/m)	MARGIN (dB)	ANTENNA HEIGHT (m)	TABLE ANGLE (Degree)	RAW VALUE (dBuV)	CORRECTION FACTOR (dB/m)
1	*5825.00	113.5 PK			1.95 V	265	101.72	11.78
2	*5825.00	102.4 AV			1.95 V	265	90.62	11.78
3	#5850.00	65.6 PK	78.2	-12.6	1.95 V	265	53.85	11.75
4	#5860.00	58.6 PK	74.0	-15.4	1.95 V	265	46.85	11.75
5	#5860.00	44.7 AV	54.0	-9.3	1.95 V	265	32.95	11.75
6	11650.00	49.9 PK	74.0	-24.1	1.68 V	216	31.74	18.16
7	11650.00	37.0 AV	54.0	-17.0	1.68 V	216	18.84	18.16
8	#17475.00	51.1 PK	74.0	-22.9	1.60 V	143	23.18	27.92
9	#17475.00	41.0 AV	54.0	-13.0	1.60 V	143	13.08	27.92

REMARKS:

1. Emission Level(dBuV/m) = Raw Value(dBuV) + Correction Factor(dB/m)
2. Correction Factor(dB/m) = Antenna Factor(dB/m) + Cable Factor(dB) – Pre-Amplifier Factor(dB)
3. The other emission levels were very low against the limit.
4. Margin value = Emission Level – Limit value
5. " * ": Fundamental frequency.
6. " # ": The radiated frequency is out of the restricted band.

802.11ac (VHT20)

CHANNEL	TX Channel 36	DETECTOR FUNCTION	Peak (PK)
FREQUENCY RANGE	1GHz ~ 40GHz		Average (AV)

ANTENNA POLARITY & TEST DISTANCE: HORIZONTAL AT 3 M

NO.	FREQ. (MHz)	EMISSION LEVEL (dBuV/m)	LIMIT (dBuV/m)	MARGIN (dB)	ANTENNA HEIGHT (m)	TABLE ANGLE (Degree)	RAW VALUE (dBuV)	CORRECTION FACTOR (dB/m)
1	5150.00	64.3 PK	74.0	-9.7	3.22 H	40	54.33	9.97
2	5150.00	48.2 AV	54.0	-5.8	3.22 H	40	38.23	9.97
3	*5180.00	108.5 PK			3.22 H	40	98.34	10.16
4	*5180.00	98.7 AV			3.22 H	40	88.54	10.16
5	#10360.00	50.3 PK	74.0	-23.7	1.63 H	201	33.32	16.98
6	#10360.00	37.2 AV	54.0	-16.8	1.63 H	201	20.22	16.98
7	15540.00	51.9 PK	74.0	-22.1	1.50 H	307	29.97	21.93
8	15540.00	40.7 AV	54.0	-13.3	1.50 H	307	18.77	21.93

ANTENNA POLARITY & TEST DISTANCE: VERTICAL AT 3 M

NO.	FREQ. (MHz)	EMISSION LEVEL (dBuV/m)	LIMIT (dBuV/m)	MARGIN (dB)	ANTENNA HEIGHT (m)	TABLE ANGLE (Degree)	RAW VALUE (dBuV)	CORRECTION FACTOR (dB/m)
1	5150.00	67.9 PK	74.0	-6.1	2.04 V	296	57.93	9.97
2	5150.00	51.6 AV	54.0	-2.4	2.04 V	296	41.63	9.97
3	*5180.00	114.5 PK			2.04 V	296	104.34	10.16
4	*5180.00	103.0 AV			2.04 V	296	92.84	10.16
5	#10360.00	50.3 PK	74.0	-23.7	1.67 V	216	33.32	16.98
6	#10360.00	37.3 AV	54.0	-16.7	1.67 V	216	20.32	16.98
7	15540.00	50.8 PK	74.0	-23.2	1.55 V	156	28.87	21.93
8	15540.00	40.6 AV	54.0	-13.4	1.55 V	156	18.67	21.93

REMARKS:

1. Emission Level(dBuV/m) = Raw Value(dBuV) + Correction Factor(dB/m)
2. Correction Factor(dB/m) = Antenna Factor(dB/m) + Cable Factor(dB) – Pre-Amplifier Factor(dB)
3. The other emission levels were very low against the limit.
4. Margin value = Emission Level – Limit value
5. " * ": Fundamental frequency.
6. " # ": The radiated frequency is out of the restricted band.

CHANNEL	TX Channel 40	DETECTOR FUNCTION	Peak (PK)
FREQUENCY RANGE	1GHz ~ 40GHz		Average (AV)

ANTENNA POLARITY & TEST DISTANCE: HORIZONTAL AT 3 M

NO.	FREQ. (MHz)	EMISSION LEVEL (dBuV/m)	LIMIT (dBuV/m)	MARGIN (dB)	ANTENNA HEIGHT (m)	TABLE ANGLE (Degree)	RAW VALUE (dBuV)	CORRECTION FACTOR (dB/m)
1	*5200.00	108.9 PK			3.08 H	65	98.64	10.26
2	*5200.00	99.2 AV			3.08 H	65	88.94	10.26
3	#10400.00	49.6 PK	74.0	-24.4	1.69 H	213	32.54	17.06
4	#10400.00	36.6 AV	54.0	-17.4	1.69 H	213	19.54	17.06
5	15600.00	52.1 PK	74.0	-21.9	1.55 H	302	29.82	22.28
6	15600.00	40.9 AV	54.0	-13.1	1.55 H	302	18.62	22.28

ANTENNA POLARITY & TEST DISTANCE: VERTICAL AT 3 M

NO.	FREQ. (MHz)	EMISSION LEVEL (dBuV/m)	LIMIT (dBuV/m)	MARGIN (dB)	ANTENNA HEIGHT (m)	TABLE ANGLE (Degree)	RAW VALUE (dBuV)	CORRECTION FACTOR (dB/m)
1	*5200.00	114.8 PK			2.02 V	297	104.54	10.26
2	*5200.00	103.3 AV			2.02 V	297	93.04	10.26
3	#10400.00	50.5 PK	74.0	-23.5	1.65 V	214	33.44	17.06
4	#10400.00	37.2 AV	54.0	-16.8	1.65 V	214	20.14	17.06
5	15600.00	51.0 PK	74.0	-23.0	1.50 V	143	28.72	22.28
6	15600.00	40.9 AV	54.0	-13.1	1.50 V	143	18.62	22.28

REMARKS:

1. Emission Level(dBuV/m) = Raw Value(dBuV) + Correction Factor(dB/m)
2. Correction Factor(dB/m) = Antenna Factor(dB/m) + Cable Factor(dB) – Pre-Amplifier Factor(dB)
3. The other emission levels were very low against the limit.
4. Margin value = Emission Level – Limit value
5. " * ": Fundamental frequency.
6. " # ": The radiated frequency is out of the restricted band.

CHANNEL	TX Channel 48	DETECTOR FUNCTION	Peak (PK)
FREQUENCY RANGE	1GHz ~ 40GHz		Average (AV)

ANTENNA POLARITY & TEST DISTANCE: HORIZONTAL AT 3 M

NO.	FREQ. (MHz)	EMISSION LEVEL (dBuV/m)	LIMIT (dBuV/m)	MARGIN (dB)	ANTENNA HEIGHT (m)	TABLE ANGLE (Degree)	RAW VALUE (dBuV)	CORRECTION FACTOR (dB/m)
1	*5240.00	108.2 PK			3.11 H	72	97.87	10.33
2	*5240.00	99.0 AV			3.11 H	72	88.67	10.33
3	5350.00	57.7 PK	74.0	-16.3	3.11 H	72	47.15	10.55
4	5350.00	44.2 AV	54.0	-9.8	3.11 H	72	33.65	10.55
5	#10480.00	49.7 PK	74.0	-24.3	1.69 H	211	32.97	16.73
6	#10480.00	36.9 AV	54.0	-17.1	1.69 H	211	20.17	16.73
7	15720.00	51.4 PK	74.0	-22.6	1.49 H	311	28.77	22.63
8	15720.00	40.1 AV	54.0	-13.9	1.49 H	311	17.47	22.63

ANTENNA POLARITY & TEST DISTANCE: VERTICAL AT 3 M

NO.	FREQ. (MHz)	EMISSION LEVEL (dBuV/m)	LIMIT (dBuV/m)	MARGIN (dB)	ANTENNA HEIGHT (m)	TABLE ANGLE (Degree)	RAW VALUE (dBuV)	CORRECTION FACTOR (dB/m)
1	*5240.00	114.2 PK			2.02 V	298	103.87	10.33
2	*5240.00	103.1 AV			2.02 V	298	92.77	10.33
3	5350.00	61.2 PK	74.0	-12.8	2.02 V	298	50.65	10.55
4	5350.00	47.5 AV	54.0	-6.5	2.02 V	298	36.95	10.55
5	#10480.00	50.9 PK	74.0	-23.1	1.69 V	228	34.17	16.73
6	#10480.00	37.6 AV	54.0	-16.4	1.69 V	228	20.87	16.73
7	15720.00	51.2 PK	74.0	-22.8	1.57 V	139	28.57	22.63
8	15720.00	40.9 AV	54.0	-13.1	1.57 V	139	18.27	22.63

REMARKS:

1. Emission Level(dBuV/m) = Raw Value(dBuV) + Correction Factor(dB/m)
2. Correction Factor(dB/m) = Antenna Factor(dB/m) + Cable Factor(dB) – Pre-Amplifier Factor(dB)
3. The other emission levels were very low against the limit.
4. Margin value = Emission Level – Limit value
5. " * ": Fundamental frequency.
6. " # ": The radiated frequency is out of the restricted band.

CHANNEL	TX Channel 149	DETECTOR FUNCTION	Peak (PK)
FREQUENCY RANGE	1GHz ~ 40GHz		Average (AV)

ANTENNA POLARITY & TEST DISTANCE: HORIZONTAL AT 3 M

NO.	FREQ. (MHz)	EMISSION LEVEL (dBuV/m)	LIMIT (dBuV/m)	MARGIN (dB)	ANTENNA HEIGHT (m)	TABLE ANGLE (Degree)	RAW VALUE (dBuV)	CORRECTION FACTOR (dB/m)
1	#5715.00	61.3 PK	74.0	-12.7	3.08 H	49	49.77	11.53
2	#5715.00	44.9 AV	54.0	-9.1	3.08 H	49	33.37	11.53
3	#5725.00	74.2 PK	78.2	-4.0	3.08 H	49	62.65	11.55
4	*5745.00	108.5 PK			3.08 H	49	96.87	11.63
5	*5745.00	99.1 AV			3.08 H	49	87.47	11.63
6	11490.00	49.6 PK	74.0	-24.4	1.74 H	215	32.30	17.30
7	11490.00	36.8 AV	54.0	-17.2	1.74 H	215	19.50	17.30
8	#17235.00	51.8 PK	74.0	-22.2	1.54 H	304	24.99	26.81
9	#17235.00	40.7 AV	54.0	-13.3	1.54 H	304	13.89	26.81

ANTENNA POLARITY & TEST DISTANCE: VERTICAL AT 3 M

NO.	FREQ. (MHz)	EMISSION LEVEL (dBuV/m)	LIMIT (dBuV/m)	MARGIN (dB)	ANTENNA HEIGHT (m)	TABLE ANGLE (Degree)	RAW VALUE (dBuV)	CORRECTION FACTOR (dB/m)
1	#5715.00	64.7 PK	74.0	-9.3	2.06 V	277	53.17	11.53
2	#5715.00	48.3 AV	54.0	-5.7	2.06 V	277	36.77	11.53
3	#5725.00	77.7 PK	78.2	-0.5	2.06 V	277	66.15	11.55
4	*5745.00	114.4 PK			2.06 V	277	102.77	11.63
5	*5745.00	103.0 AV			2.06 V	277	91.37	11.63
6	11490.00	50.1 PK	74.0	-23.9	1.72 V	228	32.80	17.30
7	11490.00	36.9 AV	54.0	-17.1	1.72 V	228	19.60	17.30
8	#17235.00	51.2 PK	74.0	-22.8	1.52 V	151	24.39	26.81
9	#17235.00	40.9 AV	54.0	-13.1	1.52 V	151	14.09	26.81

REMARKS:

1. Emission Level(dBuV/m) = Raw Value(dBuV) + Correction Factor(dB/m)
2. Correction Factor(dB/m) = Antenna Factor(dB/m) + Cable Factor(dB) – Pre-Amplifier Factor(dB)
3. The other emission levels were very low against the limit.
4. Margin value = Emission Level – Limit value
5. " * ": Fundamental frequency.
6. " # ": The radiated frequency is out of the restricted band.

CHANNEL	TX Channel 157	DETECTOR FUNCTION	Peak (PK)
FREQUENCY RANGE	1GHz ~ 40GHz		Average (AV)

ANTENNA POLARITY & TEST DISTANCE: HORIZONTAL AT 3 M

NO.	FREQ. (MHz)	EMISSION LEVEL (dBuV/m)	LIMIT (dBuV/m)	MARGIN (dB)	ANTENNA HEIGHT (m)	TABLE ANGLE (Degree)	RAW VALUE (dBuV)	CORRECTION FACTOR (dB/m)
1	#5715.00	53.2 PK	74.0	-20.8	3.14 H	34	41.67	11.53
2	#5715.00	39.5 AV	54.0	-14.5	3.14 H	34	27.97	11.53
3	#5725.00	54.1 PK	78.2	-24.1	3.14 H	34	42.55	11.55
4	*5785.00	108.4 PK			3.14 H	34	96.66	11.74
5	*5785.00	99.0 AV			3.14 H	34	87.26	11.74
6	#5850.00	52.1 PK	78.2	-26.1	3.14 H	34	40.35	11.75
7	#5860.00	51.0 PK	74.0	-23.0	3.14 H	34	39.25	11.75
8	#5860.00	37.3 AV	54.0	-16.7	3.14 H	34	25.55	11.75
9	11570.00	49.9 PK	74.0	-24.1	1.66 H	212	31.99	17.91
10	11570.00	36.9 AV	54.0	-17.1	1.66 H	212	18.99	17.91
11	#17355.00	51.8 PK	74.0	-22.2	1.56 H	326	24.66	27.14
12	#17355.00	40.8 AV	54.0	-13.2	1.56 H	326	13.66	27.14

ANTENNA POLARITY & TEST DISTANCE: VERTICAL AT 3 M

NO.	FREQ. (MHz)	EMISSION LEVEL (dBuV/m)	LIMIT (dBuV/m)	MARGIN (dB)	ANTENNA HEIGHT (m)	TABLE ANGLE (Degree)	RAW VALUE (dBuV)	CORRECTION FACTOR (dB/m)
1	#5715.00	56.6 PK	74.0	-17.4	2.04 V	275	45.07	11.53
2	#5715.00	42.6 AV	54.0	-11.4	2.04 V	275	31.07	11.53
3	#5725.00	57.3 PK	78.2	-20.9	2.04 V	275	45.75	11.55
4	*5785.00	114.4 PK			2.04 V	275	102.66	11.74
5	*5785.00	102.8 AV			2.04 V	275	91.06	11.74
6	#5850.00	55.7 PK	78.2	-22.5	2.04 V	275	43.95	11.75
7	#5860.00	54.4 PK	74.0	-19.6	2.04 V	275	42.65	11.75
8	#5860.00	40.6 AV	54.0	-13.4	2.04 V	275	28.85	11.75
9	11570.00	50.9 PK	74.0	-23.1	1.64 V	233	32.99	17.91
10	11570.00	37.3 AV	54.0	-16.7	1.64 V	233	19.39	17.91
11	#17355.00	51.3 PK	74.0	-22.7	1.54 V	168	24.16	27.14
12	#17355.00	41.4 AV	54.0	-12.6	1.54 V	168	14.26	27.14

REMARKS:

1. Emission Level(dBuV/m) = Raw Value(dBuV) + Correction Factor(dB/m)
2. Correction Factor(dB/m) = Antenna Factor(dB/m) + Cable Factor(dB) – Pre-Amplifier Factor(dB)
3. The other emission levels were very low against the limit.
4. Margin value = Emission Level – Limit value
5. " * ": Fundamental frequency.
6. " # ": The radiated frequency is out of the restricted band.

CHANNEL	TX Channel 165	DETECTOR FUNCTION	Peak (PK)
FREQUENCY RANGE	1GHz ~ 40GHz		Average (AV)

ANTENNA POLARITY & TEST DISTANCE: HORIZONTAL AT 3 M

NO.	FREQ. (MHz)	EMISSION LEVEL (dBuV/m)	LIMIT (dBuV/m)	MARGIN (dB)	ANTENNA HEIGHT (m)	TABLE ANGLE (Degree)	RAW VALUE (dBuV)	CORRECTION FACTOR (dB/m)
1	*5825.00	107.7 PK			3.33 H	65	95.92	11.78
2	*5825.00	98.3 AV			3.33 H	65	86.52	11.78
3	#5850.00	66.1 PK	78.2	-12.1	3.33 H	65	54.35	11.75
4	#5860.00	55.1 PK	74.0	-18.9	3.33 H	65	43.35	11.75
5	#5860.00	40.8 AV	54.0	-13.2	3.33 H	65	29.05	11.75
6	11650.00	49.7 PK	74.0	-24.3	1.71 H	199	31.54	18.16
7	11650.00	37.1 AV	54.0	-16.9	1.71 H	199	18.94	18.16
8	#17475.00	51.8 PK	74.0	-22.2	1.53 H	327	23.88	27.92
9	#17475.00	40.8 AV	54.0	-13.2	1.53 H	327	12.88	27.92

ANTENNA POLARITY & TEST DISTANCE: VERTICAL AT 3 M

NO.	FREQ. (MHz)	EMISSION LEVEL (dBuV/m)	LIMIT (dBuV/m)	MARGIN (dB)	ANTENNA HEIGHT (m)	TABLE ANGLE (Degree)	RAW VALUE (dBuV)	CORRECTION FACTOR (dB/m)
1	*5825.00	113.8 PK			2.04 V	291	102.02	11.78
2	*5825.00	102.2 AV			2.04 V	291	90.42	11.78
3	#5850.00	69.6 PK	78.2	-8.6	2.04 V	291	57.85	11.75
4	#5860.00	58.7 PK	74.0	-15.3	2.04 V	291	46.95	11.75
5	#5860.00	44.3 AV	54.0	-9.7	2.04 V	291	32.55	11.75
6	11650.00	50.3 PK	74.0	-23.7	1.77 V	212	32.14	18.16
7	11650.00	37.4 AV	54.0	-16.6	1.77 V	212	19.24	18.16
8	#17475.00	51.1 PK	74.0	-22.9	1.62 V	163	23.18	27.92
9	#17475.00	41.1 AV	54.0	-12.9	1.62 V	163	13.18	27.92

REMARKS:

1. Emission Level(dBuV/m) = Raw Value(dBuV) + Correction Factor(dB/m)
2. Correction Factor(dB/m) = Antenna Factor(dB/m) + Cable Factor(dB) – Pre-Amplifier Factor(dB)
3. The other emission levels were very low against the limit.
4. Margin value = Emission Level – Limit value
5. " * ": Fundamental frequency.
6. " # ": The radiated frequency is out of the restricted band.

802.11ac (VHT40)

CHANNEL	TX Channel 38	DETECTOR FUNCTION	Peak (PK)
FREQUENCY RANGE	1GHz ~ 40GHz		Average (AV)

ANTENNA POLARITY & TEST DISTANCE: HORIZONTAL AT 3 M

NO.	FREQ. (MHz)	EMISSION LEVEL (dBuV/m)	LIMIT (dBuV/m)	MARGIN (dB)	ANTENNA HEIGHT (m)	TABLE ANGLE (Degree)	RAW VALUE (dBuV)	CORRECTION FACTOR (dB/m)
1	5150.00	64.9 PK	74.0	-9.1	3.19 H	71	54.93	9.97
2	5150.00	49.7 AV	54.0	-4.3	3.19 H	71	39.73	9.97
3	*5190.00	102.9 PK			3.19 H	71	92.70	10.20
4	*5190.00	93.1 AV			3.19 H	71	82.90	10.20
5	5350.00	57.2 PK	74.0	-16.8	3.19 H	71	46.65	10.55
6	5350.00	43.7 AV	54.0	-10.3	3.19 H	71	33.15	10.55
7	#10380.00	50.2 PK	74.0	-23.8	1.73 H	201	33.18	17.02
8	#10380.00	37.1 AV	54.0	-16.9	1.73 H	201	20.08	17.02
9	15570.00	51.8 PK	74.0	-22.2	1.51 H	316	29.70	22.10
10	15570.00	40.6 AV	54.0	-13.4	1.51 H	316	18.50	22.10

ANTENNA POLARITY & TEST DISTANCE: VERTICAL AT 3 M

NO.	FREQ. (MHz)	EMISSION LEVEL (dBuV/m)	LIMIT (dBuV/m)	MARGIN (dB)	ANTENNA HEIGHT (m)	TABLE ANGLE (Degree)	RAW VALUE (dBuV)	CORRECTION FACTOR (dB/m)
1	5150.00	68.4 PK	74.0	-5.6	2.02 V	297	58.43	9.97
2	5150.00	53.0 AV	54.0	-1.0	2.02 V	297	43.03	9.97
3	*5190.00	108.6 PK			2.02 V	297	98.40	10.20
4	*5190.00	97.5 AV			2.02 V	297	87.30	10.20
5	5350.00	60.6 PK	74.0	-13.4	2.02 V	297	50.05	10.55
6	5350.00	47.1 AV	54.0	-6.9	2.02 V	297	36.55	10.55
7	#10380.00	50.2 PK	74.0	-23.8	1.65 V	242	33.18	17.02
8	#10380.00	36.7 AV	54.0	-17.3	1.65 V	242	19.68	17.02
9	15570.00	50.5 PK	74.0	-23.5	1.56 V	167	28.40	22.10
10	15570.00	40.8 AV	54.0	-13.2	1.56 V	167	18.70	22.10

REMARKS:

- Emission Level(dBuV/m) = Raw Value(dBuV) + Correction Factor(dB/m)
- Correction Factor(dB/m) = Antenna Factor(dB/m) + Cable Factor(dB) – Pre-Amplifier Factor(dB)
- The other emission levels were very low against the limit.
- Margin value = Emission Level – Limit value
- " * ": Fundamental frequency.
- " # ": The radiated frequency is out of the restricted band.

CHANNEL	TX Channel 46	DETECTOR FUNCTION	Peak (PK)
FREQUENCY RANGE	1GHz ~ 40GHz		Average (AV)

ANTENNA POLARITY & TEST DISTANCE: HORIZONTAL AT 3 M

NO.	FREQ. (MHz)	EMISSION LEVEL (dBuV/m)	LIMIT (dBuV/m)	MARGIN (dB)	ANTENNA HEIGHT (m)	TABLE ANGLE (Degree)	RAW VALUE (dBuV)	CORRECTION FACTOR (dB/m)
1	5150.00	53.8 PK	74.0	-20.2	3.26 H	85	43.83	9.97
2	5150.00	40.7 AV	54.0	-13.3	3.26 H	85	30.73	9.97
3	*5230.00	105.7 PK			3.26 H	85	95.38	10.32
4	*5230.00	95.9 AV			3.26 H	85	85.58	10.32
5	5350.00	57.7 PK	74.0	-16.3	3.26 H	85	47.15	10.55
6	5350.00	44.0 AV	54.0	-10.0	3.26 H	85	33.45	10.55
7	#10460.00	50.1 PK	74.0	-23.9	1.65 H	207	33.28	16.82
8	#10460.00	37.2 AV	54.0	-16.8	1.65 H	207	20.38	16.82
9	15690.00	52.0 PK	74.0	-22.0	1.61 H	307	29.48	22.52
10	15690.00	40.5 AV	54.0	-13.5	1.61 H	307	17.98	22.52

ANTENNA POLARITY & TEST DISTANCE: VERTICAL AT 3 M

NO.	FREQ. (MHz)	EMISSION LEVEL (dBuV/m)	LIMIT (dBuV/m)	MARGIN (dB)	ANTENNA HEIGHT (m)	TABLE ANGLE (Degree)	RAW VALUE (dBuV)	CORRECTION FACTOR (dB/m)
1	5150.00	57.2 PK	74.0	-16.8	2.07 V	298	47.23	9.97
2	5150.00	44.1 AV	54.0	-9.9	2.07 V	298	34.13	9.97
3	*5230.00	111.5 PK			2.07 V	298	101.18	10.32
4	*5230.00	99.3 AV			2.07 V	298	88.98	10.32
5	5350.00	61.0 PK	74.0	-13.0	2.07 V	298	50.45	10.55
6	5350.00	47.2 AV	54.0	-6.8	2.07 V	298	36.65	10.55
7	#10460.00	50.6 PK	74.0	-23.4	1.70 V	205	33.78	16.82
8	#10460.00	37.2 AV	54.0	-16.8	1.70 V	205	20.38	16.82
9	15690.00	51.2 PK	74.0	-22.8	1.64 V	157	28.68	22.52
10	15690.00	41.3 AV	54.0	-12.7	1.64 V	157	18.78	22.52

REMARKS:

1. Emission Level(dBuV/m) = Raw Value(dBuV) + Correction Factor(dB/m)
2. Correction Factor(dB/m) = Antenna Factor(dB/m) + Cable Factor(dB) – Pre-Amplifier Factor(dB)
3. The other emission levels were very low against the limit.
4. Margin value = Emission Level – Limit value
5. " * ": Fundamental frequency.
6. " # ": The radiated frequency is out of the restricted band.

CHANNEL	TX Channel 151	DETECTOR FUNCTION	Peak (PK)
FREQUENCY RANGE	1GHz ~ 40GHz		Average (AV)

ANTENNA POLARITY & TEST DISTANCE: HORIZONTAL AT 3 M

NO.	FREQ. (MHz)	EMISSION LEVEL (dBuV/m)	LIMIT (dBuV/m)	MARGIN (dB)	ANTENNA HEIGHT (m)	TABLE ANGLE (Degree)	RAW VALUE (dBuV)	CORRECTION FACTOR (dB/m)
1	#5715.00	65.5 PK	74.0	-8.5	3.16 H	75	53.97	11.53
2	#5715.00	49.7 AV	54.0	-4.3	3.16 H	75	38.17	11.53
3	#5725.00	69.8 PK	78.2	-8.4	3.16 H	75	58.25	11.55
4	*5755.00	103.0 PK			3.16 H	75	91.36	11.64
5	*5755.00	92.6 AV			3.16 H	75	80.96	11.64
6	11510.00	50.2 PK	74.0	-23.8	1.62 H	201	32.90	17.30
7	11510.00	37.3 AV	54.0	-16.7	1.62 H	201	20.00	17.30
8	#17265.00	52.1 PK	74.0	-21.9	1.59 H	326	25.39	26.71
9	#17265.00	40.9 AV	54.0	-13.1	1.59 H	326	14.19	26.71

ANTENNA POLARITY & TEST DISTANCE: VERTICAL AT 3 M

NO.	FREQ. (MHz)	EMISSION LEVEL (dBuV/m)	LIMIT (dBuV/m)	MARGIN (dB)	ANTENNA HEIGHT (m)	TABLE ANGLE (Degree)	RAW VALUE (dBuV)	CORRECTION FACTOR (dB/m)
1	#5715.00	69.0 PK	74.0	-5.0	2.07 V	278	57.47	11.53
2	#5715.00	53.0 AV	54.0	-1.0	2.07 V	278	41.47	11.53
3	#5725.00	73.0 PK	78.2	-5.2	2.07 V	278	61.45	11.55
4	*5755.00	108.7 PK			2.07 V	278	97.06	11.64
5	*5755.00	96.4 AV			2.07 V	278	84.76	11.64
6	11510.00	50.2 PK	74.0	-23.8	1.74 V	219	32.90	17.30
7	11510.00	36.9 AV	54.0	-17.1	1.74 V	219	19.60	17.30
8	#17265.00	51.4 PK	74.0	-22.6	1.56 V	144	24.69	26.71
9	#17265.00	41.4 AV	54.0	-12.6	1.56 V	144	14.69	26.71

REMARKS:

1. Emission Level(dBuV/m) = Raw Value(dBuV) + Correction Factor(dB/m)
2. Correction Factor(dB/m) = Antenna Factor(dB/m) + Cable Factor(dB) – Pre-Amplifier Factor(dB)
3. The other emission levels were very low against the limit.
4. Margin value = Emission Level – Limit value
5. " * ": Fundamental frequency.
6. " # ": The radiated frequency is out of the restricted band.

CHANNEL	TX Channel 159	DETECTOR FUNCTION	Peak (PK)
FREQUENCY RANGE	1GHz ~ 40GHz		Average (AV)

ANTENNA POLARITY & TEST DISTANCE: HORIZONTAL AT 3 M

NO.	FREQ. (MHz)	EMISSION LEVEL (dBuV/m)	LIMIT (dBuV/m)	MARGIN (dB)	ANTENNA HEIGHT (m)	TABLE ANGLE (Degree)	RAW VALUE (dBuV)	CORRECTION FACTOR (dB/m)
1	*5795.00	105.4 PK			3.25 H	85	93.62	11.78
2	*5795.00	95.5 AV			3.25 H	85	83.72	11.78
3	#5850.00	58.1 PK	78.2	-20.1	3.25 H	85	46.35	11.75
4	#5860.00	56.2 PK	74.0	-17.8	3.25 H	85	44.45	11.75
5	#5860.00	41.9 AV	54.0	-12.1	3.25 H	85	30.15	11.75
6	11590.00	49.8 PK	74.0	-24.2	1.65 H	228	31.69	18.11
7	11590.00	36.6 AV	54.0	-17.4	1.65 H	228	18.49	18.11
8	#17385.00	51.7 PK	74.0	-22.3	1.53 H	311	24.25	27.45
9	#17385.00	40.5 AV	54.0	-13.5	1.53 H	311	13.05	27.45

ANTENNA POLARITY & TEST DISTANCE: VERTICAL AT 3 M

NO.	FREQ. (MHz)	EMISSION LEVEL (dBuV/m)	LIMIT (dBuV/m)	MARGIN (dB)	ANTENNA HEIGHT (m)	TABLE ANGLE (Degree)	RAW VALUE (dBuV)	CORRECTION FACTOR (dB/m)
1	*5795.00	111.3 PK			2.07 V	277	99.52	11.78
2	*5795.00	98.8 AV			2.07 V	277	87.02	11.78
3	#5850.00	61.6 PK	78.2	-16.6	2.07 V	277	49.85	11.75
4	#5860.00	59.6 PK	74.0	-14.4	2.07 V	277	47.85	11.75
5	#5860.00	44.6 AV	54.0	-9.4	2.07 V	277	32.85	11.75
6	11590.00	51.1 PK	74.0	-22.9	1.77 V	210	32.99	18.11
7	11590.00	37.7 AV	54.0	-16.3	1.77 V	210	19.59	18.11
8	#17385.00	52.1 PK	74.0	-21.9	1.52 V	145	24.65	27.45
9	#17385.00	41.7 AV	54.0	-12.3	1.52 V	145	14.25	27.45

REMARKS:

1. Emission Level(dBuV/m) = Raw Value(dBuV) + Correction Factor(dB/m)
2. Correction Factor(dB/m) = Antenna Factor(dB/m) + Cable Factor(dB) – Pre-Amplifier Factor(dB)
3. The other emission levels were very low against the limit.
4. Margin value = Emission Level – Limit value
5. " * ": Fundamental frequency.
6. " # ": The radiated frequency is out of the restricted band.

802.11ac (VHT80)

CHANNEL	TX Channel 42	DETECTOR FUNCTION	Peak (PK)
FREQUENCY RANGE	1GHz ~ 40GHz		Average (AV)

ANTENNA POLARITY & TEST DISTANCE: HORIZONTAL AT 3 M

NO.	FREQ. (MHz)	EMISSION LEVEL (dBuV/m)	LIMIT (dBuV/m)	MARGIN (dB)	ANTENNA HEIGHT (m)	TABLE ANGLE (Degree)	RAW VALUE (dBuV)	CORRECTION FACTOR (dB/m)
1	5150.00	66.7 PK	74.0	-7.3	3.20 H	67	56.73	9.97
2	5150.00	50.1 AV	54.0	-3.9	3.20 H	67	40.13	9.97
3	*5210.00	93.7 PK			3.20 H	67	83.43	10.27
4	*5210.00	88.9 AV			3.20 H	67	78.63	10.27
5	5350.00	53.0 PK	74.0	-21.0	3.20 H	67	42.45	10.55
6	5350.00	38.9 AV	54.0	-15.1	3.20 H	67	28.35	10.55
7	#10420.00	49.3 PK	74.0	-24.7	1.71 H	222	32.32	16.98
8	#10420.00	36.5 AV	54.0	-17.5	1.71 H	222	19.52	16.98
9	15630.00	52.0 PK	74.0	-22.0	1.51 H	303	29.63	22.37
10	15630.00	40.6 AV	54.0	-13.4	1.51 H	303	18.23	22.37

ANTENNA POLARITY & TEST DISTANCE: VERTICAL AT 3 M

NO.	FREQ. (MHz)	EMISSION LEVEL (dBuV/m)	LIMIT (dBuV/m)	MARGIN (dB)	ANTENNA HEIGHT (m)	TABLE ANGLE (Degree)	RAW VALUE (dBuV)	CORRECTION FACTOR (dB/m)
1	5150.00	70.1 PK	74.0	-3.9	2.05 V	298	60.13	9.97
2	5150.00	53.5 AV	54.0	-0.5	2.05 V	298	43.53	9.97
3	*5210.00	106.0 PK			2.05 V	298	95.73	10.27
4	*5210.00	92.7 AV			2.05 V	298	82.43	10.27
5	5350.00	56.4 PK	74.0	-17.6	2.05 V	298	45.85	10.55
6	5350.00	42.5 AV	54.0	-11.5	2.05 V	298	31.95	10.55
7	#10420.00	51.2 PK	74.0	-22.8	1.72 V	210	34.22	16.98
8	#10420.00	37.8 AV	54.0	-16.2	1.72 V	210	20.82	16.98
9	15630.00	51.6 PK	74.0	-22.4	1.53 V	149	29.23	22.37
10	15630.00	41.4 AV	54.0	-12.6	1.53 V	149	19.03	22.37

REMARKS:

1. Emission Level(dBuV/m) = Raw Value(dBuV) + Correction Factor(dB/m)
2. Correction Factor(dB/m) = Antenna Factor(dB/m) + Cable Factor(dB) – Pre-Amplifier Factor(dB)
3. The other emission levels were very low against the limit.
4. Margin value = Emission Level – Limit value
5. " * ": Fundamental frequency.
6. " # ": The radiated frequency is out of the restricted band.

CHANNEL	TX Channel 155	DETECTOR FUNCTION	Peak (PK)
FREQUENCY RANGE	1GHz ~ 40GHz		Average (AV)

ANTENNA POLARITY & TEST DISTANCE: HORIZONTAL AT 3 M

NO.	FREQ. (MHz)	EMISSION LEVEL (dBuV/m)	LIMIT (dBuV/m)	MARGIN (dB)	ANTENNA HEIGHT (m)	TABLE ANGLE (Degree)	RAW VALUE (dBuV)	CORRECTION FACTOR (dB/m)
1	#5715.00	61.5 PK	74.0	-12.5	3.15 H	72	49.97	11.53
2	#5715.00	47.2 AV	54.0	-6.8	3.15 H	72	35.67	11.53
3	#5725.00	68.0 PK	78.2	-10.2	3.15 H	72	56.45	11.55
4	*5775.00	92.3 PK			3.15 H	72	80.58	11.72
5	*5775.00	88.2 AV			3.15 H	72	76.48	11.72
6	#5850.00	50.3 PK	78.2	-27.9	3.15 H	72	38.55	11.75
7	#5860.00	49.2 PK	74.0	-24.8	3.15 H	72	37.45	11.75
8	#5860.00	38.1 AV	54.0	-15.9	3.15 H	72	26.35	11.75
9	11550.00	50.0 PK	74.0	-24.0	1.67 H	228	32.29	17.71
10	11550.00	37.2 AV	54.0	-16.8	1.67 H	228	19.49	17.71
11	#17325.00	52.3 PK	74.0	-21.7	1.57 H	317	25.45	26.85
12	#17325.00	40.9 AV	54.0	-13.1	1.57 H	317	14.05	26.85

ANTENNA POLARITY & TEST DISTANCE: VERTICAL AT 3 M

NO.	FREQ. (MHz)	EMISSION LEVEL (dBuV/m)	LIMIT (dBuV/m)	MARGIN (dB)	ANTENNA HEIGHT (m)	TABLE ANGLE (Degree)	RAW VALUE (dBuV)	CORRECTION FACTOR (dB/m)
1	#5715.00	67.6 PK	74.0	-6.4	2.06 V	278	56.07	11.53
2	#5715.00	53.2 AV	54.0	-0.8	2.06 V	278	41.67	11.53
3	#5725.00	74.1 PK	78.2	-4.1	2.06 V	278	62.55	11.55
4	*5775.00	104.6 PK			2.06 V	278	92.88	11.72
5	*5775.00	93.3 AV			2.06 V	278	81.58	11.72
6	#5850.00	56.7 PK	78.2	-21.5	2.06 V	278	44.95	11.75
7	#5860.00	54.9 PK	74.0	-19.1	2.06 V	278	43.15	11.75
8	#5860.00	40.5 AV	54.0	-13.5	2.06 V	278	28.75	11.75
9	11550.00	50.3 PK	74.0	-23.7	1.74 V	204	32.59	17.71
10	11550.00	37.4 AV	54.0	-16.6	1.74 V	204	19.69	17.71
11	#17325.00	51.8 PK	74.0	-22.2	1.53 V	161	24.95	26.85
12	#17325.00	41.5 AV	54.0	-12.5	1.53 V	161	14.65	26.85

REMARKS:

1. Emission Level(dBuV/m) = Raw Value(dBuV) + Correction Factor(dB/m)
2. Correction Factor(dB/m) = Antenna Factor(dB/m) + Cable Factor(dB) – Pre-Amplifier Factor(dB)
3. The other emission levels were very low against the limit.
4. Margin value = Emission Level – Limit value
5. " * ": Fundamental frequency.
6. " # ": The radiated frequency is out of the restricted band.

4.1.8 Test Results (Mode 2)

Above 1GHz Data:

802.11a

CHANNEL	TX Channel 36	DETECTOR FUNCTION	Peak (PK)
FREQUENCY RANGE	1GHz ~ 40GHz		Average (AV)

ANTENNA POLARITY & TEST DISTANCE: HORIZONTAL AT 3 M

NO.	FREQ. (MHz)	EMISSION LEVEL (dBuV/m)	LIMIT (dBuV/m)	MARGIN (dB)	ANTENNA HEIGHT (m)	TABLE ANGLE (Degree)	RAW VALUE (dBuV)	CORRECTION FACTOR (dB/m)
1	5150.00	56.8 PK	74.0	-17.2	1.96 H	22	46.83	9.97
2	5150.00	41.9 AV	54.0	-12.1	1.96 H	22	31.93	9.97
3	*5180.00	105.4 PK			1.96 H	22	95.24	10.16
4	*5180.00	94.4 AV			1.96 H	22	84.24	10.16
5	#10360.00	49.2 PK	74.0	-24.8	1.61 H	202	32.22	16.98
6	#10360.00	36.6 AV	54.0	-17.4	1.61 H	202	19.62	16.98
7	15540.00	50.4 PK	74.0	-23.6	1.47 H	299	28.47	21.93
8	15540.00	39.6 AV	54.0	-14.4	1.47 H	299	17.67	21.93

ANTENNA POLARITY & TEST DISTANCE: VERTICAL AT 3 M

NO.	FREQ. (MHz)	EMISSION LEVEL (dBuV/m)	LIMIT (dBuV/m)	MARGIN (dB)	ANTENNA HEIGHT (m)	TABLE ANGLE (Degree)	RAW VALUE (dBuV)	CORRECTION FACTOR (dB/m)
1	5150.00	63.9 PK	74.0	-10.1	2.05 V	123	53.93	9.97
2	5150.00	48.8 AV	54.0	-5.2	2.05 V	123	38.83	9.97
3	*5180.00	114.8 PK			2.05 V	123	104.64	10.16
4	*5180.00	103.9 AV			2.05 V	123	93.74	10.16
5	#10360.00	50.6 PK	74.0	-23.4	1.68 V	243	33.62	16.98
6	#10360.00	37.4 AV	54.0	-16.6	1.68 V	243	20.42	16.98
7	15540.00	51.2 PK	74.0	-22.8	1.53 V	158	29.27	21.93
8	15540.00	41.1 AV	54.0	-12.9	1.53 V	158	19.17	21.93

REMARKS:

1. Emission Level(dBuV/m) = Raw Value(dBuV) + Correction Factor(dB/m)
2. Correction Factor(dB/m) = Antenna Factor(dB/m) + Cable Factor(dB) – Pre-Amplifier Factor(dB)
3. The other emission levels were very low against the limit.
4. Margin value = Emission Level – Limit value
5. " * ": Fundamental frequency.
6. " # ": The radiated frequency is out of the restricted band.

CHANNEL	TX Channel 40	DETECTOR FUNCTION	Peak (PK)
FREQUENCY RANGE	1GHz ~ 40GHz		Average (AV)

ANTENNA POLARITY & TEST DISTANCE: HORIZONTAL AT 3 M

NO.	FREQ. (MHz)	EMISSION LEVEL (dBuV/m)	LIMIT (dBuV/m)	MARGIN (dB)	ANTENNA HEIGHT (m)	TABLE ANGLE (Degree)	RAW VALUE (dBuV)	CORRECTION FACTOR (dB/m)
1	*5200.00	105.0 PK			1.97 H	30	94.74	10.26
2	*5200.00	93.9 AV			1.97 H	30	83.64	10.26
3	#10400.00	49.4 PK	74.0	-24.6	1.68 H	215	32.34	17.06
4	#10400.00	36.7 AV	54.0	-17.3	1.68 H	215	19.64	17.06
5	15600.00	51.1 PK	74.0	-22.9	1.53 H	312	28.82	22.28
6	15600.00	40.1 AV	54.0	-13.9	1.53 H	312	17.82	22.28

ANTENNA POLARITY & TEST DISTANCE: VERTICAL AT 3 M

NO.	FREQ. (MHz)	EMISSION LEVEL (dBuV/m)	LIMIT (dBuV/m)	MARGIN (dB)	ANTENNA HEIGHT (m)	TABLE ANGLE (Degree)	RAW VALUE (dBuV)	CORRECTION FACTOR (dB/m)
1	*5200.00	114.6 PK			2.05 V	125	104.34	10.26
2	*5200.00	103.9 AV			2.05 V	125	93.64	10.26
3	#10400.00	50.0 PK	74.0	-24.0	1.72 V	213	32.94	17.06
4	#10400.00	36.7 AV	54.0	-17.3	1.72 V	213	19.64	17.06
5	15600.00	50.6 PK	74.0	-23.4	1.55 V	178	28.32	22.28
6	15600.00	40.8 AV	54.0	-13.2	1.55 V	178	18.52	22.28

REMARKS:

1. Emission Level(dBuV/m) = Raw Value(dBuV) + Correction Factor(dB/m)
2. Correction Factor(dB/m) = Antenna Factor(dB/m) + Cable Factor(dB) – Pre-Amplifier Factor(dB)
3. The other emission levels were very low against the limit.
4. Margin value = Emission Level – Limit value
5. " * ": Fundamental frequency.
6. " # ": The radiated frequency is out of the restricted band.

CHANNEL	TX Channel 48	DETECTOR FUNCTION	Peak (PK)
FREQUENCY RANGE	1GHz ~ 40GHz		Average (AV)

ANTENNA POLARITY & TEST DISTANCE: HORIZONTAL AT 3 M

NO.	FREQ. (MHz)	EMISSION LEVEL (dBuV/m)	LIMIT (dBuV/m)	MARGIN (dB)	ANTENNA HEIGHT (m)	TABLE ANGLE (Degree)	RAW VALUE (dBuV)	CORRECTION FACTOR (dB/m)
1	*5240.00	106.2 PK			1.88 H	42	95.87	10.33
2	*5240.00	94.4 AV			1.88 H	42	84.07	10.33
3	5350.00	51.0 PK	74.0	-23.0	1.88 H	42	40.45	10.55
4	5350.00	37.8 AV	54.0	-16.2	1.88 H	42	27.25	10.55
5	#10480.00	49.3 PK	74.0	-24.7	1.58 H	187	32.57	16.73
6	#10480.00	36.9 AV	54.0	-17.1	1.58 H	187	20.17	16.73
7	15720.00	51.0 PK	74.0	-23.0	1.49 H	285	28.37	22.63
8	15720.00	39.9 AV	54.0	-14.1	1.49 H	285	17.27	22.63

ANTENNA POLARITY & TEST DISTANCE: VERTICAL AT 3 M

NO.	FREQ. (MHz)	EMISSION LEVEL (dBuV/m)	LIMIT (dBuV/m)	MARGIN (dB)	ANTENNA HEIGHT (m)	TABLE ANGLE (Degree)	RAW VALUE (dBuV)	CORRECTION FACTOR (dB/m)
1	*5240.00	115.7 PK			2.04 V	130	105.37	10.33
2	*5240.00	104.3 AV			2.04 V	130	93.97	10.33
3	5350.00	58.0 PK	74.0	-16.0	2.04 V	130	47.45	10.55
4	5350.00	44.7 AV	54.0	-9.3	2.04 V	130	34.15	10.55
5	#10480.00	50.6 PK	74.0	-23.4	1.67 V	223	33.87	16.73
6	#10480.00	37.1 AV	54.0	-16.9	1.67 V	223	20.37	16.73
7	15720.00	51.3 PK	74.0	-22.7	1.56 V	188	28.67	22.63
8	15720.00	41.3 AV	54.0	-12.7	1.56 V	188	18.67	22.63

REMARKS:

1. Emission Level(dBuV/m) = Raw Value(dBuV) + Correction Factor(dB/m)
2. Correction Factor(dB/m) = Antenna Factor(dB/m) + Cable Factor(dB) – Pre-Amplifier Factor(dB)
3. The other emission levels were very low against the limit.
4. Margin value = Emission Level – Limit value
5. " * ": Fundamental frequency.
6. " # ": The radiated frequency is out of the restricted band.

CHANNEL	TX Channel 149	DETECTOR FUNCTION	Peak (PK)
FREQUENCY RANGE	1GHz ~ 40GHz		Average (AV)

ANTENNA POLARITY & TEST DISTANCE: HORIZONTAL AT 3 M

NO.	FREQ. (MHz)	EMISSION LEVEL (dBuV/m)	LIMIT (dBuV/m)	MARGIN (dB)	ANTENNA HEIGHT (m)	TABLE ANGLE (Degree)	RAW VALUE (dBuV)	CORRECTION FACTOR (dB/m)
1	#5715.00	57.4 PK	74.0	-16.6	1.91 H	68	45.87	11.53
2	#5715.00	41.3 AV	54.0	-12.7	1.91 H	68	29.77	11.53
3	#5725.00	70.2 PK	78.2	-8.0	1.91 H	68	58.65	11.55
4	*5745.00	105.4 PK			1.91 H	68	93.77	11.63
5	*5745.00	94.1 AV			1.91 H	68	82.47	11.63
6	11490.00	49.5 PK	74.0	-24.5	1.62 H	192	32.20	17.30
7	11490.00	36.7 AV	54.0	-17.3	1.62 H	192	19.40	17.30
8	#17235.00	51.0 PK	74.0	-23.0	1.53 H	283	24.19	26.81
9	#17235.00	40.0 AV	54.0	-14.0	1.53 H	283	13.19	26.81

ANTENNA POLARITY & TEST DISTANCE: VERTICAL AT 3 M

NO.	FREQ. (MHz)	EMISSION LEVEL (dBuV/m)	LIMIT (dBuV/m)	MARGIN (dB)	ANTENNA HEIGHT (m)	TABLE ANGLE (Degree)	RAW VALUE (dBuV)	CORRECTION FACTOR (dB/m)
1	#5715.00	64.3 PK	74.0	-9.7	1.91 V	124	52.77	11.53
2	#5715.00	48.2 AV	54.0	-5.8	1.91 V	124	36.67	11.53
3	#5725.00	77.5 PK	78.2	-0.7	1.91 V	124	65.95	11.55
4	*5745.00	114.8 PK			1.91 V	124	103.17	11.63
5	*5745.00	104.0 AV			1.91 V	124	92.37	11.63
6	11490.00	50.5 PK	74.0	-23.5	1.77 V	206	33.20	17.30
7	11490.00	37.1 AV	54.0	-16.9	1.77 V	206	19.80	17.30
8	#17235.00	50.3 PK	74.0	-23.7	1.56 V	178	23.49	26.81
9	#17235.00	40.6 AV	54.0	-13.4	1.56 V	178	13.79	26.81

REMARKS:

1. Emission Level(dBuV/m) = Raw Value(dBuV) + Correction Factor(dB/m)
2. Correction Factor(dB/m) = Antenna Factor(dB/m) + Cable Factor(dB) – Pre-Amplifier Factor(dB)
3. The other emission levels were very low against the limit.
4. Margin value = Emission Level – Limit value
5. " * ": Fundamental frequency.
6. " # ": The radiated frequency is out of the restricted band.

CHANNEL	TX Channel 157	DETECTOR FUNCTION	Peak (PK)
FREQUENCY RANGE	1GHz ~ 40GHz		Average (AV)

ANTENNA POLARITY & TEST DISTANCE: HORIZONTAL AT 3 M

NO.	FREQ. (MHz)	EMISSION LEVEL (dBuV/m)	LIMIT (dBuV/m)	MARGIN (dB)	ANTENNA HEIGHT (m)	TABLE ANGLE (Degree)	RAW VALUE (dBuV)	CORRECTION FACTOR (dB/m)
1	#5715.00	53.5 PK	74.0	-20.5	2.00 H	46	41.97	11.53
2	#5715.00	41.3 AV	54.0	-12.7	2.00 H	46	29.77	11.53
3	#5725.00	54.5 PK	78.2	-23.7	2.00 H	46	42.95	11.55
4	*5785.00	106.1 PK			2.00 H	46	94.36	11.74
5	*5785.00	94.6 AV			2.00 H	46	82.86	11.74
6	#5850.00	52.6 PK	78.2	-25.6	2.00 H	46	40.85	11.75
7	#5860.00	51.8 PK	74.0	-22.2	2.00 H	46	40.05	11.75
8	#5860.00	37.1 AV	54.0	-16.9	2.00 H	46	25.35	11.75
9	11570.00	49.4 PK	74.0	-24.6	1.64 H	200	31.49	17.91
10	11570.00	36.7 AV	54.0	-17.3	1.64 H	200	18.79	17.91
11	#17355.00	50.8 PK	74.0	-23.2	1.43 H	310	23.66	27.14
12	#17355.00	40.0 AV	54.0	-14.0	1.43 H	310	12.86	27.14

ANTENNA POLARITY & TEST DISTANCE: VERTICAL AT 3 M

NO.	FREQ. (MHz)	EMISSION LEVEL (dBuV/m)	LIMIT (dBuV/m)	MARGIN (dB)	ANTENNA HEIGHT (m)	TABLE ANGLE (Degree)	RAW VALUE (dBuV)	CORRECTION FACTOR (dB/m)
1	#5715.00	60.7 PK	74.0	-13.3	1.95 V	135	49.17	11.53
2	#5715.00	47.2 AV	54.0	-6.8	1.95 V	135	35.67	11.53
3	#5725.00	61.3 PK	78.2	-16.9	1.95 V	135	49.75	11.55
4	*5785.00	115.5 PK			1.95 V	135	103.76	11.74
5	*5785.00	104.4 AV			1.95 V	135	92.66	11.74
6	#5850.00	56.4 PK	78.2	-21.8	1.95 V	135	44.65	11.75
7	#5860.00	55.9 PK	74.0	-18.1	1.95 V	135	44.15	11.75
8	#5860.00	42.4 AV	54.0	-11.6	1.95 V	135	30.65	11.75
9	11570.00	50.3 PK	74.0	-23.7	1.73 V	241	32.39	17.91
10	11570.00	36.7 AV	54.0	-17.3	1.73 V	241	18.79	17.91
11	#17355.00	50.8 PK	74.0	-23.2	1.62 V	176	23.66	27.14
12	#17355.00	40.7 AV	54.0	-13.3	1.62 V	176	13.56	27.14

REMARKS:

1. Emission Level(dBuV/m) = Raw Value(dBuV) + Correction Factor(dB/m)
2. Correction Factor(dB/m) = Antenna Factor(dB/m) + Cable Factor(dB) – Pre-Amplifier Factor(dB)
3. The other emission levels were very low against the limit.
4. Margin value = Emission Level – Limit value
5. " * ": Fundamental frequency.
6. " # ": The radiated frequency is out of the restricted band.

CHANNEL	TX Channel 165	DETECTOR FUNCTION	Peak (PK)
FREQUENCY RANGE	1GHz ~ 40GHz		Average (AV)

ANTENNA POLARITY & TEST DISTANCE: HORIZONTAL AT 3 M

NO.	FREQ. (MHz)	EMISSION LEVEL (dBuV/m)	LIMIT (dBuV/m)	MARGIN (dB)	ANTENNA HEIGHT (m)	TABLE ANGLE (Degree)	RAW VALUE (dBuV)	CORRECTION FACTOR (dB/m)
1	*5825.00	105.9 PK			2.05 H	58	94.12	11.78
2	*5825.00	94.6 AV			2.05 H	58	82.82	11.78
3	#5850.00	58.3 PK	78.2	-19.9	2.05 H	58	46.55	11.75
4	#5860.00	55.4 PK	74.0	-18.6	2.05 H	58	43.65	11.75
5	#5860.00	40.1 AV	54.0	-13.9	2.05 H	58	28.35	11.75
6	11650.00	49.5 PK	74.0	-24.5	1.57 H	214	31.34	18.16
7	11650.00	36.7 AV	54.0	-17.3	1.57 H	214	18.54	18.16
8	#17475.00	50.3 PK	74.0	-23.7	1.44 H	290	22.38	27.92
9	#17475.00	39.5 AV	54.0	-14.5	1.44 H	290	11.58	27.92

ANTENNA POLARITY & TEST DISTANCE: VERTICAL AT 3 M

NO.	FREQ. (MHz)	EMISSION LEVEL (dBuV/m)	LIMIT (dBuV/m)	MARGIN (dB)	ANTENNA HEIGHT (m)	TABLE ANGLE (Degree)	RAW VALUE (dBuV)	CORRECTION FACTOR (dB/m)
1	*5825.00	115.3 PK			2.00 V	122	103.52	11.78
2	*5825.00	104.3 AV			2.00 V	122	92.52	11.78
3	#5850.00	65.4 PK	78.2	-12.8	2.00 V	122	53.65	11.75
4	#5860.00	59.6 PK	74.0	-14.4	2.00 V	122	47.85	11.75
5	#5860.00	46.3 AV	54.0	-7.7	2.00 V	122	34.55	11.75
6	11650.00	50.2 PK	74.0	-23.8	1.75 V	223	32.04	18.16
7	11650.00	36.8 AV	54.0	-17.2	1.75 V	223	18.64	18.16
8	#17475.00	50.0 PK	74.0	-24.0	1.51 V	165	22.08	27.92
9	#17475.00	40.4 AV	54.0	-13.6	1.51 V	165	12.48	27.92

REMARKS:

1. Emission Level(dBuV/m) = Raw Value(dBuV) + Correction Factor(dB/m)
2. Correction Factor(dB/m) = Antenna Factor(dB/m) + Cable Factor(dB) – Pre-Amplifier Factor(dB)
3. The other emission levels were very low against the limit.
4. Margin value = Emission Level – Limit value
5. " * ": Fundamental frequency.
6. " # ": The radiated frequency is out of the restricted band.

802.11ac (VHT20)

CHANNEL	TX Channel 36	DETECTOR FUNCTION	Peak (PK)
FREQUENCY RANGE	1GHz ~ 40GHz		Average (AV)

ANTENNA POLARITY & TEST DISTANCE: HORIZONTAL AT 3 M								
NO.	FREQ. (MHz)	EMISSION LEVEL (dBuV/m)	LIMIT (dBuV/m)	MARGIN (dB)	ANTENNA HEIGHT (m)	TABLE ANGLE (Degree)	RAW VALUE (dBuV)	CORRECTION FACTOR (dB/m)
1	5150.00	60.0 PK	74.0	-14.0	2.10 H	87	50.03	9.97
2	5150.00	44.7 AV	54.0	-9.3	2.10 H	87	34.73	9.97
3	*5180.00	104.8 PK			2.10 H	87	94.64	10.16
4	*5180.00	93.8 AV			2.10 H	87	83.64	10.16
5	#10360.00	49.2 PK	74.0	-24.8	1.67 H	196	32.22	16.98
6	#10360.00	36.7 AV	54.0	-17.3	1.67 H	196	19.72	16.98
7	15540.00	50.1 PK	74.0	-23.9	1.48 H	289	28.17	21.93
8	15540.00	39.6 AV	54.0	-14.4	1.48 H	289	17.67	21.93

ANTENNA POLARITY & TEST DISTANCE: VERTICAL AT 3 M								
NO.	FREQ. (MHz)	EMISSION LEVEL (dBuV/m)	LIMIT (dBuV/m)	MARGIN (dB)	ANTENNA HEIGHT (m)	TABLE ANGLE (Degree)	RAW VALUE (dBuV)	CORRECTION FACTOR (dB/m)
1	5150.00	67.1 PK	74.0	-6.9	1.95 V	122	57.13	9.97
2	5150.00	51.3 AV	54.0	-2.7	1.95 V	122	41.33	9.97
3	*5180.00	114.3 PK			1.95 V	122	104.14	10.16
4	*5180.00	103.6 AV			1.95 V	122	93.44	10.16
5	#10360.00	50.1 PK	74.0	-23.9	1.74 V	209	33.12	16.98
6	#10360.00	37.0 AV	54.0	-17.0	1.74 V	209	20.02	16.98
7	15540.00	50.5 PK	74.0	-23.5	1.55 V	194	28.57	21.93
8	15540.00	40.8 AV	54.0	-13.2	1.55 V	194	18.87	21.93

REMARKS:

1. Emission Level(dBuV/m) = Raw Value(dBuV) + Correction Factor(dB/m)
2. Correction Factor(dB/m) = Antenna Factor(dB/m) + Cable Factor(dB) – Pre-Amplifier Factor(dB)
3. The other emission levels were very low against the limit.
4. Margin value = Emission Level – Limit value
5. " * ": Fundamental frequency.
6. " # ": The radiated frequency is out of the restricted band.

CHANNEL	TX Channel 40	DETECTOR FUNCTION	Peak (PK)
FREQUENCY RANGE	1GHz ~ 40GHz		Average (AV)

ANTENNA POLARITY & TEST DISTANCE: HORIZONTAL AT 3 M

NO.	FREQ. (MHz)	EMISSION LEVEL (dBuV/m)	LIMIT (dBuV/m)	MARGIN (dB)	ANTENNA HEIGHT (m)	TABLE ANGLE (Degree)	RAW VALUE (dBuV)	CORRECTION FACTOR (dB/m)
1	*5200.00	104.7 PK			2.07 H	85	94.44	10.26
2	*5200.00	93.5 AV			2.07 H	85	83.24	10.26
3	#10400.00	49.2 PK	74.0	-24.8	1.58 H	217	32.14	17.06
4	#10400.00	36.9 AV	54.0	-17.1	1.58 H	217	19.84	17.06
5	15600.00	50.5 PK	74.0	-23.5	1.50 H	286	28.22	22.28
6	15600.00	39.8 AV	54.0	-14.2	1.50 H	286	17.52	22.28

ANTENNA POLARITY & TEST DISTANCE: VERTICAL AT 3 M

NO.	FREQ. (MHz)	EMISSION LEVEL (dBuV/m)	LIMIT (dBuV/m)	MARGIN (dB)	ANTENNA HEIGHT (m)	TABLE ANGLE (Degree)	RAW VALUE (dBuV)	CORRECTION FACTOR (dB/m)
1	*5200.00	114.2 PK			1.93 V	127	103.94	10.26
2	*5200.00	103.2 AV			1.93 V	127	92.94	10.26
3	#10400.00	50.4 PK	74.0	-23.6	1.76 V	227	33.34	17.06
4	#10400.00	37.0 AV	54.0	-17.0	1.76 V	227	19.94	17.06
5	15600.00	50.4 PK	74.0	-23.6	1.59 V	189	28.12	22.28
6	15600.00	40.8 AV	54.0	-13.2	1.59 V	189	18.52	22.28

REMARKS:

1. Emission Level(dBuV/m) = Raw Value(dBuV) + Correction Factor(dB/m)
2. Correction Factor(dB/m) = Antenna Factor(dB/m) + Cable Factor(dB) – Pre-Amplifier Factor(dB)
3. The other emission levels were very low against the limit.
4. Margin value = Emission Level – Limit value
5. " * ": Fundamental frequency.
6. " # ": The radiated frequency is out of the restricted band.

CHANNEL	TX Channel 48	DETECTOR FUNCTION	Peak (PK)
FREQUENCY RANGE	1GHz ~ 40GHz		Average (AV)

ANTENNA POLARITY & TEST DISTANCE: HORIZONTAL AT 3 M

NO.	FREQ. (MHz)	EMISSION LEVEL (dBuV/m)	LIMIT (dBuV/m)	MARGIN (dB)	ANTENNA HEIGHT (m)	TABLE ANGLE (Degree)	RAW VALUE (dBuV)	CORRECTION FACTOR (dB/m)
1	*5240.00	105.1 PK			2.14 H	84	94.77	10.33
2	*5240.00	94.1 AV			2.14 H	84	83.77	10.33
3	5350.00	53.4 PK	74.0	-20.6	2.14 H	84	42.85	10.55
4	5350.00	39.7 AV	54.0	-14.3	2.14 H	84	29.15	10.55
5	#10480.00	49.0 PK	74.0	-25.0	1.57 H	212	32.27	16.73
6	#10480.00	36.7 AV	54.0	-17.3	1.57 H	212	19.97	16.73
7	15720.00	50.6 PK	74.0	-23.4	1.49 H	306	27.97	22.63
8	15720.00	40.0 AV	54.0	-14.0	1.49 H	306	17.37	22.63

ANTENNA POLARITY & TEST DISTANCE: VERTICAL AT 3 M

NO.	FREQ. (MHz)	EMISSION LEVEL (dBuV/m)	LIMIT (dBuV/m)	MARGIN (dB)	ANTENNA HEIGHT (m)	TABLE ANGLE (Degree)	RAW VALUE (dBuV)	CORRECTION FACTOR (dB/m)
1	*5240.00	114.5 PK			1.99 V	121	104.17	10.33
2	*5240.00	103.6 AV			1.99 V	121	93.27	10.33
3	5350.00	60.6 PK	74.0	-13.4	1.99 V	121	50.05	10.55
4	5350.00	46.8 AV	54.0	-7.2	1.99 V	121	36.25	10.55
5	#10480.00	49.9 PK	74.0	-24.1	1.77 V	212	33.17	16.73
6	#10480.00	36.7 AV	54.0	-17.3	1.77 V	212	19.97	16.73
7	15720.00	51.2 PK	74.0	-22.8	1.51 V	184	28.57	22.63
8	15720.00	41.1 AV	54.0	-12.9	1.51 V	184	18.47	22.63

REMARKS:

1. Emission Level(dBuV/m) = Raw Value(dBuV) + Correction Factor(dB/m)
2. Correction Factor(dB/m) = Antenna Factor(dB/m) + Cable Factor(dB) – Pre-Amplifier Factor(dB)
3. The other emission levels were very low against the limit.
4. Margin value = Emission Level – Limit value
5. " * ": Fundamental frequency.
6. " # ": The radiated frequency is out of the restricted band.

CHANNEL	TX Channel 149	DETECTOR FUNCTION	Peak (PK)
FREQUENCY RANGE	1GHz ~ 40GHz		Average (AV)

ANTENNA POLARITY & TEST DISTANCE: HORIZONTAL AT 3 M

NO.	FREQ. (MHz)	EMISSION LEVEL (dBuV/m)	LIMIT (dBuV/m)	MARGIN (dB)	ANTENNA HEIGHT (m)	TABLE ANGLE (Degree)	RAW VALUE (dBuV)	CORRECTION FACTOR (dB/m)
1	#5715.00	58.1 PK	74.0	-15.9	2.18 H	99	46.57	11.53
2	#5715.00	41.3 AV	54.0	-12.7	2.18 H	99	29.77	11.53
3	#5725.00	70.1 PK	78.2	-8.1	2.18 H	99	58.55	11.55
4	*5745.00	104.8 PK			2.18 H	99	93.17	11.63
5	*5745.00	93.8 AV			2.18 H	99	82.17	11.63
6	11490.00	49.0 PK	74.0	-25.0	1.65 H	202	31.70	17.30
7	11490.00	36.3 AV	54.0	-17.7	1.65 H	202	19.00	17.30
8	#17235.00	50.5 PK	74.0	-23.5	1.51 H	300	23.69	26.81
9	#17235.00	39.9 AV	54.0	-14.1	1.51 H	300	13.09	26.81

ANTENNA POLARITY & TEST DISTANCE: VERTICAL AT 3 M

NO.	FREQ. (MHz)	EMISSION LEVEL (dBuV/m)	LIMIT (dBuV/m)	MARGIN (dB)	ANTENNA HEIGHT (m)	TABLE ANGLE (Degree)	RAW VALUE (dBuV)	CORRECTION FACTOR (dB/m)
1	#5715.00	65.2 PK	74.0	-8.8	1.98 V	130	53.67	11.53
2	#5715.00	48.6 AV	54.0	-5.4	1.98 V	130	37.07	11.53
3	#5725.00	77.3 PK	78.2	-0.9	1.98 V	130	65.75	11.55
4	*5745.00	114.2 PK			1.98 V	130	102.57	11.63
5	*5745.00	103.5 AV			1.98 V	130	91.87	11.63
6	11490.00	50.3 PK	74.0	-23.7	1.72 V	217	33.00	17.30
7	11490.00	36.7 AV	54.0	-17.3	1.72 V	217	19.40	17.30
8	#17235.00	50.4 PK	74.0	-23.6	1.54 V	188	23.59	26.81
9	#17235.00	40.4 AV	54.0	-13.6	1.54 V	188	13.59	26.81

REMARKS:

1. Emission Level(dBuV/m) = Raw Value(dBuV) + Correction Factor(dB/m)
2. Correction Factor(dB/m) = Antenna Factor(dB/m) + Cable Factor(dB) – Pre-Amplifier Factor(dB)
3. The other emission levels were very low against the limit.
4. Margin value = Emission Level – Limit value
5. " * ": Fundamental frequency.
6. " # ": The radiated frequency is out of the restricted band.

CHANNEL	TX Channel 157	DETECTOR FUNCTION	Peak (PK)
FREQUENCY RANGE	1GHz ~ 40GHz		Average (AV)

ANTENNA POLARITY & TEST DISTANCE: HORIZONTAL AT 3 M

NO.	FREQ. (MHz)	EMISSION LEVEL (dBuV/m)	LIMIT (dBuV/m)	MARGIN (dB)	ANTENNA HEIGHT (m)	TABLE ANGLE (Degree)	RAW VALUE (dBuV)	CORRECTION FACTOR (dB/m)
1	#5715.00	52.6 PK	74.0	-21.4	2.20 H	101	41.07	11.53
2	#5715.00	38.4 AV	54.0	-15.6	2.20 H	101	26.87	11.53
3	#5725.00	52.2 PK	78.2	-26.0	2.20 H	101	40.65	11.55
4	*5785.00	105.3 PK			2.20 H	101	93.56	11.74
5	*5785.00	94.2 AV			2.20 H	101	82.46	11.74
6	#5850.00	52.1 PK	78.2	-26.1	2.20 H	101	40.35	11.75
7	#5860.00	51.5 PK	74.0	-22.5	2.20 H	101	39.75	11.75
8	#5860.00	37.9 AV	54.0	-16.1	2.20 H	101	26.15	11.75
9	11570.00	49.6 PK	74.0	-24.4	1.63 H	211	31.69	17.91
10	11570.00	36.7 AV	54.0	-17.3	1.63 H	211	18.79	17.91
11	#17355.00	51.0 PK	74.0	-23.0	1.46 H	295	23.86	27.14
12	#17355.00	39.7 AV	54.0	-14.3	1.46 H	295	12.56	27.14

ANTENNA POLARITY & TEST DISTANCE: VERTICAL AT 3 M

NO.	FREQ. (MHz)	EMISSION LEVEL (dBuV/m)	LIMIT (dBuV/m)	MARGIN (dB)	ANTENNA HEIGHT (m)	TABLE ANGLE (Degree)	RAW VALUE (dBuV)	CORRECTION FACTOR (dB/m)
1	#5715.00	56.4 PK	74.0	-17.6	1.99 V	139	44.87	11.53
2	#5715.00	43.2 AV	54.0	-10.8	1.99 V	139	31.67	11.53
3	#5725.00	57.3 PK	78.2	-20.9	1.99 V	139	45.75	11.55
4	*5785.00	114.8 PK			1.99 V	139	103.06	11.74
5	*5785.00	103.8 AV			1.99 V	139	92.06	11.74
6	#5850.00	55.9 PK	78.2	-22.3	1.99 V	139	44.15	11.75
7	#5860.00	55.0 PK	74.0	-19.0	1.99 V	139	43.25	11.75
8	#5860.00	41.2 AV	54.0	-12.8	1.99 V	139	29.45	11.75
9	11570.00	49.9 PK	74.0	-24.1	1.65 V	241	31.99	17.91
10	11570.00	36.7 AV	54.0	-17.3	1.65 V	241	18.79	17.91
11	#17355.00	51.5 PK	74.0	-22.5	1.64 V	150	24.36	27.14
12	#17355.00	41.5 AV	54.0	-12.5	1.64 V	150	14.36	27.14

REMARKS:

1. Emission Level(dBuV/m) = Raw Value(dBuV) + Correction Factor(dB/m)
2. Correction Factor(dB/m) = Antenna Factor(dB/m) + Cable Factor(dB) – Pre-Amplifier Factor(dB)
3. The other emission levels were very low against the limit.
4. Margin value = Emission Level – Limit value
5. " * ": Fundamental frequency.
6. " # ": The radiated frequency is out of the restricted band.

CHANNEL	TX Channel 165	DETECTOR FUNCTION	Peak (PK)
FREQUENCY RANGE	1GHz ~ 40GHz		Average (AV)

ANTENNA POLARITY & TEST DISTANCE: HORIZONTAL AT 3 M

NO.	FREQ. (MHz)	EMISSION LEVEL (dBuV/m)	LIMIT (dBuV/m)	MARGIN (dB)	ANTENNA HEIGHT (m)	TABLE ANGLE (Degree)	RAW VALUE (dBuV)	CORRECTION FACTOR (dB/m)
1	*5825.00	104.9 PK			2.24 H	99	93.12	11.78
2	*5825.00	93.7 AV			2.24 H	99	81.92	11.78
3	#5850.00	62.4 PK	78.2	-15.8	2.24 H	99	50.65	11.75
4	#5860.00	52.9 PK	74.0	-21.1	2.24 H	99	41.15	11.75
5	#5860.00	39.6 AV	54.0	-14.4	2.24 H	99	27.85	11.75
6	11650.00	49.2 PK	74.0	-24.8	1.62 H	191	31.04	18.16
7	11650.00	36.9 AV	54.0	-17.1	1.62 H	191	18.74	18.16
8	#17475.00	50.3 PK	74.0	-23.7	1.53 H	306	22.38	27.92
9	#17475.00	39.3 AV	54.0	-14.7	1.53 H	306	11.38	27.92

ANTENNA POLARITY & TEST DISTANCE: VERTICAL AT 3 M

NO.	FREQ. (MHz)	EMISSION LEVEL (dBuV/m)	LIMIT (dBuV/m)	MARGIN (dB)	ANTENNA HEIGHT (m)	TABLE ANGLE (Degree)	RAW VALUE (dBuV)	CORRECTION FACTOR (dB/m)
1	*5825.00	114.5 PK			2.01 V	151	102.72	11.78
2	*5825.00	103.3 AV			2.01 V	151	91.52	11.78
3	#5850.00	69.1 PK	78.2	-9.1	2.01 V	151	57.35	11.75
4	#5860.00	57.3 PK	74.0	-16.7	2.01 V	151	45.55	11.75
5	#5860.00	44.5 AV	54.0	-9.5	2.01 V	151	32.75	11.75
6	11650.00	50.1 PK	74.0	-23.9	1.68 V	237	31.94	18.16
7	11650.00	36.7 AV	54.0	-17.3	1.68 V	237	18.54	18.16
8	#17475.00	50.8 PK	74.0	-23.2	1.53 V	167	22.88	27.92
9	#17475.00	41.0 AV	54.0	-13.0	1.53 V	167	13.08	27.92

REMARKS:

1. Emission Level(dBuV/m) = Raw Value(dBuV) + Correction Factor(dB/m)
2. Correction Factor(dB/m) = Antenna Factor(dB/m) + Cable Factor(dB) – Pre-Amplifier Factor(dB)
3. The other emission levels were very low against the limit.
4. Margin value = Emission Level – Limit value
5. " * ": Fundamental frequency.
6. " # ": The radiated frequency is out of the restricted band.

802.11ac (VHT40)

CHANNEL	TX Channel 38	DETECTOR FUNCTION	Peak (PK)
FREQUENCY RANGE	1GHz ~ 40GHz		Average (AV)

ANTENNA POLARITY & TEST DISTANCE: HORIZONTAL AT 3 M

NO.	FREQ. (MHz)	EMISSION LEVEL (dBuV/m)	LIMIT (dBuV/m)	MARGIN (dB)	ANTENNA HEIGHT (m)	TABLE ANGLE (Degree)	RAW VALUE (dBuV)	CORRECTION FACTOR (dB/m)
1	5150.00	61.5 PK	74.0	-12.5	2.08 H	132	51.53	9.97
2	5150.00	46.7 AV	54.0	-7.3	2.08 H	132	36.73	9.97
3	*5190.00	101.3 PK			2.08 H	132	91.10	10.20
4	*5190.00	88.9 AV			2.08 H	132	78.70	10.20
5	5350.00	52.3 PK	74.0	-21.7	2.08 H	132	41.75	10.55
6	5350.00	37.7 AV	54.0	-16.3	2.08 H	132	27.15	10.55
7	#10380.00	49.3 PK	74.0	-24.7	1.66 H	194	32.28	17.02
8	#10380.00	36.6 AV	54.0	-17.4	1.66 H	194	19.58	17.02
9	15570.00	50.5 PK	74.0	-23.5	1.41 H	309	28.40	22.10
10	15570.00	40.0 AV	54.0	-14.0	1.41 H	309	17.90	22.10

ANTENNA POLARITY & TEST DISTANCE: VERTICAL AT 3 M

NO.	FREQ. (MHz)	EMISSION LEVEL (dBuV/m)	LIMIT (dBuV/m)	MARGIN (dB)	ANTENNA HEIGHT (m)	TABLE ANGLE (Degree)	RAW VALUE (dBuV)	CORRECTION FACTOR (dB/m)
1	5150.00	68.8 PK	74.0	-5.2	2.06 V	126	58.83	9.97
2	5150.00	53.4 AV	54.0	-0.6	2.06 V	126	43.43	9.97
3	*5190.00	110.8 PK			2.06 V	126	100.60	10.20
4	*5190.00	98.5 AV			2.06 V	126	88.30	10.20
5	5350.00	54.2 PK	74.0	-19.8	2.06 V	126	43.65	10.55
6	5350.00	41.1 AV	54.0	-12.9	2.06 V	126	30.55	10.55
7	#10380.00	50.2 PK	74.0	-23.8	1.68 V	202	33.18	17.02
8	#10380.00	37.0 AV	54.0	-17.0	1.68 V	202	19.98	17.02
9	15570.00	50.3 PK	74.0	-23.7	1.53 V	174	28.20	22.10
10	15570.00	40.5 AV	54.0	-13.5	1.53 V	174	18.40	22.10

REMARKS:

- Emission Level(dBuV/m) = Raw Value(dBuV) + Correction Factor(dB/m)
- Correction Factor(dB/m) = Antenna Factor(dB/m) + Cable Factor(dB) – Pre-Amplifier Factor(dB)
- The other emission levels were very low against the limit.
- Margin value = Emission Level – Limit value
- " * ": Fundamental frequency.
- " # ": The radiated frequency is out of the restricted band.

CHANNEL	TX Channel 46	DETECTOR FUNCTION	Peak (PK)
FREQUENCY RANGE	1GHz ~ 40GHz		Average (AV)

ANTENNA POLARITY & TEST DISTANCE: HORIZONTAL AT 3 M

NO.	FREQ. (MHz)	EMISSION LEVEL (dBuV/m)	LIMIT (dBuV/m)	MARGIN (dB)	ANTENNA HEIGHT (m)	TABLE ANGLE (Degree)	RAW VALUE (dBuV)	CORRECTION FACTOR (dB/m)
1	5150.00	52.9 PK	74.0	-21.1	2.00 H	144	42.93	9.97
2	5150.00	38.5 AV	54.0	-15.5	2.00 H	144	28.53	9.97
3	*5230.00	97.8 PK			2.00 H	144	87.48	10.32
4	*5230.00	85.1 AV			2.00 H	144	74.78	10.32
5	5350.00	51.6 PK	74.0	-22.4	2.00 H	144	41.05	10.55
6	5350.00	37.8 AV	54.0	-16.2	2.00 H	144	27.25	10.55
7	#10460.00	49.4 PK	74.0	-24.6	1.56 H	214	32.58	16.82
8	#10460.00	36.7 AV	54.0	-17.3	1.56 H	214	19.88	16.82
9	15690.00	50.9 PK	74.0	-23.1	1.52 H	289	28.38	22.52
10	15690.00	40.0 AV	54.0	-14.0	1.52 H	289	17.48	22.52

ANTENNA POLARITY & TEST DISTANCE: VERTICAL AT 3 M

NO.	FREQ. (MHz)	EMISSION LEVEL (dBuV/m)	LIMIT (dBuV/m)	MARGIN (dB)	ANTENNA HEIGHT (m)	TABLE ANGLE (Degree)	RAW VALUE (dBuV)	CORRECTION FACTOR (dB/m)
1	5150.00	56.4 PK	74.0	-17.6	2.07 V	124	46.43	9.97
2	5150.00	43.6 AV	54.0	-10.4	2.07 V	124	33.63	9.97
3	*5230.00	114.3 PK			2.07 V	124	103.98	10.32
4	*5230.00	102.4 AV			2.07 V	124	92.08	10.32
5	5350.00	54.5 PK	74.0	-19.5	2.07 V	124	43.95	10.55
6	5350.00	42.4 AV	54.0	-11.6	2.07 V	124	31.85	10.55
7	#10460.00	50.1 PK	74.0	-23.9	1.77 V	220	33.28	16.82
8	#10460.00	36.5 AV	54.0	-17.5	1.77 V	220	19.68	16.82
9	15690.00	50.9 PK	74.0	-23.1	1.52 V	175	28.38	22.52
10	15690.00	41.0 AV	54.0	-13.0	1.52 V	175	18.48	22.52

REMARKS:

1. Emission Level(dBuV/m) = Raw Value(dBuV) + Correction Factor(dB/m)
2. Correction Factor(dB/m) = Antenna Factor(dB/m) + Cable Factor(dB) – Pre-Amplifier Factor(dB)
3. The other emission levels were very low against the limit.
4. Margin value = Emission Level – Limit value
5. " * ": Fundamental frequency.
6. " # ": The radiated frequency is out of the restricted band.

CHANNEL	TX Channel 151	DETECTOR FUNCTION	Peak (PK)
FREQUENCY RANGE	1GHz ~ 40GHz		Average (AV)

ANTENNA POLARITY & TEST DISTANCE: HORIZONTAL AT 3 M

NO.	FREQ. (MHz)	EMISSION LEVEL (dBuV/m)	LIMIT (dBuV/m)	MARGIN (dB)	ANTENNA HEIGHT (m)	TABLE ANGLE (Degree)	RAW VALUE (dBuV)	CORRECTION FACTOR (dB/m)
1	#5715.00	62.4 PK	74.0	-11.6	2.06 H	152	50.87	11.53
2	#5715.00	46.8 AV	54.0	-7.2	2.06 H	152	35.27	11.53
3	#5725.00	69.7 PK	78.2	-8.5	2.06 H	152	58.15	11.55
4	*5755.00	94.9 PK			2.06 H	152	83.26	11.64
5	*5755.00	82.8 AV			2.06 H	152	71.16	11.64
6	11510.00	49.4 PK	74.0	-24.6	1.59 H	190	32.10	17.30
7	11510.00	36.9 AV	54.0	-17.1	1.59 H	190	19.60	17.30
8	#17265.00	50.1 PK	74.0	-23.9	1.49 H	308	23.39	26.71
9	#17265.00	39.5 AV	54.0	-14.5	1.49 H	308	12.79	26.71

ANTENNA POLARITY & TEST DISTANCE: VERTICAL AT 3 M

NO.	FREQ. (MHz)	EMISSION LEVEL (dBuV/m)	LIMIT (dBuV/m)	MARGIN (dB)	ANTENNA HEIGHT (m)	TABLE ANGLE (Degree)	RAW VALUE (dBuV)	CORRECTION FACTOR (dB/m)
1	#5715.00	69.6 PK	74.0	-4.4	1.96 V	113	58.07	11.53
2	#5715.00	53.5 AV	54.0	-0.5	1.96 V	113	41.97	11.53
3	#5725.00	76.6 PK	78.2	-1.6	1.96 V	113	65.05	11.55
4	*5755.00	111.2 PK			1.96 V	113	99.56	11.64
5	*5755.00	99.2 AV			1.96 V	113	87.56	11.64
6	11510.00	49.8 PK	74.0	-24.2	1.70 V	200	32.50	17.30
7	11510.00	36.8 AV	54.0	-17.2	1.70 V	200	19.50	17.30
8	#17265.00	50.7 PK	74.0	-23.3	1.59 V	181	23.99	26.71
9	#17265.00	41.1 AV	54.0	-12.9	1.59 V	181	14.39	26.71

REMARKS:

1. Emission Level(dBuV/m) = Raw Value(dBuV) + Correction Factor(dB/m)
2. Correction Factor(dB/m) = Antenna Factor(dB/m) + Cable Factor(dB) – Pre-Amplifier Factor(dB)
3. The other emission levels were very low against the limit.
4. Margin value = Emission Level – Limit value
5. " * ": Fundamental frequency.
6. " # ": The radiated frequency is out of the restricted band.

CHANNEL	TX Channel 159	DETECTOR FUNCTION	Peak (PK)
FREQUENCY RANGE	1GHz ~ 40GHz		Average (AV)

ANTENNA POLARITY & TEST DISTANCE: HORIZONTAL AT 3 M

NO.	FREQ. (MHz)	EMISSION LEVEL (dBuV/m)	LIMIT (dBuV/m)	MARGIN (dB)	ANTENNA HEIGHT (m)	TABLE ANGLE (Degree)	RAW VALUE (dBuV)	CORRECTION FACTOR (dB/m)
1	*5795.00	99.4 PK			2.03 H	145	87.62	11.78
2	*5795.00	87.3 AV			2.03 H	145	75.52	11.78
3	#5850.00	57.3 PK	78.2	-20.9	2.03 H	145	45.55	11.75
4	#5860.00	53.7 PK	74.0	-20.3	2.03 H	145	41.95	11.75
5	#5860.00	40.3 AV	54.0	-13.7	2.03 H	145	28.55	11.75
6	11590.00	48.8 PK	74.0	-25.2	1.64 H	201	30.69	18.11
7	11590.00	36.2 AV	54.0	-17.8	1.64 H	201	18.09	18.11
8	#17385.00	49.9 PK	74.0	-24.1	1.48 H	283	22.45	27.45
9	#17385.00	39.2 AV	54.0	-14.8	1.48 H	283	11.75	27.45

ANTENNA POLARITY & TEST DISTANCE: VERTICAL AT 3 M

NO.	FREQ. (MHz)	EMISSION LEVEL (dBuV/m)	LIMIT (dBuV/m)	MARGIN (dB)	ANTENNA HEIGHT (m)	TABLE ANGLE (Degree)	RAW VALUE (dBuV)	CORRECTION FACTOR (dB/m)
1	*5795.00	115.7 PK			1.95 V	112	103.92	11.78
2	*5795.00	103.6 AV			1.95 V	112	91.82	11.78
3	#5850.00	64.2 PK	78.2	-14.0	1.95 V	112	52.45	11.75
4	#5860.00	60.5 PK	74.0	-13.5	1.95 V	112	48.75	11.75
5	#5860.00	47.9 AV	54.0	-6.1	1.95 V	112	36.15	11.75
6	11590.00	50.5 PK	74.0	-23.5	1.75 V	210	32.39	18.11
7	11590.00	37.0 AV	54.0	-17.0	1.75 V	210	18.89	18.11
8	#17385.00	50.4 PK	74.0	-23.6	1.50 V	180	22.95	27.45
9	#17385.00	40.3 AV	54.0	-13.7	1.50 V	180	12.85	27.45

REMARKS:

1. Emission Level(dBuV/m) = Raw Value(dBuV) + Correction Factor(dB/m)
2. Correction Factor(dB/m) = Antenna Factor(dB/m) + Cable Factor(dB) – Pre-Amplifier Factor(dB)
3. The other emission levels were very low against the limit.
4. Margin value = Emission Level – Limit value
5. " * ": Fundamental frequency.
6. " # ": The radiated frequency is out of the restricted band.

802.11ac (VHT80)

CHANNEL	TX Channel 42	DETECTOR FUNCTION	Peak (PK)
FREQUENCY RANGE	1GHz ~ 40GHz		Average (AV)

ANTENNA POLARITY & TEST DISTANCE: HORIZONTAL AT 3 M

NO.	FREQ. (MHz)	EMISSION LEVEL (dBuV/m)	LIMIT (dBuV/m)	MARGIN (dB)	ANTENNA HEIGHT (m)	TABLE ANGLE (Degree)	RAW VALUE (dBuV)	CORRECTION FACTOR (dB/m)
1	5150.00	60.8 PK	74.0	-13.2	1.98 H	120	50.83	9.97
2	5150.00	45.6 AV	54.0	-8.4	1.98 H	120	35.63	9.97
3	*5210.00	91.3 PK			1.98 H	120	81.03	10.27
4	*5210.00	78.0 AV			1.98 H	120	67.73	10.27
5	5350.00	52.9 PK	74.0	-21.1	1.98 H	120	42.35	10.55
6	5350.00	38.4 AV	54.0	-15.6	1.98 H	120	27.85	10.55
7	#10420.00	48.8 PK	74.0	-25.2	1.60 H	197	31.82	16.98
8	#10420.00	36.2 AV	54.0	-17.8	1.60 H	197	19.22	16.98
9	15630.00	50.8 PK	74.0	-23.2	1.45 H	301	28.43	22.37
10	15630.00	39.7 AV	54.0	-14.3	1.45 H	301	17.33	22.37

ANTENNA POLARITY & TEST DISTANCE: VERTICAL AT 3 M

NO.	FREQ. (MHz)	EMISSION LEVEL (dBuV/m)	LIMIT (dBuV/m)	MARGIN (dB)	ANTENNA HEIGHT (m)	TABLE ANGLE (Degree)	RAW VALUE (dBuV)	CORRECTION FACTOR (dB/m)
1	5150.00	68.0 PK	74.0	-6.0	2.06 V	123	58.03	9.97
2	5150.00	53.4 AV	54.0	-0.6	2.06 V	123	43.43	9.97
3	*5210.00	107.5 PK			2.06 V	123	97.23	10.27
4	*5210.00	94.2 AV			2.06 V	123	83.93	10.27
5	5350.00	55.4 PK	74.0	-18.6	2.06 V	123	44.85	10.55
6	5350.00	42.1 AV	54.0	-11.9	2.06 V	123	31.55	10.55
7	#10420.00	50.3 PK	74.0	-23.7	1.72 V	200	33.32	16.98
8	#10420.00	36.8 AV	54.0	-17.2	1.72 V	200	19.82	16.98
9	15630.00	50.9 PK	74.0	-23.1	1.54 V	176	28.53	22.37
10	15630.00	41.2 AV	54.0	-12.8	1.54 V	176	18.83	22.37

REMARKS:

- Emission Level(dBuV/m) = Raw Value(dBuV) + Correction Factor(dB/m)
- Correction Factor(dB/m) = Antenna Factor(dB/m) + Cable Factor(dB) – Pre-Amplifier Factor(dB)
- The other emission levels were very low against the limit.
- Margin value = Emission Level – Limit value
- " * ": Fundamental frequency.
- " # ": The radiated frequency is out of the restricted band.

CHANNEL	TX Channel 155	DETECTOR FUNCTION	Peak (PK)
FREQUENCY RANGE	1GHz ~ 40GHz		Average (AV)

ANTENNA POLARITY & TEST DISTANCE: HORIZONTAL AT 3 M

NO.	FREQ. (MHz)	EMISSION LEVEL (dBuV/m)	LIMIT (dBuV/m)	MARGIN (dB)	ANTENNA HEIGHT (m)	TABLE ANGLE (Degree)	RAW VALUE (dBuV)	CORRECTION FACTOR (dB/m)
1	#5715.00	63.6 PK	74.0	-10.4	1.89 H	138	52.07	11.53
2	#5715.00	46.6 AV	54.0	-7.4	1.89 H	138	35.07	11.53
3	#5725.00	69.9 PK	78.2	-8.3	1.89 H	138	58.35	11.55
4	*5775.00	89.9 PK			1.89 H	138	78.18	11.72
5	*5775.00	76.9 AV			1.89 H	138	65.18	11.72
6	#5850.00	51.4 PK	78.2	-26.8	1.89 H	138	39.65	11.75
7	#5860.00	51.1 PK	74.0	-22.9	1.89 H	138	39.35	11.75
8	#5860.00	38.1 AV	54.0	-15.9	1.89 H	138	26.35	11.75
9	11550.00	49.5 PK	74.0	-24.5	1.56 H	209	31.79	17.71
10	11550.00	36.8 AV	54.0	-17.2	1.56 H	209	19.09	17.71
11	#17325.00	50.6 PK	74.0	-23.4	1.43 H	299	23.75	26.85
12	#17325.00	40.0 AV	54.0	-14.0	1.43 H	299	13.15	26.85

ANTENNA POLARITY & TEST DISTANCE: VERTICAL AT 3 M

NO.	FREQ. (MHz)	EMISSION LEVEL (dBuV/m)	LIMIT (dBuV/m)	MARGIN (dB)	ANTENNA HEIGHT (m)	TABLE ANGLE (Degree)	RAW VALUE (dBuV)	CORRECTION FACTOR (dB/m)
1	#5715.00	70.7 PK	74.0	-3.3	2.08 V	113	59.17	11.53
2	#5715.00	53.4 AV	54.0	-0.6	2.08 V	113	41.87	11.53
3	#5725.00	76.3 PK	78.2	-1.9	2.08 V	113	64.75	11.55
4	*5775.00	106.1 PK			2.08 V	113	94.38	11.72
5	*5775.00	92.9 AV			2.08 V	113	81.18	11.72
6	#5850.00	53.6 PK	78.2	-24.6	2.08 V	113	41.85	11.75
7	#5860.00	52.8 PK	74.0	-21.2	2.08 V	113	41.05	11.75
8	#5860.00	40.2 AV	54.0	-13.8	2.08 V	113	28.45	11.75
9	11550.00	49.6 PK	74.0	-24.4	1.67 V	212	31.89	17.71
10	11550.00	36.3 AV	54.0	-17.7	1.67 V	212	18.59	17.71
11	#17325.00	51.2 PK	74.0	-22.8	1.50 V	172	24.35	26.85
12	#17325.00	41.2 AV	54.0	-12.8	1.50 V	172	14.35	26.85

REMARKS:

1. Emission Level(dBuV/m) = Raw Value(dBuV) + Correction Factor(dB/m)
2. Correction Factor(dB/m) = Antenna Factor(dB/m) + Cable Factor(dB) – Pre-Amplifier Factor(dB)
3. The other emission levels were very low against the limit.
4. Margin value = Emission Level – Limit value
5. " * ": Fundamental frequency.
6. " # ": The radiated frequency is out of the restricted band.

4.1.9 Test Results (Mode 3)

Above 1GHz Data:

802.11a

CHANNEL	TX Channel 36	DETECTOR FUNCTION	Peak (PK)
FREQUENCY RANGE	1GHz ~ 40GHz		Average (AV)

ANTENNA POLARITY & TEST DISTANCE: HORIZONTAL AT 3 M								
NO.	FREQ. (MHz)	EMISSION LEVEL (dBuV/m)	LIMIT (dBuV/m)	MARGIN (dB)	ANTENNA HEIGHT (m)	TABLE ANGLE (Degree)	RAW VALUE (dBuV)	CORRECTION FACTOR (dB/m)
1	5150.00	61.8 PK	74.0	-12.2	1.86 H	337	53.47	8.33
2	5150.00	46.0 AV	54.0	-8.0	1.86 H	337	37.67	8.33
3	*5180.00	111.8 PK			1.86 H	337	103.33	8.47
4	*5180.00	100.3 AV			1.86 H	337	91.83	8.47
5	#10360.00	48.2 PK	74.0	-25.8	1.77 H	209	33.70	14.50
6	#10360.00	34.0 AV	54.0	-20.0	1.77 H	209	19.50	14.50
7	15540.00	51.4 PK	74.0	-22.6	1.47 H	298	32.72	18.68
8	15540.00	37.8 AV	54.0	-16.2	1.47 H	298	19.12	18.68

ANTENNA POLARITY & TEST DISTANCE: VERTICAL AT 3 M								
NO.	FREQ. (MHz)	EMISSION LEVEL (dBuV/m)	LIMIT (dBuV/m)	MARGIN (dB)	ANTENNA HEIGHT (m)	TABLE ANGLE (Degree)	RAW VALUE (dBuV)	CORRECTION FACTOR (dB/m)
1	5150.00	66.8 PK	74.0	-7.2	2.09 V	107	58.47	8.33
2	5150.00	53.5 AV	54.0	-0.5	2.09 V	107	45.17	8.33
3	*5180.00	117.5 PK			2.09 V	107	109.03	8.47
4	*5180.00	108.2 AV			2.09 V	107	99.73	8.47
5	#10360.00	49.6 PK	74.0	-24.4	1.61 V	212	35.10	14.50
6	#10360.00	35.5 AV	54.0	-18.5	1.61 V	212	21.00	14.50
7	15540.00	50.9 PK	74.0	-23.1	1.54 V	218	32.22	18.68
8	15540.00	37.4 AV	54.0	-16.6	1.54 V	218	18.72	18.68

REMARKS:

1. Emission Level(dBuV/m) = Raw Value(dBuV) + Correction Factor(dB/m)
2. Correction Factor(dB/m) = Antenna Factor(dB/m) + Cable Factor(dB) – Pre-Amplifier Factor(dB)
3. The other emission levels were very low against the limit.
4. Margin value = Emission Level – Limit value
5. " * ": Fundamental frequency.
6. " # ": The radiated frequency is out of the restricted band.

CHANNEL	TX Channel 40	DETECTOR FUNCTION	Peak (PK)
FREQUENCY RANGE	1GHz ~ 40GHz		Average (AV)

ANTENNA POLARITY & TEST DISTANCE: HORIZONTAL AT 3 M

NO.	FREQ. (MHz)	EMISSION LEVEL (dBuV/m)	LIMIT (dBuV/m)	MARGIN (dB)	ANTENNA HEIGHT (m)	TABLE ANGLE (Degree)	RAW VALUE (dBuV)	CORRECTION FACTOR (dB/m)
1	*5200.00	116.7 PK			1.83 H	335	108.16	8.54
2	*5200.00	104.5 AV			1.83 H	335	95.96	8.54
3	#10400.00	47.8 PK	74.0	-26.2	1.71 H	207	33.20	14.60
4	#10400.00	33.6 AV	54.0	-20.4	1.71 H	207	19.00	14.60
5	15600.00	51.2 PK	74.0	-22.8	1.44 H	301	32.30	18.90
6	15600.00	37.3 AV	54.0	-16.7	1.44 H	301	18.40	18.90

ANTENNA POLARITY & TEST DISTANCE: VERTICAL AT 3 M

NO.	FREQ. (MHz)	EMISSION LEVEL (dBuV/m)	LIMIT (dBuV/m)	MARGIN (dB)	ANTENNA HEIGHT (m)	TABLE ANGLE (Degree)	RAW VALUE (dBuV)	CORRECTION FACTOR (dB/m)
1	*5200.00	122.5 PK			1.85 V	108	113.96	8.54
2	*5200.00	112.4 AV			1.85 V	108	103.86	8.54
3	#10400.00	49.7 PK	74.0	-24.3	1.62 V	210	35.10	14.60
4	#10400.00	35.9 AV	54.0	-18.1	1.62 V	210	21.30	14.60
5	15600.00	51.6 PK	74.0	-22.4	1.56 V	204	32.70	18.90
6	15600.00	37.8 AV	54.0	-16.2	1.56 V	204	18.90	18.90

REMARKS:

1. Emission Level(dBuV/m) = Raw Value(dBuV) + Correction Factor(dB/m)
2. Correction Factor(dB/m) = Antenna Factor(dB/m) + Cable Factor(dB) – Pre-Amplifier Factor(dB)
3. The other emission levels were very low against the limit.
4. Margin value = Emission Level – Limit value
5. " * ": Fundamental frequency.
6. " # ": The radiated frequency is out of the restricted band.

CHANNEL	TX Channel 48	DETECTOR FUNCTION	Peak (PK)
FREQUENCY RANGE	1GHz ~ 40GHz		Average (AV)

ANTENNA POLARITY & TEST DISTANCE: HORIZONTAL AT 3 M

NO.	FREQ. (MHz)	EMISSION LEVEL (dBuV/m)	LIMIT (dBuV/m)	MARGIN (dB)	ANTENNA HEIGHT (m)	TABLE ANGLE (Degree)	RAW VALUE (dBuV)	CORRECTION FACTOR (dB/m)
1	*5240.00	116.4 PK			1.85 H	352	107.80	8.60
2	*5240.00	104.2 AV			1.85 H	352	95.60	8.60
3	#10480.00	47.6 PK	74.0	-26.4	1.67 H	205	33.13	14.47
4	#10480.00	33.7 AV	54.0	-20.3	1.67 H	205	19.23	14.47
5	15720.00	51.0 PK	74.0	-23.0	1.49 H	301	31.96	19.04
6	15720.00	37.1 AV	54.0	-16.9	1.49 H	301	18.06	19.04

ANTENNA POLARITY & TEST DISTANCE: VERTICAL AT 3 M

NO.	FREQ. (MHz)	EMISSION LEVEL (dBuV/m)	LIMIT (dBuV/m)	MARGIN (dB)	ANTENNA HEIGHT (m)	TABLE ANGLE (Degree)	RAW VALUE (dBuV)	CORRECTION FACTOR (dB/m)
1	*5240.00	122.3 PK			1.82 V	104	113.70	8.60
2	*5240.00	112.1 AV			1.82 V	104	103.50	8.60
3	#10480.00	49.3 PK	74.0	-24.7	1.64 V	221	34.83	14.47
4	#10480.00	35.6 AV	54.0	-18.4	1.64 V	221	21.13	14.47
5	15720.00	51.0 PK	74.0	-23.0	1.55 V	189	31.96	19.04
6	15720.00	37.4 AV	54.0	-16.6	1.55 V	189	18.36	19.04

REMARKS:

1. Emission Level(dBuV/m) = Raw Value(dBuV) + Correction Factor(dB/m)
2. Correction Factor(dB/m) = Antenna Factor(dB/m) + Cable Factor(dB) – Pre-Amplifier Factor(dB)
3. The other emission levels were very low against the limit.
4. Margin value = Emission Level – Limit value
5. " * ": Fundamental frequency.
6. " # ": The radiated frequency is out of the restricted band.

CHANNEL	TX Channel 149	DETECTOR FUNCTION	Peak (PK)
FREQUENCY RANGE	1GHz ~ 40GHz		Average (AV)

ANTENNA POLARITY & TEST DISTANCE: HORIZONTAL AT 3 M

NO.	FREQ. (MHz)	EMISSION LEVEL (dBuV/m)	LIMIT (dBuV/m)	MARGIN (dB)	ANTENNA HEIGHT (m)	TABLE ANGLE (Degree)	RAW VALUE (dBuV)	CORRECTION FACTOR (dB/m)
1	#5715.00	57.1 PK	74.0	-16.9	1.81 H	324	47.42	9.68
2	#5715.00	42.3 AV	54.0	-11.7	1.81 H	324	32.62	9.68
3	#5725.00	72.4 PK	78.2	-5.8	1.81 H	324	62.70	9.70
4	*5745.00	112.2 PK			1.81 H	324	102.44	9.76
5	*5745.00	100.3 AV			1.81 H	324	90.54	9.76
6	11490.00	48.4 PK	74.0	-25.6	1.74 H	223	33.54	14.86
7	11490.00	34.2 AV	54.0	-19.8	1.74 H	223	19.34	14.86
8	#17235.00	51.0 PK	74.0	-23.0	1.43 H	285	27.77	23.23
9	#17235.00	37.6 AV	54.0	-16.4	1.43 H	285	14.37	23.23

ANTENNA POLARITY & TEST DISTANCE: VERTICAL AT 3 M

NO.	FREQ. (MHz)	EMISSION LEVEL (dBuV/m)	LIMIT (dBuV/m)	MARGIN (dB)	ANTENNA HEIGHT (m)	TABLE ANGLE (Degree)	RAW VALUE (dBuV)	CORRECTION FACTOR (dB/m)
1	#5715.00	62.0 PK	74.0	-12.0	2.26 V	145	52.32	9.68
2	#5715.00	49.8 AV	54.0	-4.2	2.26 V	145	40.12	9.68
3	#5725.00	77.3 PK	78.2	-0.9	2.26 V	145	67.60	9.70
4	*5745.00	118.4 PK			2.26 V	145	108.64	9.76
5	*5745.00	108.2 AV			2.26 V	145	98.44	9.76
6	11490.00	50.5 PK	74.0	-23.5	1.58 V	220	35.64	14.86
7	11490.00	36.4 AV	54.0	-17.6	1.58 V	220	21.54	14.86
8	#17235.00	51.8 PK	74.0	-22.2	1.56 V	215	28.57	23.23
9	#17235.00	38.3 AV	54.0	-15.7	1.56 V	215	15.07	23.23

REMARKS:

1. Emission Level(dBuV/m) = Raw Value(dBuV) + Correction Factor(dB/m)
2. Correction Factor(dB/m) = Antenna Factor(dB/m) + Cable Factor(dB) – Pre-Amplifier Factor(dB)
3. The other emission levels were very low against the limit.
4. Margin value = Emission Level – Limit value
5. " * ": Fundamental frequency.
6. " # ": The radiated frequency is out of the restricted band.

CHANNEL	TX Channel 157	DETECTOR FUNCTION	Peak (PK)
FREQUENCY RANGE	1GHz ~ 40GHz		Average (AV)

ANTENNA POLARITY & TEST DISTANCE: HORIZONTAL AT 3 M

NO.	FREQ. (MHz)	EMISSION LEVEL (dBuV/m)	LIMIT (dBuV/m)	MARGIN (dB)	ANTENNA HEIGHT (m)	TABLE ANGLE (Degree)	RAW VALUE (dBuV)	CORRECTION FACTOR (dB/m)
1	#5715.00	60.2 PK	74.0	-13.8	1.85 H	334	50.52	9.68
2	#5715.00	45.5 AV	54.0	-8.5	1.85 H	334	35.82	9.68
3	#5725.00	60.4 PK	78.2	-17.8	1.85 H	334	50.70	9.70
4	*5785.00	115.8 PK			1.85 H	334	105.95	9.85
5	*5785.00	103.8 AV			1.85 H	334	93.95	9.85
6	#5850.00	57.8 PK	78.2	-20.4	1.85 H	334	47.88	9.92
7	#5860.00	56.1 PK	74.0	-17.9	1.85 H	334	46.17	9.93
8	#5860.00	41.0 AV	54.0	-13.0	1.85 H	334	31.07	9.93
9	11570.00	47.3 PK	74.0	-26.7	1.71 H	204	32.10	15.20
10	11570.00	33.6 AV	54.0	-20.4	1.71 H	204	18.40	15.20
11	#17355.00	51.4 PK	74.0	-22.6	1.45 H	294	27.84	23.56
12	#17355.00	37.3 AV	54.0	-16.7	1.45 H	294	13.74	23.56

ANTENNA POLARITY & TEST DISTANCE: VERTICAL AT 3 M

NO.	FREQ. (MHz)	EMISSION LEVEL (dBuV/m)	LIMIT (dBuV/m)	MARGIN (dB)	ANTENNA HEIGHT (m)	TABLE ANGLE (Degree)	RAW VALUE (dBuV)	CORRECTION FACTOR (dB/m)
1	#5715.00	65.1 PK	74.0	-8.9	2.09 V	301	55.42	9.68
2	#5715.00	52.9 AV	54.0	-1.1	2.09 V	301	43.22	9.68
3	#5725.00	65.2 PK	78.2	-13.0	2.09 V	301	55.50	9.70
4	*5785.00	122.2 PK			2.09 V	301	112.35	9.85
5	*5785.00	112.2 AV			2.09 V	301	102.35	9.85
6	#5850.00	62.6 PK	78.2	-15.6	2.09 V	301	52.68	9.92
7	#5860.00	61.3 PK	74.0	-12.7	2.09 V	301	51.37	9.93
8	#5860.00	48.4 AV	54.0	-5.6	2.09 V	301	38.47	9.93
9	11570.00	49.9 PK	74.0	-24.1	1.65 V	228	34.70	15.20
10	11570.00	36.0 AV	54.0	-18.0	1.65 V	228	20.80	15.20
11	#17355.00	51.3 PK	74.0	-22.7	1.59 V	177	27.74	23.56
12	#17355.00	37.9 AV	54.0	-16.1	1.59 V	177	14.34	23.56

REMARKS:

1. Emission Level(dBuV/m) = Raw Value(dBuV) + Correction Factor(dB/m)
2. Correction Factor(dB/m) = Antenna Factor(dB/m) + Cable Factor(dB) – Pre-Amplifier Factor(dB)
3. The other emission levels were very low against the limit.
4. Margin value = Emission Level – Limit value
5. " * ": Fundamental frequency.
6. " # ": The radiated frequency is out of the restricted band.

CHANNEL	TX Channel 165	DETECTOR FUNCTION	Peak (PK)
FREQUENCY RANGE	1GHz ~ 40GHz		Average (AV)

ANTENNA POLARITY & TEST DISTANCE: HORIZONTAL AT 3 M

NO.	FREQ. (MHz)	EMISSION LEVEL (dBuV/m)	LIMIT (dBuV/m)	MARGIN (dB)	ANTENNA HEIGHT (m)	TABLE ANGLE (Degree)	RAW VALUE (dBuV)	CORRECTION FACTOR (dB/m)
1	*5825.00	115.9 PK			1.85 H	337	105.99	9.91
2	*5825.00	103.7 AV			1.85 H	337	93.79	9.91
3	#5850.00	72.3 PK	78.2	-5.9	1.85 H	337	62.38	9.92
4	#5860.00	61.6 PK	68.2	-6.6	1.85 H	337	51.67	9.93
5	11650.00	48.6 PK	74.0	-25.4	1.82 H	203	33.20	15.40
6	11650.00	34.4 AV	54.0	-19.6	1.82 H	203	19.00	15.40
7	#17475.00	52.0 PK	74.0	-22.0	1.42 H	294	27.91	24.09
8	#17475.00	38.3 AV	54.0	-15.7	1.42 H	294	14.21	24.09

ANTENNA POLARITY & TEST DISTANCE: VERTICAL AT 3 M

NO.	FREQ. (MHz)	EMISSION LEVEL (dBuV/m)	LIMIT (dBuV/m)	MARGIN (dB)	ANTENNA HEIGHT (m)	TABLE ANGLE (Degree)	RAW VALUE (dBuV)	CORRECTION FACTOR (dB/m)
1	*5825.00	122.6 PK			2.34 V	60	112.69	9.91
2	*5825.00	113.4 AV			2.34 V	60	103.49	9.91
3	#5850.00	77.1 PK	78.2	-1.1	2.34 V	60	67.18	9.92
4	#5860.00	66.3 PK	68.2	-1.9	2.34 V	60	56.37	9.93
5	11650.00	49.4 PK	74.0	-24.6	1.61 V	198	34.00	15.40
6	11650.00	35.6 AV	54.0	-18.4	1.61 V	198	20.20	15.40
7	#17475.00	51.3 PK	74.0	-22.7	1.60 V	215	27.21	24.09
8	#17475.00	37.4 AV	54.0	-16.6	1.60 V	215	13.31	24.09

REMARKS:

1. Emission Level(dBuV/m) = Raw Value(dBuV) + Correction Factor(dB/m)
2. Correction Factor(dB/m) = Antenna Factor(dB/m) + Cable Factor(dB) – Pre-Amplifier Factor(dB)
3. The other emission levels were very low against the limit.
4. Margin value = Emission Level – Limit value
5. " * ": Fundamental frequency.
6. " # ": The radiated frequency is out of the restricted band.

802.11ac (VHT20)

CHANNEL	TX Channel 36	DETECTOR FUNCTION	Peak (PK)
FREQUENCY RANGE	1GHz ~ 40GHz		Average (AV)

ANTENNA POLARITY & TEST DISTANCE: HORIZONTAL AT 3 M

NO.	FREQ. (MHz)	EMISSION LEVEL (dBuV/m)	LIMIT (dBuV/m)	MARGIN (dB)	ANTENNA HEIGHT (m)	TABLE ANGLE (Degree)	RAW VALUE (dBuV)	CORRECTION FACTOR (dB/m)
1	5150.00	59.9 PK	74.0	-14.1	1.91 H	343	51.57	8.33
2	5150.00	45.2 AV	54.0	-8.8	1.91 H	343	36.87	8.33
3	*5180.00	110.2 PK			1.91 H	343	101.73	8.47
4	*5180.00	98.2 AV			1.91 H	343	89.73	8.47
5	#10360.00	48.1 PK	74.0	-25.9	1.81 H	211	33.60	14.50
6	#10360.00	33.8 AV	54.0	-20.2	1.81 H	211	19.30	14.50
7	15540.00	51.4 PK	74.0	-22.6	1.44 H	286	32.72	18.68
8	15540.00	37.8 AV	54.0	-16.2	1.44 H	286	19.12	18.68

ANTENNA POLARITY & TEST DISTANCE: VERTICAL AT 3 M

NO.	FREQ. (MHz)	EMISSION LEVEL (dBuV/m)	LIMIT (dBuV/m)	MARGIN (dB)	ANTENNA HEIGHT (m)	TABLE ANGLE (Degree)	RAW VALUE (dBuV)	CORRECTION FACTOR (dB/m)
1	5150.00	64.8 PK	74.0	-9.2	2.46 V	99	56.47	8.33
2	5150.00	53.3 AV	54.0	-0.7	2.46 V	99	44.97	8.33
3	*5180.00	117.4 PK			2.46 V	99	108.93	8.47
4	*5180.00	107.7 AV			2.46 V	99	99.23	8.47
5	#10360.00	49.2 PK	74.0	-24.8	1.61 V	198	34.70	14.50
6	#10360.00	35.6 AV	54.0	-18.4	1.61 V	198	21.10	14.50
7	15540.00	51.4 PK	74.0	-22.6	1.52 V	192	32.72	18.68
8	15540.00	37.6 AV	54.0	-16.4	1.52 V	192	18.92	18.68

REMARKS:

1. Emission Level(dBuV/m) = Raw Value(dBuV) + Correction Factor(dB/m)
2. Correction Factor(dB/m) = Antenna Factor(dB/m) + Cable Factor(dB) – Pre-Amplifier Factor(dB)
3. The other emission levels were very low against the limit.
4. Margin value = Emission Level – Limit value
5. " * ": Fundamental frequency.
6. " # ": The radiated frequency is out of the restricted band.

CHANNEL	TX Channel 40	DETECTOR FUNCTION	Peak (PK)
FREQUENCY RANGE	1GHz ~ 40GHz		Average (AV)

ANTENNA POLARITY & TEST DISTANCE: HORIZONTAL AT 3 M

NO.	FREQ. (MHz)	EMISSION LEVEL (dBuV/m)	LIMIT (dBuV/m)	MARGIN (dB)	ANTENNA HEIGHT (m)	TABLE ANGLE (Degree)	RAW VALUE (dBuV)	CORRECTION FACTOR (dB/m)
1	*5200.00	115.1 PK			1.88 H	322	106.56	8.54
2	*5200.00	103.3 AV			1.88 H	322	94.76	8.54
3	#10400.00	48.0 PK	74.0	-26.0	1.63 H	191	33.40	14.60
4	#10400.00	34.2 AV	54.0	-19.8	1.63 H	191	19.60	14.60
5	15600.00	50.7 PK	74.0	-23.3	1.51 H	310	31.80	18.90
6	15600.00	37.0 AV	54.0	-17.0	1.51 H	310	18.10	18.90

ANTENNA POLARITY & TEST DISTANCE: VERTICAL AT 3 M

NO.	FREQ. (MHz)	EMISSION LEVEL (dBuV/m)	LIMIT (dBuV/m)	MARGIN (dB)	ANTENNA HEIGHT (m)	TABLE ANGLE (Degree)	RAW VALUE (dBuV)	CORRECTION FACTOR (dB/m)
1	*5200.00	122.4 PK			1.04 V	298	113.86	8.54
2	*5200.00	112.8 AV			1.04 V	298	104.26	8.54
3	#10400.00	48.8 PK	74.0	-25.2	1.65 V	221	34.20	14.60
4	#10400.00	35.3 AV	54.0	-18.7	1.65 V	221	20.70	14.60
5	15600.00	50.8 PK	74.0	-23.2	1.54 V	173	31.90	18.90
6	15600.00	37.2 AV	54.0	-16.8	1.54 V	173	18.30	18.90

REMARKS:

1. Emission Level(dBuV/m) = Raw Value(dBuV) + Correction Factor(dB/m)
2. Correction Factor(dB/m) = Antenna Factor(dB/m) + Cable Factor(dB) – Pre-Amplifier Factor(dB)
3. The other emission levels were very low against the limit.
4. Margin value = Emission Level – Limit value
5. " * ": Fundamental frequency.
6. " # ": The radiated frequency is out of the restricted band.

CHANNEL	TX Channel 48	DETECTOR FUNCTION	Peak (PK)
FREQUENCY RANGE	1GHz ~ 40GHz		Average (AV)

ANTENNA POLARITY & TEST DISTANCE: HORIZONTAL AT 3 M

NO.	FREQ. (MHz)	EMISSION LEVEL (dBuV/m)	LIMIT (dBuV/m)	MARGIN (dB)	ANTENNA HEIGHT (m)	TABLE ANGLE (Degree)	RAW VALUE (dBuV)	CORRECTION FACTOR (dB/m)
1	*5240.00	115.4 PK			1.84 H	330	106.80	8.60
2	*5240.00	103.5 AV			1.84 H	330	94.90	8.60
3	5350.00	57.2 PK	74.0	-16.8	1.84 H	330	48.40	8.80
4	5350.00	43.4 AV	54.0	-10.6	1.84 H	330	34.60	8.80
5	#10480.00	47.8 PK	74.0	-26.2	1.76 H	205	33.33	14.47
6	#10480.00	34.1 AV	54.0	-19.9	1.76 H	205	19.63	14.47
7	15720.00	51.6 PK	74.0	-22.4	1.45 H	304	32.56	19.04
8	15720.00	38.1 AV	54.0	-15.9	1.45 H	304	19.06	19.04

ANTENNA POLARITY & TEST DISTANCE: VERTICAL AT 3 M

NO.	FREQ. (MHz)	EMISSION LEVEL (dBuV/m)	LIMIT (dBuV/m)	MARGIN (dB)	ANTENNA HEIGHT (m)	TABLE ANGLE (Degree)	RAW VALUE (dBuV)	CORRECTION FACTOR (dB/m)
1	*5240.00	122.5 PK			1.00 V	303	113.90	8.60
2	*5240.00	112.7 AV			1.00 V	303	104.10	8.60
3	5350.00	62.3 PK	74.0	-11.7	1.00 V	303	53.50	8.80
4	5350.00	49.7 AV	54.0	-4.3	1.00 V	303	40.90	8.80
5	#10480.00	49.9 PK	74.0	-24.1	1.60 V	197	35.43	14.47
6	#10480.00	36.2 AV	54.0	-17.8	1.60 V	197	21.73	14.47
7	15720.00	51.9 PK	74.0	-22.1	1.52 V	217	32.86	19.04
8	15720.00	38.2 AV	54.0	-15.8	1.52 V	217	19.16	19.04

REMARKS:

1. Emission Level(dBuV/m) = Raw Value(dBuV) + Correction Factor(dB/m)
2. Correction Factor(dB/m) = Antenna Factor(dB/m) + Cable Factor(dB) – Pre-Amplifier Factor(dB)
3. The other emission levels were very low against the limit.
4. Margin value = Emission Level – Limit value
5. " * ": Fundamental frequency.
6. " # ": The radiated frequency is out of the restricted band.

CHANNEL	TX Channel 149	DETECTOR FUNCTION	Peak (PK)
FREQUENCY RANGE	1GHz ~ 40GHz		Average (AV)

ANTENNA POLARITY & TEST DISTANCE: HORIZONTAL AT 3 M

NO.	FREQ. (MHz)	EMISSION LEVEL (dBuV/m)	LIMIT (dBuV/m)	MARGIN (dB)	ANTENNA HEIGHT (m)	TABLE ANGLE (Degree)	RAW VALUE (dBuV)	CORRECTION FACTOR (dB/m)
1	#5715.00	59.2 PK	74.0	-14.8	1.87 H	342	49.52	9.68
2	#5715.00	44.8 AV	54.0	-9.2	1.87 H	342	35.12	9.68
3	#5725.00	71.3 PK	78.2	-6.9	1.87 H	342	61.60	9.70
4	*5745.00	111.8 PK			1.87 H	342	102.04	9.76
5	*5745.00	100.3 AV			1.87 H	342	90.54	9.76
6	11490.00	48.8 PK	74.0	-25.2	1.73 H	225	33.94	14.86
7	11490.00	34.5 AV	54.0	-19.5	1.73 H	225	19.64	14.86
8	#17235.00	51.6 PK	74.0	-22.4	1.48 H	295	28.37	23.23
9	#17235.00	38.0 AV	54.0	-16.0	1.48 H	295	14.77	23.23

ANTENNA POLARITY & TEST DISTANCE: VERTICAL AT 3 M

NO.	FREQ. (MHz)	EMISSION LEVEL (dBuV/m)	LIMIT (dBuV/m)	MARGIN (dB)	ANTENNA HEIGHT (m)	TABLE ANGLE (Degree)	RAW VALUE (dBuV)	CORRECTION FACTOR (dB/m)
1	#5715.00	65.8 PK	74.0	-8.2	2.35 V	63	56.12	9.68
2	#5715.00	50.6 AV	54.0	-3.4	2.35 V	63	40.92	9.68
3	#5725.00	77.5 PK	78.2	-0.7	2.35 V	63	67.80	9.70
4	*5745.00	119.0 PK			2.35 V	63	109.24	9.76
5	*5745.00	109.8 AV			2.35 V	63	100.04	9.76
6	11490.00	48.9 PK	74.0	-25.1	1.70 V	236	34.04	14.86
7	11490.00	35.0 AV	54.0	-19.0	1.70 V	236	20.14	14.86
8	#17235.00	51.5 PK	74.0	-22.5	1.64 V	177	28.27	23.23
9	#17235.00	37.9 AV	54.0	-16.1	1.64 V	177	14.67	23.23

REMARKS:

1. Emission Level(dBuV/m) = Raw Value(dBuV) + Correction Factor(dB/m)
2. Correction Factor(dB/m) = Antenna Factor(dB/m) + Cable Factor(dB) – Pre-Amplifier Factor(dB)
3. The other emission levels were very low against the limit.
4. Margin value = Emission Level – Limit value
5. " * ": Fundamental frequency.
6. " # ": The radiated frequency is out of the restricted band.

CHANNEL	TX Channel 157	DETECTOR FUNCTION	Peak (PK)
FREQUENCY RANGE	1GHz ~ 40GHz		Average (AV)

ANTENNA POLARITY & TEST DISTANCE: HORIZONTAL AT 3 M

NO.	FREQ. (MHz)	EMISSION LEVEL (dBuV/m)	LIMIT (dBuV/m)	MARGIN (dB)	ANTENNA HEIGHT (m)	TABLE ANGLE (Degree)	RAW VALUE (dBuV)	CORRECTION FACTOR (dB/m)
1	#5715.00	59.4 PK	74.0	-14.6	1.86 H	335	49.72	9.68
2	#5715.00	47.1 AV	54.0	-6.9	1.86 H	335	37.42	9.68
3	#5725.00	59.8 PK	78.2	-18.4	1.86 H	335	50.10	9.70
4	*5785.00	116.8 PK			1.86 H	335	106.95	9.85
5	*5785.00	104.9 AV			1.86 H	335	95.05	9.85
6	#5850.00	55.8 PK	78.2	-22.4	1.86 H	335	45.88	9.92
7	#5860.00	54.4 PK	74.0	-19.6	1.86 H	335	44.47	9.93
8	#5860.00	41.8 AV	54.0	-12.2	1.86 H	335	31.87	9.93
9	11570.00	48.2 PK	74.0	-25.8	1.64 H	217	33.00	15.20
10	11570.00	34.1 AV	54.0	-19.9	1.64 H	217	18.90	15.20
11	#17355.00	50.9 PK	74.0	-23.1	1.50 H	290	27.34	23.56
12	#17355.00	37.2 AV	54.0	-16.8	1.50 H	290	13.64	23.56

ANTENNA POLARITY & TEST DISTANCE: VERTICAL AT 3 M

NO.	FREQ. (MHz)	EMISSION LEVEL (dBuV/m)	LIMIT (dBuV/m)	MARGIN (dB)	ANTENNA HEIGHT (m)	TABLE ANGLE (Degree)	RAW VALUE (dBuV)	CORRECTION FACTOR (dB/m)
1	#5715.00	65.2 PK	74.0	-8.8	2.05 V	299	55.52	9.68
2	#5715.00	52.8 AV	54.0	-1.2	2.05 V	299	43.12	9.68
3	#5725.00	65.5 PK	78.2	-12.7	2.05 V	299	55.80	9.70
4	*5785.00	124.2 PK			2.05 V	299	114.35	9.85
5	*5785.00	114.6 AV			2.05 V	299	104.75	9.85
6	#5850.00	62.6 PK	78.2	-15.6	2.05 V	299	52.68	9.92
7	#5860.00	60.8 PK	74.0	-13.2	2.05 V	299	50.87	9.93
8	#5860.00	48.1 AV	54.0	-5.9	2.05 V	299	38.17	9.93
9	11570.00	49.3 PK	74.0	-24.7	1.71 V	229	34.10	15.20
10	11570.00	35.5 AV	54.0	-18.5	1.71 V	229	20.30	15.20
11	#17355.00	51.0 PK	74.0	-23.0	1.63 V	189	27.44	23.56
12	#17355.00	37.5 AV	54.0	-16.5	1.63 V	189	13.94	23.56

REMARKS:

1. Emission Level(dBuV/m) = Raw Value(dBuV) + Correction Factor(dB/m)
2. Correction Factor(dB/m) = Antenna Factor(dB/m) + Cable Factor(dB) – Pre-Amplifier Factor(dB)
3. The other emission levels were very low against the limit.
4. Margin value = Emission Level – Limit value
5. " * ": Fundamental frequency.
6. " # ": The radiated frequency is out of the restricted band.

CHANNEL	TX Channel 165	DETECTOR FUNCTION	Peak (PK)
FREQUENCY RANGE	1GHz ~ 40GHz		Average (AV)

ANTENNA POLARITY & TEST DISTANCE: HORIZONTAL AT 3 M

NO.	FREQ. (MHz)	EMISSION LEVEL (dBuV/m)	LIMIT (dBuV/m)	MARGIN (dB)	ANTENNA HEIGHT (m)	TABLE ANGLE (Degree)	RAW VALUE (dBuV)	CORRECTION FACTOR (dB/m)
1	*5825.00	114.2 PK			1.90 H	337	104.29	9.91
2	*5825.00	102.3 AV			1.90 H	337	92.39	9.91
3	#5850.00	71.5 PK	78.2	-6.7	1.90 H	337	61.58	9.92
4	#5860.00	57.1 PK	74.0	-16.9	1.90 H	337	47.17	9.93
5	#5860.00	44.5 AV	54.0	-9.5	1.90 H	337	34.57	9.93
6	11650.00	48.0 PK	74.0	-26.0	1.77 H	208	32.60	15.40
7	11650.00	34.0 AV	54.0	-20.0	1.77 H	208	18.60	15.40
8	#17475.00	51.1 PK	74.0	-22.9	1.53 H	287	27.01	24.09
9	#17475.00	37.8 AV	54.0	-16.2	1.53 H	287	13.71	24.09

ANTENNA POLARITY & TEST DISTANCE: VERTICAL AT 3 M

NO.	FREQ. (MHz)	EMISSION LEVEL (dBuV/m)	LIMIT (dBuV/m)	MARGIN (dB)	ANTENNA HEIGHT (m)	TABLE ANGLE (Degree)	RAW VALUE (dBuV)	CORRECTION FACTOR (dB/m)
1	*5825.00	121.3 PK			2.38 V	60	111.39	9.91
2	*5825.00	112.4 AV			2.38 V	60	102.49	9.91
3	#5850.00	77.7 PK	78.2	-0.5	2.38 V	60	67.78	9.92
4	#5860.00	63.2 PK	74.0	-10.8	2.38 V	60	53.27	9.93
5	#5860.00	50.7 AV	54.0	-3.3	2.38 V	60	40.77	9.93
6	11650.00	49.7 PK	74.0	-24.3	1.68 V	215	34.30	15.40
7	11650.00	35.8 AV	54.0	-18.2	1.68 V	215	20.40	15.40
8	#17475.00	51.5 PK	74.0	-22.5	1.66 V	179	27.41	24.09
9	#17475.00	37.9 AV	54.0	-16.1	1.66 V	179	13.81	24.09

REMARKS:

1. Emission Level(dBuV/m) = Raw Value(dBuV) + Correction Factor(dB/m)
2. Correction Factor(dB/m) = Antenna Factor(dB/m) + Cable Factor(dB) – Pre-Amplifier Factor(dB)
3. The other emission levels were very low against the limit.
4. Margin value = Emission Level – Limit value
5. " * ": Fundamental frequency.
6. " # ": The radiated frequency is out of the restricted band.

802.11ac (VHT40)

CHANNEL	TX Channel 38	DETECTOR FUNCTION	Peak (PK)
FREQUENCY RANGE	1GHz ~ 40GHz		Average (AV)

ANTENNA POLARITY & TEST DISTANCE: HORIZONTAL AT 3 M

NO.	FREQ. (MHz)	EMISSION LEVEL (dBuV/m)	LIMIT (dBuV/m)	MARGIN (dB)	ANTENNA HEIGHT (m)	TABLE ANGLE (Degree)	RAW VALUE (dBuV)	CORRECTION FACTOR (dB/m)
1	5150.00	59.4 PK	74.0	-14.6	1.87 H	325	51.07	8.33
2	5150.00	46.9 AV	54.0	-7.1	1.87 H	325	38.57	8.33
3	*5190.00	103.2 PK			1.87 H	325	94.70	8.50
4	*5190.00	90.6 AV			1.87 H	325	82.10	8.50
5	5350.00	48.9 PK	74.0	-25.1	1.87 H	325	40.10	8.80
6	5350.00	37.2 AV	54.0	-16.8	1.87 H	325	28.40	8.80
7	#10380.00	47.5 PK	74.0	-26.5	1.81 H	207	32.95	14.55
8	#10380.00	33.6 AV	54.0	-20.4	1.81 H	207	19.05	14.55
9	15570.00	51.9 PK	74.0	-22.1	1.47 H	300	33.11	18.79
10	15570.00	38.2 AV	54.0	-15.8	1.47 H	300	19.41	18.79

ANTENNA POLARITY & TEST DISTANCE: VERTICAL AT 3 M

NO.	FREQ. (MHz)	EMISSION LEVEL (dBuV/m)	LIMIT (dBuV/m)	MARGIN (dB)	ANTENNA HEIGHT (m)	TABLE ANGLE (Degree)	RAW VALUE (dBuV)	CORRECTION FACTOR (dB/m)
1	5150.00	65.3 PK	74.0	-8.7	2.44 V	62	56.97	8.33
2	5150.00	53.2 AV	54.0	-0.8	2.44 V	62	44.87	8.33
3	*5190.00	110.2 PK			2.44 V	62	101.70	8.50
4	*5190.00	100.5 AV			2.44 V	62	92.00	8.50
5	5350.00	55.2 PK	74.0	-18.8	2.44 V	62	46.40	8.80
6	5350.00	43.0 AV	54.0	-11.0	2.44 V	62	34.20	8.80
7	#10380.00	49.1 PK	74.0	-24.9	1.75 V	232	34.55	14.55
8	#10380.00	35.6 AV	54.0	-18.4	1.75 V	232	21.05	14.55
9	15570.00	50.9 PK	74.0	-23.1	1.63 V	190	32.11	18.79
10	15570.00	37.7 AV	54.0	-16.3	1.63 V	190	18.91	18.79

REMARKS:

1. Emission Level(dBuV/m) = Raw Value(dBuV) + Correction Factor(dB/m)
2. Correction Factor(dB/m) = Antenna Factor(dB/m) + Cable Factor(dB) – Pre-Amplifier Factor(dB)
3. The other emission levels were very low against the limit.
4. Margin value = Emission Level – Limit value
5. " * ": Fundamental frequency.
6. " # ": The radiated frequency is out of the restricted band.

CHANNEL	TX Channel 46	DETECTOR FUNCTION	Peak (PK)
FREQUENCY RANGE	1GHz ~ 40GHz		Average (AV)

ANTENNA POLARITY & TEST DISTANCE: HORIZONTAL AT 3 M

NO.	FREQ. (MHz)	EMISSION LEVEL (dBuV/m)	LIMIT (dBuV/m)	MARGIN (dB)	ANTENNA HEIGHT (m)	TABLE ANGLE (Degree)	RAW VALUE (dBuV)	CORRECTION FACTOR (dB/m)
1	5150.00	59.4 PK	74.0	-14.6	1.91 H	347	51.07	8.33
2	5150.00	47.0 AV	54.0	-7.0	1.91 H	347	38.67	8.33
3	*5230.00	111.4 PK			1.91 H	347	102.81	8.59
4	*5230.00	100.8 AV			1.91 H	347	92.21	8.59
5	5350.00	55.6 PK	74.0	-18.4	1.91 H	347	46.80	8.80
6	5350.00	42.8 AV	54.0	-11.2	1.91 H	347	34.00	8.80
7	#10460.00	48.3 PK	74.0	-25.7	1.81 H	219	33.79	14.51
8	#10460.00	34.0 AV	54.0	-20.0	1.81 H	219	19.49	14.51
9	15690.00	51.8 PK	74.0	-22.2	1.53 H	305	32.83	18.97
10	15690.00	37.9 AV	54.0	-16.1	1.53 H	305	18.93	18.97

ANTENNA POLARITY & TEST DISTANCE: VERTICAL AT 3 M

NO.	FREQ. (MHz)	EMISSION LEVEL (dBuV/m)	LIMIT (dBuV/m)	MARGIN (dB)	ANTENNA HEIGHT (m)	TABLE ANGLE (Degree)	RAW VALUE (dBuV)	CORRECTION FACTOR (dB/m)
1	5150.00	65.7 PK	74.0	-8.3	1.00 V	302	57.37	8.33
2	5150.00	53.2 AV	54.0	-0.8	1.00 V	302	44.87	8.33
3	*5230.00	118.4 PK			1.00 V	302	109.81	8.59
4	*5230.00	109.3 AV			1.00 V	302	100.71	8.59
5	5350.00	61.9 PK	74.0	-12.1	1.00 V	302	53.10	8.80
6	5350.00	48.9 AV	54.0	-5.1	1.00 V	302	40.10	8.80
7	#10460.00	49.8 PK	74.0	-24.2	1.70 V	228	35.29	14.51
8	#10460.00	35.8 AV	54.0	-18.2	1.70 V	228	21.29	14.51
9	15690.00	50.8 PK	74.0	-23.2	1.60 V	178	31.83	18.97
10	15690.00	37.4 AV	54.0	-16.6	1.60 V	178	18.43	18.97

REMARKS:

1. Emission Level(dBuV/m) = Raw Value(dBuV) + Correction Factor(dB/m)
2. Correction Factor(dB/m) = Antenna Factor(dB/m) + Cable Factor(dB) – Pre-Amplifier Factor(dB)
3. The other emission levels were very low against the limit.
4. Margin value = Emission Level – Limit value
5. " * ": Fundamental frequency.
6. " # ": The radiated frequency is out of the restricted band.

CHANNEL	TX Channel 151	DETECTOR FUNCTION	Peak (PK)
FREQUENCY RANGE	1GHz ~ 40GHz		Average (AV)

ANTENNA POLARITY & TEST DISTANCE: HORIZONTAL AT 3 M

NO.	FREQ. (MHz)	EMISSION LEVEL (dBuV/m)	LIMIT (dBuV/m)	MARGIN (dB)	ANTENNA HEIGHT (m)	TABLE ANGLE (Degree)	RAW VALUE (dBuV)	CORRECTION FACTOR (dB/m)
1	#5715.00	61.7 PK	74.0	-12.3	1.86 H	342	52.02	9.68
2	#5715.00	47.4 AV	54.0	-6.6	1.86 H	342	37.72	9.68
3	#5725.00	68.2 PK	78.2	-10.0	1.86 H	342	58.50	9.70
4	*5755.00	105.6 PK			1.86 H	342	95.83	9.77
5	*5755.00	93.5 AV			1.86 H	342	83.73	9.77
6	11510.00	48.3 PK	74.0	-25.7	1.78 H	202	33.45	14.85
7	11510.00	34.4 AV	54.0	-19.6	1.78 H	202	19.55	14.85
8	#17265.00	51.3 PK	74.0	-22.7	1.44 H	294	28.07	23.23
9	#17265.00	37.5 AV	54.0	-16.5	1.44 H	294	14.27	23.23

ANTENNA POLARITY & TEST DISTANCE: VERTICAL AT 3 M

NO.	FREQ. (MHz)	EMISSION LEVEL (dBuV/m)	LIMIT (dBuV/m)	MARGIN (dB)	ANTENNA HEIGHT (m)	TABLE ANGLE (Degree)	RAW VALUE (dBuV)	CORRECTION FACTOR (dB/m)
1	#5715.00	67.9 PK	74.0	-6.1	2.35 V	55	58.22	9.68
2	#5715.00	53.5 AV	54.0	-0.5	2.35 V	55	43.82	9.68
3	#5725.00	74.4 PK	78.2	-3.8	2.35 V	55	64.70	9.70
4	*5755.00	112.5 PK			2.35 V	55	102.73	9.77
5	*5755.00	102.0 AV			2.35 V	55	92.23	9.77
6	11510.00	49.3 PK	74.0	-24.7	1.66 V	245	34.45	14.85
7	11510.00	35.5 AV	54.0	-18.5	1.66 V	245	20.65	14.85
8	#17265.00	50.9 PK	74.0	-23.1	1.68 V	199	27.67	23.23
9	#17265.00	37.2 AV	54.0	-16.8	1.68 V	199	13.97	23.23

REMARKS:

1. Emission Level(dBuV/m) = Raw Value(dBuV) + Correction Factor(dB/m)
2. Correction Factor(dB/m) = Antenna Factor(dB/m) + Cable Factor(dB) – Pre-Amplifier Factor(dB)
3. The other emission levels were very low against the limit.
4. Margin value = Emission Level – Limit value
5. " * ": Fundamental frequency.
6. " # ": The radiated frequency is out of the restricted band.

CHANNEL	TX Channel 159	DETECTOR FUNCTION	Peak (PK)
FREQUENCY RANGE	1GHz ~ 40GHz		Average (AV)

ANTENNA POLARITY & TEST DISTANCE: HORIZONTAL AT 3 M

NO.	FREQ. (MHz)	EMISSION LEVEL (dBuV/m)	LIMIT (dBuV/m)	MARGIN (dB)	ANTENNA HEIGHT (m)	TABLE ANGLE (Degree)	RAW VALUE (dBuV)	CORRECTION FACTOR (dB/m)
1	*5795.00	113.3 PK			1.88 H	326	103.42	9.88
2	*5795.00	101.9 AV			1.88 H	326	92.02	9.88
3	#5850.00	63.8 PK	78.2	-14.4	1.88 H	326	53.88	9.92
4	#5860.00	60.3 PK	74.0	-13.7	1.88 H	326	50.37	9.93
5	#5860.00	47.4 AV	54.0	-6.6	1.88 H	326	37.47	9.93
6	11590.00	47.4 PK	74.0	-26.6	1.77 H	218	32.09	15.31
7	11590.00	33.5 AV	54.0	-20.5	1.77 H	218	18.19	15.31
8	#17385.00	51.4 PK	74.0	-22.6	1.51 H	299	27.64	23.76
9	#17385.00	37.6 AV	54.0	-16.4	1.51 H	299	13.84	23.76

ANTENNA POLARITY & TEST DISTANCE: VERTICAL AT 3 M

NO.	FREQ. (MHz)	EMISSION LEVEL (dBuV/m)	LIMIT (dBuV/m)	MARGIN (dB)	ANTENNA HEIGHT (m)	TABLE ANGLE (Degree)	RAW VALUE (dBuV)	CORRECTION FACTOR (dB/m)
1	*5795.00	120.2 PK			2.34 V	56	110.32	9.88
2	*5795.00	110.4 AV			2.34 V	56	100.52	9.88
3	#5850.00	70.2 PK	78.2	-8.0	2.34 V	56	60.28	9.92
4	#5860.00	66.4 PK	74.0	-7.6	2.34 V	56	56.47	9.93
5	#5860.00	53.5 AV	54.0	-0.5	2.34 V	56	43.57	9.93
6	11590.00	49.9 PK	74.0	-24.1	1.71 V	232	34.59	15.31
7	11590.00	35.8 AV	54.0	-18.2	1.71 V	232	20.49	15.31
8	#17385.00	51.1 PK	74.0	-22.9	1.59 V	180	27.34	23.76
9	#17385.00	37.9 AV	54.0	-16.1	1.59 V	180	14.14	23.76

REMARKS:

1. Emission Level(dBuV/m) = Raw Value(dBuV) + Correction Factor(dB/m)
2. Correction Factor(dB/m) = Antenna Factor(dB/m) + Cable Factor(dB) – Pre-Amplifier Factor(dB)
3. The other emission levels were very low against the limit.
4. Margin value = Emission Level – Limit value
5. " * ": Fundamental frequency.
6. " # ": The radiated frequency is out of the restricted band.

802.11ac (VHT80)

CHANNEL	TX Channel 42	DETECTOR FUNCTION	Peak (PK)
FREQUENCY RANGE	1GHz ~ 40GHz		Average (AV)

ANTENNA POLARITY & TEST DISTANCE: HORIZONTAL AT 3 M

NO.	FREQ. (MHz)	EMISSION LEVEL (dBuV/m)	LIMIT (dBuV/m)	MARGIN (dB)	ANTENNA HEIGHT (m)	TABLE ANGLE (Degree)	RAW VALUE (dBuV)	CORRECTION FACTOR (dB/m)
1	5150.00	58.3 PK	74.0	-15.7	1.86 H	343	49.97	8.33
2	5150.00	47.1 AV	54.0	-6.9	1.86 H	343	38.77	8.33
3	*5210.00	99.2 PK			1.86 H	343	90.65	8.55
4	*5210.00	87.4 AV			1.86 H	343	78.85	8.55
5	5350.00	49.6 PK	74.0	-24.4	1.86 H	343	40.80	8.80
6	5350.00	37.4 AV	54.0	-16.6	1.86 H	343	28.60	8.80
7	#10420.00	48.0 PK	74.0	-26.0	1.79 H	210	33.43	14.57
8	#10420.00	34.0 AV	54.0	-20.0	1.79 H	210	19.43	14.57
9	15630.00	51.5 PK	74.0	-22.5	1.49 H	285	32.57	18.93
10	15630.00	37.8 AV	54.0	-16.2	1.49 H	285	18.87	18.93

ANTENNA POLARITY & TEST DISTANCE: VERTICAL AT 3 M

NO.	FREQ. (MHz)	EMISSION LEVEL (dBuV/m)	LIMIT (dBuV/m)	MARGIN (dB)	ANTENNA HEIGHT (m)	TABLE ANGLE (Degree)	RAW VALUE (dBuV)	CORRECTION FACTOR (dB/m)
1	5150.00	64.6 PK	74.0	-9.4	2.39 V	59	56.27	8.33
2	5150.00	53.3 AV	54.0	-0.7	2.39 V	59	44.97	8.33
3	*5210.00	106.2 PK			2.39 V	59	97.65	8.55
4	*5210.00	95.9 AV			2.39 V	59	87.35	8.55
5	5350.00	55.7 PK	74.0	-18.3	2.39 V	59	46.90	8.80
6	5350.00	43.4 AV	54.0	-10.6	2.39 V	59	34.60	8.80
7	#10420.00	49.3 PK	74.0	-24.7	1.67 V	243	34.73	14.57
8	#10420.00	35.5 AV	54.0	-18.5	1.67 V	243	20.93	14.57
9	15630.00	51.4 PK	74.0	-22.6	1.59 V	198	32.47	18.93
10	15630.00	38.0 AV	54.0	-16.0	1.59 V	198	19.07	18.93

REMARKS:

- Emission Level(dBuV/m) = Raw Value(dBuV) + Correction Factor(dB/m)
- Correction Factor(dB/m) = Antenna Factor(dB/m) + Cable Factor(dB) – Pre-Amplifier Factor(dB)
- The other emission levels were very low against the limit.
- Margin value = Emission Level – Limit value
- " * ": Fundamental frequency.
- " # ": The radiated frequency is out of the restricted band.

CHANNEL	TX Channel 155	DETECTOR FUNCTION	Peak (PK)
FREQUENCY RANGE	1GHz ~ 40GHz		Average (AV)

ANTENNA POLARITY & TEST DISTANCE: HORIZONTAL AT 3 M

NO.	FREQ. (MHz)	EMISSION LEVEL (dBuV/m)	LIMIT (dBuV/m)	MARGIN (dB)	ANTENNA HEIGHT (m)	TABLE ANGLE (Degree)	RAW VALUE (dBuV)	CORRECTION FACTOR (dB/m)
1	#5715.00	61.6 PK	74.0	-12.4	1.87 H	332	51.92	9.68
2	#5715.00	47.4 AV	54.0	-6.6	1.87 H	332	37.72	9.68
3	#5725.00	68.1 PK	78.2	-10.1	1.87 H	332	58.40	9.70
4	*5775.00	98.7 PK			1.87 H	332	88.87	9.83
5	*5775.00	87.1 AV			1.87 H	332	77.27	9.83
6	#5850.00	50.6 PK	78.2	-27.6	1.87 H	332	40.68	9.92
7	#5860.00	49.4 PK	74.0	-24.6	1.87 H	332	39.47	9.93
8	#5860.00	38.4 AV	54.0	-15.6	1.87 H	332	28.47	9.93
9	11550.00	48.1 PK	74.0	-25.9	1.75 H	199	33.01	15.09
10	11550.00	33.7 AV	54.0	-20.3	1.75 H	199	18.61	15.09
11	#17325.00	51.5 PK	74.0	-22.5	1.41 H	298	28.12	23.38
12	#17325.00	37.8 AV	54.0	-16.2	1.41 H	298	14.42	23.38

ANTENNA POLARITY & TEST DISTANCE: VERTICAL AT 3 M

NO.	FREQ. (MHz)	EMISSION LEVEL (dBuV/m)	LIMIT (dBuV/m)	MARGIN (dB)	ANTENNA HEIGHT (m)	TABLE ANGLE (Degree)	RAW VALUE (dBuV)	CORRECTION FACTOR (dB/m)
1	#5715.00	67.9 PK	74.0	-6.1	2.37 V	56	58.22	9.68
2	#5715.00	53.5 AV	54.0	-0.5	2.37 V	56	43.82	9.68
3	#5725.00	74.4 PK	78.2	-3.8	2.37 V	56	64.70	9.70
4	*5775.00	105.8 PK			2.37 V	56	95.97	9.83
5	*5775.00	96.2 AV			2.37 V	56	86.37	9.83
6	#5850.00	56.9 PK	78.2	-21.3	2.37 V	56	46.98	9.92
7	#5860.00	55.3 PK	74.0	-18.7	2.37 V	56	45.37	9.93
8	#5860.00	44.5 AV	54.0	-9.5	2.37 V	56	34.57	9.93
9	11550.00	49.8 PK	74.0	-24.2	1.68 V	237	34.71	15.09
10	11550.00	35.9 AV	54.0	-18.1	1.68 V	237	20.81	15.09
11	#17325.00	51.5 PK	74.0	-22.5	1.68 V	194	28.12	23.38
12	#17325.00	37.8 AV	54.0	-16.2	1.68 V	194	14.42	23.38

REMARKS:

- Emission Level(dBuV/m) = Raw Value(dBuV) + Correction Factor(dB/m)
- Correction Factor(dB/m) = Antenna Factor(dB/m) + Cable Factor(dB) – Pre-Amplifier Factor(dB)
- The other emission levels were very low against the limit.
- Margin value = Emission Level – Limit value
- " * ": Fundamental frequency.
- " # ": The radiated frequency is out of the restricted band.

Below 1GHz Data:
802.11a

CHANNEL	TX Channel 165	DETECTOR FUNCTION	Quasi-Peak (QP)
FREQUENCY RANGE	Below 1GHz		

ANTENNA POLARITY & TEST DISTANCE: HORIZONTAL AT 3 M

NO.	FREQ. (MHz)	EMISSION LEVEL (dBuV/m)	LIMIT (dBuV/m)	MARGIN (dB)	ANTENNA HEIGHT (m)	TABLE ANGLE (Degree)	RAW VALUE (dBuV)	CORRECTION FACTOR (dB/m)
1	39.70	31.6 QP	40.0	-8.5	1.50 H	360	40.46	-8.91
2	66.47	27.3 QP	40.0	-12.7	1.00 H	246	36.93	-9.66
3	98.29	26.1 QP	43.5	-17.5	1.50 H	228	39.45	-13.40
4	250.00	33.3 QP	46.0	-12.8	1.00 H	251	42.52	-9.27
5	374.98	35.0 QP	46.0	-11.0	1.00 H	37	40.39	-5.43
6	750.03	34.4 QP	46.0	-11.6	1.50 H	360	31.95	2.49

ANTENNA POLARITY & TEST DISTANCE: VERTICAL AT 3 M

NO.	FREQ. (MHz)	EMISSION LEVEL (dBuV/m)	LIMIT (dBuV/m)	MARGIN (dB)	ANTENNA HEIGHT (m)	TABLE ANGLE (Degree)	RAW VALUE (dBuV)	CORRECTION FACTOR (dB/m)
1	70.89	26.3 QP	40.0	-13.7	1.00 V	360	36.47	-10.20
2	98.43	24.3 QP	43.5	-19.2	2.00 V	347	37.63	-13.35
3	196.40	24.3 QP	43.5	-19.3	1.00 V	129	35.63	-11.38
4	250.00	29.3 QP	46.0	-16.7	1.00 V	356	38.60	-9.27
5	375.03	34.6 QP	46.0	-11.4	1.00 V	12	40.09	-5.45
6	644.35	29.7 QP	46.0	-16.3	1.50 V	48	28.94	0.73

REMARKS:

1. Emission Level(dBuV/m) = Raw Value(dBuV) + Correction Factor(dB/m)
2. Correction Factor(dB/m) = Antenna Factor(dB/m) + Cable Factor(dB) – Pre-Amplifier Factor(dB)
3. The other emission levels were very low against the limit.
4. Margin value = Emission Level – Limit value

4.2 Conducted Emission Measurement

4.2.1 Limits of Conducted Emission Measurement

Frequency (MHz)	Conducted Limit (dBuV)	
	Quasi-peak	Average
0.15 - 0.5	66 - 56	56 - 46
0.50 - 5.0	56	46
5.0 - 30.0	60	50

Note: 1. The lower limit shall apply at the transition frequencies.

2. The limit decreases in line with the logarithm of the frequency in the range of 0.15 to 0.50MHz.

DESCRIPTION & MANUFACTURER	MODEL NO.	SERIAL NO.	CALIBRATED DATE	CALIBRATED UNTIL
Test Receiver R&S	ESCS 30	100375	May 06, 2015	May 05, 2016
Line-Impedance Stabilization Network (for EUT) SCHWARZBECK	NSLK-8127	8127-522	Sep. 01, 2015	Aug. 31, 2016
Line-Impedance Stabilization Network (for Peripheral) R&S	ENV216	100072	June 11, 2015	June 10, 2016
RF Cable	5D-FB	COCCAB-001	Mar. 09, 2015	Mar. 08, 2016
50 ohms Terminator	N/A	EMC-03	Sep. 23, 2015	Sep. 22, 2016
50 ohms Terminator	N/A	EMC-02	Oct. 01, 2015	Sep. 30, 2016
Software BVADT	BVADT_Cond_ V7.3.7.3	NA	NA	NA

Note:

1. The calibration interval of the above test instruments are 12 months and the calibrations are traceable to NML/ROC and NIST/USA.
2. The test was performed in Shielded Room No. C.
3. The VCCI Con C Registration No. is C-3611.
4. Tested Date: Dec. 16, 2015

4.2.2 Test Procedure

- a. The EUT was placed 0.4 meters from the conducting wall of the shielded room with EUT being connected to the power mains through a line impedance stabilization network (LISN). Other support units were connected to the power mains through another LISN. The two LISNs provide 50 ohm/ 50uH of coupling impedance for the measuring instrument.
- b. Both lines of the power mains connected to the EUT were checked for maximum conducted interference.
- c. The frequency range from 150kHz to 30MHz was searched. Emission levels under (Limit - 20dB) was not recorded.

NOTE: All modes of operation were investigated and the worst-case emissions are reported.

4.2.3 Deviation from Test Standard

No deviation.

4.2.4 Test Setup

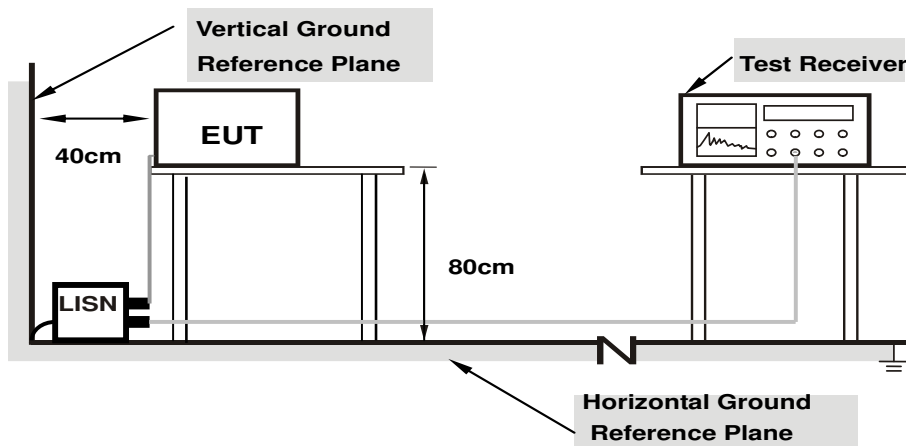

Note: 1.Support units were connected to second LISN.

For the actual test configuration, please refer to the attached file (Test Setup Photo).

4.2.5 EUT Operating Condition

Same as 4.1.6.

4.2.6 Test Results

Phase	Line (L)	Detector Function	Quasi-Peak (QP) / Average (AV)
-------	----------	-------------------	--------------------------------

Phase Of Power : Line (L)										
No	Frequency (MHz)	Correction Factor (dB)	Reading Value (dBuV)		Emission Level (dBuV)		Limit (dBuV)		Margin (dB)	
			Q.P.	AV.	Q.P.	AV.	Q.P.	AV.	Q.P.	AV.
1	0.27891	10.35	28.75	12.08	39.10	22.43	60.85	50.85	-21.75	-28.42
2	0.32969	10.36	26.26	5.72	36.62	16.08	59.46	49.46	-22.84	-33.38
3	0.59141	10.35	23.34	11.26	33.69	21.61	56.00	46.00	-22.31	-24.39
4	3.82813	10.56	15.51	8.90	26.07	19.46	56.00	46.00	-29.93	-26.54
5	9.32813	10.86	20.10	13.82	30.96	24.68	60.00	50.00	-29.04	-25.32
6	19.88672	11.45	19.36	13.27	30.81	24.72	60.00	50.00	-29.19	-25.28

Remarks:

1. Q.P. and AV. are abbreviations of quasi-peak and average individually.
2. The emission levels of other frequencies were very low against the limit.
3. Margin value = Emission level – Limit value
4. Correction factor = Insertion loss + Cable loss
5. Emission Level = Correction Factor + Reading Value

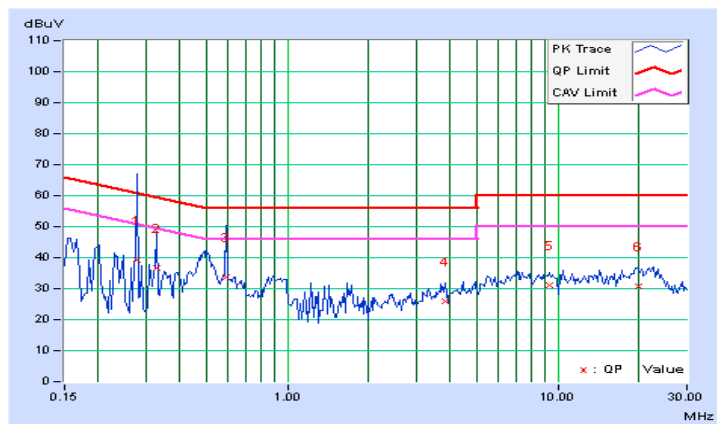

Phase	Neutral (N)	Detector Function	Quasi-Peak (QP) / Average (AV)
-------	-------------	-------------------	--------------------------------

Phase Of Power : Neutral (N)										
No	Frequency (MHz)	Correction Factor (dB)	Reading Value (dBuV)		Emission Level (dBuV)		Limit (dBuV)		Margin (dB)	
			Q.P.	AV.	Q.P.	AV.	Q.P.	AV.	Q.P.	AV.
1	0.23203	10.39	39.13	17.37	49.52	27.76	62.38	52.38	-12.85	-24.61
2	0.23984	10.40	33.73	15.31	44.13	25.71	62.10	52.10	-17.98	-26.40
3	0.36484	10.41	27.52	8.96	37.93	19.37	58.62	48.62	-20.68	-29.24
4	0.41953	10.42	22.81	9.08	33.23	19.50	57.46	47.46	-24.23	-27.96
5	0.48594	10.41	27.55	15.15	37.96	25.56	56.24	46.24	-18.27	-20.67
6	0.63438	10.40	20.96	7.60	31.36	18.00	56.00	46.00	-24.64	-28.00

Remarks:

1. Q.P. and AV. are abbreviations of quasi-peak and average individually.
2. The emission levels of other frequencies were very low against the limit.
3. Margin value = Emission level – Limit value
4. Correction factor = Insertion loss + Cable loss
5. Emission Level = Correction Factor + Reading Value

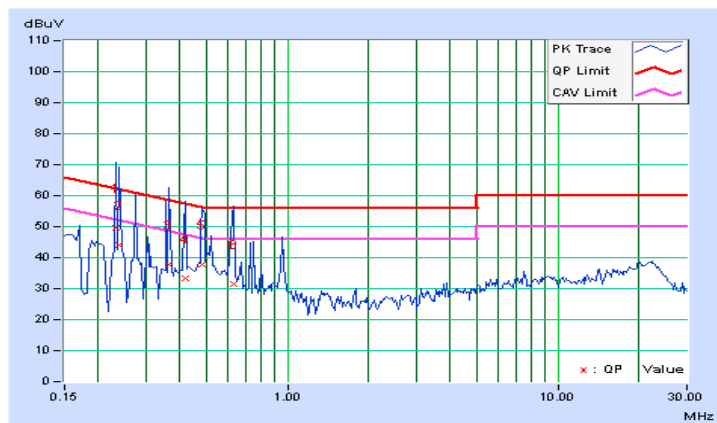

4.3 Transmit Power Measurement

4.3.1 Limits of Transmit Power Measurement

Operation Band	EUT Category		LIMIT
U-NII-1		Outdoor Access Point	1 Watt (30 dBm) (Max. e.i.r.p \leq 125mW(21 dBm) at any elevation angle above 30 degrees as measured from the horizon)
		Fixed point-to-point Access Point	1 Watt (30 dBm)
	√	Indoor Access Point	1 Watt (30 dBm)
		Mobile and Portable client device	250mW (24 dBm)
U-NII-2A	---		250mW (24 dBm) or 11 dBm+10 log B*
U-NII-2C	---		250mW (24 dBm) or 11 dBm+10 log B*
U-NII-3	√		1 Watt (30 dBm)

*B is the 26 dB emission bandwidth in megahertz

Per KDB 662911 Method of conducted output power measurement on IEEE 802.11 devices,

Array Gain = 0 dB (i.e., no array gain) for $N_{ANT} \leq 4$;

Array Gain = 0 dB (i.e., no array gain) for channel widths ≥ 40 MHz for any N_{ANT} ;

Array Gain = $5 \log(N_{ANT}/N_{SS})$ dB or 3 dB, whichever is less for 20-MHz channel widths with $N_{ANT} \geq 5$.

For power measurements on all other devices: Array Gain = $10 \log(N_{ANT}/N_{SS})$ dB.

4.3.2 Test Setup

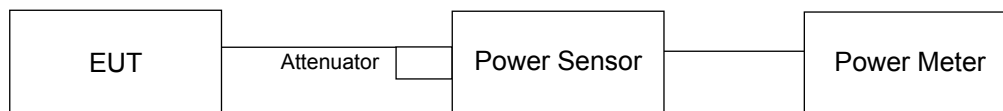

4.3.3 Test Instruments

Refer to section 4.1.2 to get information of above instrument.

4.3.4 Test Procedure

Method PM is used to perform output power measurement, trigger and gating function of wide band power meter is enabled to measure max output power of TX on burst. Duty factor is not added to measured value.

4.3.5 Deviation from Test Standard

No deviation.

4.3.6 EUT Operating Condition

The software provided by client to enable the EUT under transmission condition continuously at lowest, middle and highest channel frequencies individually.

4.3.7 Test Result (Mode 1)

POWER OUTPUT:

802.11a

Chan.	Chan. Freq. (MHz)	Average Power (mW)	Average Power (dBm)	Limit (dBm)	Pass / Fail
36	5180	182.81	22.62	29.97	Pass
40	5200	174.582	22.42	29.97	Pass
48	5240	162.181	22.10	29.97	Pass
149	5745	133.66	21.26	30.00	Pass
157	5785	162.93	22.12	30.00	Pass
165	5825	161.065	22.07	30.00	Pass

NOTE: 5.180 - 5.240 GHz: The directional gain is 6.03dBi > 6dBi, therefore the limit needs to reduce, so the power limit shall be reduced to $30-(6.03-6) = 29.97\text{dBm}$.

802.11ac (VHT20)

Chan.	Chan. Freq. (MHz)	Average Power (mW)	Average Power (dBm)	Limit (dBm)	Pass / Fail
36	5180	180.717	22.57	29.97	Pass
40	5200	173.38	22.39	29.97	Pass
48	5240	159.956	22.04	29.97	Pass
149	5745	148.936	21.73	30	Pass
157	5785	163.682	22.14	30	Pass
165	5825	161.808	22.09	30	Pass

NOTE: 5.180 - 5.240 GHz: The directional gain is 6.03dBi > 6dBi, therefore the limit needs to reduce, so the power limit shall be reduced to $30-(6.03-6) = 29.97\text{dBm}$.

802.11ac (VHT40)

Chan.	Chan. Freq. (MHz)	Average Power (mW)	Average Power (dBm)	Limit (dBm)	Pass / Fail
38	5190	116.95	20.68	29.97	Pass
46	5230	159.221	22.02	29.97	Pass
151	5755	99.541	19.98	30	Pass
159	5795	160.694	22.06	30	Pass

NOTE: 5.180 - 5.240 GHz: The directional gain is 6.03dBi > 6dBi, therefore the limit needs to reduce, so the power limit shall be reduced to $30-(6.03-6) = 29.97\text{dBm}$.

802.11ac (VHT80)

Chan.	Chan. Freq. (MHz)	Average Power (mW)	Average Power (dBm)	Limit (dBm)	Pass / Fail
42	5210	96.605	19.85	29.97	Pass
155	5775	51.523	17.12	30	Pass

NOTE: 5.180 - 5.240 GHz: The directional gain is 6.03dBi > 6dBi, therefore the limit needs to reduce, so the power limit shall be reduced to $30 - (6.03 - 6) = 29.97\text{dBm}$.

4.3.8 Test Result (Mode 2)

POWER OUTPUT:

802.11a

Chan.	Chan. Freq. (MHz)	Average Power (mW)	Average Power (dBm)	Limit (dBm)	Pass / Fail
36	5180	187.499	22.73	30	Pass
40	5200	191.867	22.83	30	Pass
48	5240	195.884	22.92	30	Pass
149	5745	119.95	20.79	30	Pass
157	5785	162.181	22.10	30	Pass
165	5825	163.305	22.13	30	Pass

802.11ac (VHT20)

Chan.	Chan. Freq. (MHz)	Average Power (mW)	Average Power (dBm)	Limit (dBm)	Pass / Fail
36	5180	189.234	22.77	30	Pass
40	5200	193.197	22.86	30	Pass
48	5240	196.789	22.94	30	Pass
149	5745	118.304	20.73	30	Pass
157	5785	158.855	22.01	30	Pass
165	5825	161.065	22.07	30	Pass

802.11ac (VHT40)

Chan.	Chan. Freq. (MHz)	Average Power (mW)	Average Power (dBm)	Limit (dBm)	Pass / Fail
38	5190	102.329	20.10	30	Pass
46	5230	190.108	22.79	30	Pass
151	5755	56.494	17.52	30	Pass
159	5795	162.181	22.10	30	Pass

802.11ac (VHT80)

Chan.	Chan. Freq. (MHz)	Average Power (mW)	Average Power (dBm)	Limit (dBm)	Pass / Fail
42	5210	63.387	18.02	30	Pass
155	5775	38.282	15.83	30	Pass

4.3.9 Test Result (Mode 3)

POWER OUTPUT:

802.11a

Chan.	Freq. (MHz)	Average Power (dBm)		Total Power (mW)	Total Power (dBm)	Power Limit (dBm)	Pass / Fail
		Chain 0	Chain 1				
36	5180	21.44	21.49	280.245	24.48	29.97	Pass
40	5200	22.06	22.76	349.493	25.43	29.97	Pass
48	5240	22.05	22.93	356.661	25.52	29.97	Pass
149	5745	19.91	20.54	211.189	23.25	30.00	Pass
157	5785	22.19	22.75	353.942	25.49	30.00	Pass
165	5825	22.48	23.16	384.025	25.84	30.00	Pass

Note: 5.180 - 5.240 GHz: Directional gain = 6.03dBi > 6dBi , so the power limit shall be reduced to $30-(6.03-6) = 29.97\text{dBm}$.

802.11ac (VHT20)

Chan.	Freq. (MHz)	Average Power (dBm)		Total Power (mW)	Total Power (dBm)	Power Limit (dBm)	Pass / Fail
		Chain 0	Chain 1				
36	5180	21.35	21.54	279.019	24.46	29.97	Pass
40	5200	22.16	22.99	363.504	25.61	29.97	Pass
48	5240	22.23	23.04	368.481	25.66	29.97	Pass
149	5745	20.08	19.40	188.955	22.76	30.00	Pass
157	5785	22.36	22.80	362.733	25.60	30.00	Pass
165	5825	22.35	22.92	367.675	25.65	30.00	Pass

Note: 5.180 - 5.240 GHz: Directional gain = 6.03dBi > 6dBi , so the power limit shall be reduced to $30-(6.03-6) = 29.97\text{dBm}$.

802.11ac (VHT40)

Chan.	Freq. (MHz)	Average Power (dBm)		Total Power (mW)	Total Power (dBm)	Power Limit (dBm)	Pass / Fail
		Chain 0	Chain 1				
38	5190	17.32	18.05	117.777	20.71	29.97	Pass
46	5230	22.20	23.01	365.945	25.63	29.97	Pass
151	5755	15.73	15.01	69.107	18.40	30.00	Pass
159	5795	22.71	21.41	324.995	25.12	30.00	Pass

Note: 5.180 - 5.240 GHz: Directional gain = 6.03dBi > 6dBi , so the power limit shall be reduced to $30-(6.03-6) = 29.97\text{dBm}$.

802.11ac (VHT80)

Chan.	Chan. Freq. (MHz)	Average Power (dBm)		Total Power (mW)	Total Power (dBm)	Power Limit (dBm)	Pass / Fail
		Chain 0	Chain 1				
42	5210	15.59	16.72	83.213	19.20	29.97	Pass
155	5775	11.70	12.18	31.311	14.96	30.00	Pass

Note: 5.180 - 5.240 GHz: Directional gain = 6.03dBi > 6dBi , so the power limit shall be reduced to $30-(6.03-6) = 29.97\text{dBm}$.

4.4 Peak Power Spectral Density Measurement

4.4.1 Limits of Peak Power Spectral Density Measurement

Operation Band	EUT Category		LIMIT
U-NII-1		Outdoor Access Point	17dBm/ MHz
		Fixed point-to-point Access Point	
		Indoor Access Point	
	√	Mobile and Portable client device	11dBm/ MHz
U-NII-2A	---		11dBm/ MHz
U-NII-2C	---		11dBm/ MHz
U-NII-3	√		30dBm/ 500kHz

4.4.2 Test Setup

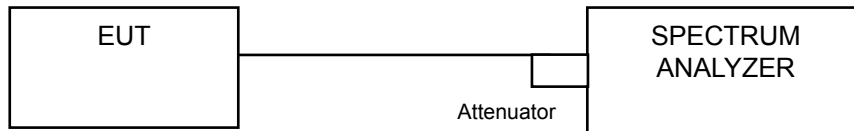

4.4.3 Test Instruments

Refer to section 4.1.2 to get information of above instrument.

4.4.4 Test Procedure

For 802.11a & 802.11ac (VHT20):

Using method SA-1

For U-NII-1 band:

1. Set span to encompass the entire emission bandwidth (EBW) of the signal.
2. Set RBW = 1 MHz, Set VBW \geq 3 MHz, Detector = RMS
3. Sweep time = auto, trigger set to "free run".
4. Trace average at least 100 traces in power averaging mode.
5. Record the max value

For U-NII-3 band:

1. Set span to encompass the entire emission bandwidth (EBW) of the signal.
2. Set RBW = 300 kHz, Set VBW \geq 1 MHz, Detector = RMS
3. Use the peak marker function to determine the maximum power level in any 300 kHz band segment within the fundamental EBW.
4. Scale the observed power level to an equivalent value in 500 kHz by adjusting (reducing) the measured power by a bandwidth correction factor (BWCF) where $BWCF = 10\log(500 \text{ kHz}/300\text{kHz})$
5. Sweep time = auto, trigger set to "free run".
6. Trace average at least 100 traces in power averaging mode.
7. Record the max value

For 802.11ac (VHT40), 802.11ac(VHT80):

Using method SA-2

For U-NII-1 band:

1. Set span to encompass the entire emission bandwidth (EBW) of the signal.
2. Set RBW = 1 MHz, Set VBW \geq 3 MHz, Detector = RMS
3. Sweep time = auto, trigger set to "free run".
4. Trace average at least 100 traces in power averaging mode.
5. Record the max value and add $10 \log (1/\text{duty cycle})$

For U-NII-3 band:

1. Set span to encompass the entire emission bandwidth (EBW) of the signal.
2. Set RBW = 300 kHz, Set VBW \geq 1 MHz, Detector = RMS
3. Use the peak marker function to determine the maximum power level in any 300 kHz band segment within the fundamental EBW.
4. Scale the observed power level to an equivalent value in 500 kHz by adjusting (reducing) the measured power by a bandwidth correction factor (BWCF) where $BWCF = 10\log(500 \text{ kHz}/300\text{kHz})$
5. Sweep time = auto, trigger set to "free run".
6. Trace average at least 100 traces in power averaging mode.
7. Record the max value and add $10 \log (1/\text{duty cycle})$

4.4.5 Deviation from Test Standard

No deviation.

4.4.6 EUT Operating Condition

Same as Item 4.3.6.

4.4.7 Test Results (Mode 1)

For U-NII-1 Band

802.11a

Chan.	Chan. Freq. (MHz)	PSD (dBm/MHz)	MAX. Limit (dBm/MHz)	Pass / Fail
36	5180	7.78	16.97	Pass
40	5200	7.45	16.97	Pass
48	5240	8.23	16.97	Pass

Note: 1. The directional gain is 6.03dBi > 6dBi, therefore the limit needs to reduce, so the power density limit shall be reduced to $17-(6.03-6) = 16.97$ dBm.

802.11ac (VHT20)

Chan.	Chan. Freq. (MHz)	PSD (dBm/MHz)	MAX. Limit (dBm/MHz)	Pass / Fail
36	5180	8.71	16.97	Pass
40	5200	8.49	16.97	Pass
48	5240	7.90	16.97	Pass

Note: 1. The directional gain is 6.03dBi > 6dBi, therefore the limit needs to reduce, so the power density limit shall be reduced to $17-(6.03-6) = 16.97$ dBm.

802.11ac (VHT40)

Chan.	Chan. Freq. (MHz)	Conducted PSD W/O Duty Factor (dBm/MHz)	Duty Factor (dB)	PSD With Duty Factor (dBm/MHz)	MAX. EIRP Limit (dBm/MHz)	Pass / Fail
36	5180	4.17	0.15	4.32	16.97	Pass
40	5200	5.51	0.15	5.66	16.97	Pass

Note: 1. The directional gain is 6.03dBi > 6dBi, therefore the limit needs to reduce, so the power density limit shall be reduced to $17-(6.03-6) = 16.97$ dBm.

2. Refer to section 3.3 for duty cycle spectrum plot.

802.11ac (VHT80)

Chan.	Chan. Freq. (MHz)	Conducted PSD W/O Duty Factor (dBm/MHz)	Duty Factor (dB)	PSD With Duty Factor (dBm/MHz)	MAX. EIRP Limit (dBm/MHz)	Pass / Fail
42	5210	0.70	0.29	0.99	16.97	Pass

Note: 1. The directional gain is 6.03dBi > 6dBi, therefore the limit needs to reduce, so the power density limit shall be reduced to $17-(6.03-6) = 16.97$ dBm.

2. Refer to section 3.3 for duty cycle spectrum plot.

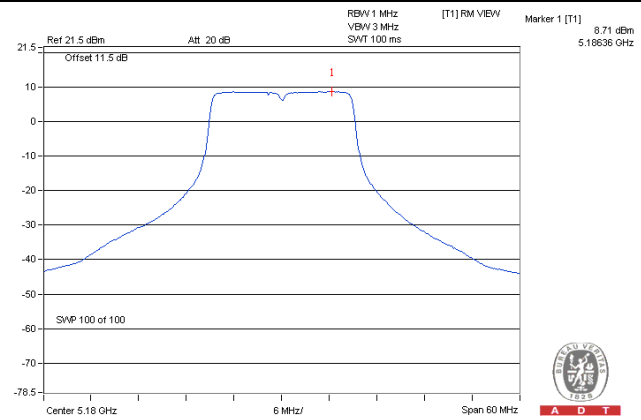
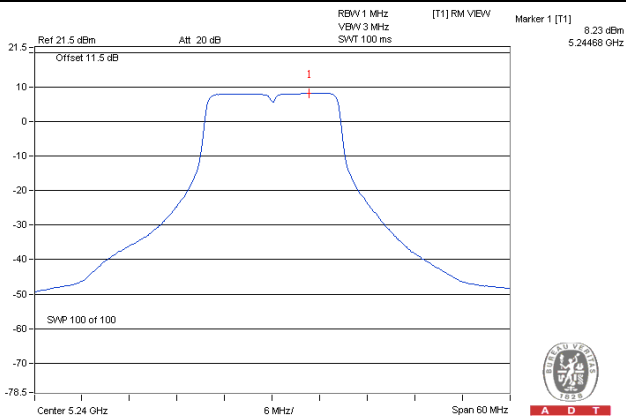
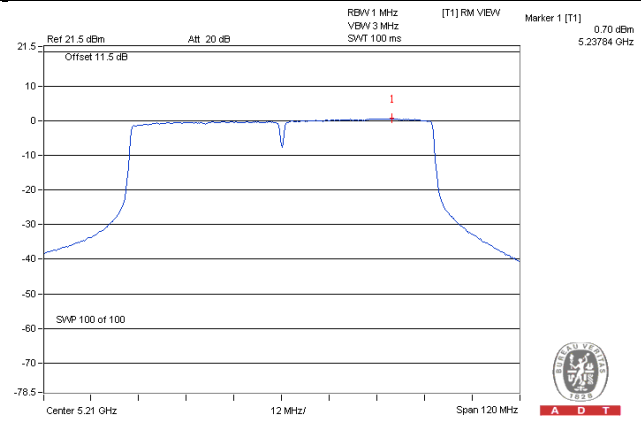
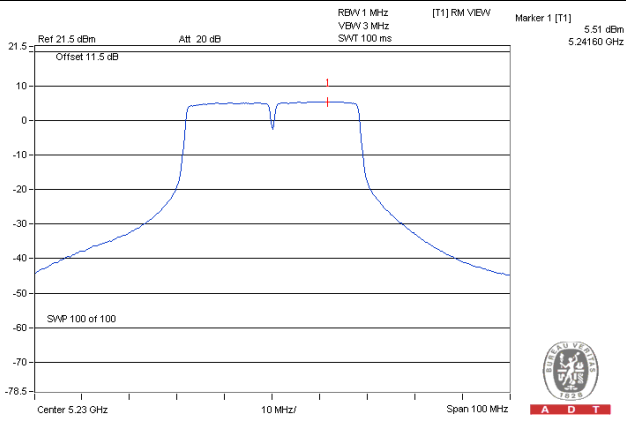
Spectrum Plot of Worst Value**802.11a – CH 48****802.11ac (VHT20) – CH 36****802.11ac (VHT40) – CH 40****802.11ac (VHT80) – CH 42**

For U-NII-3 Band
802.11a

Chan.	Chan. Freq. (MHz)	PSD (dBm/300kHz)	PSD (dBm/500kHz)	Limit (dBm/500kHz)	Pass /Fail
149	5745	0.54	2.76	30	Pass
157	5785	0.59	2.81	30	Pass
165	5825	0.45	2.67	30	Pass

802.11ac (VHT20)

Chan.	Chan. Freq. (MHz)	PSD (dBm/300kHz)	PSD (dBm/500kHz)	Limit (dBm/500kHz)	Pass /Fail
149	5745	-0.12	2.10	30	Pass
157	5785	0.42	2.64	30	Pass
165	5825	0.01	2.23	30	Pass

802.11ac (VHT40)

Chan.	Chan. Freq. (MHz)	PSD W/O Duty Factor		Duty Factor (dB)	Total PSD With Duty Factor (dBm/500kHz)	Limit (dBm/500kHz)	Pass /Fail
		(dBm/300kHz)	(dBm/500kHz)				
151	5745	-4.28	-2.06	0.15	-1.91	30	Pass
159	5785	-2.25	-0.03	0.15	0.12	30	Pass

Note: 1. Refer to section 3.3 for duty cycle spectrum plot.

802.11ac (VHT80)

Chan.	Chan. Freq. (MHz)	PSD W/O Duty Factor		Duty Factor (dB)	Total PSD With Duty Factor (dBm/500kHz)	Limit (dBm/500kHz)	Pass /Fail
		(dBm/300kHz)	(dBm/500kHz)				
155	5745	-8.79	-6.57	0.29	-6.28	30	Pass

Note: 1. Refer to section 3.3 for duty cycle spectrum plot.

Spectrum Plot of Worst Value

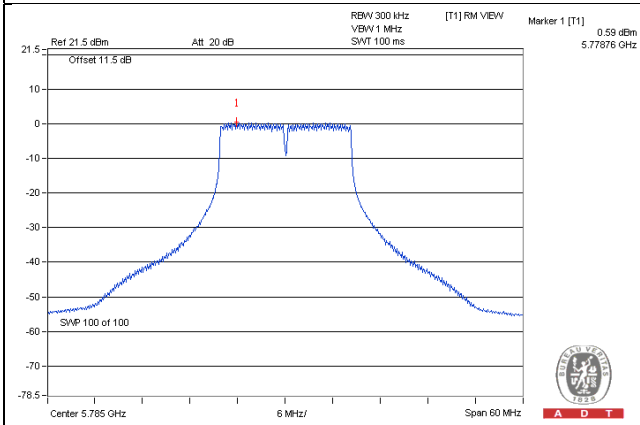
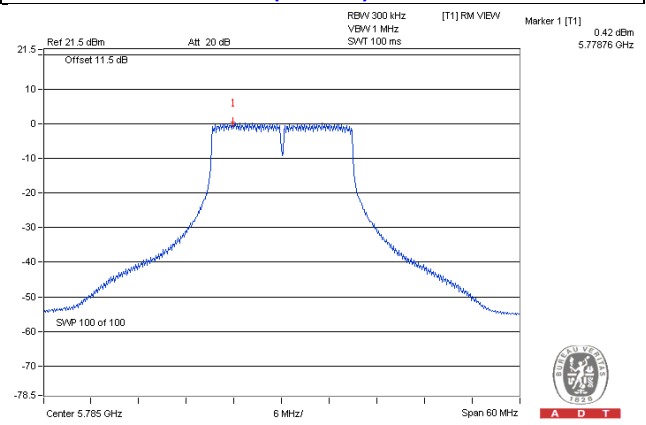
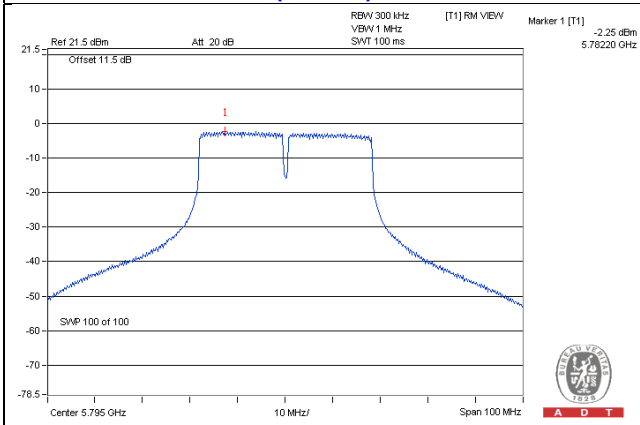
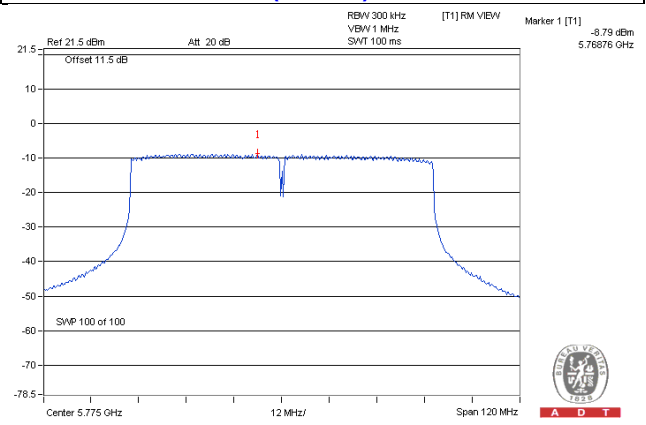
802.11a – CH 157**802.11ac (VHT20) – CH 157****802.11ac (VHT40) – CH 159****802.11ac (VHT80) – CH 155**

4.4.8 Test Results (Mode 2)
**For U-NII-1 Band
802.11a**

Chan.	Chan. Freq. (MHz)	PSD (dBm/MHz)	MAX. Limit (dBm/MHz)	Pass / Fail
36	5180	9.87	17	Pass
40	5200	9.72	17	Pass
48	5240	9.74	17	Pass

802.11ac (VHT20)

Chan.	Chan. Freq. (MHz)	PSD (dBm/MHz)	MAX. Limit (dBm/MHz)	Pass / Fail
36	5180	9.24	17	Pass
40	5200	9.56	17	Pass
48	5240	9.02	17	Pass

802.11ac (VHT40)

Chan.	Chan. Freq. (MHz)	Conducted PSD W/O Duty Factor (dBm/MHz)	Duty Factor (dB)	PSD With Duty Factor (dBm/MHz)	MAX. EIRP Limit (dBm/MHz)	Pass / Fail
36	5180	3.72	0.15	3.87	17	Pass
40	5200	5.68	0.15	5.83	17	Pass

Note: 1. Refer to section 3.3 for duty cycle spectrum plot.

802.11ac (VHT80)

Chan.	Chan. Freq. (MHz)	Conducted PSD W/O Duty Factor (dBm/MHz)	Duty Factor (dB)	PSD With Duty Factor (dBm/MHz)	MAX. EIRP Limit (dBm/MHz)	Pass / Fail
42	5210	-1.81	0.29	-1.52	17	Pass

Note: 1. Refer to section 3.3 for duty cycle spectrum plot.

Spectrum Plot of Worst Value

802.11a – CH 36

802.11ac (VHT20) – CH 40

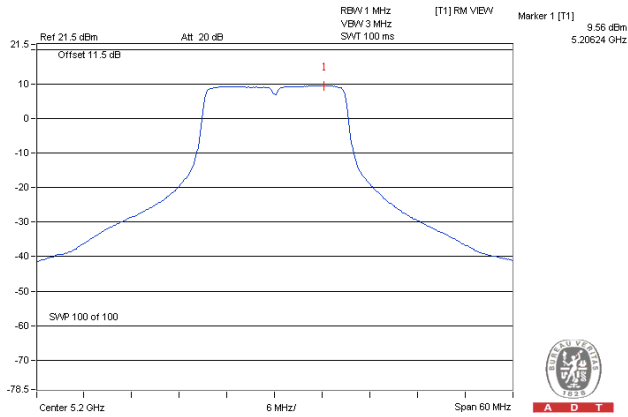
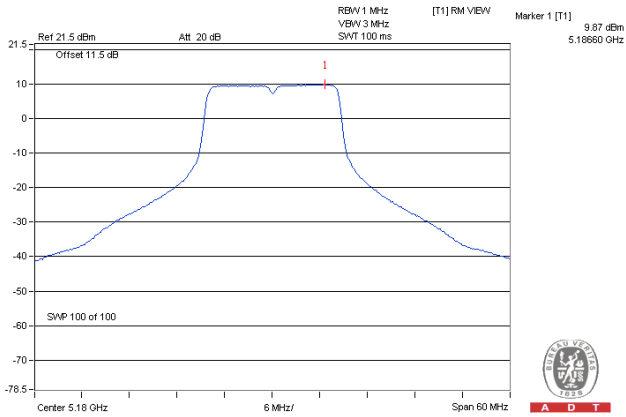

802.11ac (VHT40) – CH 40

802.11ac (VHT80) – CH 42

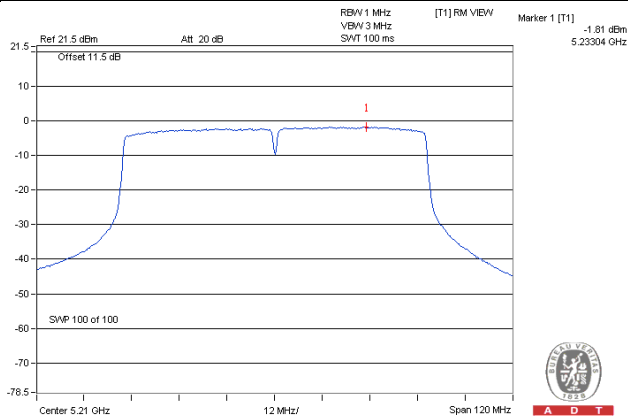
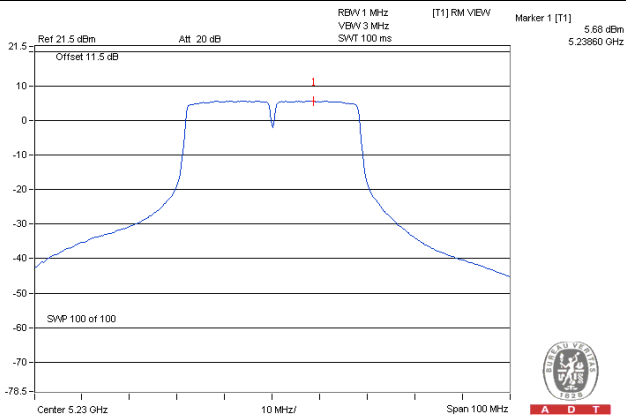

For U-NII-3 Band
802.11a

Chan.	Chan. Freq. (MHz)	PSD (dBm/300kHz)	PSD (dBm/500kHz)	Limit (dBm/500kHz)	Pass /Fail
149	5745	0.43	2.65	30	Pass
157	5785	1.38	3.60	30	Pass
165	5825	1.06	3.28	30	Pass

802.11ac (VHT20)

Chan.	Chan. Freq. (MHz)	PSD (dBm/300kHz)	PSD (dBm/500kHz)	Limit (dBm/500kHz)	Pass /Fail
149	5745	-0.43	1.79	30	Pass
157	5785	1.07	3.29	30	Pass
165	5825	0.84	3.06	30	Pass

802.11ac (VHT40)

Chan.	Chan. Freq. (MHz)	PSD W/O Duty Factor		Duty Factor (dB)	Total PSD With Duty Factor (dBm/500kHz)	Limit (dBm/500kHz)	Pass /Fail
		(dBm/300kHz)	(dBm/500kHz)				
151	5745	-6.30	-4.08	0.15	-3.93	30	Pass
159	5785	-1.93	0.29	0.15	0.44	30	Pass

Note: 1. Refer to section 3.3 for duty cycle spectrum plot.

802.11ac (VHT80)

Chan.	Chan. Freq. (MHz)	PSD W/O Duty Factor		Duty Factor (dB)	Total PSD With Duty Factor (dBm/500kHz)	Limit (dBm/500kHz)	Pass /Fail
		(dBm/300kHz)	(dBm/500kHz)				
155	5745	-12.61	-10.39	0.29	-10.10	30	Pass

Note: 1. Refer to section 3.3 for duty cycle spectrum plot.

Spectrum Plot of Worst Value

802.11a – CH 157

802.11ac (VHT20) – CH 157

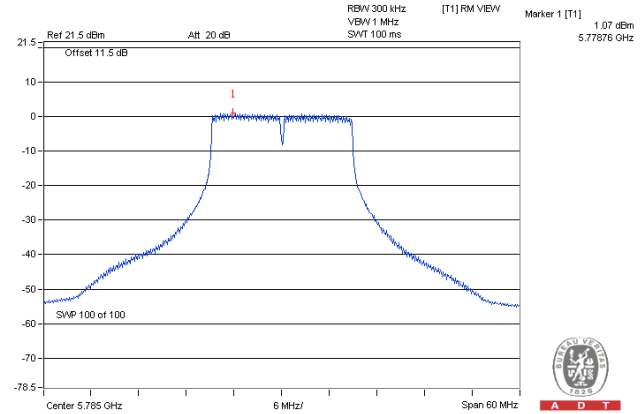
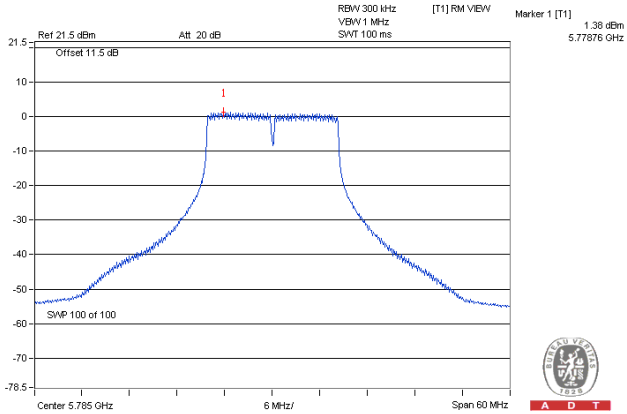

802.11ac (VHT40) – CH 159

802.11ac (VHT80) – CH 155

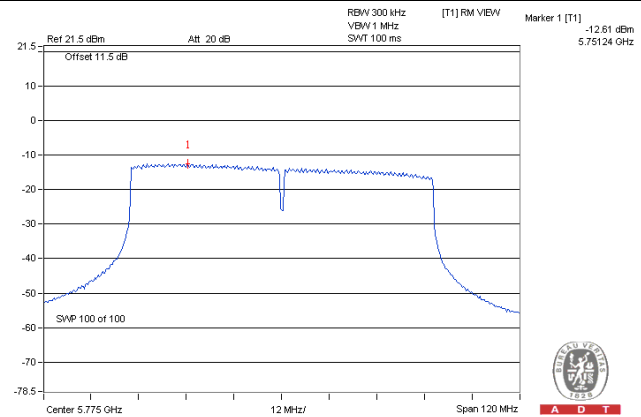
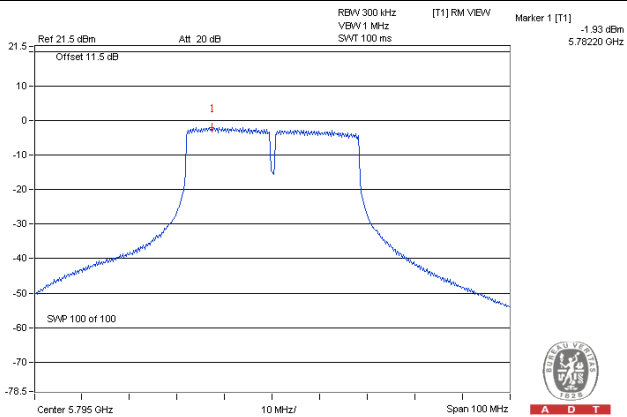

4.4.9 Test Results (Mode 3)

For U-NII-1 Band 802.11a

Chan.	Chan. Freq. (MHz)	PSD (dBm)		Total Power Density (dBm)	Max. Limit (dBm)	Pass / Fail
		Chain 0	Chain 1			
36	5180	8.12	8.50	11.32	14.41	Pass
40	5200	8.76	9.91	12.38	14.41	Pass
48	5240	8.92	10.04	12.53	14.41	Pass

NOTE: 1. Method 1 of power density measurement of KDB 662911 is using for calculating total power density. Total power density is summing entire spectra across corresponding frequency bins on the various outputs by computer.

2. Directional gain = $10 \log[(10^{G1/20} + 10^{G2/20})^2 / 2] = 8.59\text{dBi} > 6\text{dBi}$, so the power limit shall be reduced to $17-(8.59-6) = 14.41\text{dBm}$.

802.11ac (VHT20)

Chan.	Chan. Freq. (MHz)	PSD (dBm)		Total Power Density (dBm)	Max. Limit (dBm)	Pass / Fail
		Chain 0	Chain 1			
36	5180	8.52	8.61	11.58	14.41	PASS
40	5200	9.03	9.84	12.46	14.41	PASS
48	5240	8.85	10.18	12.58	14.41	PASS

NOTE: 1. Method 1 of power density measurement of KDB 662911 is using for calculating total power density. Total power density is summing entire spectra across corresponding frequency bins on the various outputs by computer.

2. Directional gain = $10 \log[(10^{G1/20} + 10^{G2/20})^2 / 2] = 8.59\text{dBi} > 6\text{dBi}$, so the power limit shall be reduced to $17-(8.59-6) = 14.41\text{dBm}$.

802.11ac (VHT40)

Chan.	Freq. (MHz)	PSD W/O Duty Factor (dBm)		Duty Factor	Total PSD with Duty Factor (dBm)	Max. Limit (dBm)	Pass / Fail
		Chain 0	Chain 1				
38	5190	1.38	1.81	0.15	4.76	14.41	Pass
46	5230	7.18	7.87	0.15	10.70	14.41	Pass

NOTE: 1. Method 1 of power density measurement of KDB 662911 is using for calculating total power density. Total power density is summing entire spectra across corresponding frequency bins on the various outputs by computer.

2. Directional gain = $10 \log[(10^{G1/20} + 10^{G2/20})^2 / 2] = 8.59\text{dBi} > 6\text{dBi}$, so the power limit shall be reduced to $17-(8.59-6) = 14.41\text{dBm}$.

3. Refer to section 3.3 for duty cycle spectrum plot.

802.11ac (VHT80)

Chan.	Freq. (MHz)	PSD W/O Duty Factor (dBm)		Duty Factor	Total PSD with Duty Factor (dBm)	Max. Limit (dBm)	Pass / Fail
		Chain 0	Chain 1				
42	5210	-3.72	-3.07	0.29	-0.08	14.41	PASS

- NOTE:** 1. Method 1 of power density measurement of KDB 662911 is using for calculating total power density. Total power density is summing entire spectra across corresponding frequency bins on the various outputs by computer.
2. Directional gain = $10 \log[(10^{G1/20} + 10^{G2/20})^2 / 2] = 8.59\text{dBi} > 6\text{dBi}$, so the power limit shall be reduced to $17 - (8.59 - 6) = 14.41\text{dBm}$.
3. Refer to section 3.3 for duty cycle spectrum plot.

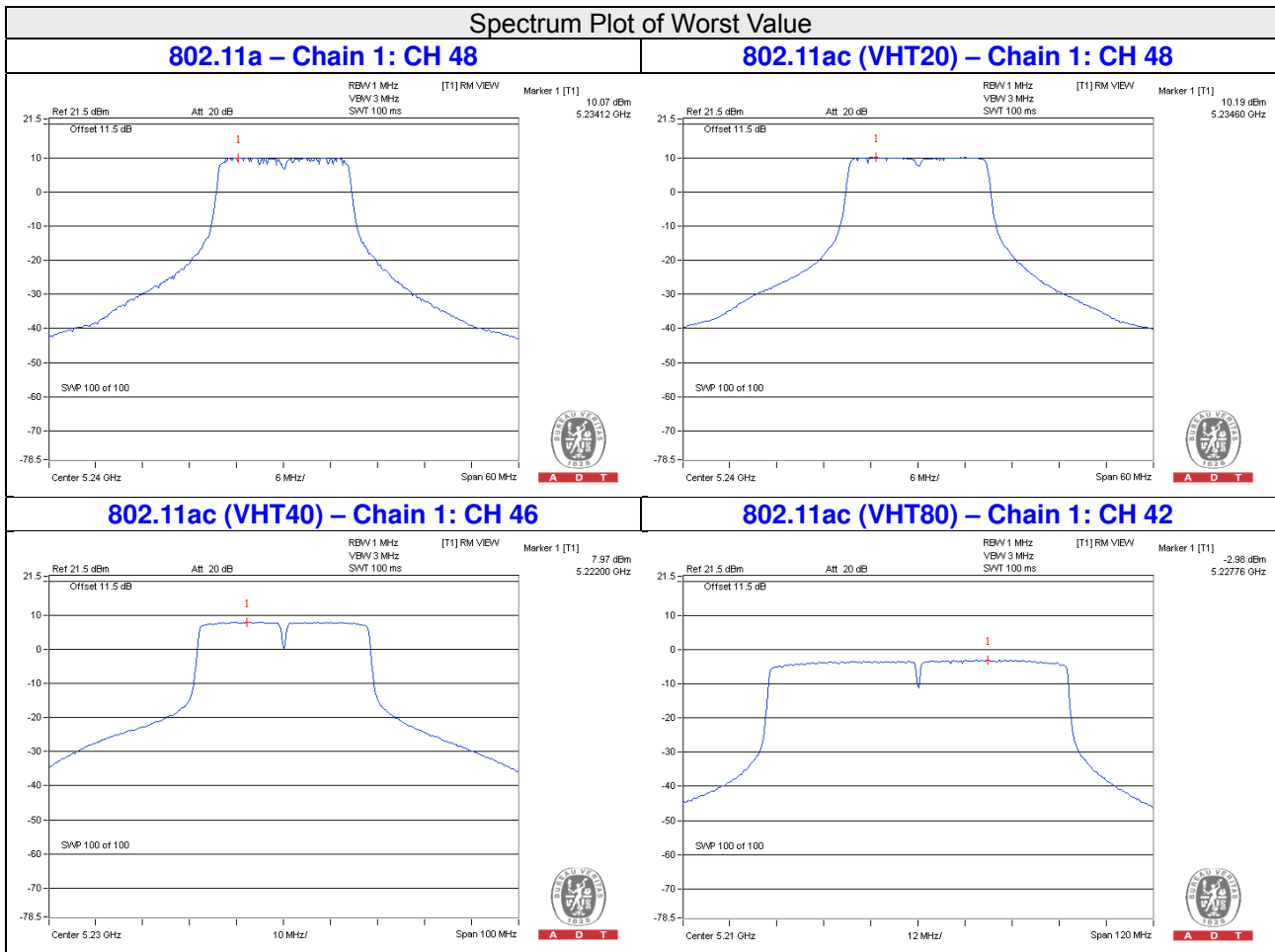

For U-NII-3 Band

802.11a

TX chain	Channel	Freq. (MHz)	PSD		10 log (N=2) dB	Total PSD (dBm/500kHz)	Limit (dBm/500kHz)	Pass /Fail
			(dBm/300kHz)	(dBm/500kHz)				
0	149	5745	-1.37	0.85	3.01	3.86	27.53	Pass
	157	5785	1.34	3.56	3.01	6.57	27.53	Pass
	165	5825	1.85	4.07	3.01	7.08	27.53	Pass
1	149	5745	0.21	2.43	3.01	5.44	27.53	Pass
	157	5785	1.95	4.17	3.01	7.18	27.53	Pass
	165	5825	2.40	4.62	3.01	7.63	27.53	Pass

NOTE: 1. Method 1 of power density measurement of KDB 662911 is using for calculating total power density. Total power density is summing entire spectra across corresponding frequency bins on the various outputs by computer.

2. Directional gain = $10 \log[(10^{G1/20} + 10^{G2/20})^2 / 2]$ = 8.47dBi > 6dBi , so the power limit shall be reduced to $30-(8.47-6) = 27.53$ dBm.

802.11ac (VHT20)

TX chain	Channel	Freq. (MHz)	PSD		10 log (N=2) dB	Total PSD (dBm/500kHz)	Limit (dBm/500kHz)	Pass /Fail
			(dBm/300kHz)	(dBm/500kHz)				
0	149	5745	-1.75	0.47	3.01	3.48	27.53	Pass
	157	5785	0.99	3.21	3.01	6.22	27.53	Pass
	165	5825	2.33	4.55	3.01	7.56	27.53	Pass
1	149	5745	-0.57	1.65	3.01	4.66	27.53	Pass
	157	5785	1.75	3.97	3.01	6.98	27.53	Pass
	165	5825	3.05	5.27	3.01	8.28	27.53	Pass

NOTE: 1. Method 1 of power density measurement of KDB 662911 is using for calculating total power density. Total power density is summing entire spectra across corresponding frequency bins on the various outputs by computer.

2. Directional gain = $10 \log[(10^{G1/20} + 10^{G2/20})^2 / 2]$ = 8.47dBi > 6dBi , so the power limit shall be reduced to $30-(8.47-6) = 27.53$ dBm.

802.11ac (VHT40)

TX Chain	Channel	Frequency (MHz)	PSD W/O Duty Factor		10 log (N=2) dB	Duty Factor (dB)	Total PSD with Duty Factor (dBm/500kHz)	Limit (dBm/500kHz)	Pass /Fail
			(dBm/300kHz)	(dBm/500kHz)					
0	151	5755	-9.65	-7.43	3.01	0.15	-4.27	27.53	Pass
	159	5795	-1.81	0.41	3.01	0.15	3.57	27.53	Pass
1	151	5755	-8.26	-6.04	3.01	0.15	-2.88	27.53	Pass
	159	5795	-0.71	1.51	3.01	0.15	4.67	27.53	Pass

NOTE: 1. Method 1 of power density measurement of KDB 662911 is using for calculating total power density. Total power density is summing entire spectra across corresponding frequency bins on the various outputs by computer.

2. Directional gain = $10 \log[(10^{G1/20} + 10^{G2/20})^2 / 2] = 8.47\text{dBi} > 6\text{dBi}$, so the power limit shall be reduced to $30-(8.47-6) = 27.53\text{dBm}$.

3. Refer to section 3.3 for duty cycle spectrum plot.

802.11ac (VHT80)

TX Chain	Channel	Frequency (MHz)	PSD W/O Duty Factor		10 log (N=2) dB	Duty Factor (dB)	Total PSD with Duty Factor (dBm/500kHz)	Limit (dBm/500kHz)	Pass /Fail
			(dBm/300kHz)	(dBm/500kHz)					
0	155	5775	-16.46	-14.24	3.01	0.29	-10.94	27.53	Pass
1	155	5775	-14.92	-12.70	3.01	0.29	-9.40	27.53	Pass

NOTE: 1. Method 1 of power density measurement of KDB 662911 is using for calculating total power density. Total power density is summing entire spectra across corresponding frequency bins on the various outputs by computer.

2. Directional gain = $10 \log[(10^{G1/20} + 10^{G2/20})^2 / 2] = 8.47\text{dBi} > 6\text{dBi}$, so the power limit shall be reduced to $30-(8.47-6) = 27.53\text{dBm}$.

3. Refer to section 3.3 for duty cycle spectrum plot.

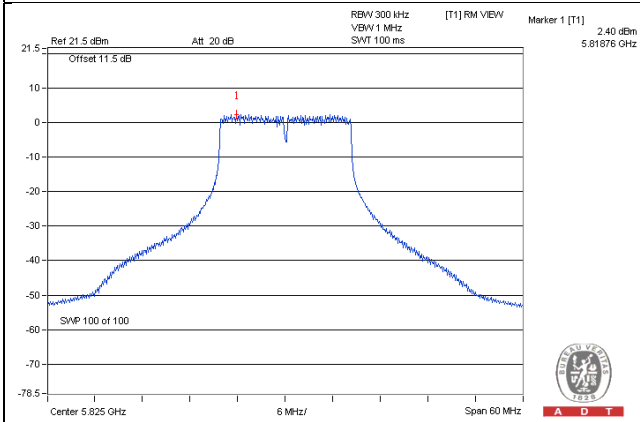
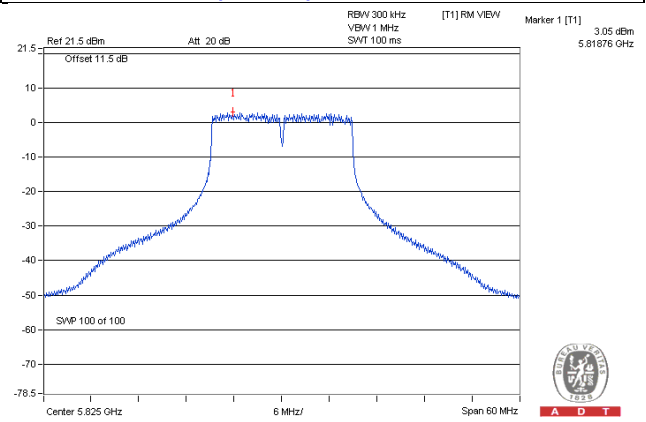
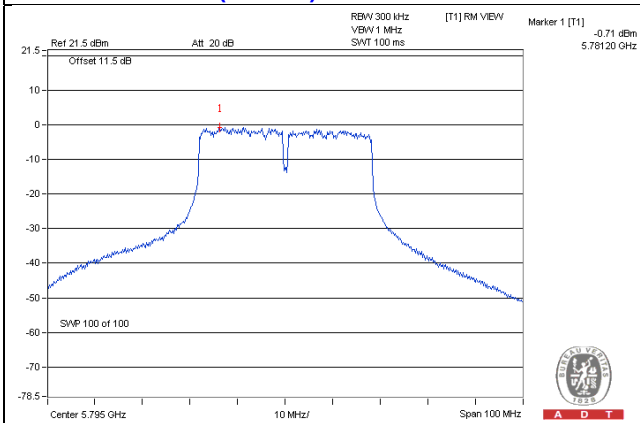
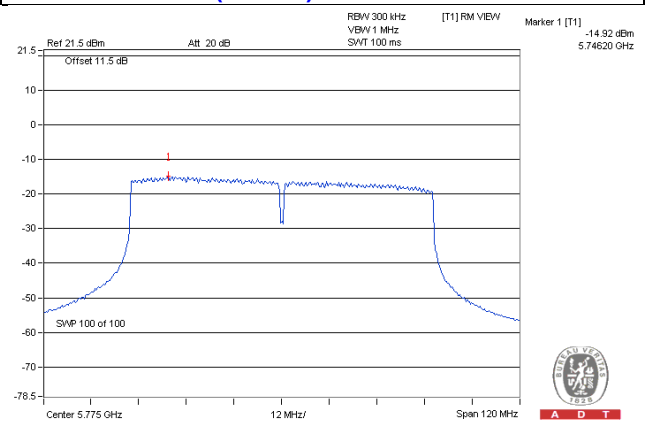
Spectrum Plot of Worst Value**802.11a – Chain 1: CH 165****802.11ac (VHT20) – Chain 1: CH 165****802.11ac (VHT40) – Chain 1: CH 159****802.11ac (VHT80) – Chain 1: CH 155**

4.5 Frequency Stability Measurement

4.5.1 Limits of Frequency Stability Measurement

The frequency of the carrier signal shall be maintained within band of operation

4.5.2 Test Setup

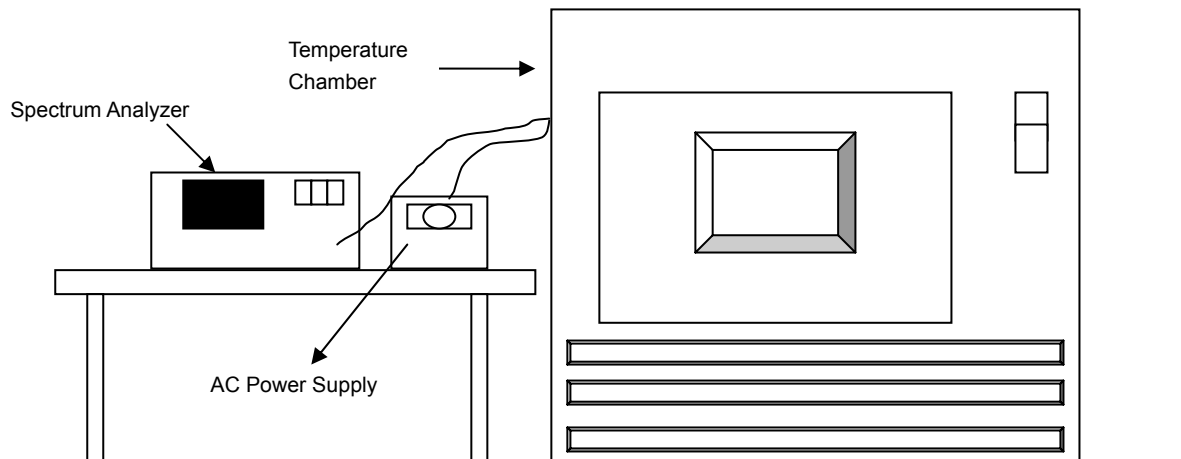

4.5.3 Test Instruments

Refer to section 4.1.2 to get information of above instrument.

4.5.4 Test Procedure

- The EUT was placed inside the environmental test chamber and powered by nominal AC voltage.
- Turn the EUT on and couple its output to a spectrum analyzer.
- Turn the EUT off and set the chamber to the highest temperature specified.
- Allow sufficient time (approximately 30 min) for the temperature of the chamber to stabilize, turn the EUT on and measure the operating frequency after 2, 5, and 10 minutes.
- Repeat step 2 and 3 with the temperature chamber set to the lowest temperature.
- The test chamber was allowed to stabilize at +20 degree C for a minimum of 30 minutes. The supply voltage was then adjusted on the EUT from 85% to 115% and the frequency record.

4.5.5 Deviation from Test Standard

No deviation.

4.5.6 EUT Operating Condition

Set the EUT transmit at un-modulation mode to test frequency stability.

4.5.7 Test Results

FREQUENCY STABILITY VERSUS TEMP.									
OPERATING FREQUENCY: 5180MHz									
TEMP. (°C)	POWER SUPPLY (Vac)	0 MINUTE		2 MINUTE		5 MINUTE		10 MINUTE	
		Measured Frequency (MHz)	Frequency Drift (%)	Measured Frequency (MHz)	Frequency Drift (%)	Measured Frequency (MHz)	Frequency Drift (%)	Measured Frequency (MHz)	Frequency Drift (%)
50	120	5179.9933	-0.00013	5179.99	-0.00019	5179.9916	-0.00016	5179.9892	-0.00021
40	120	5179.9828	-0.00033	5179.9834	-0.00032	5179.9796	-0.00039	5179.9813	-0.00036
30	120	5179.9918	-0.00016	5179.9891	-0.00021	5179.9887	-0.00022	5179.9909	-0.00018
20	120	5179.9843	-0.00030	5179.9872	-0.00025	5179.9852	-0.00029	5179.9843	-0.00030
10	120	5180.0049	0.00009	5180.0031	0.00006	5180.0033	0.00006	5180.0017	0.00003
0	120	5179.9988	-0.00002	5179.9965	-0.00007	5179.9981	-0.00004	5179.998	-0.00004
-10	120	5179.9821	-0.00035	5179.9808	-0.00037	5179.9784	-0.00042	5179.9799	-0.00039
-20	120	5179.9877	-0.00024	5179.9862	-0.00027	5179.9853	-0.00028	5179.9861	-0.00027
-30	120	5180.0025	0.00005	5180.0048	0.00009	5180.0026	0.00005	5180.0036	0.00007

FREQUENCY STABILITY VERSUS VOLTAGE									
OPERATING FREQUENCY: 5180MHz									
TEMP. (°C)	POWER SUPPLY (Vac)	0 MINUTE		2 MINUTE		5 MINUTE		10 MINUTE	
		Measured Frequency (MHz)	Frequency Drift (%)	Measured Frequency (MHz)	Frequency Drift (%)	Measured Frequency (MHz)	Frequency Drift (%)	Measured Frequency (MHz)	Frequency Drift (%)
20	138	5179.984	-0.00031	5179.9864	-0.00026	5179.9852	-0.00029	5179.9851	-0.00029
	120	5179.9843	-0.00030	5179.9872	-0.00025	5179.9852	-0.00029	5179.9843	-0.00030
	102	5179.9846	-0.00030	5179.9873	-0.00025	5179.9842	-0.00031	5179.9848	-0.00029

4.6 6dB Bandwidth Measurement

4.6.1 Limits of 6dB Bandwidth Measurement

The minimum of 6dB Bandwidth Measurement is 0.5MHz.

4.6.2 Test Setup

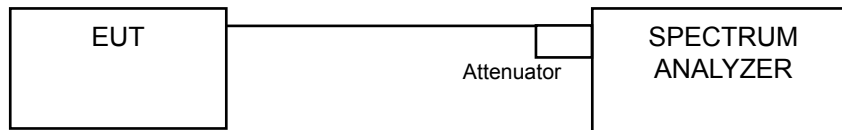

4.6.3 Test Instruments

Refer to section 4.1.2 to get information of above instrument.

4.6.4 Test Procedure

MEASUREMENT PROCEDURE REF

- a. Set resolution bandwidth (RBW) = 100kHz
- b. Set the video bandwidth (VBW) $\geq 3 \times$ RBW, Detector = Peak.
- c. Trace mode = max hold.
- d. Sweep = auto couple.
- e. Measure the maximum width of the emission that is constrained by the frequencies associated with the two amplitude points (upper and lower) that are attenuated by 6 dB relative to the maximum level measured in the fundamental emission

4.6.5 Deviation from Test Standard

No deviation.

4.6.6 EUT Operating Condition

The software provided by client to enable the EUT under transmission condition continuously at lowest, middle and highest channel frequencies individually.

4.6.7 Test Results (Mode 1)

802.11a

Channel	Frequency (MHz)	6dB Bandwidth (MHz)	Minimum Limit (MHz)	Pass / Fail
149	5745	16.41	0.5	Pass
157	5785	16.39	0.5	Pass
165	5825	16.40	0.5	Pass

802.11ac (VHT20)

Channel	Frequency (MHz)	6dB Bandwidth (MHz)	Minimum Limit (MHz)	Pass / Fail
149	5745	17.64	0.5	Pass
157	5785	17.64	0.5	Pass
165	5825	17.63	0.5	Pass

802.11ac (VHT40)

Channel	Frequency (MHz)	6dB Bandwidth (MHz)	Minimum Limit (MHz)	Pass / Fail
151	5755	36.38	0.5	Pass
159	5795	36.23	0.5	Pass

802.11ac (VHT80)

Channel	Frequency (MHz)	6dB Bandwidth (MHz)	Minimum Limit (MHz)	Pass / Fail
155	5775	76.11	0.5	Pass

Spectrum Plot of Worst Value

802.11a – CH 157

802.11ac (VHT20) – CH 165

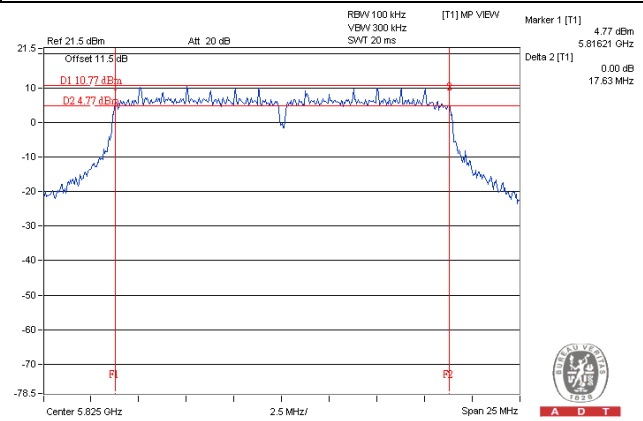
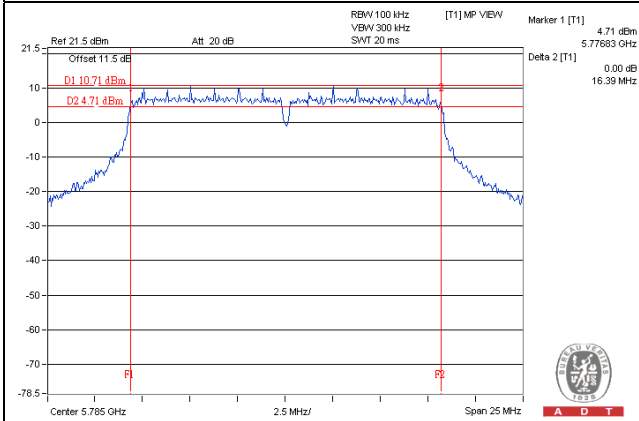

802.11ac (VHT40) – CH 159

802.11ac (VHT80) – CH 155

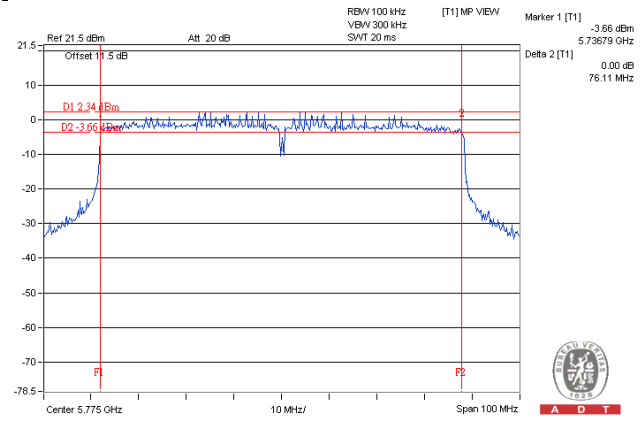
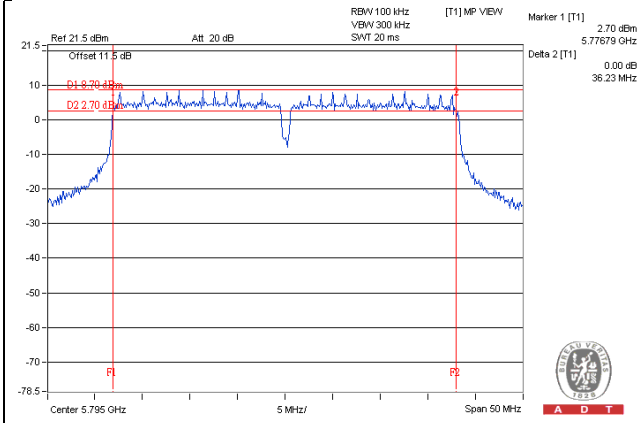

4.6.8 Test Results (Mode 2)

802.11a

Channel	Frequency (MHz)	6dB Bandwidth (MHz)	Minimum Limit (MHz)	Pass / Fail
149	5745	16.39	0.5	Pass
157	5785	16.38	0.5	Pass
165	5825	16.39	0.5	Pass

802.11ac (VHT20)

Channel	Frequency (MHz)	6dB Bandwidth (MHz)	Minimum Limit (MHz)	Pass / Fail
149	5745	17.62	0.5	Pass
157	5785	17.62	0.5	Pass
165	5825	17.66	0.5	Pass

802.11ac (VHT40)

Channel	Frequency (MHz)	6dB Bandwidth (MHz)	Minimum Limit (MHz)	Pass / Fail
151	5755	36.09	0.5	Pass
159	5795	36.23	0.5	Pass

802.11ac (VHT80)

Channel	Frequency (MHz)	6dB Bandwidth (MHz)	Minimum Limit (MHz)	Pass / Fail
155	5775	69.73	0.5	Pass

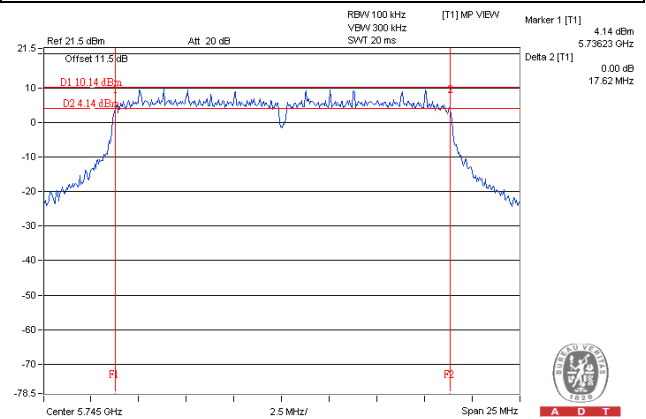
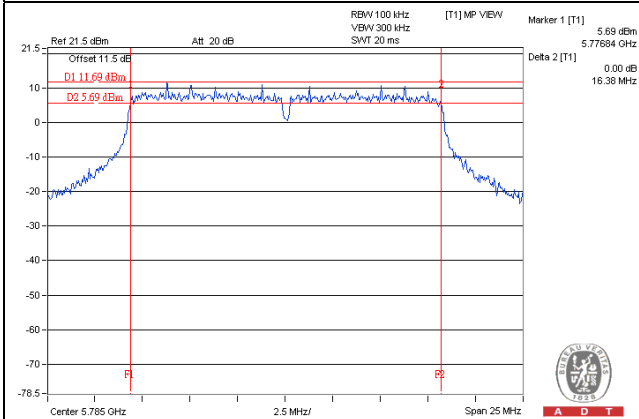
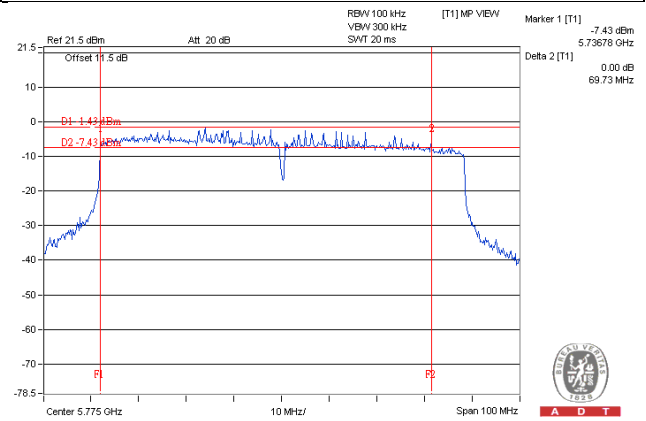
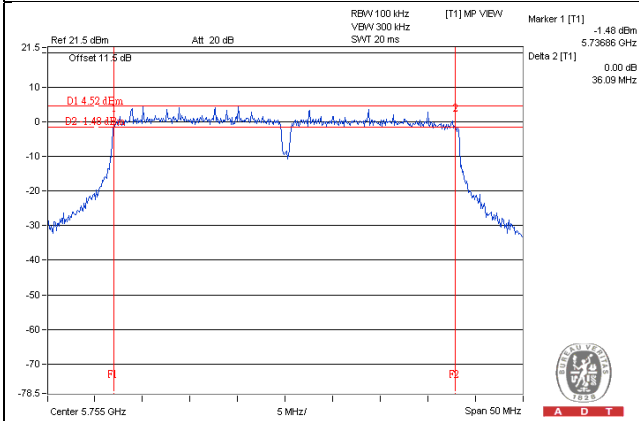
Spectrum Plot of Worst Value**802.11a – CH 157****802.11ac (VHT20) – CH 149****802.11ac (VHT40) – CH 151****802.11ac (VHT80) – CH 155**

4.6.9 Test Results (Mode 3)
802.11a

Channel	Frequency (MHz)	6dB Bandwidth (MHz)		Minimum Limit (MHz)	Pass / Fail
		Chain 0	Chain 1		
149	5745	16.42	16.41	0.5	Pass
157	5785	16.40	16.40	0.5	Pass
165	5825	16.39	16.39	0.5	Pass

802.11ac (VHT20)

Channel	Frequency (MHz)	6dB Bandwidth (MHz)		Minimum Limit (MHz)	Pass / Fail
		Chain 0	Chain 1		
149	5745	17.64	17.63	0.5	PASS
157	5785	17.62	17.62	0.5	PASS
165	5825	17.62	17.63	0.5	PASS

802.11ac (VHT40)

Channel	Frequency (MHz)	6dB Bandwidth (MHz)		Minimum Limit (MHz)	Pass / Fail
		Chain 0	Chain 1		
151	5755	36.36	35.97	0.5	PASS
159	5795	36.45	35.90	0.5	PASS

802.11ac (VHT80)

Channel	Frequency (MHz)	6dB Bandwidth (MHz)		Minimum Limit (MHz)	Pass / Fail
		Chain 0	Chain 1		
151	5755	75.89	74.65	0.5	PASS

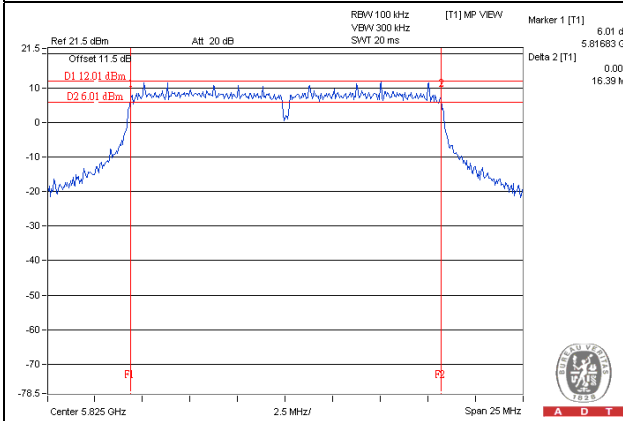
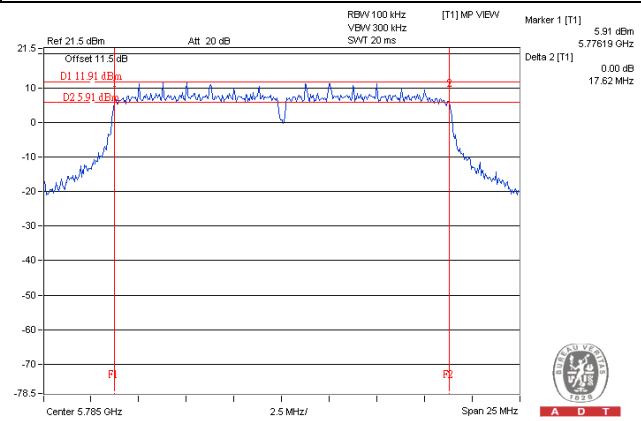
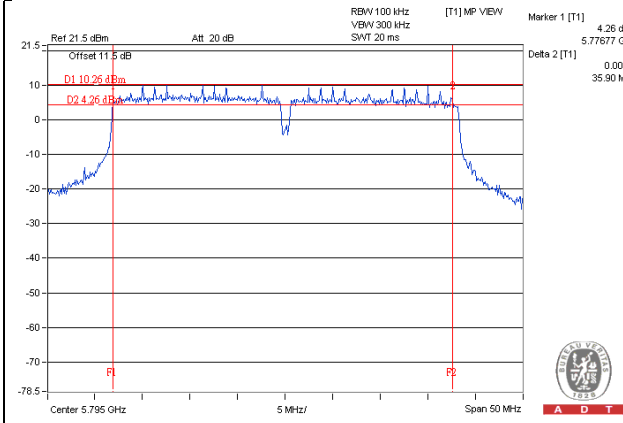
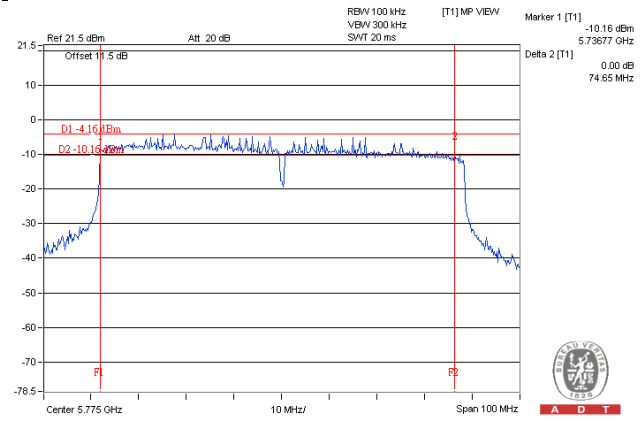
Spectrum Plot of Worst Value**802.11a – Chain 6: CH 165****802.11ac (VHT20) – Chain 0: CH 157****802.11ac (VHT40) – Chain 1: CH 159****802.11ac (VHT80) – Chain 1: CH 155**

4.7 Occupied Bandwidth Measurement

4.7.1 Test Setup

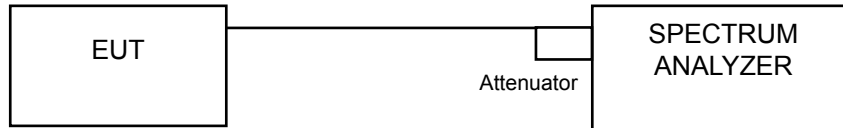

4.7.2 Test Instruments

Refer to section 4.1.2 to get information of above instrument.

4.7.3 Test Procedure

The transmitter output was connected to the spectrum analyzer through an attenuator. The bandwidth of the fundamental frequency was measured by spectrum analyzer with resolution bandwidth in the range of 1% to 5% of the anticipated emission bandwidth, and a video bandwidth at least 3x the resolution bandwidth and set the detector to PEAK. The width of a frequency band such that, below the lower and above the upper frequency limits, the mean powers emitted are each equal to a specified percentage 0.5 %of the total mean power of a given emission.

4.7.4 Deviation from Test Standard

No deviation.

4.7.5 EUT Operating Conditions

The software provided by client to enable the EUT under transmission condition continuously at lowest, middle and highest channel frequencies individually.

4.7.6 Test Results (Mode 1)
802.11a

Channel	Frequency (MHz)	Occupied Bandwidth (MHz)
36	5180	16.80
40	5200	16.80
48	5240	16.56
149	5745	16.80
157	5785	16.68
165	5825	16.92

802.11ac (VHT20)

Channel	Frequency (MHz)	Occupied Bandwidth (MHz)
36	5180	18.12
40	5200	17.88
48	5240	17.88
149	5745	18.00
157	5785	18.00
165	5825	17.88

802.11ac (VHT40)

Channel	Frequency (MHz)	Occupied Bandwidth (MHz)
38	5190	36.80
46	5230	36.80
151	5755	36.60
159	5795	36.80

802.11ac (VHT80)

Channel	Frequency (MHz)	Occupied Bandwidth (MHz)
42	5210	76.08
155	5775	76.08

Spectrum Plot of Worst Value

802.11a – CH 165

802.11ac (VHT20) – CH 36

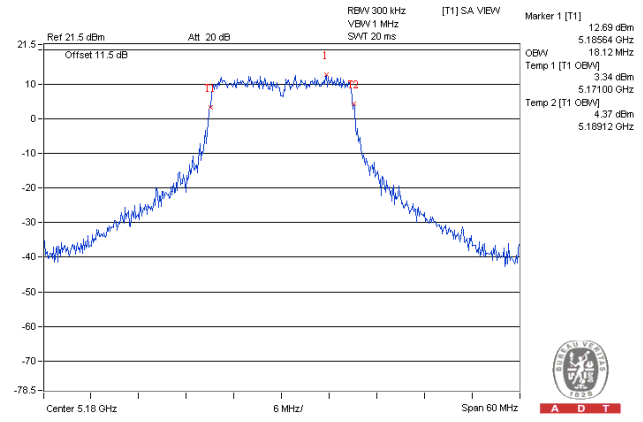
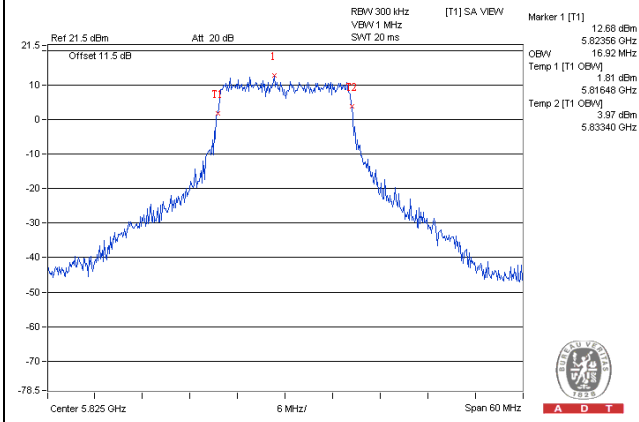

802.11ac (VHT40) – CH 38

802.11ac (VHT80) – CH 42

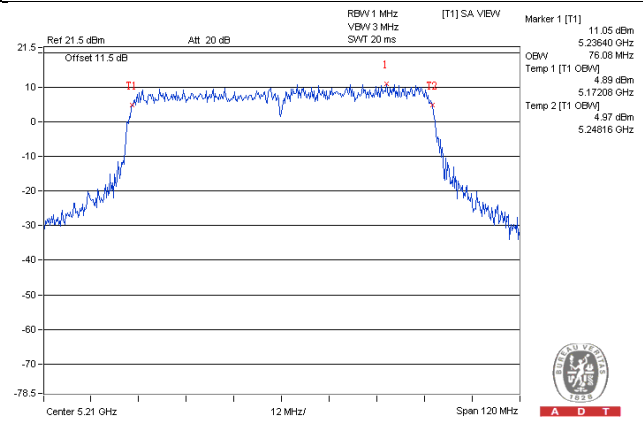
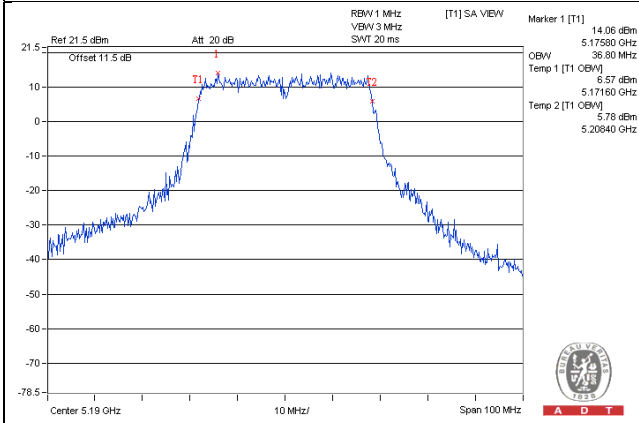

4.7.7 Test Results (Mode 2)
802.11a

Channel	Frequency (MHz)	Occupied Bandwidth (MHz)
36	5180	16.80
40	5200	17.04
48	5240	16.80
149	5745	16.80
157	5785	16.80
165	5825	16.80

802.11ac (VHT20)

Channel	Frequency (MHz)	Occupied Bandwidth (MHz)
36	5180	18.00
40	5200	18.00
48	5240	17.76
149	5745	17.88
157	5785	17.88
165	5825	17.88

802.11ac (VHT40)

Channel	Frequency (MHz)	Occupied Bandwidth (MHz)
38	5190	36.80
46	5230	36.60
151	5755	36.80
159	5795	36.80

802.11ac (VHT80)

Channel	Frequency (MHz)	Occupied Bandwidth (MHz)
42	5210	75.84
155	5775	76.08

Spectrum Plot of Worst Value

802.11a – CH 40

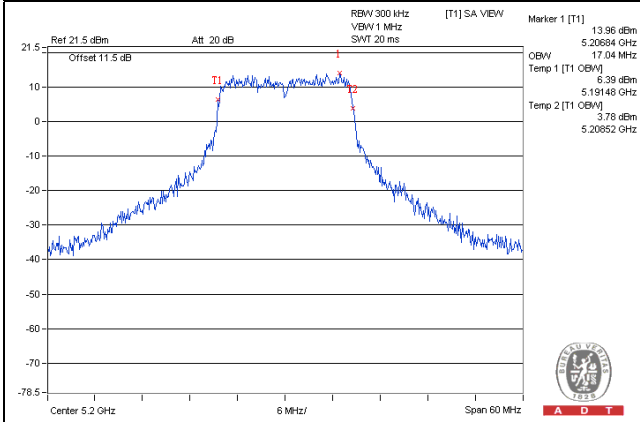

802.11ac (VHT20) – CH 36

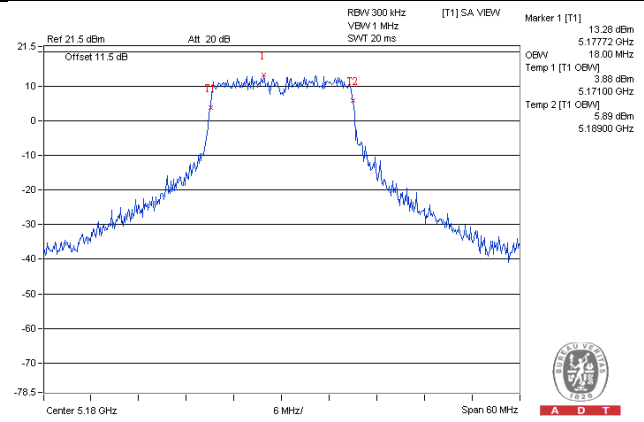

802.11ac (VHT40) – CH 38

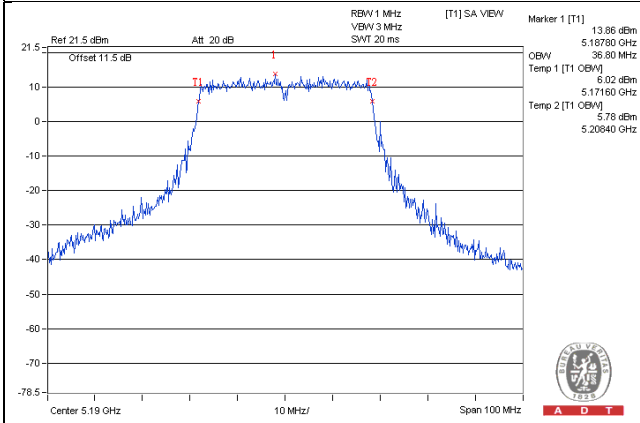

802.11ac (VHT80) – CH 155

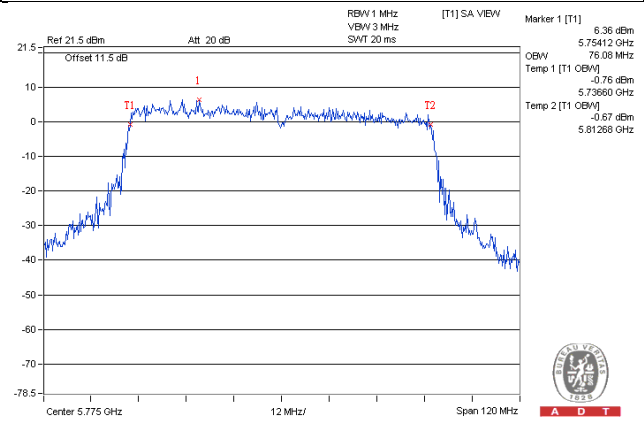

4.7.8 Test Results (Mode 3)
802.11a

Channel	Frequency (MHz)	Occupied Bandwidth (MHz)	
		Chain 0	Chain 1
36	5180	16.92	16.56
40	5200	16.80	16.92
48	5240	16.68	16.80
149	5745	16.80	16.68
157	5785	16.56	16.68
165	5825	16.80	16.80

802.11ac (VHT20)

Channel	Frequency (MHz)	Occupied Bandwidth (MHz)	
		Chain 0	Chain 1
36	5180	18.00	17.76
40	5200	18.00	18.00
48	5240	17.88	18.00
149	5745	17.88	17.88
157	5785	17.88	17.88
165	5825	18.00	17.88

802.11ac (VHT40)

Channel	Frequency (MHz)	Occupied Bandwidth (MHz)	
		Chain 0	Chain 1
38	5190	36.80	36.60
46	5230	36.80	37.00
151	5755	36.60	36.60
159	5795	36.80	36.80

802.11ac (VHT80)

Channel	Frequency (MHz)	Occupied Bandwidth (MHz)	
		Chain 0	Chain 1
42	5210	76.08	75.84
155	5775	75.84	75.84

Spectrum Plot of Worst Value

802.11a – Chain 0: CH 36

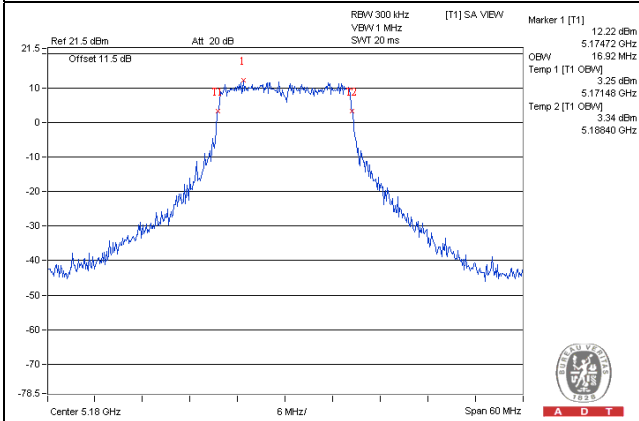

802.11ac (VHT20) – Chain 0: CH 36

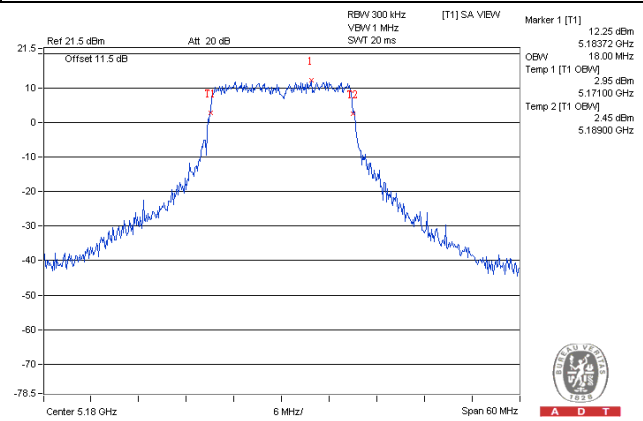

802.11ac (VHT40) – Chain 1: CH 46

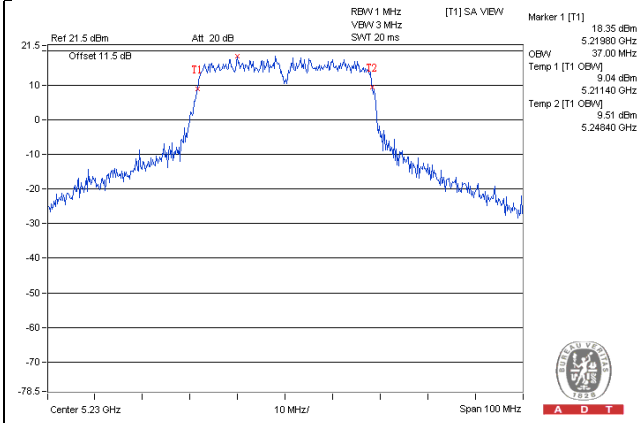

802.11ac (VHT80) – Chain 0: CH 42

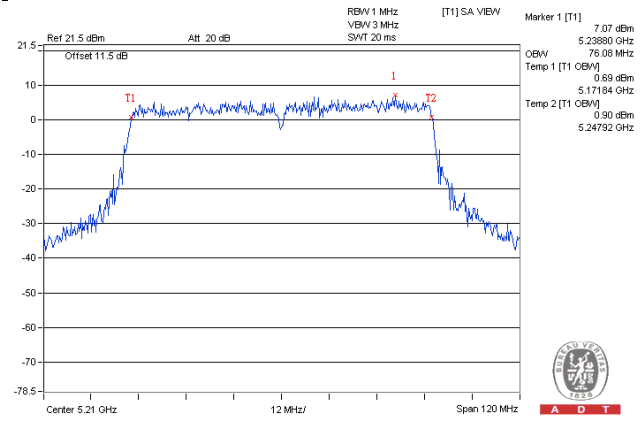

4.8 26dB Bandwidth Measurement

4.8.1 Test Setup



4.8.2 Test Instruments

Refer to section 4.1.2 to get information of above instrument.

4.8.3 Test Procedure

1. Set RBW = approximately 1% of the emission bandwidth.
2. Set the VBW > RBW.
3. Detector = Peak.
4. Trace mode = max hold.
5. Measure the maximum width of the emission that is 26 dB down from the peak of the emission. Compare this with the RBW setting of the analyzer. Readjust RBW and repeat measurement as needed until the RBW/EBW ratio is approximately 1%.

4.8.4 Deviation from Test Standard

No deviation.

4.8.5 EUT Operating Condition

The software provided by client to enable the EUT under transmission condition continuously at lowest, middle and highest channel frequencies individually.

4.8.6 Test Results (Mode 1)
802.11a

Channel	Frequency (MHz)	26dB Bandwidth (MHz)
36	5180	22.42
40	5200	22.52
48	5240	22.50
149	5745	22.38
157	5785	22.94
165	5825	22.53

802.11ac (VHT20)

Channel	Frequency (MHz)	26dB Bandwidth (MHz)
36	5180	23.45
40	5200	23.78
48	5240	23.30
149	5745	23.10
157	5785	23.72
165	5825	23.32

802.11ac (VHT40)

Channel	Frequency (MHz)	26dB Bandwidth (MHz)
38	5190	47.53
46	5230	48.74
151	5755	46.92
159	5795	46.07

802.11ac (VHT80)

Channel	Frequency (MHz)	26dB Bandwidth (MHz)
42	5210	89.32
155	5775	89.42

Spectrum Plot of Worst Value

802.11a – CH 149

802.11ac (VHT20) – CH 149

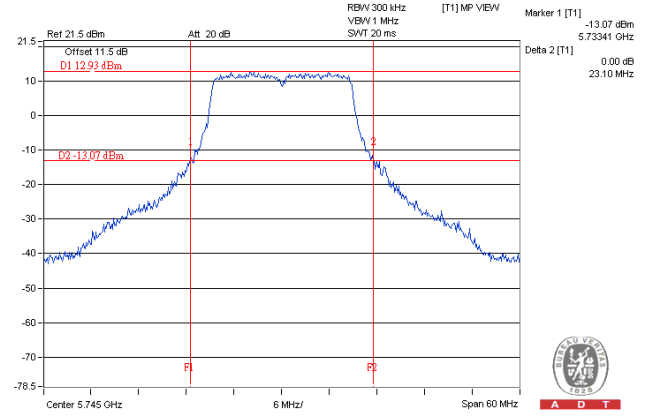
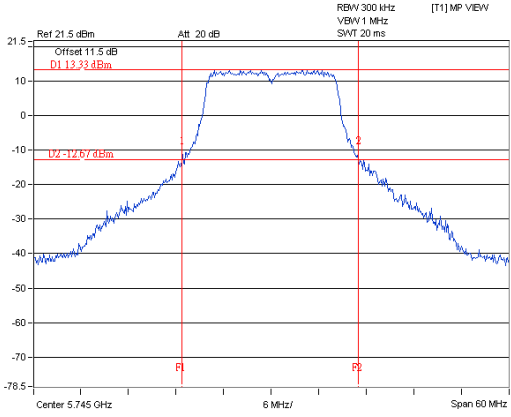

802.11ac (VHT40) – CH 159

802.11ac (VHT80) – CH 42

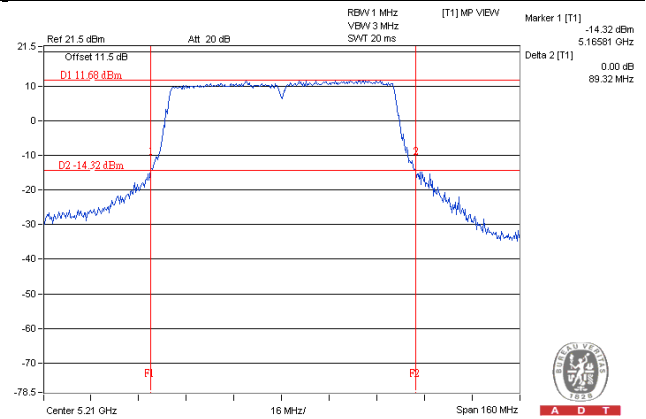
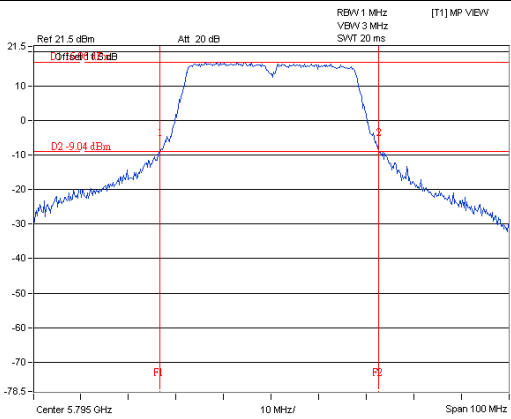

4.8.7 Test Results (Mode 2)
802.11a

Channel	Frequency (MHz)	26dB Bandwidth (MHz)
36	5180	24.45
40	5200	23.88
48	5240	23.50
149	5745	22.65
157	5785	22.60
165	5825	22.38

802.11ac (VHT20)

Channel	Frequency (MHz)	26dB Bandwidth (MHz)
36	5180	24.70
40	5200	24.64
48	5240	23.02
149	5745	22.82
157	5785	23.67
165	5825	23.39

802.11ac (VHT40)

Channel	Frequency (MHz)	26dB Bandwidth (MHz)
38	5190	45.54
46	5230	47.07
151	5755	46.02
159	5795	45.97

802.11ac (VHT80)

Channel	Frequency (MHz)	26dB Bandwidth (MHz)
42	5210	88.64
155	5775	87.40

Spectrum Plot of Worst Value

802.11a – CH 165

802.11ac (VHT20) – CH 149

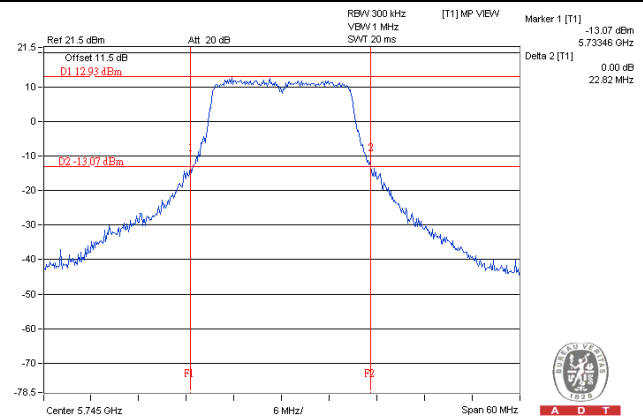
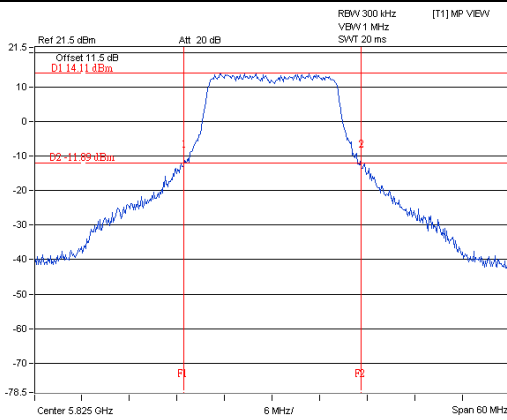

802.11ac (VHT40) – CH 38

802.11ac (VHT80) – CH 155

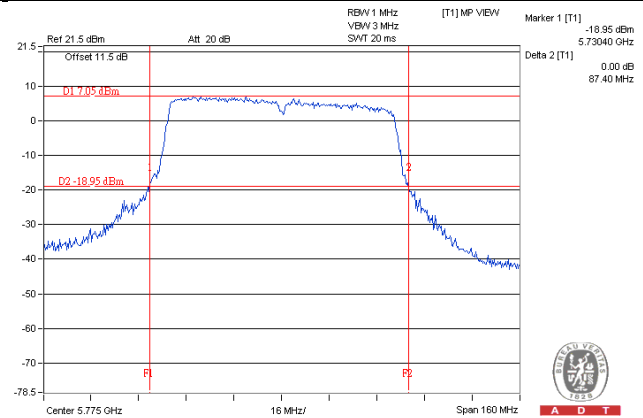
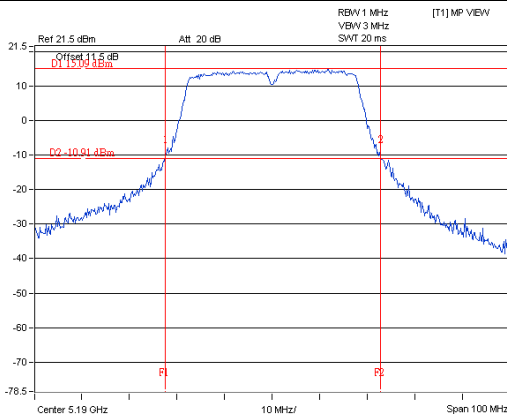

4.8.8 Test Results (Mode 3)
802.11a

Channel	Frequency (MHz)	26dB Bandwidth (MHz)	
		Chain 0	Chain 1
36	5180	22.31	22.36
40	5200	23.03	22.73
48	5240	22.17	22.97
149	5745	22.19	21.80
157	5785	22.59	22.46
165	5825	22.34	22.31

802.11ac (VHT20)

Channel	Frequency (MHz)	26dB Bandwidth (MHz)	
		Chain 0	Chain 1
36	5180	24.77	23.96
40	5200	23.62	24.29
48	5240	23.87	26.20
149	5745	23.81	22.93
157	5785	23.42	23.43
165	5825	23.62	24.66

802.11ac (VHT40)

Channel	Frequency (MHz)	26dB Bandwidth (MHz)	
		Chain 0	Chain 1
38	5190	47.02	45.51
46	5230	46.52	53.67
151	5755	46.13	44.76
159	5795	47.00	48.50

802.11ac (VHT80)

Channel	Frequency (MHz)	26dB Bandwidth (MHz)	
		Chain 0	Chain 1
42	5210	89.15	86.31
155	5775	89.44	86.96

Spectrum Plot of Worst Value

802.11a – Chain 1: CH 149

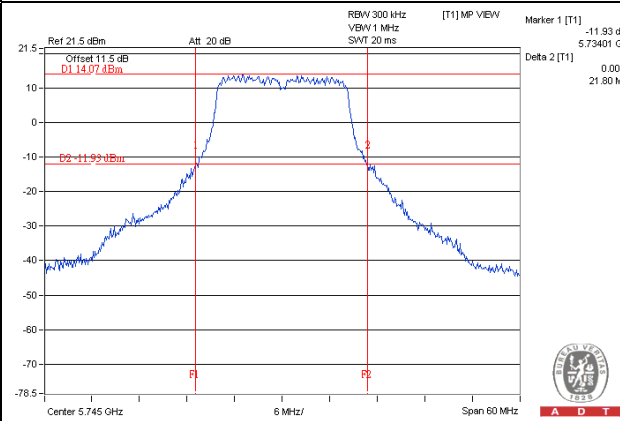

802.11ac (VHT20) – Chain 1: CH 149

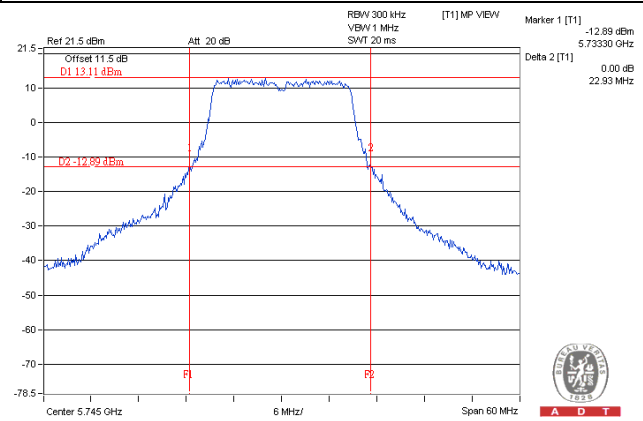

802.11ac (VHT40) – Chain 1: CH 151

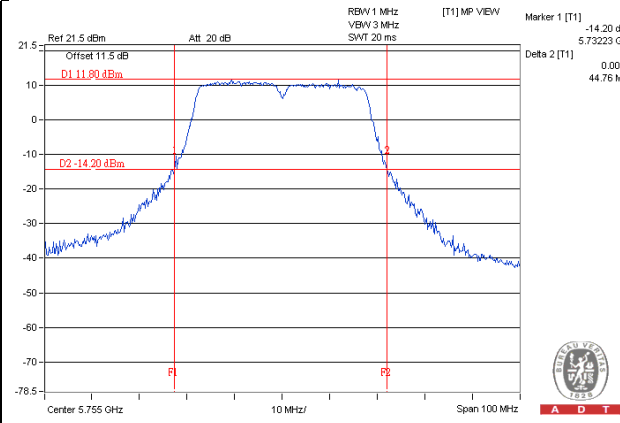

802.11ac (VHT80) – Chain 1: CH 42

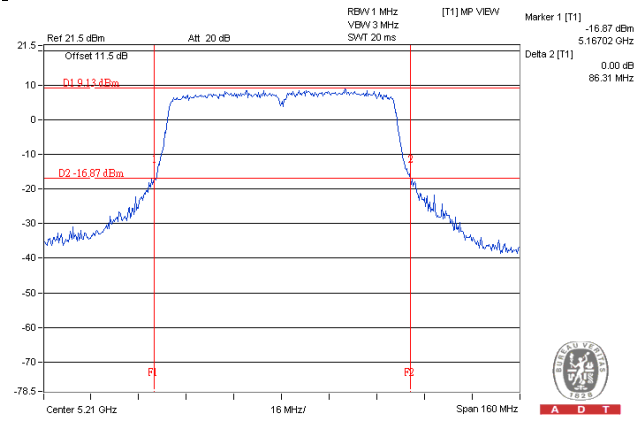

5 Pictures of Test Arrangements

Please refer to the attached file (Test Setup Photo).



Appendix – Information on the Testing Laboratories

We, Bureau Veritas Consumer Products Services (H.K.) Ltd., Taoyuan Branch, were founded in 1988 to provide our best service in EMC, Radio, Telecom and Safety consultation. Our laboratories are accredited and approved according to ISO/IEC 17025.

If you have any comments, please feel free to contact us at the following:

Linko EMC/RF Lab

Tel: 886-2-26052180

Fax: 886-2-26051924

Hsin Chu EMC/RF/Telecom Lab

Tel: 886-3-6668565

Fax: 886-3-6668323

Hwa Ya EMC/RF/Safety Lab

Tel: 886-3-3183232

Fax: 886-3-3270892

Email: service.adt@tw.bureauveritas.com

Web Site: www.bureauveritas-adt.com

The address and road map of all our labs can be found in our web site also.

--- END ---