

## FCC Test Report

**Report No.:** RF160530E01A-1 R1

**FCC ID:** 2AD8UFZCWI4A1

**Test Model:** WI4A-AC400i

**Received Date:** May 30, 2016

**Test Date:** June 21 to Aug. 23, 2016

**Issued Date:** Sep. 28, 2017

**Applicant:** Nokia Solutions and Networks.OY

**Address:** 1455 West Shure Drive, Arlington Heights, IL 60004, USA

**Issued By:** Bureau Veritas Consumer Products Services (H.K.) Ltd., Taoyuan Branch  
Hsin Chu Laboratory

**Lab Address:** E-2, No.1, Li Hsin 1st Road, Hsinchu Science Park, Hsinchu City 300,  
Taiwan R.O.C.

**Test Location (1):** E-2, No.1, Li Hsin 1st Road, Hsinchu Science Park, Hsinchu City 300,  
Taiwan R.O.C.

**Test Location (2):** No. 49, Ln. 206, Wende Rd., Shangshan Tsuen, Chiung Lin Hsiang, Hsin  
Chu Hsien 307, Taiwan R.O.C.



This report is for your exclusive use. Any copying or replication of this report to or for any other person or entity, or use of our name or trademark, is permitted only with our prior written permission. This report sets forth our findings solely with respect to the test samples identified herein. The results set forth in this report are not indicative or representative of the quality or characteristics of the lot from which a test sample was taken or any similar or identical product unless specifically and expressly noted. Our report includes all of the tests requested by you and the results thereof based upon the information that you provided to us. You have 60 days from date of issuance of this report to notify us of any material error or omission caused by our negligence, provided, however, that such notice shall be in writing and shall specifically address the issue you wish to raise. A failure to raise such issue within the prescribed time shall constitute your unqualified acceptance of the completeness of this report, the tests conducted and the correctness of the report contents. Unless specific mention, the uncertainty of measurement has been explicitly taken into account to declare the compliance or non-compliance to the specification. The report must not be used by the client to claim product certification, approval, or endorsement by TAF or any government agencies.

## Table of Contents

<b>Release Control Record</b> .....	<b>4</b>
<b>1 Certificate of Conformity</b> .....	<b>5</b>
<b>2 Summary of Test Results</b> .....	<b>6</b>
2.1 Measurement Uncertainty .....	6
2.2 Modification Record .....	6
<b>3 General Information</b> .....	<b>7</b>
3.1 General Description of EUT (DFS Band) .....	7
3.2 Description of Test Modes .....	11
3.2.1 Test Mode Applicability and Tested Channel Detail .....	13
3.3 Duty Cycle of Test Signal .....	17
3.4 Description of Support Units .....	18
3.4.1 Configuration of System under Test .....	19
3.5 General Description of Applied Standard .....	21
<b>4 Test Types and Results</b> .....	<b>22</b>
4.1 Radiated Emission and Bandedge Measurement .....	22
4.1.1 Limits of Radiated Emission and Bandedge Measurement .....	22
4.1.2 Test Instruments .....	23
4.1.3 Test Procedure .....	25
4.1.4 Deviation from Test Standard .....	25
4.1.5 Test Setup .....	26
4.1.6 EUT Operating Condition .....	26
4.1.7 Test Results (Mode 1) .....	27
4.1.8 Test Results (Mode 2) .....	73
4.2 Conducted Emission Measurement .....	74
4.2.1 Limits of Conducted Emission Measurement .....	74
4.2.2 Test Instruments .....	74
4.2.3 Test Procedure .....	75
4.2.4 Deviation from Test Standard .....	75
4.2.5 Test Setup .....	75
4.2.6 EUT Operating Condition .....	75
4.2.7 Test Results (Mode 1) .....	76
4.2.8 Test Results (Mode 2) .....	78
4.3 Transmit Power Measurement .....	80
4.3.1 Limits of Transmit Power Measurement .....	80
4.3.2 Test Setup .....	81
4.3.3 Test Instruments .....	81
4.3.4 Test Procedure .....	82
4.3.5 Deviation from Test Standard .....	82
4.3.6 EUT Operating Condition .....	82
4.3.7 Test Result .....	83
4.4 Occupied Bandwidth Measurement .....	108
4.4.1 Test Setup .....	108
4.4.2 Test Instruments .....	108
4.4.3 Test Procedure .....	108
4.5 Peak Power Spectral Density Measurement .....	112
4.5.1 Limits of Peak Power Spectral Density Measurement .....	112
4.5.2 Test Setup .....	112
4.5.3 Test Instruments .....	112
4.5.4 Test Procedure .....	113
4.5.5 Deviation from Test Standard .....	113
4.5.6 EUT Operating Condition .....	113
4.5.7 Test Results .....	114
4.6 Frequency Stability Measurement .....	124

4.6.1	Limits of Frequency Stability Measurement .....	124
4.6.2	Test Setup.....	124
4.6.3	Test Instruments .....	124
4.6.4	Test Procedure .....	124
4.6.5	Deviation from Test Standard .....	124
4.6.6	EUT Operating Condition .....	124
4.6.7	Test Results .....	125
4.7	6dB Bandwidth Measurement.....	126
4.7.1	Limits of 6dB Bandwidth Measurement.....	126
4.7.2	Test Setup.....	126
4.7.3	Test Instruments .....	126
4.7.4	Test Procedure .....	126
4.7.5	Deviation from Test Standard .....	126
4.7.6	EUT Operating Condition .....	126
4.7.7	Test Results .....	127
4.8	26dB Bandwidth Measurement.....	130
4.8.1	Test Setup.....	130
4.8.2	Test Instruments .....	130
4.8.3	Test Procedure .....	130
4.8.4	Deviation from Test Standard .....	130
4.8.5	EUT Operating Condition .....	130
4.8.6	Test Results .....	131
<b>5</b>	<b>Pictures of Test Arrangements.....</b>	<b>134</b>
	<b>Appendix – Information on the Testing Laboratories .....</b>	<b>135</b>

### Release Control Record

Issue No.	Description	Date Issued
RF160530E01A-1	Original release.	Apr. 13, 2017
RF160530E01A-1 R1	Revised section 3.1	Sep. 28, 2017

## 1 Certificate of Conformity

**Product:** Wireless Access Point

**Brand:** NOKIA

**Test Model:** WI4A-AC400i

**Sample Status:** ENGINEERING SAMPLE

**Applicant:** Nokia Solutions and Networks.OY

**Test Date:** June 21 to Aug. 23, 2016

**Standard:** 47 CFR FCC Part 15, Subpart E (Section 15.407)  
ANSI C63.10: 2013

The above equipment has been tested by **Bureau Veritas Consumer Products Services (H.K.) Ltd., Taoyuan Branch**, and found compliance with the requirement of the above standards. The test record, data evaluation & Equipment Under Test (EUT) configurations represented herein are true and accurate accounts of the measurements of the sample's EMC characteristics under the conditions specified in this report.

**Prepared by :** Wendy Wu , **Date:** Sep. 28, 2017  
Wendy Wu / Specialist

**Approved by :** May Chen , **Date:** Sep. 28, 2017  
May Chen / Manager

## 2 Summary of Test Results

47 CFR FCC Part 15, Subpart E (SECTION 15.407)				
FCC Clause	FCC KDB 789033	Test Item	Result	Remarks
15.407(b)(6)	-	AC Power Conducted Emissions	Pass	Meet the requirement of limit. Minimum passing margin is -5.12dB at 24.00000MHz.
15.407(b)(1/2/3/4(i/ii)/6)	Section G	Radiated Emissions & Band Edge Measurement*	Pass	Meet the requirement of limit. Minimum passing margin is -0.4dB at 5350.00MHz.
15.407(a)(1/2/3)	Section E.3	Transmit Output Power	PASS	Meet the requirement of limit.
-	Section D	Occupied Bandwidth Measurement	PASS	Meet the requirement.
15.407(a)(1/2/3)	Section F	Peak Power Spectral Density	PASS	Meet the requirement of limit.
15.407(e)	Section C.2	6dB bandwidth	PASS	Meet the requirement of limit. (U-NII-3 Band only)
15.407(g)	-	Frequency Stability	PASS	Meet the requirement of limit.
15.203	-	Antenna Requirement	Pass	Antenna connector is I-PEX not a standard connector.

\*For U-NII-3 band compliance with rule part 15.407(b)(4)(i), the OOB test plots were recorded in Annex A.

- NOTE:** 1. This report is prepared for FCC class II permissive change.  
 2. The DFS report was recorded in another test report.

### 2.1 Measurement Uncertainty

Where relevant, the following measurement uncertainty levels have been estimated for tests performed on the EUT as specified in CISPR 16-4-2:

Measurement	Frequency	Expanded Uncertainty (k=2) (±)
Conducted Emissions at mains ports	150kHz ~ 30MHz	1.83 dB
Radiated Emissions up to 1 GHz	30MHz ~ 1GHz	5.31 dB
Radiated Emissions above 1 GHz	1GHz ~ 6GHz	3.40 dB
	6GHz ~ 18GHz	3.73 dB
	18GHz ~ 40GHz	4.11 dB

### 2.2 Modification Record

There were no modifications required for compliance.

### 3 General Information

#### 3.1 General Description of EUT (DFS Band)

Product	Wireless Access Point
Brand	NOKIA
Test Model	WI4A-AC400i
Test Sample S/N	NH162800087
Hardware Version	AM2
Status of EUT	ENGINEERING SAMPLE
Power Supply Rating	12Vdc from power adapter or 54Vdc from POE
Modulation Type	64QAM, 16QAM, QPSK, BPSK for OFDM 256QAM for OFDM in 11ac mode.
Modulation Technology	OFDM
Transfer Rate	802.11a: up to 54Mbps 802.11n: up to 600Mbps 802.11ac: up to 1733.3Mbps
Operating Frequency	5.26GHz ~ 5.32GHz, 5.50GHz ~ 5.72GHz 5.18GHz~5.24GHz, 5.745GHz~5.825GHz (for VHT80+80)
Number of Channel	For U_NII-2A and U_NII-2C bands: 802.11a, 802.11n (HT20), 802.11ac (VHT20): 16 802.11n (HT40), 802.11ac (VHT40): 8 802.11ac (VHT80): 4 For U_NII-1+2A, U_NII-2A+2C, U_NII-2A+3 and U_NII-2C+3 bands: 802.11ac (VHT80+80): 14 sets
Output Power	<b>CDD Mode</b> U_NII-1: 251.144mW(for VHT80+80) U_NII-2A: 249.765mW U_NII-2C: 250.194mW U_NII-3: 241.54mW(for VHT80+80) <b>Beamforming Mode</b> U_NII-1: 154.778mW(for VHT80+80) U_NII-2A: 149.537mW U_NII-2C: 156.728 mW U_NII-3: 141.005mW(for VHT80+80)
Antenna Type	Refer to Note
Antenna Connector	Refer to Note
Accessory Device	NA
Data Cable Supplied	NA

**Note:**

- This report is prepared for FCC class II permissive change. The difference compared with the Report No.: RF160530E01-1 as the following:
  - ◆ Add DFS band <5250~5350MHz & 5470~5725MHz> and multi-channel operation in an 80+80 mode.
- According to above condition, all test items need to be performed. And all data weres verified to meet the requirements.
- The antennas provided to the EUT, please refer to the following table:

**WLAN – 5GHz Antenna spec.**

Antenna No	PCB Chain No.	Brand	Model	Antenna Type	Gain(dBi)	Frequency (MHz)
1	Chain 2	Galtronics	02102140-06226A1	PIFA	3.81	5150
					3.71	5250
					4.06	5350
					5.83	5725
					6.21	5825
2	Chain 3	Galtronics	02102140-06226A2	PIFA	5.67	5150
					5.95	5250
					5.83	5350
					5.38	5725
					5.38	5825
3	Chain 1	Galtronics	02102140-06226A3	PIFA	5.69	5150
					5.41	5250
					5.2	5350
					4.92	5725
					5.07	5825
4	Chain 0	Galtronics	02102140-06226A4	PIFA	4.85	5150
					4.66	5250
					4.32	5350
					5.02	5725
					4.87	5825

**Cable Spec.**

Antenna No	Brand	Model	Connector Type	Cable Loss(dB)	Cable Length (mm)
1	Galtronics	RG-137	i-pex(MHF)	1.5	175
2	Galtronics	RG-137	i-pex(MHF)	1.3	130
3	Galtronics	RG-137	i-pex(MHF)	0.5	50
4	Galtronics	RG-137	i-pex(MHF)	0.8	75

**4. Simultaneously transmission condition.**

Condition	Technology	
1	WLAN (2.4GHz)	WLAN (5GHz)

Note: For the simultaneous operation has been evaluated under below test modes, and Mode D was the worst case. (Please refer report no.: RF160530E01-2)

Mode A: WLAN (2.4GHz) + WLAN (5GHz - U\_NII-1)

Mode B: WLAN (2.4GHz) + WLAN (5GHz - U\_NII-2A)

Mode C: WLAN (2.4GHz) + WLAN (5GHz - U\_NII-2C)

Mode D: WLAN (2.4GHz) + WLAN (5GHz - U\_NII-3)



5. The EUT incorporates a MIMO function.

5GHz Band			
MODULATION MODE	DATA RATE (MCS)	TX & RX CONFIGURATION	
802.11a	6 ~ 54Mbps	4TX	4RX
802.11n (HT20)	MCS 0~7	4TX	4RX
	MCS 8~15		
	MCS16~23		
	MCS 24~31		
802.11n (HT40)	MCS 0~7	4TX	4RX
	MCS 8~15		
	MCS16~23		
	MCS 24~31		
802.11ac (VHT20)	MCS 0~8, Nss=1	4TX	4RX
	MCS 0~8, Nss=2		
	MCS 0~9, Nss=3		
	MCS 0~8, Nss=4		
802.11ac (VHT40)	MCS 0~9, Nss=1	4TX	4RX
	MCS 0~9, Nss=2		
	MCS 0~9, Nss=3		
	MCS 0~9, Nss=4		
802.11ac (VHT80)	MCS 0~9, Nss=1	4TX	4RX
	MCS 0~9, Nss=2		
	MCS 0~9, Nss=3		
	MCS 0~9, Nss=4		
802.11ac (VHT80+VHT80) noncontiguous	MCS 0~9, Nss=1	4TX	4RX
	MCS 0~9, Nss=2	4TX	4RX

Note:

- All of modulation mode support beamforming function except 802.11a modulation mode.
- The modulation and bandwidth are similar for 802.11n mode for 20MHz (40MHz) and 802.11ac mode for 20MHz (40MHz), therefore investigated worst case to representative mode in test report. (Final test mode refer section 3.2.1)

6. The EUT was tested in both DC powered and PoE powered modes of operation using the representative AC/DC power converter and PoE injector listed below:

POE		
Brand	Model No.	Spec.
UE	PoE35-54A	Input: 100-240V, 1.0A, 50/60Hz AC input cable(1.0m, unshielded) Output: 54V, 0.65A
Adapter		
Brand	Model No.	Spec.
UE	UES36-120300SPA	Input: 100-240V, 1.0A, 50/60Hz AC input cable(1.5m, unshielded) Output: 12V, 3.0A DC output cable(1.0m, unshielded)

7. The EUT was pre-tested under following test modes :

Test Mode	Description
<b>Mode 1</b>	<b>With POE</b>
Mode 2	With adapter

For the above modes, the worst radiated emission (above 1GHz) test was found in **Mode 1**. Therefore only the test data of the modes were recorded in this report.

8. The above EUT information is declared by manufacturer and for more detailed features description, please refer to the manufacturer's specifications or user's manual.

### 3.2 Description of Test Modes

#### FOR 5260 ~ 5320MHz

4 channels are provided for 802.11a, 802.11n (HT20), 802.11ac (VHT20):

Channel	Frequency	Channel	Frequency
52	5260 MHz	60	5300 MHz
56	5280 MHz	64	5320 MHz

2 channels are provided for 802.11n (HT40), 802.11ac (VHT40):

Channel	Frequency	Channel	Frequency
54	5270 MHz	62	5310 MHz

1 channel is provided for 802.11ac (VHT80):

Channel	Frequency
58	5290MHz

#### FOR 5500 ~ 5720MHz

12 channels are provided for 802.11a, 802.11n (HT20), 802.11ac (VHT20):

Channel	Frequency	Channel	Frequency
100	5500 MHz	124	5620 MHz
104	5520 MHz	128	5640 MHz
108	5540 MHz	132	5660 MHz
112	5560 MHz	136	5680 MHz
116	5580 MHz	140	5700 MHz
120	5600 MHz	144	5720 MHz

6 channels are provided for 802.11n (HT40), 802.11ac (VHT40):

Channel	Frequency	Channel	Frequency
102	5510 MHz	126	5630 MHz
110	5550 MHz	134	5670 MHz
118	5590 MHz	142	5710 MHz

3 channels are provided for 802.11ac (VHT80):

Channel	Frequency	Channel	Frequency
106	5530MHz	138	5690 MHz
122	5610 MHz		

**For simultaneous transmission:**

14 sets are provided for 802.11ac (VHT80+80):

Channel	Frequency	Channel	Frequency
42+58	5210 MHz + 5290 MHz	58+155	5290 MHz + 5775 MHz
42+106	5210 MHz + 5530 MHz	106+122	5530 MHz + 5610 MHz
42+122	5210 MHz + 5610 MHz	106+138	5530 MHz + 5690 MHz
42+138	5210 MHz + 5690 MHz	106+155	5530 MHz + 5775 MHz
58+106	5290 MHz + 5530 MHz	122+138	5610 MHz + 5690 MHz
58+122	5290 MHz + 5610 MHz	122+155	5610 MHz + 5775 MHz
58+138	5290 MHz + 5690 MHz	138+155	5690 MHz + 5775 MHz

### 3.2.1 Test Mode Applicability and Tested Channel Detail

EUT CONFIGURE MODE	APPLICABLE TO				DESCRIPTION
	RE $\geq$ 1G	RE<1G	PLC	APCM	
1	√	√	√	√	With POE
2	-	√	√	-	With adapter

Where RE $\geq$ 1G: Radiated Emission above 1GHz & Bandedge Measurement  
 RE<1G: Radiated Emission below 1GHz  
 PLC: Power Line Conducted Emission  
 APCM: Antenna Port Conducted Measurement

NOTE: "-" means no effect.

#### Radiated Emission Test (Above 1GHz):

- Pre-Scan has been conducted to determine the worst-case mode from all possible combinations between available modulations, data rates and antenna ports (if EUT with antenna diversity architecture).
- Following channel(s) was (were) selected for the final test as listed below.

CDD Mode						
Mode	FREQ. Band (MHz)	Available Channel	Tested Channel	Modulation Technology	Modulation Type	Data Rate (Mbps)
802.11a	5260-5320	52 to 64	52, 60, 64	OFDM	BPSK	6
802.11ac (VHT20)		52 to 64	52, 60, 64	OFDM	BPSK	6.5
802.11ac (VHT40)		54 to 62	54, 62	OFDM	BPSK	13.5
802.11ac (VHT80)		58	58	OFDM	BPSK	29.3
802.11a	5500-5720	100 to 144	100, 116, 140, 144	OFDM	BPSK	6
802.11ac (VHT20)		100 to 144	100, 116, 140, 144	OFDM	BPSK	6.5
802.11ac (VHT40)		102 to 142	102, 110, 134, 142	OFDM	BPSK	13.5
802.11ac (VHT80)		106 to 138	106, 122, 138	OFDM	BPSK	29.3
802.11ac (VHT80+80)	5180-5240, 5260-5320, 5500-5720, 5745-5825	42 to 155	42+106 42+122 42+138 58+106 58+122 58+138 58+155 106+138 106+155 122+155 138+155 42+58 106+122 122+138	OFDM	BPSK	58.5

### Radiated Emission Test (Below 1GHz):

- Pre-Scan has been conducted to determine the worst-case mode from all possible combinations between available modulations, data rates and antenna ports (if EUT with antenna diversity architecture).
- Following channel(s) was (were) selected for the final test as listed below.

CDD Mode						
Mode	FREQ. Band (MHz)	Available Channel	Tested Channel	Modulation Technology	Modulation Type	Data Rate (Mbps)
802.11ac (VHT80)	5260-5320	58	58	OFDM	BPSK	29.3
	5500-5720	106 to 138				

### Power Line Conducted Emission Test:

- Pre-Scan has been conducted to determine the worst-case mode from all possible combinations between available modulations, data rates and antenna ports (if EUT with antenna diversity architecture).
- Following channel(s) was (were) selected for the final test as listed below.

CDD Mode						
Mode	FREQ. Band (MHz)	Available Channel	Tested Channel	Modulation Technology	Modulation Type	Data Rate (Mbps)
802.11ac (VHT80)	5260-5320	58	58	OFDM	BPSK	29.3
	5500-5720	106 to 138				

### Antenna Port Conducted Measurement:

- This item includes all test value of each mode, but only includes spectrum plot of worst value of each mode.
- Pre-Scan has been conducted to determine the worst-case mode from all possible combinations between available modulations, data rates and antenna ports (if EUT with antenna diversity architecture).
- Following channel(s) was (were) selected for the final test as listed below.

CDD Mode						
Mode	FREQ. Band (MHz)	Available Channel	Tested Channel	Modulation Technology	Modulation Type	Data Rate (Mbps)
802.11a	5260-5320	52 to 64	52, 60, 64	OFDM	BPSK	6
802.11ac (VHT20)		52 to 64	52, 60, 64	OFDM	BPSK	6.5
802.11ac (VHT40)		54 to 62	54, 62	OFDM	BPSK	13.5
802.11ac (VHT80)		58	58	OFDM	BPSK	29.3
802.11a	5500-5720	100 to 144	100, 116, 140, 144	OFDM	BPSK	6
802.11ac (VHT20)		100 to 144	100, 116, 140, 144	OFDM	BPSK	6.5
802.11ac (VHT40)		102 to 142	102, 110, 134, 142	OFDM	BPSK	13.5
802.11ac (VHT80)		106 to 138	106, 122, 138	OFDM	BPSK	29.3
802.11ac (VHT80+80)	5180-5240, 5260-5320, 5500-5725, 5745-5825	42 to 155	42+106 42+122 42+138 58+106 58+122 58+138 58+155 106+138 106+155 122+155 138+155 42+58 106+122 122+138	OFDM	BPSK	58.5

Beamforming Mode(Output power only)						
Mode	FREQ. Band (MHz)	Available Channel	Tested Channel	Modulation Technology	Modulation Type	Data Rate (Mbps)
802.11ac (VHT20)	5260-5320	52 to 64	52, 60, 64	OFDM	BPSK	6.5
802.11ac (VHT40)		54 to 62	54, 62	OFDM	BPSK	13.5
802.11ac (VHT80)		58	58	OFDM	BPSK	29.3
802.11ac (VHT20)	5500-5720	100 to 144	100, 116, 140, 144	OFDM	BPSK	6.5
802.11ac (VHT40)		102 to 142	102, 110, 134, 142	OFDM	BPSK	13.5
802.11ac (VHT80)		106 to 138	106, 122, 138	OFDM	BPSK	29.3
802.11ac (VHT80+80)	5180-5240, 5260-5320, 5500-5720, 5745-5825	42 to 155	42+106 42+122 42+138 58+106 58+122 58+138 58+155 106+138 106+155 122+155 138+155 42+58 106+122 122+138	OFDM	BPSK	58.5

### Test Condition:

#### Input Power to POE

APPLICABLE TO	ENVIRONMENTAL CONDITIONS	INPUT POWER	TESTED BY
RE≥1G	25deg. C, 65%RH	120Vac, 60Hz	James Chan
RE<1G	24deg. C, 62%RH	120Vac, 60Hz	Jyunchun Lin
PLC	24deg. C, 62%RH	120Vac, 60Hz	Jyunchun Lin
APCM	25deg. C, 60%RH	120Vac, 60Hz	Robert Cheng

#### Input Power to Adapter

APPLICABLE TO	ENVIRONMENTAL CONDITIONS	INPUT POWER	TESTED BY
RE<1G	24deg. C, 62%RH	120Vac, 60Hz	Jyunchun Lin
PLC	24deg. C, 62%RH	120Vac, 60Hz	Jyunchun Lin



### 3.3 Duty Cycle of Test Signal

If duty cycle of test signal is  $\geq 98\%$ , duty factor is not required.

If duty cycle of test signal is  $< 98\%$ , duty factor shall be considered.

**802.11a:** Duty cycle =  $2.057 \text{ ms} / 2.135 \text{ ms} = 0.963$ , Duty factor =  $10 * \log(1/0.963) = 0.16$

**802.11ac (VHT20):** Duty cycle =  $5.005 \text{ ms} / 5.089 \text{ ms} = 0.983$

**802.11ac (VHT40):** Duty cycle =  $2.431 \text{ ms} / 2.52 \text{ ms} = 0.965$ , Duty factor =  $10 * \log(1/0.965) = 0.16$

**802.11ac (VHT80):** Duty cycle =  $1.145 \text{ ms} / 1.21 \text{ ms} = 0.946$ , Duty factor =  $10 * \log(1/0.946) = 0.24$

**802.11ac (VHT80+80):** Duty cycle =  $1.144 \text{ ms} / 1.215 \text{ ms} = 0.942$ , Duty factor =  $10 * \log(1/0.942) = 0.26$

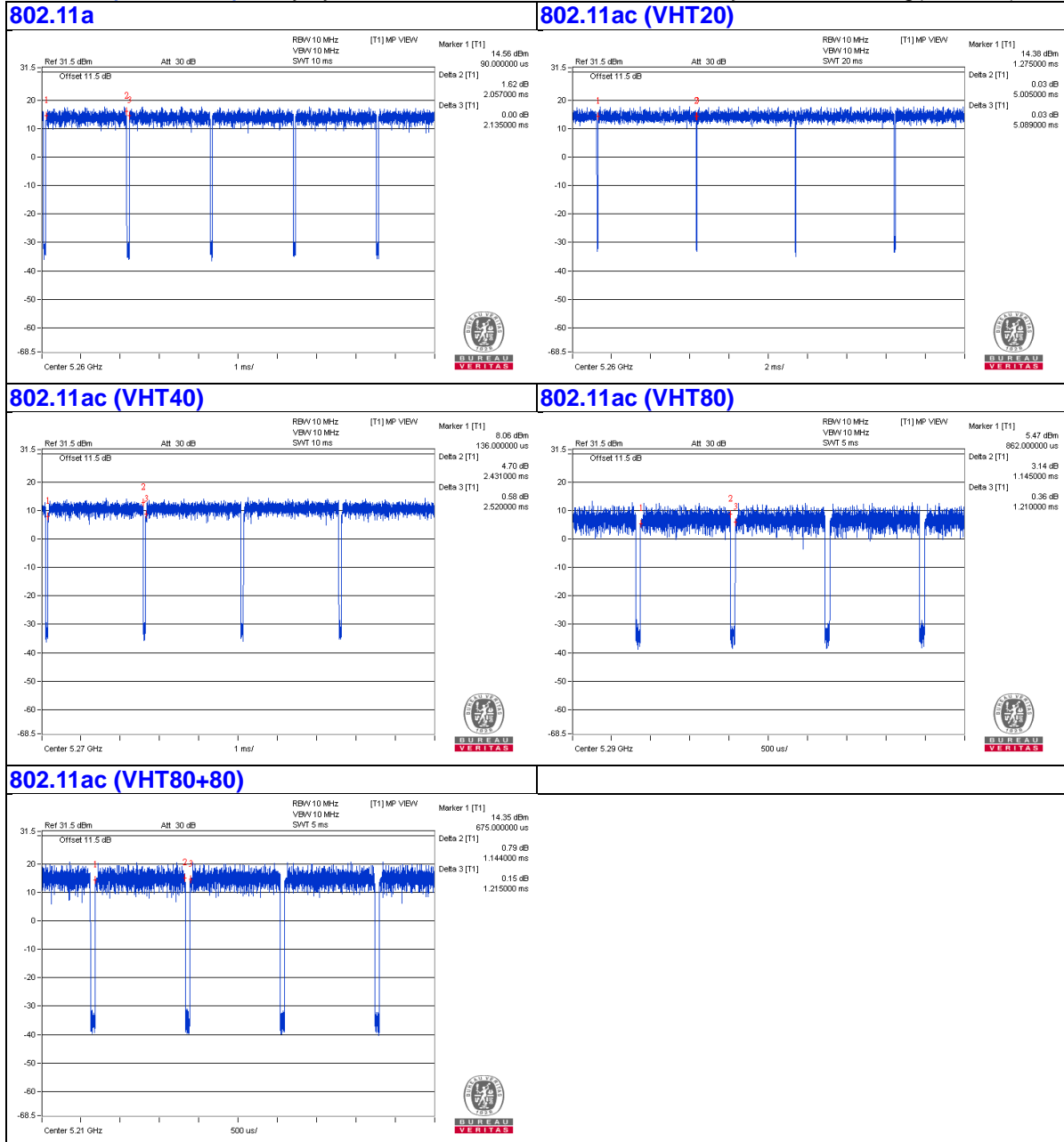

### 3.4 Description of Support Units

The EUT has been tested as an independent unit together with other necessary accessories or support units. The following support units or accessories were used to form a representative test configuration during the tests.

ID	Product	Brand	Model No.	Serial No.	FCC ID	Remarks
A.	Notebook Computer	DELL	E5430	HYV4VY1	FCC DoC	Provided by Lab
B.	HUB	ZyXEL	ES-116P	S060H02000215	FCC Doc	Provided by Lab
C.	iPod shuffle	Apple	MC749TA/A	CC4DMFKUDFDM	NA	Provided by Lab

Note:

1. All power cords of the above support units are non-shielded (1.8m).

ID	Descriptions	Qty.	Length (m)	Shielding (Yes/No)	Cores (Qty.)	Remarks
1.	RJ-45 Cable	1	10	No	0	Provided by Lab
2.	RJ-45 Cable	1	10	No	0	Provided by Lab
3.	DC Cable	1	1.0	No	0	Supplied by client
4.	AC Cable	1	1.5	No	0	Supplied by client
5.	USB Cable	1	0.1	Yes	0	Provided by Lab
6.	RJ-45 Cable	1	1.5	No	0	Provided by Lab

### 3.4.1 Configuration of System under Test

**With adapter mode:**

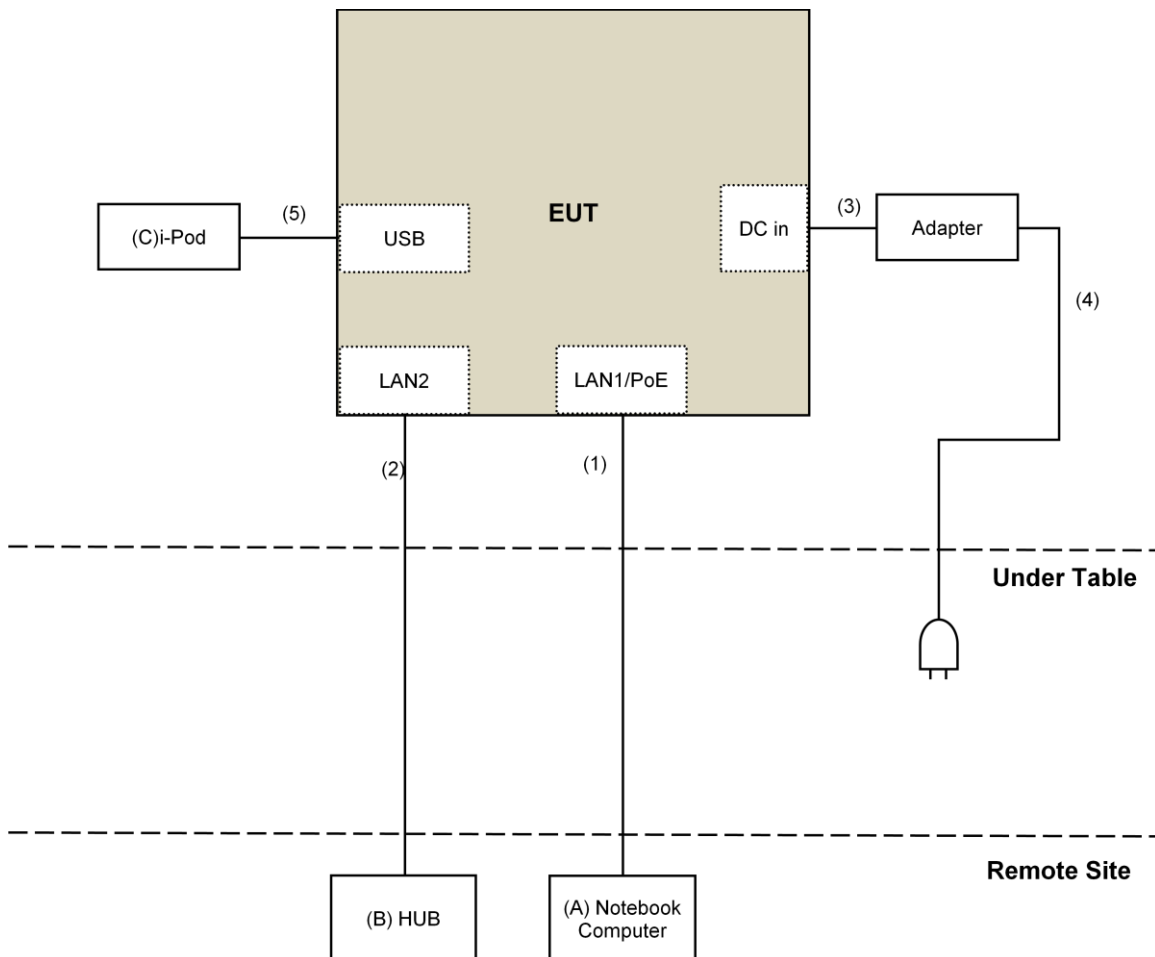

**With POE mode:**

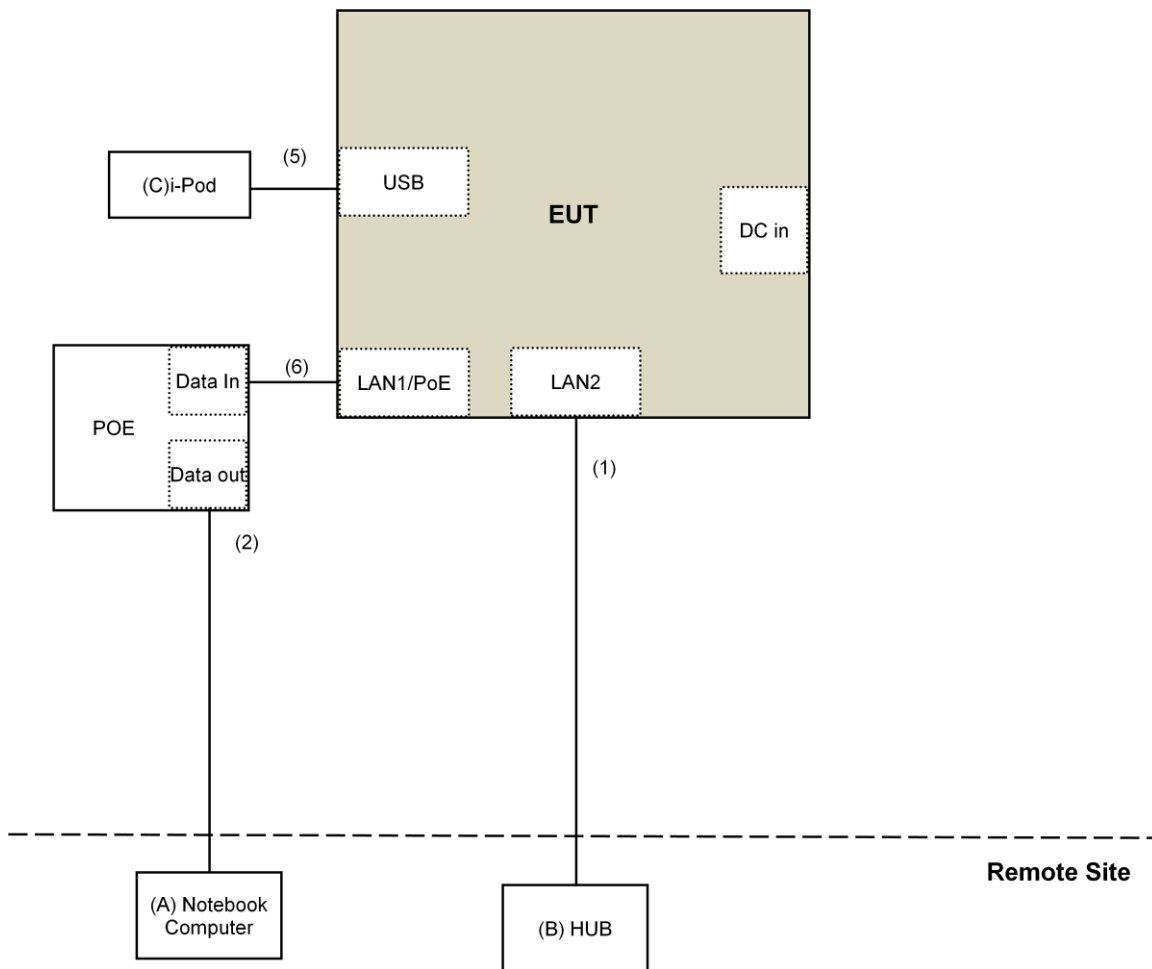

### 3.5 General Description of Applied Standard

The EUT is a RF Product. According to the specifications of the manufacturer, it must comply with the requirements of the following standards:

**FCC Part 15, Subpart E (15.407)**

**KDB 789033 D02 General UNII Test Procedure New Rules v01r03**

**KDB 662911 D01 Multiple Transmitter Output v02r01**

**KDB 644545 D03 Guidance for IEEE 802.11ac v01**

**ANSI C63.10-2013**

All test items have been performed and recorded as per the above standards.

## 4 Test Types and Results

### 4.1 Radiated Emission and Bandedge Measurement

#### 4.1.1 Limits of Radiated Emission and Bandedge Measurement

Radiated emissions which fall in the restricted bands must comply with the radiated emission limits specified as below table.

Frequencies (MHz)	Field Strength (microvolts/meter)	Measurement Distance (meters)
0.009 ~ 0.490	2400/F(kHz)	300
0.490 ~ 1.705	24000/F(kHz)	30
1.705 ~ 30.0	30	30
30 ~ 88	100	3
88 ~ 216	150	3
216 ~ 960	200	3
Above 960	500	3

#### NOTE:

1. The lower limit shall apply at the transition frequencies.
2. Emission level (dBuV/m) = 20 log Emission level (uV/m).
3. For frequencies above 1000MHz, the field strength limits are based on average detector, however, the peak field strength of any emission shall not exceed the maximum permitted average limits, specified above by more than 20dB under any condition of modulation.

Limits of unwanted emission out of the restricted bands

Applicable To		Limit	
789033 D02 General UNII Test Procedure New Rules v01r03		Field Strength at 3m	
		PK:74 (dBuV/m)	AV:54 (dBuV/m)
Frequency Band	Applicable To	EIRP Limit	Equivalent Field Strength at 3m
5150~5250 MHz	15.407(b)(1)	PK:-27 (dBm/MHz)	PK:68.2(dBuV/m)
5250~5350 MHz	15.407(b)(2)		
5470~5725 MHz	15.407(b)(3)		
5725~5850 MHz	<input checked="" type="checkbox"/> 15.407(b)(4)(i)	PK:-27 (dBm/MHz) <sup>*1</sup> PK:10 (dBm/MHz) <sup>*2</sup> PK:15.6 (dBm/MHz) <sup>*3</sup> PK:27 (dBm/MHz) <sup>*4</sup>	PK: 68.2(dBuV/m) <sup>*1</sup> PK:105.2 (dBuV/m) <sup>*2</sup> PK: 110.8(dBuV/m) <sup>*3</sup> PK:122.2 (dBuV/m) <sup>*4</sup>
	<input type="checkbox"/> 15.407(b)(4)(ii)	Emission limits in section 15.247(d)	
<sup>*1</sup> beyond 75 MHz or more above of the band edge.		<sup>*2</sup> below the band edge increasing linearly to 10 dBm/MHz at 25 MHz above.	
<sup>*3</sup> below the band edge increasing linearly to a level of 15.6 dBm/MHz at 5 MHz above.		<sup>*4</sup> from 5 MHz above or below the band edge increasing linearly to a level of 27 dBm/MHz at the band edge.	

#### Note:

The following formula is used to convert the equipment isotropic radiated power (eirp) to field strength:

$$E = \frac{1000000\sqrt{30P}}{3} \mu\text{V/m, where P is the eirp (Watts).}$$

## 4.1.2 Test Instruments

DESCRIPTION & MANUFACTURER	MODEL NO.	SERIAL NO.	CALIBRATED DATE	CALIBRATED UNTIL
Pre-Amplifier <sup>(*)</sup> EMCI	EMC001340	980142	Jan. 20, 2016	Jan. 19, 2018
Loop Antenna <sup>(*)</sup> Electro-Metrics	EM-6879	264	Dec. 16, 2014	Dec. 15, 2016
RF Cable	NA	LOOPCAB-001 LOOPCAB-002	Jan. 18, 2016	Jan. 17, 2017
Pre-Amplifier Mini-Circuits	ZFL-1000VH2 B	AMP-ZFL-05	May 07, 2016	May 06, 2017
Trilog Broadband Antenna SCHWARZBECK	VULB 9168	9168-156	Jan. 04, 2016	Jan. 03, 2017
RF Cable	8D	966-3-1 966-3-2 966-3-3	Apr. 02, 2016	Apr. 01, 2017
Horn_Antenna SCHWARZBECK	BBHA9120-D	9120D-406	Jan. 20, 2016	Jan. 19, 2017
Pre-Amplifier Agilent	8449B	3008A02465	Apr. 05, 2016	Apr. 04, 2017
RF Cable	EMC104-SM- SM-2000 EMC104-SM- SM-5000 EMC104-SM- SM-5000	150317 150321 150322	Mar. 30, 2016	Mar. 29, 2017
Spectrum Analyzer Keysight	N9030A	MY54490520	July 29, 2016	July 28, 2017
Pre-Amplifier EMCI	EMC184045	980143	Jan. 15, 2016	Jan. 14, 2017
Horn_Antenna SCHWARZBECK	BBHA 9170	BBHA9170608	Jan. 08, 2016	Jan. 07, 2017
RF Cable	SUCOFLEX 102	36432/2 36441/2	Jan. 16, 2016	Jan. 15, 2017
Software	ADT_Radiated _V8.7.08	NA	NA	NA
Antenna Tower & Turn Table Max-Full	MF-7802	MF780208406	NA	NA
Boresight Antenna Fixture	FBA-01	FBA-SIP01	NA	NA
Power meter Anritsu	ML2495A	0824006	May 26, 2016	May 25, 2017
Power sensor Anritsu	MA2411B	0738172	May 26, 2016	May 25, 2017
Spectrum Analyzer R&S	FSP40	100036	Jan. 27, 2016	Jan. 26, 2017
AC Power Source Extech Electronics	6502	1140503	NA	NA
Temperature & Humidity Chamber TERCHY	MHU-225AU	911033	Dec. 03, 2015	Dec. 02, 2016
Digital Multimeter FLUKE	87III	73680266	Nov. 10, 2015	Nov. 09, 2016

**Note:**

1. The calibration interval of the above test instruments is 12 months and the calibrations are traceable to NML/ROC and NIST/USA.
2. \*The calibration interval of the above test instruments is 24 months and the calibrations are traceable to NML/ROC and NIST/USA.
3. Loop antenna was used for all emissions below 30 MHz.
4. The test was performed in 966 Chamber No. 3.
6. The FCC Site Registration No. is 147459
8. The CANADA Site Registration No. is 20331-1
- 9 Tested Date: July 30 to Aug. 23, 2016



#### 4.1.3 Test Procedure

- a. The EUT was placed on the top of a rotating table 0.8 meters (for below 1GHz) / 1.5 meters (for above 1GHz) above the ground at 3 meter chamber room for test. The table was rotated 360 degrees to determine the position of the highest radiation.
- b. The EUT was set 3 meters away from the interference-receiving antenna, which was mounted on the top of a variable-height antenna tower.
- c. The height of antenna is varied from one meter to four meters above the ground to determine the maximum value of the field strength. Both horizontal and vertical polarizations of the antenna are set to make the measurement.
- d. For each suspected emission, the EUT was arranged to its worst case and then the antenna was tuned to heights from 1 meter to 4 meters and the rotatable table was turned from 0 degrees to 360 degrees to find the maximum reading.
- e. The test-receiver system was set to quasi-peak detect function and specified bandwidth with maximum hold mode when the test frequency is below 1 GHz.
- f. The test-receiver system was set to peak and average detect function and specified bandwidth with maximum hold mode when the test frequency is above 1 GHz. If the peak reading value also meets average limit, measurement with the average detector is unnecessary.

**Note:**

1. The resolution bandwidth and video bandwidth of test receiver/spectrum analyzer is 120kHz for Quasi-peak detection (QP) at frequency below 1GHz.
2. The resolution bandwidth of test receiver/spectrum analyzer is 1 MHz and the video bandwidth is 3 MHz for Peak detection (PK) at frequency above 1GHz.
3. The resolution bandwidth of test receiver/spectrum analyzer is 1MHz and the video bandwidth is  $\geq 1/T$  (Duty cycle < 98%) or 10Hz (Duty cycle  $\geq$  98%) for Average detection (AV) at frequency above 1GHz.
4. All modes of operation were investigated and the worst-case emissions are reported.

#### 4.1.4 Deviation from Test Standard

No deviation.

#### 4.1.5 Test Setup

##### <Frequency Range below 1GHz>

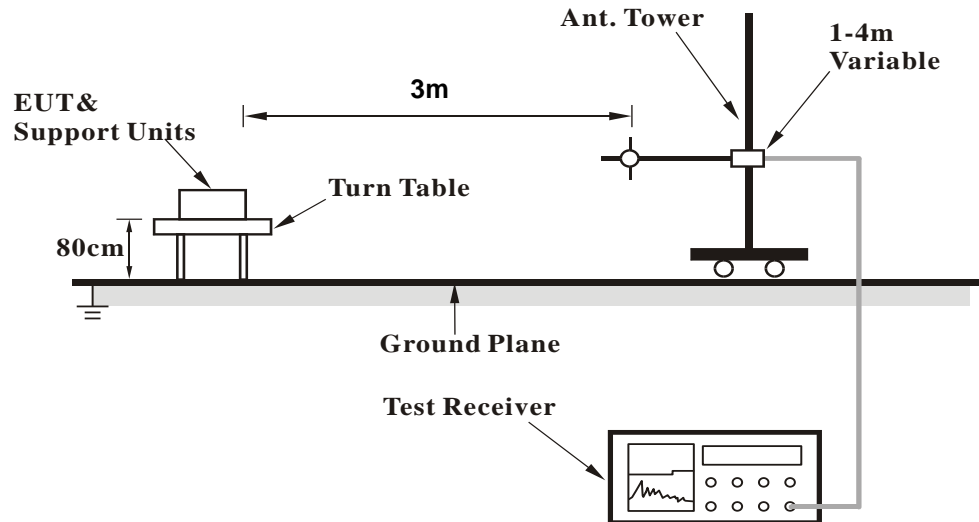

##### <Frequency Range above 1GHz>

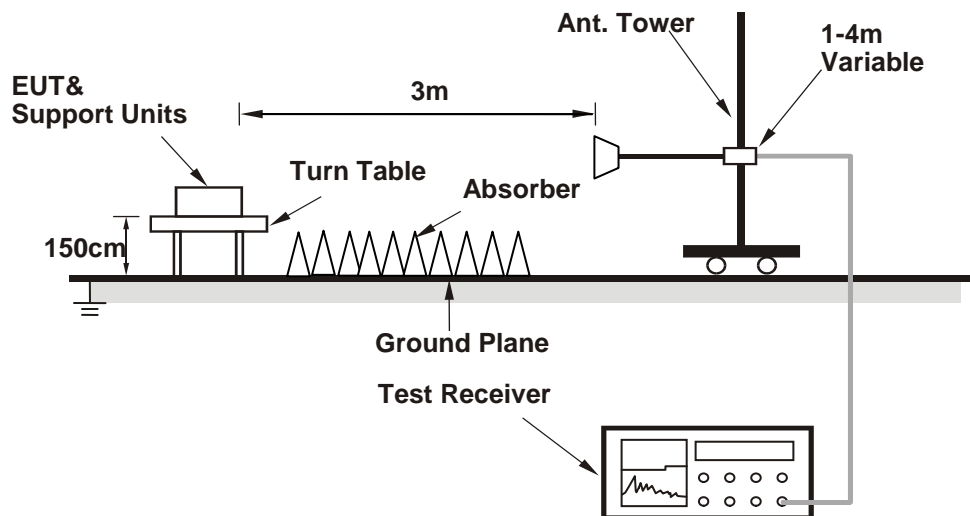

For the actual test configuration, please refer to the attached file (Test Setup Photo).

#### 4.1.6 EUT Operating Condition

- Connect the EUT with the support unit A (Notebook Computer) which is placed outside of testing area.
- The communication partner run test program "QRCT.exe[Ver3.0.174.0]" to enable EUT under transmission/receiving condition continuously at specific channel frequency.
- Support unit C (iPod shuffle) was connected to EUT via one USB cable to simulate real connection.

4.1.7 Test Results (Mode 1)

Above 1GHz Data :

802.11a

<b>CHANNEL</b>	TX Channel 52	<b>DETECTOR FUNCTION</b>	Peak (PK)
<b>FREQUENCY RANGE</b>	1GHz ~ 40GHz		Average (AV)

**ANTENNA POLARITY & TEST DISTANCE: HORIZONTAL AT 3 M**

NO.	FREQ. (MHz)	EMISSION LEVEL (dBuV/m)	LIMIT (dBuV/m)	MARGIN (dB)	ANTENNA HEIGHT (m)	TABLE ANGLE (Degree)	RAW VALUE (dBuV)	CORRECTION FACTOR (dB/m)
1	5150.00	52.8 PK	74.0	-21.2	1.62 H	134	51.2	1.6
2	5150.00	38.8 AV	54.0	-15.2	1.62 H	134	37.2	1.6
3	*5260.00	111.3 PK			1.62 H	134	109.4	1.9
4	*5260.00	101.8 AV			1.62 H	134	99.9	1.9
5	#10520.00	50.2 PK	74.0	-23.8	1.91 H	201	37.7	12.5
6	#10520.00	39.3 AV	54.0	-14.7	1.91 H	201	26.8	12.5
7	15780.00	54.1 PK	74.0	-19.9	1.23 H	201	41.0	13.1
8	15780.00	42.8 AV	54.0	-11.2	1.23 H	201	29.7	13.1

**ANTENNA POLARITY & TEST DISTANCE: VERTICAL AT 3 M**

NO.	FREQ. (MHz)	EMISSION LEVEL (dBuV/m)	LIMIT (dBuV/m)	MARGIN (dB)	ANTENNA HEIGHT (m)	TABLE ANGLE (Degree)	RAW VALUE (dBuV)	CORRECTION FACTOR (dB/m)
1	5150.00	54.0 PK	74.0	-20.0	3.81 V	189	52.4	1.6
2	5150.00	40.1 AV	54.0	-13.9	3.81 V	189	38.5	1.6
3	*5260.00	112.8 PK			3.81 V	189	110.9	1.9
4	*5260.00	103.5 AV			3.81 V	189	101.6	1.9
5	#10520.00	50.8 PK	74.0	-23.2	1.04 V	232	38.3	12.5
6	#10520.00	39.6 AV	54.0	-14.4	1.04 V	232	27.1	12.5
7	15780.00	55.2 PK	74.0	-18.8	1.98 V	133	42.1	13.1
8	15780.00	43.4 AV	54.0	-10.6	1.98 V	133	30.3	13.1

**REMARKS:**

1. Emission Level(dBuV/m) = Raw Value(dBuV) + Correction Factor(dB/m)
2. Correction Factor(dB/m) = Antenna Factor(dB/m) + Cable Factor(dB) – Pre-Amplifier Factor(dB)
3. The other emission levels were very low against the limit.
4. Margin value = Emission Level – Limit value
5. " \* ": Fundamental frequency.
6. " # ": The radiated frequency is out of the restricted band.

<b>CHANNEL</b>	TX Channel 60	<b>DETECTOR FUNCTION</b>	Peak (PK)
<b>FREQUENCY RANGE</b>	1GHz ~ 40GHz		Average (AV)

**ANTENNA POLARITY & TEST DISTANCE: HORIZONTAL AT 3 M**

NO.	FREQ. (MHz)	EMISSION LEVEL (dBuV/m)	LIMIT (dBuV/m)	MARGIN (dB)	ANTENNA HEIGHT (m)	TABLE ANGLE (Degree)	RAW VALUE (dBuV)	CORRECTION FACTOR (dB/m)
1	*5300.00	110.6 PK			1.72 H	155	108.6	2.0
2	*5300.00	100.6 AV			1.72 H	155	98.6	2.0
3	5350.00	52.3 PK	74.0	-21.7	1.72 H	155	50.2	2.1
4	5350.00	38.5 AV	54.0	-15.5	1.72 H	155	36.4	2.1
5	10600.00	50.5 PK	74.0	-23.5	1.90 H	197	37.8	12.7
6	10600.00	39.1 AV	54.0	-14.9	1.90 H	197	26.4	12.7
7	15900.00	54.7 PK	74.0	-19.3	1.19 H	200	41.4	13.3
8	15900.00	43.1 AV	54.0	-10.9	1.19 H	200	29.8	13.3

**ANTENNA POLARITY & TEST DISTANCE: VERTICAL AT 3 M**

NO.	FREQ. (MHz)	EMISSION LEVEL (dBuV/m)	LIMIT (dBuV/m)	MARGIN (dB)	ANTENNA HEIGHT (m)	TABLE ANGLE (Degree)	RAW VALUE (dBuV)	CORRECTION FACTOR (dB/m)
1	*5300.00	112.1 PK			3.96 V	181	110.1	2.0
2	*5300.00	102.4 AV			3.96 V	181	100.4	2.0
3	5350.00	53.8 PK	74.0	-20.2	3.96 V	197	51.7	2.1
4	5350.00	40.0 AV	54.0	-14.0	3.96 V	197	37.9	2.1
5	10600.00	50.6 PK	74.0	-23.4	1.02 V	246	37.9	12.7
6	10600.00	38.9 AV	54.0	-15.1	1.02 V	246	26.2	12.7
7	15900.00	55.2 PK	74.0	-18.8	2.04 V	113	41.9	13.3
8	15900.00	43.4 AV	54.0	-10.6	2.04 V	113	30.1	13.3

**REMARKS:**

1. Emission Level(dBuV/m) = Raw Value(dBuV) + Correction Factor(dB/m)
2. Correction Factor(dB/m) = Antenna Factor(dB/m) + Cable Factor(dB) – Pre-Amplifier Factor(dB)
3. The other emission levels were very low against the limit.
4. Margin value = Emission Level – Limit value
5. " \* ": Fundamental frequency.

<b>CHANNEL</b>	TX Channel 64	<b>DETECTOR FUNCTION</b>	Peak (PK)
<b>FREQUENCY RANGE</b>	1GHz ~ 40GHz		Average (AV)

**ANTENNA POLARITY & TEST DISTANCE: HORIZONTAL AT 3 M**

NO.	FREQ. (MHz)	EMISSION LEVEL (dBuV/m)	LIMIT (dBuV/m)	MARGIN (dB)	ANTENNA HEIGHT (m)	TABLE ANGLE (Degree)	RAW VALUE (dBuV)	CORRECTION FACTOR (dB/m)
1	5000.00	54.4 PK	74.0	-19.6	1.63 H	161	52.9	1.5
2	5000.00	40.5 AV	54.0	-13.5	1.63 H	161	39.0	1.5
3	*5320.00	110.8 PK			1.63 H	161	108.8	2.0
4	*5320.00	101.5 AV			1.63 H	161	99.5	2.0
5	5350.00	53.9 PK	74.0	-20.1	1.63 H	161	51.8	2.1
6	5350.00	41.6 AV	54.0	-12.4	1.63 H	161	39.5	2.1
7	10640.00	50.6 PK	74.0	-23.4	1.87 H	218	37.9	12.7
8	10640.00	39.1 AV	54.0	-14.9	1.87 H	218	26.4	12.7
9	15960.00	55.1 PK	74.0	-18.9	1.16 H	195	42.0	13.1
10	15960.00	43.4 AV	54.0	-10.6	1.16 H	195	30.3	13.1

**ANTENNA POLARITY & TEST DISTANCE: VERTICAL AT 3 M**

NO.	FREQ. (MHz)	EMISSION LEVEL (dBuV/m)	LIMIT (dBuV/m)	MARGIN (dB)	ANTENNA HEIGHT (m)	TABLE ANGLE (Degree)	RAW VALUE (dBuV)	CORRECTION FACTOR (dB/m)
1	5000.00	54.1 PK	74.0	-19.9	3.82 V	155	52.6	1.5
2	5000.00	40.1 AV	54.0	-13.9	3.82 V	155	38.6	1.5
3	*5320.00	112.4 PK			3.82 V	176	110.4	2.0
4	*5320.00	102.8 AV			3.82 V	176	100.8	2.0
5	5350.00	55.7 PK	74.0	-18.3	3.21 V	177	53.6	2.1
6	5350.00	43.2 AV	54.0	-10.8	3.21 V	177	41.1	2.1
7	10640.00	50.8 PK	74.0	-23.2	1.03 V	249	38.1	12.7
8	10640.00	39.1 AV	54.0	-14.9	1.03 V	249	26.4	12.7
9	15960.00	54.7 PK	74.0	-19.3	1.99 V	113	41.6	13.1
10	15960.00	43.1 AV	54.0	-10.9	1.99 V	113	30.0	13.1

**REMARKS:**

1. Emission Level(dBuV/m) = Raw Value(dBuV) + Correction Factor(dB/m)
2. Correction Factor(dB/m) = Antenna Factor(dB/m) + Cable Factor(dB) – Pre-Amplifier Factor(dB)
3. The other emission levels were very low against the limit.
4. Margin value = Emission Level – Limit value
5. " \* ": Fundamental frequency.

<b>CHANNEL</b>	TX Channel 100	<b>DETECTOR FUNCTION</b>	Peak (PK)
<b>FREQUENCY RANGE</b>	1GHz ~ 40GHz		Average (AV)

**ANTENNA POLARITY & TEST DISTANCE: HORIZONTAL AT 3 M**

NO.	FREQ. (MHz)	EMISSION LEVEL (dBuV/m)	LIMIT (dBuV/m)	MARGIN (dB)	ANTENNA HEIGHT (m)	TABLE ANGLE (Degree)	RAW VALUE (dBuV)	CORRECTION FACTOR (dB/m)
1	#5470.00	55.6 PK	74.0	-18.4	1.68 H	150	53.3	2.3
2	#5470.00	43.4 AV	54.0	-10.6	1.68 H	150	41.1	2.3
3	*5500.00	111.0 PK			1.68 H	150	108.7	2.3
4	*5500.00	101.4 AV			1.68 H	150	99.1	2.3
5	11000.00	50.9 PK	74.0	-23.1	1.90 H	213	37.5	13.4
6	11000.00	39.4 AV	54.0	-14.6	1.90 H	213	26.0	13.4
7	#16500.00	54.9 PK	74.0	-19.1	1.19 H	217	39.3	15.6
8	#16500.00	43.3 AV	54.0	-10.7	1.19 H	217	27.7	15.6

**ANTENNA POLARITY & TEST DISTANCE: VERTICAL AT 3 M**

NO.	FREQ. (MHz)	EMISSION LEVEL (dBuV/m)	LIMIT (dBuV/m)	MARGIN (dB)	ANTENNA HEIGHT (m)	TABLE ANGLE (Degree)	RAW VALUE (dBuV)	CORRECTION FACTOR (dB/m)
1	#5470.00	57.7 PK	74.0	-16.3	3.88 V	172	55.4	2.3
2	#5470.00	45.2 AV	54.0	-8.8	3.88 V	172	42.9	2.3
3	*5500.00	112.7 PK			3.96 V	183	110.4	2.3
4	*5500.00	102.9 AV			3.96 V	183	100.6	2.3
5	11000.00	50.4 PK	74.0	-23.6	1.05 V	251	37.0	13.4
6	11000.00	39.0 AV	54.0	-15.0	1.05 V	251	25.6	13.4
7	#16500.00	55.0 PK	74.0	-19.0	1.95 V	115	39.4	15.6
8	#16500.00	43.1 AV	54.0	-10.9	1.95 V	115	27.5	15.6

**REMARKS:**

1. Emission Level(dBuV/m) = Raw Value(dBuV) + Correction Factor(dB/m)
2. Correction Factor(dB/m) = Antenna Factor(dB/m) + Cable Factor(dB) – Pre-Amplifier Factor(dB)
3. The other emission levels were very low against the limit.
4. Margin value = Emission Level – Limit value
5. " \* ": Fundamental frequency.
6. " # ": The radiated frequency is out of the restricted band.

<b>CHANNEL</b>	TX Channel 116	<b>DETECTOR FUNCTION</b>	Peak (PK)
<b>FREQUENCY RANGE</b>	1GHz ~ 40GHz		Average (AV)

**ANTENNA POLARITY & TEST DISTANCE: HORIZONTAL AT 3 M**

NO.	FREQ. (MHz)	EMISSION LEVEL (dBuV/m)	LIMIT (dBuV/m)	MARGIN (dB)	ANTENNA HEIGHT (m)	TABLE ANGLE (Degree)	RAW VALUE (dBuV)	CORRECTION FACTOR (dB/m)
1	#5470.00	54.5 PK	74.0	-19.5	1.65 H	134	52.2	2.3
2	#5470.00	40.3 AV	54.0	-13.7	1.65 H	134	38.0	2.3
3	*5580.00	110.9 PK			1.65 H	134	108.4	2.5
4	*5580.00	101.2 AV			1.65 H	134	98.7	2.5
5	#5725.00	54.8 PK	74.0	-19.2	1.65 H	134	52.0	2.8
6	#5725.00	40.6 AV	54.0	-13.4	1.65 H	134	37.8	2.8
7	11160.00	50.5 PK	74.0	-23.5	1.85 H	209	37.2	13.3
8	11160.00	39.3 AV	54.0	-14.7	1.85 H	209	26.0	13.3
9	#16740.00	54.6 PK	74.0	-19.4	1.25 H	192	38.2	16.4
10	#16740.00	43.1 AV	54.0	-10.9	1.25 H	192	26.7	16.4

**ANTENNA POLARITY & TEST DISTANCE: VERTICAL AT 3 M**

NO.	FREQ. (MHz)	EMISSION LEVEL (dBuV/m)	LIMIT (dBuV/m)	MARGIN (dB)	ANTENNA HEIGHT (m)	TABLE ANGLE (Degree)	RAW VALUE (dBuV)	CORRECTION FACTOR (dB/m)
1	#5470.00	54.5 PK	74.0	-19.5	3.71 V	171	52.2	2.3
2	#5470.00	40.3 AV	54.0	-13.7	3.71 V	171	38.0	2.3
3	*5580.00	112.7 PK			3.50 V	181	110.2	2.5
4	*5580.00	103.1 AV			3.50 V	181	100.6	2.5
5	#5725.00	54.8 PK	74.0	-19.2	3.71 V	171	52.0	2.8
6	#5725.00	40.5 AV	54.0	-13.5	3.71 V	171	37.7	2.8
7	11160.00	50.9 PK	74.0	-23.1	1.09 V	227	37.6	13.3
8	11160.00	39.5 AV	54.0	-14.5	1.09 V	227	26.2	13.3
9	#16740.00	55.7 PK	74.0	-18.3	1.95 V	122	39.3	16.4
10	#16740.00	43.7 AV	54.0	-10.3	1.95 V	122	27.3	16.4

**REMARKS:**

1. Emission Level(dBuV/m) = Raw Value(dBuV) + Correction Factor(dB/m)
2. Correction Factor(dB/m) = Antenna Factor(dB/m) + Cable Factor(dB) – Pre-Amplifier Factor(dB)
3. The other emission levels were very low against the limit.
4. Margin value = Emission Level – Limit value
5. " \* ": Fundamental frequency.
6. " # ": The radiated frequency is out of the restricted band.

<b>CHANNEL</b>	TX Channel 140	<b>DETECTOR FUNCTION</b>	Peak (PK)
<b>FREQUENCY RANGE</b>	1GHz ~ 40GHz		Average (AV)

**ANTENNA POLARITY & TEST DISTANCE: HORIZONTAL AT 3 M**

NO.	FREQ. (MHz)	EMISSION LEVEL (dBuV/m)	LIMIT (dBuV/m)	MARGIN (dB)	ANTENNA HEIGHT (m)	TABLE ANGLE (Degree)	RAW VALUE (dBuV)	CORRECTION FACTOR (dB/m)
1	*5700.00	109.5 PK			1.00 H	132	106.7	2.8
2	*5700.00	100.7 AV			1.00 H	132	97.9	2.8
3	#5725.00	58.6 PK	74.0	-15.4	1.67 H	145	55.8	2.8
4	#5725.00	44.0 AV	54.0	-10.0	1.67 H	145	41.2	2.8
5	11400.00	51.1 PK	74.0	-22.9	1.87 H	207	37.7	13.4
6	11400.00	39.8 AV	54.0	-14.2	1.87 H	207	26.4	13.4
7	#17100.00	54.7 PK	74.0	-19.3	1.23 H	207	36.8	17.9
8	#17100.00	43.5 AV	54.0	-10.5	1.23 H	207	25.6	17.9

**ANTENNA POLARITY & TEST DISTANCE: VERTICAL AT 3 M**

NO.	FREQ. (MHz)	EMISSION LEVEL (dBuV/m)	LIMIT (dBuV/m)	MARGIN (dB)	ANTENNA HEIGHT (m)	TABLE ANGLE (Degree)	RAW VALUE (dBuV)	CORRECTION FACTOR (dB/m)
1	*5700.00	111.2 PK			3.30 V	173	108.4	2.8
2	*5700.00	102.5 AV			3.30 V	173	99.7	2.8
3	#5725.00	60.2 PK	74.0	-13.8	3.12 V	191	57.4	2.8
4	#5725.00	45.7 AV	54.0	-8.3	3.12 V	191	42.9	2.8
5	11400.00	51.3 PK	74.0	-22.7	1.09 V	217	37.9	13.4
6	11400.00	39.7 AV	54.0	-14.3	1.09 V	217	26.3	13.4
7	#17100.00	55.6 PK	74.0	-18.4	1.90 V	121	37.7	17.9
8	#17100.00	43.7 AV	54.0	-10.3	1.90 V	121	25.8	17.9

**REMARKS:**

1. Emission Level(dBuV/m) = Raw Value(dBuV) + Correction Factor(dB/m)
2. Correction Factor(dB/m) = Antenna Factor(dB/m) + Cable Factor(dB) – Pre-Amplifier Factor(dB)
3. The other emission levels were very low against the limit.
4. Margin value = Emission Level – Limit value
5. " \* ": Fundamental frequency.
6. " # ": The radiated frequency is out of the restricted band.



<b>CHANNEL</b>	TX Channel 144	<b>DETECTOR FUNCTION</b>	Peak (PK)
<b>FREQUENCY RANGE</b>	1GHz ~ 40GHz		Average (AV)

**ANTENNA POLARITY & TEST DISTANCE: HORIZONTAL AT 3 M**

NO.	FREQ. (MHz)	EMISSION LEVEL (dBuV/m)	LIMIT (dBuV/m)	MARGIN (dB)	ANTENNA HEIGHT (m)	TABLE ANGLE (Degree)	RAW VALUE (dBuV)	CORRECTION FACTOR (dB/m)
1	#5470.00	54.8 PK	74.0	-19.2	1.64 H	155	52.5	2.3
2	#5470.00	40.6 AV	54.0	-13.4	1.64 H	155	38.3	2.3
3	*5720.00	111.5 PK			1.64 H	155	108.7	2.8
4	*5720.00	102.0 AV			1.64 H	155	99.2	2.8
5	#5850.00	54.8 PK	74.0	-19.2	1.64 H	155	51.8	3.0
6	#5850.00	40.4 AV	54.0	-13.6	1.64 H	155	37.4	3.0
7	11440.00	50.8 PK	74.0	-23.2	1.85 H	203	37.4	13.4
8	11440.00	39.6 AV	54.0	-14.4	1.85 H	203	26.2	13.4
9	#17160.00	54.7 PK	74.0	-19.3	1.22 H	206	36.6	18.1
10	#17160.00	43.2 AV	54.0	-10.8	1.22 H	206	25.1	18.1

**ANTENNA POLARITY & TEST DISTANCE: VERTICAL AT 3 M**

NO.	FREQ. (MHz)	EMISSION LEVEL (dBuV/m)	LIMIT (dBuV/m)	MARGIN (dB)	ANTENNA HEIGHT (m)	TABLE ANGLE (Degree)	RAW VALUE (dBuV)	CORRECTION FACTOR (dB/m)
1	#5470.00	54.1 PK	74.0	-19.9	3.63 V	181	51.8	2.3
2	#5470.00	40.1 AV	54.0	-13.9	3.63 V	181	37.8	2.3
3	*5720.00	112.7 PK			3.63 V	181	109.9	2.8
4	*5720.00	103.3 AV			3.63 V	181	100.5	2.8
5	#5850.00	54.8 PK	74.0	-19.2	3.63 V	181	51.8	3.0
6	#5850.00	40.3 AV	54.0	-13.7	3.63 V	181	37.3	3.0
7	11440.00	50.9 PK	74.0	-23.1	1.00 V	238	37.5	13.4
8	11440.00	39.4 AV	54.0	-14.6	1.00 V	238	26.0	13.4
9	#17160.00	55.0 PK	74.0	-19.0	1.98 V	127	36.9	18.1
10	#17160.00	43.2 AV	54.0	-10.8	1.98 V	127	25.1	18.1

**REMARKS:**

1. Emission Level(dBuV/m) = Raw Value(dBuV) + Correction Factor(dB/m)
2. Correction Factor(dB/m) = Antenna Factor(dB/m) + Cable Factor(dB) – Pre-Amplifier Factor(dB)
3. The other emission levels were very low against the limit.
4. Margin value = Emission Level – Limit value
5. " \* ": Fundamental frequency.
6. " # ": The radiated frequency is out of the restricted band.

**802.11ac (VHT20)**

<b>CHANNEL</b>	TX Channel 52	<b>DETECTOR FUNCTION</b>	Peak (PK)
<b>FREQUENCY RANGE</b>	1GHz ~ 40GHz		Average (AV)

**ANTENNA POLARITY & TEST DISTANCE: HORIZONTAL AT 3 M**

NO.	FREQ. (MHz)	EMISSION LEVEL (dBuV/m)	LIMIT (dBuV/m)	MARGIN (dB)	ANTENNA HEIGHT (m)	TABLE ANGLE (Degree)	RAW VALUE (dBuV)	CORRECTION FACTOR (dB/m)
1	5150.00	55.6 PK	74.0	-18.4	1.66 H	154	54.0	1.6
2	5150.00	40.9 AV	54.0	-13.1	1.66 H	154	39.3	1.6
3	*5260.00	111.8 PK			1.66 H	154	109.9	1.9
4	*5260.00	102.1 AV			1.66 H	154	100.2	1.9
5	#10520.00	50.6 PK	74.0	-23.4	1.85 H	199	38.1	12.5
6	#10520.00	39.3 AV	54.0	-14.7	1.85 H	199	26.8	12.5
7	15780.00	55.3 PK	74.0	-18.7	1.16 H	197	42.2	13.1
8	15780.00	43.6 AV	54.0	-10.4	1.16 H	197	30.5	13.1

**ANTENNA POLARITY & TEST DISTANCE: VERTICAL AT 3 M**

NO.	FREQ. (MHz)	EMISSION LEVEL (dBuV/m)	LIMIT (dBuV/m)	MARGIN (dB)	ANTENNA HEIGHT (m)	TABLE ANGLE (Degree)	RAW VALUE (dBuV)	CORRECTION FACTOR (dB/m)
1	5150.00	55.3 PK	74.0	-18.7	3.96 V	176	53.7	1.6
2	5150.00	40.8 AV	54.0	-13.2	3.96 V	176	39.2	1.6
3	*5260.00	113.4 PK			3.67 V	176	111.5	1.9
4	*5260.00	103.7 AV			3.67 V	176	101.8	1.9
5	#10520.00	51.4 PK	74.0	-22.6	1.11 V	239	38.9	12.5
6	#10520.00	39.7 AV	54.0	-14.3	1.11 V	239	27.2	12.5
7	15780.00	55.5 PK	74.0	-18.5	1.95 V	131	42.4	13.1
8	15780.00	43.3 AV	54.0	-10.7	1.95 V	131	30.2	13.1

**REMARKS:**

- Emission Level(dBuV/m) = Raw Value(dBuV) + Correction Factor(dB/m)
- Correction Factor(dB/m) = Antenna Factor(dB/m) + Cable Factor(dB) – Pre-Amplifier Factor(dB)
- The other emission levels were very low against the limit.
- Margin value = Emission Level – Limit value
- " \* ": Fundamental frequency.
- " # ": The radiated frequency is out of the restricted band.

<b>CHANNEL</b>	TX Channel 60	<b>DETECTOR FUNCTION</b>	Peak (PK)
<b>FREQUENCY RANGE</b>	1GHz ~ 40GHz		Average (AV)

**ANTENNA POLARITY & TEST DISTANCE: HORIZONTAL AT 3 M**

NO.	FREQ. (MHz)	EMISSION LEVEL (dBuV/m)	LIMIT (dBuV/m)	MARGIN (dB)	ANTENNA HEIGHT (m)	TABLE ANGLE (Degree)	RAW VALUE (dBuV)	CORRECTION FACTOR (dB/m)
1	*5300.00	111.6 PK			1.64 H	133	109.6	2.0
2	*5300.00	102.1 AV			1.64 H	133	100.1	2.0
3	5350.00	54.9 PK	74.0	-19.1	1.64 H	133	52.8	2.1
4	5350.00	40.5 AV	54.0	-13.5	1.64 H	133	38.4	2.1
5	10600.00	50.3 PK	74.0	-23.7	1.87 H	207	37.6	12.7
6	10600.00	39.3 AV	54.0	-14.7	1.87 H	207	26.6	12.7
7	15900.00	54.9 PK	74.0	-19.1	1.16 H	193	41.6	13.3
8	15900.00	43.3 AV	54.0	-10.7	1.16 H	193	30.0	13.3

**ANTENNA POLARITY & TEST DISTANCE: VERTICAL AT 3 M**

NO.	FREQ. (MHz)	EMISSION LEVEL (dBuV/m)	LIMIT (dBuV/m)	MARGIN (dB)	ANTENNA HEIGHT (m)	TABLE ANGLE (Degree)	RAW VALUE (dBuV)	CORRECTION FACTOR (dB/m)
1	*5300.00	112.9 PK			3.55 V	169	110.9	2.0
2	*5300.00	103.5 AV			3.55 V	169	101.5	2.0
3	5350.00	54.8 PK	74.0	-19.2	3.96 V	189	52.7	2.1
4	5350.00	40.5 AV	54.0	-13.5	3.96 V	189	38.4	2.1
5	10600.00	51.3 PK	74.0	-22.7	1.08 V	219	38.6	12.7
6	10600.00	40.0 AV	54.0	-14.0	1.08 V	219	27.3	12.7
7	15900.00	56.1 PK	74.0	-17.9	1.90 V	130	42.8	13.3
8	15900.00	44.0 AV	54.0	-10.0	1.90 V	130	30.7	13.3

**REMARKS:**

1. Emission Level(dBuV/m) = Raw Value(dBuV) + Correction Factor(dB/m)
2. Correction Factor(dB/m) = Antenna Factor(dB/m) + Cable Factor(dB) – Pre-Amplifier Factor(dB)
3. The other emission levels were very low against the limit.
4. Margin value = Emission Level – Limit value
5. " \* ": Fundamental frequency.

<b>CHANNEL</b>	TX Channel 64	<b>DETECTOR FUNCTION</b>	Peak (PK)
<b>FREQUENCY RANGE</b>	1GHz ~ 40GHz		Average (AV)

**ANTENNA POLARITY & TEST DISTANCE: HORIZONTAL AT 3 M**

NO.	FREQ. (MHz)	EMISSION LEVEL (dBuV/m)	LIMIT (dBuV/m)	MARGIN (dB)	ANTENNA HEIGHT (m)	TABLE ANGLE (Degree)	RAW VALUE (dBuV)	CORRECTION FACTOR (dB/m)
1	*5320.00	113.2 PK			1.66 H	152	111.2	2.0
2	*5320.00	104.2 AV			1.66 H	152	102.2	2.0
3	5350.00	58.5 PK	74.0	-15.5	1.66 H	152	56.4	2.1
4	5350.00	44.5 AV	54.0	-9.5	1.66 H	152	42.4	2.1
5	10640.00	51.1 PK	74.0	-22.9	1.85 H	191	38.4	12.7
6	10640.00	39.7 AV	54.0	-14.3	1.85 H	191	27.0	12.7
7	15960.00	54.3 PK	74.0	-19.7	1.24 H	199	41.2	13.1
8	15960.00	43.1 AV	54.0	-10.9	1.24 H	199	30.0	13.1

**ANTENNA POLARITY & TEST DISTANCE: VERTICAL AT 3 M**

NO.	FREQ. (MHz)	EMISSION LEVEL (dBuV/m)	LIMIT (dBuV/m)	MARGIN (dB)	ANTENNA HEIGHT (m)	TABLE ANGLE (Degree)	RAW VALUE (dBuV)	CORRECTION FACTOR (dB/m)
1	*5320.00	114.3 PK			3.82 V	176	112.3	2.0
2	*5320.00	105.3 AV			3.82 V	176	103.3	2.0
3	5350.00	60.0 PK	74.0	-14.0	3.83 V	163	57.9	2.1
4	5350.00	46.1 AV	54.0	-7.9	3.83 V	163	44.0	2.1
5	10640.00	50.6 PK	74.0	-23.4	1.10 V	240	37.9	12.7
6	10640.00	39.4 AV	54.0	-14.6	1.10 V	240	26.7	12.7
7	15960.00	55.4 PK	74.0	-18.6	1.92 V	122	42.3	13.1
8	15960.00	43.3 AV	54.0	-10.7	1.92 V	122	30.2	13.1

**REMARKS:**

1. Emission Level(dBuV/m) = Raw Value(dBuV) + Correction Factor(dB/m)
2. Correction Factor(dB/m) = Antenna Factor(dB/m) + Cable Factor(dB) – Pre-Amplifier Factor(dB)
3. The other emission levels were very low against the limit.
4. Margin value = Emission Level – Limit value
5. " \* ": Fundamental frequency.

<b>CHANNEL</b>	TX Channel 100	<b>DETECTOR FUNCTION</b>	Peak (PK)
<b>FREQUENCY RANGE</b>	1GHz ~ 40GHz		Average (AV)

**ANTENNA POLARITY & TEST DISTANCE: HORIZONTAL AT 3 M**

NO.	FREQ. (MHz)	EMISSION LEVEL (dBuV/m)	LIMIT (dBuV/m)	MARGIN (dB)	ANTENNA HEIGHT (m)	TABLE ANGLE (Degree)	RAW VALUE (dBuV)	CORRECTION FACTOR (dB/m)
1	#5470.00	59.1 PK	74.0	-14.9	1.64 H	152	56.8	2.3
2	#5470.00	44.8 AV	54.0	-9.2	1.64 H	152	42.5	2.3
3	*5500.00	110.7 PK			1.64 H	152	108.4	2.3
4	*5500.00	101.9 AV			1.64 H	152	99.6	2.3
5	11000.00	51.1 PK	74.0	-22.9	1.89 H	206	37.7	13.4
6	11000.00	39.9 AV	54.0	-14.1	1.89 H	206	26.5	13.4
7	#16500.00	54.4 PK	74.0	-19.6	1.19 H	209	38.8	15.6
8	#16500.00	43.1 AV	54.0	-10.9	1.19 H	209	27.5	15.6

**ANTENNA POLARITY & TEST DISTANCE: VERTICAL AT 3 M**

NO.	FREQ. (MHz)	EMISSION LEVEL (dBuV/m)	LIMIT (dBuV/m)	MARGIN (dB)	ANTENNA HEIGHT (m)	TABLE ANGLE (Degree)	RAW VALUE (dBuV)	CORRECTION FACTOR (dB/m)
1	#5470.00	60.6 PK	74.0	-13.4	3.24 V	161	58.3	2.3
2	#5470.00	46.4 AV	54.0	-7.6	3.24 V	161	44.1	2.3
3	*5500.00	112.3 PK			3.44 V	176	110.0	2.3
4	*5500.00	103.8 AV			3.44 V	176	101.5	2.3
5	11000.00	50.6 PK	74.0	-23.4	1.12 V	243	37.2	13.4
6	11000.00	39.3 AV	54.0	-14.7	1.12 V	243	25.9	13.4
7	#16500.00	55.4 PK	74.0	-18.6	1.93 V	128	39.8	15.6
8	#16500.00	43.7 AV	54.0	-10.3	1.93 V	128	28.1	15.6

**REMARKS:**

1. Emission Level(dBuV/m) = Raw Value(dBuV) + Correction Factor(dB/m)
2. Correction Factor(dB/m) = Antenna Factor(dB/m) + Cable Factor(dB) – Pre-Amplifier Factor(dB)
3. The other emission levels were very low against the limit.
4. Margin value = Emission Level – Limit value
5. " \* ": Fundamental frequency.
6. " # ": The radiated frequency is out of the restricted band.

<b>CHANNEL</b>	TX Channel 116	<b>DETECTOR FUNCTION</b>	Peak (PK)
<b>FREQUENCY RANGE</b>	1GHz ~ 40GHz		Average (AV)

**ANTENNA POLARITY & TEST DISTANCE: HORIZONTAL AT 3 M**

NO.	FREQ. (MHz)	EMISSION LEVEL (dBuV/m)	LIMIT (dBuV/m)	MARGIN (dB)	ANTENNA HEIGHT (m)	TABLE ANGLE (Degree)	RAW VALUE (dBuV)	CORRECTION FACTOR (dB/m)
1	#5470.00	54.5 PK	74.0	-19.5	1.72 H	152	52.2	2.3
2	#5470.00	40.3 AV	54.0	-13.7	1.72 H	152	38.0	2.3
3	*5580.00	110.0 PK			1.72 H	152	107.5	2.5
4	*5580.00	100.8 AV			1.72 H	152	98.3	2.5
5	#5725.00	55.0 PK	74.0	-19.0	1.72 H	152	52.2	2.8
6	#5725.00	40.6 AV	54.0	-13.4	1.72 H	152	37.8	2.8
7	11160.00	50.4 PK	74.0	-23.6	1.80 H	193	37.1	13.3
8	11160.00	39.3 AV	54.0	-14.7	1.80 H	193	26.0	13.3
9	#16740.00	54.4 PK	74.0	-19.6	1.24 H	199	38.0	16.4
10	#16740.00	43.0 AV	54.0	-11.0	1.24 H	199	26.6	16.4

**ANTENNA POLARITY & TEST DISTANCE: VERTICAL AT 3 M**

NO.	FREQ. (MHz)	EMISSION LEVEL (dBuV/m)	LIMIT (dBuV/m)	MARGIN (dB)	ANTENNA HEIGHT (m)	TABLE ANGLE (Degree)	RAW VALUE (dBuV)	CORRECTION FACTOR (dB/m)
1	#5470.00	54.5 PK	74.0	-19.5	3.46 V	180	52.2	2.3
2	#5470.00	40.4 AV	54.0	-13.6	3.46 V	180	38.1	2.3
3	*5580.00	111.8 PK			3.46 V	180	109.3	2.5
4	*5580.00	102.5 AV			3.46 V	180	100.0	2.5
5	#5725.00	55.2 PK	74.0	-18.8	3.46 V	180	52.4	2.8
6	#5725.00	40.9 AV	54.0	-13.1	3.46 V	180	38.1	2.8
7	11160.00	50.7 PK	74.0	-23.3	1.06 V	213	37.4	13.3
8	11160.00	39.2 AV	54.0	-14.8	1.06 V	213	25.9	13.3
9	#16740.00	55.2 PK	74.0	-18.8	1.96 V	115	38.8	16.4
10	#16740.00	43.3 AV	54.0	-10.7	1.96 V	115	26.9	16.4

**REMARKS:**

1. Emission Level(dBuV/m) = Raw Value(dBuV) + Correction Factor(dB/m)
2. Correction Factor(dB/m) = Antenna Factor(dB/m) + Cable Factor(dB) – Pre-Amplifier Factor(dB)
3. The other emission levels were very low against the limit.
4. Margin value = Emission Level – Limit value
5. " \* ": Fundamental frequency.
6. " # ": The radiated frequency is out of the restricted band.

<b>CHANNEL</b>	TX Channel 140	<b>DETECTOR FUNCTION</b>	Peak (PK)
<b>FREQUENCY RANGE</b>	1GHz ~ 40GHz		Average (AV)

**ANTENNA POLARITY & TEST DISTANCE: HORIZONTAL AT 3 M**

NO.	FREQ. (MHz)	EMISSION LEVEL (dBuV/m)	LIMIT (dBuV/m)	MARGIN (dB)	ANTENNA HEIGHT (m)	TABLE ANGLE (Degree)	RAW VALUE (dBuV)	CORRECTION FACTOR (dB/m)
1	*5700.00	111.0 PK			1.63 H	142	108.2	2.8
2	*5700.00	102.3 AV			1.63 H	142	99.5	2.8
3	#5725.00	56.4 PK	74.0	-17.6	1.63 H	142	53.6	2.8
4	#5725.00	45.0 AV	54.0	-9.0	1.63 H	142	42.2	2.8
5	11400.00	50.6 PK	74.0	-23.4	1.82 H	201	37.2	13.4
6	11400.00	39.4 AV	54.0	-14.6	1.82 H	201	26.0	13.4
7	#17100.00	54.7 PK	74.0	-19.3	1.21 H	208	36.8	17.9
8	#17100.00	43.5 AV	54.0	-10.5	1.21 H	208	25.6	17.9

**ANTENNA POLARITY & TEST DISTANCE: VERTICAL AT 3 M**

NO.	FREQ. (MHz)	EMISSION LEVEL (dBuV/m)	LIMIT (dBuV/m)	MARGIN (dB)	ANTENNA HEIGHT (m)	TABLE ANGLE (Degree)	RAW VALUE (dBuV)	CORRECTION FACTOR (dB/m)
1	*5700.00	112.6 PK			3.13 V	192	109.8	2.8
2	*5700.00	103.7 AV			3.13 V	192	100.9	2.8
3	#5725.00	57.6 PK	74.0	-16.4	3.13 V	192	54.8	2.8
4	#5725.00	46.1 AV	54.0	-7.9	3.13 V	192	43.3	2.8
5	11400.00	51.4 PK	74.0	-22.6	1.10 V	222	38.0	13.4
6	11400.00	40.0 AV	54.0	-14.0	1.10 V	222	26.6	13.4
7	#17100.00	55.9 PK	74.0	-18.1	1.94 V	108	38.0	17.9
8	#17100.00	44.0 AV	54.0	-10.0	1.94 V	108	26.1	17.9

**REMARKS:**

- Emission Level(dBuV/m) = Raw Value(dBuV) + Correction Factor(dB/m)
- Correction Factor(dB/m) = Antenna Factor(dB/m) + Cable Factor(dB) – Pre-Amplifier Factor(dB)
- The other emission levels were very low against the limit.
- Margin value = Emission Level – Limit value
- " \* ": Fundamental frequency.
- " # ": The radiated frequency is out of the restricted band.

<b>CHANNEL</b>	TX Channel 144	<b>DETECTOR FUNCTION</b>	Peak (PK)
<b>FREQUENCY RANGE</b>	1GHz ~ 40GHz		Average (AV)

**ANTENNA POLARITY & TEST DISTANCE: HORIZONTAL AT 3 M**

NO.	FREQ. (MHz)	EMISSION LEVEL (dBuV/m)	LIMIT (dBuV/m)	MARGIN (dB)	ANTENNA HEIGHT (m)	TABLE ANGLE (Degree)	RAW VALUE (dBuV)	CORRECTION FACTOR (dB/m)
1	#5470.00	54.2 PK	74.0	-19.8	1.65 H	154	51.9	2.3
2	#5470.00	40.6 AV	54.0	-13.4	1.65 H	154	38.3	2.3
3	*5720.00	110.5 PK			1.65 H	154	107.7	2.8
4	*5720.00	101.4 AV			1.65 H	154	98.6	2.8
5	#5850.00	54.2 PK	74.0	-19.8	1.65 H	154	51.2	3.0
6	#5850.00	40.4 AV	54.0	-13.6	1.65 H	154	37.4	3.0
7	11440.00	50.7 PK	74.0	-23.3	1.85 H	198	37.3	13.4
8	11440.00	39.3 AV	54.0	-14.7	1.85 H	198	25.9	13.4
9	#17160.00	54.8 PK	74.0	-19.2	1.27 H	200	36.7	18.1
10	#17160.00	43.3 AV	54.0	-10.7	1.27 H	200	25.2	18.1

**ANTENNA POLARITY & TEST DISTANCE: VERTICAL AT 3 M**

NO.	FREQ. (MHz)	EMISSION LEVEL (dBuV/m)	LIMIT (dBuV/m)	MARGIN (dB)	ANTENNA HEIGHT (m)	TABLE ANGLE (Degree)	RAW VALUE (dBuV)	CORRECTION FACTOR (dB/m)
1	#5470.00	53.0 PK	74.0	-21.0	3.43 V	183	50.7	2.3
2	#5470.00	41.5 AV	54.0	-12.5	3.43 V	183	39.2	2.3
3	*5720.00	111.6 PK			3.45 V	180	108.8	2.8
4	*5720.00	102.8 AV			3.45 V	180	100.0	2.8
5	#5850.00	52.4 PK	74.0	-21.6	3.43 V	173	49.4	3.0
6	#5850.00	41.3 AV	54.0	-12.7	3.43 V	173	38.3	3.0
7	11440.00	50.5 PK	74.0	-23.5	1.13 V	243	37.1	13.4
8	11440.00	39.1 AV	54.0	-14.9	1.13 V	243	25.7	13.4
9	#17160.00	56.1 PK	74.0	-17.9	1.96 V	117	38.0	18.1
10	#17160.00	44.2 AV	54.0	-9.8	1.96 V	117	26.1	18.1

**REMARKS:**

1. Emission Level(dBuV/m) = Raw Value(dBuV) + Correction Factor(dB/m)
2. Correction Factor(dB/m) = Antenna Factor(dB/m) + Cable Factor(dB) – Pre-Amplifier Factor(dB)
3. The other emission levels were very low against the limit.
4. Margin value = Emission Level – Limit value
5. " \* ": Fundamental frequency.
6. " # ": The radiated frequency is out of the restricted band.



**802.11ac (VHT40)**

<b>CHANNEL</b>	TX Channel 54	<b>DETECTOR FUNCTION</b>	Peak (PK)
<b>FREQUENCY RANGE</b>	1GHz ~ 40GHz		Average (AV)

**ANTENNA POLARITY & TEST DISTANCE: HORIZONTAL AT 3 M**

NO.	FREQ. (MHz)	EMISSION LEVEL (dBuV/m)	LIMIT (dBuV/m)	MARGIN (dB)	ANTENNA HEIGHT (m)	TABLE ANGLE (Degree)	RAW VALUE (dBuV)	CORRECTION FACTOR (dB/m)
1	5150.00	55.2 PK	74.0	-18.8	1.67 H	133	53.6	1.6
2	5150.00	40.8 AV	54.0	-13.2	1.67 H	133	39.2	1.6
3	*5270.00	111.4 PK			1.67 H	133	109.4	2.0
4	*5270.00	100.7 AV			1.67 H	133	98.7	2.0
5	#10540.00	51.3 PK	74.0	-22.7	1.84 H	214	38.8	12.5
6	#10540.00	39.8 AV	54.0	-14.2	1.84 H	214	27.3	12.5
7	15810.00	54.5 PK	74.0	-19.5	1.25 H	208	41.4	13.1
8	15810.00	42.8 AV	54.0	-11.2	1.25 H	208	29.7	13.1

**ANTENNA POLARITY & TEST DISTANCE: VERTICAL AT 3 M**

NO.	FREQ. (MHz)	EMISSION LEVEL (dBuV/m)	LIMIT (dBuV/m)	MARGIN (dB)	ANTENNA HEIGHT (m)	TABLE ANGLE (Degree)	RAW VALUE (dBuV)	CORRECTION FACTOR (dB/m)
1	5150.00	53.2 PK	74.0	-20.8	3.46 V	158	51.6	1.6
2	5150.00	41.8 AV	54.0	-12.2	3.46 V	158	40.2	1.6
3	*5270.00	112.4 PK			3.46 V	158	110.4	2.0
4	*5270.00	101.9 AV			3.46 V	158	99.9	2.0
5	#10540.00	50.8 PK	74.0	-23.2	1.15 V	237	38.3	12.5
6	#10540.00	39.2 AV	54.0	-14.8	1.15 V	237	26.7	12.5
7	15810.00	55.8 PK	74.0	-18.2	1.89 V	126	42.7	13.1
8	15810.00	43.8 AV	54.0	-10.2	1.89 V	126	30.7	13.1

**REMARKS:**

- Emission Level(dBuV/m) = Raw Value(dBuV) + Correction Factor(dB/m)
- Correction Factor(dB/m) = Antenna Factor(dB/m) + Cable Factor(dB) – Pre-Amplifier Factor(dB)
- The other emission levels were very low against the limit.
- Margin value = Emission Level – Limit value
- " \* ": Fundamental frequency.
- " # ": The radiated frequency is out of the restricted band.

<b>CHANNEL</b>	TX Channel 62	<b>DETECTOR FUNCTION</b>	Peak (PK)
<b>FREQUENCY RANGE</b>	1GHz ~ 40GHz		Average (AV)

**ANTENNA POLARITY & TEST DISTANCE: HORIZONTAL AT 3 M**

NO.	FREQ. (MHz)	EMISSION LEVEL (dBuV/m)	LIMIT (dBuV/m)	MARGIN (dB)	ANTENNA HEIGHT (m)	TABLE ANGLE (Degree)	RAW VALUE (dBuV)	CORRECTION FACTOR (dB/m)
1	*5310.00	109.9 PK			3.71 H	124	107.9	2.0
2	*5310.00	100.3 AV			3.71 H	124	98.3	2.0
3	5350.00	62.2 PK	74.0	-11.8	3.71 H	124	60.1	2.1
4	5350.00	49.7 AV	54.0	-4.3	3.71 H	124	47.6	2.1
5	10620.00	51.0 PK	74.0	-23.0	1.85 H	216	38.3	12.7
6	10620.00	39.6 AV	54.0	-14.4	1.85 H	216	26.9	12.7
7	15930.00	54.3 PK	74.0	-19.7	1.26 H	209	41.0	13.3
8	15930.00	42.9 AV	54.0	-11.1	1.26 H	209	29.6	13.3

**ANTENNA POLARITY & TEST DISTANCE: VERTICAL AT 3 M**

NO.	FREQ. (MHz)	EMISSION LEVEL (dBuV/m)	LIMIT (dBuV/m)	MARGIN (dB)	ANTENNA HEIGHT (m)	TABLE ANGLE (Degree)	RAW VALUE (dBuV)	CORRECTION FACTOR (dB/m)
1	*5310.00	112.3 PK			3.50 V	170	110.3	2.0
2	*5310.00	102.0 AV			3.50 V	170	100.0	2.0
3	5350.00	64.2 PK	74.0	-9.8	3.50 V	170	62.1	2.1
4	5350.00	52.3 AV	54.0	-1.7	3.50 V	170	50.2	2.1
5	10620.00	50.8 PK	74.0	-23.2	1.11 V	220	38.1	12.7
6	10620.00	39.4 AV	54.0	-14.6	1.11 V	220	26.7	12.7
7	15930.00	55.4 PK	74.0	-18.6	1.90 V	121	42.1	13.3
8	15930.00	43.5 AV	54.0	-10.5	1.90 V	121	30.2	13.3

**REMARKS:**

1. Emission Level(dBuV/m) = Raw Value(dBuV) + Correction Factor(dB/m)
2. Correction Factor(dB/m) = Antenna Factor(dB/m) + Cable Factor(dB) – Pre-Amplifier Factor(dB)
3. The other emission levels were very low against the limit.
4. Margin value = Emission Level – Limit value
5. " \* ": Fundamental frequency.

<b>CHANNEL</b>	TX Channel 102	<b>DETECTOR FUNCTION</b>	Peak (PK)
<b>FREQUENCY RANGE</b>	1GHz ~ 40GHz		Average (AV)

**ANTENNA POLARITY & TEST DISTANCE: HORIZONTAL AT 3 M**

NO.	FREQ. (MHz)	EMISSION LEVEL (dBuV/m)	LIMIT (dBuV/m)	MARGIN (dB)	ANTENNA HEIGHT (m)	TABLE ANGLE (Degree)	RAW VALUE (dBuV)	CORRECTION FACTOR (dB/m)
1	#5470.00	63.4 PK	74.0	-10.6	1.72 H	129	61.1	2.3
2	#5470.00	49.5 AV	54.0	-4.5	1.72 H	129	47.2	2.3
3	*5510.00	108.2 PK			1.72 H	129	105.9	2.3
4	*5510.00	98.2 AV			1.72 H	129	95.9	2.3
5	11020.00	50.8 PK	74.0	-23.2	1.89 H	195	37.4	13.4
6	11020.00	39.4 AV	54.0	-14.6	1.89 H	195	26.0	13.4
7	#16530.00	54.7 PK	74.0	-19.3	1.25 H	209	38.9	15.8
8	#16530.00	43.2 AV	54.0	-10.8	1.25 H	209	27.4	15.8

**ANTENNA POLARITY & TEST DISTANCE: VERTICAL AT 3 M**

NO.	FREQ. (MHz)	EMISSION LEVEL (dBuV/m)	LIMIT (dBuV/m)	MARGIN (dB)	ANTENNA HEIGHT (m)	TABLE ANGLE (Degree)	RAW VALUE (dBuV)	CORRECTION FACTOR (dB/m)
1	#5470.00	65.9 PK	74.0	-8.1	3.37 V	174	63.6	2.3
2	#5470.00	51.9 AV	54.0	-2.1	3.37 V	174	49.6	2.3
3	*5510.00	110.4 PK			3.37 V	174	108.1	2.3
4	*5510.00	100.2 AV			3.37 V	174	97.9	2.3
5	11020.00	51.4 PK	74.0	-22.6	1.14 V	212	38.0	13.4
6	11020.00	39.9 AV	54.0	-14.1	1.14 V	212	26.5	13.4
7	#16530.00	55.6 PK	74.0	-18.4	1.95 V	128	39.8	15.8
8	#16530.00	43.6 AV	54.0	-10.4	1.95 V	128	27.8	15.8

**REMARKS:**

1. Emission Level(dBuV/m) = Raw Value(dBuV) + Correction Factor(dB/m)
2. Correction Factor(dB/m) = Antenna Factor(dB/m) + Cable Factor(dB) – Pre-Amplifier Factor(dB)
3. The other emission levels were very low against the limit.
4. Margin value = Emission Level – Limit value
5. " \* ": Fundamental frequency.
6. " # ": The radiated frequency is out of the restricted band.

<b>CHANNEL</b>	TX Channel 110	<b>DETECTOR FUNCTION</b>	Peak (PK)
<b>FREQUENCY RANGE</b>	1GHz ~ 40GHz		Average (AV)

**ANTENNA POLARITY & TEST DISTANCE: HORIZONTAL AT 3 M**

NO.	FREQ. (MHz)	EMISSION LEVEL (dBuV/m)	LIMIT (dBuV/m)	MARGIN (dB)	ANTENNA HEIGHT (m)	TABLE ANGLE (Degree)	RAW VALUE (dBuV)	CORRECTION FACTOR (dB/m)
1	*5550.00	109.4 PK			1.67 H	135	106.9	2.5
2	*5550.00	99.2 AV			1.67 H	135	96.7	2.5
3	11100.00	50.5 PK	74.0	-23.5	1.84 H	194	37.3	13.2
4	11100.00	39.2 AV	54.0	-14.8	1.84 H	194	26.0	13.2
5	#16650.00	55.4 PK	74.0	-18.6	1.19 H	197	39.2	16.2
6	#16650.00	43.6 AV	54.0	-10.4	1.19 H	197	27.4	16.2

**ANTENNA POLARITY & TEST DISTANCE: VERTICAL AT 3 M**

NO.	FREQ. (MHz)	EMISSION LEVEL (dBuV/m)	LIMIT (dBuV/m)	MARGIN (dB)	ANTENNA HEIGHT (m)	TABLE ANGLE (Degree)	RAW VALUE (dBuV)	CORRECTION FACTOR (dB/m)
1	*5550.00	111.2 PK			3.39 V	164	108.7	2.5
2	*5550.00	100.7 AV			3.39 V	164	98.2	2.5
3	11100.00	51.2 PK	74.0	-22.8	1.11 V	230	38.0	13.2
4	11100.00	39.8 AV	54.0	-14.2	1.11 V	230	26.6	13.2
5	#16650.00	55.9 PK	74.0	-18.1	1.92 V	119	39.7	16.2
6	#16650.00	43.7 AV	54.0	-10.3	1.92 V	119	27.5	16.2

**REMARKS:**

1. Emission Level(dBuV/m) = Raw Value(dBuV) + Correction Factor(dB/m)
2. Correction Factor(dB/m) = Antenna Factor(dB/m) + Cable Factor(dB) – Pre-Amplifier Factor(dB)
3. The other emission levels were very low against the limit.
4. Margin value = Emission Level – Limit value
5. " \* ": Fundamental frequency.
6. " # ": The radiated frequency is out of the restricted band.

<b>CHANNEL</b>	TX Channel 134	<b>DETECTOR FUNCTION</b>	Peak (PK)
<b>FREQUENCY RANGE</b>	1GHz ~ 40GHz		Average (AV)

**ANTENNA POLARITY & TEST DISTANCE: HORIZONTAL AT 3 M**

NO.	FREQ. (MHz)	EMISSION LEVEL (dBuV/m)	LIMIT (dBuV/m)	MARGIN (dB)	ANTENNA HEIGHT (m)	TABLE ANGLE (Degree)	RAW VALUE (dBuV)	CORRECTION FACTOR (dB/m)
1	*5670.00	108.5 PK			3.71 H	114	105.9	2.6
2	*5670.00	98.6 AV			3.71 H	114	96.0	2.6
3	#5725.00	59.8 PK	74.0	-14.2	3.71 H	114	57.0	2.8
4	#5725.00	44.5 AV	54.0	-9.5	3.71 H	114	41.7	2.8
5	11340.00	51.2 PK	74.0	-22.8	1.80 H	207	37.4	13.8
6	11340.00	39.9 AV	54.0	-14.1	1.80 H	207	26.1	13.8
7	#17010.00	55.4 PK	74.0	-18.6	1.27 H	199	37.6	17.8
8	#17010.00	43.7 AV	54.0	-10.3	1.27 H	199	25.9	17.8

**ANTENNA POLARITY & TEST DISTANCE: VERTICAL AT 3 M**

NO.	FREQ. (MHz)	EMISSION LEVEL (dBuV/m)	LIMIT (dBuV/m)	MARGIN (dB)	ANTENNA HEIGHT (m)	TABLE ANGLE (Degree)	RAW VALUE (dBuV)	CORRECTION FACTOR (dB/m)
1	*5670.00	109.8 PK			3.71 V	182	107.2	2.6
2	*5670.00	100.0 AV			3.71 V	182	97.4	2.6
3	#5725.00	60.5 PK	74.0	-13.5	3.71 V	182	57.7	2.8
4	#5725.00	45.3 AV	54.0	-8.7	3.71 V	182	42.5	2.8
5	11340.00	50.5 PK	74.0	-23.5	1.03 V	230	36.7	13.8
6	11340.00	39.3 AV	54.0	-14.7	1.03 V	230	25.5	13.8
7	#17010.00	55.8 PK	74.0	-18.2	1.97 V	123	38.0	17.8
8	#17010.00	43.6 AV	54.0	-10.4	1.97 V	123	25.8	17.8

**REMARKS:**

1. Emission Level(dBuV/m) = Raw Value(dBuV) + Correction Factor(dB/m)
2. Correction Factor(dB/m) = Antenna Factor(dB/m) + Cable Factor(dB) – Pre-Amplifier Factor(dB)
3. The other emission levels were very low against the limit.
4. Margin value = Emission Level – Limit value
5. " \* ": Fundamental frequency.
6. " # ": The radiated frequency is out of the restricted band.

<b>CHANNEL</b>	TX Channel 142	<b>DETECTOR FUNCTION</b>	Peak (PK)
<b>FREQUENCY RANGE</b>	1GHz ~ 40GHz		Average (AV)

**ANTENNA POLARITY & TEST DISTANCE: HORIZONTAL AT 3 M**

NO.	FREQ. (MHz)	EMISSION LEVEL (dBuV/m)	LIMIT (dBuV/m)	MARGIN (dB)	ANTENNA HEIGHT (m)	TABLE ANGLE (Degree)	RAW VALUE (dBuV)	CORRECTION FACTOR (dB/m)
1	#5470.00	54.9 PK	74.0	-19.1	1.64 H	131	52.6	2.3
2	#5470.00	40.8 AV	54.0	-13.2	1.64 H	131	38.5	2.3
3	*5710.00	107.8 PK			1.64 H	131	105.0	2.8
4	*5710.00	98.4 AV			1.64 H	131	95.6	2.8
5	#5850.00	54.6 PK	74.0	-19.4	1.64 H	131	51.6	3.0
6	#5850.00	40.3 AV	54.0	-13.7	1.64 H	131	37.3	3.0
7	11420.00	51.3 PK	74.0	-22.7	1.91 H	214	37.9	13.4
8	11420.00	40.1 AV	54.0	-13.9	1.91 H	214	26.7	13.4
9	#17130.00	55.0 PK	74.0	-19.0	1.18 H	202	36.9	18.1
10	#17130.00	43.2 AV	54.0	-10.8	1.18 H	202	25.1	18.1

**ANTENNA POLARITY & TEST DISTANCE: VERTICAL AT 3 M**

NO.	FREQ. (MHz)	EMISSION LEVEL (dBuV/m)	LIMIT (dBuV/m)	MARGIN (dB)	ANTENNA HEIGHT (m)	TABLE ANGLE (Degree)	RAW VALUE (dBuV)	CORRECTION FACTOR (dB/m)
1	#5470.00	54.1 PK	74.0	-19.9	3.71 V	182	51.8	2.3
2	#5470.00	40.3 AV	54.0	-13.7	3.71 V	182	38.0	2.3
3	*5710.00	109.2 PK			3.71 V	182	106.4	2.8
4	*5710.00	99.6 AV			3.71 V	182	96.8	2.8
5	#5850.00	54.7 PK	74.0	-19.3	3.71 V	182	51.7	3.0
6	#5850.00	40.7 AV	54.0	-13.3	3.71 V	182	37.7	3.0
7	11420.00	51.0 PK	74.0	-23.0	1.03 V	232	37.6	13.4
8	11420.00	39.3 AV	54.0	-14.7	1.03 V	232	25.9	13.4
9	#17130.00	55.6 PK	74.0	-18.4	2.01 V	107	37.5	18.1
10	#17130.00	43.6 AV	54.0	-10.4	2.01 V	107	25.5	18.1

**REMARKS:**

1. Emission Level(dBuV/m) = Raw Value(dBuV) + Correction Factor(dB/m)
2. Correction Factor(dB/m) = Antenna Factor(dB/m) + Cable Factor(dB) – Pre-Amplifier Factor(dB)
3. The other emission levels were very low against the limit.
4. Margin value = Emission Level – Limit value
5. " \* ": Fundamental frequency.
6. " # ": The radiated frequency is out of the restricted band.

**802.11ac (VHT80)**

<b>CHANNEL</b>	TX Channel 58	<b>DETECTOR FUNCTION</b>	Peak (PK)
<b>FREQUENCY RANGE</b>	1GHz ~ 40GHz		Average (AV)

**ANTENNA POLARITY & TEST DISTANCE: HORIZONTAL AT 3 M**

NO.	FREQ. (MHz)	EMISSION LEVEL (dBuV/m)	LIMIT (dBuV/m)	MARGIN (dB)	ANTENNA HEIGHT (m)	TABLE ANGLE (Degree)	RAW VALUE (dBuV)	CORRECTION FACTOR (dB/m)
1	5150.00	54.2 PK	74.0	-19.8	1.70 H	152	52.6	1.6
2	5150.00	40.3 AV	54.0	-13.7	1.70 H	152	38.7	1.6
3	*5290.00	108.1 PK			1.70 H	152	106.1	2.0
4	*5290.00	96.5 AV			1.70 H	152	94.5	2.0
5	5350.00	69.5 PK	74.0	-4.5	1.70 H	152	67.4	2.1
6	5350.00	52.1 AV	54.0	-1.9	1.70 H	152	50.0	2.1
7	#10580.00	51.1 PK	74.0	-22.9	1.86 H	211	38.4	12.7
8	#10580.00	40.1 AV	54.0	-13.9	1.86 H	211	27.4	12.7
9	15870.00	54.0 PK	74.0	-20.0	1.26 H	221	40.7	13.3
10	15870.00	42.7 AV	54.0	-11.3	1.26 H	221	29.4	13.3

**ANTENNA POLARITY & TEST DISTANCE: VERTICAL AT 3 M**

NO.	FREQ. (MHz)	EMISSION LEVEL (dBuV/m)	LIMIT (dBuV/m)	MARGIN (dB)	ANTENNA HEIGHT (m)	TABLE ANGLE (Degree)	RAW VALUE (dBuV)	CORRECTION FACTOR (dB/m)
1	5150.00	55.6 PK	74.0	-18.4	3.87 V	173	54.0	1.6
2	5150.00	42.0 AV	54.0	-12.0	3.87 V	173	40.4	1.6
3	*5290.00	109.3 PK			3.87 V	173	107.3	2.0
4	*5290.00	98.0 AV			3.87 V	173	96.0	2.0
5	5350.00	70.3 PK	74.0	-3.7	3.87 V	173	68.2	2.1
6	5350.00	53.2 AV	54.0	-0.8	3.87 V	173	51.1	2.1
7	#10580.00	51.2 PK	74.0	-22.8	1.05 V	231	38.5	12.7
8	#10580.00	39.9 AV	54.0	-14.1	1.05 V	231	27.2	12.7
9	15870.00	56.2 PK	74.0	-17.8	1.92 V	128	42.9	13.3
10	15870.00	43.9 AV	54.0	-10.1	1.92 V	128	30.6	13.3

**REMARKS:**

1. Emission Level(dBuV/m) = Raw Value(dBuV) + Correction Factor(dB/m)
2. Correction Factor(dB/m) = Antenna Factor(dB/m) + Cable Factor(dB) – Pre-Amplifier Factor(dB)
3. The other emission levels were very low against the limit.
4. Margin value = Emission Level – Limit value
5. " \* ": Fundamental frequency.
6. " # ": The radiated frequency is out of the restricted band.

<b>CHANNEL</b>	TX Channel 106	<b>DETECTOR FUNCTION</b>	Peak (PK)
<b>FREQUENCY RANGE</b>	1GHz ~ 40GHz		Average (AV)

**ANTENNA POLARITY & TEST DISTANCE: HORIZONTAL AT 3 M**

NO.	FREQ. (MHz)	EMISSION LEVEL (dBuV/m)	LIMIT (dBuV/m)	MARGIN (dB)	ANTENNA HEIGHT (m)	TABLE ANGLE (Degree)	RAW VALUE (dBuV)	CORRECTION FACTOR (dB/m)
1	#5470.00	65.4 PK	74.0	-8.6	1.71 H	130	63.1	2.3
2	#5470.00	51.3 AV	54.0	-2.7	1.71 H	130	49.0	2.3
3	*5530.00	108.3 PK			1.71 H	130	105.9	2.4
4	*5530.00	95.1 AV			1.71 H	130	92.7	2.4
5	#5725.00	51.7 PK	74.0	-22.3	1.71 H	130	48.9	2.8
6	#5725.00	39.4 AV	54.0	-14.6	1.71 H	130	36.6	2.8
7	11060.00	51.1 PK	74.0	-22.9	1.86 H	208	37.8	13.3
8	11060.00	39.8 AV	54.0	-14.2	1.86 H	208	26.5	13.3
9	#16590.00	54.2 PK	74.0	-19.8	1.23 H	197	37.9	16.3
10	#16590.00	42.8 AV	54.0	-11.2	1.23 H	197	26.5	16.3

**ANTENNA POLARITY & TEST DISTANCE: VERTICAL AT 3 M**

NO.	FREQ. (MHz)	EMISSION LEVEL (dBuV/m)	LIMIT (dBuV/m)	MARGIN (dB)	ANTENNA HEIGHT (m)	TABLE ANGLE (Degree)	RAW VALUE (dBuV)	CORRECTION FACTOR (dB/m)
1	#5470.00	67.2 PK	74.0	-6.8	3.89 V	186	64.9	2.3
2	#5470.00	53.1 AV	54.0	-0.9	3.89 V	186	50.8	2.3
3	*5530.00	109.6 PK			3.89 V	186	107.2	2.4
4	*5530.00	96.4 AV			3.89 V	186	94.0	2.4
5	#5725.00	51.1 PK	74.0	-22.9	3.89 V	186	48.3	2.8
6	#5725.00	39.0 AV	54.0	-15.0	3.89 V	186	36.2	2.8
7	11060.00	50.5 PK	74.0	-23.5	1.04 V	235	37.2	13.3
8	11060.00	39.3 AV	54.0	-14.7	1.04 V	235	26.0	13.3
9	#16590.00	55.6 PK	74.0	-18.4	1.90 V	137	39.3	16.3
10	#16590.00	43.6 AV	54.0	-10.4	1.90 V	137	27.3	16.3

**REMARKS:**

1. Emission Level(dBuV/m) = Raw Value(dBuV) + Correction Factor(dB/m)
2. Correction Factor(dB/m) = Antenna Factor(dB/m) + Cable Factor(dB) – Pre-Amplifier Factor(dB)
3. The other emission levels were very low against the limit.
4. Margin value = Emission Level – Limit value
5. " \* ": Fundamental frequency.
6. " # ": The radiated frequency is out of the restricted band.



<b>CHANNEL</b>	TX Channel 122	<b>DETECTOR FUNCTION</b>	Peak (PK)
<b>FREQUENCY RANGE</b>	1GHz ~ 40GHz		Average (AV)

**ANTENNA POLARITY & TEST DISTANCE: HORIZONTAL AT 3 M**

NO.	FREQ. (MHz)	EMISSION LEVEL (dBuV/m)	LIMIT (dBuV/m)	MARGIN (dB)	ANTENNA HEIGHT (m)	TABLE ANGLE (Degree)	RAW VALUE (dBuV)	CORRECTION FACTOR (dB/m)
1	*5610.00	109.1 PK			1.68 H	137	106.5	2.6
2	*5610.00	96.3 AV			1.68 H	137	93.7	2.6
3	#5725.00	63.1 PK	74.0	-10.9	1.68 H	137	60.3	2.8
4	#5725.00	48.6 AV	54.0	-5.4	1.68 H	137	45.8	2.8
5	11220.00	50.4 PK	74.0	-23.6	1.87 H	194	36.9	13.5
6	11220.00	39.3 AV	54.0	-14.7	1.87 H	194	25.8	13.5
7	#16830.00	54.5 PK	74.0	-19.5	1.23 H	206	37.4	17.1
8	#16830.00	42.9 AV	54.0	-11.1	1.23 H	206	25.8	17.1

**ANTENNA POLARITY & TEST DISTANCE: VERTICAL AT 3 M**

NO.	FREQ. (MHz)	EMISSION LEVEL (dBuV/m)	LIMIT (dBuV/m)	MARGIN (dB)	ANTENNA HEIGHT (m)	TABLE ANGLE (Degree)	RAW VALUE (dBuV)	CORRECTION FACTOR (dB/m)
1	*5610.00	110.6 PK			3.87 V	193	108.0	2.6
2	*5610.00	97.7 AV			3.87 V	193	95.1	2.6
3	#5725.00	64.6 PK	74.0	-9.4	3.87 V	193	61.8	2.8
4	#5725.00	50.0 AV	54.0	-4.0	3.87 V	193	47.2	2.8
5	11220.00	50.8 PK	74.0	-23.2	1.07 V	226	37.3	13.5
6	11220.00	39.2 AV	54.0	-14.8	1.07 V	226	25.7	13.5
7	#16830.00	55.4 PK	74.0	-18.6	1.99 V	122	38.3	17.1
8	#16830.00	43.5 AV	54.0	-10.5	1.99 V	122	26.4	17.1

**REMARKS:**

1. Emission Level(dBuV/m) = Raw Value(dBuV) + Correction Factor(dB/m)
2. Correction Factor(dB/m) = Antenna Factor(dB/m) + Cable Factor(dB) – Pre-Amplifier Factor(dB)
3. The other emission levels were very low against the limit.
4. Margin value = Emission Level – Limit value
5. " \* ": Fundamental frequency.
6. " # ": The radiated frequency is out of the restricted band.

<b>CHANNEL</b>	TX Channel 138	<b>DETECTOR FUNCTION</b>	Peak (PK)
<b>FREQUENCY RANGE</b>	1GHz ~ 40GHz		Average (AV)

**ANTENNA POLARITY & TEST DISTANCE: HORIZONTAL AT 3 M**

NO.	FREQ. (MHz)	EMISSION LEVEL (dBuV/m)	LIMIT (dBuV/m)	MARGIN (dB)	ANTENNA HEIGHT (m)	TABLE ANGLE (Degree)	RAW VALUE (dBuV)	CORRECTION FACTOR (dB/m)
1	#5470.00	53.3 PK	74.0	-20.7	1.69 H	144	51.0	2.3
2	#5470.00	39.3 AV	54.0	-14.7	1.69 H	144	37.0	2.3
3	*5690.00	109.8 PK			1.69 H	144	107.0	2.8
4	*5690.00	98.3 AV			1.69 H	144	95.5	2.8
5	#5850.00	57.5 PK	74.0	-16.5	1.69 H	144	54.5	3.0
6	#5850.00	43.1 AV	54.0	-10.9	1.69 H	144	40.1	3.0
7	11380.00	50.5 PK	74.0	-23.5	1.88 H	203	37.0	13.5
8	11380.00	39.2 AV	54.0	-14.8	1.88 H	203	25.7	13.5
9	#17070.00	54.9 PK	74.0	-19.1	1.19 H	214	37.0	17.9
10	#17070.00	43.2 AV	54.0	-10.8	1.19 H	214	25.3	17.9

**ANTENNA POLARITY & TEST DISTANCE: VERTICAL AT 3 M**

NO.	FREQ. (MHz)	EMISSION LEVEL (dBuV/m)	LIMIT (dBuV/m)	MARGIN (dB)	ANTENNA HEIGHT (m)	TABLE ANGLE (Degree)	RAW VALUE (dBuV)	CORRECTION FACTOR (dB/m)
1	#5470.00	54.2 PK	74.0	-19.8	3.88 V	186	51.9	2.3
2	#5470.00	40.2 AV	54.0	-13.8	3.88 V	186	37.9	2.3
3	*5690.00	111.6 PK			3.88 V	186	108.8	2.8
4	*5690.00	100.0 AV			3.88 V	186	97.2	2.8
5	#5850.00	58.8 PK	74.0	-15.2	3.88 V	186	55.8	3.0
6	#5850.00	44.6 AV	54.0	-9.4	3.88 V	186	41.6	3.0
7	11380.00	50.7 PK	74.0	-23.3	1.07 V	230	37.2	13.5
8	11380.00	39.5 AV	54.0	-14.5	1.07 V	230	26.0	13.5
9	#17070.00	56.1 PK	74.0	-17.9	1.98 V	131	38.2	17.9
10	#17070.00	44.0 AV	54.0	-10.0	1.98 V	131	26.1	17.9

**REMARKS:**

1. Emission Level(dBuV/m) = Raw Value(dBuV) + Correction Factor(dB/m)
2. Correction Factor(dB/m) = Antenna Factor(dB/m) + Cable Factor(dB) – Pre-Amplifier Factor(dB)
3. The other emission levels were very low against the limit.
4. Margin value = Emission Level – Limit value
5. " \* ": Fundamental frequency.
6. " # ": The radiated frequency is out of the restricted band.

**802.11ac (VHT80+80)**

<b>CHANNEL</b>	TX Channel 42+106	<b>DETECTOR FUNCTION</b>	Peak (PK)
<b>FREQUENCY RANGE</b>	1GHz ~ 40GHz		Average (AV)

**ANTENNA POLARITY & TEST DISTANCE: HORIZONTAL AT 3 M**

NO.	FREQ. (MHz)	EMISSION LEVEL (dBuV/m)	LIMIT (dBuV/m)	MARGIN (dB)	ANTENNA HEIGHT (m)	TABLE ANGLE (Degree)	RAW VALUE (dBuV)	CORRECTION FACTOR (dB/m)
1	5113.00	61.2 PK	74.0	-12.8	3.88 H	270	58.3	2.9
2	5113.00	47.6 AV	54.0	-6.4	3.88 H	270	44.7	2.9
3	*5210.00	112.2 PK			3.88 H	270	109.0	3.2
4	*5210.00	99.8 AV			3.88 H	270	96.6	3.2
5	5350.00	58.8 PK	74.0	-15.2	3.88 H	270	55.3	3.5
6	5350.00	45.8 AV	54.0	-8.2	3.88 H	270	42.3	3.5
7	#5470.00	70.1 PK	74.0	-3.9	2.35 H	315	66.4	3.7
8	#5470.00	53.5 AV	54.0	-0.5	2.35 H	315	49.8	3.7
9	*5530.00	115.3 PK			2.35 H	315	111.4	3.9
10	*5530.00	101.7 AV			2.35 H	315	97.8	3.9
11	#5815.00	61.8 PK	74.0	-12.2	2.35 H	315	57.6	4.2
12	#5815.00	46.7 AV	54.0	-7.3	2.35 H	315	42.5	4.2
13	#10420.00	52.1 PK	74.0	-21.9	1.67 H	120	38.3	13.8
14	#10420.00	40.6 AV	54.0	-13.4	1.67 H	120	26.8	13.8
15	11060.00	53.2 PK	74.0	-20.8	1.55 H	42	38.1	15.1
16	11060.00	41.3 AV	54.0	-12.7	1.55 H	42	26.2	15.1
17	15630.00	54.5 PK	74.0	-19.5	1.85 H	162	38.8	15.7
18	15630.00	42.4 AV	54.0	-11.6	1.85 H	162	26.7	15.7
19	#16590.00	56.7 PK	74.0	-17.3	1.48 H	92	39.0	17.7
20	#16590.00	44.2 AV	54.0	-9.8	1.48 H	92	26.5	17.7

**ANTENNA POLARITY & TEST DISTANCE: VERTICAL AT 3 M**

NO.	FREQ. (MHz)	EMISSION LEVEL (dBuV/m)	LIMIT (dBuV/m)	MARGIN (dB)	ANTENNA HEIGHT (m)	TABLE ANGLE (Degree)	RAW VALUE (dBuV)	CORRECTION FACTOR (dB/m)
1	5113.00	66.9 PK	74.0	-7.1	3.55 V	175	64.0	2.9
2	5113.00	53.5 AV	54.0	-0.5	3.55 V	175	50.6	2.9
3	*5210.00	113.6 PK			3.55 V	175	110.4	3.2
4	*5210.00	101.5 AV			3.55 V	175	98.3	3.2
5	5350.00	59.2 PK	74.0	-14.8	3.55 V	175	55.7	3.5
6	5350.00	46.0 AV	54.0	-8.0	3.55 V	175	42.5	3.5
7	#5470.00	61.9 PK	74.0	-12.1	3.52 V	168	58.2	3.7
8	#5470.00	48.5 AV	54.0	-5.5	3.52 V	168	44.8	3.7
9	*5530.00	108.6 PK			3.52 V	168	104.7	3.9
10	*5530.00	95.6 AV			3.52 V	168	91.7	3.9
11	#5815.00	56.9 PK	74.0	-17.1	3.52 V	168	52.7	4.2
12	#5815.00	43.7 AV	54.0	-10.3	3.52 V	168	39.5	4.2
13	#10420.00	52.6 PK	74.0	-21.4	1.25 V	208	38.8	13.8
14	#10420.00	40.9 AV	54.0	-13.1	1.25 V	208	27.1	13.8
15	11060.00	53.4 PK	74.0	-20.6	1.55 V	171	38.3	15.1
16	11060.00	41.4 AV	54.0	-12.6	1.55 V	171	26.3	15.1
17	15630.00	54.8 PK	74.0	-19.2	2.16 V	182	39.1	15.7
18	15630.00	42.6 AV	54.0	-11.4	2.16 V	182	26.9	15.7
19	#16590.00	57.0 PK	74.0	-17.0	1.75 V	216	39.3	17.7
20	#16590.00	44.3 AV	54.0	-9.7	1.75 V	216	26.6	17.7

**REMARKS:**

1. Emission Level(dBuV/m) = Raw Value(dBuV) + Correction Factor(dB/m)
2. Correction Factor(dB/m) = Antenna Factor(dB/m) + Cable Factor(dB) – Pre-Amplifier Factor(dB)
3. The other emission levels were very low against the limit.
4. Margin value = Emission Level – Limit value
5. " \* ": Fundamental frequency.
6. " # ": The radiated frequency is out of the restricted band.

<b>CHANNEL</b>	TX Channel 42+122	<b>DETECTOR FUNCTION</b>	Peak (PK)
<b>FREQUENCY RANGE</b>	1GHz ~ 40GHz		Average (AV)

**ANTENNA POLARITY & TEST DISTANCE: HORIZONTAL AT 3 M**

NO.	FREQ. (MHz)	EMISSION LEVEL (dBuV/m)	LIMIT (dBuV/m)	MARGIN (dB)	ANTENNA HEIGHT (m)	TABLE ANGLE (Degree)	RAW VALUE (dBuV)	CORRECTION FACTOR (dB/m)
1	5136.00	60.3 PK	74.0	-13.7	3.90 H	272	57.3	3.0
2	5136.00	46.8 AV	54.0	-7.2	3.90 H	272	43.8	3.0
3	*5210.00	112.8 PK			3.90 H	272	109.6	3.2
4	*5210.00	100.2 AV			3.90 H	272	97.0	3.2
5	5350.00	57.6 PK	74.0	-16.4	3.90 H	272	54.1	3.5
6	5350.00	44.2 AV	54.0	-9.8	3.90 H	272	40.7	3.5
7	*5610.00	114.2 PK			2.35 H	314	110.3	3.9
8	*5610.00	100.3 AV			2.35 H	314	96.4	3.9
9	#5725.00	57.2 PK	74.0	-16.8	2.35 H	314	53.0	4.2
10	#5725.00	44.2 AV	54.0	-9.8	2.35 H	314	40.0	4.2
11	#10420.00	52.4 PK	74.0	-21.6	1.66 H	117	38.6	13.8
12	#10420.00	40.6 AV	54.0	-13.4	1.66 H	117	26.8	13.8
13	11220.00	53.2 PK	74.0	-20.8	1.58 H	40	38.0	15.2
14	11220.00	41.2 AV	54.0	-12.8	1.58 H	40	26.0	15.2
15	15630.00	54.9 PK	74.0	-19.1	1.89 H	167	39.2	15.7
16	15630.00	42.8 AV	54.0	-11.2	1.89 H	167	27.1	15.7
17	#16830.00	55.6 PK	74.0	-18.4	1.48 H	100	37.1	18.5
18	#16830.00	44.4 AV	54.0	-9.6	1.48 H	100	25.9	18.5

**ANTENNA POLARITY & TEST DISTANCE: VERTICAL AT 3 M**

NO.	FREQ. (MHz)	EMISSION LEVEL (dBuV/m)	LIMIT (dBuV/m)	MARGIN (dB)	ANTENNA HEIGHT (m)	TABLE ANGLE (Degree)	RAW VALUE (dBuV)	CORRECTION FACTOR (dB/m)
1	5136.00	66.6 PK	74.0	-7.4	3.53 V	182	63.6	3.0
2	5136.00	53.3 AV	54.0	-0.7	3.53 V	182	50.3	3.0
3	*5210.00	113.1 PK			3.53 V	182	109.9	3.2
4	*5210.00	101.1 AV			3.53 V	182	97.9	3.2
5	5350.00	60.0 PK	74.0	-14.0	3.53 V	182	56.5	3.5
6	5350.00	46.2 AV	54.0	-7.8	3.53 V	182	42.7	3.5
7	*5610.00	108.1 PK			3.56 V	168	104.2	3.9
8	*5610.00	95.0 AV			3.56 V	168	91.1	3.9
9	#5725.00	54.2 PK	74.0	-19.8	3.56 V	168	50.0	4.2
10	#5725.00	41.6 AV	54.0	-12.4	3.56 V	168	37.4	4.2
11	#10420.00	52.5 PK	74.0	-21.5	1.30 V	208	38.7	13.8
12	#10420.00	41.4 AV	54.0	-12.6	1.30 V	208	27.6	13.8
13	11220.00	53.5 PK	74.0	-20.5	1.52 V	181	38.3	15.2
14	11220.00	41.3 AV	54.0	-12.7	1.52 V	181	26.1	15.2
15	15630.00	55.1 PK	74.0	-18.9	2.11 V	177	39.4	15.7
16	15630.00	42.8 AV	54.0	-11.2	2.11 V	177	27.1	15.7
17	#16830.00	57.4 PK	74.0	-16.6	1.78 V	203	38.9	18.5
18	#16830.00	44.5 AV	54.0	-9.5	1.78 V	203	26.0	18.5

**REMARKS:**

1. Emission Level(dBuV/m) = Raw Value(dBuV) + Correction Factor(dB/m)
2. Correction Factor(dB/m) = Antenna Factor(dB/m) + Cable Factor(dB) – Pre-Amplifier Factor(dB)
3. The other emission levels were very low against the limit.
4. Margin value = Emission Level – Limit value
5. " \* ": Fundamental frequency.
6. " # ": The radiated frequency is out of the restricted band.

<b>CHANNEL</b>	TX Channel 42+138	<b>DETECTOR FUNCTION</b>	Peak (PK)
<b>FREQUENCY RANGE</b>	1GHz ~ 40GHz		Average (AV)

**ANTENNA POLARITY & TEST DISTANCE: HORIZONTAL AT 3 M**

NO.	FREQ. (MHz)	EMISSION LEVEL (dBuV/m)	LIMIT (dBuV/m)	MARGIN (dB)	ANTENNA HEIGHT (m)	TABLE ANGLE (Degree)	RAW VALUE (dBuV)	CORRECTION FACTOR (dB/m)
1	5136.00	60.5 PK	74.0	-13.5	3.90 H	272	57.5	3.0
2	5136.00	47.0 AV	54.0	-7.0	3.90 H	272	44.0	3.0
3	*5210.00	113.0 PK			3.90 H	272	109.8	3.2
4	*5210.00	100.1 AV			3.90 H	272	96.9	3.2
5	5350.00	57.9 PK	74.0	-16.1	3.90 H	272	54.4	3.5
6	5350.00	44.2 AV	54.0	-9.8	3.90 H	272	40.7	3.5
7	#5470.00	56.6 PK	74.0	-17.4	3.61 H	63	52.9	3.7
8	#5470.00	43.6 AV	54.0	-10.4	3.61 H	63	39.9	3.7
9	*5690.00	113.9 PK			3.61 H	63	109.7	4.2
10	*5690.00	99.1 AV			3.61 H	63	94.9	4.2
11	#5850.00	55.3 PK	74.0	-18.7	3.61 H	63	51.1	4.2
12	#5850.00	42.3 AV	54.0	-11.7	3.61 H	63	38.1	4.2
13	#10420.00	52.8 PK	74.0	-21.2	1.61 H	122	39.0	13.8
14	#10420.00	41.1 AV	54.0	-12.9	1.61 H	122	27.3	13.8
15	11380.00	53.0 PK	74.0	-21.0	1.52 H	48	37.6	15.4
16	11380.00	41.0 AV	54.0	-13.0	1.52 H	48	25.6	15.4
17	15630.00	55.2 PK	74.0	-18.8	1.89 H	178	39.5	15.7
18	15630.00	43.1 AV	54.0	-10.9	1.89 H	178	27.4	15.7
19	#17070.00	57.6 PK	74.0	-16.4	1.49 H	81	37.6	20.0
20	#17070.00	45.0 AV	54.0	-9.0	1.49 H	81	25.0	20.0

**ANTENNA POLARITY & TEST DISTANCE: VERTICAL AT 3 M**

NO.	FREQ. (MHz)	EMISSION LEVEL (dBuV/m)	LIMIT (dBuV/m)	MARGIN (dB)	ANTENNA HEIGHT (m)	TABLE ANGLE (Degree)	RAW VALUE (dBuV)	CORRECTION FACTOR (dB/m)
1	5136.00	67.0 PK	74.0	-7.0	3.53 V	28	64.0	3.0
2	5136.00	53.5 AV	54.0	-0.5	3.53 V	28	50.5	3.0
3	*5210.00	113.6 PK			3.53 V	28	110.4	3.2
4	*5210.00	100.8 AV			3.53 V	28	97.6	3.2
5	5350.00	59.6 PK	74.0	-14.4	3.53 V	28	56.1	3.5
6	5350.00	45.8 AV	54.0	-8.2	3.53 V	28	42.3	3.5
7	#5470.00	56.0 PK	74.0	-18.0	3.93 V	20	52.3	3.7
8	#5470.00	43.2 AV	54.0	-10.8	3.93 V	20	39.5	3.7
9	*5690.00	108.9 PK			3.93 V	20	104.7	4.2
10	*5690.00	96.4 AV			3.93 V	20	92.2	4.2
11	#5850.00	53.3 PK	74.0	-20.7	3.93 V	20	49.1	4.2
12	#5850.00	40.3 AV	54.0	-13.7	3.93 V	20	36.1	4.2
13	#10420.00	52.3 PK	74.0	-21.7	1.32 V	222	38.5	13.8
14	#10420.00	41.4 AV	54.0	-12.6	1.32 V	222	27.6	13.8
15	11380.00	53.6 PK	74.0	-20.4	1.54 V	158	38.2	15.4
16	11380.00	41.4 AV	54.0	-12.6	1.54 V	158	26.0	15.4
17	15630.00	55.4 PK	74.0	-18.6	2.14 V	179	39.7	15.7
18	15630.00	43.2 AV	54.0	-10.8	2.14 V	179	27.5	15.7
19	#17070.00	56.7 PK	74.0	-17.3	1.76 V	222	36.7	20.0
20	#17070.00	44.0 AV	54.0	-10.0	1.76 V	222	24.0	20.0

**REMARKS:**

1. Emission Level(dBuV/m) = Raw Value(dBuV) + Correction Factor(dB/m)
2. Correction Factor(dB/m) = Antenna Factor(dB/m) + Cable Factor(dB) – Pre-Amplifier Factor(dB)
3. The other emission levels were very low against the limit.
4. Margin value = Emission Level – Limit value
5. " \* ": Fundamental frequency.
6. " # ": The radiated frequency is out of the restricted band.



<b>CHANNEL</b>	TX Channel 58+106	<b>DETECTOR FUNCTION</b>	Peak (PK)
<b>FREQUENCY RANGE</b>	1GHz ~ 40GHz		Average (AV)

**ANTENNA POLARITY & TEST DISTANCE: HORIZONTAL AT 3 M**

NO.	FREQ. (MHz)	EMISSION LEVEL (dBuV/m)	LIMIT (dBuV/m)	MARGIN (dB)	ANTENNA HEIGHT (m)	TABLE ANGLE (Degree)	RAW VALUE (dBuV)	CORRECTION FACTOR (dB/m)
1	5150.00	57.7 PK	74.0	-16.3	3.42 H	77	54.7	3.0
2	5150.00	44.4 AV	54.0	-9.6	3.42 H	77	41.4	3.0
3	*5290.00	113.3 PK			3.42 H	77	110.0	3.3
4	*5290.00	100.6 AV			3.42 H	77	97.3	3.3
5	5350.00	66.7 PK	74.0	-7.3	3.42 H	77	63.2	3.5
6	5350.00	52.5 AV	54.0	-1.5	3.42 H	77	49.0	3.5
7	#5470.00	68.4 PK	74.0	-5.6	2.37 H	323	64.7	3.7
8	#5470.00	53.5 AV	54.0	-0.5	2.37 H	323	49.8	3.7
9	*5530.00	113.2 PK			2.37 H	323	109.3	3.9
10	*5530.00	100.5 AV			2.37 H	323	96.6	3.9
11	#5725.00	58.5 PK	74.0	-15.5	2.37 H	323	54.3	4.2
12	#5725.00	44.7 AV	54.0	-9.3	2.37 H	323	40.5	4.2
13	#10580.00	52.5 PK	74.0	-21.5	1.69 H	118	38.2	14.3
14	#10580.00	41.3 AV	54.0	-12.7	1.69 H	118	27.0	14.3
15	11060.00	52.8 PK	74.0	-21.2	1.61 H	56	37.7	15.1
16	11060.00	41.0 AV	54.0	-13.0	1.61 H	56	25.9	15.1
17	15870.00	54.9 PK	74.0	-19.1	1.88 H	165	39.9	15.0
18	15870.00	42.5 AV	54.0	-11.5	1.88 H	165	27.5	15.0
19	#16590.00	56.4 PK	74.0	-17.6	1.51 H	92	38.7	17.7
20	#16590.00	43.8 AV	54.0	-10.2	1.51 H	92	26.1	17.7

**ANTENNA POLARITY & TEST DISTANCE: VERTICAL AT 3 M**

NO.	FREQ. (MHz)	EMISSION LEVEL (dBuV/m)	LIMIT (dBuV/m)	MARGIN (dB)	ANTENNA HEIGHT (m)	TABLE ANGLE (Degree)	RAW VALUE (dBuV)	CORRECTION FACTOR (dB/m)
1	5150.00	56.4 PK	74.0	-17.6	3.43 V	175	53.4	3.0
2	5150.00	43.8 AV	54.0	-10.2	3.43 V	175	40.8	3.0
3	*5290.00	113.6 PK			3.43 V	175	110.3	3.3
4	*5290.00	100.8 AV			3.43 V	175	97.5	3.3
5	5350.00	65.9 PK	74.0	-8.1	3.43 V	175	62.4	3.5
6	5350.00	52.6 AV	54.0	-1.4	3.43 V	175	49.1	3.5
7	#5470.00	62.4 PK	74.0	-11.6	3.96 V	177	58.7	3.7
8	#5470.00	49.5 AV	54.0	-4.5	3.96 V	177	45.8	3.7
9	*5530.00	109.2 PK			3.96 V	177	105.3	3.9
10	*5530.00	96.4 AV			3.96 V	177	92.5	3.9
11	#5725.00	58.1 PK	74.0	-15.9	3.96 V	177	53.9	4.2
12	#5725.00	43.9 AV	54.0	-10.1	3.96 V	177	39.7	4.2
13	#10580.00	52.3 PK	74.0	-21.7	1.28 V	196	38.0	14.3
14	#10580.00	41.1 AV	54.0	-12.9	1.28 V	196	26.8	14.3
15	11060.00	52.8 PK	74.0	-21.2	1.54 V	173	37.7	15.1
16	11060.00	41.0 AV	54.0	-13.0	1.54 V	173	25.9	15.1
17	15870.00	55.2 PK	74.0	-18.8	2.13 V	163	40.2	15.0
18	15870.00	42.9 AV	54.0	-11.1	2.13 V	163	27.9	15.0
19	#16590.00	57.5 PK	74.0	-16.5	1.81 V	215	39.8	17.7
20	#16590.00	44.8 AV	54.0	-9.2	1.81 V	215	27.1	17.7

**REMARKS:**

1. Emission Level(dBuV/m) = Raw Value(dBuV) + Correction Factor(dB/m)
2. Correction Factor(dB/m) = Antenna Factor(dB/m) + Cable Factor(dB) – Pre-Amplifier Factor(dB)
3. The other emission levels were very low against the limit.
4. Margin value = Emission Level – Limit value
5. " \* ": Fundamental frequency.
6. " # ": The radiated frequency is out of the restricted band.

<b>CHANNEL</b>	TX Channel 58+122	<b>DETECTOR FUNCTION</b>	Peak (PK)
<b>FREQUENCY RANGE</b>	1GHz ~ 40GHz		Average (AV)

**ANTENNA POLARITY & TEST DISTANCE: HORIZONTAL AT 3 M**

NO.	FREQ. (MHz)	EMISSION LEVEL (dBuV/m)	LIMIT (dBuV/m)	MARGIN (dB)	ANTENNA HEIGHT (m)	TABLE ANGLE (Degree)	RAW VALUE (dBuV)	CORRECTION FACTOR (dB/m)
1	5136.00	57.5 PK	74.0	-16.5	3.22 H	80	54.5	3.0
2	5136.00	44.2 AV	54.0	-9.8	3.22 H	80	41.2	3.0
3	*5290.00	113.3 PK			3.22 H	80	110.0	3.3
4	*5290.00	100.5 AV			3.22 H	80	97.2	3.3
5	5350.00	68.4 PK	74.0	-5.6	3.22 H	80	64.9	3.5
6	5350.00	53.5 AV	54.0	-0.5	3.22 H	80	50.0	3.5
7	*5610.00	113.0 PK			2.37 H	323	109.1	3.9
8	*5610.00	99.3 AV			2.37 H	323	95.4	3.9
9	#5725.00	57.9 PK	74.0	-16.1	2.37 H	323	53.7	4.2
10	#5725.00	43.7 AV	54.0	-10.3	2.37 H	323	39.5	4.2
11	#10580.00	52.6 PK	74.0	-21.4	1.69 H	121	38.3	14.3
12	#10580.00	41.1 AV	54.0	-12.9	1.69 H	121	26.8	14.3
13	11220.00	52.9 PK	74.0	-21.1	1.52 H	54	37.7	15.2
14	11220.00	41.0 AV	54.0	-13.0	1.52 H	54	25.8	15.2
15	15870.00	55.2 PK	74.0	-18.8	1.93 H	174	40.2	15.0
16	15870.00	43.0 AV	54.0	-11.0	1.93 H	174	28.0	15.0
17	#16830.00	56.7 PK	74.0	-17.3	1.42 H	108	38.2	18.5
18	#16830.00	44.4 AV	54.0	-9.6	1.42 H	108	25.9	18.5

**ANTENNA POLARITY & TEST DISTANCE: VERTICAL AT 3 M**

NO.	FREQ. (MHz)	EMISSION LEVEL (dBuV/m)	LIMIT (dBuV/m)	MARGIN (dB)	ANTENNA HEIGHT (m)	TABLE ANGLE (Degree)	RAW VALUE (dBuV)	CORRECTION FACTOR (dB/m)
1	5136.00	56.8 PK	74.0	-17.2	3.45 V	179	53.8	3.0
2	5136.00	43.3 AV	54.0	-10.7	3.45 V	179	40.3	3.0
3	*5290.00	113.4 PK			3.45 V	179	110.1	3.3
4	*5290.00	100.6 AV			3.45 V	179	97.3	3.3
5	5350.00	65.5 PK	74.0	-8.5	3.45 V	179	62.0	3.5
6	5350.00	52.9 AV	54.0	-1.1	3.45 V	179	49.4	3.5
7	*5610.00	108.4 PK			3.96 V	174	104.5	3.9
8	*5610.00	95.9 AV			3.96 V	174	92.0	3.9
9	#5725.00	55.2 PK	74.0	-18.8	3.96 V	174	51.0	4.2
10	#5725.00	42.5 AV	54.0	-11.5	3.96 V	174	38.3	4.2
11	#10580.00	52.3 PK	74.0	-21.7	1.33 V	206	38.0	14.3
12	#10580.00	40.9 AV	54.0	-13.1	1.33 V	206	26.6	14.3
13	11220.00	53.6 PK	74.0	-20.4	1.50 V	164	38.4	15.2
14	11220.00	41.6 AV	54.0	-12.4	1.50 V	164	26.4	15.2
15	15870.00	55.3 PK	74.0	-18.7	2.19 V	158	40.3	15.0
16	15870.00	42.7 AV	54.0	-11.3	2.19 V	158	27.7	15.0
17	#16830.00	57.8 PK	74.0	-16.2	1.86 V	216	39.3	18.5
18	#16830.00	45.5 AV	54.0	-8.5	1.86 V	216	27.0	18.5

**REMARKS:**

1. Emission Level(dBuV/m) = Raw Value(dBuV) + Correction Factor(dB/m)
2. Correction Factor(dB/m) = Antenna Factor(dB/m) + Cable Factor(dB) – Pre-Amplifier Factor(dB)
3. The other emission levels were very low against the limit.
4. Margin value = Emission Level – Limit value
5. " \* ": Fundamental frequency.
6. " # ": The radiated frequency is out of the restricted band.

<b>CHANNEL</b>	TX Channel 58+138	<b>DETECTOR FUNCTION</b>	Peak (PK)
<b>FREQUENCY RANGE</b>	1GHz ~ 40GHz		Average (AV)

**ANTENNA POLARITY & TEST DISTANCE: HORIZONTAL AT 3 M**

NO.	FREQ. (MHz)	EMISSION LEVEL (dBuV/m)	LIMIT (dBuV/m)	MARGIN (dB)	ANTENNA HEIGHT (m)	TABLE ANGLE (Degree)	RAW VALUE (dBuV)	CORRECTION FACTOR (dB/m)
1	5136.00	57.6 PK	74.0	-16.4	3.42 H	78	54.6	3.0
2	5136.00	44.1 AV	54.0	-9.9	3.42 H	78	41.1	3.0
3	*5290.00	112.9 PK			3.42 H	78	109.6	3.3
4	*5290.00	100.2 AV			3.42 H	78	96.9	3.3
5	5350.00	65.0 PK	74.0	-9.0	3.42 H	78	61.5	3.5
6	5350.00	51.9 AV	54.0	-2.1	3.42 H	78	48.4	3.5
7	5404.00	60.5 PK	74.0	-13.5	3.53 H	68	56.8	3.7
8	5404.00	46.6 AV	54.0	-7.4	3.53 H	68	42.9	3.7
9	*5690.00	113.1 PK			3.53 H	68	108.9	4.2
10	*5690.00	98.1 AV			3.53 H	68	93.9	4.2
11	#5850.00	55.8 PK	74.0	-18.2	3.53 H	68	51.6	4.2
12	#5850.00	42.1 AV	54.0	-11.9	3.53 H	68	37.9	4.2
13	#10580.00	52.2 PK	74.0	-21.8	1.65 H	120	37.9	14.3
14	#10580.00	40.5 AV	54.0	-13.5	1.65 H	120	26.2	14.3
15	11380.00	53.3 PK	74.0	-20.7	1.57 H	52	37.9	15.4
16	11380.00	41.3 AV	54.0	-12.7	1.57 H	52	25.9	15.4
17	15870.00	54.8 PK	74.0	-19.2	1.87 H	186	39.8	15.0
18	15870.00	42.6 AV	54.0	-11.4	1.87 H	186	27.6	15.0
19	#17070.00	56.9 PK	74.0	-17.1	1.42 H	81	36.9	20.0
20	#17070.00	44.3 AV	54.0	-9.7	1.42 H	81	24.3	20.0

**ANTENNA POLARITY & TEST DISTANCE: VERTICAL AT 3 M**

NO.	FREQ. (MHz)	EMISSION LEVEL (dBuV/m)	LIMIT (dBuV/m)	MARGIN (dB)	ANTENNA HEIGHT (m)	TABLE ANGLE (Degree)	RAW VALUE (dBuV)	CORRECTION FACTOR (dB/m)
1	5136.00	55.5 PK	74.0	-18.5	3.95 V	350	52.5	3.0
2	5136.00	43.5 AV	54.0	-10.5	3.95 V	350	40.5	3.0
3	*5290.00	113.0 PK			3.95 V	350	109.7	3.3
4	*5290.00	100.3 AV			3.95 V	350	97.0	3.3
5	5350.00	66.9 PK	74.0	-7.1	3.95 V	350	63.4	3.5
6	5350.00	53.5 AV	54.0	-0.5	3.95 V	350	50.0	3.5
7	5404.00	61.5 PK	74.0	-12.5	3.93 V	22	57.8	3.7
8	5404.00	48.6 AV	54.0	-5.4	3.93 V	22	44.9	3.7
9	*5690.00	111.1 PK			3.93 V	22	106.9	4.2
10	*5690.00	98.2 AV			3.93 V	22	94.0	4.2
11	#5850.00	55.5 PK	74.0	-18.5	3.93 V	22	51.3	4.2
12	#5850.00	42.0 AV	54.0	-12.0	3.93 V	22	37.8	4.2
13	#10580.00	51.9 PK	74.0	-22.1	1.23 V	197	37.6	14.3
14	#10580.00	40.7 AV	54.0	-13.3	1.23 V	197	26.4	14.3
15	11380.00	55.6 PK	74.0	-18.4	1.51 V	183	40.2	15.4
16	11380.00	42.0 AV	54.0	-12.0	1.51 V	183	26.6	15.4
17	15870.00	54.9 PK	74.0	-19.1	2.11 V	151	39.9	15.0
18	15870.00	42.6 AV	54.0	-11.4	2.11 V	151	27.6	15.0
19	#17070.00	58.7 PK	74.0	-15.3	1.80 V	222	38.7	20.0
20	#17070.00	46.6 AV	54.0	-7.4	1.80 V	222	26.6	20.0

**REMARKS:**

1. Emission Level(dBuV/m) = Raw Value(dBuV) + Correction Factor(dB/m)
2. Correction Factor(dB/m) = Antenna Factor(dB/m) + Cable Factor(dB) – Pre-Amplifier Factor(dB)
3. The other emission levels were very low against the limit.
4. Margin value = Emission Level – Limit value
5. " \* ": Fundamental frequency.
6. " # ": The radiated frequency is out of the restricted band.

<b>CHANNEL</b>	TX Channel 58+155	<b>DETECTOR FUNCTION</b>	Peak (PK)
<b>FREQUENCY RANGE</b>	1GHz ~ 40GHz		Average (AV)

**ANTENNA POLARITY & TEST DISTANCE: HORIZONTAL AT 3 M**

NO.	FREQ. (MHz)	EMISSION LEVEL (dBuV/m)	LIMIT (dBuV/m)	MARGIN (dB)	ANTENNA HEIGHT (m)	TABLE ANGLE (Degree)	RAW VALUE (dBuV)	CORRECTION FACTOR (dB/m)
1	5136.00	57.8 PK	74.0	-16.2	3.42 H	78	54.8	3.0
2	5136.00	44.6 AV	54.0	-9.4	3.42 H	78	41.6	3.0
3	*5290.00	112.2 PK			3.42 H	78	108.9	3.3
4	*5290.00	100.4 AV			3.42 H	78	97.1	3.3
5	5350.00	66.2 PK	74.0	-7.8	3.42 H	78	62.7	3.5
6	5350.00	52.6 AV	54.0	-1.4	3.42 H	78	49.1	3.5
7	#5583.25	53.7 PK	68.2	-14.5	1.50 H	228	49.8	3.9
8	*5775.00	114.6 PK			2.84 H	316	110.4	4.2
9	*5775.00	100.0 AV			2.84 H	316	95.8	4.2
10	#5982.73	52.6 PK	68.2	-15.6	1.50 H	228	48.1	4.5
11	#10580.00	52.5 PK	74.0	-21.5	1.70 H	103	38.2	14.3
12	#10580.00	41.1 AV	54.0	-12.9	1.70 H	103	26.8	14.3
13	11550.00	54.7 PK	74.0	-19.3	1.52 H	51	39.5	15.2
14	11550.00	41.4 AV	54.0	-12.6	1.52 H	51	26.2	15.2
15	15870.00	55.2 PK	74.0	-18.8	1.94 H	167	40.2	15.0
16	15870.00	43.2 AV	54.0	-10.8	1.94 H	167	28.2	15.0
17	#17325.00	57.7 PK	74.0	-16.3	1.43 H	90	37.4	20.3
18	#17325.00	45.6 AV	54.0	-8.4	1.43 H	90	25.3	20.3

**ANTENNA POLARITY & TEST DISTANCE: VERTICAL AT 3 M**

NO.	FREQ. (MHz)	EMISSION LEVEL (dBuV/m)	LIMIT (dBuV/m)	MARGIN (dB)	ANTENNA HEIGHT (m)	TABLE ANGLE (Degree)	RAW VALUE (dBuV)	CORRECTION FACTOR (dB/m)
1	5136.00	56.6 PK	74.0	-17.4	3.47 V	178	53.6	3.0
2	5136.00	43.4 AV	54.0	-10.6	3.47 V	178	40.4	3.0
3	*5290.00	112.3 PK			3.47 V	178	109.0	3.3
4	*5290.00	100.5 AV			3.47 V	178	97.2	3.3
5	5350.00	66.2 PK	74.0	-7.8	3.47 V	24	62.7	3.5
6	5350.00	53.0 AV	54.0	-1.0	3.47 V	24	49.5	3.5
7	#5646.90	57.2 PK	68.2	-11.0	3.91 V	186	53.2	4.0
8	*5775.00	109.0 PK			3.91 V	186	104.8	4.2
9	*5775.00	95.9 AV			3.91 V	186	91.7	4.2
10	#5979.40	53.7 PK	68.2	-14.5	3.91 V	186	49.2	4.5
11	#10580.00	51.9 PK	74.0	-22.1	1.31 V	204	37.6	14.3
12	#10580.00	41.0 AV	54.0	-13.0	1.31 V	204	26.7	14.3
13	11550.00	55.8 PK	74.0	-18.2	1.54 V	170	40.6	15.2
14	11550.00	42.2 AV	54.0	-11.8	1.54 V	170	27.0	15.2
15	15870.00	55.4 PK	74.0	-18.6	2.12 V	153	40.4	15.0
16	15870.00	43.3 AV	54.0	-10.7	2.12 V	153	28.3	15.0
17	#17325.00	58.8 PK	74.0	-15.2	1.79 V	229	38.5	20.3
18	#17325.00	46.6 AV	54.0	-7.4	1.79 V	229	26.3	20.3

**REMARKS:**

1. Emission Level(dBuV/m) = Raw Value(dBuV) + Correction Factor(dB/m)
2. Correction Factor(dB/m) = Antenna Factor(dB/m) + Cable Factor(dB) – Pre-Amplifier Factor(dB)
3. The other emission levels were very low against the limit.
4. Margin value = Emission Level – Limit value
5. " \* ": Fundamental frequency.
6. " # ": The radiated frequency is out of the restricted band.



<b>CHANNEL</b>	TX Channel 106+138	<b>DETECTOR FUNCTION</b>	Peak (PK)
<b>FREQUENCY RANGE</b>	1GHz ~ 40GHz		Average (AV)

**ANTENNA POLARITY & TEST DISTANCE: HORIZONTAL AT 3 M**

NO.	FREQ. (MHz)	EMISSION LEVEL (dBuV/m)	LIMIT (dBuV/m)	MARGIN (dB)	ANTENNA HEIGHT (m)	TABLE ANGLE (Degree)	RAW VALUE (dBuV)	CORRECTION FACTOR (dB/m)
1	#5470.00	58.7 PK	74.0	-15.3	3.26 H	76	55.0	3.7
2	#5470.00	46.5 AV	54.0	-7.5	3.26 H	76	42.8	3.7
3	*5530.00	109.7 PK			3.26 H	76	105.8	3.9
4	*5530.00	97.3 AV			3.26 H	76	93.4	3.9
5	*5690.00	109.1 PK			2.84 H	319	104.9	4.2
6	*5690.00	96.7 AV			2.84 H	319	92.5	4.2
7	#5850.00	57.5 PK	74.0	-16.5	2.84 H	319	53.3	4.2
8	#5850.00	42.8 AV	54.0	-11.2	2.84 H	319	38.6	4.2
9	11060.00	52.9 PK	74.0	-21.1	1.67 H	114	37.8	15.1
10	11060.00	41.6 AV	54.0	-12.4	1.67 H	114	26.5	15.1
11	11380.00	60.1 PK	74.0	-13.9	3.57 H	74	44.7	15.4
12	11380.00	46.3 AV	54.0	-7.7	3.57 H	74	30.9	15.4
13	#16590.00	54.5 PK	74.0	-19.5	1.90 H	160	36.8	17.7
14	#16590.00	42.4 AV	54.0	-11.6	1.90 H	160	24.7	17.7
15	#17070.00	55.3 PK	74.0	-18.7	3.55 H	64	35.3	20.0
16	#17070.00	41.9 AV	54.0	-12.1	3.55 H	64	21.9	20.0

**ANTENNA POLARITY & TEST DISTANCE: VERTICAL AT 3 M**

NO.	FREQ. (MHz)	EMISSION LEVEL (dBuV/m)	LIMIT (dBuV/m)	MARGIN (dB)	ANTENNA HEIGHT (m)	TABLE ANGLE (Degree)	RAW VALUE (dBuV)	CORRECTION FACTOR (dB/m)
1	#5470.00	60.3 PK	74.0	-13.7	3.45 V	0	56.6	3.7
2	#5470.00	48.0 AV	54.0	-6.0	3.45 V	0	44.3	3.7
3	*5530.00	111.6 PK			3.45 V	0	107.7	3.9
4	*5530.00	98.3 AV			3.45 V	0	94.4	3.9
5	*5690.00	107.5 PK			3.99 V	14	103.3	4.2
6	*5690.00	93.7 AV			3.99 V	14	89.5	4.2
7	#5850.00	57.4 PK	74.0	-16.6	3.95 V	8	53.2	4.2
8	#5850.00	42.9 AV	54.0	-11.1	3.95 V	8	38.7	4.2
9	11060.00	53.9 PK	74.0	-20.1	1.26 V	223	38.8	15.1
10	11060.00	41.9 AV	54.0	-12.1	1.26 V	223	26.8	15.1
11	11380.00	56.0 PK	74.0	-18.0	1.56 V	174	40.6	15.4
12	11380.00	42.4 AV	54.0	-11.6	1.56 V	174	27.0	15.4
13	#16590.00	57.3 PK	74.0	-16.7	2.23 V	147	39.6	17.7
14	#16590.00	44.6 AV	54.0	-9.4	2.23 V	147	26.9	17.7
15	#17070.00	59.3 PK	74.0	-14.7	1.71 V	228	39.3	20.0
16	#17070.00	46.8 AV	54.0	-7.2	1.71 V	228	26.8	20.0

**REMARKS:**

1. Emission Level(dBuV/m) = Raw Value(dBuV) + Correction Factor(dB/m)
2. Correction Factor(dB/m) = Antenna Factor(dB/m) + Cable Factor(dB) – Pre-Amplifier Factor(dB)
3. The other emission levels were very low against the limit.
4. Margin value = Emission Level – Limit value
5. " \* ": Fundamental frequency.
6. " # ": The radiated frequency is out of the restricted band.

<b>CHANNEL</b>	TX Channel 106+155	<b>DETECTOR FUNCTION</b>	Peak (PK)
<b>FREQUENCY RANGE</b>	1GHz ~ 40GHz		Average (AV)

**ANTENNA POLARITY & TEST DISTANCE: HORIZONTAL AT 3 M**

NO.	FREQ. (MHz)	EMISSION LEVEL (dBuV/m)	LIMIT (dBuV/m)	MARGIN (dB)	ANTENNA HEIGHT (m)	TABLE ANGLE (Degree)	RAW VALUE (dBuV)	CORRECTION FACTOR (dB/m)
1	#5470.00	65.4 PK	74.0	-8.6	3.42 H	71	61.7	3.7
2	#5470.00	53.1 AV	54.0	-0.9	3.42 H	71	49.4	3.7
3	*5530.00	113.7 PK			3.42 H	71	109.8	3.9
4	*5530.00	101.4 AV			3.42 H	71	97.5	3.9
5	*5775.00	114.3 PK			2.84 H	316	110.1	4.2
6	*5775.00	99.3 AV			2.84 H	316	95.1	4.2
7	#5994.12	56.1 PK	68.2	-12.1	1.50 H	227	51.6	4.5
8	11060.00	53.1 PK	74.0	-20.9	1.66 H	120	38.0	15.1
9	11060.00	41.8 AV	54.0	-12.2	1.66 H	120	26.7	15.1
10	11550.00	54.1 PK	74.0	-19.9	1.51 H	51	38.9	15.2
11	11550.00	41.0 AV	54.0	-13.0	1.51 H	51	25.8	15.2
12	#16590.00	54.9 PK	74.0	-19.1	1.91 H	166	37.2	17.7
13	#16590.00	42.5 AV	54.0	-11.5	1.91 H	166	24.8	17.7
14	#17325.00	58.8 PK	74.0	-15.2	1.50 H	78	38.5	20.3
15	#17325.00	46.4 AV	54.0	-7.6	1.50 H	78	26.1	20.3

**ANTENNA POLARITY & TEST DISTANCE: VERTICAL AT 3 M**

NO.	FREQ. (MHz)	EMISSION LEVEL (dBuV/m)	LIMIT (dBuV/m)	MARGIN (dB)	ANTENNA HEIGHT (m)	TABLE ANGLE (Degree)	RAW VALUE (dBuV)	CORRECTION FACTOR (dB/m)
1	#5470.00	63.3 PK	74.0	-10.7	3.14 V	178	59.6	3.7
2	#5470.00	50.6 AV	54.0	-3.4	3.14 V	178	46.9	3.7
3	*5530.00	113.8 PK			3.14 V	178	109.9	3.9
4	*5530.00	101.7 AV			3.14 V	178	97.8	3.9
5	*5775.00	108.8 PK			3.91 V	188	104.6	4.2
6	*5775.00	96.3 AV			3.91 V	188	92.1	4.2
7	#6020.73	58.3 PK	68.2	-9.9	3.91 V	188	53.7	4.6
8	11060.00	53.6 PK	74.0	-20.4	1.31 V	229	38.5	15.1
9	11060.00	41.9 AV	54.0	-12.1	1.31 V	229	26.8	15.1
10	11550.00	55.9 PK	74.0	-18.1	1.50 V	159	40.7	15.2
11	11550.00	42.5 AV	54.0	-11.5	1.50 V	159	27.3	15.2
12	#16590.00	56.9 PK	74.0	-17.1	2.21 V	159	39.2	17.7
13	#16590.00	44.3 AV	54.0	-9.7	2.21 V	159	26.6	17.7
14	#17325.00	58.7 PK	74.0	-15.3	1.75 V	239	38.4	20.3
15	#17325.00	46.2 AV	54.0	-7.8	1.75 V	239	25.9	20.3

**REMARKS:**

1. Emission Level(dBuV/m) = Raw Value(dBuV) + Correction Factor(dB/m)
2. Correction Factor(dB/m) = Antenna Factor(dB/m) + Cable Factor(dB) – Pre-Amplifier Factor(dB)
3. The other emission levels were very low against the limit.
4. Margin value = Emission Level – Limit value
5. " \* ": Fundamental frequency.
6. " # ": The radiated frequency is out of the restricted band.

<b>CHANNEL</b>	TX Channel 122+155	<b>DETECTOR FUNCTION</b>	Peak (PK)
<b>FREQUENCY RANGE</b>	1GHz ~ 40GHz		Average (AV)

**ANTENNA POLARITY & TEST DISTANCE: HORIZONTAL AT 3 M**

NO.	FREQ. (MHz)	EMISSION LEVEL (dBuV/m)	LIMIT (dBuV/m)	MARGIN (dB)	ANTENNA HEIGHT (m)	TABLE ANGLE (Degree)	RAW VALUE (dBuV)	CORRECTION FACTOR (dB/m)
1	*5610.00	113.2 PK			3.16 H	61	109.3	3.9
2	*5610.00	100.5 AV			3.16 H	61	96.6	3.9
3	*5775.00	114.5 PK			2.84 H	321	110.3	4.2
4	*5775.00	100.8 AV			2.84 H	321	96.6	4.2
5	#5994.60	58.2 PK	68.2	-10.0	2.84 H	321	53.7	4.5
6	11220.00	52.4 PK	74.0	-21.6	1.71 H	130	37.2	15.2
7	11220.00	40.9 AV	54.0	-13.1	1.71 H	130	25.7	15.2
8	11550.00	54.8 PK	74.0	-19.2	1.60 H	39	39.6	15.2
9	11550.00	41.6 AV	54.0	-12.4	1.60 H	39	26.4	15.2
10	#16830.00	55.5 PK	74.0	-18.5	1.87 H	181	37.0	18.5
11	#16830.00	43.4 AV	54.0	-10.6	1.87 H	181	24.9	18.5
12	#17325.00	57.8 PK	74.0	-16.2	1.46 H	96	37.5	20.3
13	#17325.00	45.9 AV	54.0	-8.1	1.46 H	96	25.6	20.3

**ANTENNA POLARITY & TEST DISTANCE: VERTICAL AT 3 M**

NO.	FREQ. (MHz)	EMISSION LEVEL (dBuV/m)	LIMIT (dBuV/m)	MARGIN (dB)	ANTENNA HEIGHT (m)	TABLE ANGLE (Degree)	RAW VALUE (dBuV)	CORRECTION FACTOR (dB/m)
1	*5610.00	113.6 PK			3.20 V	171	109.7	3.9
2	*5610.00	100.8 AV			3.20 V	171	96.9	3.9
3	*5775.00	108.9 PK			3.96 V	182	104.7	4.2
4	*5775.00	96.3 AV			3.96 V	182	92.1	4.2
5	#5968.95	58.0 PK	68.2	-10.2	3.96 V	182	53.5	4.5
6	11220.00	53.9 PK	74.0	-20.1	1.52 V	173	38.7	15.2
7	11220.00	42.1 AV	54.0	-11.9	1.52 V	173	26.9	15.2
8	11550.00	55.6 PK	74.0	-18.4	1.57 V	165	40.4	15.2
9	11550.00	42.3 AV	54.0	-11.7	1.57 V	165	27.1	15.2
10	#16830.00	57.9 PK	74.0	-16.1	1.91 V	216	39.4	18.5
11	#16830.00	45.5 AV	54.0	-8.5	1.91 V	216	27.0	18.5
12	#17325.00	58.9 PK	74.0	-15.1	1.74 V	225	38.6	20.3
13	#17325.00	46.6 AV	54.0	-7.4	1.74 V	225	26.3	20.3

**REMARKS:**

- Emission Level(dBuV/m) = Raw Value(dBuV) + Correction Factor(dB/m)
- Correction Factor(dB/m) = Antenna Factor(dB/m) + Cable Factor(dB) – Pre-Amplifier Factor(dB)
- The other emission levels were very low against the limit.
- Margin value = Emission Level – Limit value
- " \* ": Fundamental frequency.
- " # ": The radiated frequency is out of the restricted band.

<b>CHANNEL</b>	TX Channel 138+155	<b>DETECTOR FUNCTION</b>	Peak (PK)
<b>FREQUENCY RANGE</b>	1GHz ~ 40GHz		Average (AV)

**ANTENNA POLARITY & TEST DISTANCE: HORIZONTAL AT 3 M**

NO.	FREQ. (MHz)	EMISSION LEVEL (dBuV/m)	LIMIT (dBuV/m)	MARGIN (dB)	ANTENNA HEIGHT (m)	TABLE ANGLE (Degree)	RAW VALUE (dBuV)	CORRECTION FACTOR (dB/m)
1	*5690.00	114.3 PK			3.26 H	70	110.1	4.2
2	*5690.00	101.6 AV			3.26 H	70	97.4	4.2
3	*5775.00	114.4 PK			2.84 H	321	110.2	4.2
4	*5775.00	100.6 AV			2.84 H	321	96.4	4.2
5	#5850.00	61.8 PK	74.0	-12.2	3.26 H	70	57.6	4.2
6	#5850.00	48.2 AV	54.0	-5.8	3.26 H	70	44.0	4.2
7	#5938.55	56.4 PK	68.2	-11.8	2.84 H	321	52.0	4.4
8	11380.00	60.7 PK	74.0	-13.3	3.58 H	81	45.3	15.4
9	11380.00	46.6 AV	54.0	-7.4	3.58 H	81	31.2	15.4
10	11550.00	53.8 PK	74.0	-20.2	1.65 H	49	38.6	15.2
11	11550.00	41.0 AV	54.0	-13.0	1.65 H	49	25.8	15.2
12	#17070.00	56.2 PK	74.0	-17.8	3.55 H	56	36.2	20.0
13	#17070.00	42.5 AV	54.0	-11.5	3.55 H	56	22.5	20.0
14	#17325.00	58.5 PK	74.0	-15.5	1.44 H	88	38.2	20.3
15	#17325.00	46.3 AV	54.0	-7.7	1.44 H	88	26.0	20.3

**ANTENNA POLARITY & TEST DISTANCE: VERTICAL AT 3 M**

NO.	FREQ. (MHz)	EMISSION LEVEL (dBuV/m)	LIMIT (dBuV/m)	MARGIN (dB)	ANTENNA HEIGHT (m)	TABLE ANGLE (Degree)	RAW VALUE (dBuV)	CORRECTION FACTOR (dB/m)
1	*5690.00	114.6 PK			3.23 V	357	110.4	4.2
2	*5690.00	102.1 AV			3.23 V	357	97.9	4.2
3	*5775.00	110.2 PK			3.78 V	11	106.0	4.2
4	*5775.00	96.4 AV			3.78 V	11	92.2	4.2
5	#5850.00	62.2 PK	74.0	-11.8	3.23 V	357	58.0	4.2
6	#5850.00	48.4 AV	54.0	-5.6	3.23 V	357	44.2	4.2
7	#5962.30	55.8 PK	68.2	-12.4	3.23 V	357	51.3	4.5
8	11380.00	56.2 PK	74.0	-17.8	1.46 V	156	40.8	15.4
9	11380.00	42.3 AV	54.0	-11.7	1.46 V	156	26.9	15.4
10	11550.00	55.9 PK	74.0	-18.1	1.56 V	171	40.7	15.2
11	11550.00	42.2 AV	54.0	-11.8	1.56 V	171	27.0	15.2
12	#17070.00	58.9 PK	74.0	-15.1	1.91 V	211	38.9	20.0
13	#17070.00	47.1 AV	54.0	-6.9	1.91 V	211	27.1	20.0
14	#17325.00	59.0 PK	74.0	-15.0	1.81 V	244	38.7	20.3
15	#17325.00	46.7 AV	54.0	-7.3	1.81 V	244	26.4	20.3

**REMARKS:**

1. Emission Level(dBuV/m) = Raw Value(dBuV) + Correction Factor(dB/m)
2. Correction Factor(dB/m) = Antenna Factor(dB/m) + Cable Factor(dB) – Pre-Amplifier Factor(dB)
3. The other emission levels were very low against the limit.
4. Margin value = Emission Level – Limit value
5. " \* ": Fundamental frequency.
6. " # ": The radiated frequency is out of the restricted band.

<b>CHANNEL</b>	TX Channel 42+58	<b>DETECTOR FUNCTION</b>	Peak (PK)
<b>FREQUENCY RANGE</b>	1GHz ~ 40GHz		Average (AV)

ANTENNA POLARITY & TEST DISTANCE: HORIZONTAL AT 3 M								
NO.	FREQ. (MHz)	EMISSION LEVEL (dBuV/m)	LIMIT (dBuV/m)	MARGIN (dB)	ANTENNA HEIGHT (m)	TABLE ANGLE (Degree)	RAW VALUE (dBuV)	CORRECTION FACTOR (dB/m)
1	5136.00	62.5 PK	74.0	-11.5	3.65 H	287	59.5	3.0
2	5136.00	49.5 AV	54.0	-4.5	3.65 H	287	46.5	3.0
3	*5210.00	113.3 PK			3.65 H	287	110.1	3.2
4	*5210.00	101.5 AV			3.65 H	287	98.3	3.2
5	*5290.00	114.3 PK			2.84 H	305	111.0	3.3
6	*5290.00	100.7 AV			2.84 H	305	97.4	3.3
7	5350.00	63.8 PK	74.0	-10.2	2.84 H	305	60.3	3.5
8	5350.00	50.9 AV	54.0	-3.1	2.84 H	305	47.4	3.5
9	#10420.00	53.5 PK	74.0	-20.5	1.66 H	32	39.7	13.8
10	#10420.00	41.4 AV	54.0	-12.6	1.66 H	32	27.6	13.8
11	#10580.00	54.1 PK	74.0	-19.9	1.64 H	39	39.8	14.3
12	#10580.00	41.0 AV	54.0	-13.0	1.64 H	39	26.7	14.3
13	15630.00	56.9 PK	74.0	-17.1	1.49 H	99	41.2	15.7
14	15630.00	44.0 AV	54.0	-10.0	1.49 H	99	28.3	15.7
15	15870.00	58.3 PK	74.0	-15.7	1.38 H	104	43.3	15.0
16	15870.00	46.4 AV	54.0	-7.6	1.38 H	104	31.4	15.0

ANTENNA POLARITY & TEST DISTANCE: VERTICAL AT 3 M								
NO.	FREQ. (MHz)	EMISSION LEVEL (dBuV/m)	LIMIT (dBuV/m)	MARGIN (dB)	ANTENNA HEIGHT (m)	TABLE ANGLE (Degree)	RAW VALUE (dBuV)	CORRECTION FACTOR (dB/m)
1	5136.00	66.6 PK	74.0	-7.4	3.73 V	358	63.6	3.0
2	5136.00	53.3 AV	54.0	-0.7	3.73 V	358	50.3	3.0
3	*5210.00	115.7 PK			3.73 V	358	112.5	3.2
4	*5210.00	102.5 AV			3.73 V	358	99.3	3.2
5	*5290.00	113.2 PK			3.94 V	360	109.9	3.3
6	*5290.00	100.6 AV			3.94 V	360	97.3	3.3
7	5350.00	69.2 PK	74.0	-4.8	3.94 V	360	65.7	3.5
8	5350.00	53.6 AV	54.0	-0.4	3.94 V	360	50.1	3.5
9	#10420.00	52.8 PK	74.0	-21.2	1.33 V	216	39.0	13.8
10	#10420.00	41.7 AV	54.0	-12.3	1.33 V	216	27.9	13.8
11	#10580.00	52.4 PK	74.0	-21.6	1.26 V	205	38.1	14.3
12	#10580.00	41.1 AV	54.0	-12.9	1.26 V	205	26.8	14.3
13	15630.00	54.5 PK	74.0	-19.5	2.13 V	187	38.8	15.7
14	15630.00	42.5 AV	54.0	-11.5	2.13 V	187	26.8	15.7
15	15870.00	54.8 PK	74.0	-19.2	2.07 V	156	39.8	15.0
16	15870.00	42.5 AV	54.0	-11.5	2.07 V	156	27.5	15.0

**REMARKS:**

- Emission Level(dBuV/m) = Raw Value(dBuV) + Correction Factor(dB/m)
- Correction Factor(dB/m) = Antenna Factor(dB/m) + Cable Factor(dB) – Pre-Amplifier Factor(dB)
- The other emission levels were very low against the limit.
- Margin value = Emission Level – Limit value
- " \* ": Fundamental frequency.
- " # ": The radiated frequency is out of the restricted band.

<b>CHANNEL</b>	TX Channel 106+122	<b>DETECTOR FUNCTION</b>	Peak (PK)
<b>FREQUENCY RANGE</b>	1GHz ~ 40GHz		Average (AV)

**ANTENNA POLARITY & TEST DISTANCE: HORIZONTAL AT 3 M**

NO.	FREQ. (MHz)	EMISSION LEVEL (dBuV/m)	LIMIT (dBuV/m)	MARGIN (dB)	ANTENNA HEIGHT (m)	TABLE ANGLE (Degree)	RAW VALUE (dBuV)	CORRECTION FACTOR (dB/m)
1	#5470.00	62.8 PK	74.0	-11.2	3.50 H	301	59.1	3.7
2	#5470.00	49.6 AV	54.0	-4.4	3.50 H	301	45.9	3.7
3	*5530.00	109.6 PK			3.21 H	68	105.7	3.9
4	*5530.00	97.2 AV			3.21 H	68	93.3	3.9
5	*5610.00	109.1 PK			2.86 H	319	105.2	3.9
6	*5610.00	96.7 AV			2.86 H	319	92.8	3.9
7	#5725.00	53.1 PK	74.0	-20.9	2.86 H	319	48.9	4.2
8	#5725.00	40.3 AV	54.0	-13.7	2.86 H	319	36.1	4.2
9	11060.00	52.8 PK	74.0	-21.2	1.66 H	118	37.7	15.1
10	11060.00	41.7 AV	54.0	-12.3	1.66 H	118	26.6	15.1
11	11220.00	52.5 PK	74.0	-21.5	1.53 H	44	37.3	15.2
12	11220.00	40.7 AV	54.0	-13.3	1.53 H	44	25.5	15.2
13	#16590.00	54.9 PK	74.0	-19.1	1.90 H	146	37.2	17.7
14	#16590.00	42.6 AV	54.0	-11.4	1.90 H	146	24.9	17.7
15	#16830.00	56.7 PK	74.0	-17.3	1.46 H	93	38.2	18.5
16	#16830.00	44.4 AV	54.0	-9.6	1.46 H	93	25.9	18.5

**ANTENNA POLARITY & TEST DISTANCE: VERTICAL AT 3 M**

NO.	FREQ. (MHz)	EMISSION LEVEL (dBuV/m)	LIMIT (dBuV/m)	MARGIN (dB)	ANTENNA HEIGHT (m)	TABLE ANGLE (Degree)	RAW VALUE (dBuV)	CORRECTION FACTOR (dB/m)
1	#5470.00	60.4 PK	74.0	-13.6	3.41 V	6	56.7	3.7
2	#5470.00	48.2 AV	54.0	-5.8	3.41 V	6	44.5	3.7
3	*5530.00	111.6 PK			3.41 V	6	107.7	3.9
4	*5530.00	98.1 AV			3.41 V	6	94.2	3.9
5	*5610.00	108.4 PK			3.95 V	187	104.5	3.9
6	*5610.00	96.0 AV			3.95 V	187	92.1	3.9
7	#5725.00	55.0 PK	74.0	-19.0	3.95 V	187	50.8	4.2
8	#5725.00	42.4 AV	54.0	-11.6	3.95 V	187	38.2	4.2
9	11060.00	54.1 PK	74.0	-19.9	1.28 V	234	39.0	15.1
10	11060.00	42.3 AV	54.0	-11.7	1.28 V	234	27.2	15.1
11	11220.00	54.1 PK	74.0	-19.9	1.51 V	156	38.9	15.2
12	11220.00	42.0 AV	54.0	-12.0	1.51 V	156	26.8	15.2
13	#16590.00	57.8 PK	74.0	-16.2	2.21 V	151	40.1	17.7
14	#16590.00	45.0 AV	54.0	-9.0	2.21 V	151	27.3	17.7
15	#16830.00	57.7 PK	74.0	-16.3	1.90 V	221	39.2	18.5
16	#16830.00	45.3 AV	54.0	-8.7	1.90 V	221	26.8	18.5

**REMARKS:**

1. Emission Level(dBuV/m) = Raw Value(dBuV) + Correction Factor(dB/m)
2. Correction Factor(dB/m) = Antenna Factor(dB/m) + Cable Factor(dB) – Pre-Amplifier Factor(dB)
3. The other emission levels were very low against the limit.
4. Margin value = Emission Level – Limit value
5. " \* ": Fundamental frequency.
6. " # ": The radiated frequency is out of the restricted band.

<b>CHANNEL</b>	TX Channel 122+138	<b>DETECTOR FUNCTION</b>	Peak (PK)
<b>FREQUENCY RANGE</b>	1GHz ~ 40GHz		Average (AV)

**ANTENNA POLARITY & TEST DISTANCE: HORIZONTAL AT 3 M**

NO.	FREQ. (MHz)	EMISSION LEVEL (dBuV/m)	LIMIT (dBuV/m)	MARGIN (dB)	ANTENNA HEIGHT (m)	TABLE ANGLE (Degree)	RAW VALUE (dBuV)	CORRECTION FACTOR (dB/m)
1	*5610.00	109.7 PK			3.22 H	78	105.8	3.9
2	*5610.00	97.2 AV			3.22 H	78	93.3	3.9
3	*5690.00	109.5 PK			2.83 H	311	105.3	4.2
4	*5690.00	97.0 AV			2.83 H	311	92.8	4.2
5	#5850.00	55.7 PK	74.0	-18.3	2.83 H	311	51.5	4.2
6	#5850.00	42.6 AV	54.0	-11.4	2.83 H	311	38.4	4.2
7	11220.00	60.8 PK	74.0	-13.2	3.63 H	66	45.6	15.2
8	11220.00	46.8 AV	54.0	-7.2	3.63 H	66	31.6	15.2
9	11380.00	60.3 PK	74.0	-13.7	3.56 H	62	44.9	15.4
10	11380.00	46.3 AV	54.0	-7.7	3.56 H	62	30.9	15.4
11	#16830.00	55.5 PK	74.0	-18.5	3.59 H	45	37.0	18.5
12	#16830.00	41.6 AV	54.0	-12.4	3.59 H	45	23.1	18.5
13	#17070.00	55.5 PK	74.0	-18.5	3.53 H	50	35.5	20.0
14	#17070.00	42.1 AV	54.0	-11.9	3.53 H	50	22.1	20.0

**ANTENNA POLARITY & TEST DISTANCE: VERTICAL AT 3 M**

NO.	FREQ. (MHz)	EMISSION LEVEL (dBuV/m)	LIMIT (dBuV/m)	MARGIN (dB)	ANTENNA HEIGHT (m)	TABLE ANGLE (Degree)	RAW VALUE (dBuV)	CORRECTION FACTOR (dB/m)
1	*5610.00	111.1 PK			3.06 V	7	107.2	3.9
2	*5610.00	97.9 AV			3.06 V	7	94.0	3.9
3	*5690.00	108.1 PK			3.99 V	14	103.9	4.2
4	*5690.00	94.1 AV			3.99 V	14	89.9	4.2
5	#5850.00	55.4 PK	74.0	-18.6	3.99 V	14	51.2	4.2
6	#5850.00	42.7 AV	54.0	-11.3	3.99 V	14	38.5	4.2
7	11220.00	56.7 PK	74.0	-17.3	1.64 V	161	41.5	15.2
8	11220.00	43.3 AV	54.0	-10.7	1.64 V	161	28.1	15.2
9	11380.00	55.8 PK	74.0	-18.2	1.54 V	168	40.4	15.4
10	11380.00	42.4 AV	54.0	-11.6	1.54 V	168	27.0	15.4
11	#16830.00	59.9 PK	74.0	-14.1	1.67 V	225	41.4	18.5
12	#16830.00	47.2 AV	54.0	-6.8	1.67 V	225	28.7	18.5
13	#17070.00	59.4 PK	74.0	-14.6	1.69 V	237	39.4	20.0
14	#17070.00	46.6 AV	54.0	-7.4	1.69 V	237	26.6	20.0

**REMARKS:**

1. Emission Level(dBuV/m) = Raw Value(dBuV) + Correction Factor(dB/m)
2. Correction Factor(dB/m) = Antenna Factor(dB/m) + Cable Factor(dB) – Pre-Amplifier Factor(dB)
3. The other emission levels were very low against the limit.
4. Margin value = Emission Level – Limit value
5. " \* ": Fundamental frequency.
6. " # ": The radiated frequency is out of the restricted band.

Below 1GHz Data :

802.11ac (VHT80)

<b>CHANNEL</b>	TX Channel 58	<b>DETECTOR FUNCTION</b>	Quasi-Peak (QP)
<b>FREQUENCY RANGE</b>	Below 1GHz		

**ANTENNA POLARITY & TEST DISTANCE: HORIZONTAL AT 3 M**

NO.	FREQ. (MHz)	EMISSION LEVEL (dBuV/m)	LIMIT (dBuV/m)	MARGIN (dB)	ANTENNA HEIGHT (m)	TABLE ANGLE (Degree)	RAW VALUE (dBuV)	CORRECTION FACTOR (dB/m)
1	125.00	35.2 QP	43.5	-8.3	2.50 H	150	45.7	-10.5
2	153.90	39.8 QP	43.5	-3.7	2.00 H	135	48.1	-8.3
3	216.96	39.8 QP	46.0	-6.2	1.50 H	189	51.1	-11.3
4	375.01	42.0 QP	46.0	-4.0	1.00 H	170	47.5	-5.5
5	500.01	38.0 QP	46.0	-8.0	2.00 H	150	40.3	-2.3
6	625.00	37.4 QP	46.0	-8.6	1.50 H	180	37.0	0.4

**ANTENNA POLARITY & TEST DISTANCE: VERTICAL AT 3 M**

NO.	FREQ. (MHz)	EMISSION LEVEL (dBuV/m)	LIMIT (dBuV/m)	MARGIN (dB)	ANTENNA HEIGHT (m)	TABLE ANGLE (Degree)	RAW VALUE (dBuV)	CORRECTION FACTOR (dB/m)
1	53.02	36.7 QP	40.0	-3.3	1.00 V	234	45.0	-8.3
2	73.50	36.9 QP	40.0	-3.1	1.00 V	51	48.0	-11.1
3	92.86	37.8 QP	43.5	-5.7	1.00 V	360	51.7	-13.9
4	154.21	34.0 QP	43.5	-9.5	1.00 V	243	42.3	-8.3
5	375.01	36.6 QP	46.0	-9.4	1.00 V	260	42.1	-5.5
6	625.02	36.3 QP	46.0	-9.7	1.50 V	65	35.9	0.4

**REMARKS:**

1. Emission Level(dBuV/m) = Raw Value(dBuV) + Correction Factor(dB/m)
2. Correction Factor(dB/m) = Antenna Factor(dB/m) + Cable Factor(dB) – Pre-Amplifier Factor(dB)
3. The other emission levels were very low against the limit.
4. Margin value = Emission Level – Limit value



4.1.8 Test Results (Mode 2)

Below 1GHz Data :

802.11ac (VHT80)

<b>CHANNEL</b>	TX Channel 58	<b>DETECTOR FUNCTION</b>	Quasi-Peak (QP)
<b>FREQUENCY RANGE</b>	Below 1GHz		

ANTENNA POLARITY & TEST DISTANCE: HORIZONTAL AT 3 M								
NO.	FREQ. (MHz)	EMISSION LEVEL (dBuV/m)	LIMIT (dBuV/m)	MARGIN (dB)	ANTENNA HEIGHT (m)	TABLE ANGLE (Degree)	RAW VALUE (dBuV)	CORRECTION FACTOR (dB/m)
1	66.40	31.8 QP	40.0	-8.2	1.50 H	300	41.6	-9.8
2	93.30	30.7 QP	43.5	-12.8	1.80 H	205	44.6	-13.9
3	209.30	33.8 QP	43.5	-9.7	1.20 H	201	45.2	-11.4
4	236.10	36.5 QP	46.0	-9.5	1.00 H	282	46.7	-10.2
5	330.50	36.4 QP	46.0	-9.6	1.50 H	100	42.9	-6.5
6	500.10	33.1 QP	46.0	-12.9	1.80 H	206	35.4	-2.3

ANTENNA POLARITY & TEST DISTANCE: VERTICAL AT 3 M								
NO.	FREQ. (MHz)	EMISSION LEVEL (dBuV/m)	LIMIT (dBuV/m)	MARGIN (dB)	ANTENNA HEIGHT (m)	TABLE ANGLE (Degree)	RAW VALUE (dBuV)	CORRECTION FACTOR (dB/m)
1	40.66	38.8 QP	40.0	-1.2	1.50 V	110	52.8	-14.0
2	66.44	35.8 QP	40.0	-4.2	1.00 V	200	50.6	-14.8
3	125.10	33.8 QP	43.5	-9.7	1.20 V	104	49.3	-15.5
4	146.40	32.4 QP	43.5	-11.1	1.50 V	110	46.0	-13.6
5	329.70	30.6 QP	46.0	-15.4	1.10 V	102	42.2	-11.6
6	625.10	30.4 QP	46.0	-15.6	1.00 V	110	35.1	-4.7

**REMARKS:**

1. Emission Level(dBuV/m) = Raw Value(dBuV) + Correction Factor(dB/m)
2. Correction Factor(dB/m) = Antenna Factor(dB/m) + Cable Factor(dB) – Pre-Amplifier Factor(dB)
3. The other emission levels were very low against the limit.
4. Margin value = Emission Level – Limit value

## 4.2 Conducted Emission Measurement

### 4.2.1 Limits of Conducted Emission Measurement

Frequency (MHz)	Conducted Limit (dBuV)	
	Quasi-peak	Average
0.15 - 0.5	66 - 56	56 - 46
0.50 - 5.0	56	46
5.0 - 30.0	60	50

Note: 1. The lower limit shall apply at the transition frequencies.

2. The limit decreases in line with the logarithm of the frequency in the range of 0.15 to 0.50MHz.

### 4.2.2 Test Instruments

DESCRIPTION & MANUFACTURER	MODEL NO.	SERIAL NO.	CALIBRATED DATE	CALIBRATED UNTIL
Test Receiver R&S	ESCS 30	847124/029	Oct. 23, 2015	Oct. 22, 2016
Line-Impedance Stabilization Network (for EUT) R&S	ESH3-Z5	848773/004	Oct. 28, 2015	Oct. 27, 2016
RF Cable	5D-FB	COACAB-002	Mar. 04, 2016	Mar. 03, 2017
10 dB PAD Mini-Circuits	HAT-10+	CONATT-004	Jun. 20, 2016	Jun. 19, 2017
Software BVADT	BVADT_Cond_ V7.3.7.3	NA	NA	NA

**Note:**

1. The calibration interval of the above test instruments are 12 months and the calibrations are traceable to NML/ROC and NIST/USA.
2. The test was performed in Shielded Room No. 1.
- 3 Tested Date: June 21 to Aug. 16, 2016

#### 4.2.3 Test Procedure

- The EUT was placed 0.4 meters from the conducting wall of the shielded room with EUT being connected to the power mains through a line impedance stabilization network (LISN). Other support units were connected to the power mains through another LISN. The two LISNs provide 50 ohm/ 50uH of coupling impedance for the measuring instrument.
- Both lines of the power mains connected to the EUT were checked for maximum conducted interference.
- The frequency range from 150kHz to 30MHz was searched. Emission levels under (Limit - 20dB) was not recorded.

**NOTE:** All modes of operation were investigated and the worst-case emissions are reported.

#### 4.2.4 Deviation from Test Standard

No deviation.

#### 4.2.5 Test Setup

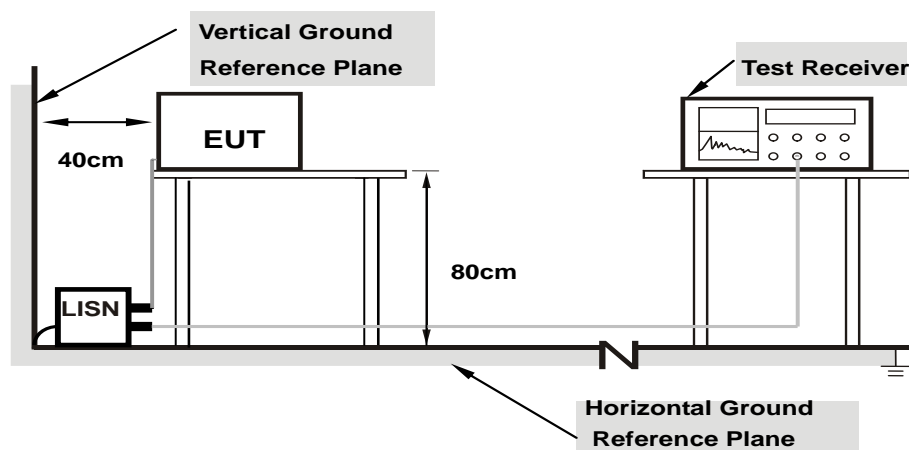

**Note: 1.Support units were connected to second LISN.**

**2.Both of LISNs (AMN) are 80 cm from EUT and at least 80 from other units and other metal planes**

For the actual test configuration, please refer to the attached file (Test Setup Photo).

#### 4.2.6 EUT Operating Condition

Same as 4.1.6.

#### 4.2.7 Test Results (Mode 1)

Phase	Line (L)	Detector Function	Quasi-Peak (QP) / Average (AV)
-------	----------	-------------------	--------------------------------

Phase Of Power : Line (L)										
No	Frequency (MHz)	Correction Factor (dB)	Reading Value (dBuV)		Emission Level (dBuV)		Limit (dBuV)		Margin (dB)	
			Q.P.	AV.	Q.P.	AV.	Q.P.	AV.	Q.P.	AV.
1	0.15000	10.21	34.41	25.33	44.62	35.54	66.00	56.00	-21.38	-20.46
2	0.22812	10.22	32.27	25.37	42.49	35.59	62.52	52.52	-20.03	-16.93
3	0.53387	10.23	20.46	13.02	30.69	23.25	56.00	46.00	-25.31	-22.75
4	0.94688	10.26	20.24	13.14	30.50	23.40	56.00	46.00	-25.50	-22.60
5	7.07422	10.46	23.03	17.47	33.49	27.93	60.00	50.00	-26.51	-22.07
<b>6</b>	<b>24.00000</b>	<b>11.43</b>	<b>33.95</b>	<b>33.45</b>	<b>45.38</b>	<b>44.88</b>	<b>60.00</b>	<b>50.00</b>	<b>-14.62</b>	<b>-5.12</b>

#### Remarks:

1. Q.P. and AV. are abbreviations of quasi-peak and average individually.
2. The emission levels of other frequencies were very low against the limit.
3. Margin value = Emission level – Limit value
4. Correction factor = Insertion loss + Cable loss
5. Emission Level = Correction Factor + Reading Value

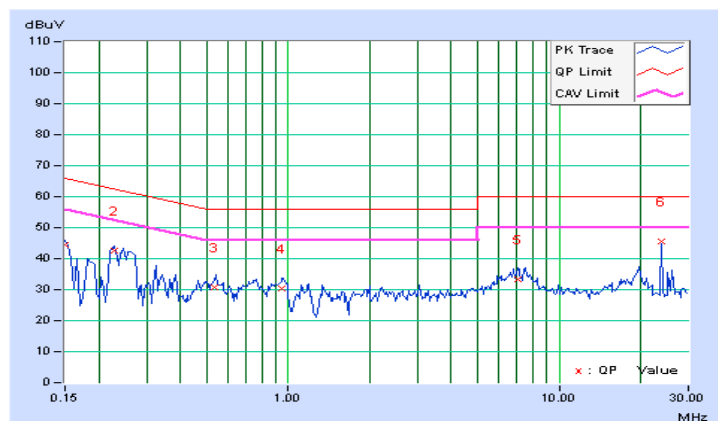

Phase	Neutral (N)	Detector Function	Quasi-Peak (QP) / Average (AV)
-------	-------------	-------------------	--------------------------------

Phase Of Power : Neutral (N)										
No	Frequency (MHz)	Correction Factor (dB)	Reading Value (dBuV)		Emission Level (dBuV)		Limit (dBuV)		Margin (dB)	
			Q.P.	AV.	Q.P.	AV.	Q.P.	AV.	Q.P.	AV.
1	0.15000	10.19	34.45	25.25	44.64	35.44	66.00	56.00	-21.36	-20.56
2	0.22803	10.21	32.25	24.71	42.46	34.92	62.52	52.52	-20.06	-17.60
3	0.53216	10.21	20.56	14.04	30.77	24.25	56.00	46.00	-25.23	-21.75
4	0.95506	10.24	20.56	12.41	30.80	22.65	56.00	46.00	-25.20	-23.35
5	7.32813	10.39	22.64	16.83	33.03	27.22	60.00	50.00	-26.97	-22.78
6	24.00000	11.13	31.92	31.60	43.05	42.73	60.00	50.00	-16.95	-7.27

**Remarks:**

1. Q.P. and AV. are abbreviations of quasi-peak and average individually.
2. The emission levels of other frequencies were very low against the limit.
3. Margin value = Emission level – Limit value
4. Correction factor = Insertion loss + Cable loss
5. Emission Level = Correction Factor + Reading Value

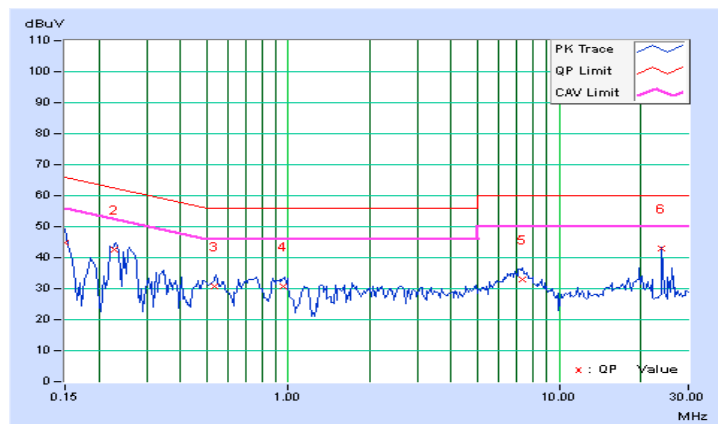

#### 4.2.8 Test Results (Mode 2)

Phase	Line (L)	Detector Function	Quasi-Peak (QP) / Average (AV)
-------	----------	-------------------	--------------------------------

Phase Of Power : Line (L)										
No	Frequency (MHz)	Correction Factor (dB)	Reading Value (dBuV)		Emission Level (dBuV)		Limit (dBuV)		Margin (dB)	
			Q.P.	AV.	Q.P.	AV.	Q.P.	AV.	Q.P.	AV.
1	0.16172	10.21	40.48	26.75	50.69	36.96	65.38	55.38	-14.68	-18.41
2	0.19297	10.22	36.16	22.07	46.38	32.29	63.91	53.91	-17.53	-21.62
3	0.27109	10.22	27.77	14.96	37.99	25.18	61.08	51.08	-23.09	-25.90
4	0.59922	10.23	18.98	12.77	29.21	23.00	56.00	46.00	-26.79	-23.00
5	15.16406	11.07	19.92	15.89	30.99	26.96	60.00	50.00	-29.01	-23.04
6	25.23047	11.45	23.88	21.76	35.33	33.21	60.00	50.00	-24.67	-16.79

**Remarks:**

1. Q.P. and AV. are abbreviations of quasi-peak and average individually.
2. The emission levels of other frequencies were very low against the limit.
3. Margin value = Emission level – Limit value
4. Correction factor = Insertion loss + Cable loss
5. Emission Level = Correction Factor + Reading Value

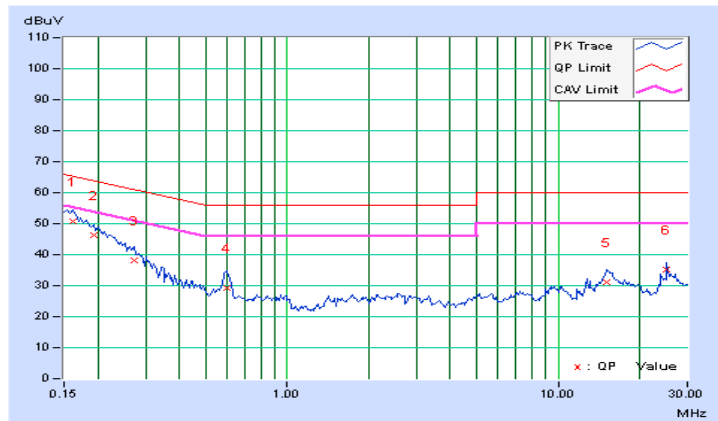

Phase	Neutral (N)	Detector Function	Quasi-Peak (QP) / Average (AV)
-------	-------------	-------------------	--------------------------------

Phase Of Power : Neutral (N)										
No	Frequency (MHz)	Correction Factor (dB)	Reading Value (dBuV)		Emission Level (dBuV)		Limit (dBuV)		Margin (dB)	
			Q.P.	AV.	Q.P.	AV.	Q.P.	AV.	Q.P.	AV.
1	0.16172	10.19	40.69	26.82	50.88	37.01	65.38	55.38	-14.49	-18.36
2	0.21250	10.21	33.82	19.74	44.03	29.95	63.11	53.11	-19.08	-23.16
3	0.28281	10.21	26.58	14.27	36.79	24.48	60.73	50.73	-23.95	-26.26
4	0.59922	10.21	18.69	13.26	28.90	23.47	56.00	46.00	-27.10	-22.53
5	15.46484	10.91	21.53	18.35	32.44	29.26	60.00	50.00	-27.56	-20.74
6	25.22656	11.13	23.66	20.96	34.79	32.09	60.00	50.00	-25.21	-17.91

**Remarks:**

1. Q.P. and AV. are abbreviations of quasi-peak and average individually.
2. The emission levels of other frequencies were very low against the limit.
3. Margin value = Emission level – Limit value
4. Correction factor = Insertion loss + Cable loss
5. Emission Level = Correction Factor + Reading Value

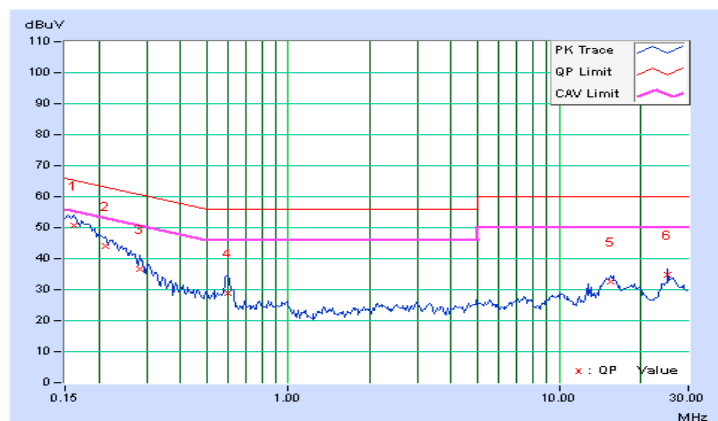

### 4.3 Transmit Power Measurement

#### 4.3.1 Limits of Transmit Power Measurement

Operation Band	EUT Category		Limit
U-NII-1		Outdoor Access Point	1 Watt (30 dBm) (Max. e.i.r.p $\leq$ 125mW(21 dBm) at any elevation angle above 30 degrees as measured from the horizon)
		Fixed point-to-point Access Point	1 Watt (30 dBm)
	√	Indoor Access Point	1 Watt (30 dBm)
		Mobile and Portable client device	250mW (24 dBm)
U-NII-2A		√	250mW (24 dBm) or 11 dBm+10 log B*
U-NII-2C		√	250mW (24 dBm) or 11 dBm+10 log B*
U-NII-3		√	1 Watt (30 dBm)

\*B is the 26 dB emission bandwidth in megahertz

Per KDB 662911 Method of conducted output power measurement on IEEE 802.11 devices,

Array Gain = 0 dB (i.e., no array gain) for  $N_{ANT} \leq 4$ ;

Array Gain = 0 dB (i.e., no array gain) for channel widths  $\geq 40$  MHz for any  $N_{ANT}$ ;

Array Gain =  $5 \log(N_{ANT}/N_{SS})$  dB or 3 dB, whichever is less for 20-MHz channel widths with  $N_{ANT} \geq 5$ .

For power measurements on all other devices: Array Gain =  $10 \log(N_{ANT}/N_{SS})$  dB.



#### 4.3.2 Test Setup

##### FOR POWER OUTPUT MEASUREMENT

For channel straddling 5725MHz:

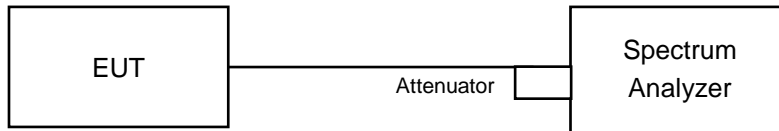

For other channels:

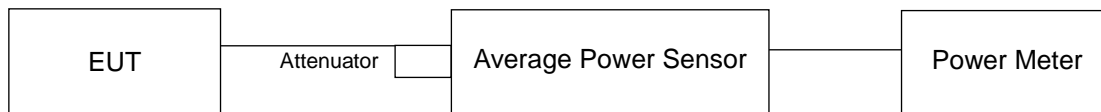

##### FOR 26dB OCCUPIED BANDWIDTH

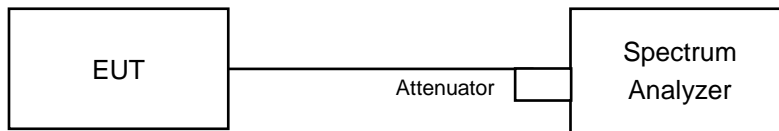

#### 4.3.3 Test Instruments

Refer to section 4.1.2 to get information of above instrument.

#### 4.3.4 Test Procedure

##### FOR AVERAGE POWER MEASUREMENT

**For channel straddling 5725MHz:**

##### 802.11ac (VHT20)

Method SA-1

1. Set span to encompass the entire emission bandwidth (EBW) of the signal.
2. Set RBW =1MHz.
3. Set the VBW  $\geq 3 \times$  RBW.
4. Number of points in sweep  $\geq 2$  Span / RBW.
5. Sweep time = auto.
6. Set trigger to free run (duty cycle  $\geq 98$  percent)
7. Detector = RMS.
8. Trace average at least 100 traces in power averaging mode
9. Compute power by integrating the spectrum across the 26 dB EBW of the signal.

##### Other Modulation mode

Method SA-2

1. Set span to encompass the emission bandwidth (EBW) of the signal.
2. Set RBW =1MHz.
3. Set the VBW  $\geq 3 \times$  RBW.
4. Number of points in sweep  $\geq 2$  Span / RBW.
5. Sweep time = auto.
6. Detector = RMS.
7. Trace average at least 100 traces in power averaging mode
8. Compute power by integrating the spectrum across the 26 dB EBW of the signal.
9. Duty factor need added to measured value (duty cycle  $< 98$  percent).

##### For other channels:

Method PM is used to perform output power measurement, trigger and gating function of wide band power meter is enabled to measure max output power of TX on burst. Duty factor is not added to measured value.

##### FOR 26dB OCCUPIED BANDWIDTH

1. Set RBW = approximately 1% of the emission bandwidth.
2. Set the VBW  $>$  RBW.
3. Detector = Peak.
4. Trace mode = max hold.
5. Measure the maximum width of the emission that is 26 dB down from the peak of the emission. Compare this with the RBW setting of the analyzer. Readjust RBW and repeat measurement as needed until the RBW/EBW ratio is approximately 1%.

#### 4.3.5 Deviation from Test Standard

No deviation.

#### 4.3.6 EUT Operating Condition

The software provided by client to enable the EUT under transmission condition continuously at lowest, middle and highest channel frequencies individually.

#### 4.3.7 Test Result

#### CDD Mode

#### 802.11a

#### POWER OUTPUT:

Chan.	Chan. Freq. (MHz)	Maximum Conducted Power (dBm)				Total Power (mW)	Total Power (dBm)	Limit (dBm)	Pass / Fail
		Chain 0	Chain 1	Chain 2	Chain 3				
52	5260	12.88	12.66	13.07	12.77	77.059	18.87	23.95	Pass
60	5300	12.92	12.54	12.86	12.68	75.39	18.77	23.96	Pass
64	5320	13.00	12.46	12.51	12.66	73.847	18.68	23.97	Pass
100	5500	12.27	12.32	12.83	13.02	73.159	18.64	24.00	Pass
116	5580	12.32	12.34	12.77	13.13	73.683	18.67	23.99	Pass
140	5700	12.30	12.26	12.82	13.06	73.182	18.64	23.99	Pass
*144 (U_NII-2C)	5720	8.85	8.09	8.32	7.96	28.19	14.50	22.80	Pass
*144 (U_NII-3)	5720	2.32	2.02	2.00	1.84	6.654	8.23	29.79	Pass

Note: For U\_NII-3: Antenna gain (Max.) = 6.21dBi > 6dBi , so the power limit shall be reduced to 30-(6.21-6) =29.79dBm.

\* Test was performed in accordance with Measurement follow FCC KDB 789033 UNII test procedure Method SA-2 and use spectrum analyzer test.

The Total Power for the straddle channel:

Chan.	Chan. Freq. (MHz)	Average Power (mW)	Average Power (dBm)
144	5720	34.844	15.42

Note: The total power was calculated through formula and record the value for reference only.

**26dB BANDWIDTH:**

Channel	Frequency (MHz)	26dBc Bandwidth (MHz)			
		Chain 0	Chain 1	Chain 2	Chain 3
52	5260	19.75	19.92	19.82	19.85
60	5300	19.94	19.81	20.03	20.00
64	5320	20.30	19.87	19.88	19.84
100	5500	20.12	20.06	20.02	20.30
116	5580	20.07	20.04	20.00	19.94
140	5700	19.98	19.99	20.33	19.95
144 (U_NII-2C)	5720	15.16	15.19	15.21	15.18

**Note: For U-NII-2A, U-NII-2C Band output power limitation is determined based on 26dBc bandwidth**

Power Limit = 11dBm + 10logB < U-NII-2A, U-NII-2C >			
Channel Number	Freq.(MHz)	Min. B(MHz)	Determined Conducted Limit (dBm)
52	5260	19.75	23.95 < 24
60	5300	19.81	23.96 < 24
64	5320	19.84	23.97 < 24
100	5500	20.02	24.01 > 24
116	5580	19.94	23.99 < 24
140	5700	19.95	23.99 < 24
144 (U_NII-2C)	5720	15.16	22.8 < 24

## 802.11ac (VHT20)

### POWER OUTPUT:

Chan.	Chan. Freq. (MHz)	Maximum Conducted Power (dBm)				Total Power (mW)	Total Power (dBm)	Limit (dBm)	Pass / Fail
		Chain 0	Chain 1	Chain 2	Chain 3				
52	5260	12.90	12.45	12.84	12.66	74.758	18.74	24.00	Pass
60	5300	13.06	12.54	12.77	12.76	75.98	18.81	24.00	Pass
64	5320	12.94	12.50	12.79	12.70	75.094	18.76	24.00	Pass
100	5500	12.65	12.36	12.52	12.32	70.553	18.49	24.00	Pass
116	5580	12.54	12.47	12.52	12.39	70.81	18.50	24.00	Pass
140	5700	13.12	12.24	12.49	12.06	71.072	18.52	24.00	Pass
*144 (U_NII-2C)	5720	8.98	8.28	8.45	8.18	28.212	14.50	22.81	Pass
*144 (U_NII-3)	5720	3.11	2.64	2.73	2.39	7.492	8.75	29.79	Pass

Note: For U\_NII-3: Antenna gain (Max.) = 6.21dBi > 6dBi , so the power limit shall be reduced to  $30-(6.21-6) = 29.79\text{dBm}$ .

\* Test was performed in accordance with Measurement follow FCC KDB 789033 UNII test procedure Method SA-1 and use spectrum analyzer test.

The Total Power for the straddle channel:

Chan.	Chan. Freq. (MHz)	Average Power (mW)	Average Power (dBm)
144	5720	35.704	15.53

Note: The total power was calculated through formula and record the value for reference only.

**26dB BANDWIDTH:**

Channel	Frequency (MHz)	26dBc Bandwidth (MHz)			
		Chain 0	Chain 1	Chain 2	Chain 3
52	5260	20.60	20.62	20.61	20.78
60	5300	20.77	20.71	20.60	20.73
64	5320	20.56	20.68	20.71	20.66
100	5500	20.64	20.77	20.72	21.04
116	5580	20.84	20.68	20.67	20.63
140	5700	20.78	20.76	20.80	20.88
144 (U_NII-2C)	5720	15.31	15.30	15.36	15.20

**Note: For FCC output power limitation is determined based on 26dB bandwidth.**

Power Limit = 11dBm + 10logB < U-NII-2A, U-NII-2C >			
Channel Number	Freq.(MHz)	Min. B(MHz)	Determined Conducted Limit (dBm)
52	5260	20.60	24.13 > 24
60	5300	20.60	24.13 > 24
64	5320	20.56	24.13 > 24
100	5500	20.64	24.14 > 24
116	5580	20.63	24.14 > 24
140	5700	20.76	24.17 > 24
144 (U_NII-2C)	5720	15.20	22.81 < 24

**802.11ac (VHT40)**
**POWER OUTPUT:**

Chan.	Chan. Freq. (MHz)	Maximum Conducted Power (dBm)				Total Power (mW)	Total Power (dBm)	Limit (dBm)	Pass / Fail
		Chain 0	Chain 1	Chain 2	Chain 3				
54	5270	15.72	15.50	16.15	15.51	149.579	21.75	24.00	Pass
62	5310	15.73	15.44	16.16	15.46	148.867	21.73	24.00	Pass
102	5510	15.36	15.07	15.65	15.82	141.415	21.50	24.00	Pass
110	5550	15.30	15.15	15.72	15.77	141.7	21.51	24.00	Pass
134	5670	15.86	15.59	15.65	15.16	144.31	21.59	24.00	Pass
*142 (U_NII-2C)	5710	12.41	11.88	12.03	12.27	68.064	18.33	24.00	Pass
*142 (U_NII-3)	5710	0.35	0.43	0.53	0.55	4.616	6.64	29.79	Pass

Note: For U\_NII-3: Antenna gain (Max.) = 6.21dBi > 6dBi , so the power limit shall be reduced to 30-(6.21-6) =29.79dBm.

\* Test was performed in accordance with Measurement follow FCC KDB 789033 UNII test procedure Method SA-2 and use spectrum analyzer test.

The Total Power for the straddle channel:

Chan.	Chan. Freq. (MHz)	Average Power (mW)	Average Power (dBm)
142	5710	72.68	18.61

Note: The total power was calculated through formula and record the value for reference only.

**26dB BANDWIDTH:**

Channel	Frequency (MHz)	26dBc Bandwidth (MHz)			
		Chain 0	Chain 1	Chain 2	Chain 3
54	5270	40.89	40.86	40.74	40.75
62	5310	40.87	40.86	40.85	40.89
102	5510	40.77	40.81	40.78	40.77
110	5550	40.88	40.87	40.86	41.01
134	5670	41.12	40.93	41.17	40.80
142 (U_NII-2C)	5710	35.44	35.39	35.39	35.52

**Note: For U-NII-2A, U-NII-2C Band output power limitation is determined based on 26dBc bandwidth**

Power Limit = 11dBm + 10logB < U-NII-2A, U-NII-2C >			
Channel Number	Freq.(MHz)	Min. B(MHz)	Determined Conducted Limit (dBm)
54	5270	40.74	27.1 > 24
62	5310	40.85	27.11 > 24
102	5510	40.77	27.1 > 24
110	5550	40.86	27.11 > 24
134	5670	40.80	27.1 > 24
142 (U_NII-2C)	5710	35.39	26.48 > 24



**802.11ac (VHT80)**
**OUTPUT POWER:**

Chan.	Chan. Freq. (MHz)	Maximum Conducted Power (dBm)				Total Power (mW)	Total Power (dBm)	Limit (dBm)	Pass / Fail
		Chain 0	Chain 1	Chain 2	Chain 3				
58	5290	17.89	17.72	18.04	17.59	241.766	23.83	24.00	Pass
106	5530	15.88	15.55	15.96	16.14	155.179	21.91	24.00	Pass
122	5610	17.92	18.00	18.15	17.77	250.194	23.98	24.00	Pass
*138 (U_NII-2C)	5690	14.19	13.91	13.87	14.20	107.291	20.31	24.00	Pass
*138 (U_NII-3)	5690	-0.68	-0.09	0.17	-0.56	3.9666	5.98	29.79	Pass

Note: For U\_NII-3: Antenna gain (Max.) = 6.21dBi > 6dBi , so the power limit shall be reduced to  $30-(6.21-6) = 29.79\text{dBm}$ .

\* Test was performed in accordance with Measurement follow FCC KDB 789033 UNII test procedure Method SA-2 and use spectrum analyzer test.

The Total Power for the straddle channel:

Chan.	Chan. Freq. (MHz)	Average Power (mW)	Average Power (dBm)
138	5690	111.2576	20.46

Note: The total power was calculated through formula and record the value for reference only.

**26dB BANDWIDTH:**

Channel	Frequency (MHz)	26dBc Bandwidth (MHz)			
		Chain 0	Chain 1	Chain 2	Chain 3
58	5290	85.27	84.83	84.97	85.31
106	5530	84.50	84.75	83.97	84.80
122	5610	84.73	85.23	85.02	84.92
138 (U_NII-2C)	5690	77.68	77.75	78.04	78.10

**Note: For U-NII-2A, U-NII-2C Band output power limitation is determined based on 26dBc bandwidth**

Power Limit = 11dBm + 10logB < U-NII-2A, U-NII-2C >			
Channel Number	Freq.(MHz)	Min. B(MHz)	Determined Conducted Limit (dBm)
58	5290	84.83	30.28 > 24
106	5530	83.97	30.24 > 24
122	5610	84.73	30.28 > 24
138 (U_NII-2C)	5690	77.68	29.9 > 24

**802.11ac (VHT80+80)**
**OUTPUT POWER:**

Chan.	Chan. Freq. (MHz)	Maximum Conducted Power (dBm)				Total Power (mW)	Total Power (dBm)	Limit (dBm)	Pass / Fail
		Chain 0	Chain 1	Chain 2	Chain 3				
42+106	5210	20.83	21.14	-	-	251.077	24.00	30.00	Pass
	5530	-	-	20.86	21.03	248.664	23.96	24.00	Pass
42+122	5210	20.80	21.17	-	-	251.144	24.00	30.00	Pass
	5610	-	-	20.91	20.96	248.048	23.95	24.00	Pass
42+ 138* (U_NII-2C)+ 138* (U_NII-3)	5210	20.79	21.15	-	-	250.267	23.98	30.00	Pass
	5690	-	-	16.93	17.59	113.353	20.54	24.00	Pass
	5690	-	-	2.16	1.66	3.303	5.19	29.79	Pass
58+106	5290	20.68	21.02	-	-	243.424	23.86	24.00	Pass
	5530	-	-	20.95	20.98	249.765	23.98	24.00	Pass
58+122	5290	20.53	20.96	-	-	237.718	23.76	24.00	Pass
	5610	-	-	20.95	20.99	250.054	23.98	24.00	Pass
58+ 138* (U_NII-2C)+ 138* (U_NII-3)	5290	20.65	21.08	-	-	244.378	23.88	24.00	Pass
	5690	-	-	16.93	17.59	113.353	20.54	24.00	Pass
	5690	-	-	2.16	1.66	3.303	5.19	29.79	Pass
58+155	5290	20.95	20.98	-	-	249.765	23.98	24.00	Pass
	5775	-	-	20.51	20.43	222.868	23.48	29.79	Pass
106 +138*(U_NII-2C) +138*(U_NII-3)	5530	17.84	17.69	-	-	169.669	22.30	24.00	Pass
	5690			13.59	13.86				
	5690	-	-	0.55	-0.82	2.0847	3.19	29.79	Pass
106+155	5530	20.94	20.97	-	-	249.191	23.97	24.00	Pass
	5775	-	-	20.45	20.49	222.861	23.48	29.79	Pass
122+155	5610	20.73	20.94	-	-	242.469	23.85	24.00	Pass
	5775	-	-	20.42	20.50	222.356	23.47	29.79	Pass
138* (U_NII-2C) +138* (U_NII-3) +155	5690	16.78	16.56	-	-	98.701	19.94	24.00	Pass
	5690	2.58	2.51	-	-	241.54	23.83	29.79	Pass
	5775	-	-	20.69	20.81				

Chan.	Chan. Freq. (MHz)	Maximum Conducted Power (dBm)				Total Power (mW)	Total Power (dBm)	Limit (dBm)	Pass / Fail
		Chain 0	Chain 1	Chain 2	Chain 3				
42+58	5210	20.80	20.91	-	-	243.536	23.87	30.00	Pass
	5290	-	-	20.75	20.06	220.241	23.43	24.00	Pass
106+122	5530	17.86	17.68	-	-	239.254	23.79	24.00	Pass
	5610	-	-	17.74	17.79				
122+ 138* (U_NII-2C) +138* (U_NII-3)	5610	17.82	17.77	-	-	170.481	22.32	24.00	Pass
	5690	-	-	13.59	13.86				
	5690	-	-	0.55	-0.82	2.0847	3.19	29.79	Pass

Note: For U\_NII-3: Antenna gain (Max.) = 6.21dBi > 6dBi, so the power limit shall be reduced to  $30-(6.21-6) = 29.79\text{dBm}$ .

\* Test was performed in accordance with Measurement follow FCC KDB 789033 UNII test procedure Method SA-2 and use spectrum analyzer test.

The Total Power for the straddle channel:

Chan.	Chan. Freq. (MHz)	Average Power (mW)	Average Power (dBm)
42+ 138 (U_NII-2C)+ 138 (U_NII-3)	5690	116.656	20.67
58+ 138 (U_NII-2C)+ 138 (U_NII-3)	5690	116.656	20.67
106+ 138 (U_NII-2C)+ 138 (U_NII-3)	5690	51.971	17.4
138 (U_NII-2C)+ 138 (U_NII-3)+ 155	5690	102.517	20.11
122+ 138 (U_NII-2C)+ 138 (U_NII-3)	5690	52.191	17.44

Note: The total power was calculated through formula and record the value for reference only.

**26dB BANDWIDTH:**

Channel	Frequency (MHz)	26dBc Bandwidth (MHz)			
		Chain 0	Chain 1	Chain 2	Chain 3
42+106	5210	84.80	84.99	-	-
	5530	-	-	84.77	84.47
42+122	5210	84.80	84.99	-	-
	5610	-	-	85.13	84.57
42+ 138 (U_NII-2C)+ 138 (U_NII-3)	5210	84.80	84.99	-	-
	5690	-	-	77.73	78.13
	5690	-	-	7.24	7.30
58+106	5290	85.31	85.32	-	-
	5530	-	-	84.77	84.47
58+122	5290	85.31	85.32	-	-
	5610	-	-	85.13	84.57
58+ 138 (U_NII-2C)+ 138 (U_NII-3)	5290	85.31	85.32	-	-
	5690	-	-	77.73	78.13
	5690	-	-	7.24	7.30
58+155	5290	85.31	85.32	-	-
	5775	-	-	85.04	85.10
106+ 138 (U_NII-2C)+ 138 (U_NII-3)	5530	84.56	84.96	-	-
	5690	-	-	78.00	77.51
	5690	-	-	7.20	7.47
106+155	5530	84.99	85.22	-	-
	5775	-	-	85.04	85.10
122+155	5610	85.13	84.96	-	-
	5775	-	-	85.04	85.10
138 (U_NII-2C)+ 138 (U_NII-3)+ 155	5690	77.96	77.60	-	-
	5690	7.11	7.46	-	-
	5775	-	-	85.04	85.10
42+58	5210	84.80	84.99	-	-
	5290	-	-	85.18	85.38
106+122	5530	84.56	84.96	-	-
	5610	-	-	84.87	85.16
122+ 138 (U_NII-2C)+ 138 (U_NII-3)	5610	84.46	85.02	-	-
	5690	-	-	78.00	77.51
	5690	-	-	7.20	7.47

**Note: For U-NII-2A, U-NII-2C Band output power limitation is determined based on 26dBc bandwidth**

Power Limit = 11dBm + 10logB < U-NII-2A, U-NII-2C >			
Channel Number	Freq.(MHz)	Min. B(MHz)	Determined Conducted Limit (dBm)
42+106	5210	-	-
	5530	84.47	30.26 > 24
42+122	5210	-	-
	5610	84.57	30.27 > 24
42+ 138 (U_NII-2C)+ 138 (U_NII-3)	5210	-	-
	5690	77.73	29.9 > 24
	5690	-	-
58+106	5290	85.31	30.3 > 24
	5530	84.47	30.26 > 24
58+122	5290	85.31	30.3 > 24
	5610	84.57	30.27 > 24
58+ 138 (U_NII-2C)+ 138 (U_NII-3)	5290	85.31	30.3 > 24
	5690	77.73	29.9 > 24
	5690	-	-
58+155	5290	85.31	30.3 > 24
	5775	-	-
106+ 138 (U_NII-2C)+ 138 (U_NII-3)	5560	84.56	30.27 > 24
	5690	77.51	29.9 > 24
	5690	-	-
106+155	5530	84.99	30.29 > 24
	5775	-	-
122+155	5610	84.96	30.29 > 24
	5775	-	-
138 (U_NII-2C)+ 138 (U_NII-3)+ 155	5690	77.60	29.89 > 24
	5690	-	-
	5775	-	-
42+58	5210	-	-
	5290	85.18	30.3 > 24
106+122	5530	84.56	30.27 > 24
	5610	84.87	30.28 > 24
122+ 138 (U_NII-2C)+ 138 (U_NII-3)	5610	84.46	30.26 > 24
	5690	77.51	29.89 > 24
	5690	-	-

### Spectrum Plot of Worst Value

**802.11a / Chain 0 - CH144 (U\_NII-2C)**

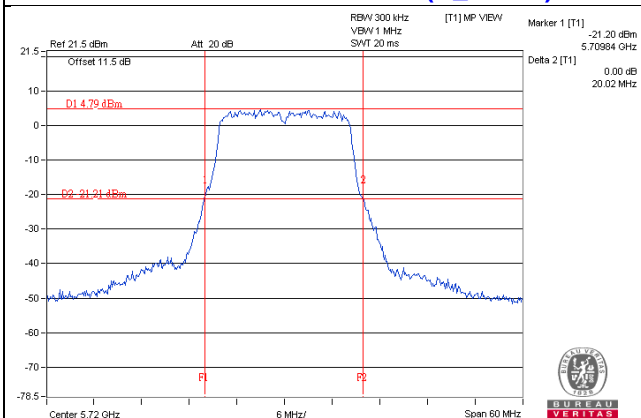

**802.11ac (VHT20) / Chain 3 - CH144 (U\_NII-2C)**

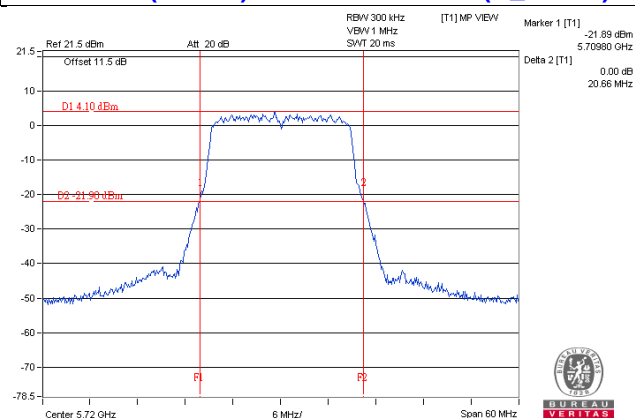

**802.11ac (VHT40) / Chain 2 - CH142 (U\_NII-2C)**

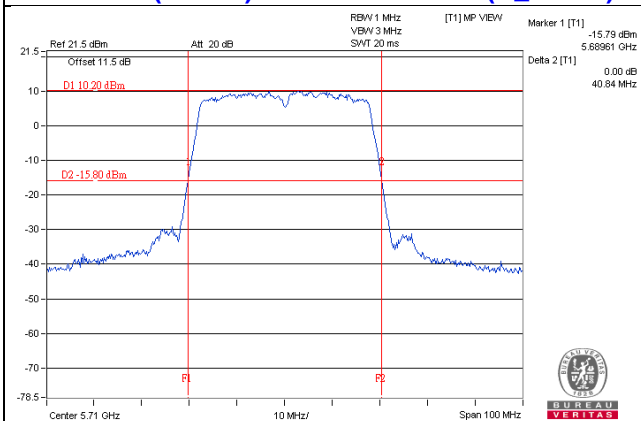

**802.11ac (VHT80) / Chain 0 - CH138 (U\_NII-2C)**

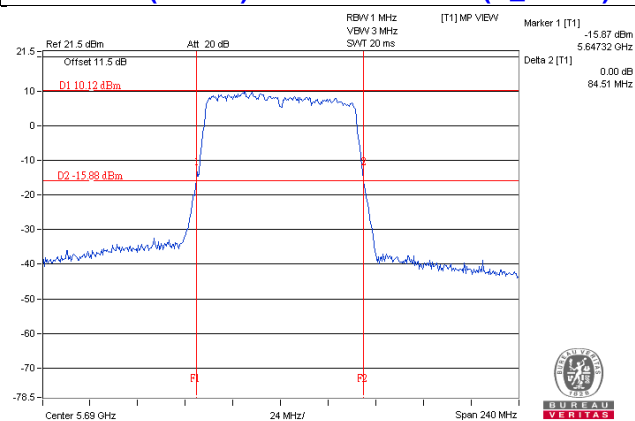

**802.11ac (VHT80+80) / Chain 3 - CH138 (U\_NII-2C)**

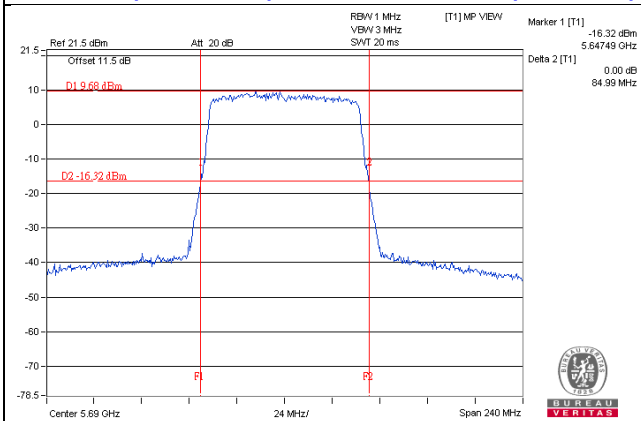

**NOTE:**

- For CH144 (U\_NII-2C) = 5725MHz - Marker 1
- For CH142 (U\_NII-2C) = 5725MHz - Marker 1
- For CH138 (U\_NII-2C) = 5725MHz - Marker 1

## Beamforming Mode

### 802.11ac (VHT20)

#### POWER OUTPUT:

Chan.	Chan. Freq. (MHz)	Maximum Conducted Power (dBm)				Total Power (mW)	Total Power (dBm)	Limit (dBm)	Pass / Fail
		Chain 0	Chain 1	Chain 2	Chain 3				
52	5260	12.90	12.45	12.84	12.66	74.758	18.74	18.93	Pass
60	5300	13.06	12.54	12.77	12.76	75.98	18.81	18.93	Pass
64	5320	12.94	12.50	12.79	12.70	75.094	18.76	18.93	Pass
100	5500	12.65	12.36	12.52	12.32	70.553	18.49	18.68	Pass
116	5580	12.54	12.47	12.52	12.39	70.81	18.50	18.68	Pass
140	5700	13.12	12.24	12.49	12.06	71.072	18.52	18.68	Pass
*144 (U_NII-2C)	5720	8.98	8.28	8.45	8.18	28.212	14.50	17.49	Pass
*144 (U_NII-3)	5720	3.11	2.64	2.73	2.39	7.492	8.75	24.58	Pass

- Note:**
- For U-NII-2A:** Directional gain =  $10 \log[(10^{G1/20} + 10^{G2/20} + 10^{G3/20} + 10^{G4/20})^2 / 4] = 11.07\text{dBi} > 6\text{dBi}$ , so the power limit shall be reduced to "Determined Conducted Limit-(11.07-6).
  - For U-NII-2C:** Directional gain =  $10 \log[(10^{G1/20} + 10^{G2/20} + 10^{G3/20} + 10^{G4/20})^2 / 4] = 11.32\text{dBi} > 6\text{dBi}$ , so the power limit shall be reduced to "Determined Conducted Limit-(11.32-6).
  - For U-NII-3:** Directional gain =  $10 \log[(10^{G1/20} + 10^{G2/20} + 10^{G3/20} + 10^{G4/20})^2 / 4] = 11.42\text{dBi} > 6\text{dBi}$ , so the power limit shall be reduced to  $30 - (11.42 - 6) = 24.58\text{dBm}$ .
- \* Test was performed in accordance with Measurement follow FCC KDB 789033 UNII test procedure Method SA-1 and use spectrum analyzer test.

The Total Power for the straddle channel:

Chan.	Chan. Freq. (MHz)	Average Power (mW)	Average Power (dBm)
144	5720	35.704	15.53

Note: The total power was calculated through formula and record the value for reference only.



**26dB BANDWIDTH:**

Channel	Frequency (MHz)	26dBc Bandwidth (MHz)			
		Chain 0	Chain 1	Chain 2	Chain 3
52	5260	20.60	20.62	20.61	20.78
60	5300	20.77	20.71	20.60	20.73
64	5320	20.56	20.68	20.71	20.66
100	5500	20.64	20.77	20.72	21.04
116	5580	20.84	20.68	20.67	20.63
140	5700	20.78	20.76	20.80	20.88
144 (U_NII-2C)	5720	15.31	15.30	15.36	15.20

**Note: For FCC output power limitation is determined based on 26dB bandwidth.**

Power Limit = 11dBm + 10logB < U-NII-2A, U-NII-2C >			
Channel Number	Freq.(MHz)	Min. B(MHz)	Determined Conducted Limit (dBm)
52	5260	20.60	24.13 > 24
60	5300	20.60	24.13 > 24
64	5320	20.56	24.13 > 24
100	5500	20.64	24.14 > 24
116	5580	20.63	24.14 > 24
140	5700	20.76	24.17 > 24
144 (U_NII-2C)	5720	15.20	22.81 < 24

**802.11ac (VHT40)**
**POWER OUTPUT:**

Chan.	Chan. Freq. (MHz)	Maximum Conducted Power (dBm)				Total Power (mW)	Total Power (dBm)	Limit (dBm)	Pass / Fail
		Chain 0	Chain 1	Chain 2	Chain 3				
54	5270	13.01	12.45	12.95	12.48	75.003	18.75	18.93	Pass
62	5310	13.12	12.54	12.88	12.35	75.047	18.75	18.93	Pass
102	5510	12.38	12.08	12.48	12.84	70.374	18.47	18.68	Pass
110	5550	12.44	12.15	12.33	12.76	69.925	18.45	18.68	Pass
134	5670	12.40	12.10	12.49	12.80	70.393	18.48	18.68	Pass
*142 (U_NII-2C)	5710	9.24	8.71	8.98	9.06	32.95	15.18	18.68	Pass
*142 (U_NII-3)	5710	-2.35	-2.33	-2.57	-2.15	2.4151	3.83	24.58	Pass

- Note:** 1. **For U-NII-2A:** Directional gain =  $10 \log[(10^{G1/20} + 10^{G2/20} + 10^{G3/20} + 10^{G4/20})^2 / 4]$  = 11.07dBi > 6dBi , so the power limit shall be reduced to "Determined Conducted Limit-(11.07-6).
2. **For U-NII-2C:** Directional gain =  $10 \log[(10^{G1/20} + 10^{G2/20} + 10^{G3/20} + 10^{G4/20})^2 / 4]$  =11.32dBi > 6dBi , so the power limit shall be reduced to "Determined Conducted Limit-(11.32-6).
3. **For U-NII-3:** Directional gain =  $10 \log[(10^{G1/20} + 10^{G2/20} + 10^{G3/20} + 10^{G4/20})^2 / 4]$  =11.42dBi > 6dBi , so the power limit shall be reduced to 30-(11.42-6) = 24.58dBm.
- \* Test was performed in accordance with Measurement follow FCC KDB 789033 UNII test procedure Method SA-2 and use spectrum analyzer test.

The Total Power for the straddle channel:

Chan.	Chan. Freq. (MHz)	Average Power (mW)	Average Power (dBm)
142	5710	35.3651	15.49

Note: The total power was calculated through formula and record the value for reference only.

**26dB BANDWIDTH:**

Channel	Frequency (MHz)	26dBc Bandwidth (MHz)			
		Chain 0	Chain 1	Chain 2	Chain 3
54	5270	40.89	40.86	40.74	40.75
62	5310	40.87	40.86	40.85	40.89
102	5510	40.77	40.81	40.78	40.77
110	5550	40.88	40.87	40.86	41.01
134	5670	41.12	40.93	41.17	40.80
142 (U_NII-2C)	5710	35.44	35.39	35.39	35.52

**Note: For U-NII-2A, U-NII-2C Band output power limitation is determined based on 26dBc bandwidth**

Power Limit = 11dBm + 10logB < U-NII-2A, U-NII-2C >			
Channel Number	Freq.(MHz)	Min. B(MHz)	Determined Conducted Limit (dBm)
54	5270	40.74	27.1 > 24
62	5310	40.85	27.11 > 24
102	5510	40.77	27.1 > 24
110	5550	40.86	27.11 > 24
134	5670	40.80	27.1 > 24
142 (U_NII-2C)	5710	35.39	26.48 > 24

**802.11ac (VHT80)**
**OUTPUT POWER:**

Chan.	Chan. Freq. (MHz)	Maximum Conducted Power (dBm)				Total Power (mW)	Total Power (dBm)	Limit (dBm)	Pass / Fail
		Chain 0	Chain 1	Chain 2	Chain 3				
58	5290	13.12	12.44	12.86	12.54	75.318	18.77	18.93	Pass
106	5530	12.46	12.15	12.52	12.77	70.814	18.50	18.68	Pass
122	5610	12.46	12.20	12.44	12.86	71.075	18.52	18.68	Pass
*138 (U_NII-2C)	5690	8.71	8.68	9.15	9.27	33.271	15.22	18.68	Pass
*138 (U_NII-3)	5690	-6.08	-4.52	-5.37	-4.22	1.3406	1.27	24.58	Pass

- Note:** 1. **For U-NII-2A:** Directional gain =  $10 \log[(10^{G1/20} + 10^{G2/20} + 10^{G3/20} + 10^{G4/20})^2 / 4] = 11.07\text{dBi} > 6\text{dBi}$ , so the power limit shall be reduced to "Determined Conducted Limit-(11.07-6).  
 2. **For U-NII-2C:** Directional gain =  $10 \log[(10^{G1/20} + 10^{G2/20} + 10^{G3/20} + 10^{G4/20})^2 / 4] = 11.32\text{dBi} > 6\text{dBi}$ , so the power limit shall be reduced to "Determined Conducted Limit-(11.32-6).  
 3. **For U-NII-3:** Directional gain =  $10 \log[(10^{G1/20} + 10^{G2/20} + 10^{G3/20} + 10^{G4/20})^2 / 4] = 11.42\text{dBi} > 6\text{dBi}$ , so the power limit shall be reduced to  $30 - (11.42 - 6) = 24.58\text{dBm}$ .  
 \* Test was performed in accordance with Measurement follow FCC KDB 789033 UNII test procedure Method SA-2 and use spectrum analyzer test.

The Total Power for the straddle channel:

Chan.	Chan. Freq. (MHz)	Average Power (mW)	Average Power (dBm)
138	5690	34.6116	15.39

Note: The total power was calculated through formula and record the value for reference only.

**26dB BANDWIDTH:**

Channel	Frequency (MHz)	26dBc Bandwidth (MHz)			
		Chain 0	Chain 1	Chain 2	Chain 3
58	5290	85.27	84.83	84.97	85.31
106	5530	84.50	84.75	83.97	84.80
122	5610	84.73	85.23	85.02	84.92
138 (U_NII-2C)	5690	77.68	77.75	78.04	78.10

**Note: For U-NII-2A, U-NII-2C Band output power limitation is determined based on 26dBc bandwidth**

Power Limit = 11dBm + 10logB < U-NII-2A, U-NII-2C >			
Channel Number	Freq.(MHz)	Min. B(MHz)	Determined Conducted Limit (dBm)
58	5290	84.83	30.28 > 24
106	5530	83.97	30.24 > 24
122	5610	84.73	30.28 > 24
138 (U_NII-2C)	5690	77.68	29.9 > 24

**802.11ac (VHT80+80)**  
**OUTPUT POWER:**

Chan.	Chan. Freq. (MHz)	Maximum Conducted Power (dBm)				Total Power (mW)	Total Power (dBm)	Limit (dBm)	Pass / Fail
		Chain 0	Chain 1	Chain 2	Chain 3				
42+106	5210	18.11	18.70	-	-	138.845	21.43	27.71	Pass
	5530	-	-	18.23	18.41	135.87	21.33	21.38	Pass
42+122	5210	18.13	18.61	-	-	137.624	21.39	27.71	Pass
	5610	-	-	18.28	18.42	136.8	21.36	21.38	Pass
42+ 138* (U_NII-2C)+ 138* (U_NII-3)	5210	18.20	18.55	-	-	137.683	21.39	27.71	Pass
	5690	-	-	14.55	14.71	61.695	17.90	21.38	Pass
	5690	-	-	1.28	0.63	2.654	4.24	27.18	Pass
58+106	5290	18.22	18.49	-	-	137.006	21.37	21.95	Pass
	5530	-	-	18.21	18.50	137.017	21.37	21.38	Pass
58+122	5290	18.21	18.25	-	-	133.056	21.24	21.95	Pass
	5610	-	-	18.35	18.37	137.098	21.37	21.38	Pass
58+ 138* (U_NII-2C)+ 138* (U_NII-3)	5290	18.14	18.33	-	-	133.24	21.25	21.95	Pass
	5690	-	-	14.55	14.71	61.695	17.90	21.38	Pass
	5690	-	-	1.28	0.63	2.654	4.24	27.18	Pass
58+155	5290	18.69	18.76	-	-	149.123	21.74	21.95	Pass
	5775	-	-	18.45	18.32	137.904	21.40	27.18	Pass
106 +138*(U_NII-2C) +138*(U_NII-3)	5530	12.24	12.25	-	-	46.677	16.69	18.68	Pass
	5690	-	-	7.55	8.25	0.5685	-2.45	21.38	Pass
	5690	-	-	-6.11	-5.37	0.5685	-2.45	21.38	Pass
106+155	5530	19.04	18.84	-	-	156.728	21.95	22.02	Pass
	5775	-	-	18.33	18.38	136.942	21.37	27.18	Pass
122+155	5610	18.88	18.76	-	-	152.43	21.83	22.02	Pass
	5775	-	-	18.42	18.33	137.579	21.39	27.18	Pass
138* (U_NII-2C) +138* (U_NII-3) +155	5690	15.01	14.98	-	-	67.094	18.27	22.02	Pass
	5690	0.42	1.39	-	-	141.005	21.49	24.55	Pass
	5775	-	-	18.36	18.44	141.005	21.49	24.55	Pass

Chan.	Chan. Freq. (MHz)	Maximum Conducted Power (dBm)				Total Power (mW)	Total Power (dBm)	Limit (dBm)	Pass / Fail
		Chain 0	Chain 1	Chain 2	Chain 3				
42+58	5210	18.76	19.01	-	-	154.778	21.90	27.71	Pass
	5290	-	-	18.48	18.98	149.537	21.75	21.93	Pass
106+122	5530	12.33	12.36	-	-	68.157	18.34	18.68	Pass
	5610	-	-	12.10	12.46				
122+ 138* (U_NII-2C) +138* (U_NII-3)	5610	12.22	12.34	-	-	46.952	16.72	18.68	Pass
	5690	-	-	7.55	8.25				
	5690	-	-	-6.11	-5.37	0.5685	-2.45	27.18	Pass

- Note:**
- For U-NII-1(chain 0+chain 1):** Directional gain =  $10 \log[(10^{G_{1/20}} + 10^{G_{2/20}})^2 / 2] = 8.29\text{dBi} > 6\text{dBi}$ , so the power limit shall be reduced to "Determined Conducted Limit-(8.29-6).
  - For U-NII-1(chain 2+chain 3):** Directional gain =  $10 \log[(10^{G_{3/20}} + 10^{G_{4/20}})^2 / 2] = 7.8\text{dBi} > 6\text{dBi}$ , so the power limit shall be reduced to "Determined Conducted Limit-(7.8-6).
  - For U-NII-2A(chain 0+chain 1):** Directional gain =  $10 \log[(10^{G_{1/20}} + 10^{G_{2/20}})^2 / 2] = 8.05\text{dBi} > 6\text{dBi}$ , so the power limit shall be reduced to "Determined Conducted Limit-(8.05-6).
  - For U-NII-2A(chain 2+chain 3):** Directional gain =  $10 \log[(10^{G_{3/20}} + 10^{G_{4/20}})^2 / 2] = 8.07\text{dBi} > 6\text{dBi}$ , so the power limit shall be reduced to "Determined Conducted Limit-(8.07-6).
  - For U-NII-2C(chain 0+chain 1):** Directional gain =  $10 \log[(10^{G_{1/20}} + 10^{G_{2/20}})^2 / 2] = 7.98\text{dBi} > 6\text{dBi}$ , so the power limit shall be reduced to "Determined Conducted Limit-(7.98-6).
  - For U-NII-2C(chain 2+chain 3):** Directional gain =  $10 \log[(10^{G_{3/20}} + 10^{G_{4/20}})^2 / 2] = 8.62\text{dBi} > 6\text{dBi}$ , so the power limit shall be reduced to "Determined Conducted Limit-(8.62-6).
  - For U-NII-3(chain 0+chain 1):** Directional gain =  $10 \log[(10^{G_{1/20}} + 10^{G_{2/20}})^2 / 2] = 7.98\text{dBi} > 6\text{dBi}$ , so the power limit shall be reduced to "Determined Conducted Limit-(7.98-6).
  - For U-NII-3(chain 2+chain 3):** Directional gain =  $10 \log[(10^{G_{3/20}} + 10^{G_{4/20}})^2 / 2] = 8.82\text{dBi} > 6\text{dBi}$ , so the power limit shall be reduced to "Determined Conducted Limit-(8.82-6).
  - For U-NII-2C(chain 0+chain 1+chain 2+chain 3):** Directional gain =  $10 \log[(10^{G_{1/20}} + 10^{G_{2/20}} + 10^{G_{3/20}} + 10^{G_{4/20}})^2 / 4] = 11.32\text{dBi} > 6\text{dBi}$ , so the power limit shall be reduced to "Determined Conducted Limit-(11.32-6).
  - For U-NII-3(chain 0+chain 1+chain 2+chain 3):** Directional gain =  $10 \log[(10^{G_{1/20}} + 10^{G_{2/20}} + 10^{G_{3/20}} + 10^{G_{4/20}})^2 / 4] = 11.45\text{dBi} > 6\text{dBi}$ , so the power limit shall be reduced to  $30 - (11.45 - 6) = 24.55\text{dBm}$ .
- \* Test was performed in accordance with Measurement follow FCC KDB 789033 UNII test procedure Method SA-2 and use spectrum analyzer test.

The Total Power for the straddle channel:

Chan.	Chan. Freq. (MHz)	Average Power (mW)	Average Power (dBm)
42+ 138 (U_NII-2C)+ 138 (U_NII-3)	5690	64.349	18.09
58+ 138 (U_NII-2C)+ 138 (U_NII-3)	5690	64.349	18.09
106+ 138 (U_NII-2C)+ 138 (U_NII-3)	5690	13.708	11.37
138 (U_NII-2C)+ 138 (U_NII-3)+ 155	5690	69.727	18.43
122+ 138 (U_NII-2C)+ 138 (U_NII-3)	5690	13.708	11.63

Note: The total power was calculated through formula and record the value for reference only.



**26dB BANDWIDTH:**

Channel	Frequency (MHz)	26dBc Bandwidth (MHz)			
		Chain 0	Chain 1	Chain 2	Chain 3
42+106	5210	84.80	84.99	-	-
	5530	-	-	84.77	84.47
42+122	5210	84.80	84.99	-	-
	5610	-	-	85.13	84.57
42+ 138 (U_NII-2C)+ 138 (U_NII-3)	5210	84.80	84.99	-	-
	5690	-	-	77.73	78.13
	5690	-	-	7.24	7.30
58+106	5290	85.31	85.32	-	-
	5530	-	-	84.77	84.47
58+122	5290	85.31	85.32	-	-
	5610	-	-	85.13	84.57
58+ 138 (U_NII-2C)+ 138 (U_NII-3)	5290	85.31	85.32	-	-
	5690	-	-	77.73	78.13
	5690	-	-	7.24	7.30
58+155	5290	85.31	85.32	-	-
	5775	-	-	85.04	85.10
106+ 138 (U_NII-2C)+ 138 (U_NII-3)	5530	84.56	84.96	-	-
	5690	-	-	78.00	77.51
	5690	-	-	7.20	7.47
106+155	5530	84.99	85.22	-	-
	5775	-	-	85.04	85.10
122+155	5610	85.13	84.96	-	-
	5775	-	-	85.04	85.10
138 (U_NII-2C)+ 138 (U_NII-3)+ 155	5690	77.96	77.60	-	-
	5690	7.11	7.46	-	-
	5775	-	-	85.04	85.10
42+58	5210	84.80	84.99	-	-
	5290	-	-	85.18	85.38
106+122	5530	84.56	84.96	-	-
	5610	-	-	84.87	85.16
122+ 138 (U_NII-2C)+ 138 (U_NII-3)	5610	84.46	85.02	-	-
	5690	-	-	78.00	77.51
	5690	-	-	7.20	7.47

**Note: For U-NII-2A, U-NII-2C Band output power limitation is determined based on 26dBc bandwidth**

Power Limit = 11dBm + 10logB < U-NII-2A, U-NII-2C >			
Channel Number	Freq.(MHz)	Min. B(MHz)	Determined Conducted Limit (dBm)
42+106	5210	-	-
	5530	84.47	30.26 > 24
42+122	5210	-	-
	5610	84.57	30.27 > 24
42+ 138 (U_NII-2C)+ 138 (U_NII-3)	5210	-	-
	5690	77.73	29.9 > 24
	5690	-	-
58+106	5290	85.31	30.3 > 24
	5530	84.47	30.26 > 24
58+122	5290	85.31	30.3 > 24
	5610	84.57	30.27 > 24
58+ 138 (U_NII-2C)+ 138 (U_NII-3)	5290	85.31	30.3 > 24
	5690	77.73	29.9 > 24
	5690	-	-
58+155	5290	85.31	30.3 > 24
	5775	-	-
106+ 138 (U_NII-2C)+ 138 (U_NII-3)	5560	84.56	30.27 > 24
	5690	77.51	29.9 > 24
	5690	-	-
106+155	5530	84.99	30.29 > 24
	5775	-	-
122+155	5610	84.96	30.29 > 24
	5775	-	-
138 (U_NII-2C)+ 138 (U_NII-3)+ 155	5690	77.60	29.89 > 24
	5690	-	-
	5775	-	-
42+58	5210	-	-
	5290	85.18	30.3 > 24
106+122	5530	84.56	30.27 > 24
	5610	84.87	30.28 > 24
122+ 138 (U_NII-2C)+ 138 (U_NII-3)	5610	84.46	30.26 > 24
	5690	77.51	29.89 > 24
	5690	-	-

Spectrum Plot of Worst Value

802.11ac (VHT20) / Chain 3 - CH144 (U\_NII-2C)

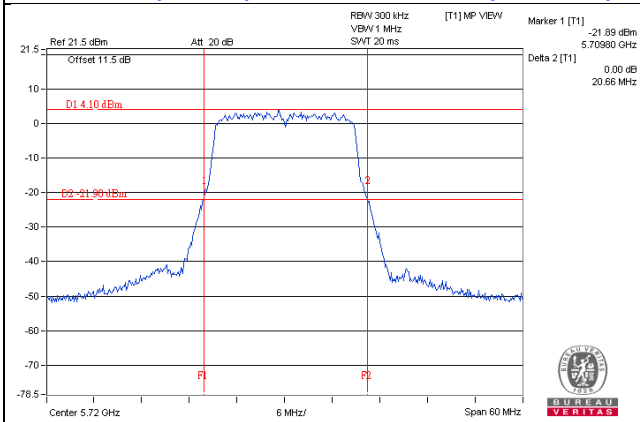

802.11ac (VHT40) / Chain 2 - CH142 (U\_NII-2C)

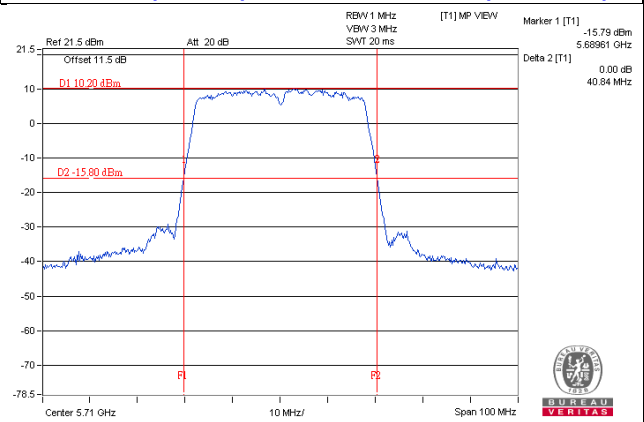

802.11ac (VHT80) / Chain 0 - CH138 (U\_NII-2C)

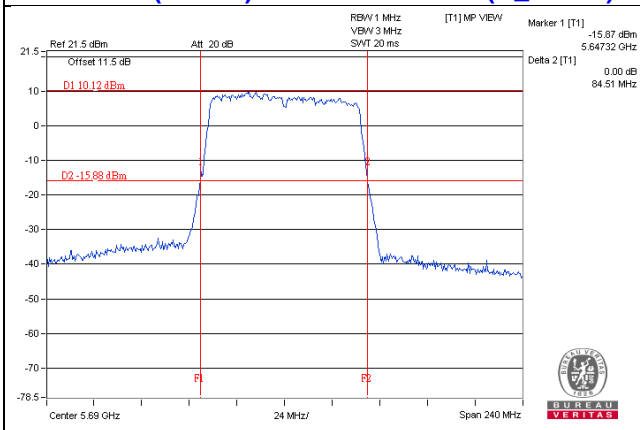

802.11ac (VHT80+80) / Chain 3 - CH130(U\_NII-2C)

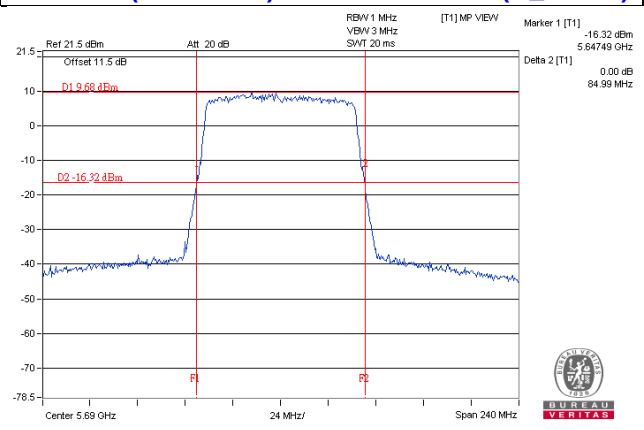

**NOTE:**

- For CH144 (U\_NII-2C) = 5725MHz - Marker 1
- For CH142 (U\_NII-2C) = 5725MHz - Marker 1
- For CH138 (U\_NII-2C) = 5725MHz - Marker 1

## 4.4 Occupied Bandwidth Measurement

### 4.4.1 Test Setup

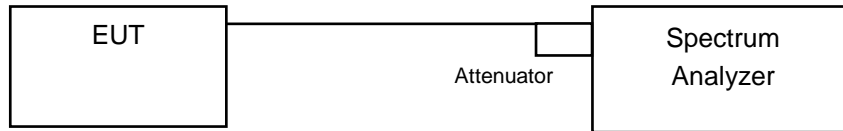

### 4.4.2 Test Instruments

Refer to section 4.1.2 to get information of above instrument.

### 4.4.3 Test Procedure

The transmitter output was connected to the spectrum analyzer through an attenuator. The bandwidth of the fundamental frequency was measured by spectrum analyzer with resolution bandwidth in the range of 1% to 5% of the anticipated emission bandwidth, and a video bandwidth at least 3x the resolution bandwidth and set the detector to SAMPLE. The width of a frequency band such that, below the lower and above the upper frequency limits, the mean powers emitted are each equal to a specified percentage 0.5 %of the total mean power of a given emission.

#### 802.11a

Channel	Channel Frequency (MHz)	Occupied Bandwidth (MHz)			
		Chain 0	Chain 1	Chain 2	Chain 3
52	5260	16.44	16.56	16.56	16.56
60	5300	16.44	16.56	16.44	16.56
64	5320	16.56	16.56	16.44	16.44
100	5500	16.56	16.56	16.56	16.56
116	5580	16.44	16.68	16.44	16.56
140	5700	16.56	16.44	16.56	16.68
144 (U_NII-2C)	5720	13.27	13.27	13.27	13.27
144 (U_NII-3)	5720	3.17	3.17	3.29	3.17

**802.11ac (VHT20)**

Channel	Channel Frequency (MHz)	Occupied Bandwidth (MHz)			
		Chain 0	Chain 1	Chain 2	Chain 3
52	5260	17.64	17.64	17.64	17.64
60	5300	17.64	17.64	17.64	17.64
64	5320	17.64	17.64	17.64	17.64
100	5500	17.64	17.76	17.64	17.64
116	5580	17.76	17.64	17.64	17.64
140	5700	17.64	17.64	17.64	17.64
144 (U_NII-2C)	5720	13.88	13.88	13.88	13.88
144 (U_NII-3)	5720	3.76	3.76	3.76	3.88

**802.11ac (VHT40)**

Channel	Channel Frequency (MHz)	Occupied Bandwidth (MHz)			
		Chain 0	Chain 1	Chain 2	Chain 3
54	5270	36.24	36.24	36.24	36.48
62	5310	36.24	36.24	36.48	36.24
102	5510	36.24	36.24	36.24	36.24
110	5550	36.24	36.00	36.24	36.24
134	5670	36.24	36.24	36.24	36.24
142 (U_NII-2C)	5710	33.39	33.19	33.19	33.19
142 (U_NII-3)	5710	3.01	3.01	3.01	3.01

**802.11ac (VHT80)**

Channel	Channel Frequency (MHz)	Occupied Bandwidth (MHz)			
		Chain 0	Chain 1	Chain 2	Chain 3
58	5290	75.84	76.32	76.32	76.32
106	5530	75.84	75.84	75.84	76.32
122	5610	75.84	76.32	76.32	75.36
138 (U_NII-2C)	5690	73.39	72.92	73.39	73.39
138 (U_NII-3)	5690	2.45	2.92	2.92	2.92

**802.11ac (VHT80+80)**

Channel	Channel Frequency (MHz)	Occupied Bandwidth (MHz)			
		Chain 0	Chain 1	Chain 2	Chain 3
42+106	5210	75.84	75.84	-	-
	5530	-	-	76.32	76.32
42+122	5210	75.84	75.84	-	-
	5610	-	-	76.32	75.84
42+ 138 (U_NII-2C)+ 138 (U_NII-3)	5210	75.84	75.84	-	-
	5690	-	-	73.39	73.39
	5690	-	-	2.92	2.45
58+106	5290	75.84	76.32	-	-
	5530	-	-	76.32	76.32
58+122	5290	75.84	76.32	-	-
	5610	-	-	76.32	75.84
58+ 138 (U_NII-2C)+ 138 (U_NII-3)	5290	75.84	76.32	-	-
	5690	-	-	73.39	73.39
	5690	-	-	2.92	2.45
58+155	5290	75.84	76.32	-	-
	5775	-	-	75.84	75.84
106+ 138(U_NII-2C)+ 138(U_NII-3)	5530	-	-	75.84	76.32
	5690	-	-	72.92	72.92
	5690	-	-	2.92	2.92
106+155	5530	76.32	76.32	-	-
	5775	-	-	75.84	75.84
122+155	5610	76.32	76.32	-	-
	5775	-	-	75.84	75.84
138 (U_NII-2C)+ 138 (U_NII-3)+ 155	5690	73.39	73.39	-	-
	5690	2.45	2.45	-	-
	5775	-	-	75.84	75.84
42+58	5210	75.84	75.84		
	5290			76.32	75.84
106+122	5530	75.84	76.32		
	5610			75.84	76.32
122+ 138 (U_NII-2C)+ 138 (U_NII-3)	5610	76.32	76.32		
	5690			72.92	72.92
	5690			2.92	2.92



## 4.5 Peak Power Spectral Density Measurement

### 4.5.1 Limits of Peak Power Spectral Density Measurement

Operation Band	EUT Category		Limit
U-NII-1		Outdoor Access Point	17dBm/ MHz
		Fixed point-to-point Access Point	
	√	Indoor Access Point	
		Mobile and Portable client device	11dBm/ MHz
U-NII-2A		√	11dBm/ MHz
U-NII-2C		√	11dBm/ MHz
U-NII-3		√	30dBm/ 500kHz

### 4.5.2 Test Setup

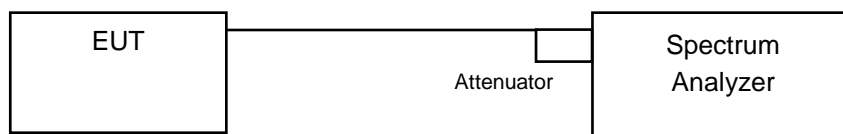

### 4.5.3 Test Instruments

Refer to section 4.1.2 to get information of above instrument.



#### 4.5.4 Test Procedure

##### For U-NII-2A, U-NII-2C band:

##### **802.11a, 802.11ac (VHT40), 802.11ac (VHT80)**

Using method SA-2

1. Set span to encompass the entire emission bandwidth (EBW) of the signal.
2. Set RBW = 1 MHz, Set VBW  $\geq$  3 MHz, Detector = RMS
3. Sweep time = auto, trigger set to "free run".
4. Trace average at least 100 traces in power averaging mode.
5. Record the max value and add 10 log (1/duty cycle)

##### **802.11ac (VHT20)**

Using method SA-1

1. Set span to encompass the entire emission bandwidth (EBW) of the signal.
2. Set RBW = 1 MHz, Set VBW  $\geq$  3 MHz, Detector = RMS
3. Sweep time = auto, trigger set to "free run".
4. Trace average at least 100 traces in power averaging mode.
5. Record the max value

##### For U-NII-3:

##### **802.11a, 802.11ac (VHT40), 802.11ac (VHT80)**

1. Set span to encompass the entire emission bandwidth (EBW) of the signal.
2. Set RBW = 300 kHz, Set VBW  $\geq$  1 MHz, Detector = RMS
3. Use the peak marker function to determine the maximum power level in any 300 kHz band segment within the fundamental EBW.
4. Scale the observed power level to an equivalent value in 500 kHz by adjusting (reducing) the measured power by a bandwidth correction factor (BWCF) where  $BWCF = 10\log(500 \text{ kHz}/300\text{kHz})$
5. Sweep time = auto, trigger set to "free run".
6. Trace average at least 100 traces in power averaging mode.
7. Record the max value and add 10 log (1/duty cycle)

##### **802.11ac (VHT20)**

1. Set span to encompass the entire emission bandwidth (EBW) of the signal.
2. Set RBW = 300 kHz, Set VBW  $\geq$  1 MHz, Detector = RMS
3. Use the peak marker function to determine the maximum power level in any 300 kHz band segment within the fundamental EBW.
4. Scale the observed power level to an equivalent value in 500 kHz by adjusting (reducing) the measured power by a bandwidth correction factor (BWCF) where  $BWCF = 10\log(500 \text{ kHz}/300\text{kHz})$
5. Sweep time = auto, trigger set to "free run".
6. Trace average at least 100 traces in power averaging mode.
7. Record the max value

#### 4.5.5 Deviation from Test Standard

No deviation.

#### 4.5.6 EUT Operating Condition

Same as Item 4.3.6.

#### 4.5.7 Test Results

##### 802.11a

##### For U\_NII-2A, U\_NII-2C Band

Chan.	Chan. Freq. (MHz)	PSD W/O Duty Factor (dBm/MHz)				Duty Factor (dB)	Total PSD With Duty Factor (dBm/MHz)	MAX. Limit (dBm/MHz)	Pass / Fail
		Chain 0	Chain 1	Chain 2	Chain 3				
52	5260	-0.86	-0.72	-0.96	-1.04	0.16	5.29	5.93	Pass
60	5300	-0.86	-0.66	-1.19	-0.97	0.16	5.27	5.93	Pass
64	5320	-1.08	-0.78	-1.09	-0.99	0.16	5.20	5.93	Pass
100	5500	-1.28	-1.36	-0.78	-0.47	0.16	5.23	5.68	Pass
116	5580	-1.30	-1.43	-1.26	-0.59	0.16	5.05	5.68	Pass
140	5700	-1.47	-1.46	-0.79	-0.60	0.16	5.12	5.68	Pass
144 (U_NII-2C)	5720	-0.87	-1.45	-1.38	-1.69	0.16	4.85	5.68	Pass

- Note:**
- Method a) of power density measurement of KDB 662911 is using for calculating total power density. Total power density is summing entire spectra across corresponding frequency bins on the various outputs by computer.
  - For U-NII-2A:** Directional gain =  $10 \log[(10^{G1/20} + 10^{G2/20} + 10^{G3/20} + 10^{G4/20})^2 / 4] = 11.07\text{dBi} > 6\text{dBi}$ , so the power density limit shall be reduced to  $11 - (11.07 - 6) = 5.93\text{dBm}$ .
  - For U-NII-2C:** Directional gain =  $10 \log[(10^{G1/20} + 10^{G2/20} + 10^{G3/20} + 10^{G4/20})^2 / 4] = 11.32\text{dBi} > 6\text{dBi}$ , so the power density limit shall be reduced to  $11 - (11.32 - 6) = 5.68\text{dBm}$ .
  - Refer to section 3.3 for duty cycle spectrum plot.

##### For U\_NII-3 Band

TX chain	Chan.	Chan. Freq. (MHz)	PSD W/O Duty Factor		10 log (N=4) dB	Duty Factor (dB)	Total PSD With Duty Factor (dBm/500kHz)	Limit (dBm/500kHz)	Pass /Fail
			(dBm/300kHz)	(dBm/500kHz)					
0	144 (U_NII-3)	5720	-9.49	-7.27	6.02	0.16	-1.09	24.58	Pass
1	144 (U_NII-3)	5720	-10.01	-7.79	6.02	0.16	-1.61	24.58	Pass
2	144 (U_NII-3)	5720	-9.94	-7.72	6.02	0.16	-1.54	24.58	Pass
3	144 (U_NII-3)	5720	-10.19	-7.97	6.02	0.16	-1.79	24.58	Pass

- Note:**
- Directional gain =  $10 \log[(10^{G1/20} + 10^{G2/20} + 10^{G3/20} + 10^{G4/20})^2 / 4] = 11.42\text{dBi} > 6\text{dBi}$ , so the power density limit shall be reduced to  $30 - (11.42 - 6) = 24.58\text{dBm}$ .
  - Refer to section 3.3 for duty cycle spectrum plot.

**802.11ac (VHT20)**  
**For U\_NII-2A, U\_NII-2C Band**

Chan.	Chan. Freq. (MHz)	PSD (dBm/MHz)				Total Power Density (dBm/MHz)	MAX. Limit (dBm/MHz)	Pass / Fail
		Chain 0	Chain 1	Chain 2	Chain 3			
52	5260	-1.34	-1.70	-1.38	-1.45	4.56	5.93	Pass
60	5300	-1.31	-1.74	-1.66	-1.49	4.47	5.93	Pass
64	5320	-1.58	-1.74	-1.61	-1.47	4.42	5.93	Pass
100	5500	-1.29	-1.41	-1.40	-1.69	4.58	5.68	Pass
116	5580	-1.27	-1.37	-1.67	-1.52	4.57	5.68	Pass
140	5700	-1.24	-1.99	-1.81	-2.07	4.26	5.68	Pass
144 (U_NII-2C)	5720	-1.29	-1.91	-1.75	-2.06	4.28	5.68	Pass

- Note:** 1. Method a) of power density measurement of KDB 662911 is using for calculating total power density. Total power density is summing entire spectra across corresponding frequency bins on the various outputs by computer.
2. **For U-NII-2A:** Directional gain =  $10 \log[(10^{G1/20} + 10^{G2/20} + 10^{G3/20} + 10^{G4/20})^2 / 4] = 11.07\text{dBi} > 6\text{dBi}$ , so the power density limit shall be reduced to  $11 - (11.07 - 6) = 5.93\text{dBm}$ .
3. **For U-NII-2C:** Directional gain =  $10 \log[(10^{G1/20} + 10^{G2/20} + 10^{G3/20} + 10^{G4/20})^2 / 4] = 11.32\text{dBi} > 6\text{dBi}$ , so the power density limit shall be reduced to  $11 - (11.32 - 6) = 5.68\text{dBm}$ .

**For U\_NII-3 Band**

TX chain	Chan.	Chan. Freq. (MHz)	PSD		10 log (N=4) dB	Total PSD (dBm/500kHz)	Limit (dBm/500kHz)	Pass /Fail
			(dBm/300kHz)	(dBm/500kHz)				
0	144 (U_NII-3)	5720	-9.78	-7.56	6.02	-1.54	24.58	Pass
1	144 (U_NII-3)	5720	-10.31	-8.09	6.02	-2.07	24.58	Pass
2	144 (U_NII-3)	5720	-10.28	-8.06	6.02	-2.04	24.58	Pass
3	144 (U_NII-3)	5720	-10.49	-8.27	6.02	-2.25	24.58	Pass

- Note:** 1. Directional gain =  $10 \log[(10^{G1/20} + 10^{G2/20} + 10^{G3/20} + 10^{G4/20})^2 / 4] = 11.42\text{dBi} > 6\text{dBi}$ , so the power density limit shall be reduced to  $30 - (11.42 - 6) = 24.58\text{dBm}$ .

**802.11ac (VHT40)**
**For U\_NII-2A, U\_NII-2C Band**

Chan.	Chan. Freq. (MHz)	PSD W/O Duty Factor (dBm/MHz)				Duty Factor (dB)	Total PSD With Duty Factor (dBm/MHz)	MAX. Limit (dBm/MHz)	Pass / Fail
		Chain 0	Chain 1	Chain 2	Chain 3				
54	5270	-1.03	-1.43	-0.94	-1.00	0.16	5.08	5.93	Pass
62	5310	-0.87	-1.47	-0.83	-1.20	0.16	5.09	5.93	Pass
102	5510	-1.49	-1.60	-1.10	-0.93	0.16	4.91	5.68	Pass
110	5550	-1.48	-1.55	-1.34	-1.10	0.16	4.81	5.68	Pass
134	5670	-0.98	-1.16	-1.31	-1.42	0.16	4.96	5.68	Pass
142 (U_NII-2C)	5710	-1.02	-1.63	-1.37	-1.08	0.16	4.91	5.68	Pass

- Note:** 1. Method a) of power density measurement of KDB 662911 is using for calculating total power density. Total power density is summing entire spectra across corresponding frequency bins on the various outputs by computer.
2. **For U-NII-2A:** Directional gain =  $10 \log[(10^{G1/20} + 10^{G2/20} + 10^{G3/20} + 10^{G4/20})^2 / 4] = 11.07 \text{dBi} > 6 \text{dBi}$ , so the power density limit shall be reduced to  $11 - (11.07 - 6) = 5.93 \text{dBm}$ .
3. **For U-NII-2C:** Directional gain =  $10 \log[(10^{G1/20} + 10^{G2/20} + 10^{G3/20} + 10^{G4/20})^2 / 4] = 11.32 \text{dBi} > 6 \text{dBi}$ , so the power density limit shall be reduced to  $11 - (11.32 - 6) = 5.68 \text{dBm}$ .
4. Refer to section 3.3 for duty cycle spectrum plot.

**For U\_NII-3 Band**

TX chain	Chan.	Chan. Freq. (MHz)	PSD W/O Duty Factor		10 log (N=4) dB	Duty Factor (dB)	Total PSD With Duty Factor (dBm/500kHz)	Limit (dBm/500kHz)	Pass /Fail
			(dBm/300kHz)	(dBm/500kHz)					
0	142 (U_NII-3)	5720	-11.54	-9.32	6.02	0.16	-3.14	24.58	Pass
1	142 (U_NII-3)	5720	-11.23	-9.01	6.02	0.16	-2.83	24.58	Pass
2	142 (U_NII-3)	5720	-11.52	-9.30	6.02	0.16	-3.12	24.58	Pass
3	142 (U_NII-3)	5720	-11.32	-9.10	6.02	0.16	-2.92	24.58	Pass

- Note:** 1. Directional gain =  $10 \log[(10^{G1/20} + 10^{G2/20} + 10^{G3/20} + 10^{G4/20})^2 / 4] = 11.42 \text{dBi} > 6 \text{dBi}$ , so the power density limit shall be reduced to  $30 - (11.42 - 6) = 24.58 \text{dBm}$ .
2. Refer to section 3.3 for duty cycle spectrum plot.

### 802.11ac (VHT80)

#### For U\_NII-2A, U\_NII-2C Band

Chan.	Chan. Freq. (MHz)	PSD W/O Duty Factor (dBm/MHz)				Duty Factor (dB)	Total PSD With Duty Factor (dBm/MHz)	MAX. Limit (dBm/MHz)	Pass / Fail
		Chain 0	Chain 1	Chain 2	Chain 3				
58	5290	-2.16	-1.86	-1.88	-2.48	0.24	4.17	5.93	Pass
106	5530	-3.82	-4.59	-3.85	-3.99	0.24	2.21	5.68	Pass
122	5610	-1.63	-1.87	-1.74	-1.78	0.24	4.51	5.68	Pass
138 (U_NII-2C)	5690	-1.49	-2.40	-2.12	-1.68	0.24	4.35	5.68	Pass

- Note:**
- Method a) of power density measurement of KDB 662911 is using for calculating total power density. Total power density is summing entire spectra across corresponding frequency bins on the various outputs by computer.
  - For U-NII-2A:** Directional gain =  $10 \log[(10^{G1/20} + 10^{G2/20} + 10^{G3/20} + 10^{G4/20})^2 / 4] = 11.07\text{dBi} > 6\text{dBi}$ , so the power density limit shall be reduced to  $11 - (11.07 - 6) = 5.93\text{dBm}$ .
  - For U-NII-2C:** Directional gain =  $10 \log[(10^{G1/20} + 10^{G2/20} + 10^{G3/20} + 10^{G4/20})^2 / 4] = 11.32\text{dBi} > 6\text{dBi}$ , so the power density limit shall be reduced to  $11 - (11.32 - 6) = 5.68\text{dBm}$ .
  - Refer to section 3.3 for duty cycle spectrum plot.

#### For U\_NII-3 Band

TX chain	Chan.	Chan. Freq. (MHz)	PSD W/O Duty Factor		10 log (N=4) dB	Duty Factor (dB)	Total PSD With Duty Factor (dBm/500kHz)	Limit (dBm/500kHz)	Pass /Fail
			(dBm/300kHz)	(dBm/500kHz)					
0	138 (U_NII-3)	5690	-13.00	-10.78	6.02	0.24	-4.52	24.58	Pass
1	138 (U_NII-3)	5690	-12.34	-10.12	6.02	0.24	-3.86	24.58	Pass
2	138 (U_NII-3)	5690	-12.50	-10.28	6.02	0.24	-4.02	24.58	Pass
2	138 (U_NII-3)	5690	-12.95	-10.73	6.02	0.24	-4.47	24.58	Pass

- Note:**
- Directional gain =  $10 \log[(10^{G1/20} + 10^{G2/20} + 10^{G3/20} + 10^{G4/20})^2 / 4] = 11.42\text{dBi} > 6\text{dBi}$ , so the power density limit shall be reduced to  $30 - (11.42 - 6) = 24.58\text{dBm}$ .
  - Refer to section 3.3 for duty cycle spectrum plot.

**802.11ac (VHT80+80)**
**For U\_NII-1, U\_NII-2A, U\_NII-2C Band**

Chan.	Chan. Freq. (MHz)	PSD W/O Duty Factor (dBm/MHz)				Duty Factor (dB)	Total PSD With Duty Factor (dBm/MHz)	MAX. Limit (dBm/MHz)	Pass / Fail
		Chain 0	Chain 1	Chain 2	Chain 3				
42+106	5210	1.11	1.09	c	-	0.26	4.37	14.71	Pass
	5530	-	-	0.96	1.63	0.26	4.58	8.38	Pass
42+122	5210	1.11	1.09	-	-	0.26	4.37	14.71	Pass
	5610	-	-	1.05	1.52	0.26	4.56	8.38	Pass
42+ 138(U_NII-2C)+ 138 (U_NII-3)	5210	1.11	1.09	-	-	0.26	4.39	14.71	Pass
	5690	-	-	0.53	2.10	0.26	4.66	8.38	Pass
	5690	Test results refer to U-NII-3 data							
58+106	5290	0.14	0.41	-	-	0.26	3.55	8.95	Pass
	5530	-	-	0.96	1.63	0.26	4.58	8.38	Pass
58+122	5290	0.14	0.41	-	-	0.26	3.55	8.95	Pass
	5610	-	-	1.05	1.52	0.26	4.56	8.38	Pass
58+ 138(U_NII-2C)+ 138 (U_NII-3)	5290	0.14	0.41	-	-	0.26	3.55	8.95	Pass
	5690	-	-	0.53	2.10	0.26	4.66	8.38	Pass
	5690	Test results refer to U-NII-3 data							
58+155	5290	0.14	0.41	-	-	0.26	3.55	8.95	Pass
	5775	Test results refer to U-NII-3 data							
106+ 138(U_NII-2C)+ 138 (U_NII-3)	5530	-2.02	-2.09	-	-	0.26	4.10	5.68	Pass
	5690	-	-	-2.74	-1.92				
	5690	Test results refer to U-NII-3 data							
106+155	5530	-3.61	-3.53	-	-	0.26	-0.30	9.02	Pass
	5775	Test results refer to U-NII-3 data							
122+155	5610	0.96	0.57	-	-	0.26	4.04	9.02	Pass
	5775	Test results refer to U-NII-3 data							
138(U_NII-2C)+ 138 (U_NII-3)+ 155	5690	0.53	0.98	-	-	0.26	4.03	9.02	Pass
	5690	Test results refer to U-NII-3 data							
	5775	Test results refer to U-NII-3 data							
42+58	5210	1.11	1.09	-	-	0.26	4.37	14.71	Pass
	5290	-	-	0.41	0.50	0.26	3.73	8.93	Pass
106+122	5530	-2.02	-2.09	-	-	0.26	4.23	5.68	Pass
	5610	-	-	-2.09	-1.99	0.26			Pass
122+ 138(U_NII-2C)+ 138 (U_NII-3)	5610	-2.26	-2.39	-	-	0.26	3.96	5.68	Pass
	5690	-	-	-2.74	-1.92	0.26			Pass
	5690	Test results refer to U-NII-3 data							

- Note:** 1. Method a) of power density measurement of KDB 662911 is using for calculating total power density. Total power density is summing entire spectra across corresponding frequency bins on the various outputs by computer.
2. **For U-NII-1(chain 0+chain 1):** Directional gain =  $10 \log[(10^{G1/20} + 10^{G2/20})^2 / 2] = 8.29\text{dBi} > 6\text{dBi}$  , so the power density limit shall be reduced to  $17-(8.29-6) = 14.71\text{dBm}$ .
  3. **For U-NII-2A(chain 0+chain 1):** Directional gain =  $10 \log[(10^{G1/20} + 10^{G2/20})^2 / 2] = 8.05\text{dBi} > 6\text{dBi}$  , so the power density limit shall be reduced to  $11-(8.05-6) = 8.95\text{dBm}$ .
  4. **For U-NII-2A(chain 2+chain 3):** Directional gain =  $10 \log[(10^{G1/20} + 10^{G2/20})^2 / 2] = 8.07\text{dBi} > 6\text{dBi}$  , so the power density limit shall be reduced to  $11-(8.07-6) = 8.93\text{dBm}$ .
  5. **For U-NII-2C(chain 0+chain 1):** Directional gain =  $10 \log[(10^{G1/20} + 10^{G2/20})^2 / 2] = 7.98\text{dBi} > 6\text{dBi}$  , so the power density limit shall be reduced to  $11-(7.98-6) = 9.02\text{dBm}$ .
  6. **For U-NII-2C(chain 2+chain 3):** Directional gain =  $10 \log[(10^{G3/20} + 10^{G4/20})^2 / 2] = 8.62\text{dBi} > 6\text{dBi}$  , so the power density limit shall be reduced to  $11-(8.62-6) = 8.38\text{dBm}$ .
  7. **For U-NII-2C(chain 0+chain 1+chain 2+chain 3):** Directional gain =  $10 \log[(10^{G1/20} + 10^{G2/20} + 10^{G3/20} + 10^{G4/20})^2 / 4] = 11.32\text{dBi} > 6\text{dBi}$  , so the power density limit shall be reduced to  $11-(11.32-6) = 5.68\text{dBm}$ .

**For U-NII-3 Band**

Chan	TX chain.	Chan. Freq. (MHz)	PSD W/O Duty Factor		10 log (N=2) dB	Duty Factor (dB)	Total PSD With Duty Factor (dBm/500kHz)	Limit (dBm/500kHz)	Pass /Fail
			(dBm/300kHz)	(dBm/500kHz)					
42 + 138(U_NII-2C) + 138 (U_NII-3)	0	5210	Test results refer to U-NII-1 data						
		5690	Test results refer to U-NII-2C data						
	1	5210	Test results refer to U-NII-1 data						
		5690	Test results refer to U-NII-2C data						
	2	5690	-8.88	-6.66	3.01	0.26	-3.39	27.18	Pass
3	5690	-9.66	-7.44	3.01	0.26	-4.17	27.18	Pass	
Chan	TX chain.	Chan. Freq. (MHz)	PSD W/O Duty Factor		10 log (N=2) dB	Duty Factor (dB)	Total PSD With Duty Factor (dBm/500kHz)	Limit (dBm/500kHz)	Pass /Fail
			(dBm/300kHz)	(dBm/500kHz)					
58 + 138(U_NII-2C) + 138 (U_NII-3)	0	5290	Test results refer to U-NII-2A data						
		5690	Test results refer to U-NII-2C data						
	1	5290	Test results refer to U-NII-2A data						
		5690	Test results refer to U-NII-2C data						
	2	5690	-8.88	-6.66	3.01	0.26	-3.39	27.18	Pass
3	5690	-9.66	-7.44	3.01	0.26	-4.17	27.18	Pass	
Chan	TX chain.	Chan. Freq. (MHz)	PSD W/O Duty Factor		10 log (N=2) dB	Duty Factor (dB)	Total PSD With Duty Factor (dBm/500kHz)	Limit (dBm/500kHz)	Pass /Fail
			(dBm/300kHz)	(dBm/500kHz)					
58+ 155	0	5290	Test results refer to U-NII-2A data						
	1	5290	Test results refer to U-NII-2A data						
	2	5775	-8.28	-6.06	3.01	0.26	-2.79	27.18	Pass
	3	5775	-7.72	-5.50	3.01	0.26	-2.23	27.18	Pass
Chan	TX chain.	Chan. Freq. (MHz)	PSD W/O Duty Factor		10 log (N=2) dB	Duty Factor (dB)	Total PSD With Duty Factor (dBm/500kHz)	Limit (dBm/500kHz)	Pass /Fail
			(dBm/300kHz)	(dBm/500kHz)					
106 + 138(U_NII-2C) + 138 (U_NII-3)	0	5530	Test results refer to U-NII-2C data						
		5690	Test results refer to U-NII-2C data						
	1	5530	Test results refer to U-NII-2C data						
		5690	Test results refer to U-NII-2C data						
	2	5690	-12.41	-10.19	3.01	0.26	-6.92	24.55	Pass
3	5690	-12.61	-10.39	3.01	0.26	-7.12	24.55	Pass	



Chan	TX chain.	Chan. Freq. (MHz)	PSD W/O Duty Factor		10 log (N=2) dB	Duty Factor (dB)	Total PSD With Duty Factor (dBm/500kHz)	Limit (dBm/500kHz)	Pass /Fail
			(dBm/300kHz)	(dBm/500kHz)					
106+ 155	0	5530	Test results refer to U-NII-2C data						
	1	5530	Test results refer to U-NII-2C data						
	2	5775	-8.28	-6.06	3.01	0.26	-2.79	27.18	Pass
	3	5775	-7.72	-5.50	3.01	0.26	-2.23	27.18	Pass
122+ 155	0	5610	Test results refer to U-NII-2C data						
	1	5610	Test results refer to U-NII-2C data						
	2	5775	-8.28	-6.06	3.01	0.26	-2.79	27.18	Pass
	3	5775	-7.72	-5.50	3.01	0.26	-2.23	27.18	Pass
138(U_NII-2C) + 138 (U_NII-3) + 155	0	5690	Test results refer to U-NII-2C data						
		5690	-9.66	-7.44	3.01	0.26	-4.17	27.94	Pass
	1	5690	Test results refer to U-NII-2C data						
		5690	-9.28	-7.06	3.01	0.26	-3.79	27.94	Pass
	2	5775	-8.28	-6.06	3.01	0.26	-2.79	27.18	Pass
	3	5775	-7.72	-5.50	3.01	0.26	-2.23	27.18	Pass
122 + 138(U_NII-2C) + 138 (U_NII-3)	0	5610	Test results refer to U-NII-2C data						
		5690	Test results refer to U-NII-2C data						
	1	5610	Test results refer to U-NII-2C data						
		5690	Test results refer to U-NII-2C data						
	2	5690	-12.41	-10.19	3.01	0.26	-6.92	27.18	Pass
	3	5690	-12.61	-10.39	3.01	0.26	-7.12	27.18	Pass

- Note:**
- For U-NII-3(chain 0+chain 1):** Directional gain =  $10 \log[(10^{G1/20} + 10^{G2/20})^2 / 2] = 8.06\text{dBi} > 6\text{dBi}$  , so the power density limit shall be reduced to  $30-(8.06-6) = 27.94\text{dBm}$ .
  - For U-NII-3(chain 2+chain 3):** Directional gain =  $10 \log[(10^{G3/20} + 10^{G4/20})^2 / 2] = 8.82\text{dBi} > 6\text{dBi}$  , so the power density limit shall be reduced to  $30-(8.82-6) = 27.18\text{dBm}$ .
  - For U-NII-3(chain 0+chain 1+chain 2+chain 3):** Directional gain =  $10 \log[(10^{G1/20} + 10^{G2/20} + 10^{G3/20} + 10^{G4/20})^2 / 4] = 8.82\text{dBi} > 6\text{dBi}$  , so the power density limit shall be reduced to  $30-(8.82-6) = 27.18\text{dBm}$ .
  - Refer to section 3.3 for duty cycle spectrum plot.

For U\_NII-1, U\_NII-2A, U\_NII-2C Band

Spectrum Plot of Worst Value

802.11a / Chain 3 – CH100

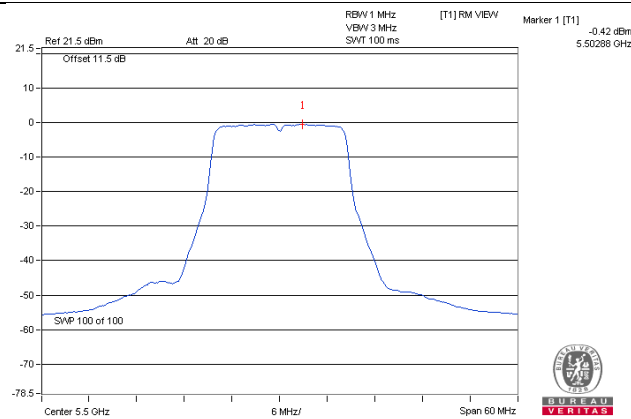

802.11ac (VHT20) / Chain 0 – CH140

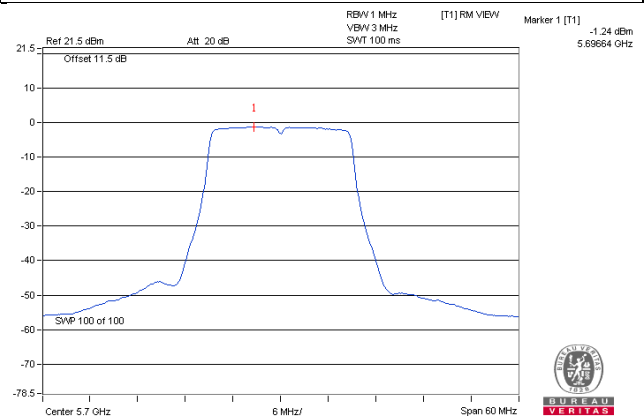

802.11ac (VHT40) / Chain 2 – CH62

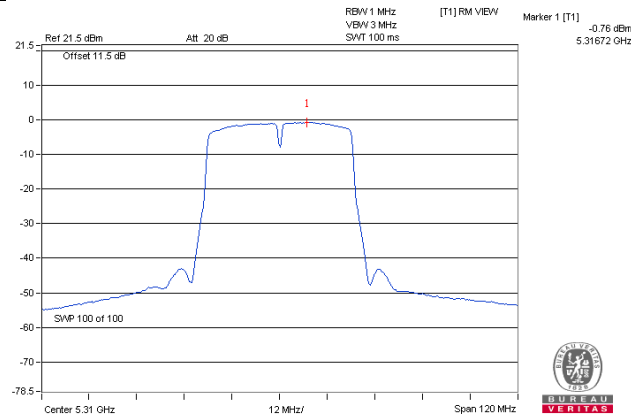

802.11ac (VHT80) / Chain 0- CH138(U\_NII-2C)

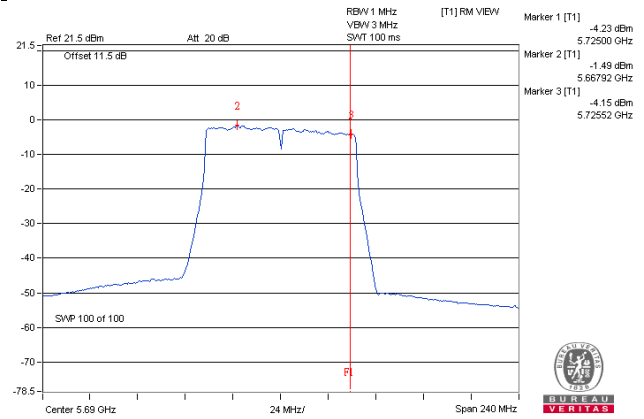

802.11ac (VHT80+80) / Chain 3 CH138(U\_NII-2C)

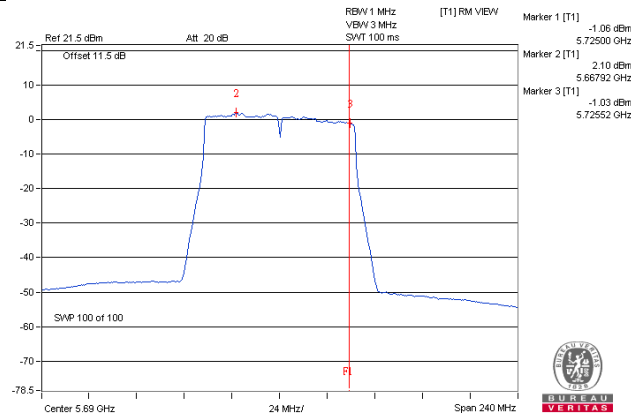

For U\_NII-3 Band

Spectrum Plot of Worst Value

802.11a / Chain 0 – CH144(U\_NII-3)

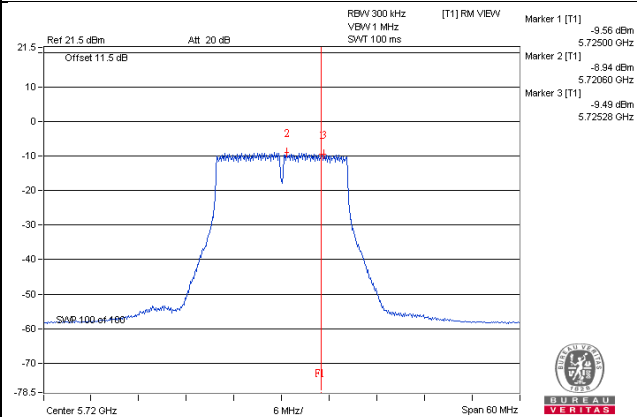

802.11ac (VHT20) / Chain 0 – CH144 (U\_NII-3)

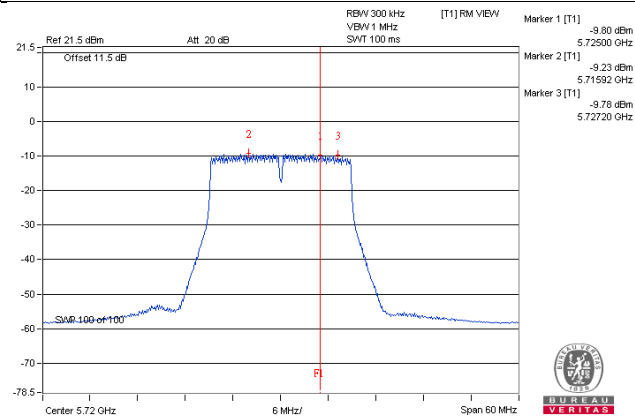

802.11ac (VHT40) / Chain 1– CH142(U\_NII-3)

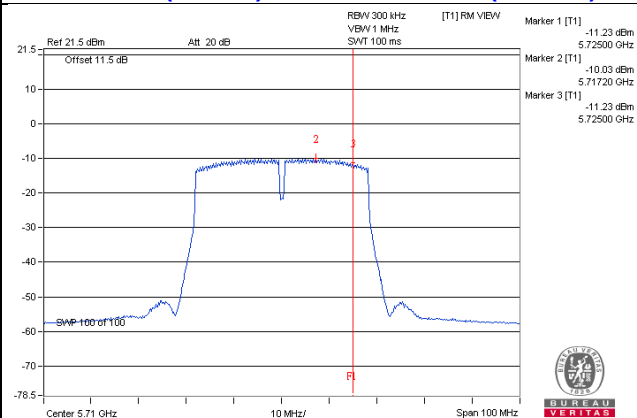

802.11ac (VHT80) / Chain 1 – CH138(U\_NII-3)

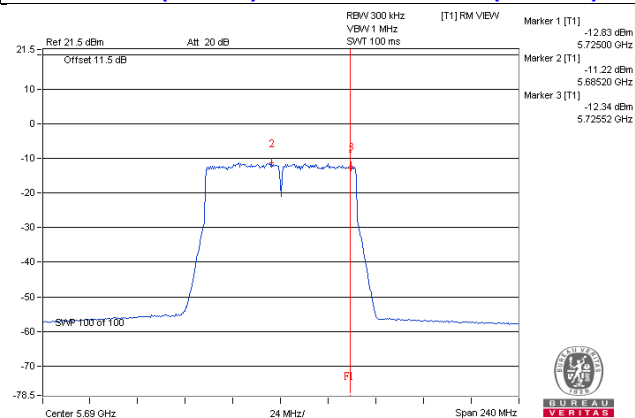

802.11ac (VHT80+80) / Chain 3– CH155(U\_NII-3)

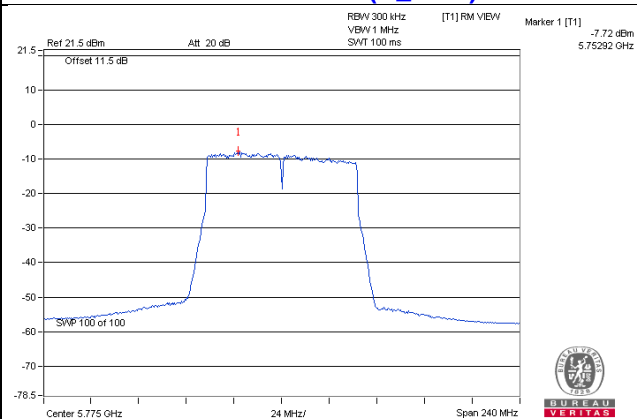

## 4.6 Frequency Stability Measurement

### 4.6.1 Limits of Frequency Stability Measurement

The frequency of the carrier signal shall be maintained within band of operation

### 4.6.2 Test Setup

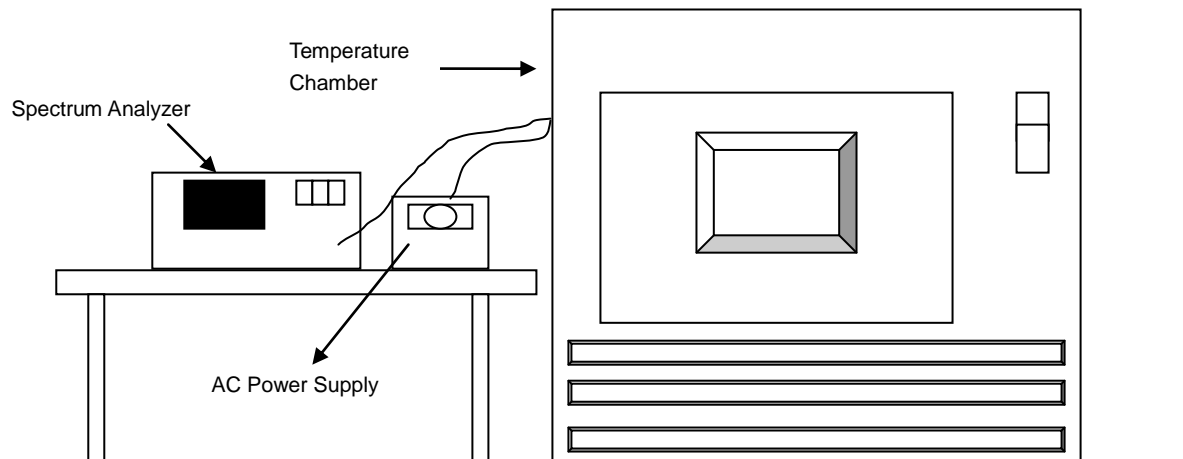

### 4.6.3 Test Instruments

Refer to section 4.1.2 to get information of above instrument.

### 4.6.4 Test Procedure

- The EUT was placed inside the environmental test chamber and powered by nominal AC voltage.
- Turn the EUT on and couple its output to a spectrum analyzer.
- Turn the EUT off and set the chamber to the highest temperature specified.
- Allow sufficient time (approximately 30 min) for the temperature of the chamber to stabilize, turn the EUT on and measure the operating frequency after 2, 5, and 10 Minutes.
- Repeat step 2 and 3 with the temperature chamber set to the lowest temperature.
- The test chamber was allowed to stabilize at +20 degree C for a minimum of 30 Minutes. The supply voltage was then adjusted on the EUT from 85% to 115% and the frequency record.

### 4.6.5 Deviation from Test Standard

No deviation.

### 4.6.6 EUT Operating Condition

Set the EUT transmit at un-modulation mode to test frequency stability.

#### 4.6.7 Test Results

Frequency Stability Versus Temp.									
Operating Frequency: 5260 MHz									
TEMP. (°C)	Power Supply (Vac)	0 Minute		2 Minute		5 Minute		10 Minute	
		Measured Frequency (MHz)	Pass/Fail	Measured Frequency (MHz)	Pass/Fail	Measured Frequency (MHz)	Pass/Fail	Measured Frequency (MHz)	Pass/Fail
50	120	5260.0188	Pass	5260.0164	Pass	5260.0171	Pass	5260.0167	Pass
40	120	5259.9997	Pass	5259.9997	Pass	5260.0023	Pass	5260.0025	Pass
30	120	5259.9927	Pass	5259.9973	Pass	5259.9977	Pass	5259.9969	Pass
20	120	5260.0024	Pass	5260.0056	Pass	5260.0019	Pass	5260.0028	Pass
10	120	5259.9879	Pass	5259.9915	Pass	5259.9879	Pass	5259.9864	Pass
0	120	5260.0104	Pass	5260.0103	Pass	5260.0151	Pass	5260.0129	Pass
-10	120	5259.9743	Pass	5259.9781	Pass	5259.9779	Pass	5259.9776	Pass
-20	120	5260.0195	Pass	5260.024	Pass	5260.02	Pass	5260.0218	Pass
-30	120	5259.9741	Pass	5259.9751	Pass	5259.9739	Pass	5259.9762	Pass

Frequency Stability Versus Voltage									
Operating Frequency: 5260 MHz									
TEMP. (°C)	Power Supply (Vac)	0 Minute		2 Minute		5 Minute		10 Minute	
		Measured Frequency (MHz)	Pass/Fail	Measured Frequency (MHz)	Pass/Fail	Measured Frequency (MHz)	Pass/Fail	Measured Frequency (MHz)	Pass/Fail
20	138	5260.0014	Pass	5260.0063	Pass	5260.0019	Pass	5260.0038	Pass
	120	5260.0024	Pass	5260.0056	Pass	5260.0019	Pass	5260.0028	Pass
	102	5260.0022	Pass	5260.0052	Pass	5260.0012	Pass	5260.0038	Pass

## 4.7 6dB Bandwidth Measurement

### 4.7.1 Limits of 6dB Bandwidth Measurement

The minimum of 6dB Bandwidth Measurement is 0.5MHz.

### 4.7.2 Test Setup

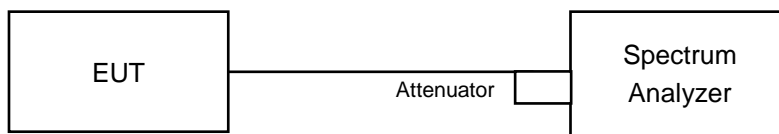

### 4.7.3 Test Instruments

Refer to section 4.1.2 to get information of above instrument.

### 4.7.4 Test Procedure

#### MEASUREMENT PROCEDURE REF

- Set resolution bandwidth (RBW) = 100kHz
- Set the video bandwidth (VBW)  $\geq 3 \times$  RBW, Detector = Peak.
- Trace mode = max hold.
- Sweep = auto couple.
- Measure the maximum width of the emission that is constrained by the frequencies associated with the two amplitude points (upper and lower) that are attenuated by 6 dB relative to the maximum level measured in the fundamental emission

### 4.7.5 Deviation from Test Standard

No deviation.

### 4.7.6 EUT Operating Condition

The software provided by client to enable the EUT under transmission condition continuously at lowest, middle and highest channel frequencies individually.

#### 4.7.7 Test Results

##### 802.11a

Channel	Frequency (MHz)	6dB Bandwidth (MHz)				Minimum Limit (MHz)	Pass / Fail
		Chain 0	Chain 1	Chain 2	Chain 3		
*144 (U_NII-3)	5720	3.16	3.16	3.16	3.16	0.5	Pass

Note: \*The 6dB bandwidth above 5725MHz = Marker 1 + Delta 2 - 5725MHz

##### 802.11ac (VHT20)

Channel	Frequency (MHz)	6dB Bandwidth (MHz)				Minimum Limit (MHz)	Pass / Fail
		Chain 0	Chain 1	Chain 2	Chain 3		
*144 (U_NII-3)	5720	3.78	3.76	3.76	3.77	0.5	Pass

Note: \*The 6dB bandwidth above 5725MHz = Marker 1 + Delta 2 - 5725MHz

##### 802.11ac (VHT40)

Channel	Frequency (MHz)	6dB Bandwidth (MHz)				Minimum Limit (MHz)	Pass / Fail
		Chain 0	Chain 1	Chain 2	Chain 3		
*142 (U_NII-3)	5710	2.57	2.64	2.63	2.62	0.5	Pass

Note: \*The 6dB bandwidth above 5725MHz = Marker 1 + Delta 2 - 5725MHz

##### 802.11ac (VHT80)

Channel	Frequency (MHz)	6dB Bandwidth (MHz)				Minimum Limit (MHz)	Pass / Fail
		Chain 0	Chain 1	Chain 2	Chain 3		
*138 (U_NII-3)	5690	2.69	2.77	2.82	2.70	0.5	Pass

Note: \*The 6dB bandwidth above 5725MHz = Marker 1 + Delta 2 - 5725MHz

**802.11ac (VHT80+80)**

Channel	Frequency (MHz)	6dB Bandwidth (MHz)				Minimum Limit (MHz)	Pass / Fail
		Chain 0	Chain 1	Chain 2	Chain 3		
42+ 138 (U_NII-2C)+ *138 (U_NII-3)	5210	-					
	5690	-					
	5690	-	-	2.75	2.68	0.5	Pass
58+ 138 (U_NII-2C)+ *138 (U_NII-3)	5290	-					
	5690	-					
	5690	-	-	2.75	2.68	0.5	Pass
58+155	5290	-					
	5775	-	-	75.62	75.53	0.5	Pass
106+ 138 (U_NII-2C)+ *138 (U_NII-3)	5530	-					
	5690	-					
	5690	-	-	2.77	2.68	0.5	Pass
106+155	5530	-					
	5775	-	-	75.62	75.53	0.5	Pass
122+155	5610	-					
	5775	-	-	75.62	75.53	0.5	Pass
138 (U_NII-2C)+ *138 (U_NII-3)+ 155	5690	-					
	5690	2.72	2.69	-	-	0.5	Pass
	5775	-	-	75.62	75.53	0.5	Pass
122+ 138 (U_NII-2C)+ *138 (U_NII-3)	5610	-					
	5690	-					
	5690	-	-	2.77	2.68	0.5	Pass

Note: \*The 6dB bandwidth above 5725MHz = Marker 1 + Delta 2 - 5725MHz



Spectrum Plot of Worst Value

802.11a / Chain 2 - CH144 (U\_NII-3)

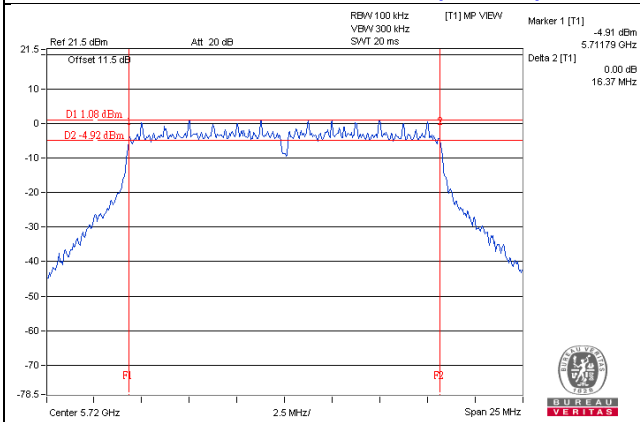

802.11ac (VHT20) / Chain 2 - CH144 (U\_NII-3)

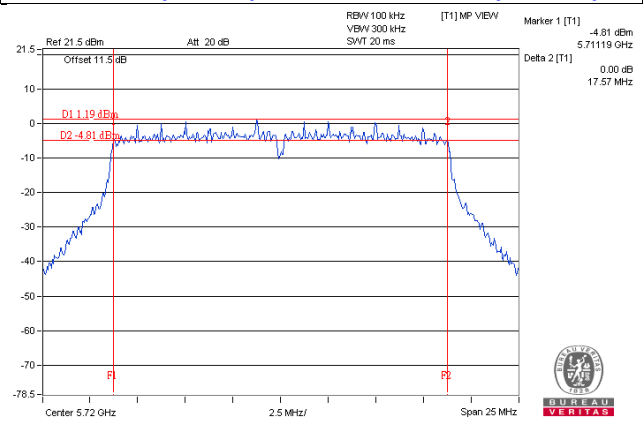

802.11ac (VHT40) / Chain 0 - CH142 (U\_NII-3)

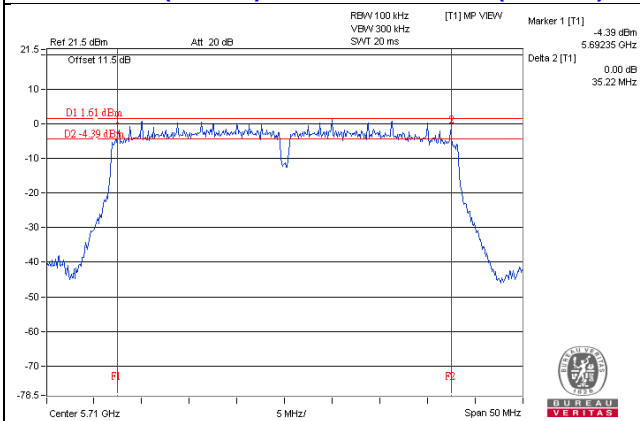

802.11ac (VHT80) / Chain 0 - CH138 (U\_NII-3)

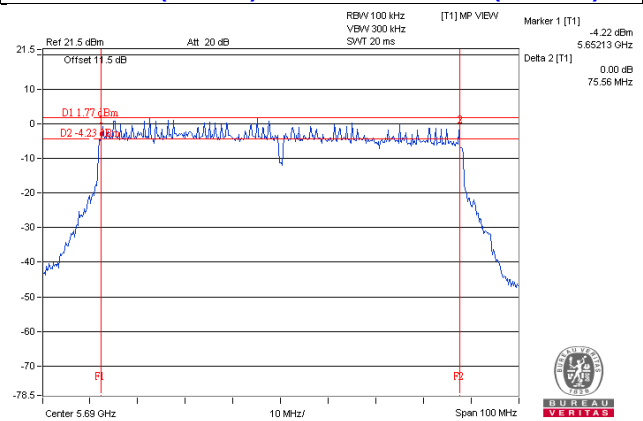

802.11ac (VHT80+80) / Chain 3 - CH138 (U\_NII-3)

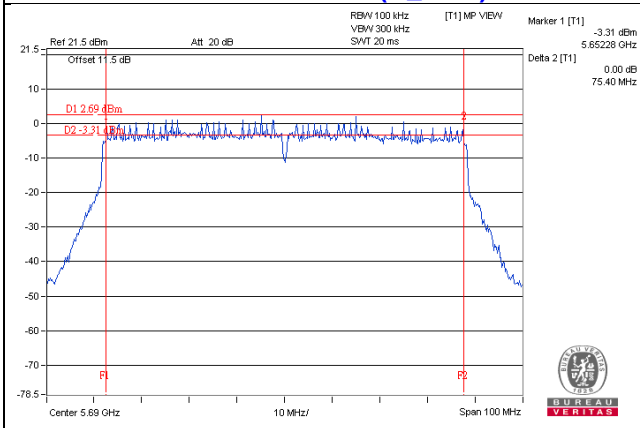

## 4.8 26dB Bandwidth Measurement

### 4.8.1 Test Setup

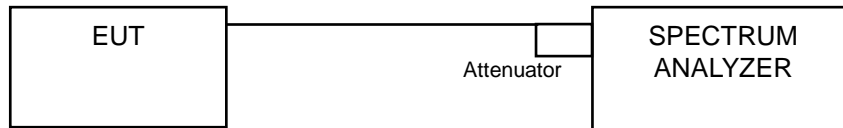

### 4.8.2 Test Instruments

Refer to section 4.1.2 to get information of above instrument.

### 4.8.3 Test Procedure

1. Set RBW = approximately 1% of the emission bandwidth.
2. Set the VBW > RBW.
3. Detector = Peak.
4. Trace mode = max hold.
5. Measure the maximum width of the emission that is 26 dB down from the peak of the emission. Compare this with the RBW setting of the analyzer. Readjust RBW and repeat measurement as needed until the RBW/EBW ratio is approximately 1%.

### 4.8.4 Deviation from Test Standard

No deviation.

### 4.8.5 EUT Operating Condition

The software provided by client to enable the EUT under transmission condition continuously at lowest, middle and highest channel frequencies individually.

## 4.8.6 Test Results

## 802.11a

Channel	Channel Frequency (MHz)	26dB Bandwidth (MHz)			
		Chain 0	Chain 1	Chain 2	Chain 3
52	5260	19.75	19.92	19.82	19.85
60	5300	19.94	19.81	20.03	20.00
64	5320	20.30	19.87	19.88	19.84
100	5500	20.12	20.06	20.02	20.30
116	5580	20.07	20.04	20.00	19.94
140	5700	19.98	19.99	20.33	19.95
144 (U_NII-2C)	5720	15.16	15.19	15.21	15.18
144 (U_NII-3)	5720	4.87	5.15	4.83	4.89

## 802.11ac (VHT20)

Channel	Channel Frequency (MHz)	26dB Bandwidth (MHz)			
		Chain 0	Chain 1	Chain 2	Chain 3
52	5260	20.60	20.62	20.61	20.78
60	5300	20.77	20.71	20.60	20.73
64	5320	20.56	20.68	20.71	20.66
100	5500	20.64	20.77	20.72	21.04
116	5580	20.84	20.68	20.67	20.63
140	5700	20.78	20.76	20.80	20.88
144 (U_NII-2C)	5720	15.31	15.30	15.36	15.20
144 (U_NII-3)	5720	5.46	5.51	5.52	5.47

## 802.11ac (VHT40)

Channel	Channel Frequency (MHz)	26dB Bandwidth (MHz)			
		Chain 0	Chain 1	Chain 2	Chain 3
54	5270	40.89	40.86	40.74	40.75
62	5310	40.87	40.86	40.85	40.89
102	5510	40.77	40.81	40.78	40.77
110	5550	40.88	40.87	40.86	41.01
134	5670	41.12	40.93	41.17	40.80
142 (U_NII-2C)	5710	35.44	35.39	35.39	35.52
142 (U_NII-3)	5710	5.50	5.49	5.45	5.48

**802.11ac (VHT80)**

Channel	Channel Frequency (MHz)	26dB Bandwidth (MHz)			
		Chain 0	Chain 1	Chain 2	Chain 3
58	5290	85.27	84.83	84.97	85.31
106	5530	84.50	84.75	83.97	84.80
122	5610	84.73	85.23	85.02	84.92
138 (U_NII-2C)	5690	77.68	77.75	78.04	78.10
138 (U_NII-3)	5690	6.83	7.44	7.19	7.05

**802.11ac (VHT80+80)**

Channel	Channel Frequency (MHz)	26dB Bandwidth (MHz)			
		Chain 0	Chain 1	Chain 2	Chain 3
42+106	5210	84.80	84.99	-	-
	5530	-	-	84.77	84.47
42+122	5210	84.80	84.99	-	-
	5610	-	-	85.13	84.57
42+ 138 (U_NII-2C)+ 138 (U_NII-3)	5210	84.80	84.99	-	-
	5690	-	-	77.73	78.13
	5690	-	-	7.24	7.30
58+106	5290	85.31	85.32	-	-
	5530	-	-	84.77	84.47
58+122	5290	85.31	85.32	-	-
	5610	-	-	85.13	84.57
58+ 138 (U_NII-2C)+ 138 (U_NII-3)	5290	85.31	85.32	-	-
	5690	-	-	77.73	78.13
	5690	-	-	7.24	7.30
58+155	5290	85.31	85.32	-	-
	5775	-	-	85.04	85.10
106+ 138(U_NII-2C)+ +138(U_NII-3)	5530	84.56	84.96	-	-
	5690	-	-	78.00	77.51
	5690	-	-	7.20	7.47
106+155	5530	84.99	85.22	-	-
	5775	-	-	85.04	85.10
122+155	5610	85.13	84.96	-	-
	5775	-	-	85.04	85.10
138 (U_NII-2C)+ 138(U_NII-3)+ 155	5690	77.96	77.60	-	-
	5690	7.11	7.46	-	-
	5775	-	-	85.04	85.10

Channel	Channel Frequency (MHz)	26dB Bandwidth (MHz)			
		Chain 0	Chain 1	Chain 2	Chain 3
42+58	5210	84.80	84.99	-	-
	5290	-	-	85.18	85.38
106+122	5530	84.56	84.96	-	-
	5610	-	-	84.87	85.16
58+ 138 (U_NII-2C)+ 138 (U_NII-3)	5610	84.46	85.02	-	-
	5690	-	-	78.00	77.51
	5690	-	-	7.20	7.47

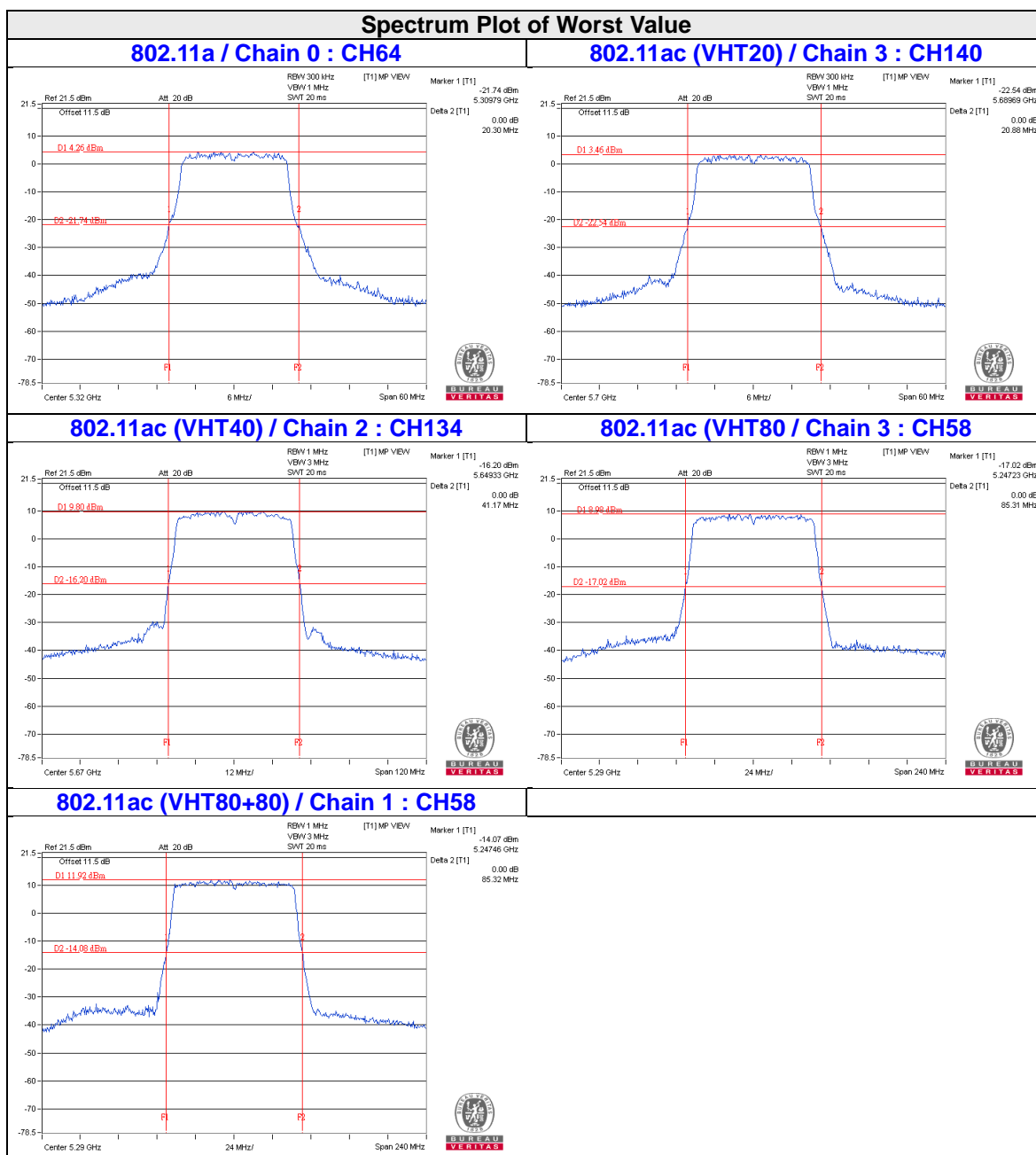

## 5 Pictures of Test Arrangements

Please refer to the attached file (Test Setup Photo).

## Appendix – Information on the Testing Laboratories

We, Bureau Veritas Consumer Products Services (H.K.) Ltd., Taoyuan Branch, were founded in 1988 to provide our best service in EMC, Radio, Telecom and Safety consultation. Our laboratories are accredited and approved according to ISO/IEC 17025.

If you have any comments, please feel free to contact us at the following:

**Linko EMC/RF Lab**

Tel: 886-2-26052180

Fax: 886-2-26051924

**Hsin Chu EMC/RF/Telecom Lab**

Tel: 886-3-6668565

Fax: 886-3-6668323

**Hwa Ya EMC/RF/Safety Lab**

Tel: 886-3-3183232

Fax: 886-3-3270892

**Email:** [service.adt@tw.bureauveritas.com](mailto:service.adt@tw.bureauveritas.com)

**Web Site:** [www.bureauveritas-adt.com](http://www.bureauveritas-adt.com)

The address and road map of all our labs can be found in our web site also.

--- END ---