

FCC Test Report

Report No.: RF160530E01-1

FCC ID: 2AD8UFZCW14A1

Test Model: WI4A-AC400i

Received Date: May 30, 2016

Test Date: June 21 to Aug. 18, 2016

Issued Date: Sep. 30, 2016

Applicant: Nokia Solutions and Networks.OY

Address: 1455 West Shure Drive, Arlington Heights, IL 60004, USA

Issued By: Bureau Veritas Consumer Products Services (H.K.) Ltd., Taoyuan Branch
Hsin Chu Laboratory

Lab Address: E-2, No.1, Li Hsin 1st Road, Hsinchu Science Park, Hsinchu City 300,
Taiwan R.O.C.

Test Location (1): E-2, No.1, Li Hsin 1st Road, Hsinchu Science Park, Hsinchu City 300,
Taiwan R.O.C.

Test Location (2): No. 49, Ln. 206, Wende Rd., Shangshan Tsuen, Chiung Lin Hsiang, Hsin
Chu Hsien 307, Taiwan R.O.C.



This report is for your exclusive use. Any copying or replication of this report to or for any other person or entity, or use of our name or trademark, is permitted only with our prior written permission. This report sets forth our findings solely with respect to the test samples identified herein. The results set forth in this report are not indicative or representative of the quality or characteristics of the lot from which a test sample was taken or any similar or identical product unless specifically and expressly noted. Our report includes all of the tests requested by you and the results thereof based upon the information that you provided to us. You have 60 days from date of issuance of this report to notify us of any material error or omission caused by our negligence, provided, however, that such notice shall be in writing and shall specifically address the issue you wish to raise. A failure to raise such issue within the prescribed time shall constitute your unqualified acceptance of the completeness of this report, the tests conducted and the correctness of the report contents. Unless specific mention, the uncertainty of measurement has been explicitly taken into account to declare the compliance or non-compliance to the specification. The report must not be used by the client to claim product certification, approval, or endorsement by TAF or any government agencies.

Table of Contents

Release Control Record	4
1 Certificate of Conformity	5
2 Summary of Test Results	6
2.1 Measurement Uncertainty	6
2.2 Modification Record	6
3 General Information	7
3.1 General Description of EUT	7
3.2 Description of Test Modes	11
3.2.1 Test Mode Applicability and Tested Channel Detail	12
3.3 Duty Cycle of Test Signal	15
3.4 Description of Support Units	16
3.4.1 Configuration of System under Test	17
3.5 General Description of Applied Standard	19
4 Test Types and Results	20
4.1 Radiated Emission and Bandedge Measurement	20
4.1.1 Limits of Radiated Emission and Bandedge Measurement	20
4.1.2 Test Instruments	21
4.1.3 Test Procedure	23
4.1.4 Deviation from Test Standard	23
4.1.5 Test Setup	24
4.1.6 EUT Operating Condition	24
4.1.7 Test Results (Mode 1)	25
4.1.8 Test Results (Mode 2)	46
4.2 Conducted Emission Measurement	47
4.2.1 Limits of Conducted Emission Measurement	47
4.2.2 Test Instruments	47
4.2.3 Test Procedure	48
4.2.4 Deviation from Test Standard	48
4.2.5 Test Setup	48
4.2.6 EUT Operating Condition	48
4.2.7 Test Results (Mode 1)	49
4.2.8 Test Results (Mode 2)	51
4.3 Transmit Power Measurement	53
4.3.1 Limits of Transmit Power Measurement	53
4.3.2 Test Setup	53
4.3.3 Test Instruments	53
4.3.4 Test Procedure	54
4.3.5 Deviation from Test Standard	54
4.3.6 EUT Operating Condition	54
4.3.7 Test Result	55
4.4 Occupied Bandwidth Measurement	59
4.4.1 Test Setup	59
4.4.2 Test Instruments	59
4.4.3 Test Procedure	59
4.5 Peak Power Spectral Density Measurement	65
4.5.1 Limits of Peak Power Spectral Density Measurement	65
4.5.2 Test Setup	65
4.5.3 Test Instruments	65
4.5.4 Test Procedure	66
4.5.5 Deviation from Test Standard	66
4.5.6 EUT Operating Condition	66
4.5.7 Test Results	67
4.6 Frequency Stability Measurement	73

4.6.1	Limits of Frequency Stability Measurement	73
4.6.2	Test Setup.....	73
4.6.3	Test Instruments	73
4.6.4	Test Procedure	73
4.6.5	Deviation from Test Standard	74
4.6.6	EUT Operating Condition	74
4.6.7	Test Results	75
4.7	6dB Bandwidth Measurement.....	76
4.7.1	Limits of 6dB Bandwidth Measurement.....	76
4.7.2	Test Setup.....	76
4.7.3	Test Instruments	76
4.7.4	Test Procedure	76
4.7.5	Deviation from Test Standard	76
4.7.6	EUT Operating Condition	76
4.7.7	Test Results	77
4.8	26dB Bandwidth Measurement.....	79
4.8.1	Test Setup.....	79
4.8.2	Test Instruments	79
4.8.3	Test Procedure	79
4.8.4	Deviation from Test Standard	79
4.8.5	EUT Operating Condition	79
4.8.6	Test Results	80
5	Pictures of Test Arrangements.....	82
	Annex A- Radiated Out of Band Emission (OOBE) Measurement (For U-NII-3 band).....	83
	Appendix – Information on the Testing Laboratories	87

Release Control Record

Issue No.	Description	Date Issued
RF160530E01-1	Original release.	Sep. 30, 2016

1 Certificate of Conformity

Product: Wireless Access Point

Brand: NOKIA

Test Model: WI4A-AC400i

Sample Status: ENGINEERING SAMPLE

Applicant: Nokia Solutions and Networks.OY

Test Date: June 21 to Aug. 18, 2016

Standard: 47 CFR FCC Part 15, Subpart E (Section 15.407)
ANSI C63.10: 2013

The above equipment has been tested by **Bureau Veritas Consumer Products Services (H.K.) Ltd., Taoyuan Branch**, and found compliance with the requirement of the above standards. The test record, data evaluation & Equipment Under Test (EUT) configurations represented herein are true and accurate accounts of the measurements of the sample's EMC characteristics under the conditions specified in this report.

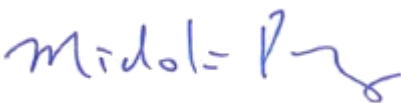
Prepared by :  , **Date:** Sep. 30, 2016
Midoli Peng / Specialist

Approved by :  , **Date:** Sep. 30, 2016
May Chen / Manager

2 Summary of Test Results

47 CFR FCC Part 15, Subpart E (SECTION 15.407)				
FCC Clause	FCC KDB 789033	Test Item	Result	Remarks
15.407(b)(6)	-	AC Power Conducted Emissions	Pass	Meet the requirement of limit. Minimum passing margin is -5.08dB at 24.00000MHz.
15.407(b)(1/2/3/4(i/ii)/6)	Section G	Radiated Emissions & Band Edge Measurement*	PASS	Meet the requirement of limit. Minimum passing margin is -0.6dB at 5138.00MHz.
15.407(a)(1/2/3)	Section E.3	Transmit Output Power	PASS	Meet the requirement of limit.
15.407(a)(1/2/3)	Section F	Peak Power Spectral Density	PASS	Meet the requirement of limit.
15.407(e)	Section C.2	6dB bandwidth	PASS	Meet the requirement of limit. (U-NII-3 Band only)
-	Section D	Occupied Bandwidth Measurement	PASS	Meet the requirement.
15.407(g)	-	Frequency Stability	PASS	Meet the requirement of limit.
15.203	-	Antenna Requirement	Pass	Antenna connector is I-PEX not a standard connector.

NOTE: * For U-NII-3 band compliance with rule part 15.407(b)(4)(i), the OOB test plots were recorded in Annex A.

2.1 Measurement Uncertainty

Where relevant, the following measurement uncertainty levels have been estimated for tests performed on the EUT as specified in CISPR 16-4-2:

Measurement	Frequency	Expanded Uncertainty (k=2) (±)
Conducted Emissions at mains ports	150kHz ~ 30MHz	1.83 dB
Radiated Emissions up to 1 GHz	30MHz ~ 1GHz	5.31 dB
Radiated Emissions above 1 GHz	1GHz ~ 6GHz	3.40 dB
	6GHz ~ 18GHz	3.73 dB
	18GHz ~ 40GHz	4.11 dB

2.2 Modification Record

There were no modifications required for compliance.

3 General Information

3.1 General Description of EUT

Product	Wireless Access Point
Brand	NOKIA
Test Model	WI4A-AC400i
Test Sample S/N	NH162800087
Hardware Version	AM2
Status of EUT	ENGINEERING SAMPLE
Power Supply Rating	12Vdc from power adapter or 54Vdc from POE
Modulation Type	64QAM, 16QAM, QPSK, BPSK for OFDM 256QAM for OFDM in 11ac mode
Modulation Technology	OFDM
Transfer Rate	802.11a: up to 54Mbps 802.11n: up to 600Mbps 802.11ac: up to 1733.3Mbps
Operating Frequency	5.18 ~ 5.24GHz and 5.745 ~ 5.825GHz
Number of Channel	802.11a, 802.11n (HT20), 802.11ac (VHT20): 9 802.11n (HT40), 802.11ac (VHT40): 4 802.11ac (VHT80): 2 802.11ac (VHT80+80): 2
Output Power	5.18GHz ~ 5.24GHz: CDD Mode: 534.298mW Beamforming Mode: 283.263mW 5.745GHz ~ 5.825GHz: CDD Mode: 951.593mW Beamforming Mode: 280.374mW
Antenna Type	Refer to Note
Antenna Connector	Refer to Note
Accessory Device	Adapter x1
Data Cable Supplied	NA

Note:

1. The antennas provided to the EUT, please refer to the following table:

WLAN – 5GHz Antenna spec.

Antenna No	PCB Chain No.	Brand	Model	Antenna Type	Gain(dBi)	Frequency (MHz)
1	Chain 2	Galtronics	02102140-06226A1	PIFA	3.81	5150
					3.71	5250
					4.06	5350
					5.83	5725
					6.21	5825
2	Chain 3	Galtronics	02102140-06226A2	PIFA	5.67	5150
					5.95	5250
					5.83	5350
					5.38	5725
					5.38	5825
3	Chain 1	Galtronics	02102140-06226A3	PIFA	5.69	5150
					5.41	5250
					5.2	5350
					4.92	5725
					5.07	5825
4	Chain 0	Galtronics	02102140-06226A4	PIFA	4.85	5150
					4.66	5250
					4.32	5350
					5.02	5725
					4.87	5825

Cable Spec.

Antenna No	Brand	Model	Connector Type	Cable Loss(dB)	Cable Length (mm)
1	Galtronics	RG-137	i-pex(MHF)	1.5	175
2	Galtronics	RG-137	i-pex(MHF)	1.3	130
3	Galtronics	RG-137	i-pex(MHF)	0.5	50
4	Galtronics	RG-137	i-pex(MHF)	0.8	75

2. Simultaneously transmission condition.

Condition	Technology	
1	WLAN (2.4GHz)	WLAN (5GHz)

3. The EUT incorporates a MIMO function.

5GHz Band			
MODULATION MODE	DATA RATE (MCS)	TX & RX CONFIGURATION	
802.11a	6 ~ 54Mbps	4TX	4RX
802.11n (HT20)	MCS 0~7	4TX	4RX
	MCS 8~15		
	MCS16~23		
	MCS 24~31		
802.11n (HT40)	MCS 0~7	4TX	4RX
	MCS 8~15		
	MCS16~23		
	MCS 24~31		
802.11ac (VHT20)	MCS 0~8, Nss=1	4TX	4RX
	MCS 0~8, Nss=2		
	MCS 0~9, Nss=3		
	MCS 0~8, Nss=4		
802.11ac (VHT40)	MCS 0~9, Nss=1	4TX	4RX
	MCS 0~9, Nss=2		
	MCS 0~9, Nss=3		
	MCS 0~9, Nss=4		
802.11ac (VHT80)	MCS 0~9, Nss=1	4TX	4RX
	MCS 0~9, Nss=2		
	MCS 0~9, Nss=3		
	MCS 0~9, Nss=4		
802.11ac (VHT80+VHT80) noncontiguous	MCS 0~9, Nss=1	4TX	4RX
	MCS 0~9, Nss=2	4TX	4RX

Note:

- All of modulation mode support beamforming function except 802.11a modulation mode.
- The modulation and bandwidth are similar for 802.11n mode for 20MHz (40MHz) and 802.11ac mode for 20MHz (40MHz), therefore investigated worst case to representative mode in test report. (Final test mode refer section 3.2.1)

4. The EUT was tested in both DC powered and PoE powered modes of operation using the representative AC/DC power converter and PoE injector listed below:

POE		
Brand	Model No.	Spec.
UE	PoE35-54A	Input: 100-240V, 1.0A, 50/60Hz AC input cable(1.0m, unshielded) Output: 54V, 0.65A
Adapter		
Brand	Model No.	Spec.
UE	UES36-120300SPA	Input: 100-240V, 1.0A, 50/60Hz AC input cable(1.5m, unshielded) Output: 12V, 3.0A DC output cable(1.0m, unshielded, with one core)

5. The EUT was pre-tested under following test modes :

Test Mode	Description
Mode 1	With POE
Mode 2	With adapter

For the above modes, the worst radiated emission (above 1GHz) test was found in **Mode 1**. Therefore only the test data of the modes were recorded in this report.

6. The above EUT information is declared by manufacturer and for more detailed features description, please refer to the manufacturer's specifications or user's manual.

3.2 Description of Test Modes

FOR 5180 ~ 5240MHz:

4 channels are provided for 802.11a, 802.11n (HT20), 802.11ac (VHT20):

Channel	Frequency	Channel	Frequency
36	5180 MHz	44	5220 MHz
40	5200 MHz	48	5240 MHz

2 channels are provided for 802.11n (HT40), 802.11ac (VHT40):

Channel	Frequency	Channel	Frequency
38	5190 MHz	46	5230 MHz

1 channel is provided for 802.11ac (VHT80):

Channel	Frequency
42	5210MHz

FOR 5745 ~ 5825MHz:

5 channels are provided for 802.11a, 802.11n (HT20), 802.11ac (VHT20):

Channel	Frequency	Channel	Frequency
149	5745MHz	161	5805MHz
153	5765MHz	165	5825MHz
157	5785MHz		

2 channels are provided for 802.11n (HT40), 802.11ac (VHT40):

Channel	Frequency	Channel	Frequency
151	5755MHz	159	5795MHz

1 channel is provided for 802.11ac (VHT80):

Channel	Frequency
155	5775MHz

2 channels are provided for 802.11ac (VHT80+80):

Channel	Frequency	Channel	Frequency
42	5210MHz	155	5775MHz

3.2.1 Test Mode Applicability and Tested Channel Detail

EUT CONFIGURE MODE	APPLICABLE TO				DESCRIPTION
	RE \geq 1G	RE<1G	PLC	APCM	
1	√	√	√	√	With POE
2	-	√	√	-	With adapter

Where RE \geq 1G: Radiated Emission above 1GHz & Bandedge Measurement
 RE<1G: Radiated Emission below 1GHz
 PLC: Power Line Conducted Emission
 APCM: Antenna Port Conducted Measurement

NOTE: "-" means no effect.

Radiated Emission Test (Above 1GHz):

- Pre-Scan has been conducted to determine the worst-case mode from all possible combinations between available modulations, data rates and antenna ports (if EUT with antenna diversity architecture).
- Following channel(s) was (were) selected for the final test as listed below.

CDD Mode						
Mode	FREQ. Band (MHz)	Available Channel	Tested Channel	Modulation Technology	Modulation Type	Data Rate (Mbps)
802.11a	5180-5240	36 to 48	36, 40, 48	OFDM	BPSK	6
802.11ac (VHT20)		36 to 48	36, 40, 48	OFDM	BPSK	6.5
802.11ac (VHT40)		38 to 46	38, 46	OFDM	BPSK	13.5
802.11ac (VHT80)		42	42	OFDM	BPSK	29.3
802.11a	5745-5825	149 to 165	149, 157, 165	OFDM	BPSK	6
802.11ac (VHT20)		149 to 165	149, 157, 165	OFDM	BPSK	6.5
802.11ac (VHT40)		151 to 159	151, 159	OFDM	BPSK	13.5
802.11ac (VHT80)		155	155	OFDM	BPSK	29.3
802.11ac (VHT80+80)	5180-5240 & 5745-5825	42	42	OFDM	BPSK	58.5
		155	155	OFDM	BPSK	58.5

Radiated Emission Test (Below 1GHz):

- Pre-Scan has been conducted to determine the worst-case mode from all possible combinations between available modulations, data rates and antenna ports (if EUT with antenna diversity architecture).
- Following channel(s) was (were) selected for the final test as listed below.

CDD Mode						
Mode	FREQ. Band (MHz)	Available Channel	Tested Channel	Modulation Technology	Modulation Type	Data Rate (Mbps)
802.11ac (VHT20)	5180-5240	36 to 48	165	OFDM	BPSK	6.5
	5745-5825	149 to 165				

Power Line Conducted Emission Test:

- Pre-Scan has been conducted to determine the worst-case mode from all possible combinations between available modulations, data rates and antenna ports (if EUT with antenna diversity architecture).
- Following channel(s) was (were) selected for the final test as listed below.

CDD Mode						
Mode	FREQ. Band (MHz)	Available Channel	Tested Channel	Modulation Technology	Modulation Type	Data Rate (Mbps)
802.11ac (VHT20)	5180-5240	36 to 48	165	OFDM	BPSK	6.5
	5745-5825	149 to 165				

Antenna Port Conducted Measurement:

- This item includes all test value of each mode, but only includes spectrum plot of worst value of each mode.
- Pre-Scan has been conducted to determine the worst-case mode from all possible combinations between available modulations, data rates and antenna ports (if EUT with antenna diversity architecture).
- Following channel(s) was (were) selected for the final test as listed below.

CDD Mode						
Mode	FREQ. Band (MHz)	Available Channel	Tested Channel	Modulation Technology	Modulation Type	Data Rate (Mbps)
802.11a	5180-5240	36 to 48	36, 40, 48	OFDM	BPSK	6
802.11ac (VHT20)		36 to 48	36, 40, 48	OFDM	BPSK	6.5
802.11ac (VHT40)		38 to 46	38, 46	OFDM	BPSK	13.5
802.11ac (VHT80)		42	42	OFDM	BPSK	29.3
802.11a	5745-5825	149 to 165	149, 157, 165	OFDM	BPSK	6
802.11ac (VHT20)		149 to 165	149, 157, 165	OFDM	BPSK	6.5
802.11ac (VHT40)		151 to 159	151, 159	OFDM	BPSK	13.5
802.11ac (VHT80)		155	155	OFDM	BPSK	29.3
802.11ac (VHT80+80)	5180-5240 & 5745-5825	42	42	OFDM	BPSK	58.5
		155	155	OFDM	BPSK	58.5
Beamforming Mode (Output power only)						
Mode	FREQ. Band (MHz)	Available Channel	Tested Channel	Modulation Technology	Modulation Type	Data Rate (Mbps)
802.11ac (VHT20)	5180-5240	36 to 48	36, 40, 48	OFDM	BPSK	6.5
802.11ac (VHT40)		38 to 46	38, 46	OFDM	BPSK	13.5
802.11ac (VHT80)		42	42	OFDM	BPSK	29.3
802.11ac (VHT20)	5745-5825	149 to 165	149, 157, 165	OFDM	BPSK	6.5
802.11ac (VHT40)		151 to 159	151, 159	OFDM	BPSK	13.5
802.11ac (VHT80)		155	155	OFDM	BPSK	29.3
802.11ac (VHT80+80)	5180-5240 & 5745-5825	42	42	OFDM	BPSK	58.5
		155	155	OFDM	BPSK	58.5

Test Condition:

Input Power to POE

Applicable To	Environmental Conditions	Input Power	Tested By
RE \geq 1G	25deg. C, 65%RH	120Vac, 60Hz	Jyunchun Lin
RE<1G	24deg. C, 62%RH	120Vac, 60Hz	Jyunchun Lin
PLC	25deg. C, 61%RH	120Vac, 60Hz	Jyunchun Lin
APCM	25deg. C, 60%RH	120Vac, 60Hz	Robert Cheng

Input Power to Adapter

Applicable To	Environmental Conditions	Input Power	Tested By
RE<1G	24deg. C, 62%RH	120Vac, 60Hz	Jyunchun Lin
PLC	25deg. C, 61%RH	120Vac, 60Hz	Jyunchun Lin

3.3 Duty Cycle of Test Signal

If duty cycle of test signal is $\geq 98\%$, duty factor is not required.

If duty cycle of test signal is $< 98\%$, duty factor shall be considered.

802.11a: Duty cycle = $2.057 \text{ ms} / 2.135 \text{ ms} = 0.963$, Duty factor = $10 * \log(1/0.963) = 0.16$

802.11ac (VHT20): Duty cycle = $5.002 \text{ ms} / 5.087 \text{ ms} = 0.983$

802.11ac (VHT40): Duty cycle = $2.426 \text{ ms} / 2.515 \text{ ms} = 0.965$, Duty factor = $10 * \log(1/0.965) = 0.16$

802.11ac (VHT80): Duty cycle = $1.147 \text{ ms} / 1.212 \text{ ms} = 0.946$, Duty factor = $10 * \log(1/0.946) = 0.24$

802.11ac (VHT80+80): Duty cycle = $1.144 \text{ ms} / 1.215 \text{ ms} = 0.942$, Duty factor = $10 * \log(1/0.942) = 0.26$

802.11a

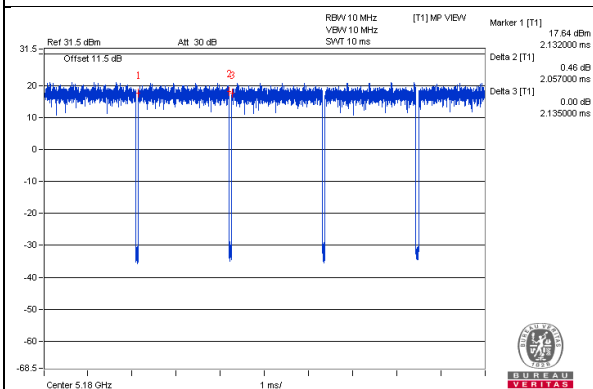

802.11ac (VHT20)

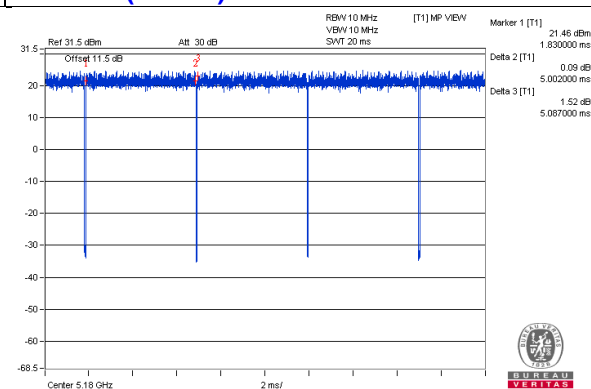

802.11ac (VHT40)

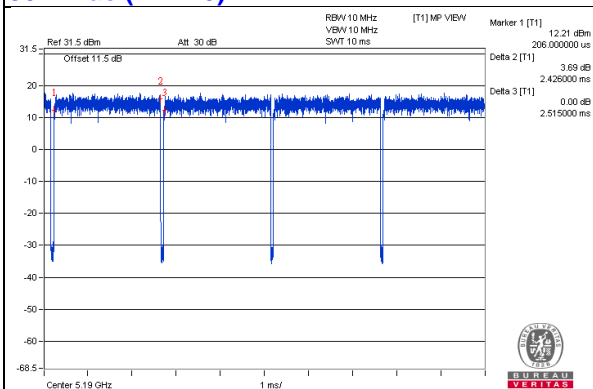

802.11ac (VHT80)

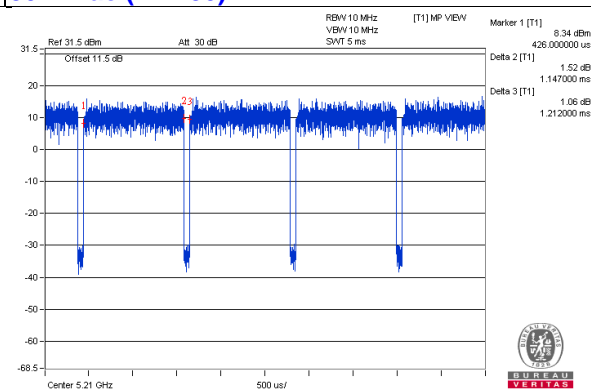

802.11ac (VHT80+80)

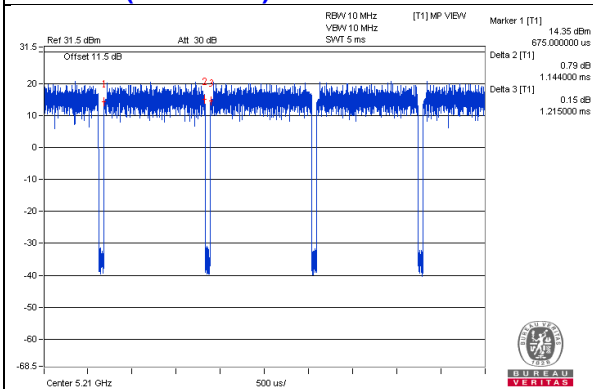

3.4 Description of Support Units

The EUT has been tested as an independent unit together with other necessary accessories or support units. The following support units or accessories were used to form a representative test configuration during the tests.

ID	Product	Brand	Model No.	Serial No.	FCC ID	Remarks
A.	Notebook Computer	DELL	E5430	HYV4VY1	FCC DoC	Provided by Lab
B.	HUB	ZyXEL	ES-116P	S060H02000215	FCC DoC	Provided by Lab
C.	iPod shuffle	Apple	MC749TA/A	CC4DMFKUDFDM	NA	Provided by Lab

Note:

1. All power cords of the above support units are non-shielded (1.8m).

ID	Descriptions	Qty.	Length (m)	Shielding (Yes/No)	Cores (Qty.)	Remarks
1.	RJ-45 Cable	1	10	No	0	Provided by Lab
2.	RJ-45 Cable	1	10	No	0	Provided by Lab
3.	DC Cable	1	1.0	No	0	Supplied by client
4.	AC Cable	1	1.5	No	0	Supplied by client
5.	USB Cable	1	0.1	Yes	0	Provided by Lab
6.	RJ-45 Cable	1	1.5	No	0	Provided by Lab

3.4.1 Configuration of System under Test

With adapter mode:

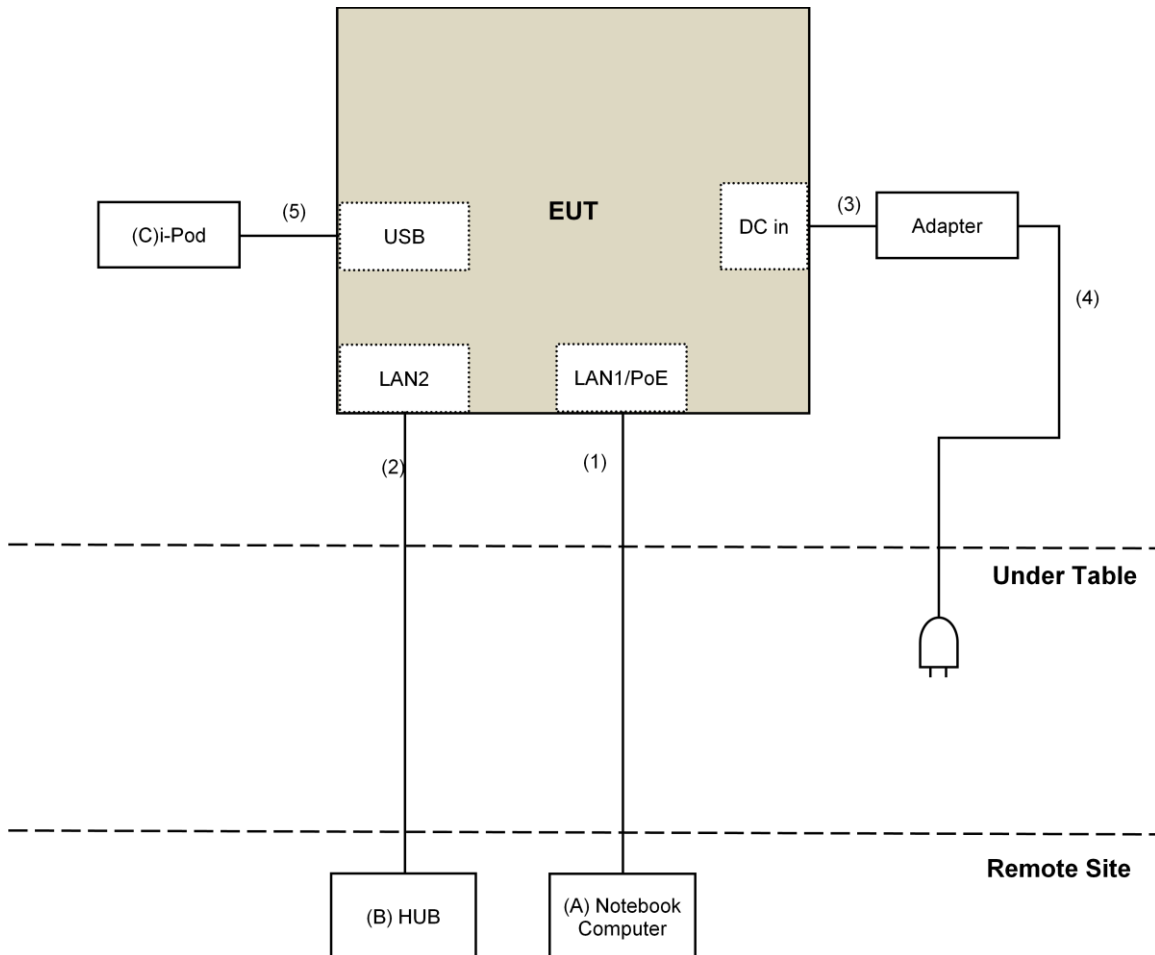

With POE mode:

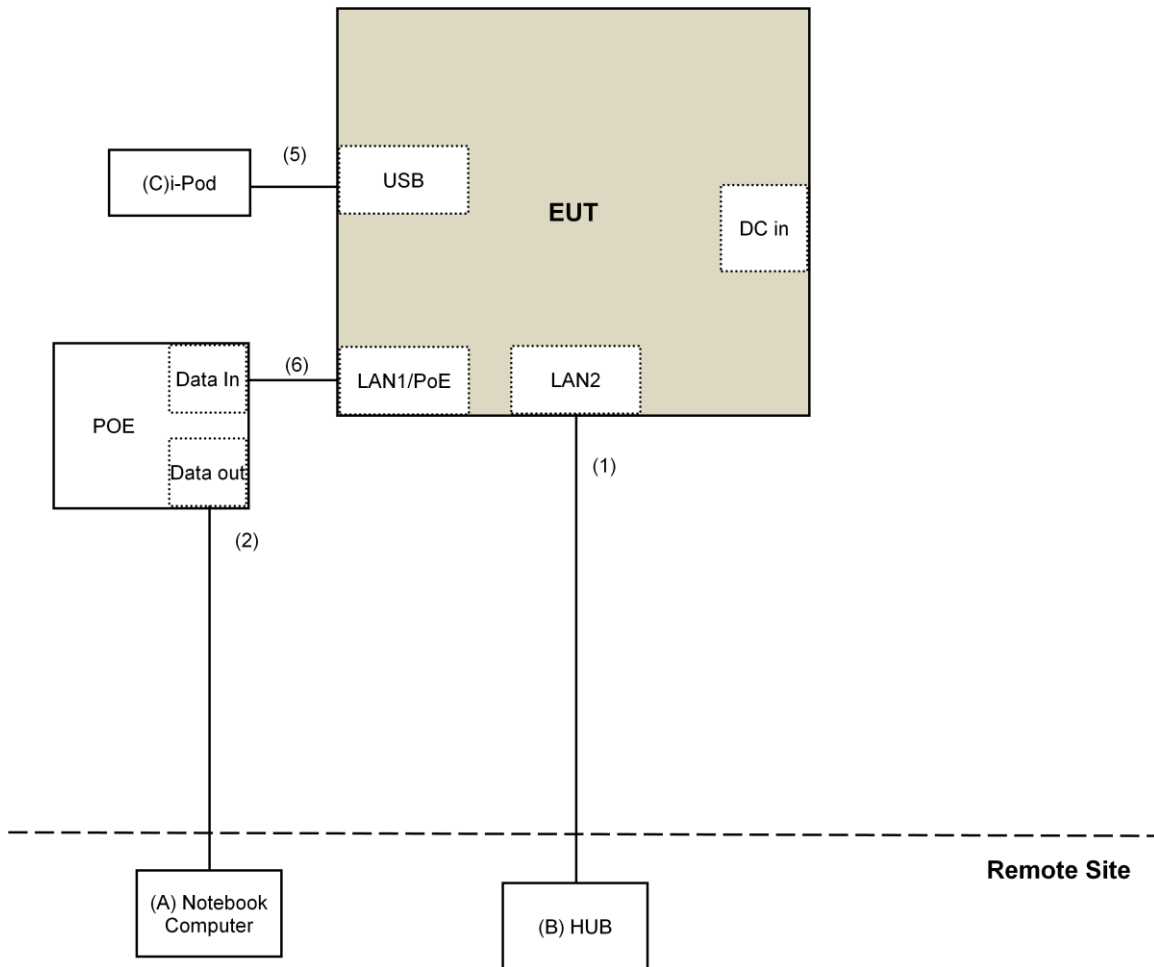

3.5 General Description of Applied Standard

The EUT is a RF Product. According to the specifications of the manufacturer, it must comply with the requirements of the following standards:

FCC Part 15, Subpart E (15.407)
KDB 789033 D02 General UNII Test Procedure New Rules v01r03
KDB 662911 D01 Multiple Transmitter Output v02r01
KDB 644545 D03 Guidance for IEEE 802.11ac v01
ANSI C63.10-2013

All test items have been performed and recorded as per the above standards.

4 Test Types and Results

4.1 Radiated Emission and Bandedge Measurement

4.1.1 Limits of Radiated Emission and Bandedge Measurement

Radiated emissions which fall in the restricted bands must comply with the radiated emission limits specified as below table.

Frequencies (MHz)	Field Strength (microvolts/meter)	Measurement Distance (meters)
0.009 ~ 0.490	2400/F(kHz)	300
0.490 ~ 1.705	24000/F(kHz)	30
1.705 ~ 30.0	30	30
30 ~ 88	100	3
88 ~ 216	150	3
216 ~ 960	200	3
Above 960	500	3

NOTE:

1. The lower limit shall apply at the transition frequencies.
2. Emission level (dBuV/m) = 20 log Emission level (uV/m).
3. For frequencies above 1000MHz, the field strength limits are based on average detector, however, the peak field strength of any emission shall not exceed the maximum permitted average limits, specified above by more than 20dB under any condition of modulation.

Limits of unwanted emission out of the restricted bands

Applicable To		Limit	
789033 D02 General UNII Test Procedure New Rules v01r03		Field Strength at 3m	
		PK:74 (dBuV/m)	AV:54 (dBuV/m)
Frequency Band	Applicable To	EIRP Limit	Equivalent Field Strength at 3m
5150~5250 MHz	15.407(b)(1)	PK:-27 (dBm/MHz)	PK:68.2(dBuV/m)
5250~5350 MHz	15.407(b)(2)		
5470~5725 MHz	15.407(b)(3)		
5725~5850 MHz	<input checked="" type="checkbox"/> 15.407(b)(4)(i)	PK:-27 (dBm/MHz) ^{*1} PK:10 (dBm/MHz) ^{*2} PK:15.6 (dBm/MHz) ^{*3} PK:27 (dBm/MHz) ^{*4}	PK: 68.2(dBuV/m) ^{*1} PK:105.2 (dBuV/m) ^{*2} PK: 110.8(dBuV/m) ^{*3} PK:122.2 (dBuV/m) ^{*4}
	<input type="checkbox"/> 15.407(b)(4)(ii)	Emission limits in section 15.247(d)	
^{*1} beyond 75 MHz or more above of the band edge.		^{*2} below the band edge increasing linearly to 10 dBm/MHz at 25 MHz above.	
^{*3} below the band edge increasing linearly to a level of 15.6 dBm/MHz at 5 MHz above.		^{*4} from 5 MHz above or below the band edge increasing linearly to a level of 27 dBm/MHz at the band edge.	

Note:

The following formula is used to convert the equipment isotropic radiated power (eirp) to field strength:

$$E = \frac{1000000\sqrt{30P}}{3} \mu\text{V/m, where P is the eirp (Watts).}$$

4.1.2 Test Instruments

For below 1GHz test:

DESCRIPTION & MANUFACTURER	MODEL NO.	SERIAL NO.	CALIBRATED DATE	CALIBRATED UNTIL
Test Receiver Agilent	N9038A	MY50010156	Aug. 12, 2015	Aug. 11, 2016
Pre-Amplifier ^(*) EMCI	EMC001340	980142	Jan. 20, 2016	Jan. 19, 2018
Loop Antenna ^(*) Electro-Metrics	EM-6879	264	Dec. 16, 2014	Dec. 15, 2016
RF Cable	NA	LOOPCAB-001 LOOPCAB-002	Jan. 18, 2016	Jan. 17, 2017
Pre-Amplifier Mini-Circuits	ZFL-1000VH2 B	AMP-ZFL-05	May 07, 2016	May 06, 2017
Trilog Broadband Antenna SCHWARZBECK	VULB 9168	9168-156	Jan. 04, 2016	Jan. 03, 2017
RF Cable	8D	966-3-1 966-3-2 966-3-3	Apr. 02, 2016	Apr. 01, 2017
Software	ADT_Radiated _V8.7.07	NA	NA	NA
Antenna Tower & Turn Table Max-Full	MF-7802	MF780208406	NA	NA
Boresight Antenna Fixture	FBA-01	FBA-SIP01	NA	NA

Note:

1. The calibration interval of the above test instruments is 12 months and the calibrations are traceable to NML/ROC and NIST/USA.
2. *The calibration interval of the above test instruments is 24 months and the calibrations are traceable to NML/ROC and NIST/USA.
3. Loop antenna was used for all emissions below 30 MHz.
4. The test was performed in 966 Chamber No. 3.
5. The FCC Site Registration No. is 147459
6. The CANADA Site Registration No. is 20331-1
7. Tested Date: Aug. 02, 2016

For above 1GHz test:

DESCRIPTION & MANUFACTURER	MODEL NO.	SERIAL NO.	CALIBRATED DATE	CALIBRATED UNTIL
Test Receiver Agilent	N9038A	MY50010156	Aug. 12, 2015	Aug. 11, 2016
Horn_Antenna SCHWARZBECK	BBHA9120-D	9120D-406	Jan. 20, 2016	Jan. 19, 2017
Pre-Amplifier Agilent	8449B	3008A02465	Apr. 05, 2016	Apr. 04, 2017
RF Cable	EMC104-SM- SM-2000 EMC104-SM- SM-5000 EMC104-SM- SM-5000	150317 150321 150322	Mar. 30, 2016	Mar. 29, 2017
Spectrum Analyzer Keysight	N9030A	MY54490520	July 29, 2016	July 28, 2017
Pre-Amplifier EMCI	EMC184045	980143	Jan. 15, 2016	Jan. 14, 2017
Horn_Antenna SCHWARZBECK	BBHA 9170	BBHA9170608	Jan. 08, 2016	Jan. 07, 2017
RF Cable	SUCOFLEX 102	36432/2 36441/2	Jan. 16, 2016	Jan. 15, 2017
Software	ADT_Radiated _V8.7.07	NA	NA	NA
Antenna Tower & Turn Table Max-Full	MF-7802	MF780208406	NA	NA
Boresight Antenna Fixture	FBA-01	FBA-SIP01	NA	NA

Note:

1. The calibration interval of the above test instruments is 12 months and the calibrations are traceable to NML/ROC and NIST/USA.
2. The test was performed in 966 Chamber No. 3.
3. The FCC Site Registration No. is 147459
4. The CANADA Site Registration No. is 20331-1
5. Tested Date: July 30, 2016

4.1.3 Test Procedure

- a. The EUT was placed on the top of a rotating table 0.8 meters (for below 1GHz) / 1.5 meters (for above 1GHz) above the ground at 3 meter chamber room for test. The table was rotated 360 degrees to determine the position of the highest radiation.
- b. The EUT was set 3 meters away from the interference-receiving antenna, which was mounted on the top of a variable-height antenna tower.
- c. The height of antenna is varied from one meter to four meters above the ground to determine the maximum value of the field strength. Both horizontal and vertical polarizations of the antenna are set to make the measurement.
- d. For each suspected emission, the EUT was arranged to its worst case and then the antenna was tuned to heights from 1 meter to 4 meters and the rotatable table was turned from 0 degrees to 360 degrees to find the maximum reading.
- e. The test-receiver system was set to quasi-peak detect function and specified bandwidth with maximum hold mode when the test frequency is below 1 GHz.
- f. The test-receiver system was set to peak and average detect function and specified bandwidth with maximum hold mode when the test frequency is above 1 GHz. If the peak reading value also meets average limit, measurement with the average detector is unnecessary.

Note:

1. The resolution bandwidth and video bandwidth of test receiver/spectrum analyzer is 120kHz for Quasi-peak detection (QP) at frequency below 1GHz.
2. The resolution bandwidth of test receiver/spectrum analyzer is 1 MHz and the video bandwidth is 3 MHz for Peak detection (PK) at frequency above 1GHz.
3. The resolution bandwidth of test receiver/spectrum analyzer is 1MHz and the video bandwidth is $\geq 1/T$ (Duty cycle < 98%) or 10Hz (Duty cycle $\geq 98\%$) for Average detection (AV) at frequency above 1GHz.
4. All modes of operation were investigated and the worst-case emissions are reported.

4.1.4 Deviation from Test Standard

No deviation.

4.1.5 Test Setup

<Frequency Range below 1GHz>

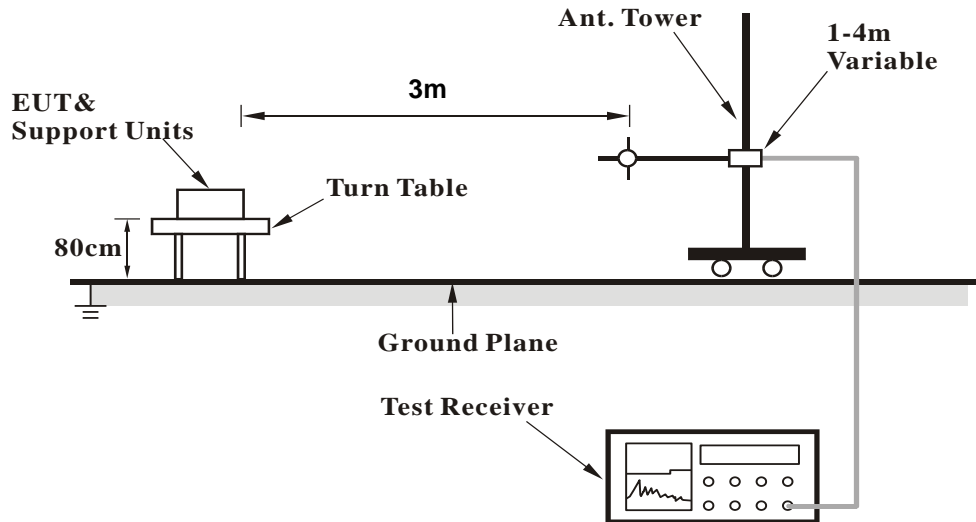

<Frequency Range above 1GHz>

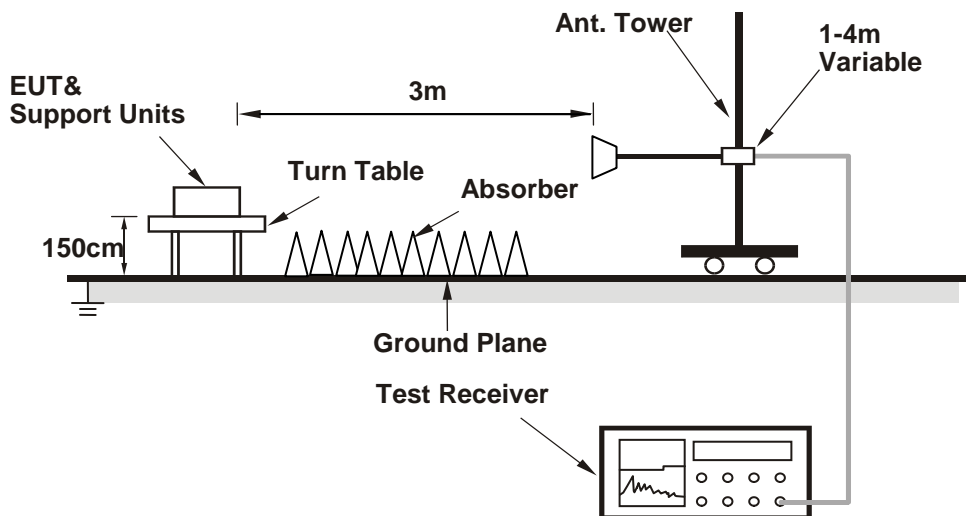

For the actual test configuration, please refer to the attached file (Test Setup Photo).

4.1.6 EUT Operating Condition

- Connect the EUT with the support unit A (Notebook Computer) which is placed outside of testing area.
- The communication partner run test program "QRCT.exe[Ver3.0.174.0]" to enable EUT under transmission/receiving condition continuously at specific channel frequency.
- Support unit C (iPod shuffle) was connected to EUT via one USB cable to simulate real connection.

4.1.7 Test Results (Mode 1)

Above 1GHz Data :

802.11a

CHANNEL	TX Channel 36	DETECTOR FUNCTION	Peak (PK)
FREQUENCY RANGE	1GHz ~ 40GHz		Average (AV)

ANTENNA POLARITY & TEST DISTANCE: HORIZONTAL AT 3 M

NO.	FREQ. (MHz)	EMISSION LEVEL (dBuV/m)	LIMIT (dBuV/m)	MARGIN (dB)	ANTENNA HEIGHT (m)	TABLE ANGLE (Degree)	RAW VALUE (dBuV)	CORRECTION FACTOR (dB/m)
1	5150.00	63.6 PK	74.0	-10.4	2.03 H	122	60.6	3.0
2	5150.00	48.6 AV	54.0	-5.4	2.03 H	122	45.6	3.0
3	*5180.00	117.6 PK			2.03 H	122	114.5	3.1
4	*5180.00	105.8 AV			2.03 H	122	102.7	3.1
5	#10360.00	49.7 PK	74.0	-24.3	1.42 H	204	36.1	13.6
6	#10360.00	37.4 AV	54.0	-16.6	1.42 H	204	23.8	13.6
7	15540.00	53.8 PK	74.0	-20.2	1.55 H	190	38.1	15.7
8	15540.00	42.0 AV	54.0	-12.0	1.55 H	190	26.3	15.7

ANTENNA POLARITY & TEST DISTANCE: VERTICAL AT 3 M

NO.	FREQ. (MHz)	EMISSION LEVEL (dBuV/m)	LIMIT (dBuV/m)	MARGIN (dB)	ANTENNA HEIGHT (m)	TABLE ANGLE (Degree)	RAW VALUE (dBuV)	CORRECTION FACTOR (dB/m)
1	5150.00	63.0 PK	74.0	-11.0	3.84 V	206	60.0	3.0
2	5150.00	46.3 AV	54.0	-7.7	3.84 V	206	43.3	3.0
3	*5180.00	117.9 PK			3.84 V	206	114.8	3.1
4	*5180.00	106.8 AV			3.84 V	206	103.7	3.1
5	#10360.00	48.9 PK	74.0	-25.1	1.43 V	136	35.3	13.6
6	#10360.00	36.3 AV	54.0	-17.7	1.43 V	136	22.7	13.6
7	15540.00	61.0 PK	74.0	-13.0	3.51 V	181	45.3	15.7
8	15540.00	46.9 AV	54.0	-7.1	3.51 V	181	31.2	15.7

REMARKS:

1. Emission Level(dBuV/m) = Raw Value(dBuV) + Correction Factor(dB/m)
2. Correction Factor(dB/m) = Antenna Factor(dB/m) + Cable Factor(dB) – Pre-Amplifier Factor(dB)
3. The other emission levels were very low against the limit.
4. Margin value = Emission Level – Limit value
5. " * ": Fundamental frequency.
6. " # ": The radiated frequency is out of the restricted band.

CHANNEL	TX Channel 40	DETECTOR FUNCTION	Peak (PK)
FREQUENCY RANGE	1GHz ~ 40GHz		Average (AV)

ANTENNA POLARITY & TEST DISTANCE: HORIZONTAL AT 3 M

NO.	FREQ. (MHz)	EMISSION LEVEL (dBuV/m)	LIMIT (dBuV/m)	MARGIN (dB)	ANTENNA HEIGHT (m)	TABLE ANGLE (Degree)	RAW VALUE (dBuV)	CORRECTION FACTOR (dB/m)
1	5150.00	55.0 PK	74.0	-19.0	1.01 H	235	52.0	3.0
2	5150.00	41.2 AV	54.0	-12.8	1.01 H	235	38.2	3.0
3	*5200.00	117.4 PK			1.07 H	114	114.3	3.1
4	*5200.00	109.0 AV			1.07 H	114	105.9	3.1
5	#10400.00	49.6 PK	74.0	-24.4	1.43 H	195	36.0	13.6
6	#10400.00	37.5 AV	54.0	-16.5	1.43 H	195	23.9	13.6
7	15600.00	54.1 PK	74.0	-19.9	1.52 H	177	38.4	15.7
8	15600.00	42.3 AV	54.0	-11.7	1.52 H	177	26.6	15.7

ANTENNA POLARITY & TEST DISTANCE: VERTICAL AT 3 M

NO.	FREQ. (MHz)	EMISSION LEVEL (dBuV/m)	LIMIT (dBuV/m)	MARGIN (dB)	ANTENNA HEIGHT (m)	TABLE ANGLE (Degree)	RAW VALUE (dBuV)	CORRECTION FACTOR (dB/m)
1	5150.00	58.9 PK	74.0	-15.1	3.68 V	179	55.9	3.0
2	5150.00	45.1 AV	54.0	-8.9	3.68 V	179	42.1	3.0
3	*5200.00	118.0 PK			3.79 V	173	114.9	3.1
4	*5200.00	109.3 AV			3.79 V	173	106.2	3.1
5	#10400.00	48.7 PK	74.0	-25.3	1.46 V	147	35.1	13.6
6	#10400.00	36.0 AV	54.0	-18.0	1.46 V	147	22.4	13.6
7	15600.00	61.3 PK	74.0	-12.7	3.53 V	191	45.6	15.7
8	15600.00	46.9 AV	54.0	-7.1	3.53 V	191	31.2	15.7

REMARKS:

1. Emission Level(dBuV/m) = Raw Value(dBuV) + Correction Factor(dB/m)
2. Correction Factor(dB/m) = Antenna Factor(dB/m) + Cable Factor(dB) – Pre-Amplifier Factor(dB)
3. The other emission levels were very low against the limit.
4. Margin value = Emission Level – Limit value
5. " * ": Fundamental frequency.
6. " # ": The radiated frequency is out of the restricted band.

CHANNEL	TX Channel 48	DETECTOR FUNCTION	Peak (PK)
FREQUENCY RANGE	1GHz ~ 40GHz		Average (AV)

ANTENNA POLARITY & TEST DISTANCE: HORIZONTAL AT 3 M

NO.	FREQ. (MHz)	EMISSION LEVEL (dBuV/m)	LIMIT (dBuV/m)	MARGIN (dB)	ANTENNA HEIGHT (m)	TABLE ANGLE (Degree)	RAW VALUE (dBuV)	CORRECTION FACTOR (dB/m)
1	5000.00	49.1 PK	74.0	-24.9	1.97 H	112	46.5	2.6
2	5000.00	41.8 AV	54.0	-12.2	1.97 H	112	39.2	2.6
3	*5240.00	116.4 PK			1.97 H	112	113.2	3.2
4	*5240.00	106.7 AV			1.97 H	112	103.5	3.2
5	5350.00	51.3 PK	74.0	-22.7	1.97 H	112	47.8	3.5
6	5350.00	40.8 AV	54.0	-13.2	1.97 H	112	37.3	3.5
7	#10480.00	49.6 PK	74.0	-24.4	1.43 H	193	35.6	14.0
8	#10480.00	37.5 AV	54.0	-16.5	1.43 H	193	23.5	14.0
9	15720.00	54.5 PK	74.0	-19.5	1.48 H	186	39.1	15.4
10	15720.00	42.6 AV	54.0	-11.4	1.48 H	186	27.2	15.4

ANTENNA POLARITY & TEST DISTANCE: VERTICAL AT 3 M

NO.	FREQ. (MHz)	EMISSION LEVEL (dBuV/m)	LIMIT (dBuV/m)	MARGIN (dB)	ANTENNA HEIGHT (m)	TABLE ANGLE (Degree)	RAW VALUE (dBuV)	CORRECTION FACTOR (dB/m)
1	5000.00	50.8 PK	74.0	-23.2	3.75 V	199	48.2	2.6
2	5000.00	43.3 AV	54.0	-10.7	3.75 V	199	40.7	2.6
3	*5240.00	118.0 PK			3.75 V	199	114.8	3.2
4	*5240.00	108.5 AV			3.75 V	199	105.3	3.2
5	5350.00	51.1 PK	74.0	-22.9	3.75 V	199	47.6	3.5
6	5350.00	40.5 AV	54.0	-13.5	3.75 V	199	37.0	3.5
7	#10480.00	49.2 PK	74.0	-24.8	1.42 V	153	35.2	14.0
8	#10480.00	36.3 AV	54.0	-17.7	1.42 V	153	22.3	14.0
9	15720.00	61.3 PK	74.0	-12.7	3.52 V	182	45.9	15.4
10	15720.00	46.9 AV	54.0	-7.1	3.52 V	182	31.5	15.4

REMARKS:

1. Emission Level(dBuV/m) = Raw Value(dBuV) + Correction Factor(dB/m)
2. Correction Factor(dB/m) = Antenna Factor(dB/m) + Cable Factor(dB) – Pre-Amplifier Factor(dB)
3. The other emission levels were very low against the limit.
4. Margin value = Emission Level – Limit value
5. " * ": Fundamental frequency.
6. " # ": The radiated frequency is out of the restricted band.

CHANNEL	TX Channel 149	DETECTOR FUNCTION	Peak (PK)
FREQUENCY RANGE	1GHz ~ 40GHz		Average (AV)

ANTENNA POLARITY & TEST DISTANCE: HORIZONTAL AT 3 M

NO.	FREQ. (MHz)	EMISSION LEVEL (dBuV/m)	LIMIT (dBuV/m)	MARGIN (dB)	ANTENNA HEIGHT (m)	TABLE ANGLE (Degree)	RAW VALUE (dBuV)	CORRECTION FACTOR (dB/m)
1	#5629.32	59.9 PK	68.2	-8.3	1.00 H	235	55.9	4.0
2	*5745.00	121.2 PK			1.00 H	235	117.0	4.2
3	*5745.00	111.9 AV			1.00 H	235	107.7	4.2
4	#6025.00	58.6 PK	68.2	-9.6	1.00 H	235	54.0	4.6
5	11490.00	54.1 PK	74.0	-19.9	1.23 H	214	38.9	15.2
6	11490.00	41.9 AV	54.0	-12.1	1.23 H	214	26.7	15.2
7	#17235.00	60.5 PK	74.0	-13.5	3.27 H	248	40.5	20.0
8	#17235.00	48.5 AV	54.0	-5.5	3.27 H	248	28.5	20.0

ANTENNA POLARITY & TEST DISTANCE: VERTICAL AT 3 M

NO.	FREQ. (MHz)	EMISSION LEVEL (dBuV/m)	LIMIT (dBuV/m)	MARGIN (dB)	ANTENNA HEIGHT (m)	TABLE ANGLE (Degree)	RAW VALUE (dBuV)	CORRECTION FACTOR (dB/m)
1	#5647.85	62.4 PK	68.2	-5.8	3.43 V	179	58.4	4.0
2	*5745.00	122.5 PK			3.43 V	179	118.3	4.2
3	*5745.00	113.5 AV			3.43 V	179	109.3	4.2
4	#5924.77	60.6 PK	68.4	-7.8	3.43 V	179	56.2	4.4
5	11490.00	50.5 PK	74.0	-23.5	1.22 V	180	35.3	15.2
6	11490.00	40.4 AV	54.0	-13.6	1.22 V	180	25.2	15.2
7	#17235.00	60.6 PK	74.0	-13.4	2.11 V	209	40.6	20.0
8	#17235.00	47.6 AV	54.0	-6.4	2.11 V	209	27.6	20.0

REMARKS:

1. Emission Level(dBuV/m) = Raw Value(dBuV) + Correction Factor(dB/m)
2. Correction Factor(dB/m) = Antenna Factor(dB/m) + Cable Factor(dB) – Pre-Amplifier Factor(dB)
3. The other emission levels were very low against the limit.
4. Margin value = Emission Level – Limit value
5. " * ": Fundamental frequency.
6. " # ": The radiated frequency is out of the restricted band.

CHANNEL	TX Channel 157	DETECTOR FUNCTION	Peak (PK)
FREQUENCY RANGE	1GHz ~ 40GHz		Average (AV)

ANTENNA POLARITY & TEST DISTANCE: HORIZONTAL AT 3 M

NO.	FREQ. (MHz)	EMISSION LEVEL (dBuV/m)	LIMIT (dBuV/m)	MARGIN (dB)	ANTENNA HEIGHT (m)	TABLE ANGLE (Degree)	RAW VALUE (dBuV)	CORRECTION FACTOR (dB/m)
1	#5581.35	58.9 PK	68.2	-9.3	1.06 H	288	55.0	3.9
2	*5785.00	120.7 PK			1.06 H	228	116.6	4.1
3	*5785.00	111.5 AV			1.06 H	228	107.4	4.1
4	#6016.45	58.4 PK	68.2	-9.8	1.06 H	288	53.9	4.5
5	11570.00	53.7 PK	74.0	-20.3	1.25 H	199	38.6	15.1
6	11570.00	41.5 AV	54.0	-12.5	1.25 H	199	26.4	15.1
7	#17355.00	60.1 PK	74.0	-13.9	3.31 H	240	39.6	20.5
8	#17355.00	48.3 AV	54.0	-5.7	3.31 H	240	27.8	20.5

ANTENNA POLARITY & TEST DISTANCE: VERTICAL AT 3 M

NO.	FREQ. (MHz)	EMISSION LEVEL (dBuV/m)	LIMIT (dBuV/m)	MARGIN (dB)	ANTENNA HEIGHT (m)	TABLE ANGLE (Degree)	RAW VALUE (dBuV)	CORRECTION FACTOR (dB/m)
1	#5606.05	61.4 PK	68.2	-6.8	3.38 V	183	57.5	3.9
2	*5785.00	122.4 PK			3.38 V	183	118.3	4.1
3	*5785.00	113.2 AV			3.38 V	183	109.1	4.1
4	#5976.07	61.1 PK	68.2	-7.1	3.38 V	183	56.6	4.5
5	11570.00	50.4 PK	74.0	-23.6	1.24 V	196	35.3	15.1
6	11570.00	40.3 AV	54.0	-13.7	1.24 V	196	25.2	15.1
7	#17355.00	60.1 PK	74.0	-13.9	2.06 V	202	39.6	20.5
8	#17355.00	47.2 AV	54.0	-6.8	2.06 V	202	26.7	20.5

REMARKS:

1. Emission Level(dBuV/m) = Raw Value(dBuV) + Correction Factor(dB/m)
2. Correction Factor(dB/m) = Antenna Factor(dB/m) + Cable Factor(dB) – Pre-Amplifier Factor(dB)
3. The other emission levels were very low against the limit.
4. Margin value = Emission Level – Limit value
5. " * ": Fundamental frequency.
6. " # ": The radiated frequency is out of the restricted band.

CHANNEL	TX Channel 165	DETECTOR FUNCTION	Peak (PK)
FREQUENCY RANGE	1GHz ~ 40GHz		Average (AV)

ANTENNA POLARITY & TEST DISTANCE: HORIZONTAL AT 3 M

NO.	FREQ. (MHz)	EMISSION LEVEL (dBuV/m)	LIMIT (dBuV/m)	MARGIN (dB)	ANTENNA HEIGHT (m)	TABLE ANGLE (Degree)	RAW VALUE (dBuV)	CORRECTION FACTOR (dB/m)
1	#5615.55	59.8 PK	68.2	-8.4	1.12 H	212	55.9	3.9
2	*5825.00	121.4 PK			1.12 H	212	117.2	4.2
3	*5825.00	112.0 AV			1.12 H	212	107.8	4.2
4	#5960.87	58.8 PK	68.2	-9.4	1.12 H	212	54.3	4.5
5	11650.00	53.3 PK	74.0	-20.7	1.27 H	210	38.3	15.0
6	11650.00	41.2 AV	54.0	-12.8	1.27 H	210	26.2	15.0
7	#17475.00	59.6 PK	74.0	-14.4	3.36 H	248	38.5	21.1
8	#17475.00	48.1 AV	54.0	-5.9	3.36 H	248	27.0	21.1

ANTENNA POLARITY & TEST DISTANCE: VERTICAL AT 3 M

NO.	FREQ. (MHz)	EMISSION LEVEL (dBuV/m)	LIMIT (dBuV/m)	MARGIN (dB)	ANTENNA HEIGHT (m)	TABLE ANGLE (Degree)	RAW VALUE (dBuV)	CORRECTION FACTOR (dB/m)
1	#5612.70	62.2 PK	68.2	-6.0	3.40 V	169	58.3	3.9
2	*5825.00	121.9 PK			3.40 V	169	117.7	4.2
3	*5825.00	113.0 AV			3.40 V	169	108.8	4.2
4	#5940.45	60.2 PK	68.2	-8.0	3.40 V	169	55.8	4.4
5	11650.00	50.7 PK	74.0	-23.3	1.25 V	199	35.7	15.0
6	11650.00	40.8 AV	54.0	-13.2	1.25 V	199	25.8	15.0
7	#17475.00	60.6 PK	74.0	-13.4	2.11 V	199	39.5	21.1
8	#17475.00	47.4 AV	54.0	-6.6	2.11 V	199	26.3	21.1

REMARKS:

1. Emission Level(dBuV/m) = Raw Value(dBuV) + Correction Factor(dB/m)
2. Correction Factor(dB/m) = Antenna Factor(dB/m) + Cable Factor(dB) – Pre-Amplifier Factor(dB)
3. The other emission levels were very low against the limit.
4. Margin value = Emission Level – Limit value
5. " * ": Fundamental frequency.
6. " # ": The radiated frequency is out of the restricted band.

802.11ac (VHT20)

CHANNEL	TX Channel 36	DETECTOR FUNCTION	Peak (PK)
FREQUENCY RANGE	1GHz ~ 40GHz		Average (AV)

ANTENNA POLARITY & TEST DISTANCE: HORIZONTAL AT 3 M

NO.	FREQ. (MHz)	EMISSION LEVEL (dBuV/m)	LIMIT (dBuV/m)	MARGIN (dB)	ANTENNA HEIGHT (m)	TABLE ANGLE (Degree)	RAW VALUE (dBuV)	CORRECTION FACTOR (dB/m)
1	5150.00	63.0 PK	74.0	-11.0	3.66 H	120	60.0	3.0
2	5150.00	49.0 AV	54.0	-5.0	3.66 H	120	46.0	3.0
3	*5180.00	117.0 PK			3.66 H	120	113.9	3.1
4	*5180.00	106.3 AV			3.66 H	120	103.2	3.1
5	#10360.00	49.5 PK	74.0	-24.5	1.42 H	199	35.9	13.6
6	#10360.00	37.1 AV	54.0	-16.9	1.42 H	199	23.5	13.6
7	15540.00	54.2 PK	74.0	-19.8	1.55 H	198	38.5	15.7
8	15540.00	42.3 AV	54.0	-11.7	1.55 H	198	26.6	15.7

ANTENNA POLARITY & TEST DISTANCE: VERTICAL AT 3 M

NO.	FREQ. (MHz)	EMISSION LEVEL (dBuV/m)	LIMIT (dBuV/m)	MARGIN (dB)	ANTENNA HEIGHT (m)	TABLE ANGLE (Degree)	RAW VALUE (dBuV)	CORRECTION FACTOR (dB/m)
1	5150.00	66.1 PK	74.0	-7.9	3.85 V	172	63.1	3.0
2	5150.00	49.6 AV	54.0	-4.4	3.85 V	172	46.6	3.0
3	*5180.00	117.7 PK			3.85 V	172	114.6	3.1
4	*5180.00	107.1 AV			3.85 V	172	104.0	3.1
5	#10360.00	48.9 PK	74.0	-25.1	1.41 V	123	35.3	13.6
6	#10360.00	36.5 AV	54.0	-17.5	1.41 V	123	22.9	13.6
7	15540.00	61.6 PK	74.0	-12.4	3.55 V	183	45.9	15.7
8	15540.00	47.2 AV	54.0	-6.8	3.55 V	183	31.5	15.7

REMARKS:

- Emission Level(dBuV/m) = Raw Value(dBuV) + Correction Factor(dB/m)
- Correction Factor(dB/m) = Antenna Factor(dB/m) + Cable Factor(dB) – Pre-Amplifier Factor(dB)
- The other emission levels were very low against the limit.
- Margin value = Emission Level – Limit value
- " * ": Fundamental frequency.
- " # ": The radiated frequency is out of the restricted band.

CHANNEL	TX Channel 40	DETECTOR FUNCTION	Peak (PK)
FREQUENCY RANGE	1GHz ~ 40GHz		Average (AV)

ANTENNA POLARITY & TEST DISTANCE: HORIZONTAL AT 3 M

NO.	FREQ. (MHz)	EMISSION LEVEL (dBuV/m)	LIMIT (dBuV/m)	MARGIN (dB)	ANTENNA HEIGHT (m)	TABLE ANGLE (Degree)	RAW VALUE (dBuV)	CORRECTION FACTOR (dB/m)
1	5150.00	57.1 PK	74.0	-16.9	2.01 H	109	54.1	3.0
2	5150.00	43.9 AV	54.0	-10.1	2.01 H	109	40.9	3.0
3	*5200.00	117.0 PK			2.01 H	109	113.9	3.1
4	*5200.00	106.8 AV			2.01 H	109	103.7	3.1
5	#10400.00	49.5 PK	74.0	-24.5	1.44 H	191	35.9	13.6
6	#10400.00	37.2 AV	54.0	-16.8	1.44 H	191	23.6	13.6
7	15600.00	53.5 PK	74.0	-20.5	1.57 H	202	37.8	15.7
8	15600.00	41.7 AV	54.0	-12.3	1.57 H	202	26.0	15.7

ANTENNA POLARITY & TEST DISTANCE: VERTICAL AT 3 M

NO.	FREQ. (MHz)	EMISSION LEVEL (dBuV/m)	LIMIT (dBuV/m)	MARGIN (dB)	ANTENNA HEIGHT (m)	TABLE ANGLE (Degree)	RAW VALUE (dBuV)	CORRECTION FACTOR (dB/m)
1	5150.00	58.5 PK	74.0	-15.5	3.68 V	181	55.5	3.0
2	5150.00	45.2 AV	54.0	-8.8	3.68 V	181	42.2	3.0
3	*5200.00	118.6 PK			3.39 V	188	115.5	3.1
4	*5200.00	108.2 AV			3.39 V	188	105.1	3.1
5	#10400.00	49.0 PK	74.0	-25.0	1.44 V	134	35.4	13.6
6	#10400.00	36.3 AV	54.0	-17.7	1.44 V	134	22.7	13.6
7	15600.00	61.1 PK	74.0	-12.9	3.57 V	181	45.4	15.7
8	15600.00	47.3 AV	54.0	-6.7	3.57 V	181	31.6	15.7

REMARKS:

1. Emission Level(dBuV/m) = Raw Value(dBuV) + Correction Factor(dB/m)
2. Correction Factor(dB/m) = Antenna Factor(dB/m) + Cable Factor(dB) – Pre-Amplifier Factor(dB)
3. The other emission levels were very low against the limit.
4. Margin value = Emission Level – Limit value
5. " * ": Fundamental frequency.
6. " # ": The radiated frequency is out of the restricted band.

CHANNEL	TX Channel 48	DETECTOR FUNCTION	Peak (PK)
FREQUENCY RANGE	1GHz ~ 40GHz		Average (AV)

ANTENNA POLARITY & TEST DISTANCE: HORIZONTAL AT 3 M

NO.	FREQ. (MHz)	EMISSION LEVEL (dBuV/m)	LIMIT (dBuV/m)	MARGIN (dB)	ANTENNA HEIGHT (m)	TABLE ANGLE (Degree)	RAW VALUE (dBuV)	CORRECTION FACTOR (dB/m)
1	*5240.00	115.6 PK			3.61 H	121	112.4	3.2
2	*5240.00	104.0 AV			3.61 H	121	100.8	3.2
3	5350.00	52.0 PK	74.0	-22.0	3.61 H	121	48.5	3.5
4	5350.00	40.1 AV	54.0	-13.9	3.61 H	121	36.6	3.5
5	#10480.00	49.8 PK	74.0	-24.2	1.42 H	216	35.8	14.0
6	#10480.00	37.7 AV	54.0	-16.3	1.42 H	216	23.7	14.0
7	15720.00	53.3 PK	74.0	-20.7	1.53 H	176	37.9	15.4
8	15720.00	41.5 AV	54.0	-12.5	1.53 H	176	26.1	15.4

ANTENNA POLARITY & TEST DISTANCE: VERTICAL AT 3 M

NO.	FREQ. (MHz)	EMISSION LEVEL (dBuV/m)	LIMIT (dBuV/m)	MARGIN (dB)	ANTENNA HEIGHT (m)	TABLE ANGLE (Degree)	RAW VALUE (dBuV)	CORRECTION FACTOR (dB/m)
1	*5240.00	117.4 PK			3.89 V	167	114.2	3.2
2	*5240.00	106.1 AV			3.89 V	167	102.9	3.2
3	5350.00	53.1 PK	74.0	-20.9	3.89 V	167	49.6	3.5
4	5350.00	41.1 AV	54.0	-12.9	3.89 V	167	37.6	3.5
5	#10480.00	48.9 PK	74.0	-25.1	1.43 V	152	34.9	14.0
6	#10480.00	36.5 AV	54.0	-17.5	1.43 V	152	22.5	14.0
7	15720.00	60.6 PK	74.0	-13.4	3.46 V	173	45.2	15.4
8	15720.00	46.5 AV	54.0	-7.5	3.46 V	173	31.1	15.4

REMARKS:

1. Emission Level(dBuV/m) = Raw Value(dBuV) + Correction Factor(dB/m)
2. Correction Factor(dB/m) = Antenna Factor(dB/m) + Cable Factor(dB) – Pre-Amplifier Factor(dB)
3. The other emission levels were very low against the limit.
4. Margin value = Emission Level – Limit value
5. " * ": Fundamental frequency.
6. " # ": The radiated frequency is out of the restricted band.

CHANNEL	TX Channel 149	DETECTOR FUNCTION	Peak (PK)
FREQUENCY RANGE	1GHz ~ 40GHz		Average (AV)

ANTENNA POLARITY & TEST DISTANCE: HORIZONTAL AT 3 M

NO.	FREQ. (MHz)	EMISSION LEVEL (dBuV/m)	LIMIT (dBuV/m)	MARGIN (dB)	ANTENNA HEIGHT (m)	TABLE ANGLE (Degree)	RAW VALUE (dBuV)	CORRECTION FACTOR (dB/m)
1	#5607.95	61.2 PK	68.2	-7.0	1.03 H	163	57.3	3.9
2	*5745.00	120.7 PK			1.03 H	163	116.5	4.2
3	*5745.00	112.2 AV			1.03 H	163	108.0	4.2
4	#5953.27	60.0 PK	68.2	-8.2	1.03 H	163	55.6	4.4
5	11490.00	52.9 PK	74.0	-21.1	1.21 H	198	37.7	15.2
6	11490.00	41.0 AV	54.0	-13.0	1.21 H	198	25.8	15.2
7	#17235.00	59.2 PK	74.0	-14.8	3.39 H	250	39.2	20.0
8	#17235.00	47.9 AV	54.0	-6.1	3.39 H	250	27.9	20.0

ANTENNA POLARITY & TEST DISTANCE: VERTICAL AT 3 M

NO.	FREQ. (MHz)	EMISSION LEVEL (dBuV/m)	LIMIT (dBuV/m)	MARGIN (dB)	ANTENNA HEIGHT (m)	TABLE ANGLE (Degree)	RAW VALUE (dBuV)	CORRECTION FACTOR (dB/m)
1	#5617.45	61.7 PK	68.2	-6.5	3.42 V	179	57.8	3.9
2	*5745.00	124.1 PK			3.42 V	179	119.9	4.2
3	*5745.00	113.3 AV			3.42 V	179	109.1	4.2
4	#5966.10	61.6 PK	68.2	-6.6	3.42 V	179	57.1	4.5
5	11490.00	50.5 PK	74.0	-23.5	1.30 V	189	35.3	15.2
6	11490.00	40.7 AV	54.0	-13.3	1.30 V	189	25.5	15.2
7	#17235.00	60.7 PK	74.0	-13.3	2.16 V	205	40.7	20.0
8	#17235.00	47.3 AV	54.0	-6.7	2.16 V	205	27.3	20.0

REMARKS:

1. Emission Level(dBuV/m) = Raw Value(dBuV) + Correction Factor(dB/m)
2. Correction Factor(dB/m) = Antenna Factor(dB/m) + Cable Factor(dB) – Pre-Amplifier Factor(dB)
3. The other emission levels were very low against the limit.
4. Margin value = Emission Level – Limit value
5. " * ": Fundamental frequency.
6. " # ": The radiated frequency is out of the restricted band.

CHANNEL	TX Channel 157	DETECTOR FUNCTION	Peak (PK)
FREQUENCY RANGE	1GHz ~ 40GHz		Average (AV)

ANTENNA POLARITY & TEST DISTANCE: HORIZONTAL AT 3 M

NO.	FREQ. (MHz)	EMISSION LEVEL (dBuV/m)	LIMIT (dBuV/m)	MARGIN (dB)	ANTENNA HEIGHT (m)	TABLE ANGLE (Degree)	RAW VALUE (dBuV)	CORRECTION FACTOR (dB/m)
1	#5582.30	61.9 PK	68.2	-6.3	1.08 H	147	58.0	3.9
2	*5785.00	121.4 PK			1.08 H	147	117.3	4.1
3	*5785.00	112.3 AV			1.08 H	147	108.2	4.1
4	#5991.75	61.3 PK	68.2	-6.9	1.08 H	147	56.8	4.5
5	11570.00	53.2 PK	74.0	-20.8	1.30 H	196	38.1	15.1
6	11570.00	40.9 AV	54.0	-13.1	1.30 H	196	25.8	15.1
7	#17355.00	59.7 PK	74.0	-14.3	3.33 H	240	39.2	20.5
8	#17355.00	48.4 AV	54.0	-5.6	3.33 H	240	27.9	20.5

ANTENNA POLARITY & TEST DISTANCE: VERTICAL AT 3 M

NO.	FREQ. (MHz)	EMISSION LEVEL (dBuV/m)	LIMIT (dBuV/m)	MARGIN (dB)	ANTENNA HEIGHT (m)	TABLE ANGLE (Degree)	RAW VALUE (dBuV)	CORRECTION FACTOR (dB/m)
1	#5595.60	60.9 PK	68.2	-7.3	3.35 V	177	57.0	3.9
2	*5785.00	123.4 PK			3.35 V	177	119.3	4.1
3	*5785.00	113.7 AV			3.35 V	177	109.6	4.1
4	#6012.18	60.5 PK	68.2	-7.7	3.35 V	177	56.0	4.5
5	11570.00	50.8 PK	74.0	-23.2	1.20 V	195	35.7	15.1
6	11570.00	40.8 AV	54.0	-13.2	1.20 V	195	25.7	15.1
7	#17355.00	60.7 PK	74.0	-13.3	2.06 V	187	40.2	20.5
8	#17355.00	47.5 AV	54.0	-6.5	2.06 V	187	27.0	20.5

REMARKS:

1. Emission Level(dBuV/m) = Raw Value(dBuV) + Correction Factor(dB/m)
2. Correction Factor(dB/m) = Antenna Factor(dB/m) + Cable Factor(dB) – Pre-Amplifier Factor(dB)
3. The other emission levels were very low against the limit.
4. Margin value = Emission Level – Limit value
5. " * ": Fundamental frequency.
6. " # ": The radiated frequency is out of the restricted band.

CHANNEL	TX Channel 165	DETECTOR FUNCTION	Peak (PK)
FREQUENCY RANGE	1GHz ~ 40GHz		Average (AV)

ANTENNA POLARITY & TEST DISTANCE: HORIZONTAL AT 3 M

NO.	FREQ. (MHz)	EMISSION LEVEL (dBuV/m)	LIMIT (dBuV/m)	MARGIN (dB)	ANTENNA HEIGHT (m)	TABLE ANGLE (Degree)	RAW VALUE (dBuV)	CORRECTION FACTOR (dB/m)
1	#5571.85	58.9 PK	68.2	-9.3	1.00 H	138	55.0	3.9
2	*5825.00	120.4 PK			1.00 H	138	116.2	4.2
3	*5825.00	112.0 AV			1.00 H	138	107.8	4.2
4	#6018.82	58.8 PK	68.2	-9.4	1.00 H	138	54.3	4.5
5	11650.00	53.2 PK	74.0	-20.8	1.25 H	211	38.2	15.0
6	11650.00	41.2 AV	54.0	-12.8	1.25 H	211	26.2	15.0
7	#17475.00	60.2 PK	74.0	-13.8	3.35 H	254	39.1	21.1
8	#17475.00	48.5 AV	54.0	-5.5	3.35 H	254	27.4	21.1

ANTENNA POLARITY & TEST DISTANCE: VERTICAL AT 3 M

NO.	FREQ. (MHz)	EMISSION LEVEL (dBuV/m)	LIMIT (dBuV/m)	MARGIN (dB)	ANTENNA HEIGHT (m)	TABLE ANGLE (Degree)	RAW VALUE (dBuV)	CORRECTION FACTOR (dB/m)
1	#5556.18	59.3 PK	68.2	-8.9	3.31 V	180	55.4	3.9
2	*5825.00	123.2 PK			3.31 V	180	119.0	4.2
3	*5825.00	113.8 AV			3.31 V	180	109.6	4.2
4	#5934.27	60.2 PK	68.2	-8.0	3.31 V	180	55.8	4.4
5	11650.00	50.6 PK	74.0	-23.4	1.29 V	184	35.6	15.0
6	11650.00	40.9 AV	54.0	-13.1	1.29 V	184	25.9	15.0
7	#17475.00	60.5 PK	74.0	-13.5	2.12 V	200	39.4	21.1
8	#17475.00	47.3 AV	54.0	-6.7	2.12 V	200	26.2	21.1

REMARKS:

1. Emission Level(dBuV/m) = Raw Value(dBuV) + Correction Factor(dB/m)
2. Correction Factor(dB/m) = Antenna Factor(dB/m) + Cable Factor(dB) – Pre-Amplifier Factor(dB)
3. The other emission levels were very low against the limit.
4. Margin value = Emission Level – Limit value
5. " * ": Fundamental frequency.
6. " # ": The radiated frequency is out of the restricted band.

802.11ac (VHT40)

CHANNEL	TX Channel 38	DETECTOR FUNCTION	Peak (PK)
FREQUENCY RANGE	1GHz ~ 40GHz		Average (AV)

ANTENNA POLARITY & TEST DISTANCE: HORIZONTAL AT 3 M

NO.	FREQ. (MHz)	EMISSION LEVEL (dBuV/m)	LIMIT (dBuV/m)	MARGIN (dB)	ANTENNA HEIGHT (m)	TABLE ANGLE (Degree)	RAW VALUE (dBuV)	CORRECTION FACTOR (dB/m)
1	5150.00	64.8 PK	74.0	-9.2	1.99 H	110	61.8	3.0
2	5150.00	51.5 AV	54.0	-2.5	1.99 H	110	48.5	3.0
3	*5190.00	111.2 PK			1.99 H	110	108.1	3.1
4	*5190.00	101.1 AV			1.99 H	110	98.0	3.1
5	5350.00	50.7 PK	74.0	-23.3	1.99 H	110	47.2	3.5
6	5350.00	37.8 AV	54.0	-16.2	1.99 H	110	34.3	3.5
7	#10380.00	49.6 PK	74.0	-24.4	1.39 H	207	35.9	13.7
8	#10380.00	37.0 AV	54.0	-17.0	1.39 H	207	23.3	13.7
9	15570.00	53.6 PK	74.0	-20.4	1.53 H	192	38.0	15.6
10	15570.00	41.6 AV	54.0	-12.4	1.53 H	192	26.0	15.6

ANTENNA POLARITY & TEST DISTANCE: VERTICAL AT 3 M

NO.	FREQ. (MHz)	EMISSION LEVEL (dBuV/m)	LIMIT (dBuV/m)	MARGIN (dB)	ANTENNA HEIGHT (m)	TABLE ANGLE (Degree)	RAW VALUE (dBuV)	CORRECTION FACTOR (dB/m)
1	5150.00	66.6 PK	74.0	-7.4	3.83 V	204	63.6	3.0
2	5150.00	53.1 AV	54.0	-0.9	3.83 V	204	50.1	3.0
3	*5190.00	112.7 PK			3.83 V	204	109.6	3.1
4	*5190.00	102.6 AV			3.83 V	204	99.5	3.1
5	5350.00	51.8 PK	74.0	-22.2	3.83 V	204	48.3	3.5
6	5350.00	39.1 AV	54.0	-14.9	3.83 V	204	35.6	3.5
7	#10380.00	49.4 PK	74.0	-24.6	1.39 V	142	35.7	13.7
8	#10380.00	36.7 AV	54.0	-17.3	1.39 V	142	23.0	13.7
9	15570.00	60.9 PK	74.0	-13.1	3.57 V	192	45.3	15.6
10	15570.00	47.0 AV	54.0	-7.0	3.57 V	192	31.4	15.6

REMARKS:

1. Emission Level(dBuV/m) = Raw Value(dBuV) + Correction Factor(dB/m)
2. Correction Factor(dB/m) = Antenna Factor(dB/m) + Cable Factor(dB) – Pre-Amplifier Factor(dB)
3. The other emission levels were very low against the limit.
4. Margin value = Emission Level – Limit value
5. " * ": Fundamental frequency.
6. " # ": The radiated frequency is out of the restricted band.

CHANNEL	TX Channel 46	DETECTOR FUNCTION	Peak (PK)
FREQUENCY RANGE	1GHz ~ 40GHz		Average (AV)

ANTENNA POLARITY & TEST DISTANCE: HORIZONTAL AT 3 M

NO.	FREQ. (MHz)	EMISSION LEVEL (dBuV/m)	LIMIT (dBuV/m)	MARGIN (dB)	ANTENNA HEIGHT (m)	TABLE ANGLE (Degree)	RAW VALUE (dBuV)	CORRECTION FACTOR (dB/m)
1	5150.00	62.5 PK	74.0	-11.5	2.03 H	130	59.5	3.0
2	5150.00	48.3 AV	54.0	-5.7	2.03 H	130	45.3	3.0
3	*5230.00	114.6 PK			2.03 H	130	111.4	3.2
4	*5230.00	104.7 AV			2.03 H	130	101.5	3.2
5	5350.00	54.9 PK	74.0	-19.1	2.03 H	130	51.4	3.5
6	5350.00	41.7 AV	54.0	-12.3	2.03 H	130	38.2	3.5
7	#10460.00	49.5 PK	74.0	-24.5	1.41 H	212	35.6	13.9
8	#10460.00	37.2 AV	54.0	-16.8	1.41 H	212	23.3	13.9
9	15690.00	54.4 PK	74.0	-19.6	1.56 H	186	38.8	15.6
10	15690.00	42.3 AV	54.0	-11.7	1.56 H	186	26.7	15.6

ANTENNA POLARITY & TEST DISTANCE: VERTICAL AT 3 M

NO.	FREQ. (MHz)	EMISSION LEVEL (dBuV/m)	LIMIT (dBuV/m)	MARGIN (dB)	ANTENNA HEIGHT (m)	TABLE ANGLE (Degree)	RAW VALUE (dBuV)	CORRECTION FACTOR (dB/m)
1	5150.00	64.0 PK	74.0	-10.0	3.56 V	171	61.0	3.0
2	5150.00	49.5 AV	54.0	-4.5	3.56 V	171	46.5	3.0
3	*5230.00	116.7 PK			3.56 V	171	113.5	3.2
4	*5230.00	106.6 AV			3.56 V	171	103.4	3.2
5	5350.00	56.5 PK	74.0	-17.5	3.56 V	171	53.0	3.5
6	5350.00	43.4 AV	54.0	-10.6	3.56 V	171	39.9	3.5
7	#10460.00	48.7 PK	74.0	-25.3	1.47 V	142	34.8	13.9
8	#10460.00	36.1 AV	54.0	-17.9	1.47 V	142	22.2	13.9
9	15690.00	60.7 PK	74.0	-13.3	3.54 V	181	45.1	15.6
10	15690.00	46.6 AV	54.0	-7.4	3.54 V	181	31.0	15.6

REMARKS:

- Emission Level(dBuV/m) = Raw Value(dBuV) + Correction Factor(dB/m)
- Correction Factor(dB/m) = Antenna Factor(dB/m) + Cable Factor(dB) – Pre-Amplifier Factor(dB)
- The other emission levels were very low against the limit.
- Margin value = Emission Level – Limit value
- " * ": Fundamental frequency.
- " # ": The radiated frequency is out of the restricted band.

CHANNEL	TX Channel 151	DETECTOR FUNCTION	Peak (PK)
FREQUENCY RANGE	1GHz ~ 40GHz		Average (AV)

ANTENNA POLARITY & TEST DISTANCE: HORIZONTAL AT 3 M

NO.	FREQ. (MHz)	EMISSION LEVEL (dBuV/m)	LIMIT (dBuV/m)	MARGIN (dB)	ANTENNA HEIGHT (m)	TABLE ANGLE (Degree)	RAW VALUE (dBuV)	CORRECTION FACTOR (dB/m)
1	#5645.48	64.2 PK	68.2	-4.0	3.68 H	242	60.2	4.0
2	*5755.00	118.8 PK			3.68 H	242	114.6	4.2
3	*5755.00	109.5 AV			3.68 H	242	105.3	4.2
4	#5968.48	61.9 PK	68.2	-6.3	3.68 H	242	57.4	4.5
5	11510.00	53.1 PK	74.0	-20.9	1.22 H	195	38.0	15.1
6	11510.00	40.9 AV	54.0	-13.1	1.22 H	195	25.8	15.1
7	#17265.00	59.7 PK	74.0	-14.3	3.39 H	258	39.8	19.9
8	#17265.00	48.2 AV	54.0	-5.8	3.39 H	258	28.3	19.9

ANTENNA POLARITY & TEST DISTANCE: VERTICAL AT 3 M

NO.	FREQ. (MHz)	EMISSION LEVEL (dBuV/m)	LIMIT (dBuV/m)	MARGIN (dB)	ANTENNA HEIGHT (m)	TABLE ANGLE (Degree)	RAW VALUE (dBuV)	CORRECTION FACTOR (dB/m)
1	#5644.05	67.1 PK	68.2	-1.1	3.96 V	177	63.1	4.0
2	*5755.00	121.8 PK			3.96 V	177	117.6	4.2
3	*5755.00	112.1 AV			3.96 V	177	107.9	4.2
4	#5937.60	60.9 PK	68.2	-7.3	3.96 V	177	56.5	4.4
5	11510.00	50.7 PK	74.0	-23.3	1.22 V	195	35.6	15.1
6	11510.00	41.0 AV	54.0	-13.0	1.22 V	195	25.9	15.1
7	#17265.00	60.7 PK	74.0	-13.3	2.11 V	188	40.8	19.9
8	#17265.00	47.3 AV	54.0	-6.7	2.11 V	188	27.4	19.9

REMARKS:

1. Emission Level(dBuV/m) = Raw Value(dBuV) + Correction Factor(dB/m)
2. Correction Factor(dB/m) = Antenna Factor(dB/m) + Cable Factor(dB) – Pre-Amplifier Factor(dB)
3. The other emission levels were very low against the limit.
4. Margin value = Emission Level – Limit value
5. " * ": Fundamental frequency.
6. " # ": The radiated frequency is out of the restricted band.

CHANNEL	TX Channel 159	DETECTOR FUNCTION	Peak (PK)
FREQUENCY RANGE	1GHz ~ 40GHz		Average (AV)

ANTENNA POLARITY & TEST DISTANCE: HORIZONTAL AT 3 M

NO.	FREQ. (MHz)	EMISSION LEVEL (dBuV/m)	LIMIT (dBuV/m)	MARGIN (dB)	ANTENNA HEIGHT (m)	TABLE ANGLE (Degree)	RAW VALUE (dBuV)	CORRECTION FACTOR (dB/m)
1	#5616.98	62.7 PK	68.2	-5.5	3.66 H	239	58.8	3.9
2	*5795.00	119.8 PK			3.66 H	239	115.7	4.1
3	*5795.00	108.6 AV			3.66 H	239	104.5	4.1
4	#5930.00	65.0 PK	68.2	-3.2	3.66 H	239	60.6	4.4
5	11590.00	53.1 PK	74.0	-20.9	1.29 H	216	38.0	15.1
6	11590.00	41.1 AV	54.0	-12.9	1.29 H	216	26.0	15.1
7	#17385.00	59.4 PK	74.0	-14.6	3.36 H	263	38.8	20.6
8	#17385.00	47.7 AV	54.0	-6.3	3.36 H	263	27.1	20.6

ANTENNA POLARITY & TEST DISTANCE: VERTICAL AT 3 M

NO.	FREQ. (MHz)	EMISSION LEVEL (dBuV/m)	LIMIT (dBuV/m)	MARGIN (dB)	ANTENNA HEIGHT (m)	TABLE ANGLE (Degree)	RAW VALUE (dBuV)	CORRECTION FACTOR (dB/m)
1	#5646.90	63.2 PK	68.2	-5.0	3.92 V	177	59.2	4.0
2	*5795.00	122.2 PK			3.92 V	177	118.1	4.1
3	*5795.00	112.4 AV			3.92 V	177	108.3	4.1
4	#5929.05	66.6 PK	68.2	-1.6	3.92 V	177	62.2	4.4
5	11590.00	50.4 PK	74.0	-23.6	1.25 V	187	35.3	15.1
6	11590.00	40.4 AV	54.0	-13.6	1.25 V	187	25.3	15.1
7	#17385.00	60.7 PK	74.0	-13.3	2.14 V	194	40.1	20.6
8	#17385.00	47.7 AV	54.0	-6.3	2.14 V	194	27.1	20.6

REMARKS:

1. Emission Level(dBuV/m) = Raw Value(dBuV) + Correction Factor(dB/m)
2. Correction Factor(dB/m) = Antenna Factor(dB/m) + Cable Factor(dB) – Pre-Amplifier Factor(dB)
3. The other emission levels were very low against the limit.
4. Margin value = Emission Level – Limit value
5. " * ": Fundamental frequency.
6. " # ": The radiated frequency is out of the restricted band.

802.11ac (VHT80)

CHANNEL	TX Channel 42	DETECTOR FUNCTION	Peak (PK)
FREQUENCY RANGE	1GHz ~ 40GHz		Average (AV)

ANTENNA POLARITY & TEST DISTANCE: HORIZONTAL AT 3 M

NO.	FREQ. (MHz)	EMISSION LEVEL (dBuV/m)	LIMIT (dBuV/m)	MARGIN (dB)	ANTENNA HEIGHT (m)	TABLE ANGLE (Degree)	RAW VALUE (dBuV)	CORRECTION FACTOR (dB/m)
1	5138.00	64.8 PK	74.0	-9.2	1.97 H	134	61.8	3.0
2	5138.00	52.4 AV	54.0	-1.6	1.97 H	134	49.4	3.0
3	*5210.00	107.4 PK			1.97 H	134	104.2	3.2
4	*5210.00	95.0 AV			1.97 H	134	91.8	3.2
5	5350.00	51.3 PK	74.0	-22.7	1.97 H	134	47.8	3.5
6	5350.00	39.9 AV	54.0	-14.1	1.97 H	134	36.4	3.5
7	#10420.00	49.8 PK	74.0	-24.2	1.37 H	190	36.0	13.8
8	#10420.00	37.8 AV	54.0	-16.2	1.37 H	190	24.0	13.8
9	15630.00	53.2 PK	74.0	-20.8	1.61 H	193	37.5	15.7
10	15630.00	41.6 AV	54.0	-12.4	1.61 H	193	25.9	15.7

ANTENNA POLARITY & TEST DISTANCE: VERTICAL AT 3 M

NO.	FREQ. (MHz)	EMISSION LEVEL (dBuV/m)	LIMIT (dBuV/m)	MARGIN (dB)	ANTENNA HEIGHT (m)	TABLE ANGLE (Degree)	RAW VALUE (dBuV)	CORRECTION FACTOR (dB/m)
1	5138.00	66.1 PK	74.0	-7.9	3.71 V	199	63.1	3.0
2	5138.00	53.4 AV	54.0	-0.6	3.71 V	199	50.4	3.0
3	*5210.00	108.6 PK			3.71 V	199	105.4	3.2
4	*5210.00	96.5 AV			3.71 V	199	93.3	3.2
5	5350.00	52.6 PK	74.0	-21.4	3.71 V	199	49.1	3.5
6	5350.00	41.0 AV	54.0	-13.0	3.71 V	199	37.5	3.5
7	#10420.00	48.7 PK	74.0	-25.3	1.47 V	148	34.9	13.8
8	#10420.00	36.2 AV	54.0	-17.8	1.47 V	148	22.4	13.8
9	15630.00	60.6 PK	74.0	-13.4	3.57 V	181	44.9	15.7
10	15630.00	46.5 AV	54.0	-7.5	3.57 V	181	30.8	15.7

REMARKS:

- Emission Level(dBuV/m) = Raw Value(dBuV) + Correction Factor(dB/m)
- Correction Factor(dB/m) = Antenna Factor(dB/m) + Cable Factor(dB) – Pre-Amplifier Factor(dB)
- The other emission levels were very low against the limit.
- Margin value = Emission Level – Limit value
- " * ": Fundamental frequency.
- " # ": The radiated frequency is out of the restricted band.

CHANNEL	TX Channel 155	DETECTOR FUNCTION	Peak (PK)
FREQUENCY RANGE	1GHz ~ 40GHz		Average (AV)

ANTENNA POLARITY & TEST DISTANCE: HORIZONTAL AT 3 M

NO.	FREQ. (MHz)	EMISSION LEVEL (dBuV/m)	LIMIT (dBuV/m)	MARGIN (dB)	ANTENNA HEIGHT (m)	TABLE ANGLE (Degree)	RAW VALUE (dBuV)	CORRECTION FACTOR (dB/m)
1	#5633.10	64.5 PK	74.0	-9.5	3.66 H	239	60.5	4.0
2	#5633.10	50.2 AV	54.0	-3.8	3.66 H	239	46.2	4.0
3	*5775.00	113.1 PK			3.65 H	239	108.9	4.2
4	*5775.00	100.1 AV			3.65 H	239	95.9	4.2
5	#5998.40	61.9 PK	74.0	-12.1	3.66 H	239	57.4	4.5
6	#5998.40	48.2 AV	54.0	-5.8	3.66 H	239	43.7	4.5
7	11550.00	53.1 PK	74.0	-20.9	1.32 H	198	37.9	15.2
8	11550.00	40.7 AV	54.0	-13.3	1.32 H	198	25.5	15.2
9	#17325.00	59.2 PK	74.0	-14.8	3.31 H	263	38.9	20.3
10	#17325.00	47.7 AV	54.0	-6.3	3.31 H	263	27.4	20.3

ANTENNA POLARITY & TEST DISTANCE: VERTICAL AT 3 M

NO.	FREQ. (MHz)	EMISSION LEVEL (dBuV/m)	LIMIT (dBuV/m)	MARGIN (dB)	ANTENNA HEIGHT (m)	TABLE ANGLE (Degree)	RAW VALUE (dBuV)	CORRECTION FACTOR (dB/m)
1	#5643.60	68.3 PK	74.0	-5.7	3.96 V	176	64.3	4.0
2	#5643.60	53.1 AV	54.0	-0.9	3.96 V	176	49.1	4.0
3	*5775.00	115.0 PK			3.96 V	176	110.8	4.2
4	*5775.00	103.5 AV			3.96 V	176	99.3	4.2
5	#5926.70	63.3 PK	74.0	-10.7	3.96 V	176	58.9	4.4
6	#5926.70	47.3 AV	54.0	-6.7	3.96 V	176	42.9	4.4
7	11550.00	51.3 PK	74.0	-22.7	1.23 V	204	36.1	15.2
8	11550.00	41.1 AV	54.0	-12.9	1.23 V	204	25.9	15.2
9	#17325.00	60.7 PK	74.0	-13.3	2.15 V	186	40.4	20.3
10	#17325.00	47.7 AV	54.0	-6.3	2.15 V	186	27.4	20.3

REMARKS:

1. Emission Level(dBuV/m) = Raw Value(dBuV) + Correction Factor(dB/m)
2. Correction Factor(dB/m) = Antenna Factor(dB/m) + Cable Factor(dB) – Pre-Amplifier Factor(dB)
3. The other emission levels were very low against the limit.
4. Margin value = Emission Level – Limit value
5. " * ": Fundamental frequency.
6. " # ": The radiated frequency is out of the restricted band.

802.11ac (VHT80+80)

CHANNEL	TX Channel 42+155	DETECTOR FUNCTION	Peak (PK)
FREQUENCY RANGE	1GHz ~ 40GHz		Average (AV)

ANTENNA POLARITY & TEST DISTANCE: HORIZONTAL AT 3 M

NO.	FREQ. (MHz)	EMISSION LEVEL (dBuV/m)	LIMIT (dBuV/m)	MARGIN (dB)	ANTENNA HEIGHT (m)	TABLE ANGLE (Degree)	RAW VALUE (dBuV)	CORRECTION FACTOR (dB/m)
1	5138.00	62.1 PK	74.0	-11.9	3.50 H	80	59.1	3.0
2	5138.00	49.4 AV	54.0	-4.6	3.50 H	80	46.4	3.0
3	*5210.00	113.5 PK			3.50 H	80	110.3	3.2
4	*5210.00	101.0 AV			3.50 H	80	97.8	3.2
5	5350.00	59.8 PK	74.0	-14.2	3.50 H	80	56.3	3.5
6	5350.00	45.6 AV	54.0	-8.4	3.50 H	80	42.1	3.5
7	#5644.52	58.4 PK	68.2	-9.8	2.84 H	321	54.4	4.0
8	*5775.00	114.2 PK			2.84 H	321	110.0	4.2
9	*5775.00	99.9 AV			2.84 H	321	95.7	4.2
10	#5938.07	55.8 PK	68.2	-12.4	2.84 H	321	51.4	4.4
11	#10420.00	52.3 PK	74.0	-21.7	1.69 H	110	38.5	13.8
12	#10420.00	40.8 AV	54.0	-13.2	1.69 H	110	27.0	13.8
13	11550.00	54.2 PK	74.0	-19.8	1.55 H	52	39.0	15.2
14	11550.00	41.2 AV	54.0	-12.8	1.55 H	52	26.0	15.2
15	15630.00	55.0 PK	74.0	-19.0	1.91 H	172	39.3	15.7
16	15630.00	42.8 AV	54.0	-11.2	1.91 H	172	27.1	15.7
17	#17325.00	58.2 PK	74.0	-15.8	1.50 H	77	37.9	20.3
18	#17325.00	46.0 AV	54.0	-8.0	1.50 H	77	25.7	20.3

ANTENNA POLARITY & TEST DISTANCE: VERTICAL AT 3 M

NO.	FREQ. (MHz)	EMISSION LEVEL (dBuV/m)	LIMIT (dBuV/m)	MARGIN (dB)	ANTENNA HEIGHT (m)	TABLE ANGLE (Degree)	RAW VALUE (dBuV)	CORRECTION FACTOR (dB/m)
1	5138.00	66.3 PK	74.0	-7.7	3.55 V	180	63.3	3.0
2	5138.00	53.1 AV	54.0	-0.9	3.55 V	180	50.1	3.0
3	*5210.00	113.7 PK			3.55 V	180	110.5	3.2
4	*5210.00	101.1 AV			3.55 V	180	97.9	3.2
5	5350.00	59.6 PK	74.0	-14.4	3.55 V	180	56.1	3.5
6	5350.00	45.5 AV	54.0	-8.5	3.55 V	180	42.0	3.5
7	#5601.30	58.5 PK	68.2	-9.7	2.84 V	316	54.6	3.9
8	*5775.00	108.8 PK			3.76 V	183	104.6	4.2
9	*5775.00	96.9 AV			3.76 V	183	92.7	4.2
10	#5934.27	56.5 PK	68.2	-11.7	2.84 V	316	52.1	4.4
11	#10420.00	52.5 PK	74.0	-21.5	1.27 V	209	38.7	13.8
12	#10420.00	41.2 AV	54.0	-12.8	1.27 V	209	27.4	13.8
13	11550.00	53.9 PK	74.0	-20.1	1.52 V	182	38.7	15.2
14	11550.00	41.7 AV	54.0	-12.3	1.52 V	182	26.5	15.2
15	15630.00	55.4 PK	74.0	-18.6	2.13 V	166	39.7	15.7
16	15630.00	43.1 AV	54.0	-10.9	2.13 V	166	27.4	15.7
17	#17325.00	57.4 PK	74.0	-16.6	1.78 V	213	37.1	20.3
18	#17325.00	44.5 AV	54.0	-9.5	1.78 V	213	24.2	20.3

REMARKS:

1. Emission Level(dBuV/m) = Raw Value(dBuV) + Correction Factor(dB/m)
2. Correction Factor(dB/m) = Antenna Factor(dB/m) + Cable Factor(dB) – Pre-Amplifier Factor(dB)
3. The other emission levels were very low against the limit.
4. Margin value = Emission Level – Limit value
5. " * ": Fundamental frequency.
6. " # ": The radiated frequency is out of the restricted band.

Below 1GHz Data :

802.11ac (VHT20)

CHANNEL	TX Channel 165	DETECTOR FUNCTION	Quasi-Peak (QP)
FREQUENCY RANGE	Below 1GHz		

ANTENNA POLARITY & TEST DISTANCE: HORIZONTAL AT 3 M

NO.	FREQ. (MHz)	EMISSION LEVEL (dBuV/m)	LIMIT (dBuV/m)	MARGIN (dB)	ANTENNA HEIGHT (m)	TABLE ANGLE (Degree)	RAW VALUE (dBuV)	CORRECTION FACTOR (dB/m)
1	80.83	31.4 QP	40.0	-8.6	2.00 H	263	44.4	-13.0
2	153.80	39.9 QP	43.5	-3.6	2.00 H	112	48.2	-8.3
3	216.74	37.4 QP	46.0	-8.6	1.50 H	188	48.7	-11.3
4	258.00	34.9 QP	46.0	-11.1	1.00 H	299	44.1	-9.2
5	375.00	40.5 QP	46.0	-5.5	1.00 H	178	46.0	-5.5
6	500.00	37.6 QP	46.0	-8.4	2.00 H	143	39.9	-2.3

ANTENNA POLARITY & TEST DISTANCE: VERTICAL AT 3 M

NO.	FREQ. (MHz)	EMISSION LEVEL (dBuV/m)	LIMIT (dBuV/m)	MARGIN (dB)	ANTENNA HEIGHT (m)	TABLE ANGLE (Degree)	RAW VALUE (dBuV)	CORRECTION FACTOR (dB/m)
1	53.00	36.7 QP	40.0	-3.3	1.00 V	315	45.0	-8.3
2	73.51	36.3 QP	40.0	-3.7	1.00 V	247	47.4	-11.1
3	125.01	34.8 QP	43.5	-8.7	1.00 V	226	45.3	-10.5
4	155.01	35.0 QP	43.5	-8.5	1.00 V	107	43.4	-8.4
5	375.00	35.6 QP	46.0	-10.4	1.00 V	314	41.1	-5.5
6	499.99	32.6 QP	46.0	-13.4	1.00 V	39	34.9	-2.3

REMARKS:

1. Emission Level(dBuV/m) = Raw Value(dBuV) + Correction Factor(dB/m)
2. Correction Factor(dB/m) = Antenna Factor(dB/m) + Cable Factor(dB) – Pre-Amplifier Factor(dB)
3. The other emission levels were very low against the limit.
4. Margin value = Emission Level – Limit value

4.1.8 Test Results (Mode 2)

Below 1GHz Data :

802.11ac (VHT20)

CHANNEL	TX Channel 165	DETECTOR FUNCTION	Quasi-Peak (QP)
FREQUENCY RANGE	Below 1GHz		

ANTENNA POLARITY & TEST DISTANCE: HORIZONTAL AT 3 M								
NO.	FREQ. (MHz)	EMISSION LEVEL (dBuV/m)	LIMIT (dBuV/m)	MARGIN (dB)	ANTENNA HEIGHT (m)	TABLE ANGLE (Degree)	RAW VALUE (dBuV)	CORRECTION FACTOR (dB/m)
1	66.40	31.8 QP	40.0	-8.2	1.50 H	350	41.6	-9.8
2	93.40	30.8 QP	43.5	-12.7	1.50 H	250	44.7	-13.9
3	209.20	33.9 QP	43.5	-9.6	1.10 H	251	45.3	-11.4
4	236.10	36.5 QP	46.0	-9.5	1.50 H	252	46.7	-10.2
5	330.52	36.4 QP	46.0	-9.6	1.00 H	100	42.9	-6.5
6	370.15	33.6 QP	46.0	-12.4	1.50 H	300	39.2	-5.6
ANTENNA POLARITY & TEST DISTANCE: VERTICAL AT 3 M								
NO.	FREQ. (MHz)	EMISSION LEVEL (dBuV/m)	LIMIT (dBuV/m)	MARGIN (dB)	ANTENNA HEIGHT (m)	TABLE ANGLE (Degree)	RAW VALUE (dBuV)	CORRECTION FACTOR (dB/m)
1	40.50	38.8 QP	40.0	-1.2	1.50 V	10	47.8	-9.0
2	66.44	35.9 QP	40.0	-4.1	1.00 V	260	45.7	-9.8
3	125.10	33.7 QP	43.5	-9.8	1.00 V	104	44.2	-10.5
4	146.30	32.4 QP	43.5	-11.1	1.50 V	100	41.0	-8.6
5	329.60	30.4 QP	46.0	-15.6	1.00 V	102	36.9	-6.5
6	625.10	30.2 QP	46.0	-15.8	1.00 V	158	29.8	0.4

REMARKS:

1. Emission Level(dBuV/m) = Raw Value(dBuV) + Correction Factor(dB/m)
2. Correction Factor(dB/m) = Antenna Factor(dB/m) + Cable Factor(dB) – Pre-Amplifier Factor(dB)
3. The other emission levels were very low against the limit.
4. Margin value = Emission Level – Limit value

4.2 Conducted Emission Measurement

4.2.1 Limits of Conducted Emission Measurement

Frequency (MHz)	Conducted Limit (dBuV)	
	Quasi-peak	Average
0.15 - 0.5	66 - 56	56 - 46
0.50 - 5.0	56	46
5.0 - 30.0	60	50

Note: 1. The lower limit shall apply at the transition frequencies.

2. The limit decreases in line with the logarithm of the frequency in the range of 0.15 to 0.50MHz.

4.2.2 Test Instruments

DESCRIPTION & MANUFACTURER	MODEL NO.	SERIAL NO.	CALIBRATED DATE	CALIBRATED UNTIL
Test Receiver R&S	ESCS 30	847124/029	Oct. 23, 2015	Oct. 22, 2016
Line-Impedance Stabilization Network (for EUT) R&S	ESH3-Z5	848773/004	Oct. 28, 2015	Oct. 27, 2016
RF Cable	5D-FB	COACAB-002	Mar. 04, 2016	Mar. 03, 2017
10 dB PAD Mini-Circuits	HAT-10+	CONATT-004	Jun. 20, 2016	Jun. 19, 2017
Software BVADT	BVADT_Cond_ V7.3.7.3	NA	NA	NA

Note:

1. The calibration interval of the above test instruments are 12 months and the calibrations are traceable to NML/ROC and NIST/USA.
2. The test was performed in Shielded Room No. 1.
- 3 Tested Date: June 21 to Aug. 16, 2016

4.2.3 Test Procedure

- The EUT was placed 0.4 meters from the conducting wall of the shielded room with EUT being connected to the power mains through a line impedance stabilization network (LISN). Other support units were connected to the power mains through another LISN. The two LISNs provide 50 ohm/ 50uH of coupling impedance for the measuring instrument.
- Both lines of the power mains connected to the EUT were checked for maximum conducted interference.
- The frequency range from 150kHz to 30MHz was searched. Emission levels under (Limit - 20dB) was not recorded.

NOTE: All modes of operation were investigated and the worst-case emissions are reported.

4.2.4 Deviation from Test Standard

No deviation.

4.2.5 Test Setup

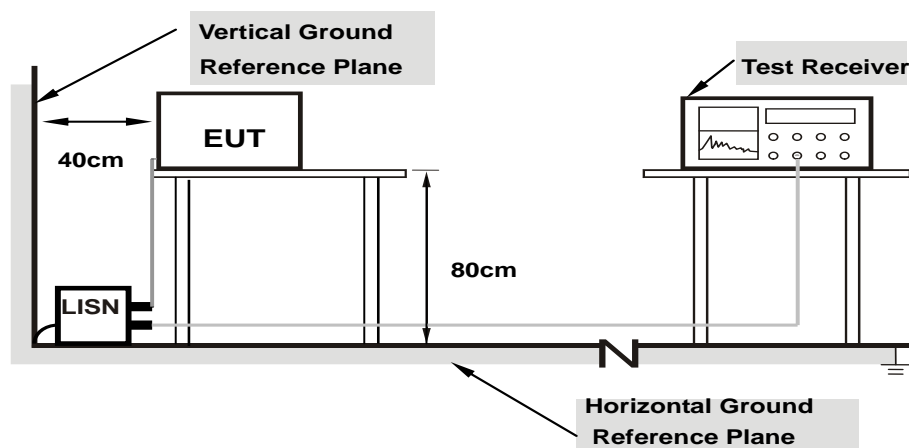

Note: 1.Support units were connected to second LISN.

For the actual test configuration, please refer to the attached file (Test Setup Photo).

4.2.6 EUT Operating Condition

Same as 4.1.6.

4.2.7 Test Results (Mode 1)

Phase	Line (L)	Detector Function	Quasi-Peak (QP) / Average (AV)
-------	----------	-------------------	--------------------------------

Phase Of Power : Line (L)										
No	Frequency (MHz)	Correction Factor (dB)	Reading Value (dBuV)		Emission Level (dBuV)		Limit (dBuV)		Margin (dB)	
			Q.P.	AV.	Q.P.	AV.	Q.P.	AV.	Q.P.	AV.
1	0.15000	10.21	34.37	25.05	44.58	35.26	66.00	56.00	-21.42	-20.74
2	0.22678	10.22	32.17	26.20	42.39	36.42	62.57	52.57	-20.18	-16.15
3	0.33750	10.22	22.57	16.54	32.79	26.76	59.26	49.26	-26.47	-22.50
4	0.91563	10.25	19.75	12.58	30.00	22.83	56.00	46.00	-26.00	-23.17
5	7.48828	10.48	22.40	17.27	32.88	27.75	60.00	50.00	-27.12	-22.25
6	24.00000	11.43	33.56	33.49	44.99	44.92	60.00	50.00	-15.01	-5.08

Remarks:

1. Q.P. and AV. are abbreviations of quasi-peak and average individually.
2. The emission levels of other frequencies were very low against the limit.
3. Margin value = Emission level – Limit value
4. Correction factor = Insertion loss + Cable loss
5. Emission Level = Correction Factor + Reading Value

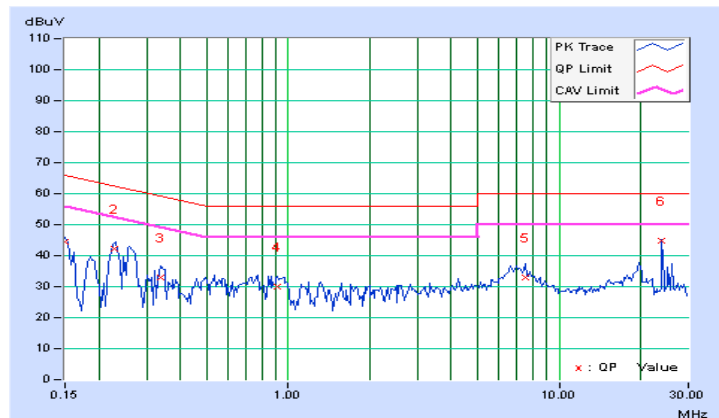

Phase	Neutral (N)	Detector Function	Quasi-Peak (QP) / Average (AV)
-------	-------------	-------------------	--------------------------------

Phase Of Power : Neutral (N)										
No	Frequency (MHz)	Correction Factor (dB)	Reading Value (dBuV)		Emission Level (dBuV)		Limit (dBuV)		Margin (dB)	
			Q.P.	AV.	Q.P.	AV.	Q.P.	AV.	Q.P.	AV.
1	0.15391	10.19	33.15	23.99	43.34	34.18	65.79	55.79	-22.44	-21.60
2	0.22728	10.21	32.04	26.32	42.25	36.53	62.55	52.55	-20.30	-16.02
3	0.53650	10.21	20.79	13.93	31.00	24.14	56.00	46.00	-25.00	-21.86
4	0.94688	10.24	20.03	13.03	30.27	23.27	56.00	46.00	-25.73	-22.73
5	6.94141	10.37	22.95	17.68	33.32	28.05	60.00	50.00	-26.68	-21.95
6	24.00000	11.13	33.02	33.02	44.15	44.15	60.00	50.00	-15.85	-5.85

Remarks:

1. Q.P. and AV. are abbreviations of quasi-peak and average individually.
2. The emission levels of other frequencies were very low against the limit.
3. Margin value = Emission level – Limit value
4. Correction factor = Insertion loss + Cable loss
5. Emission Level = Correction Factor + Reading Value

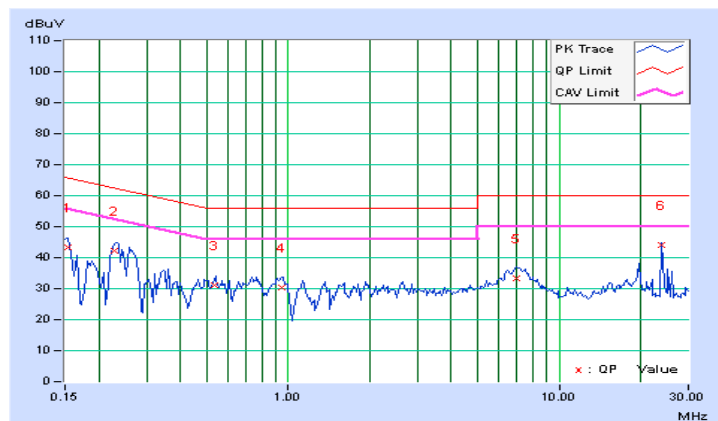

4.2.8 Test Results (Mode 2)

Phase	Line (L)	Detector Function	Quasi-Peak (QP) / Average (AV)
-------	----------	-------------------	--------------------------------

Phase Of Power : Line (L)										
No	Frequency (MHz)	Correction Factor (dB)	Reading Value (dBuV)		Emission Level (dBuV)		Limit (dBuV)		Margin (dB)	
			Q.P.	AV.	Q.P.	AV.	Q.P.	AV.	Q.P.	AV.
1	0.15391	10.21	41.69	27.97	51.90	38.18	65.79	55.79	-13.89	-17.61
2	0.21250	10.22	33.98	19.91	44.20	30.13	63.11	53.11	-18.91	-22.98
3	0.59922	10.23	18.92	12.69	29.15	22.92	56.00	46.00	-26.85	-23.08
4	2.58594	10.30	11.17	7.41	21.47	17.71	56.00	46.00	-34.53	-28.29
5	15.20313	11.08	19.20	14.91	30.28	25.99	60.00	50.00	-29.72	-24.01
6	25.22656	11.45	23.44	20.96	34.89	32.41	60.00	50.00	-25.11	-17.59

Remarks:

1. Q.P. and AV. are abbreviations of quasi-peak and average individually.
2. The emission levels of other frequencies were very low against the limit.
3. Margin value = Emission level – Limit value
4. Correction factor = Insertion loss + Cable loss
5. Emission Level = Correction Factor + Reading Value

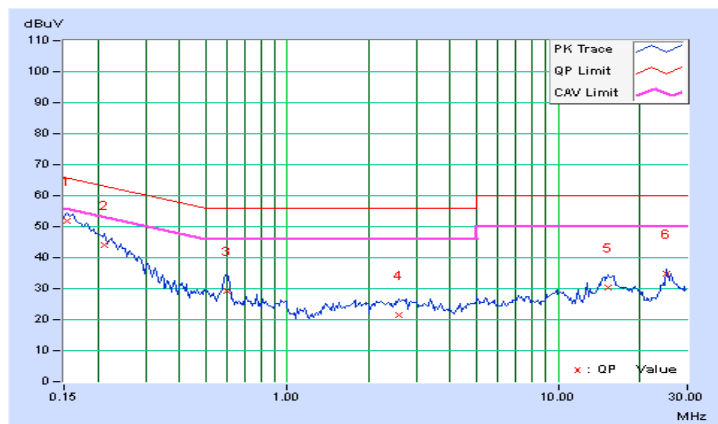

Phase	Neutral (N)	Detector Function	Quasi-Peak (QP) / Average (AV)
-------	-------------	-------------------	--------------------------------

Phase Of Power : Neutral (N)										
No	Frequency (MHz)	Correction Factor (dB)	Reading Value (dBuV)		Emission Level (dBuV)		Limit (dBuV)		Margin (dB)	
			Q.P.	AV.	Q.P.	AV.	Q.P.	AV.	Q.P.	AV.
1	0.15391	10.19	41.61	28.35	51.80	38.54	65.79	55.79	-13.98	-17.24
2	0.20469	10.21	34.58	20.70	44.79	30.91	63.42	53.42	-18.63	-22.51
3	0.26328	10.21	29.00	16.05	39.21	26.26	61.33	51.33	-22.12	-25.07
4	0.59141	10.21	20.36	14.95	30.57	25.16	56.00	46.00	-25.43	-20.84
5	15.43750	10.91	20.46	16.06	31.37	26.97	60.00	50.00	-28.63	-23.03
6	25.23047	11.13	24.16	21.70	35.29	32.83	60.00	50.00	-24.71	-17.17

Remarks:

1. Q.P. and AV. are abbreviations of quasi-peak and average individually.
2. The emission levels of other frequencies were very low against the limit.
3. Margin value = Emission level – Limit value
4. Correction factor = Insertion loss + Cable loss
5. Emission Level = Correction Factor + Reading Value

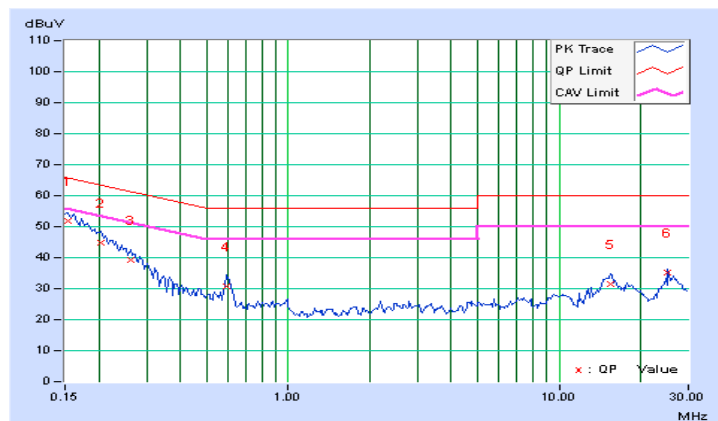

4.3 Transmit Power Measurement

4.3.1 Limits of Transmit Power Measurement

Operation Band	EUT Category		Limit
U-NII-1		Outdoor Access Point	1 Watt (30 dBm) (Max. e.i.r.p \leq 125mW(21 dBm) at any elevation angle above 30 degrees as measured from the horizon)
		Fixed point-to-point Access Point	1 Watt (30 dBm)
	√	Indoor Access Point	1 Watt (30 dBm)
		Mobile and Portable client device	250mW (24 dBm)
U-NII-2A			250mW (24 dBm) or 11 dBm+10 log B*
U-NII-2C			250mW (24 dBm) or 11 dBm+10 log B*
U-NII-3	√		1 Watt (30 dBm)

*B is the 26 dB emission bandwidth in megahertz

Per KDB 662911 Method of conducted output power measurement on IEEE 802.11 devices,

Array Gain = 0 dB (i.e., no array gain) for $N_{ANT} \leq 4$;

Array Gain = 0 dB (i.e., no array gain) for channel widths ≥ 40 MHz for any N_{ANT} ;

Array Gain = 5 log(N_{ANT}/N_{SS}) dB or 3 dB, whichever is less for 20-MHz channel widths with $N_{ANT} \geq 5$.

For power measurements on all other devices: Array Gain = 10 log(N_{ANT}/N_{SS}) dB.

4.3.2 Test Setup

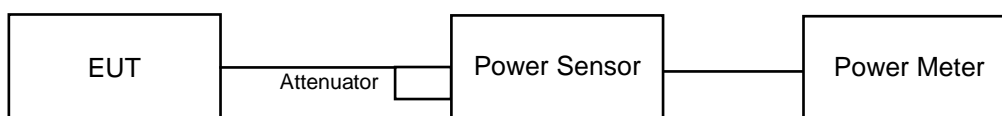

4.3.3 Test Instruments

DESCRIPTION & MANUFACTURER	MODEL NO.	SERIAL NO.	CALIBRATED DATE	CALIBRATED UNTIL
Power meter Anritsu	ML2495A	0824006	May 26, 2016	May 25, 2017
Power sensor Anritsu	MA2411B	0738172	May 26, 2016	May 25, 2017

Note:

1. The calibration interval of the above test instruments is 12 months and the calibrations are traceable to NML/ROC and NIST/USA.
2. Tested Date: July 15, 2016

4.3.4 Test Procedure

Method PM is used to perform output power measurement, trigger and gating function of wide band power meter is enabled to measure max output power of TX on burst. Duty factor is not added to measured value.

4.3.5 Deviation from Test Standard

No deviation.

4.3.6 EUT Operating Condition

The software provided by client to enable the EUT under transmission condition continuously at lowest, middle and highest channel frequencies individually.

4.3.7 Test Result

CDD Mode

802.11a

Chan.	Chan. Freq. (MHz)	Maximum Conducted Power (dBm)				Total Power (mW)	Total Power (dBm)	Limit (dBm)	Pass / Fail
		Chain 0	Chain 1	Chain 2	Chain 3				
36	5180	18.79	18.39	18.54	18.44	285.98	24.56	30.00	Pass
40	5200	18.80	18.40	18.50	18.54	287.286	24.58	30.00	Pass
48	5240	18.77	18.55	18.44	18.49	287.405	24.58	30.00	Pass
149	5745	23.80	23.59	23.54	23.28	907.201	29.58	29.79	Pass
157	5785	23.59	23.58	23.42	23.58	904.414	29.56	29.79	Pass
165	5825	23.62	23.60	23.52	23.44	904.936	29.57	29.79	Pass

Note: 1. For UNII-3: Antenna gain (Max.) = 6.21dBi > 6dBi , so the power limit shall be reduced to $30-(6.21-6) = 29.79\text{dBm}$.

802.11ac (VHT20)

Chan.	Chan. Freq. (MHz)	Maximum Conducted Power (dBm)				Total Power (mW)	Total Power (dBm)	Limit (dBm)	Pass / Fail
		Chain 0	Chain 1	Chain 2	Chain 3				
36	5180	18.80	18.14	18.52	18.52	283.263	24.52	30.00	Pass
40	5200	18.65	18.16	18.51	18.44	279.527	24.46	30.00	Pass
48	5240	18.70	18.20	18.69	18.22	280.535	24.48	30.00	Pass
149	5745	23.12	23.55	23.54	23.59	886.084	29.47	29.79	Pass
157	5785	23.45	23.92	23.47	23.92	936.848	29.72	29.79	Pass
165	5825	23.50	24.07	23.26	24.16	951.593	29.78	29.79	Pass

Note: 1. For UNII-3: Antenna gain (Max.) = 6.21dBi > 6dBi , so the power limit shall be reduced to $30-(6.21-6) = 29.79\text{dBm}$.

802.11ac (VHT40)

Chan.	Chan. Freq. (MHz)	Maximum Conducted Power (dBm)				Total Power (mW)	Total Power (dBm)	Limit (dBm)	Pass / Fail
		Chain 0	Chain 1	Chain 2	Chain 3				
38	5190	16.86	16.24	17.29	16.92	193.386	22.86	30.00	Pass
46	5230	21.65	20.92	21.48	20.93	534.298	27.28	30.00	Pass
151	5755	23.59	23.46	23.17	23.54	883.815	29.46	29.79	Pass
159	5795	22.99	23.49	23.10	23.71	861.561	29.35	29.79	Pass

Note: 1. For UNII-3: Antenna gain (Max.) = 6.21dBi > 6dBi , so the power limit shall be reduced to $30-(6.21-6) = 29.79\text{dBm}$.

802.11ac (VHT80)

Chan.	Chan. Freq. (MHz)	Maximum Conducted Power (dBm)				Total Power (mW)	Total Power (dBm)	Limit (dBm)	Pass / Fail
		Chain 0	Chain 1	Chain 2	Chain 3				
42	5210	16.29	15.11	16.20	15.67	153.579	21.86	30.00	Pass
155	5775	19.86	20.05	20.27	20.20	409.113	26.12	29.79	Pass

Note: 1. For UNII-3: Antenna gain (Max.) = 6.21dBi > 6dBi , so the power limit shall be reduced to $30-(6.21-6) = 29.79\text{dBm}$.

802.11ac (VHT80+80)

Chan.	Chan. Freq. (MHz)	Maximum Conducted Power (dBm)				Total Power (mW)	Total Power (dBm)	Limit (dBm)	Pass / Fail
		Chain 0	Chain 1	Chain 2	Chain 3				
42	5210	20.81	21.19	-	-	252.026	24.01	30.00	Pass
155	5775	-	-	20.33	20.41	217.796	23.38	29.79	Pass

Note: 1. For UNII-3: Antenna gain (Max.) = 6.21dBi > 6dBi , so the power limit shall be reduced to $30-(6.21-6) = 29.79\text{dBm}$.

Beamforming Mode

802.11ac (VHT20)

Chan.	Chan. Freq. (MHz)	Maximum Conducted Power (dBm)				Total Power (mW)	Total Power (dBm)	Limit (dBm)	Pass / Fail
		Chain 0	Chain 1	Chain 2	Chain 3				
36	5180	18.80	18.14	18.52	18.52	283.263	24.52	24.86	Pass
40	5200	18.65	18.16	18.51	18.44	279.527	24.46	24.86	Pass
48	5240	18.70	18.20	18.69	18.22	280.535	24.48	24.86	Pass
149	5745	18.29	18.33	18.89	18.16	278.44	24.45	24.55	Pass
157	5785	18.20	18.42	18.90	18.22	279.57	24.46	24.55	Pass
165	5825	18.26	18.16	18.86	18.20	275.434	24.40	24.55	Pass

- Note:** 1. For UNII-1: Directional gain = $10 \log[(10^{G1/20} + 10^{G2/20} + 10^{G3/20} + 10^{G4/20})^2 / 4]$ = 11.14dBi > 6dBi , so the power limit shall be reduced to $30-(11.14-6) = 24.86$ dBm.
 2. For UNII-3: Directional gain = $10 \log[(10^{G1/20} + 10^{G2/20} + 10^{G3/20} + 10^{G4/20})^2 / 4]$ = 11.45dBi > 6dBi , so the power limit shall be reduced to $30-(11.45-6) = 24.55$ dBm.

802.11ac (VHT40)

Chan.	Chan. Freq. (MHz)	Maximum Conducted Power (dBm)				Total Power (mW)	Total Power (dBm)	Limit (dBm)	Pass / Fail
		Chain 0	Chain 1	Chain 2	Chain 3				
38	5190	16.86	16.24	17.29	16.92	193.386	22.86	24.86	Pass
46	5230	18.32	18.42	18.92	18.20	281.474	24.49	24.86	Pass
151	5755	18.30	18.38	18.86	18.26	280.374	24.48	24.55	Pass
159	5795	18.26	18.32	18.88	18.32	280.096	24.47	24.55	Pass

- Note:** 1. For UNII-1: Directional gain = $10 \log[(10^{G1/20} + 10^{G2/20} + 10^{G3/20} + 10^{G4/20})^2 / 4]$ = 11.14dBi > 6dBi , so the power limit shall be reduced to $30-(11.14-6) = 24.86$ dBm.
 2. For UNII-3: Directional gain = $10 \log[(10^{G1/20} + 10^{G2/20} + 10^{G3/20} + 10^{G4/20})^2 / 4]$ = 11.45dBi > 6dBi , so the power limit shall be reduced to $30-(11.45-6) = 24.55$ dBm.

802.11ac (VHT80)

Chan.	Chan. Freq. (MHz)	Maximum Conducted Power (dBm)				Total Power (mW)	Total Power (dBm)	Limit (dBm)	Pass / Fail
		Chain 0	Chain 1	Chain 2	Chain 3				
42	5210	16.29	15.11	16.20	15.67	153.579	21.86	24.86	Pass
155	5775	18.20	18.36	18.80	18.32	278.396	24.45	24.55	Pass

- Note:** 1. For UNII-1: Directional gain = $10 \log[(10^{G1/20} + 10^{G2/20} + 10^{G3/20} + 10^{G4/20})^2 / 4] = 11.14\text{dBi} > 6\text{dBi}$, so the power limit shall be reduced to $30 - (11.14 - 6) = 24.86\text{dBm}$.
2. For UNII-3: Directional gain = $10 \log[(10^{G1/20} + 10^{G2/20} + 10^{G3/20} + 10^{G4/20})^2 / 4] = 11.45\text{dBi} > 6\text{dBi}$, so the power limit shall be reduced to $30 - (11.45 - 6) = 24.55\text{dBm}$.

802.11ac (VHT80+80)

Chan.	Chan. Freq. (MHz)	Maximum Conducted Power (dBm)				Total Power (mW)	Total Power (dBm)	Limit (dBm)	Pass / Fail
		Chain 0	Chain 1	Chain 2	Chain 3				
42	5210	20.81	21.19	-	-	252.026	24.01	27.71	Pass
155	5775	-	-	20.33	20.41	217.796	23.38	27.18	Pass

- Note:** 1. For UNII-1: Directional gain = $10 \log[(10^{G1/20} + 10^{G2/20})^2 / 2] = 8.29\text{dBi} > 6\text{dBi}$, so the power limit shall be reduced to $30 - (8.29 - 6) = 27.71\text{dBm}$.
2. For UNII-3: Directional gain = $10 \log[(10^{G3/20} + 10^{G4/20})^2 / 2] = 8.82\text{dBi} > 6\text{dBi}$, so the power limit shall be reduced to $30 - (8.82 - 6) = 27.18\text{dBm}$.

4.4 Occupied Bandwidth Measurement

4.4.1 Test Setup

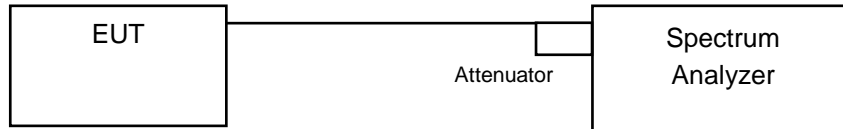

4.4.2 Test Instruments

DESCRIPTION & MANUFACTURER	MODEL NO.	SERIAL NO.	CALIBRATED DATE	CALIBRATED UNTIL
Spectrum Analyzer R&S	FSP40	100036	Jan. 27, 2016	Jan. 26, 2017

Note:

1. The calibration interval of the above test instruments is 12 months and the calibrations are traceable to NML/ROC and NIST/USA.
2. Tested Date: July 15, 2016

4.4.3 Test Procedure

The transmitter output was connected to the spectrum analyzer through an attenuator. The bandwidth of the fundamental frequency was measured by spectrum analyzer with resolution bandwidth in the range of 1% to 5% of the anticipated emission bandwidth, and a video bandwidth at least 3x the resolution bandwidth and set the detector to SAMPLE. The width of a frequency band such that, below the lower and above the upper frequency limits, the mean powers emitted are each equal to a specified percentage 0.5 %of the total mean power of a given emission.

802.11a

Channel	Channel Frequency (MHz)	Occupied Bandwidth (MHz)			
		Chain 0	Chain 1	Chain 2	Chain 3
36	5180	16.56	16.44	16.44	16.56
40	5200	16.56	16.56	16.56	16.44
48	5240	16.56	16.44	16.44	16.44
149	5745	16.44	16.56	16.44	16.68
157	5785	16.56	16.56	16.68	16.56
165	5825	16.56	16.68	16.56	16.56

802.11ac (VHT20)

Channel	Channel Frequency (MHz)	Occupied Bandwidth (MHz)			
		Chain 0	Chain 1	Chain 2	Chain 3
36	5180	17.76	17.64	17.64	17.64
40	5200	17.64	17.64	17.64	17.64
48	5240	17.64	17.64	17.64	17.76
149	5745	17.64	17.64	17.64	17.64
157	5785	17.64	17.64	17.76	17.76
165	5825	17.76	17.64	17.76	17.64

802.11ac (VHT40)

Channel	Channel Frequency (MHz)	Occupied Bandwidth (MHz)			
		Chain 0	Chain 1	Chain 2	Chain 3
38	5190	36.24	36.24	36.24	36.24
46	5230	36.24	36.24	36.24	36.24
151	5755	36.24	36.24	36.24	36.24
159	5795	36.48	36.48	36.48	36.48

802.11ac (VHT80)

Channel	Channel Frequency (MHz)	Occupied Bandwidth (MHz)			
		Chain 0	Chain 1	Chain 2	Chain 3
42	5210	75.84	75.84	75.84	75.84
155	5775	76.32	76.32	75.84	75.84

802.11ac (VHT80+80)

Channel	Channel Frequency (MHz)	Occupied Bandwidth (MHz)			
		Chain 0	Chain 1	Chain 2	Chain 3
42	5210	75.84	75.84	-	--
155	5775	-	-	75.84	75.84

Spectrum Plot of Worst Value

802.11a / Chain 1 : CH165

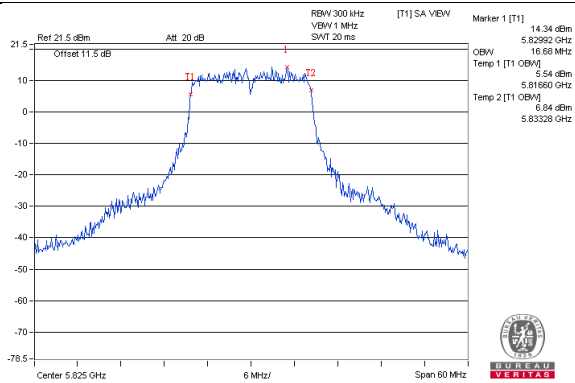

802.11ac (VHT20) / Chain 0 : CH36

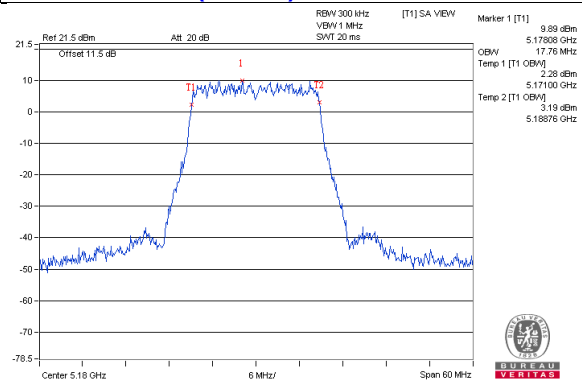

802.11ac (VHT40) / Chain 0 : CH159

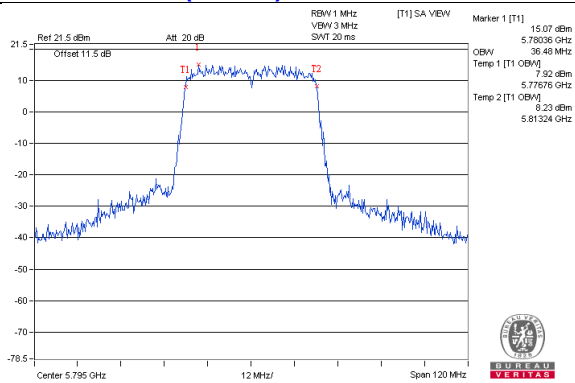

802.11ac (VHT80 / Chain 0 : CH155

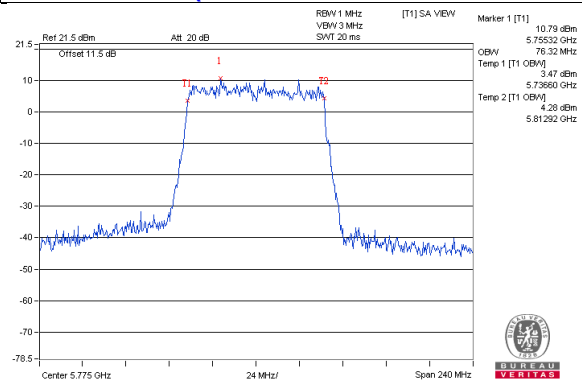

802.11ac (VHT80+80) / Chain 0 : CH42

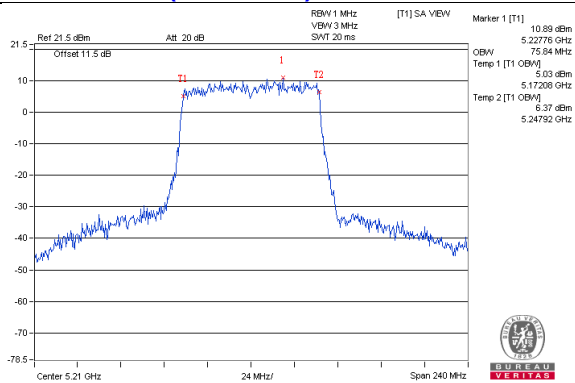

**Spectrum Plot for near by DFS band
(DFS is required, if 99% OCP straddle into U-NII-2A band)**

802.11a / Chain 0 : CH48

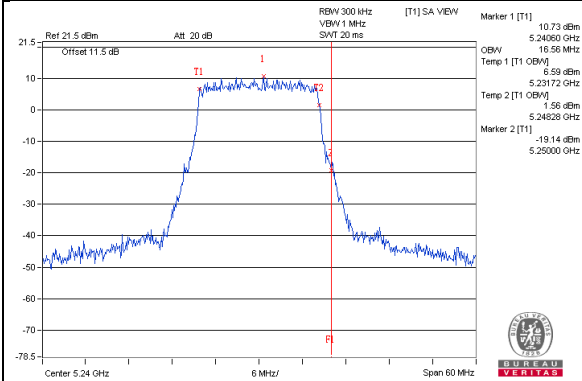

802.11a / Chain 1 : CH48

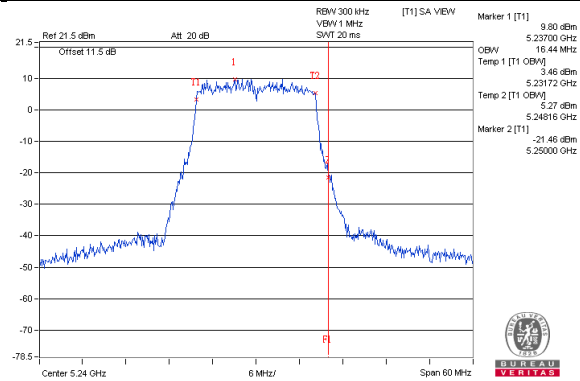

802.11a / Chain 2 : CH48

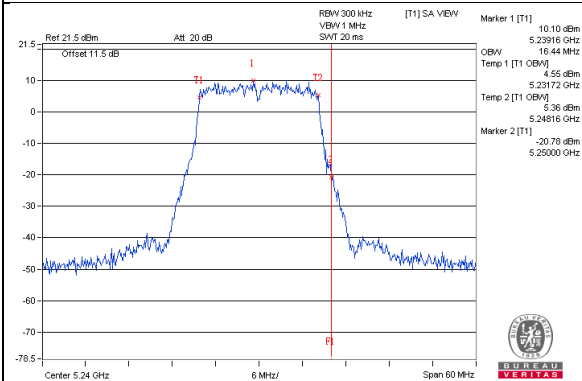

802.11a / Chain 3 : CH48

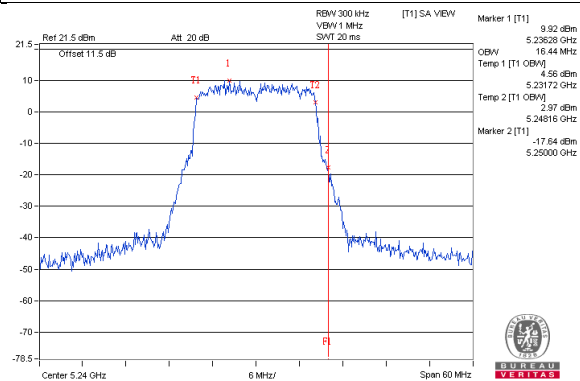

802.11ac(VHT20) / Chain 0 : CH48

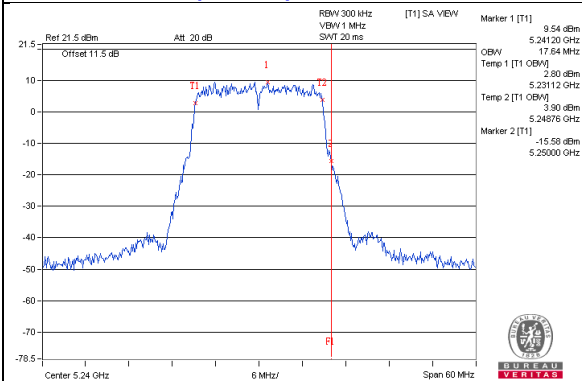

802.11ac(VHT20) / Chain 1 : CH48

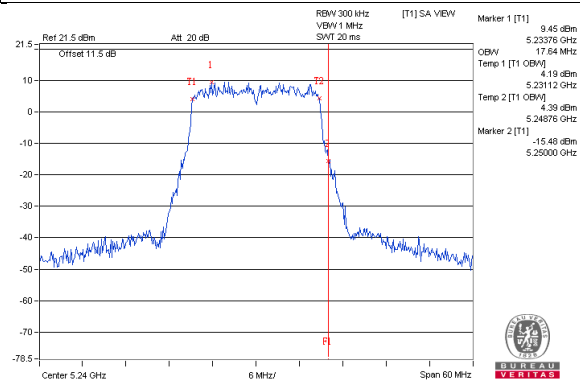

802.11ac(VHT20) / Chain 2 : CH48

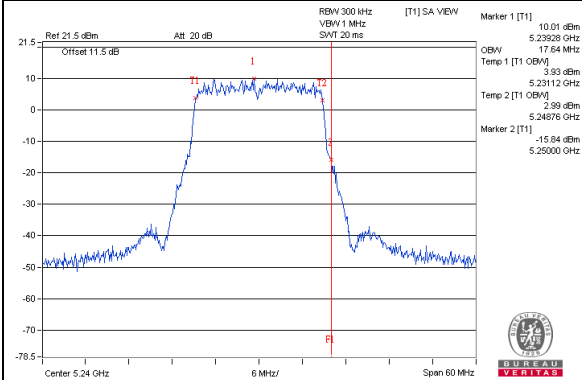

802.11ac(VHT20) / Chain 3 : CH48

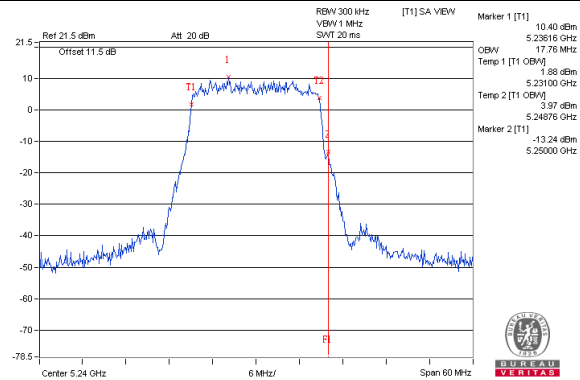

802.11ac(VHT40) / Chain 0 : CH46

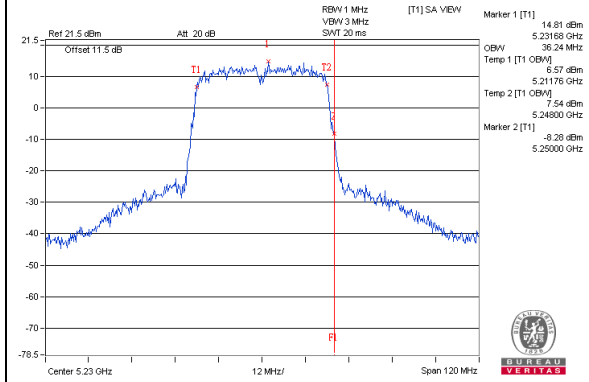

802.11ac(VHT20) / Chain 1 : CH46

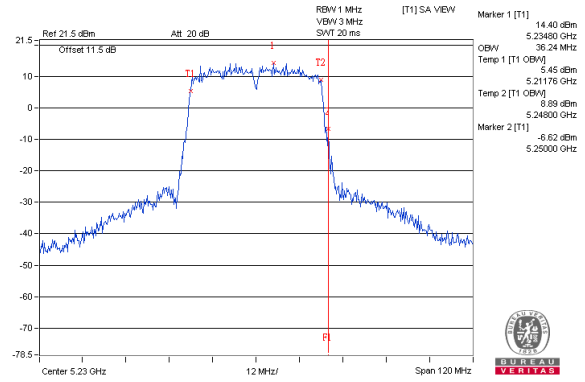

802.11ac(VHT40) / Chain 2 : CH46

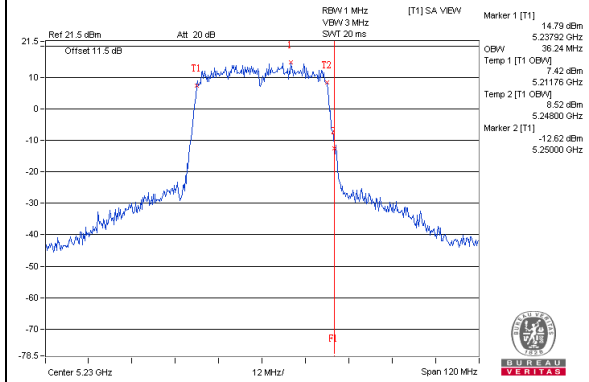

802.11ac(VHT20) / Chain 3 : CH46

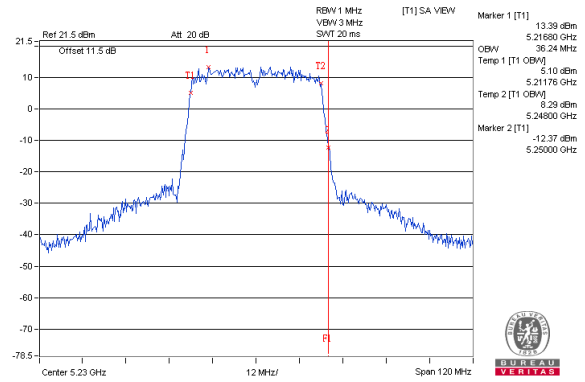

802.11ac(VHT80) / Chain 0 : CH42

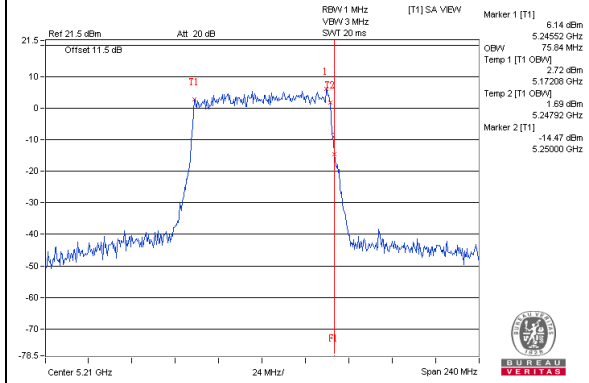

802.11ac(VHT80) / Chain 1 : CH42

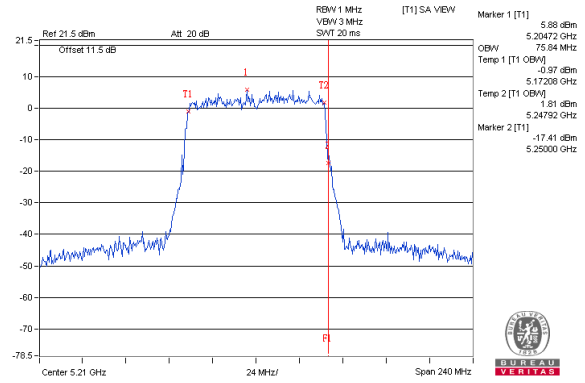

802.11ac(VHT80) / Chain 2 : CH42

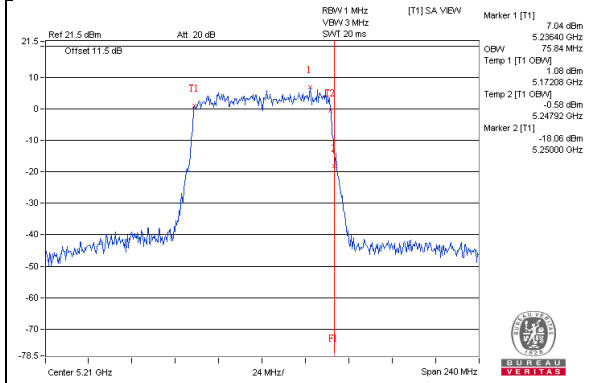

802.11ac(VHT80) / Chain 3 : CH42

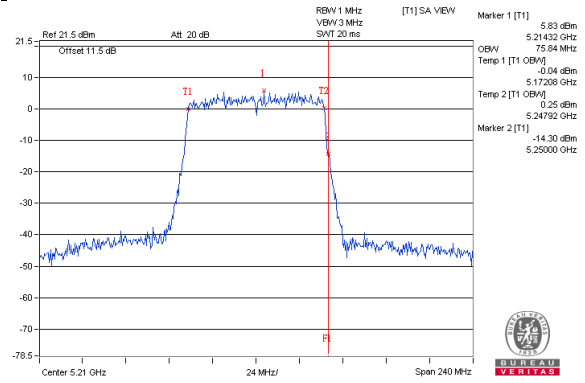

802.11ac(VHT80+80) / Chain 0 : CH42

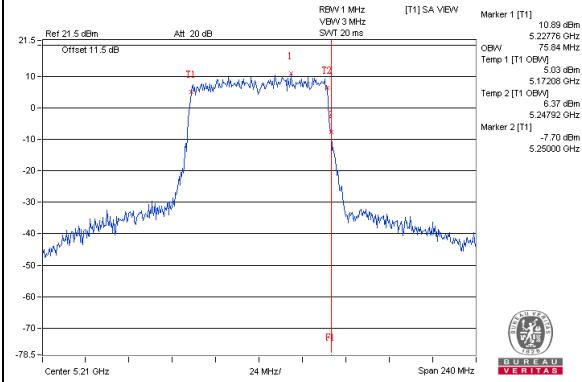

802.11ac(VHT80+80) / Chain 1 : CH42

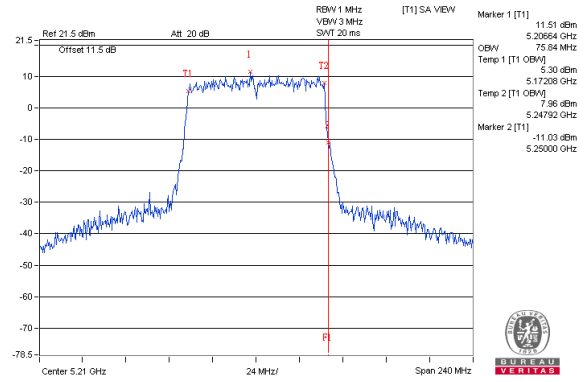

4.5 Peak Power Spectral Density Measurement

4.5.1 Limits of Peak Power Spectral Density Measurement

Operation Band	EUT Category		Limit
U-NII-1		Outdoor Access Point	17dBm/ MHz
		Fixed point-to-point Access Point	
	√	Indoor Access Point	
		Mobile and Portable client device	11dBm/ MHz
U-NII-2A	---		11dBm/ MHz
U-NII-2C	---		11dBm/ MHz
U-NII-3	√		30dBm/ 500kHz

4.5.2 Test Setup



4.5.3 Test Instruments

DESCRIPTION & MANUFACTURER	MODEL NO.	SERIAL NO.	CALIBRATED DATE	CALIBRATED UNTIL
Spectrum Analyzer R&S	FSP40	100036	Jan. 27, 2016	Jan. 26, 2017

Note:

1. The calibration interval of the above test instruments is 12 months and the calibrations are traceable to NML/ROC and NIST/USA.
2. Tested Date: July 15, 2016

4.5.4 Test Procedure

802.11ac (VHT20)

For U-NII-1:

Using method SA-1

1. Set span to encompass the entire emission bandwidth (EBW) of the signal.
2. Set RBW = 1 MHz, Set VBW \geq 3 MHz, Detector = RMS
3. Sweep time = auto, trigger set to "free run".
4. Trace average at least 100 traces in power averaging mode.
5. Record the max value

For U-NII-3:

1. Set span to encompass the entire emission bandwidth (EBW) of the signal.
2. Set RBW = 300 kHz, Set VBW \geq 1 MHz, Detector = RMS
3. Use the peak marker function to determine the maximum power level in any 300 kHz band segment within the fundamental EBW.
4. Scale the observed power level to an equivalent value in 500 kHz by adjusting (reducing) the measured power by a bandwidth correction factor (BWCF) where $BWCF = 10\log(500 \text{ kHz}/300\text{kHz})$
5. Sweep time = auto, trigger set to "free run".
6. Trace average at least 100 traces in power averaging mode.
7. Record the max value

802.11a, 802.11ac (VHT40), 802.11ac (VHT80), 802.11ac (VHT80+80)

For U-NII-1:

Using method SA-2

1. Set span to encompass the entire emission bandwidth (EBW) of the signal.
2. Set RBW = 1 MHz, Set VBW \geq 3 MHz, Detector = RMS
3. Sweep time = auto, trigger set to "free run".
4. Trace average at least 100 traces in power averaging mode.
5. Record the max value and add $10 \log(1/\text{duty cycle})$

For U-NII-3:

1. Set span to encompass the entire emission bandwidth (EBW) of the signal.
2. Set RBW = 300 kHz, Set VBW \geq 1 MHz, Detector = RMS
3. Use the peak marker function to determine the maximum power level in any 300 kHz band segment within the fundamental EBW.
4. Scale the observed power level to an equivalent value in 500 kHz by adjusting (reducing) the measured power by a bandwidth correction factor (BWCF) where $BWCF = 10\log(500 \text{ kHz}/300\text{kHz})$
5. Sweep time = auto, trigger set to "free run".
6. Trace average at least 100 traces in power averaging mode.
7. Record the max value and add $10 \log(1/\text{duty cycle})$

4.5.5 Deviation from Test Standard

No deviation.

4.5.6 EUT Operating Condition

Same as Item 4.3.6.

4.5.7 Test Results

For U-NII-1:

802.11a

Chan.	Chan. Freq. (MHz)	PSD W/O Duty Factor (dBm/MHz)				Duty Factor (dB)	Total PSD With Duty Factor (dBm/MHz)	MAX. Limit (dBm/MHz)	Pass / Fail
		Chain 0	Chain 1	Chain 2	Chain 3				
36	5180	5.25	5.24	5.63	5.15	0.16	11.50	11.86	Pass
40	5200	5.68	5.10	5.32	5.25	0.16	11.53	11.86	Pass
48	5240	5.89	5.23	5.55	5.24	0.16	11.67	11.86	Pass

- Note:**
- Method a) of power density measurement of KDB 662911 is using for calculating total power density. Total power density is summing entire spectra across corresponding frequency bins on the various outputs by computer.
 - Directional gain = $10 \log[(10^{G1/20} + 10^{G2/20} + 10^{G3/20} + 10^{G4/20})^2 / 4] = 11.14\text{dBi} > 6\text{dBi}$, so the power density limit shall be reduced to $17 - (11.14 - 6) = 11.86\text{dBm}$.
 - Refer to section 3.3 for duty cycle spectrum plot.

802.11ac (VHT20)

Chan.	Chan. Freq. (MHz)	PSD (dBm/MHz)				Total Power Density (dBm/MHz)	MAX. Limit (dBm/MHz)	Pass / Fail
		Chain 0	Chain 1	Chain 2	Chain 3			
36	5180	5.60	5.08	5.65	5.18	11.41	11.94	Pass
40	5200	5.69	5.29	5.77	5.16	11.51	11.94	Pass
48	5240	6.62	5.28	6.17	5.24	11.89	11.94	Pass

- Note:**
- Method a) of power density measurement of KDB 662911 is using for calculating total power density. Total power density is summing entire spectra across corresponding frequency bins on the various outputs by computer.
 - Directional gain = $10 \log[(10^{G1/20} + 10^{G2/20} + 10^{G3/20} + 10^{G4/20})^2 / 4] = 11.14\text{dBi} > 6\text{dBi}$, so the power density limit shall be reduced to $17 - (11.14 - 6) = 11.86\text{dBm}$.

802.11ac (VHT40)

Chan.	Chan. Freq. (MHz)	PSD W/O Duty Factor (dBm/MHz)				Duty Factor (dB)	Total PSD With Duty Factor (dBm/MHz)	MAX. Limit (dBm/MHz)	Pass / Fail
		Chain 0	Chain 1	Chain 2	Chain 3				
38	5190	0.16	-0.68	0.71	0.45	0.16	6.37	11.86	Pass
46	5230	4.70	4.42	4.79	4.44	0.16	10.77	11.86	Pass

- Note:**
- Method a) of power density measurement of KDB 662911 is using for calculating total power density. Total power density is summing entire spectra across corresponding frequency bins on the various outputs by computer.
 - Directional gain = $10 \log[(10^{G1/20} + 10^{G2/20} + 10^{G3/20} + 10^{G4/20})^2 / 4] = 11.14\text{dBi} > 6\text{dBi}$, so the power density limit shall be reduced to $17 - (11.14 - 6) = 11.86\text{dBm}$.
 - Refer to section 3.3 for duty cycle spectrum plot.

802.11ac (VHT80):

Chan.	Chan. Freq. (MHz)	PSD W/O Duty Factor (dBm/MHz)				Duty Factor (dB)	Total PSD With Duty Factor (dBm/MHz)	MAX. Limit (dBm/MHz)	Pass / Fail
		Chain 0	Chain 1	Chain 2	Chain 3				
42	5210	-3.31	-4.05	-3.37	-3.84	0.24	2.63	11.86	Pass

- Note:**
- Method a) of power density measurement of KDB 662911 is using for calculating total power density. Total power density is summing entire spectra across corresponding frequency bins on the various outputs by computer.
 - Directional gain = $10 \log[(10^{G1/20} + 10^{G2/20} + 10^{G3/20} + 10^{G4/20})^2 / 4] = 11.14\text{dBi} > 6\text{dBi}$, so the power density limit shall be reduced to $17 - (11.14 - 6) = 11.86\text{dBm}$.
 - Refer to section 3.3 for duty cycle spectrum plot.

802.11ac (VHT80+80):

Chan.	Chan. Freq. (MHz)	PSD W/O Duty Factor (dBm/MHz)				Duty Factor (dB)	Total PSD With Duty Factor (dBm/MHz)	MAX. Limit (dBm/MHz)	Pass / Fail
		Chain 0	Chain 1	Chain 2	Chain 3				
42	5210	1.11	1.09	-	-	0.26	4.37	14.71	Pass

- Note:**
- Method a) of power density measurement of KDB 662911 is using for calculating total power density. Total power density is summing entire spectra across corresponding frequency bins on the various outputs by computer.
 - Directional gain = $10 \log[(10^{G1/20} + 10^{G2/20})^2 / 2] = 8.29\text{dBi} > 6\text{dBi}$, so the power density limit shall be reduced to $17 - (8.29 - 6) = 14.71\text{dBm}$.
 - Refer to section 3.3 for duty cycle spectrum plot.

Spectrum Plot of Worst Value

802.11a / Chain 0 : CH48

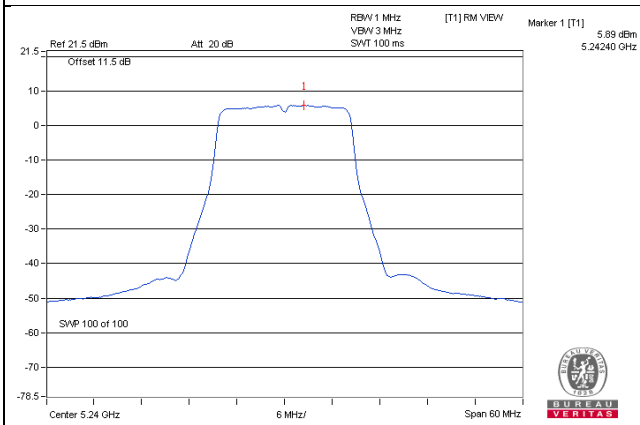

802.11ac (VHT20) / Chain 0 : CH48

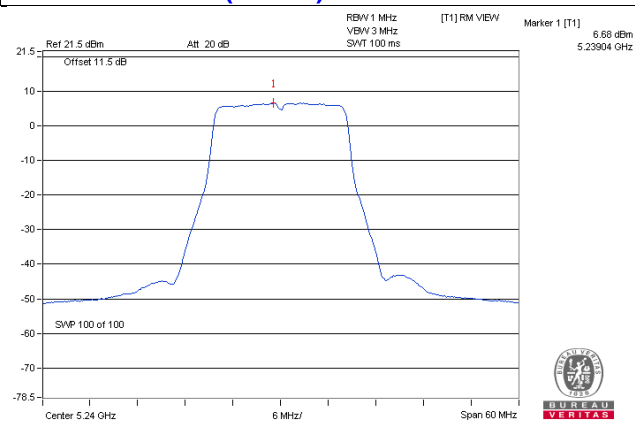

802.11ac (VHT40) / Chain 2 : CH46

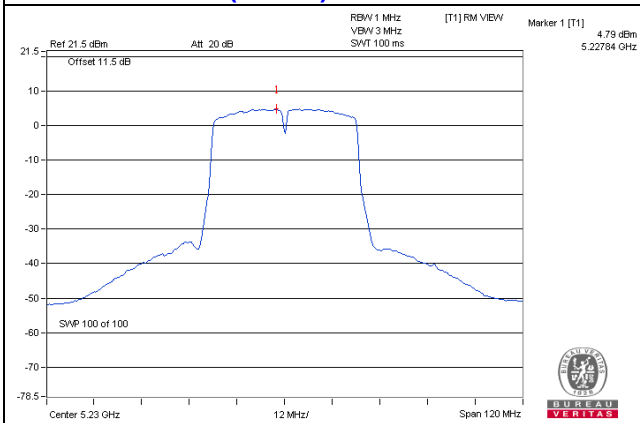

802.11ac (VHT80) / Chain 0 : CH42

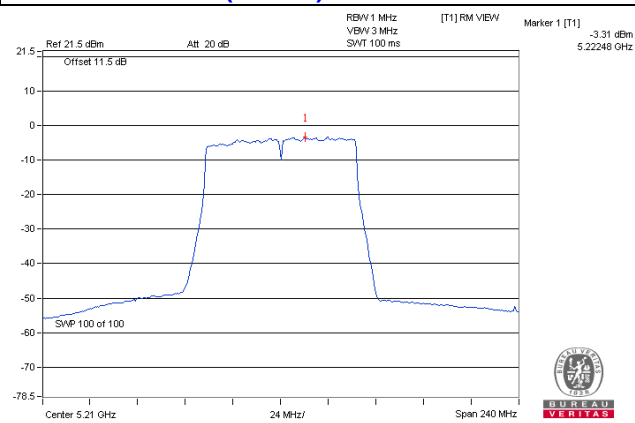

802.11ac (VHT80+80) / Chain 0 : CH42

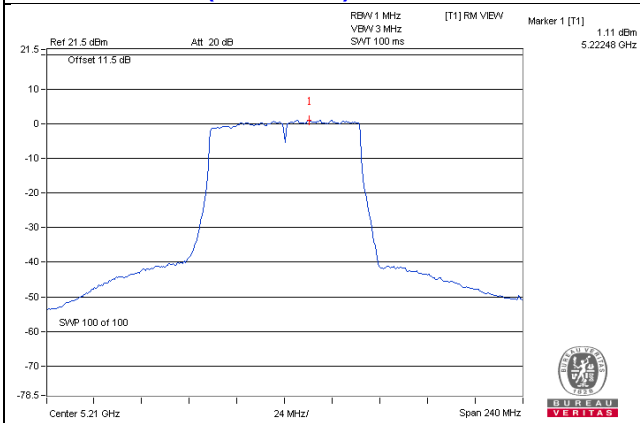

For U-NII-3:
802.11a

TX chain	Chan.	Chan. Freq. (MHz)	PSD W/O Duty Factor		10 log (N=4) dB	Duty Factor (dB)	Total PSD With Duty Factor (dBm/500kHz)	Limit (dBm/500kHz)	Pass /Fail
			(dBm/300kHz)	(dBm/500kHz)					
0	149	5745	1.29	3.51	6.02	0.16	9.69	24.55	Pass
	157	5785	1.16	3.38	6.02	0.16	9.56	24.55	Pass
	165	5825	1.07	3.29	6.02	0.16	9.47	24.55	Pass
1	149	5745	1.01	3.23	6.02	0.16	9.41	24.55	Pass
	157	5785	0.57	2.79	6.02	0.16	8.97	24.55	Pass
	165	5825	0.75	2.97	6.02	0.16	9.15	24.55	Pass
2	149	5745	0.95	3.17	6.02	0.16	9.35	24.55	Pass
	157	5785	0.80	3.02	6.02	0.16	9.20	24.55	Pass
	165	5825	0.80	3.02	6.02	0.16	9.20	24.55	Pass
3	149	5745	1.03	3.25	6.02	0.16	9.43	24.55	Pass
	157	5785	1.11	3.33	6.02	0.16	9.51	24.55	Pass
	165	5825	1.02	3.24	6.02	0.16	9.42	24.55	Pass

- Note:** 1. Directional gain = $10 \log[(10^{G1/20} + 10^{G2/20} + 10^{G3/20} + 10^{G4/20})^2 / 4] = 11.45\text{dBi} > 6\text{dBi}$, so the power density limit shall be reduced to $30-(11.45-6) = 24.55\text{dBm}$.
2. Refer to section 3.3 for duty cycle spectrum plot.

802.11ac (VHT20)

TX chain	Channel	Freq. (MHz)	PSD (dBm/300kHz)	PSD (dBm/500kHz)	10 log (N=4) dB	Total PSD (dBm/500kHz)	Limit (dBm/500kHz)	Pass /Fail
0	149	5745	0.07	2.29	6.02	8.31	24.55	Pass
	157	5785	0.49	2.71	6.02	8.73	24.55	Pass
	165	5825	0.75	2.97	6.02	8.99	24.55	Pass
1	149	5745	0.64	2.86	6.02	8.88	24.55	Pass
	157	5785	0.74	2.96	6.02	8.98	24.55	Pass
	165	5825	1.05	3.27	6.02	9.29	24.55	Pass
2	149	5745	0.61	2.83	6.02	8.85	24.55	Pass
	157	5785	0.41	2.63	6.02	8.65	24.55	Pass
	165	5825	0.40	2.62	6.02	8.64	24.55	Pass
3	149	5745	0.74	2.96	6.02	8.98	24.55	Pass
	157	5785	0.66	2.88	6.02	8.90	24.55	Pass
	165	5825	0.88	3.10	6.02	9.12	24.55	Pass

- Note:** 1. Directional gain = $10 \log[(10^{G1/20} + 10^{G2/20} + 10^{G3/20} + 10^{G4/20})^2 / 4] = 11.45\text{dBi} > 6\text{dBi}$, so the power density limit shall be reduced to $30-(11.45-6) = 24.55\text{dBm}$.

802.11ac (VHT40)

TX chain	Chan.	Chan. Freq. (MHz)	PSD W/O Duty Factor		10 log (N=4) dB	Duty Factor (dB)	Total PSD With Duty Factor (dBm/500kHz)	Limit (dBm/500kHz)	Pass /Fail
			(dBm/300kHz)	(dBm/500kHz)					
0	151	5755	-2.69	-0.47	6.02	0.16	5.71	24.55	Pass
	159	5795	-3.39	-1.17	6.02	0.16	5.01	24.55	Pass
1	151	5755	-2.88	-0.66	6.02	0.16	5.52	24.55	Pass
	159	5795	-2.68	-0.46	6.02	0.16	5.72	24.55	Pass
2	151	5755	-3.29	-1.07	6.02	0.16	5.11	24.55	Pass
	159	5795	-3.27	-1.05	6.02	0.16	5.13	24.55	Pass
3	149	5745	-2.64	-0.42	6.02	0.16	5.76	24.55	Pass
	151	5755	-2.46	-0.24	6.02	0.16	5.94	24.55	Pass

Note: 1. Directional gain = $10 \log[(10^{G1/20} + 10^{G2/20} + 10^{G3/20} + 10^{G4/20})^2 / 4] = 11.45\text{dBi} > 6\text{dBi}$, so the power density limit shall be reduced to $30 - (11.45 - 6) = 24.55\text{dBm}$.

2. Refer to section 3.3 for duty cycle spectrum plot.

802.11ac (VHT80)

TX chain	Chan.	Chan. Freq. (MHz)	PSD W/O Duty Factor		10 log (N=4) dB	Duty Factor (dB)	Total PSD With Duty Factor (dBm/500kHz)	Limit (dBm/500kHz)	Pass /Fail
			(dBm/300kHz)	(dBm/500kHz)					
0	155	5775	-8.89	-6.67	6.02	0.24	-0.41	24.55	Pass
1	155	5775	-8.90	-6.68	6.02	0.24	-0.42	24.55	Pass
2	155	5775	-8.28	-6.06	6.02	0.24	0.20	24.55	Pass
3	155	5775	-7.72	-5.50	6.02	0.24	0.76	24.55	Pass

Note: 1. Directional gain = $10 \log[(10^{G1/20} + 10^{G2/20} + 10^{G3/20} + 10^{G4/20})^2 / 4] = 11.45\text{dBi} > 6\text{dBi}$, so the power density limit shall be reduced to $30 - (11.45 - 6) = 24.55\text{dBm}$.

2. Refer to section 3.3 for duty cycle spectrum plot.

802.11ac (VHT80+80)

TX chain	Chan.	Chan. Freq. (MHz)	PSD W/O Duty Factor		10 log (N=2) dB	Duty Factor (dB)	Total PSD With Duty Factor (dBm/500kHz)	Limit (dBm/500kHz)	Pass /Fail
			(dBm/300kHz)	(dBm/500kHz)					
2	155	5775	-8.28	-6.06	3.01	0.26	-2.79	27.18	Pass
3	155	5775	-7.72	-5.50	3.01	0.26	-2.23	27.18	Pass

Note: 1. Directional gain = $10 \log[(10^{G3/20} + 10^{G4/20})^2 / 2] = 8.82\text{dBi} > 6\text{dBi}$, so the power density limit shall be reduced to $30 - (8.82 - 6) = 27.18\text{dBm}$.

2. Refer to section 3.3 for duty cycle spectrum plot.

Spectrum Plot of Worst Value

802.11a / Chain 0 : CH149

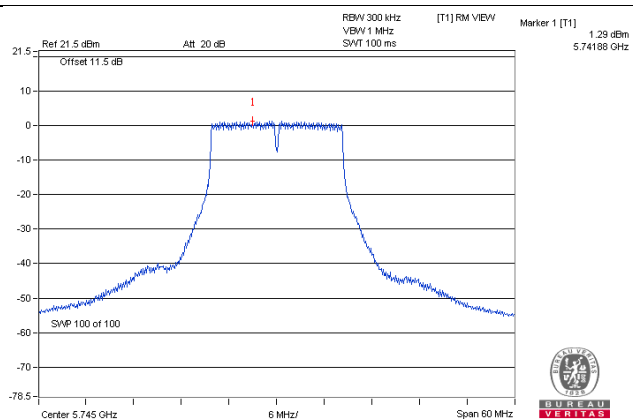

802.11ac (VHT20) / Chain 1 : CH165

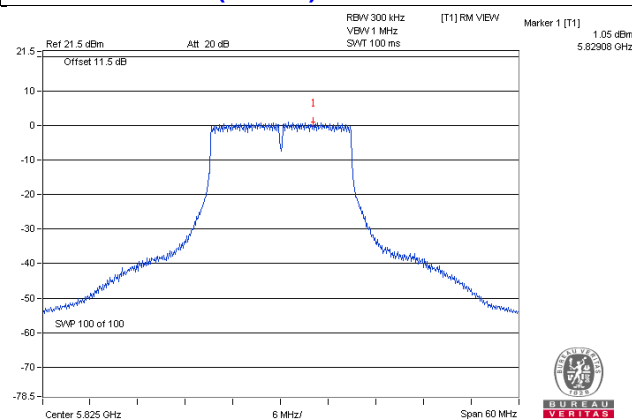

802.11ac (VHT40) / Chain 3 : CH159

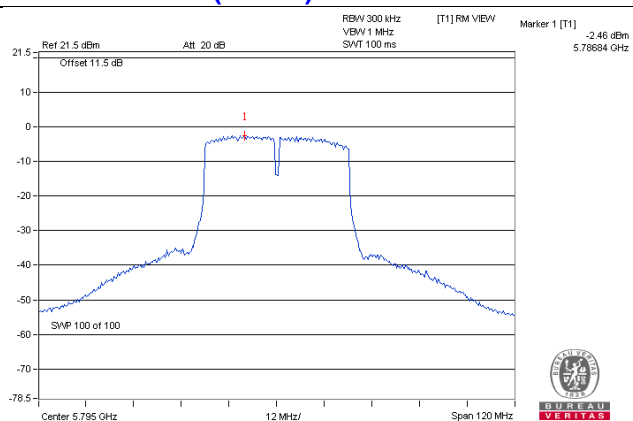

802.11ac (VHT80) / Chain 3 : CH155

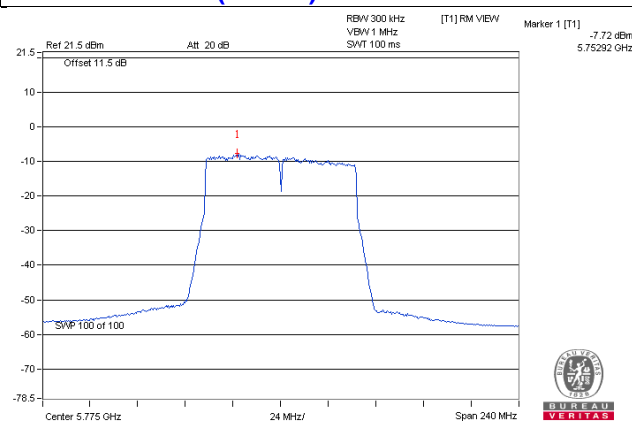

802.11ac (VHT80+80) / Chain 3 : CH155

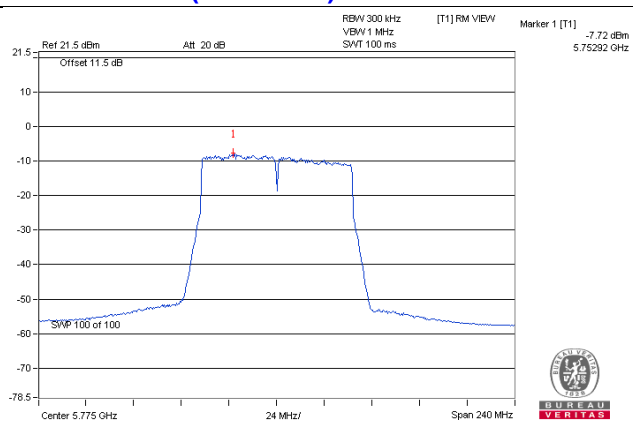

4.6 Frequency Stability Measurement

4.6.1 Limits of Frequency Stability Measurement

The frequency of the carrier signal shall be maintained within band of operation

4.6.2 Test Setup

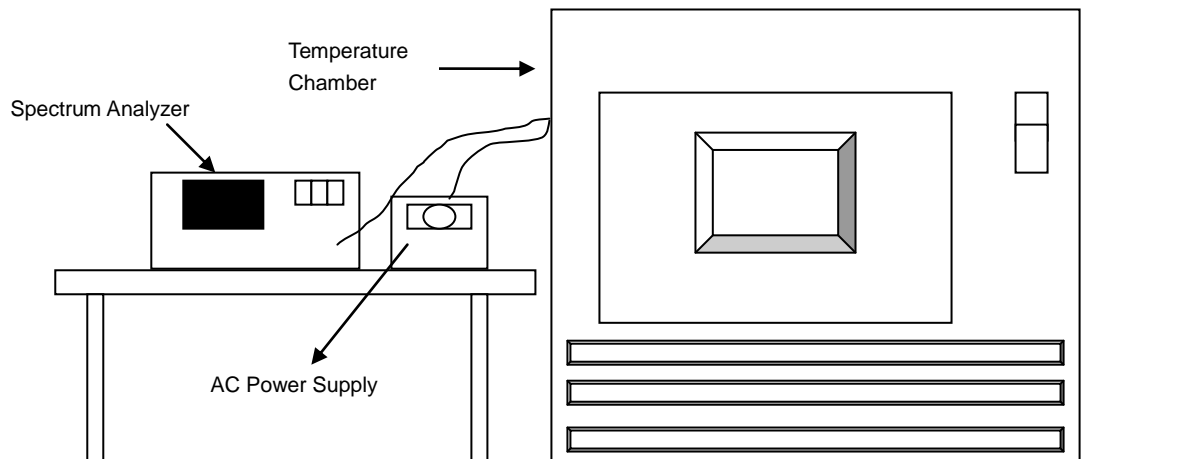

4.6.3 Test Instruments

DESCRIPTION & MANUFACTURER	MODEL NO.	SERIAL NO.	CALIBRATED DATE	CALIBRATED UNTIL
Spectrum Analyzer R&S	FSP40	100036	Jan. 27, 2016	Jan. 26, 2017
AC Power Source Exttech Electronics	6502	1140503	NA	NA
Temperature & Humidity Chamber TERCHY	MHU-225AU	911033	Dec. 03, 2015	Dec. 02, 2016
Digital Multimeter FLUKE	87III	73680266	Nov. 10, 2015	Nov. 09, 2016

Note:

1. The calibration interval of the above test instruments is 12 months and the calibrations are traceable to NML/ROC and NIST/USA.
2. Tested Date: July 15, 2016

4.6.4 Test Procedure

- a. The EUT was placed inside the environmental test chamber and powered by nominal AC voltage.
- b. Turn the EUT on and couple its output to a spectrum analyzer.
- c. Turn the EUT off and set the chamber to the highest temperature specified.
- d. Allow sufficient time (approximately 30 min) for the temperature of the chamber to stabilize, turn the EUT on and measure the operating frequency after 2, 5, and 10 Minutes.
- e. Repeat step 2 and 3 with the temperature chamber set to the lowest temperature.
- f. The test chamber was allowed to stabilize at +20 degree C for a minimum of 30 Minutes. The supply voltage was then adjusted on the EUT from 85% to 115% and the frequency record.

4.6.5 Deviation from Test Standard

No deviation.

4.6.6 EUT Operating Condition

Set the EUT transmit at un-modulation mode to test frequency stability.

4.6.7 Test Results

Frequency Stability Versus Temp.									
Operating Frequency: 5180 MHz									
TEMP. (°C)	Power Supply (Vac)	0 Minute		2 Minute		5 Minute		10 Minute	
		Measured Frequency (MHz)	Pass/Fail	Measured Frequency (MHz)	Pass/Fail	Measured Frequency (MHz)	Pass/Fail	Measured Frequency (MHz)	Pass/Fail
50	120	5180.0067	Pass	5180.009	Pass	5180.0088	Pass	5180.0086	Pass
40	120	5179.9735	Pass	5179.9761	Pass	5179.9736	Pass	5179.9757	Pass
30	120	5180.0028	Pass	5180.0005	Pass	5180.0033	Pass	5180.0029	Pass
20	120	5179.9993	Pass	5179.9957	Pass	5179.9993	Pass	5179.9963	Pass
10	120	5179.9859	Pass	5179.9861	Pass	5179.9846	Pass	5179.9848	Pass
0	120	5179.9928	Pass	5179.9911	Pass	5179.993	Pass	5179.9915	Pass
-10	120	5180.0238	Pass	5180.0235	Pass	5180.0277	Pass	5180.0272	Pass
-20	120	5180.0049	Pass	5180.0078	Pass	5180.0058	Pass	5180.004	Pass
-30	120	5179.9899	Pass	5179.9933	Pass	5179.9925	Pass	5179.991	Pass

Frequency Stability Versus Voltage									
Operating Frequency: 5180 MHz									
TEMP. (°C)	Power Supply (Vac)	0 Minute		2 Minute		5 Minute		10 Minute	
		Measured Frequency (MHz)	Pass/Fail	Measured Frequency (MHz)	Pass/Fail	Measured Frequency (MHz)	Pass/Fail	Measured Frequency (MHz)	Pass/Fail
20	138	5179.9994	Pass	5179.9958	Pass	5179.9998	Pass	5179.9967	Pass
	120	5179.9993	Pass	5179.9957	Pass	5179.9993	Pass	5179.9963	Pass
	102	5179.9985	Pass	5179.9958	Pass	5180.0001	Pass	5179.9955	Pass

4.7 6dB Bandwidth Measurement

4.7.1 Limits of 6dB Bandwidth Measurement

The minimum of 6dB Bandwidth Measurement is 0.5MHz.

4.7.2 Test Setup

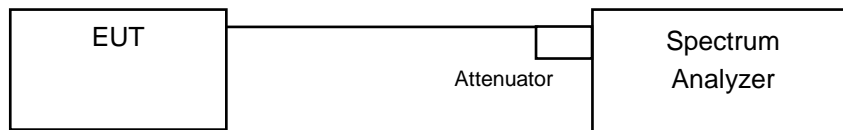

4.7.3 Test Instruments

DESCRIPTION & MANUFACTURER	MODEL NO.	SERIAL NO.	CALIBRATED DATE	CALIBRATED UNTIL
Spectrum Analyzer R&S	FSP40	100036	Jan. 27, 2016	Jan. 26, 2017

Note:

1. The calibration interval of the above test instruments is 12 months and the calibrations are traceable to NML/ROC and NIST/USA.
2. Tested Date: July 15, 2016

4.7.4 Test Procedure

MEASUREMENT PROCEDURE REF

- a. Set resolution bandwidth (RBW) = 100kHz
- b. Set the video bandwidth (VBW) $\geq 3 \times$ RBW, Detector = Peak.
- c. Trace mode = max hold.
- d. Sweep = auto couple.
- e. Measure the maximum width of the emission that is constrained by the frequencies associated with the two amplitude points (upper and lower) that are attenuated by 6 dB relative to the maximum level measured in the fundamental emission

4.7.5 Deviation from Test Standard

No deviation.

4.7.6 EUT Operating Condition

The software provided by client to enable the EUT under transmission condition continuously at lowest, middle and highest channel frequencies individually.

4.7.7 Test Results

802.11a

Channel	Frequency (MHz)	6dB Bandwidth (MHz)				Minimum Limit (MHz)	Pass / Fail
		Chain 0	Chain 1	Chain 2	Chain 3		
149	5745	16.36	16.34	16.34	16.34	0.5	Pass
157	5785	16.36	16.36	16.35	16.36	0.5	Pass
165	5825	16.34	16.32	16.31	16.37	0.5	Pass

802.11ac (VHT20)

Channel	Frequency (MHz)	6dB Bandwidth (MHz)				Minimum Limit (MHz)	Pass / Fail
		Chain 0	Chain 1	Chain 2	Chain 3		
149	5745	17.28	17.27	17.24	17.62	0.5	Pass
157	5785	17.27	16.90	17.56	17.23	0.5	Pass
165	5825	17.57	16.86	16.98	17.56	0.5	Pass

802.11ac (VHT40)

Channel	Frequency (MHz)	6dB Bandwidth (MHz)				Minimum Limit (MHz)	Pass / Fail
		Chain 0	Chain 1	Chain 2	Chain 3		
151	5755	35.21	35.21	35.16	35.23	0.5	Pass
159	5795	35.09	35.11	35.06	35.24	0.5	Pass

802.11ac (VHT80)

Channel	Frequency (MHz)	6dB Bandwidth (MHz)				Minimum Limit (MHz)	Pass / Fail
		Chain 0	Chain 1	Chain 2	Chain 3		
155	5775	74.78	75.57	75.62	75.53	0.5	Pass

802.11ac (VHT80+80)

Channel	Frequency (MHz)	6dB Bandwidth (MHz)				Minimum Limit (MHz)	Pass / Fail
		Chain 0	Chain 1	Chain 2	Chain 3		
155	5775	-	-	75.62	75.53	0.5	Pass

Spectrum Plot of Worst Value

802.11a / Chain 2 : CH165

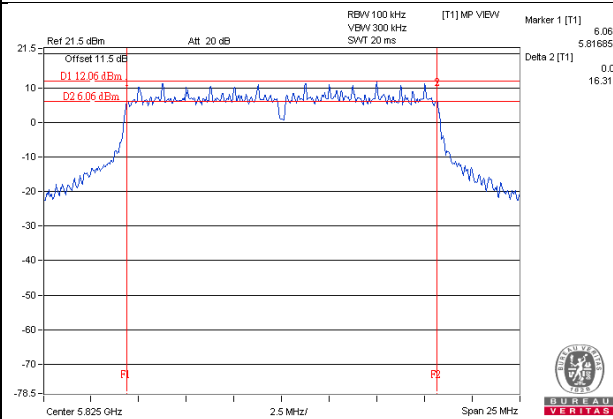

802.11ac(VHT20) / Chain 1 : CH165

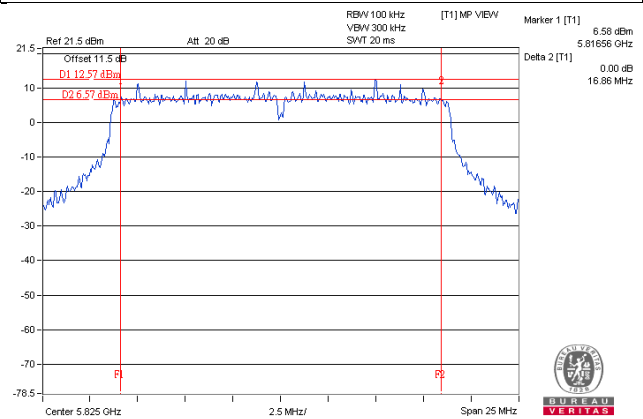

802.11ac(VHT40) / Chain 2 : CH159

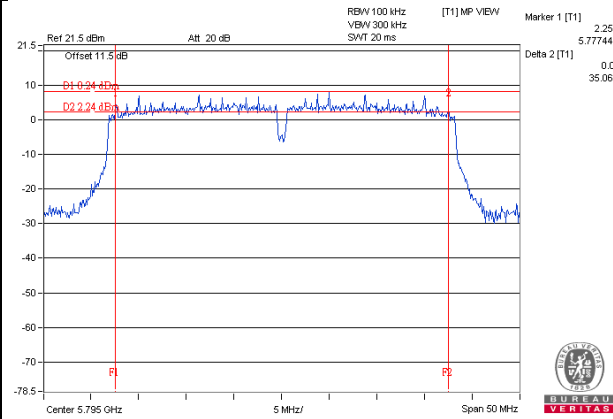

802.11ac(VHT80) / Chain 0 : CH155

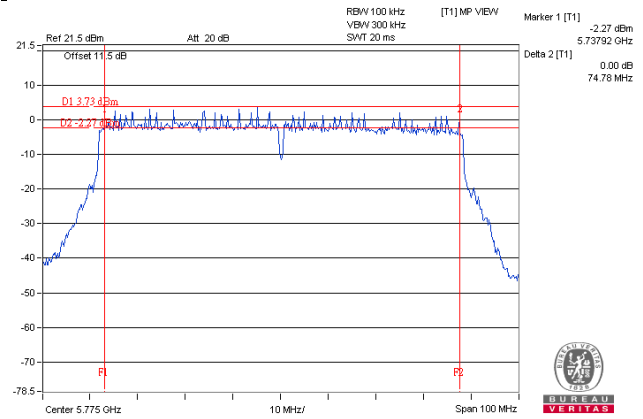

802.11ac(VHT80+80) / Chain 3 : CH155

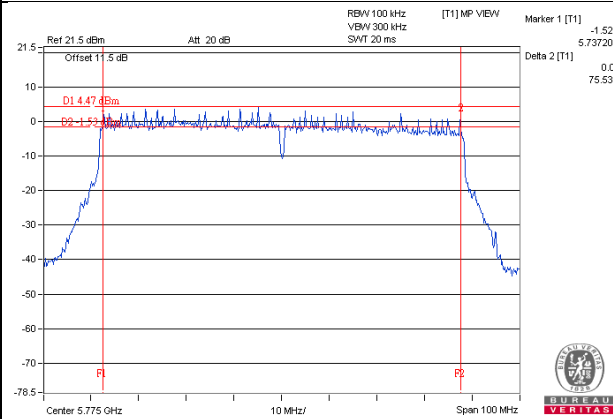

4.8 26dB Bandwidth Measurement

4.8.1 Test Setup



4.8.2 Test Instruments

DESCRIPTION & MANUFACTURER	MODEL NO.	SERIAL NO.	CALIBRATED DATE	CALIBRATED UNTIL
Spectrum Analyzer R&S	FSP40	100036	Jan. 27, 2016	Jan. 26, 2017

Note:

1. The calibration interval of the above test instruments is 12 months and the calibrations are traceable to NML/ROC and NIST/USA.
2. Tested Date: July 15, 2016

4.8.3 Test Procedure

1. Set RBW = approximately 1% of the emission bandwidth.
2. Set the VBW > RBW.
3. Detector = Peak.
4. Trace mode = max hold.
5. Measure the maximum width of the emission that is 26 dB down from the peak of the emission. Compare this with the RBW setting of the analyzer. Readjust RBW and repeat measurement as needed until the RBW/EBW ratio is approximately 1%.

4.8.4 Deviation from Test Standard

No deviation.

4.8.5 EUT Operating Condition

The software provided by client to enable the EUT under transmission condition continuously at lowest, middle and highest channel frequencies individually.

4.8.6 Test Results

802.11a

Channel	Channel Frequency (MHz)	26dB Bandwidth (MHz)			
		Chain 0	Chain 1	Chain 2	Chain 3
36	5180	19.75	19.72	19.75	20.03
40	5200	19.58	19.62	19.64	19.88
48	5240	20.09	19.64	19.49	19.96
149	5745	20.42	20.59	20.49	20.59
157	5785	20.44	20.42	21.06	20.71
165	5825	20.59	20.51	21.79	20.56

802.11ac (VHT20)

Channel	Channel Frequency (MHz)	26dB Bandwidth (MHz)			
		Chain 0	Chain 1	Chain 2	Chain 3
36	5180	20.55	20.55	20.55	20.54
40	5200	20.51	20.66	20.51	20.48
48	5240	20.42	20.72	20.41	20.49
149	5745	20.75	20.91	20.81	20.76
157	5785	20.82	21.22	21.68	20.98
165	5825	21.05	20.92	21.91	21.25

802.11ac (VHT40)

Channel	Channel Frequency (MHz)	26dB Bandwidth (MHz)			
		Chain 0	Chain 1	Chain 2	Chain 3
38	5190	40.91	40.74	40.97	40.84
46	5230	41.01	40.84	40.80	40.76
151	5755	41.00	41.02	41.05	41.09
159	5795	40.98	41.07	41.15	41.28

802.11ac (VHT80)

Channel	Channel Frequency (MHz)	26dB Bandwidth (MHz)			
		Chain 0	Chain 1	Chain 2	Chain 3
42	5210	84.86	85.21	84.86	85.00
155	5775	85.35	84.72	85.04	85.10

802.11ac (VHT80+80)

Channel	Channel Frequency (MHz)	26dB Bandwidth (MHz)			
		Chain 0	Chain 1	Chain 2	Chain 3
42	5210	84.80	84.99	-	-
155	5775	-	-	85.04	85.10

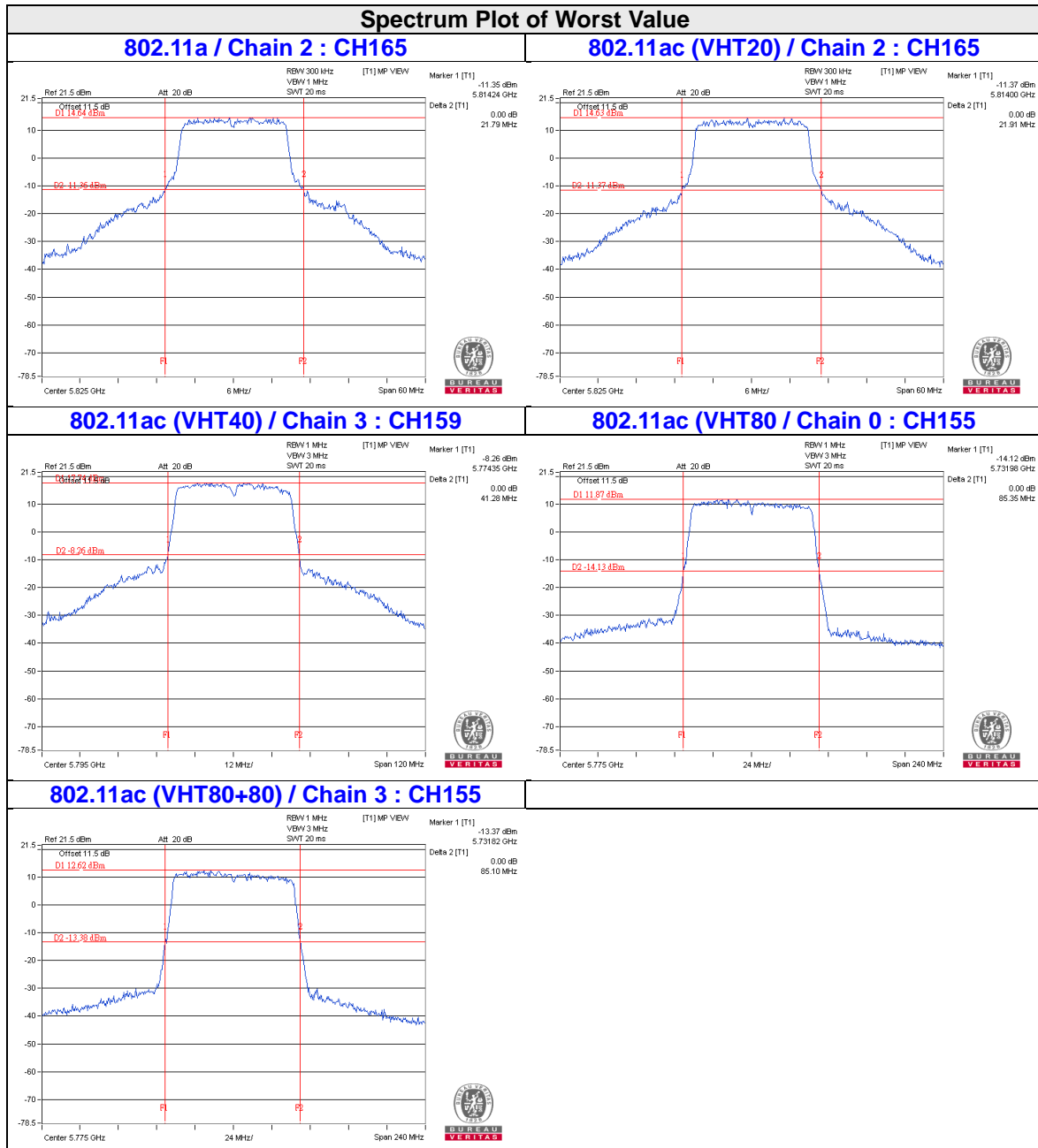

5 Pictures of Test Arrangements

Please refer to the attached file (Test Setup Photo).

Annex A- Radiated Out of Band Emission (OOBE) Measurement (For U-NII-3 band)

802.11a

CH 149 5745 MHz

Horizontal

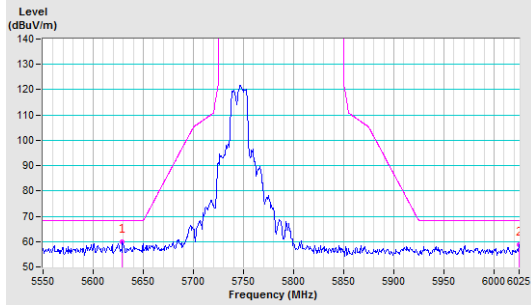

Vertical

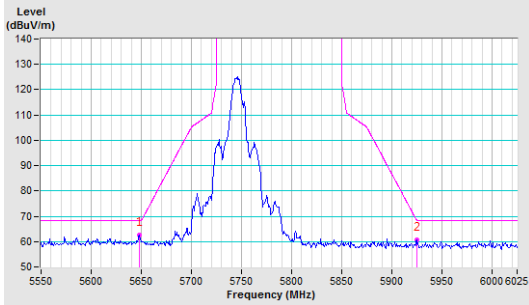

CH 157 5785 MHz

Horizontal

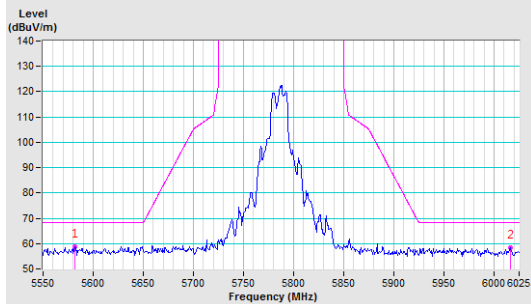

Vertical

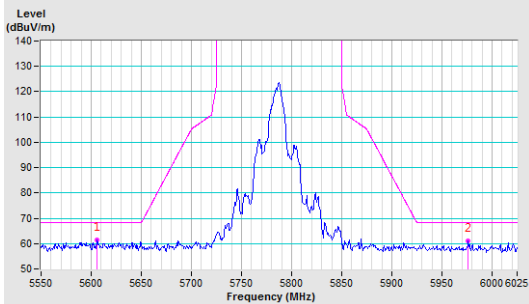

CH 165 5825 MHz

Horizontal

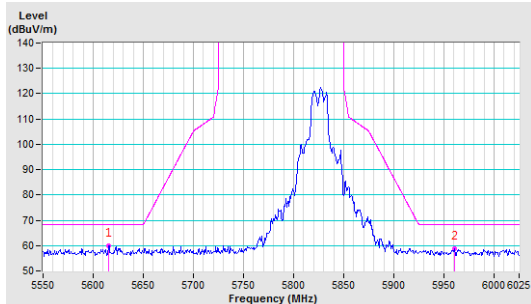

Vertical

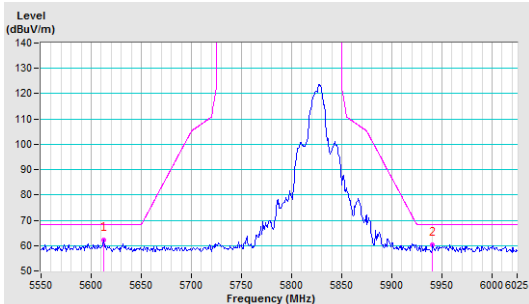

802.11ac (VHT20)

CH 149 5745 MHz

Horizontal

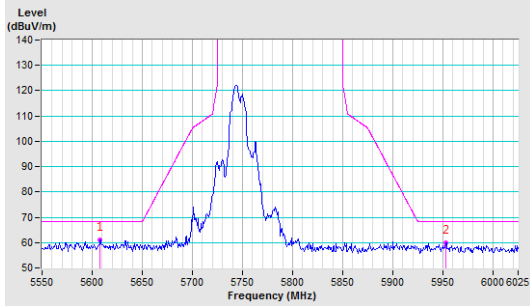

Vertical

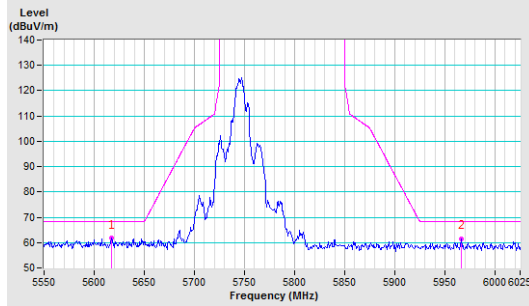

CH 157 5785 MHz

Horizontal

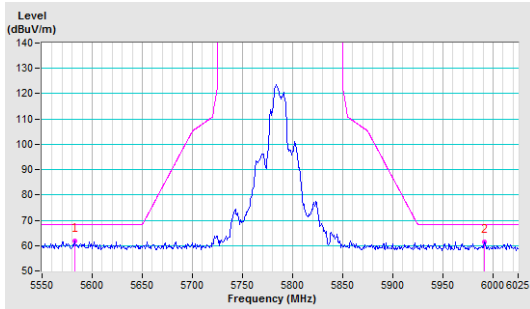

Vertical

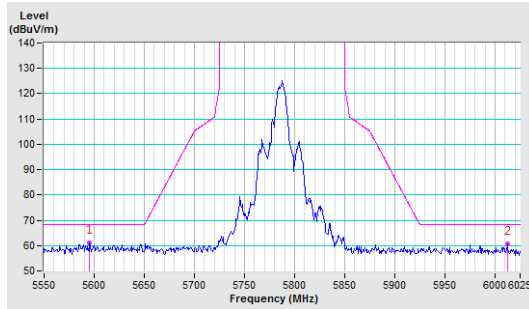

CH 165 5825 MHz

Horizontal

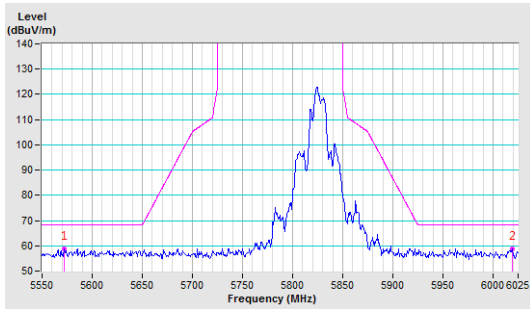

Vertical

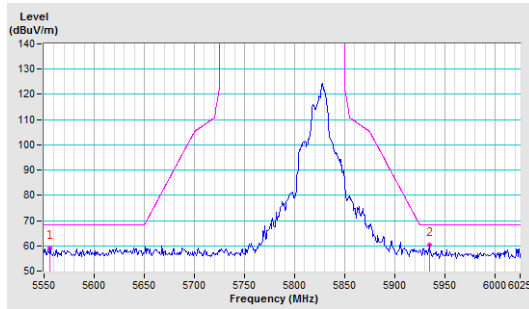

802.11ac (VHT40)

CH 151 5755 MHz

Horizontal

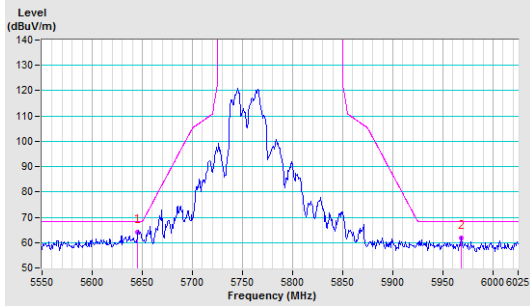

Vertical

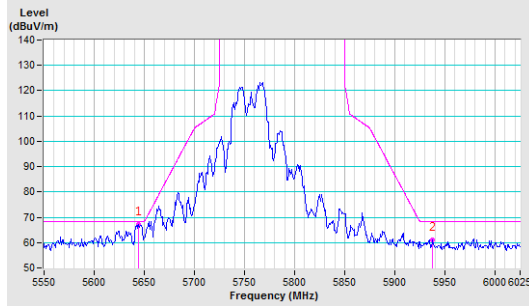

CH 159 5795 MHz

Horizontal

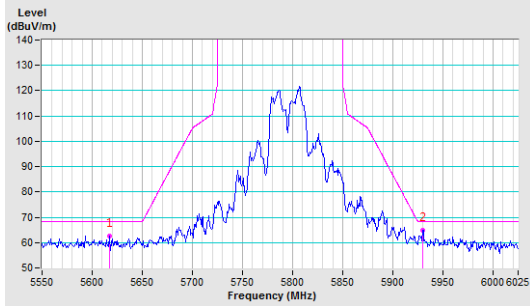

Vertical

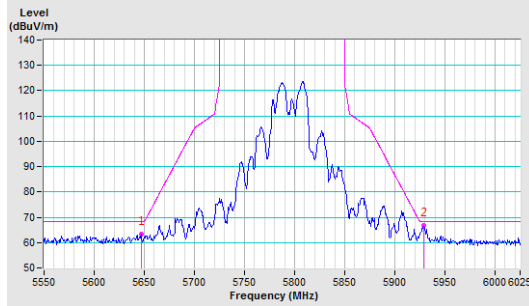

802.11ac (VHT80)

CH 155 5775 MHz

Horizontal

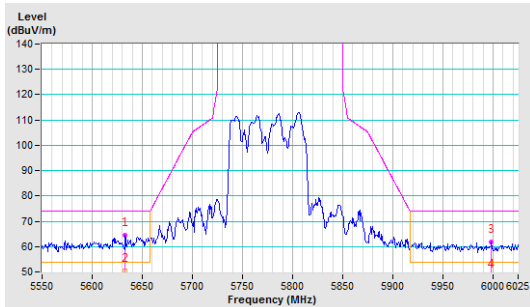

Vertical

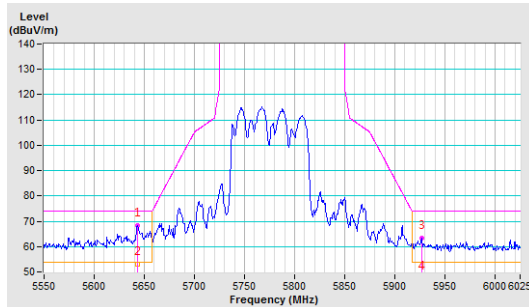

802.11ac (VHT80+80)

CH 155 5775 MHz

Horizontal

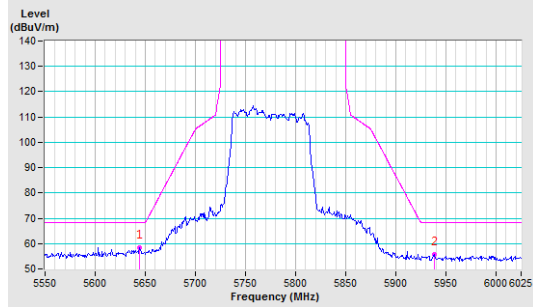

Vertical

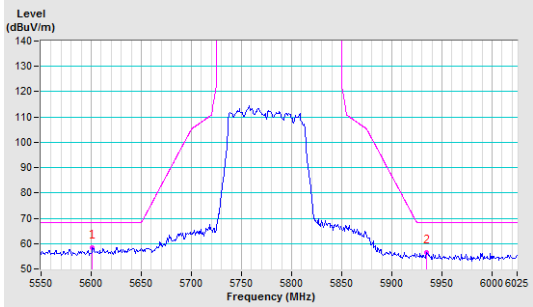

Appendix – Information on the Testing Laboratories

We, Bureau Veritas Consumer Products Services (H.K.) Ltd., Taoyuan Branch, were founded in 1988 to provide our best service in EMC, Radio, Telecom and Safety consultation. Our laboratories are accredited and approved according to ISO/IEC 17025.

If you have any comments, please feel free to contact us at the following:

Linko EMC/RF Lab

Tel: 886-2-26052180

Fax: 886-2-26051924

Hsin Chu EMC/RF/Telecom Lab

Tel: 886-3-6668565

Fax: 886-3-6668323

Hwa Ya EMC/RF/Safety Lab

Tel: 886-3-3183232

Fax: 886-3-3270892

Email: service.adt@tw.bureauveritas.com

Web Site: www.bureauveritas-adt.com

The address and road map of all our labs can be found in our web site also.

--- END ---