

FCC Test Report

Report No.: RF160530E01

FCC ID: 2AD8UFZCWI4A1

Test Model: WI4A-AC400i

Received Date: May 30, 2016

Test Date: June 21 to Aug. 18, 2016

Issued Date: Sep. 30, 2016

Applicant: Nokia Solutions and Networks.OY

Address: 1455 West Shure Drive, Arlington Heights, IL 60004, USA

Issued By: Bureau Veritas Consumer Products Services (H.K.) Ltd., Taoyuan Branch
Hsin Chu Laboratory

Lab Address: E-2, No.1, Li Hsin 1st Road, Hsinchu Science Park, Hsinchu City 300,
Taiwan R.O.C.

Test Location (1): E-2, No.1, Li Hsin 1st Road, Hsinchu Science Park, Hsinchu City 300,
Taiwan R.O.C.

Test Location (2): No. 49, Ln. 206, Wende Rd., Shangshan Tsuen, Chiung Lin Hsiang, Hsin
Chu Hsien 307, Taiwan R.O.C.



This report is for your exclusive use. Any copying or replication of this report to or for any other person or entity, or use of our name or trademark, is permitted only with our prior written permission. This report sets forth our findings solely with respect to the test samples identified herein. The results set forth in this report are not indicative or representative of the quality or characteristics of the lot from which a test sample was taken or any similar or identical product unless specifically and expressly noted. Our report includes all of the tests requested by you and the results thereof based upon the information that you provided to us. You have 60 days from date of issuance of this report to notify us of any material error or omission caused by our negligence, provided, however, that such notice shall be in writing and shall specifically address the issue you wish to raise. A failure to raise such issue within the prescribed time shall constitute your unqualified acceptance of the completeness of this report, the tests conducted and the correctness of the report contents. Unless specific mention, the uncertainty of measurement has been explicitly taken into account to declare the compliance or non-compliance to the specification. The report must not be used by the client to claim product certification, approval, or endorsement by TAF or any government agencies.

Table of Contents

Release Control Record	4
1 Certificate of Conformity	5
2 Summary of Test Results	6
2.1 Measurement Uncertainty	6
2.2 Modification Record	6
3 General Information	7
3.1 General Description of EUT	7
3.2 Description of Test Modes	10
3.2.1 Test Mode Applicability and Tested Channel Detail	11
3.3 Duty Cycle of Test Signal	13
3.4 Description of Support Units	14
3.4.1 Configuration of System under Test	15
3.5 General Description of Applied Standards	17
4 Test Types and Results	18
4.1 Radiated Emission and Bandedge Measurement	18
4.1.1 Limits of Radiated Emission and Bandedge Measurement	18
4.1.2 Test Instruments	19
4.1.3 Test Procedures	21
4.1.4 Deviation from Test Standard	21
4.1.5 Test Setup	22
4.1.6 EUT Operating Conditions	22
4.1.7 Test Results (Mode 1)	23
4.1.8 Test Results (Mode 2)	36
4.2 Conducted Emission Measurement	37
4.2.1 Limits of Conducted Emission Measurement	37
4.2.2 Test Instruments	37
4.2.3 Test Procedures	38
4.2.4 Deviation from Test Standard	38
4.2.5 Test Setup	38
4.2.6 EUT Operating Conditions	38
4.2.7 Test Results (Mode 1)	39
4.2.8 Test Results (Mode 2)	41
4.3 6dB Bandwidth Measurement	43
4.3.1 Limits of 6dB Bandwidth Measurement	43
4.3.2 Test Setup	43
4.3.3 Test Instruments	43
4.3.4 Test Procedure	43
4.3.5 Deviation from Test Standard	43
4.3.6 EUT Operating Conditions	43
4.3.7 Test Result	44
4.4 Conducted Output Power Measurement	46
4.4.1 Limits of Conducted Output Power Measurement	46
4.4.2 Test Setup	46
4.4.3 Test Instruments	46
4.4.4 Test Procedures	46
4.4.5 Deviation from Test Standard	46
4.4.6 EUT Operating Conditions	46
4.4.7 Test Results	47
4.5 Power Spectral Density Measurement	49
4.5.1 Limits of Power Spectral Density Measurement	49
4.5.2 Test Setup	49
4.5.3 Test Instruments	49
4.5.4 Test Procedure	49

4.5.5	Deviation from Test Standard	49
4.5.6	EUT Operating Condition	49
4.5.7	Test Results	50
4.6	Conducted Out of Band Emission Measurement	53
4.6.1	Limits of Conducted Out of Band Emission Measurement.....	53
4.6.2	Test Setup.....	53
4.6.3	Test Instruments	53
4.6.4	Test Procedure	53
4.6.5	Deviation from Test Standard	53
4.6.6	EUT Operating Condition	53
4.6.7	Test Results (Overall Spurious Emission Test).....	54
4.6.8	Test Results (Band Edge Test)	71
5	Pictures of Test Arrangements.....	76
	Appendix – Information on the Testing Laboratories	77

Release Control Record

Issue No.	Description	Date Issued
RF160530E01	Original release.	Sep. 30, 2016

1 Certificate of Conformity

Product: Wireless Access Point

Brand: NOKIA

Test Model: WI4A-AC400i

Sample Status: ENGINEERING SAMPLE

Applicant: Nokia Solutions and Networks.OY

Test Date: June 21 to Aug. 18, 2016

Standards: 47 CFR FCC Part 15, Subpart C (Section 15.247)
ANSI C63.10: 2013

The above equipment has been tested by **Bureau Veritas Consumer Products Services (H.K.) Ltd., Taoyuan Branch**, and found compliance with the requirement of the above standards. The test record, data evaluation & Equipment Under Test (EUT) configurations represented herein are true and accurate accounts of the measurements of the sample's EMC characteristics under the conditions specified in this report.

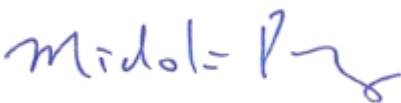
Prepared by :  , **Date:** Sep. 30, 2016
Midoli Peng / Specialist

Approved by :  , **Date:** Sep. 30, 2016
May Chen / Manager

2 Summary of Test Results

47 CFR FCC Part 15, Subpart C (SECTION 15.247)				
FCC Clause	FCC KDB 558074	Test Item	Result	Remarks
15.207	-	AC Power Conducted Emission	PASS	Meet the requirement of limit. Minimum passing margin is -3.05dB at 24.0000MHz.
15.205 / 15.209 / 15.247(d)	Section 11, 12 & 13	Radiated Emissions and Band Edge Measurement	PASS	Meet the requirement of limit. Minimum passing margin is -0.5dB at 2483.50MHz & 2390.00MHz
15.247(d)	Section 11, 12 & 13	Antenna Port Emission	PASS	Meet the requirement of limit.
15.247(a)(2)	Section 8.1	6dB bandwidth	PASS	Meet the requirement of limit.
15.247(b)	Section 9.2.3.2	Transmitter output power	PASS	Meet the requirement of limit.
15.247(e)	Section 10.5	Power Spectral Density	PASS	Meet the requirement of limit.
15.203	-	Antenna Requirement	PASS	Antenna connector is i-pex(MHF) not a standard connector.

2.1 Measurement Uncertainty

Where relevant, the following measurement uncertainty levels have been estimated for tests performed on the EUT as specified in CISPR 16-4-2:

Measurement	Frequency	Expanded Uncertainty (k=2) (±)
Conducted Emissions at mains ports	150kHz ~ 30MHz	1.83 dB
Radiated Emissions up to 1 GHz	30MHz ~ 1GHz	5.31 dB
Radiated Emissions above 1 GHz	1GHz ~ 6GHz	3.40 dB
	6GHz ~ 18GHz	3.73 dB
	18GHz ~ 40GHz	4.11 dB

2.2 Modification Record

There were no modifications required for compliance.

3 General Information

3.1 General Description of EUT

Product	Wireless Access Point
Brand	NOKIA
Test Model	WI4A-AC400i
Test Sample S/N	NH162800087
Hardware Version	AM2
Status of EUT	ENGINEERING SAMPLE
Power Supply Rating	12Vdc from power adapter or 54Vdc from POE
Modulation Type	CCK, DQPSK, DBPSK for DSSS 64QAM, 16QAM, QPSK, BPSK for OFDM
Modulation Technology	DSSS, OFDM
Transfer Rate	802.11b: up to 11Mbps 802.11g: up to 54Mbps 802.11n: up to 600Mbps
Operating Frequency	2.412 ~ 2.462GHz
Number of Channel	802.11b, 802.11g, 802.11n (HT20): 11 802.11n (HT40): 7
Output Power	CDD Mode 884.423mW Beamforming Mode 420.146mW
Antenna Type	Refer to Note
Antenna Connector	Refer to Note
Accessory Device	Adapter x1
Data Cable Supplied	NA

Note:

1. The antennas provided to the EUT, please refer to the following table:

WLAN – 2.4GHz Antenna spec.

Antenna No	PCB Chain No.	Brand	Model	Antenna Type	Gain(dBi)	Frequency (MHz)
1	Chain 1	Galtronics	02102140-06226A1	PIFA	3.92	2400
					3.99	2450
					4.28	2500
2	Chain 0	Galtronics	02102140-06226A2	PIFA	2.27	2400
					1.81	2450
					1.84	2500
3	Chain 2	Galtronics	02102140-06226A3	PIFA	2.42	2400
					2.45	2450
					2.71	2500
4	Chain 3	Galtronics	02102140-06226A4	PIFA	2.88	2400
					3.22	2450
					3.82	2500

Cable Spec.

Antenna No	Brand	Model	Connector Type	Cable Loss(dB)	Cable Length (mm)
1	Galtronics	RG-137	i-pex(MHF)	1.5	175
2	Galtronics	RG-137	i-pex(MHF)	1.3	130
3	Galtronics	RG-137	i-pex(MHF)	0.5	50
4	Galtronics	RG-137	i-pex(MHF)	0.8	75

2. Simultaneously transmission condition.

Condition	Technology	
1	WLAN (2.4GHz)	WLAN (5GHz)

3. The EUT incorporates a MIMO function.

2.4GHz Band			
MODULATION MODE	DATA RATE (MCS)	TX & RX CONFIGURATION	
802.11b	1 ~ 11Mbps	4TX	4RX
802.11g	6 ~ 54Mbps	4TX	4RX
802.11n (HT20)	MCS 0~7	4TX	4RX
	MCS 8~15		
	MCS16~23		
	MCS 24~31		
802.11n (HT40)	MCS 0~7	4TX	4RX
	MCS 8~15		
	MCS16~23		
	MCS 24~31		

Note: All of modulation mode support beamforming function except 802.11b/g modulation mode.

4. The EUT was tested in both DC powered and PoE powered modes of operation using the representative AC/DC power converter and PoE injector listed below:

POE		
Brand	Model No.	Spec.
UE	PoE35-54A	Input: 100-240V, 1.0A, 50/60Hz AC input cable(1.0m, unshielded) Output: 54V, 0.65A
Adapter		
Brand	Model No.	Spec.
UE	UES36-120300SPA	Input: 100-240V, 1.0A, 50/60Hz AC input cable(1.5m, unshielded) Output: 12V, 3.0A DC output cable(1.0m, unshielded, with one core)

5. The EUT was pre-tested under following test modes :

Test Mode	Description
Mode 1	With POE
Mode 2	With adapter

For the above modes, the worst radiated emission (above 1GHz) test was found in **Mode 1**. Therefore only the test data of the modes were recorded in this report.

6. The above EUT information is declared by manufacturer and for more detailed features description, please refer to the manufacturer's specifications or user's manual.

3.2 Description of Test Modes

11 channels are provided for 802.11b, 802.11g and 802.11n (HT20):

Channel	Frequency	Channel	Frequency
1	2412MHz	7	2442MHz
2	2417MHz	8	2447MHz
3	2422MHz	9	2452MHz
4	2427MHz	10	2457MHz
5	2432MHz	11	2462MHz
6	2437MHz		

7 channels are provided for 802.11n (HT40):

Channel	Frequency	Channel	Frequency
3	2422MHz	7	2442MHz
4	2427MHz	8	2447MHz
5	2432MHz	9	2452MHz
6	2437MHz		

3.2.1 Test Mode Applicability and Tested Channel Detail

EUT CONFIGURE MODE	APPLICABLE TO				DESCRIPTION
	RE \geq 1G	RE<1G	PLC	APCM	
1	√	√	√	√	With POE
2	-	√	√	-	With adapter

Where RE \geq 1G: Radiated Emission above 1GHz & Bandedge Measurement
 RE<1G: Radiated Emission below 1GHz
 PLC: Power Line Conducted Emission
 APCM: Antenna Port Conducted Measurement

NOTE: "-" means no effect.

Radiated Emission Test (Above 1GHz):

- Pre-Scan has been conducted to determine the worst-case mode from all possible combinations between available modulations, data rates and antenna ports (if EUT with antenna diversity architecture).
- Following channel(s) was (were) selected for the final test as listed below.

CDD Mode					
MODE	AVAILABLE CHANNEL	TESTED CHANNEL	MODULATION TECHNOLOGY	MODULATION TYPE	DATA RATE (Mbps)
802.11b	1 to 11	1, 6, 11	DSSS	DBPSK	1
802.11g	1 to 11	1, 6, 11	OFDM	BPSK	6
802.11n (HT20)	1 to 11	1, 6, 11	OFDM	BPSK	6.5
802.11n (HT40)	3 to 9	3, 6, 9	OFDM	BPSK	13.5

Radiated Emission Test (Below 1GHz):

- Pre-Scan has been conducted to determine the worst-case mode from all possible combinations between available modulations, data rates and antenna ports (if EUT with antenna diversity architecture).
- Following channel(s) was (were) selected for the final test as listed below.

CDD Mode					
MODE	AVAILABLE CHANNEL	TESTED CHANNEL	MODULATION TECHNOLOGY	MODULATION TYPE	DATA RATE (Mbps)
802.11g	1 to 11	6	OFDM	BPSK	6

Power Line Conducted Emission Test:

- Pre-Scan has been conducted to determine the worst-case mode from all possible combinations between available modulations, data rates and antenna ports (if EUT with antenna diversity architecture).
- Following channel(s) was (were) selected for the final test as listed below.

CDD Mode					
MODE	AVAILABLE CHANNEL	TESTED CHANNEL	MODULATION TECHNOLOGY	MODULATION TYPE	DATA RATE (Mbps)
802.11g	1 to 11	6	OFDM	BPSK	6

Antenna Port Conducted Measurement:

- This item includes all test value of each mode, but only includes spectrum plot of worst value of each mode.
- Pre-Scan has been conducted to determine the worst-case mode from all possible combinations between available modulations, data rates and antenna ports (if EUT with antenna diversity architecture).
- Following channel(s) was (were) selected for the final test as listed below.

CDD Mode					
MODE	AVAILABLE CHANNEL	TESTED CHANNEL	MODULATION TECHNOLOGY	MODULATION TYPE	DATA RATE (Mbps)
802.11b	1 to 11	1, 6, 11	DSSS	DBPSK	1
802.11g	1 to 11	1, 6, 11	OFDM	BPSK	6
802.11n (HT20)	1 to 11	1, 6, 11	OFDM	BPSK	6.5
802.11n (HT40)	3 to 9	3, 6, 9	OFDM	BPSK	13.5
Beamforming Mode (Output power only)					
MODE	AVAILABLE CHANNEL	TESTED CHANNEL	MODULATION TECHNOLOGY	MODULATION TYPE	DATA RATE (Mbps)
802.11n (HT20)	1 to 11	1, 6, 11	OFDM	BPSK	6.5
802.11n (HT40)	3 to 9	3, 6, 9	OFDM	BPSK	13.5

Test Condition:

Input Power to POE

APPLICABLE TO	ENVIRONMENTAL CONDITIONS	INPUT POWER	TESTED BY
RE \geq 1G	25deg. C, 65%RH	120Vac, 60Hz	Jyunchun Lin
RE<1G	24deg. C, 62%RH	120Vac, 60Hz	Jyunchun Lin
PLC	25deg. C, 61%RH	120Vac, 60Hz	Jyunchun Lin
APCM	25deg. C, 60%RH	120Vac, 60Hz	Robert Cheng

Input Power to Adapter

APPLICABLE TO	ENVIRONMENTAL CONDITIONS	INPUT POWER	TESTED BY
RE<1G	24deg. C, 62%RH	120Vac, 60Hz	Jyunchun Lin
PLC	25deg. C, 61%RH	120Vac, 60Hz	Jyunchun Lin

3.3 Duty Cycle of Test Signal

If duty cycle of test signal is $\geq 98\%$, duty factor is not required.

If duty cycle of test signal is $< 98\%$, duty factor shall be considered.

802.11b: Duty cycle = $12.494/12.6 = 0.992$

802.11g: Duty cycle = $2.062/2.100 = 0.982$

802.11n (HT20): Duty cycle = $4.996/5.063 = 0.987$

802.11n (HT40): Duty cycle = $2.428/2.496 = 0.973$, Duty factor = $10 * \log(1/0.973) = 0.12$

802.11b

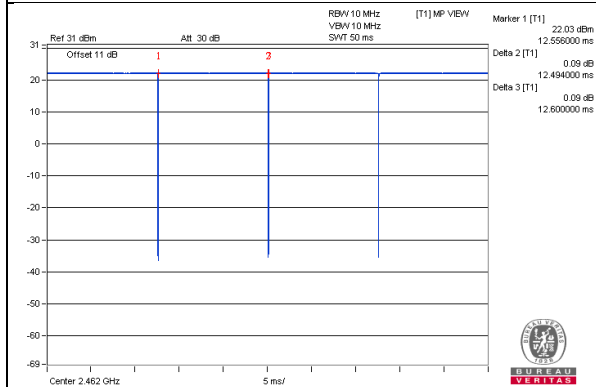

802.11g

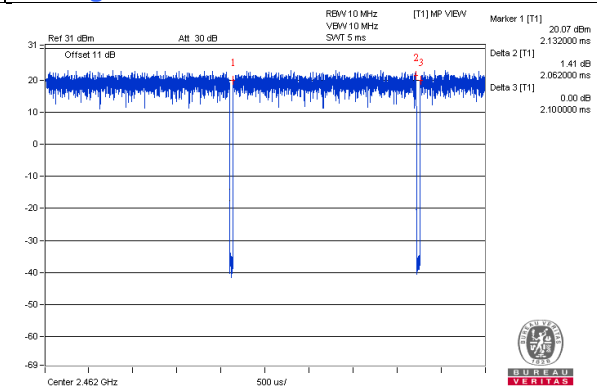

802.11n (HT20)

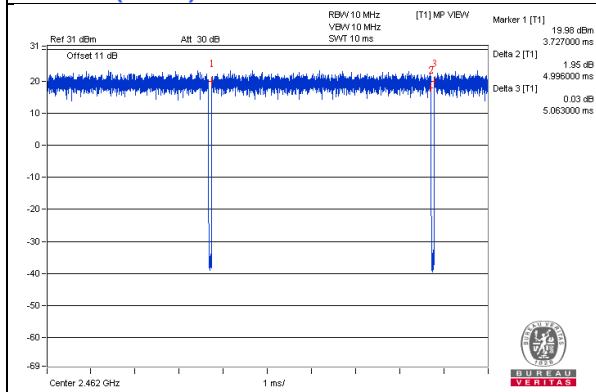

802.11n (HT40)

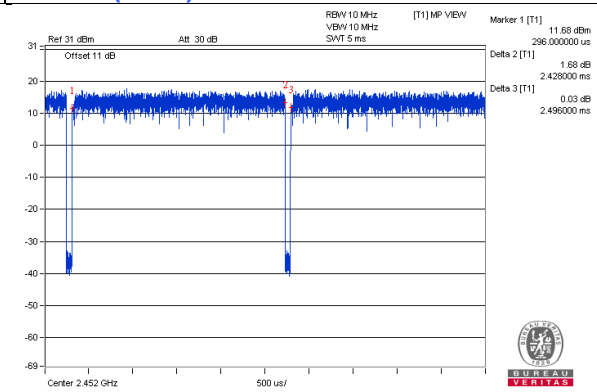

3.4 Description of Support Units

The EUT has been tested as an independent unit together with other necessary accessories or support units. The following support units or accessories were used to form a representative test configuration during the tests.

ID	Product	Brand	Model No.	Serial No.	FCC ID	Remarks
A.	Notebook Computer	DELL	E5430	HYV4VY1	FCC DoC	Provided by Lab
B.	HUB	ZyXEL	ES-116P	S060H02000215	FCC DoC	Provided by Lab
C.	iPod shuffle	Apple	MC749TA/A	CC4DMFKUDFDM	NA	Provided by Lab

Note:

1. All power cords of the above support units are non-shielded (1.8m).

ID	Descriptions	Qty.	Length (m)	Shielding (Yes/No)	Cores (Qty.)	Remarks
1.	RJ-45 Cable	1	10	No	0	Provided by Lab
2.	RJ-45 Cable	1	10	No	0	Provided by Lab
3.	DC Cable	1	1.0	No	0	Supplied by client
4.	AC Cable	1	1.5	No	0	Supplied by client
5.	USB Cable	1	0.1	Yes	0	Provided by Lab
6.	RJ-45 Cable	1	1.5	No	0	Provided by Lab

3.4.1 Configuration of System under Test

With adapter mode:

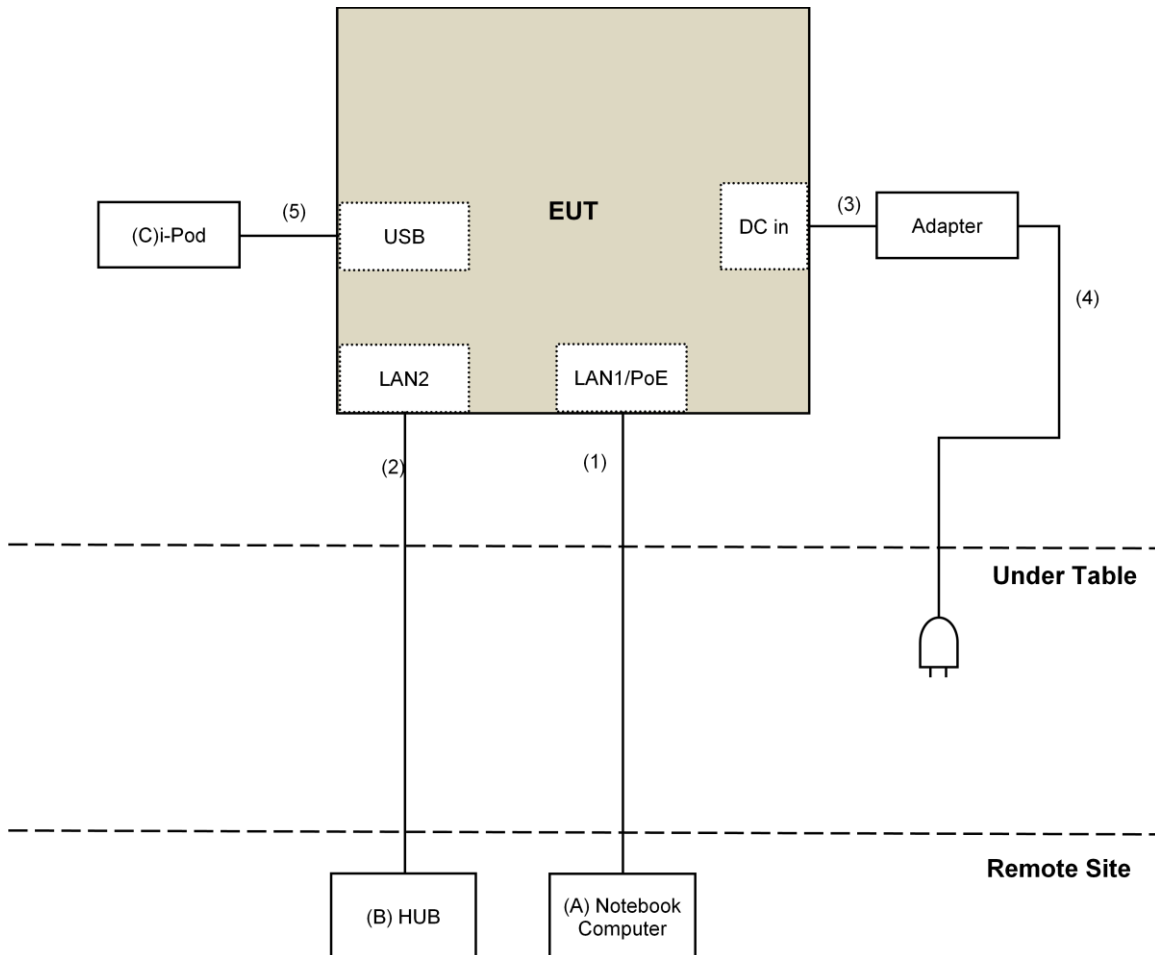

With POE mode:

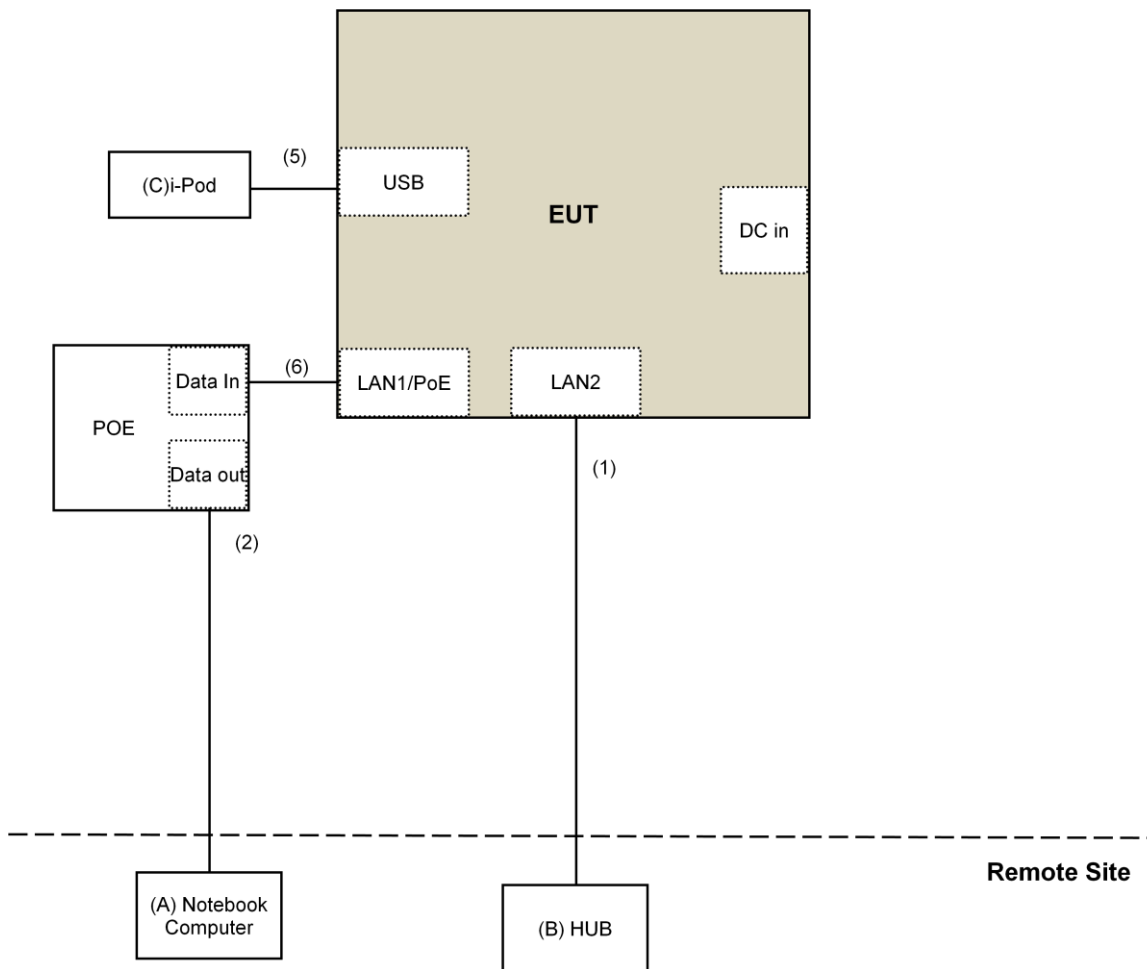

3.5 General Description of Applied Standards

The EUT is a RF Product. According to the specifications of the manufacturer, it must comply with the requirements of the following standards:

FCC Part 15, Subpart C (15.247)

KDB 558074 D01 DTS Meas Guidance v03r05

KDB 662911 D01 Multiple Transmitter Output v02r01

ANSI C63.10-2013

All test items have been performed and recorded as per the above standards.

4 Test Types and Results

4.1 Radiated Emission and Bandedge Measurement

4.1.1 Limits of Radiated Emission and Bandedge Measurement

Radiated emissions which fall in the restricted bands must comply with the radiated emission limits specified as below table. Other emissions shall be at least 30dB below the highest level of the desired power:

Frequencies (MHz)	Field Strength (microvolts/meter)	Measurement Distance (meters)
0.009 ~ 0.490	2400/F(kHz)	300
0.490 ~ 1.705	24000/F(kHz)	30
1.705 ~ 30.0	30	30
30 ~ 88	100	3
88 ~ 216	150	3
216 ~ 960	200	3
Above 960	500	3

NOTE:

1. The lower limit shall apply at the transition frequencies.
2. Emission level (dBuV/m) = 20 log Emission level (uV/m).
3. For frequencies above 1000MHz, the field strength limits are based on average detector, however, the peak field strength of any emission shall not exceed the maximum permitted average limits, specified above by more than 20dB under any condition of modulation.

4.1.2 Test Instruments

DESCRIPTION & MANUFACTURER	MODEL NO.	SERIAL NO.	CALIBRATED DATE	CALIBRATED UNTIL
Test Receiver Agilent	N9038A	MY50010156	Aug. 12, 2015	Aug. 11, 2016
Pre-Amplifier ^(*) EMCI	EMC001340	980142	Jan. 20, 2016	Jan. 19, 2018
Loop Antenna ^(*) Electro-Metrics	EM-6879	264	Dec. 16, 2014	Dec. 15, 2016
RF Cable	NA	LOOPCAB-001 LOOPCAB-002	Jan. 18, 2016	Jan. 17, 2017
Pre-Amplifier Mini-Circuits	ZFL-1000VH2 B	AMP-ZFL-05	May 07, 2016	May 06, 2017
Trilog Broadband Antenna SCHWARZBECK	VULB 9168	9168-156	Jan. 04, 2016	Jan. 03, 2017
RF Cable	8D	966-3-1 966-3-2 966-3-3	Apr. 02, 2016	Apr. 01, 2017
Horn_Antenna SCHWARZBECK	BBHA9120-D	9120D-406	Jan. 20, 2016	Jan. 19, 2017
Pre-Amplifier Agilent	8449B	3008A02465	Apr. 05, 2016	Apr. 04, 2017
RF Cable	EMC104-SM- SM-2000 EMC104-SM- SM-5000 EMC104-SM- SM-5000	150317 150321 150322	Mar. 30, 2016	Mar. 29, 2017
Spectrum Analyzer Keysight	N9030A	MY54490520	July 29, 2016	July 28, 2017
Pre-Amplifier EMCI	EMC184045	980143	Jan. 15, 2016	Jan. 14, 2017
Horn_Antenna SCHWARZBECK	BBHA 9170	BBHA9170608	Jan. 08, 2016	Jan. 07, 2017
RF Cable	SUCOFLEX 102	36432/2 36441/2	Jan. 16, 2016	Jan. 15, 2017
Software	ADT_Radiated _V8.7.07	NA	NA	NA
Antenna Tower & Turn Table Max-Full	MF-7802	MF780208406	NA	NA
Boresight Antenna Fixture	FBA-01	FBA-SIP01	NA	NA
Spectrum Analyzer R&S	FSP40	100036	Jan. 27, 2016	Jan. 26, 2017
Power meter Anritsu	ML2495A	0824006	May 26, 2016	May 25, 2017
Power sensor Anritsu	MA2411B	0738172	May 26, 2016	May 25, 2017

Note:

1. The calibration interval of the above test instruments is 12 months and the calibrations are traceable to NML/ROC and NIST/USA.
2. *The calibration interval of the above test instruments is 24 months and the calibrations are traceable to NML/ROC and NIST/USA.
3. Loop antenna was used for all emissions below 30 MHz.
4. The test was performed in 966 Chamber No. 3.
5. The FCC Site Registration No. is 147459
6. The CANADA Site Registration No. is 20331-1
7. Tested Date: July 30 to Aug. 08, 2016

4.1.3 Test Procedures

- a. The EUT was placed on the top of a rotating table 0.8 meters (for below 1GHz) / 1.5 meters (for above 1GHz) above the ground at 3 meter chamber room for test. The table was rotated 360 degrees to determine the position of the highest radiation.
- b. The EUT was set 3 meters away from the interference-receiving antenna, which was mounted on the top of a variable-height antenna tower.
- c. The height of antenna is varied from one meter to four meters above the ground to determine the maximum value of the field strength. Both horizontal and vertical polarizations of the antenna are set to make the measurement.
- d. For each suspected emission, the EUT was arranged to its worst case and then the antenna was tuned to heights from 1 meter to 4 meters and the rotatable table was turned from 0 degrees to 360 degrees to find the maximum reading.
- e. The test-receiver system was set to quasi-peak detect function and specified bandwidth with maximum hold mode when the test frequency is below 1 GHz.
- f. The test-receiver system was set to peak and average detect function and specified bandwidth with maximum hold mode when the test frequency is above 1 GHz. If the peak reading value also meets average limit, measurement with the average detector is unnecessary.

Note:

1. The resolution bandwidth and video bandwidth of test receiver/spectrum analyzer is 120kHz for Quasi-peak detection (QP) at frequency below 1GHz.
2. The resolution bandwidth of test receiver/spectrum analyzer is 1 MHz and the video bandwidth is 3 MHz for Peak detection (PK) at frequency above 1GHz.
3. The resolution bandwidth of test receiver/spectrum analyzer is 1MHz and the video bandwidth is $\geq 1/T$ (Duty cycle < 98%) or 10Hz (Duty cycle $\geq 98\%$) for Average detection (AV) at frequency above 1GHz.
4. All modes of operation were investigated and the worst-case emissions are reported.

4.1.4 Deviation from Test Standard

No deviation.

4.1.5 Test Setup

<Frequency Range below 1GHz>

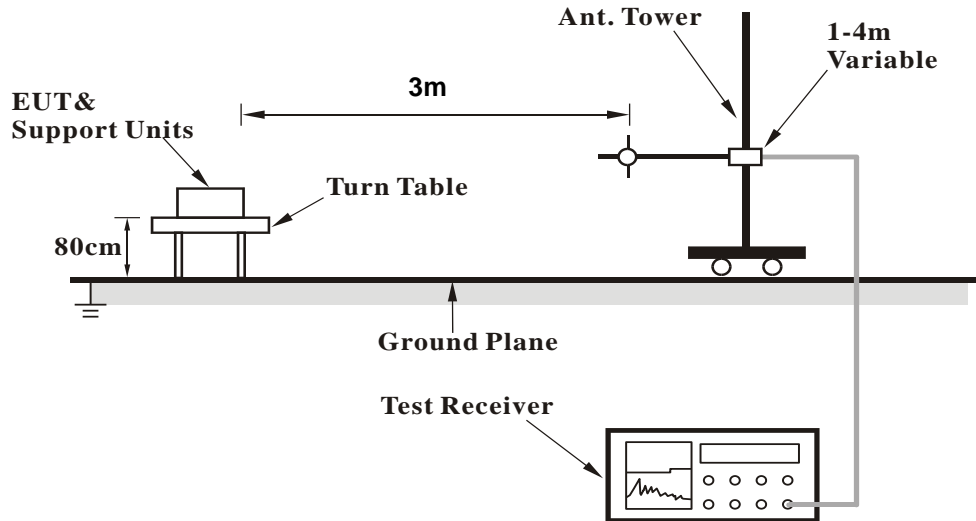

<Frequency Range above 1GHz>

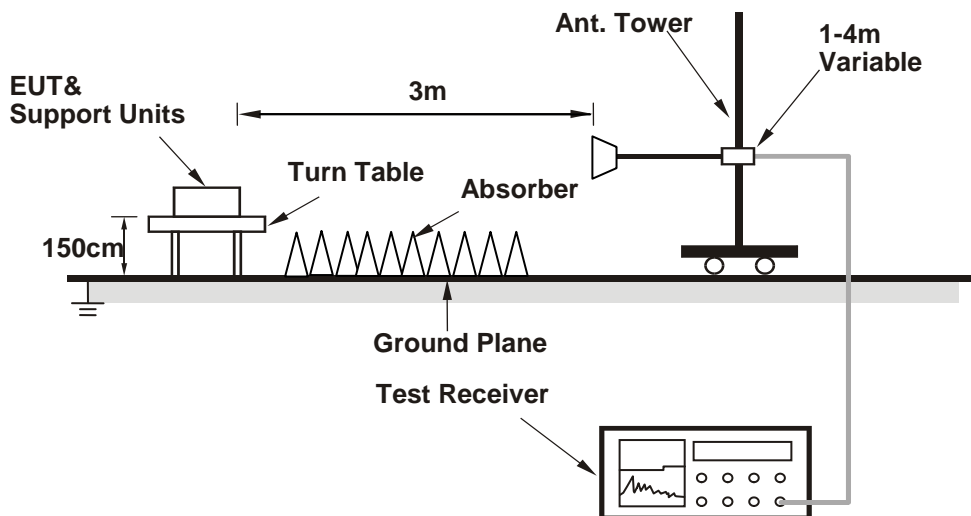

For the actual test configuration, please refer to the attached file (Test Setup Photo).

4.1.6 EUT Operating Conditions

- Connect the EUT with the support unit A (Notebook Computer) which is placed outside of testing area.
- The communication partner run test program "QRCT.exe[Ver3.0.174.0]" to enable EUT under transmission/receiving condition continuously at specific channel frequency.
- Support unit C (iPod shuffle) was connected to EUT via one USB cable to simulate real connection.

4.1.7 Test Results (Mode 1)

Above 1GHz Data :

802.11b

CHANNEL	TX Channel 1	DETECTOR FUNCTION	Peak (PK)
FREQUENCY RANGE	1GHz ~ 25GHz		Average (AV)

ANTENNA POLARITY & TEST DISTANCE: HORIZONTAL AT 3 M

NO.	FREQ. (MHz)	EMISSION LEVEL (dBuV/m)	LIMIT (dBuV/m)	MARGIN (dB)	ANTENNA HEIGHT (m)	TABLE ANGLE (Degree)	RAW VALUE (dBuV)	CORRECTION FACTOR (dB/m)
1	2390.00	59.2 PK	74.0	-14.8	2.71 H	250	63.4	-4.2
2	2390.00	52.7 AV	54.0	-1.3	2.71 H	250	56.9	-4.2
3	*2412.00	117.9 PK			2.71 H	250	122.0	-4.1
4	*2412.00	115.5 AV			2.71 H	250	119.6	-4.1
5	4824.00	46.2 PK	74.0	-27.8	1.06 H	149	43.9	2.3
6	4824.00	41.8 AV	54.0	-12.2	1.06 H	149	39.5	2.3

ANTENNA POLARITY & TEST DISTANCE: VERTICAL AT 3 M

NO.	FREQ. (MHz)	EMISSION LEVEL (dBuV/m)	LIMIT (dBuV/m)	MARGIN (dB)	ANTENNA HEIGHT (m)	TABLE ANGLE (Degree)	RAW VALUE (dBuV)	CORRECTION FACTOR (dB/m)
1	2390.00	57.8 PK	74.0	-16.2	3.77 V	205	62.0	-4.2
2	2390.00	51.2 AV	54.0	-2.8	3.77 V	205	55.4	-4.2
3	*2412.00	116.8 PK			3.77 V	205	120.9	-4.1
4	*2412.00	114.2 AV			3.77 V	205	118.3	-4.1
5	4824.00	46.0 PK	74.0	-28.0	1.05 V	173	43.7	2.3
6	4824.00	41.3 AV	54.0	-12.7	1.05 V	173	39.0	2.3

REMARKS:

1. Emission Level(dBuV/m) = Raw Value(dBuV) + Correction Factor(dB/m)
2. Correction Factor(dB/m) = Antenna Factor(dB/m) + Cable Factor(dB) – Pre-Amplifier Factor(dB)
3. The other emission levels were very low against the limit.
4. Margin value = Emission Level – Limit value
5. " * ": Fundamental frequency.

CHANNEL	TX Channel 6	DETECTOR FUNCTION	Peak (PK)
FREQUENCY RANGE	1GHz ~ 25GHz		Average (AV)

ANTENNA POLARITY & TEST DISTANCE: HORIZONTAL AT 3 M

NO.	FREQ. (MHz)	EMISSION LEVEL (dBuV/m)	LIMIT (dBuV/m)	MARGIN (dB)	ANTENNA HEIGHT (m)	TABLE ANGLE (Degree)	RAW VALUE (dBuV)	CORRECTION FACTOR (dB/m)
1	2387.00	57.6 PK	74.0	-16.4	2.55 H	249	61.9	-4.3
2	2387.00	52.1 AV	54.0	-1.9	2.55 H	249	56.4	-4.3
3	*2437.00	120.8 PK			2.55 H	249	124.8	-4.0
4	*2437.00	118.6 AV			2.55 H	249	122.6	-4.0
5	2496.00	57.1 PK	74.0	-16.9	2.55 H	249	61.0	-3.9
6	2496.00	51.3 AV	54.0	-2.7	2.55 H	249	55.2	-3.9
7	4874.00	54.5 PK	74.0	-19.5	1.00 H	147	52.0	2.5
8	4874.00	52.6 AV	54.0	-1.4	1.00 H	147	50.1	2.5
9	7311.00	57.3 PK	74.0	-16.7	2.04 H	237	48.4	8.9
10	7311.00	51.3 AV	54.0	-2.7	2.04 H	237	42.4	8.9

ANTENNA POLARITY & TEST DISTANCE: VERTICAL AT 3 M

NO.	FREQ. (MHz)	EMISSION LEVEL (dBuV/m)	LIMIT (dBuV/m)	MARGIN (dB)	ANTENNA HEIGHT (m)	TABLE ANGLE (Degree)	RAW VALUE (dBuV)	CORRECTION FACTOR (dB/m)
1	2387.00	56.2 PK	74.0	-17.8	3.86 V	215	60.5	-4.3
2	2387.00	50.5 AV	54.0	-3.5	3.86 V	215	54.8	-4.3
3	*2437.00	119.7 PK			3.86 V	215	123.7	-4.0
4	*2437.00	117.3 AV			3.86 V	215	121.3	-4.0
5	2496.00	55.7 PK	74.0	-18.3	3.86 V	215	59.6	-3.9
6	2496.00	50.1 AV	54.0	-3.9	3.86 V	215	54.0	-3.9
7	4874.00	52.1 PK	74.0	-21.9	1.00 V	161	49.6	2.5
8	4874.00	49.9 AV	54.0	-4.1	1.00 V	161	47.4	2.5
9	7311.00	51.3 PK	74.0	-22.7	1.52 V	179	42.4	8.9
10	7311.00	45.2 AV	54.0	-8.8	1.52 V	179	36.3	8.9

REMARKS:

1. Emission Level(dBuV/m) = Raw Value(dBuV) + Correction Factor(dB/m)
2. Correction Factor(dB/m) = Antenna Factor(dB/m) + Cable Factor(dB) – Pre-Amplifier Factor(dB)
3. The other emission levels were very low against the limit.
4. Margin value = Emission Level – Limit value
5. " * ": Fundamental frequency.

CHANNEL	TX Channel 11	DETECTOR FUNCTION	Peak (PK)
FREQUENCY RANGE	1GHz ~ 25GHz		Average (AV)

ANTENNA POLARITY & TEST DISTANCE: HORIZONTAL AT 3 M

NO.	FREQ. (MHz)	EMISSION LEVEL (dBuV/m)	LIMIT (dBuV/m)	MARGIN (dB)	ANTENNA HEIGHT (m)	TABLE ANGLE (Degree)	RAW VALUE (dBuV)	CORRECTION FACTOR (dB/m)
1	*2462.00	118.8 PK			2.39 H	249	122.9	-4.1
2	*2462.00	116.3 AV			2.39 H	249	120.4	-4.1
3	2483.50	60.2 PK	74.0	-13.8	2.39 H	249	64.2	-4.0
4	2483.50	53.5 AV	54.0	-0.5	2.39 H	249	57.5	-4.0
5	4924.00	45.7 PK	74.0	-28.3	1.08 H	140	43.2	2.5
6	4924.00	41.6 AV	54.0	-12.4	1.08 H	140	39.1	2.5
7	7386.00	48.6 PK	74.0	-25.4	2.05 H	225	39.3	9.3
8	7386.00	39.6 AV	54.0	-14.4	2.05 H	225	30.3	9.3

ANTENNA POLARITY & TEST DISTANCE: VERTICAL AT 3 M

NO.	FREQ. (MHz)	EMISSION LEVEL (dBuV/m)	LIMIT (dBuV/m)	MARGIN (dB)	ANTENNA HEIGHT (m)	TABLE ANGLE (Degree)	RAW VALUE (dBuV)	CORRECTION FACTOR (dB/m)
1	*2462.00	117.4 PK			3.77 V	200	121.5	-4.1
2	*2462.00	114.9 AV			3.77 V	200	119.0	-4.1
3	2483.50	59.1 PK	74.0	-14.9	3.77 V	200	63.1	-4.0
4	2483.50	52.5 AV	54.0	-1.5	3.77 V	200	56.5	-4.0
5	4924.00	46.1 PK	74.0	-27.9	1.00 V	164	43.6	2.5
6	4924.00	41.7 AV	54.0	-12.3	1.00 V	164	39.2	2.5
7	7386.00	48.5 PK	74.0	-25.5	1.52 V	217	39.2	9.3
8	7386.00	39.7 AV	54.0	-14.3	1.52 V	217	30.4	9.3

REMARKS:

1. Emission Level(dBuV/m) = Raw Value(dBuV) + Correction Factor(dB/m)
2. Correction Factor(dB/m) = Antenna Factor(dB/m) + Cable Factor(dB) – Pre-Amplifier Factor(dB)
3. The other emission levels were very low against the limit.
4. Margin value = Emission Level – Limit value
5. " * ": Fundamental frequency.

802.11g

CHANNEL	TX Channel 1	DETECTOR FUNCTION	Peak (PK)
FREQUENCY RANGE	1GHz ~ 25GHz		Average (AV)

ANTENNA POLARITY & TEST DISTANCE: HORIZONTAL AT 3 M

NO.	FREQ. (MHz)	EMISSION LEVEL (dBuV/m)	LIMIT (dBuV/m)	MARGIN (dB)	ANTENNA HEIGHT (m)	TABLE ANGLE (Degree)	RAW VALUE (dBuV)	CORRECTION FACTOR (dB/m)
1	2390.00	69.4 PK	74.0	-4.6	3.02 H	251	73.6	-4.2
2	2390.00	53.5 AV	54.0	-0.5	3.02 H	251	57.7	-4.2
3	*2412.00	116.3 PK			3.02 H	251	120.4	-4.1
4	*2412.00	104.8 AV			3.02 H	251	108.9	-4.1
5	4824.00	45.4 PK	74.0	-28.6	1.06 H	134	43.1	2.3
6	4824.00	34.5 AV	54.0	-19.5	1.06 H	134	32.2	2.3

ANTENNA POLARITY & TEST DISTANCE: VERTICAL AT 3 M

NO.	FREQ. (MHz)	EMISSION LEVEL (dBuV/m)	LIMIT (dBuV/m)	MARGIN (dB)	ANTENNA HEIGHT (m)	TABLE ANGLE (Degree)	RAW VALUE (dBuV)	CORRECTION FACTOR (dB/m)
1	2390.00	63.1 PK	74.0	-10.9	3.81 V	213	67.3	-4.2
2	2390.00	47.8 AV	54.0	-6.2	3.81 V	213	52.0	-4.2
3	*2412.00	116.1 PK			3.81 V	213	120.2	-4.1
4	*2412.00	103.8 AV			3.81 V	213	107.9	-4.1
5	4824.00	46.2 PK	74.0	-27.8	1.09 V	157	43.9	2.3
6	4824.00	34.9 AV	54.0	-19.1	1.09 V	157	32.6	2.3

REMARKS:

1. Emission Level(dBuV/m) = Raw Value(dBuV) + Correction Factor(dB/m)
2. Correction Factor(dB/m) = Antenna Factor(dB/m) + Cable Factor(dB) – Pre-Amplifier Factor(dB)
3. The other emission levels were very low against the limit.
4. Margin value = Emission Level – Limit value
5. " * ": Fundamental frequency.

CHANNEL	TX Channel 6	DETECTOR FUNCTION	Peak (PK)
FREQUENCY RANGE	1GHz ~ 25GHz		Average (AV)

ANTENNA POLARITY & TEST DISTANCE: HORIZONTAL AT 3 M

NO.	FREQ. (MHz)	EMISSION LEVEL (dBuV/m)	LIMIT (dBuV/m)	MARGIN (dB)	ANTENNA HEIGHT (m)	TABLE ANGLE (Degree)	RAW VALUE (dBuV)	CORRECTION FACTOR (dB/m)
1	2390.00	70.1 PK	74.0	-3.9	2.65 H	236	74.3	-4.2
2	2390.00	52.3 AV	54.0	-1.7	2.65 H	236	56.5	-4.2
3	*2437.00	120.7 PK			2.65 H	236	124.7	-4.0
4	*2437.00	109.4 AV			2.65 H	236	113.4	-4.0
5	2483.50	66.1 PK	74.0	-7.9	2.65 H	236	70.1	-4.0
6	2483.50	50.8 AV	54.0	-3.2	2.65 H	236	54.8	-4.0
7	4874.00	45.4 PK	74.0	-28.6	1.02 H	139	42.9	2.5
8	4874.00	34.3 AV	54.0	-19.7	1.02 H	139	31.8	2.5
9	7311.00	48.7 PK	74.0	-25.3	2.06 H	216	39.8	8.9
10	7311.00	37.1 AV	54.0	-16.9	2.06 H	216	28.2	8.9

ANTENNA POLARITY & TEST DISTANCE: VERTICAL AT 3 M

NO.	FREQ. (MHz)	EMISSION LEVEL (dBuV/m)	LIMIT (dBuV/m)	MARGIN (dB)	ANTENNA HEIGHT (m)	TABLE ANGLE (Degree)	RAW VALUE (dBuV)	CORRECTION FACTOR (dB/m)
1	2390.00	68.8 PK	74.0	-5.2	3.79 V	210	73.0	-4.2
2	2390.00	51.3 AV	54.0	-2.7	3.79 V	210	55.5	-4.2
3	*2437.00	118.8 PK			3.79 V	210	122.8	-4.0
4	*2437.00	107.5 AV			3.79 V	210	111.5	-4.0
5	2483.50	64.4 PK	74.0	-9.6	3.79 V	210	68.4	-4.0
6	2483.50	49.0 AV	54.0	-5.0	3.79 V	210	53.0	-4.0
7	4874.00	45.8 PK	74.0	-28.2	1.00 V	163	43.3	2.5
8	4874.00	34.5 AV	54.0	-19.5	1.00 V	163	32.0	2.5
9	7311.00	48.4 PK	74.0	-25.6	1.52 V	186	39.5	8.9
10	7311.00	36.8 AV	54.0	-17.2	1.52 V	186	27.9	8.9

REMARKS:

1. Emission Level(dBuV/m) = Raw Value(dBuV) + Correction Factor(dB/m)
2. Correction Factor(dB/m) = Antenna Factor(dB/m) + Cable Factor(dB) – Pre-Amplifier Factor(dB)
3. The other emission levels were very low against the limit.
4. Margin value = Emission Level – Limit value
5. " * ": Fundamental frequency.

CHANNEL	TX Channel 11	DETECTOR FUNCTION	Peak (PK)
FREQUENCY RANGE	1GHz ~ 25GHz		Average (AV)

ANTENNA POLARITY & TEST DISTANCE: HORIZONTAL AT 3 M

NO.	FREQ. (MHz)	EMISSION LEVEL (dBuV/m)	LIMIT (dBuV/m)	MARGIN (dB)	ANTENNA HEIGHT (m)	TABLE ANGLE (Degree)	RAW VALUE (dBuV)	CORRECTION FACTOR (dB/m)
1	*2462.00	117.5 PK			2.62 H	231	121.6	-4.1
2	*2462.00	105.7 AV			2.62 H	231	109.8	-4.1
3	2483.50	65.3 PK	74.0	-8.7	2.62 H	231	69.3	-4.0
4	2483.50	52.8 AV	54.0	-1.2	2.62 H	231	56.8	-4.0
5	4924.00	45.5 PK	74.0	-28.5	1.02 H	129	43.0	2.5
6	4924.00	34.5 AV	54.0	-19.5	1.02 H	129	32.0	2.5
7	7386.00	49.1 PK	74.0	-24.9	2.01 H	218	39.8	9.3
8	7386.00	37.6 AV	54.0	-16.4	2.01 H	218	28.3	9.3

ANTENNA POLARITY & TEST DISTANCE: VERTICAL AT 3 M

NO.	FREQ. (MHz)	EMISSION LEVEL (dBuV/m)	LIMIT (dBuV/m)	MARGIN (dB)	ANTENNA HEIGHT (m)	TABLE ANGLE (Degree)	RAW VALUE (dBuV)	CORRECTION FACTOR (dB/m)
1	*2462.00	116.0 PK			3.79 V	202	120.1	-4.1
2	*2462.00	103.9 AV			3.79 V	202	108.0	-4.1
3	2483.50	63.9 PK	74.0	-10.1	3.79 V	202	67.9	-4.0
4	2483.50	51.2 AV	54.0	-2.8	3.79 V	202	55.2	-4.0
5	4924.00	46.2 PK	74.0	-27.8	1.04 V	160	43.7	2.5
6	4924.00	34.6 AV	54.0	-19.4	1.04 V	160	32.1	2.5
7	7386.00	48.0 PK	74.0	-26.0	1.51 V	187	38.7	9.3
8	7386.00	36.4 AV	54.0	-17.6	1.51 V	187	27.1	9.3

REMARKS:

1. Emission Level(dBuV/m) = Raw Value(dBuV) + Correction Factor(dB/m)
2. Correction Factor(dB/m) = Antenna Factor(dB/m) + Cable Factor(dB) – Pre-Amplifier Factor(dB)
3. The other emission levels were very low against the limit.
4. Margin value = Emission Level – Limit value
5. " * ": Fundamental frequency.

802.11n (HT20)

CHANNEL	TX Channel 1	DETECTOR FUNCTION	Peak (PK)
FREQUENCY RANGE	1GHz ~ 25GHz		Average (AV)

ANTENNA POLARITY & TEST DISTANCE: HORIZONTAL AT 3 M

NO.	FREQ. (MHz)	EMISSION LEVEL (dBuV/m)	LIMIT (dBuV/m)	MARGIN (dB)	ANTENNA HEIGHT (m)	TABLE ANGLE (Degree)	RAW VALUE (dBuV)	CORRECTION FACTOR (dB/m)
1	2390.00	68.1 PK	74.0	-5.9	3.08 H	255	72.3	-4.2
2	2390.00	52.9 AV	54.0	-1.1	3.08 H	255	57.1	-4.2
3	*2412.00	115.9 PK			3.08 H	255	120.0	-4.1
4	*2412.00	104.4 AV			3.08 H	255	108.5	-4.1
5	4824.00	45.4 PK	74.0	-28.6	1.00 H	136	43.1	2.3
6	4824.00	34.3 AV	54.0	-19.7	1.00 H	136	32.0	2.3

ANTENNA POLARITY & TEST DISTANCE: VERTICAL AT 3 M

NO.	FREQ. (MHz)	EMISSION LEVEL (dBuV/m)	LIMIT (dBuV/m)	MARGIN (dB)	ANTENNA HEIGHT (m)	TABLE ANGLE (Degree)	RAW VALUE (dBuV)	CORRECTION FACTOR (dB/m)
1	2390.00	66.3 PK	74.0	-7.7	3.77 V	223	70.5	-4.2
2	2390.00	51.4 AV	54.0	-2.6	3.77 V	223	55.6	-4.2
3	*2412.00	114.2 PK			3.77 V	223	118.3	-4.1
4	*2412.00	102.5 AV			3.77 V	223	106.6	-4.1
5	4824.00	46.7 PK	74.0	-27.3	1.04 V	157	44.4	2.3
6	4824.00	34.9 AV	54.0	-19.1	1.04 V	157	32.6	2.3

REMARKS:

1. Emission Level(dBuV/m) = Raw Value(dBuV) + Correction Factor(dB/m)
2. Correction Factor(dB/m) = Antenna Factor(dB/m) + Cable Factor(dB) – Pre-Amplifier Factor(dB)
3. The other emission levels were very low against the limit.
4. Margin value = Emission Level – Limit value
5. " * ": Fundamental frequency.

CHANNEL	TX Channel 6	DETECTOR FUNCTION	Peak (PK)
FREQUENCY RANGE	1GHz ~ 25GHz		Average (AV)

ANTENNA POLARITY & TEST DISTANCE: HORIZONTAL AT 3 M

NO.	FREQ. (MHz)	EMISSION LEVEL (dBuV/m)	LIMIT (dBuV/m)	MARGIN (dB)	ANTENNA HEIGHT (m)	TABLE ANGLE (Degree)	RAW VALUE (dBuV)	CORRECTION FACTOR (dB/m)
1	2390.00	66.5 PK	74.0	-7.5	3.33 H	227	70.7	-4.2
2	2390.00	53.5 AV	54.0	-0.5	3.33 H	227	57.7	-4.2
3	*2437.00	121.1 PK			3.33 H	227	125.1	-4.0
4	*2437.00	110.6 AV			3.33 H	227	114.6	-4.0
5	2483.50	66.3 PK	74.0	-7.7	3.33 H	227	70.3	-4.0
6	2483.50	50.6 AV	54.0	-3.4	3.33 H	227	54.6	-4.0
7	4874.00	45.7 PK	74.0	-28.3	1.07 H	126	43.2	2.5
8	4874.00	34.5 AV	54.0	-19.5	1.07 H	126	32.0	2.5
9	7311.00	49.0 PK	74.0	-25.0	1.97 H	226	40.1	8.9
10	7311.00	37.2 AV	54.0	-16.8	1.97 H	226	28.3	8.9

ANTENNA POLARITY & TEST DISTANCE: VERTICAL AT 3 M

NO.	FREQ. (MHz)	EMISSION LEVEL (dBuV/m)	LIMIT (dBuV/m)	MARGIN (dB)	ANTENNA HEIGHT (m)	TABLE ANGLE (Degree)	RAW VALUE (dBuV)	CORRECTION FACTOR (dB/m)
1	2390.00	64.9 PK	74.0	-9.1	3.80 V	228	69.1	-4.2
2	2390.00	51.9 AV	54.0	-2.1	3.80 V	228	56.1	-4.2
3	*2437.00	119.7 PK			3.80 V	228	123.7	-4.0
4	*2437.00	109.0 AV			3.80 V	228	113.0	-4.0
5	2483.50	64.5 PK	74.0	-9.5	3.80 V	228	68.5	-4.0
6	2483.50	49.0 AV	54.0	-5.0	3.80 V	228	53.0	-4.0
7	4874.00	45.8 PK	74.0	-28.2	1.01 V	154	43.3	2.5
8	4874.00	34.5 AV	54.0	-19.5	1.01 V	154	32.0	2.5
9	7311.00	47.9 PK	74.0	-26.1	1.54 V	187	39.0	8.9
10	7311.00	36.3 AV	54.0	-17.7	1.54 V	187	27.4	8.9

REMARKS:

1. Emission Level(dBuV/m) = Raw Value(dBuV) + Correction Factor(dB/m)
2. Correction Factor(dB/m) = Antenna Factor(dB/m) + Cable Factor(dB) – Pre-Amplifier Factor(dB)
3. The other emission levels were very low against the limit.
4. Margin value = Emission Level – Limit value
5. " * ": Fundamental frequency.

CHANNEL	TX Channel 11	DETECTOR FUNCTION	Peak (PK)
FREQUENCY RANGE	1GHz ~ 25GHz		Average (AV)

ANTENNA POLARITY & TEST DISTANCE: HORIZONTAL AT 3 M

NO.	FREQ. (MHz)	EMISSION LEVEL (dBuV/m)	LIMIT (dBuV/m)	MARGIN (dB)	ANTENNA HEIGHT (m)	TABLE ANGLE (Degree)	RAW VALUE (dBuV)	CORRECTION FACTOR (dB/m)
1	*2462.00	117.2 PK			3.28 H	226	121.3	-4.1
2	*2462.00	106.0 AV			3.28 H	226	110.1	-4.1
3	2483.50	65.8 PK	74.0	-8.2	3.28 H	226	69.8	-4.0
4	2483.50	51.5 AV	54.0	-2.5	3.28 H	226	55.5	-4.0
5	4924.00	46.0 PK	74.0	-28.0	1.09 H	123	43.5	2.5
6	4924.00	34.9 AV	54.0	-19.1	1.09 H	123	32.4	2.5
7	7386.00	49.7 PK	74.0	-24.3	2.02 H	220	40.4	9.3
8	7386.00	37.9 AV	54.0	-16.1	2.02 H	220	28.6	9.3

ANTENNA POLARITY & TEST DISTANCE: VERTICAL AT 3 M

NO.	FREQ. (MHz)	EMISSION LEVEL (dBuV/m)	LIMIT (dBuV/m)	MARGIN (dB)	ANTENNA HEIGHT (m)	TABLE ANGLE (Degree)	RAW VALUE (dBuV)	CORRECTION FACTOR (dB/m)
1	*2462.00	115.0 PK			3.86 V	216	119.1	-4.1
2	*2462.00	104.1 AV			3.86 V	216	108.2	-4.1
3	2483.50	63.7 PK	74.0	-10.3	3.86 V	216	67.7	-4.0
4	2483.50	49.7 AV	54.0	-4.3	3.86 V	216	53.7	-4.0
5	4924.00	45.8 PK	74.0	-28.2	1.09 V	151	43.3	2.5
6	4924.00	34.3 AV	54.0	-19.7	1.09 V	151	31.8	2.5
7	7386.00	47.4 PK	74.0	-26.6	1.52 V	199	38.1	9.3
8	7386.00	35.9 AV	54.0	-18.1	1.52 V	199	26.6	9.3

REMARKS:

1. Emission Level(dBuV/m) = Raw Value(dBuV) + Correction Factor(dB/m)
2. Correction Factor(dB/m) = Antenna Factor(dB/m) + Cable Factor(dB) – Pre-Amplifier Factor(dB)
3. The other emission levels were very low against the limit.
4. Margin value = Emission Level – Limit value
5. " * ": Fundamental frequency.

802.11n (HT40)

CHANNEL	TX Channel 3	DETECTOR FUNCTION	Peak (PK)
FREQUENCY RANGE	1GHz ~ 25GHz		Average (AV)

ANTENNA POLARITY & TEST DISTANCE: HORIZONTAL AT 3 M

NO.	FREQ. (MHz)	EMISSION LEVEL (dBuV/m)	LIMIT (dBuV/m)	MARGIN (dB)	ANTENNA HEIGHT (m)	TABLE ANGLE (Degree)	RAW VALUE (dBuV)	CORRECTION FACTOR (dB/m)
1	2390.00	65.2 PK	74.0	-8.8	2.97 H	252	69.4	-4.2
2	2390.00	53.3 AV	54.0	-0.7	2.97 H	252	57.5	-4.2
3	*2422.00	110.6 PK			2.97 H	252	114.7	-4.1
4	*2422.00	99.4 AV			2.97 H	252	103.5	-4.1
5	4844.00	46.3 PK	74.0	-27.7	1.05 H	118	44.0	2.3
6	4844.00	35.3 AV	54.0	-18.7	1.05 H	118	33.0	2.3
7	7266.00	49.4 PK	74.0	-24.6	1.97 H	211	40.6	8.8
8	7266.00	37.9 AV	54.0	-16.1	1.97 H	211	29.1	8.8

ANTENNA POLARITY & TEST DISTANCE: VERTICAL AT 3 M

NO.	FREQ. (MHz)	EMISSION LEVEL (dBuV/m)	LIMIT (dBuV/m)	MARGIN (dB)	ANTENNA HEIGHT (m)	TABLE ANGLE (Degree)	RAW VALUE (dBuV)	CORRECTION FACTOR (dB/m)
1	2390.00	63.7 PK	74.0	-10.3	3.79 V	224	67.9	-4.2
2	2390.00	52.1 AV	54.0	-1.9	3.79 V	224	56.3	-4.2
3	*2422.00	109.3 PK			3.79 V	224	113.4	-4.1
4	*2422.00	98.0 AV			3.79 V	224	102.1	-4.1
5	4844.00	46.0 PK	74.0	-28.0	1.04 V	151	43.7	2.3
6	4844.00	34.7 AV	54.0	-19.3	1.04 V	151	32.4	2.3
7	7266.00	46.9 PK	74.0	-27.1	1.49 V	191	38.1	8.8
8	7266.00	35.4 AV	54.0	-18.6	1.49 V	191	26.6	8.8

REMARKS:

- Emission Level(dBuV/m) = Raw Value(dBuV) + Correction Factor(dB/m)
- Correction Factor(dB/m) = Antenna Factor(dB/m) + Cable Factor(dB) – Pre-Amplifier Factor(dB)
- The other emission levels were very low against the limit.
- Margin value = Emission Level – Limit value
- " * ": Fundamental frequency.

CHANNEL	TX Channel 6	DETECTOR FUNCTION	Peak (PK)
FREQUENCY RANGE	1GHz ~ 25GHz		Average (AV)

ANTENNA POLARITY & TEST DISTANCE: HORIZONTAL AT 3 M

NO.	FREQ. (MHz)	EMISSION LEVEL (dBuV/m)	LIMIT (dBuV/m)	MARGIN (dB)	ANTENNA HEIGHT (m)	TABLE ANGLE (Degree)	RAW VALUE (dBuV)	CORRECTION FACTOR (dB/m)
1	2390.00	65.3 PK	74.0	-8.7	3.29 H	228	69.5	-4.2
2	2390.00	53.1 AV	54.0	-0.9	3.29 H	228	57.3	-4.2
3	*2437.00	113.2 PK			3.29 H	228	117.2	-4.0
4	*2437.00	101.4 AV			3.29 H	228	105.4	-4.0
5	2483.50	62.0 PK	74.0	-12.0	3.29 H	228	66.0	-4.0
6	2483.50	48.1 AV	54.0	-5.9	3.29 H	228	52.1	-4.0
7	4874.00	46.3 PK	74.0	-27.7	1.08 H	116	43.8	2.5
8	4874.00	35.1 AV	54.0	-18.9	1.08 H	116	32.6	2.5
9	7311.00	49.4 PK	74.0	-24.6	2.07 H	223	40.5	8.9
10	7311.00	37.5 AV	54.0	-16.5	2.07 H	223	28.6	8.9

ANTENNA POLARITY & TEST DISTANCE: VERTICAL AT 3 M

NO.	FREQ. (MHz)	EMISSION LEVEL (dBuV/m)	LIMIT (dBuV/m)	MARGIN (dB)	ANTENNA HEIGHT (m)	TABLE ANGLE (Degree)	RAW VALUE (dBuV)	CORRECTION FACTOR (dB/m)
1	2390.00	64.2 PK	74.0	-9.8	3.81 V	201	68.4	-4.2
2	2390.00	51.9 AV	54.0	-2.1	3.81 V	201	56.1	-4.2
3	*2437.00	111.8 PK			3.81 V	201	115.8	-4.0
4	*2437.00	100.0 AV			3.81 V	201	104.0	-4.0
5	2483.50	60.5 PK	74.0	-13.5	3.81 V	201	64.5	-4.0
6	2483.50	46.8 AV	54.0	-7.2	3.81 V	201	50.8	-4.0
7	4874.00	46.4 PK	74.0	-27.6	1.12 V	163	43.9	2.5
8	4874.00	34.7 AV	54.0	-19.3	1.12 V	163	32.2	2.5
9	7311.00	47.1 PK	74.0	-26.9	1.51 V	208	38.2	8.9
10	7311.00	35.9 AV	54.0	-18.1	1.51 V	208	27.0	8.9

REMARKS:

1. Emission Level(dBuV/m) = Raw Value(dBuV) + Correction Factor(dB/m)
2. Correction Factor(dB/m) = Antenna Factor(dB/m) + Cable Factor(dB) – Pre-Amplifier Factor(dB)
3. The other emission levels were very low against the limit.
4. Margin value = Emission Level – Limit value
5. " * ": Fundamental frequency.

CHANNEL	TX Channel 9	DETECTOR FUNCTION	Peak (PK)
FREQUENCY RANGE	1GHz ~ 25GHz		Average (AV)

ANTENNA POLARITY & TEST DISTANCE: HORIZONTAL AT 3 M

NO.	FREQ. (MHz)	EMISSION LEVEL (dBuV/m)	LIMIT (dBuV/m)	MARGIN (dB)	ANTENNA HEIGHT (m)	TABLE ANGLE (Degree)	RAW VALUE (dBuV)	CORRECTION FACTOR (dB/m)
1	*2452.00	113.4 PK			2.91 H	227	117.5	-4.1
2	*2452.00	102.0 AV			2.91 H	227	106.1	-4.1
3	2483.50	70.1 PK	74.0	-3.9	2.91 H	227	74.1	-4.0
4	2483.50	53.5 AV	54.0	-0.5	2.91 H	227	57.5	-4.0
5	4904.00	45.9 PK	74.0	-28.1	1.10 H	108	43.4	2.5
6	4904.00	34.7 AV	54.0	-19.3	1.10 H	108	32.2	2.5
7	7356.00	50.0 PK	74.0	-24.0	2.00 H	219	40.8	9.2
8	7356.00	38.3 AV	54.0	-15.7	2.00 H	219	29.1	9.2

ANTENNA POLARITY & TEST DISTANCE: VERTICAL AT 3 M

NO.	FREQ. (MHz)	EMISSION LEVEL (dBuV/m)	LIMIT (dBuV/m)	MARGIN (dB)	ANTENNA HEIGHT (m)	TABLE ANGLE (Degree)	RAW VALUE (dBuV)	CORRECTION FACTOR (dB/m)
1	*2452.00	109.7 PK			3.06 V	203	113.8	-4.1
2	*2452.00	98.8 AV			3.06 V	203	102.9	-4.1
3	2483.50	67.8 PK	74.0	-6.2	3.06 V	203	71.8	-4.0
4	2483.50	51.6 AV	54.0	-2.4	3.06 V	203	55.6	-4.0
5	4904.00	45.7 PK	74.0	-28.3	1.09 V	159	43.2	2.5
6	4904.00	34.2 AV	54.0	-19.8	1.09 V	159	31.7	2.5
7	7356.00	47.2 PK	74.0	-26.8	1.54 V	190	38.0	9.2
8	7356.00	35.7 AV	54.0	-18.3	1.54 V	190	26.5	9.2

REMARKS:

1. Emission Level(dBuV/m) = Raw Value(dBuV) + Correction Factor(dB/m)
2. Correction Factor(dB/m) = Antenna Factor(dB/m) + Cable Factor(dB) – Pre-Amplifier Factor(dB)
3. The other emission levels were very low against the limit.
4. Margin value = Emission Level – Limit value
5. " * ": Fundamental frequency.

Below 1GHz Data:

802.11g

CHANNEL	TX Channel 6	DETECTOR FUNCTION	Quasi-Peak (QP)
FREQUENCY RANGE	Below 1GHz		

ANTENNA POLARITY & TEST DISTANCE: HORIZONTAL AT 3 M								
NO.	FREQ. (MHz)	EMISSION LEVEL (dBuV/m)	LIMIT (dBuV/m)	MARGIN (dB)	ANTENNA HEIGHT (m)	TABLE ANGLE (Degree)	RAW VALUE (dBuV)	CORRECTION FACTOR (dB/m)
1	125.01	34.0 QP	43.5	-9.5	2.50 H	105	44.5	-10.5
2	153.75	40.0 QP	43.5	-3.5	2.00 H	90	48.3	-8.3
3	216.82	36.7 QP	46.0	-9.3	1.50 H	161	48.0	-11.3
4	375.03	40.2 QP	46.0	-5.8	1.00 H	144	45.7	-5.5
5	499.99	36.9 QP	46.0	-9.1	2.00 H	177	39.2	-2.3
6	625.02	36.2 QP	46.0	-9.8	1.50 H	80	35.8	0.4

ANTENNA POLARITY & TEST DISTANCE: VERTICAL AT 3 M								
NO.	FREQ. (MHz)	EMISSION LEVEL (dBuV/m)	LIMIT (dBuV/m)	MARGIN (dB)	ANTENNA HEIGHT (m)	TABLE ANGLE (Degree)	RAW VALUE (dBuV)	CORRECTION FACTOR (dB/m)
1	52.99	36.9 QP	40.0	-3.1	1.00 V	342	45.2	-8.3
2	73.55	36.6 QP	40.0	-3.4	1.00 V	21	47.7	-11.1
3	92.81	37.3 QP	43.5	-6.2	1.00 V	258	51.2	-13.9
4	154.38	33.8 QP	43.5	-9.7	1.00 V	223	42.1	-8.3
5	374.98	34.8 QP	46.0	-11.2	1.00 V	360	40.3	-5.5
6	625.00	34.5 QP	46.0	-11.5	1.50 V	44	34.1	0.4

REMARKS:

1. Emission Level(dBuV/m) = Raw Value(dBuV) + Correction Factor(dB/m)
2. Correction Factor(dB/m) = Antenna Factor(dB/m) + Cable Factor(dB) – Pre-Amplifier Factor(dB)
3. The other emission levels were very low against the limit.
4. Margin value = Emission Level – Limit value

4.1.8 Test Results (Mode 2)

Below 1GHz Data:

802.11g

CHANNEL	TX Channel 6	DETECTOR FUNCTION	Quasi-Peak (QP)
FREQUENCY RANGE	Below 1GHz		

ANTENNA POLARITY & TEST DISTANCE: HORIZONTAL AT 3 M

NO.	FREQ. (MHz)	EMISSION LEVEL (dBuV/m)	LIMIT (dBuV/m)	MARGIN (dB)	ANTENNA HEIGHT (m)	TABLE ANGLE (Degree)	RAW VALUE (dBuV)	CORRECTION FACTOR (dB/m)
1	66.42	31.8 QP	40.0	-8.2	1.00 H	360	41.6	-9.8
2	93.37	30.8 QP	43.5	-12.7	2.00 H	295	44.7	-13.9
3	209.23	33.9 QP	43.5	-9.6	1.00 H	291	45.3	-11.4
4	236.15	36.4 QP	46.0	-9.6	1.50 H	282	46.6	-10.2
5	330.48	36.4 QP	46.0	-9.6	1.00 H	40	42.9	-6.5
6	370.03	33.6 QP	46.0	-12.4	1.00 H	324	39.2	-5.6

ANTENNA POLARITY & TEST DISTANCE: VERTICAL AT 3 M

NO.	FREQ. (MHz)	EMISSION LEVEL (dBuV/m)	LIMIT (dBuV/m)	MARGIN (dB)	ANTENNA HEIGHT (m)	TABLE ANGLE (Degree)	RAW VALUE (dBuV)	CORRECTION FACTOR (dB/m)
1	40.48	38.6 QP	40.0	-1.4	2.00 V	0	47.6	-9.0
2	66.40	35.9 QP	40.0	-4.1	1.00 V	259	45.7	-9.8
3	125.01	33.7 QP	43.5	-9.8	1.50 V	194	44.2	-10.5
4	146.35	32.5 QP	43.5	-11.0	1.00 V	69	41.1	-8.6
5	478.24	30.8 QP	46.0	-15.2	1.00 V	5	33.6	-2.8
6	644.33	30.5 QP	46.0	-15.5	1.50 V	360	29.8	0.7

REMARKS:

1. Emission Level(dBuV/m) = Raw Value(dBuV) + Correction Factor(dB/m)
2. Correction Factor(dB/m) = Antenna Factor(dB/m) + Cable Factor(dB) – Pre-Amplifier Factor(dB)
3. The other emission levels were very low against the limit.
4. Margin value = Emission Level – Limit value

4.2 Conducted Emission Measurement

4.2.1 Limits of Conducted Emission Measurement

Frequency (MHz)	Conducted Limit (dBuV)	
	Quasi-peak	Average
0.15 - 0.5	66 - 56	56 - 46
0.50 - 5.0	56	46
5.0 - 30.0	60	50

Note: 1. The lower limit shall apply at the transition frequencies.

2. The limit decreases in line with the logarithm of the frequency in the range of 0.15 to 0.50MHz.

4.2.2 Test Instruments

DESCRIPTION & MANUFACTURER	MODEL NO.	SERIAL NO.	CALIBRATED DATE	CALIBRATED UNTIL
Test Receiver R&S	ESCS 30	847124/029	Oct. 23, 2015	Oct. 22, 2016
Line-Impedance Stabilization Network (for EUT) R&S	ESH3-Z5	848773/004	Oct. 28, 2015	Oct. 27, 2016
RF Cable	5D-FB	COACAB-002	Mar. 04, 2016	Mar. 03, 2017
10 dB PAD Mini-Circuits	HAT-10+	CONATT-004	Jun. 20, 2016	Jun. 19, 2017
Software BVADT	BVADT_Cond_ V7.3.7.3	NA	NA	NA

Note:

1. The calibration interval of the above test instruments are 12 months and the calibrations are traceable to NML/ROC and NIST/USA.
2. The test was performed in Shielded Room No. 1.
- 3 Tested Date: June 21 to Aug. 16, 2016

4.2.3 Test Procedures

- The EUT was placed 0.4 meters from the conducting wall of the shielded room with EUT being connected to the power mains through a line impedance stabilization network (LISN). Other support units were connected to the power mains through another LISN. The two LISNs provide 50 ohm/ 50uH of coupling impedance for the measuring instrument.
- Both lines of the power mains connected to the EUT were checked for maximum conducted interference.
- The frequency range from 150kHz to 30MHz was searched. Emission levels under (Limit - 20dB) was not recorded.

NOTE: The resolution bandwidth and video bandwidth of test receiver is 9kHz for quasi-peak detection (QP) and average detection (AV) at frequency 0.15MHz-30MHz.

4.2.4 Deviation from Test Standard

No deviation.

4.2.5 Test Setup

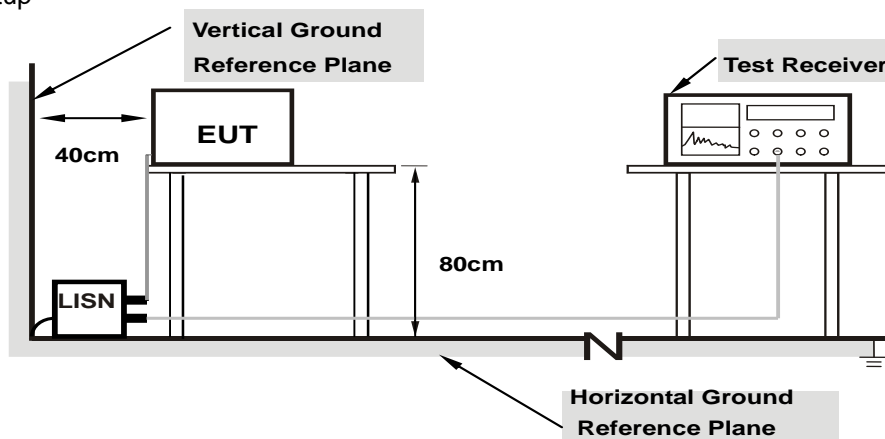

Note: 1.Support units were connected to second LISN.

For the actual test configuration, please refer to the attached file (Test Setup Photo).

4.2.6 EUT Operating Conditions

Same as 4.1.6.

4.2.7 Test Results (Mode 1)

Phase	Line (L)	Detector Function	Quasi-Peak (QP) / Average (AV)
-------	----------	-------------------	--------------------------------

Phase Of Power : Line (L)										
No	Frequency (MHz)	Correction Factor (dB)	Reading Value (dBuV)		Emission Level (dBuV)		Limit (dBuV)		Margin (dB)	
			Q.P.	AV.	Q.P.	AV.	Q.P.	AV.	Q.P.	AV.
1	0.15000	10.21	37.83	27.15	48.04	37.36	66.00	56.00	-17.96	-18.64
2	0.22844	10.22	31.97	22.35	42.19	32.57	62.51	52.51	-20.32	-19.94
3	0.94688	10.26	15.89	9.14	26.15	19.40	56.00	46.00	-29.85	-26.60
4	7.04297	10.46	19.57	14.08	30.03	24.54	60.00	50.00	-29.97	-25.46
5	19.66797	11.33	26.56	22.84	37.89	34.17	60.00	50.00	-22.11	-15.83
6	24.00000	11.43	36.53	35.52	47.96	46.95	60.00	50.00	-12.04	-3.05

Remarks:

1. Q.P. and AV. are abbreviations of quasi-peak and average individually.
2. The emission levels of other frequencies were very low against the limit.
3. Margin value = Emission level – Limit value
4. Correction factor = Insertion loss + Cable loss
5. Emission Level = Correction Factor + Reading Value

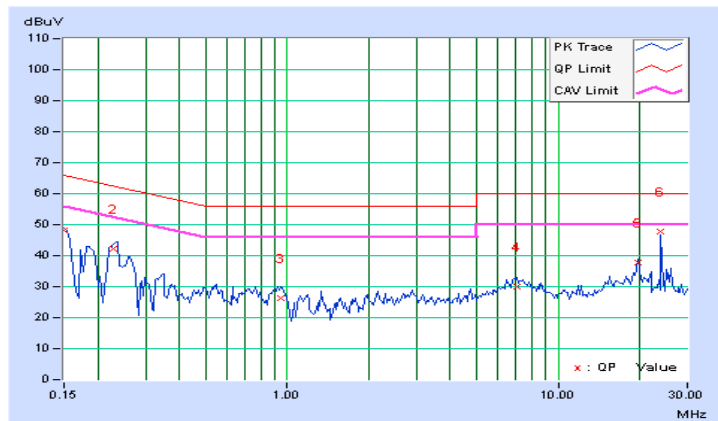

Phase	Neutral (N)	Detector Function	Quasi-Peak (QP) / Average (AV)
-------	-------------	-------------------	--------------------------------

Phase Of Power : Neutral (N)										
No	Frequency (MHz)	Correction Factor (dB)	Reading Value (dBuV)		Emission Level (dBuV)		Limit (dBuV)		Margin (dB)	
			Q.P.	AV.	Q.P.	AV.	Q.P.	AV.	Q.P.	AV.
1	0.15000	10.19	38.12	26.04	48.31	36.23	66.00	56.00	-17.69	-19.77
2	0.22731	10.21	32.05	22.53	42.26	32.74	62.55	52.55	-20.29	-19.81
3	0.34478	10.20	21.10	8.42	31.30	18.62	59.09	49.09	-27.78	-30.46
4	0.94978	10.24	14.28	7.00	24.52	17.24	56.00	46.00	-31.48	-28.76
5	6.75391	10.36	16.84	10.96	27.20	21.32	60.00	50.00	-32.80	-28.68
6	24.00000	11.13	34.34	33.86	45.47	44.99	60.00	50.00	-14.53	-5.01

Remarks:

1. Q.P. and AV. are abbreviations of quasi-peak and average individually.
2. The emission levels of other frequencies were very low against the limit.
3. Margin value = Emission level – Limit value
4. Correction factor = Insertion loss + Cable loss
5. Emission Level = Correction Factor + Reading Value

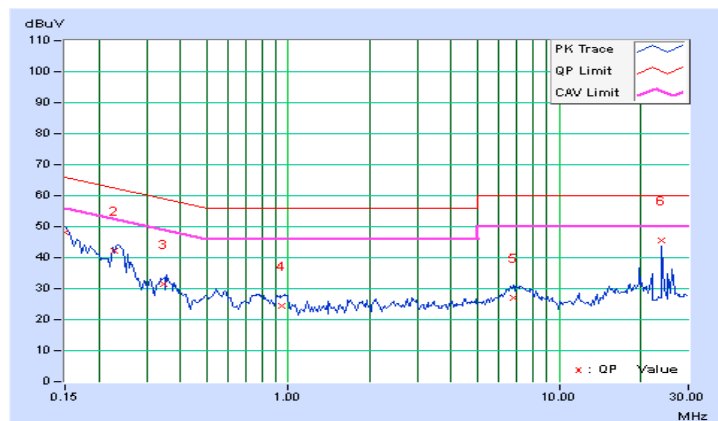

4.2.8 Test Results (Mode 2)

Phase	Line (L)	Detector Function	Quasi-Peak (QP) / Average (AV)
-------	----------	-------------------	--------------------------------

Phase Of Power : Line (L)										
No	Frequency (MHz)	Correction Factor (dB)	Reading Value (dBuV)		Emission Level (dBuV)		Limit (dBuV)		Margin (dB)	
			Q.P.	AV.	Q.P.	AV.	Q.P.	AV.	Q.P.	AV.
1	0.15391	10.21	41.21	27.66	51.42	37.87	65.79	55.79	-14.37	-17.92
2	0.22422	10.22	32.55	18.91	42.77	29.13	62.66	52.66	-19.89	-23.53
3	0.59531	10.23	19.84	13.66	30.07	23.89	56.00	46.00	-25.93	-22.11
4	2.20313	10.31	11.85	10.07	22.16	20.38	56.00	46.00	-33.84	-25.62
5	15.51172	11.09	20.62	15.94	31.71	27.03	60.00	50.00	-28.29	-22.97
6	25.23047	11.45	24.64	22.27	36.09	33.72	60.00	50.00	-23.91	-16.28

Remarks:

1. Q.P. and AV. are abbreviations of quasi-peak and average individually.
2. The emission levels of other frequencies were very low against the limit.
3. Margin value = Emission level – Limit value
4. Correction factor = Insertion loss + Cable loss
5. Emission Level = Correction Factor + Reading Value

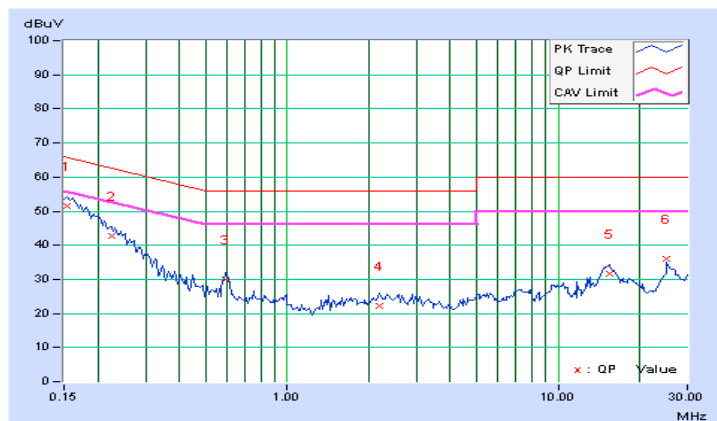

Phase	Neutral (N)	Detector Function	Quasi-Peak (QP) / Average (AV)
-------	-------------	-------------------	--------------------------------

Phase Of Power : Neutral (N)										
No	Frequency (MHz)	Correction Factor (dB)	Reading Value (dBuV)		Emission Level (dBuV)		Limit (dBuV)		Margin (dB)	
			Q.P.	AV.	Q.P.	AV.	Q.P.	AV.	Q.P.	AV.
1	0.15000	10.19	40.30	27.32	50.49	37.51	66.00	56.00	-15.51	-18.49
2	0.19297	10.21	36.27	22.15	46.48	32.36	63.91	53.91	-17.43	-21.55
3	0.28281	10.21	26.44	14.27	36.65	24.48	60.73	50.73	-24.09	-26.26
4	0.59141	10.21	20.10	14.93	30.31	25.14	56.00	46.00	-25.69	-20.86
5	15.40234	10.91	20.92	17.26	31.83	28.17	60.00	50.00	-28.17	-21.83
6	25.23047	11.13	24.50	21.97	35.63	33.10	60.00	50.00	-24.37	-16.90

Remarks:

1. Q.P. and AV. are abbreviations of quasi-peak and average individually.
2. The emission levels of other frequencies were very low against the limit.
3. Margin value = Emission level – Limit value
4. Correction factor = Insertion loss + Cable loss
5. Emission Level = Correction Factor + Reading Value

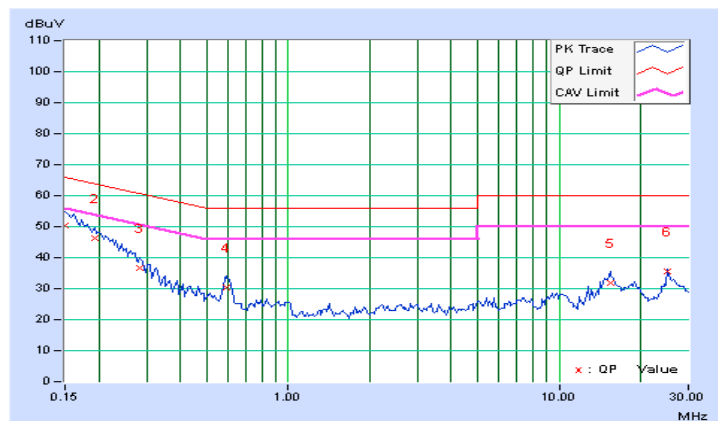

4.3 6dB Bandwidth Measurement

4.3.1 Limits of 6dB Bandwidth Measurement

The minimum of 6dB Bandwidth Measurement is 0.5 MHz.

4.3.2 Test Setup

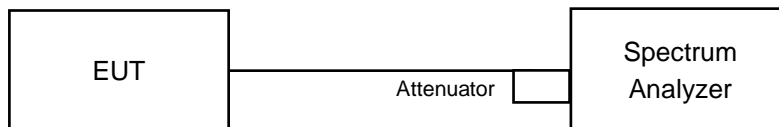

4.3.3 Test Instruments

Refer to section 4.1.2 to get information of above instrument.

4.3.4 Test Procedure

- a. Set resolution bandwidth (RBW) = 100kHz
- b. Set the video bandwidth (VBW) $\geq 3 \times$ RBW, Detector = Peak.
- c. Trace mode = max hold.
- d. Sweep = auto couple.
- e. Measure the maximum width of the emission that is constrained by the frequencies associated with the two amplitude points (upper and lower) that are attenuated by 6 dB relative to the maximum level measured in the fundamental emission

4.3.5 Deviation from Test Standard

No deviation.

4.3.6 EUT Operating Conditions

The software provided by client to enable the EUT under transmission condition continuously at lowest, middle and highest channel frequencies individually.

4.3.7 Test Result

802.11b

Channel	Frequency (MHz)	6dB Bandwidth (MHz)				Minimum Limit (MHz)	Pass / Fail
		Chain 0	Chain 1	Chain 2	Chain 3		
1	2412	8.13	9.10	8.13	8.11	0.5	Pass
6	2437	8.10	8.13	8.12	7.62	0.5	Pass
11	2462	7.62	7.64	7.64	8.13	0.5	Pass

802.11g

Channel	Frequency (MHz)	6dB Bandwidth (MHz)				Minimum Limit (MHz)	Pass / Fail
		Chain 0	Chain 1	Chain 2	Chain 3		
1	2412	15.99	16.26	15.95	15.99	0.5	Pass
6	2437	16.35	16.33	16.34	16.33	0.5	Pass
11	2462	16.11	15.92	15.94	16.10	0.5	Pass

802.11n (HT20)

Channel	Frequency (MHz)	6dB Bandwidth (MHz)				Minimum Limit (MHz)	Pass / Fail
		Chain 0	Chain 1	Chain 2	Chain 3		
1	2412	17.19	16.00	16.94	16.02	0.5	Pass
6	2437	17.26	16.94	17.20	16.91	0.5	Pass
11	2462	16.98	16.56	16.57	17.22	0.5	Pass

802.11n (HT40)

Channel	Frequency (MHz)	6dB Bandwidth (MHz)				Minimum Limit (MHz)	Pass / Fail
		Chain 0	Chain 1	Chain 2	Chain 3		
3	2422	35.09	35.10	32.64	33.98	0.5	Pass
6	2437	35.19	35.34	35.34	35.14	0.5	Pass
9	2452	35.15	35.17	35.19	34.07	0.5	Pass

Spectrum Plot of Worst Value

802.11b / Chain 0 : CH11

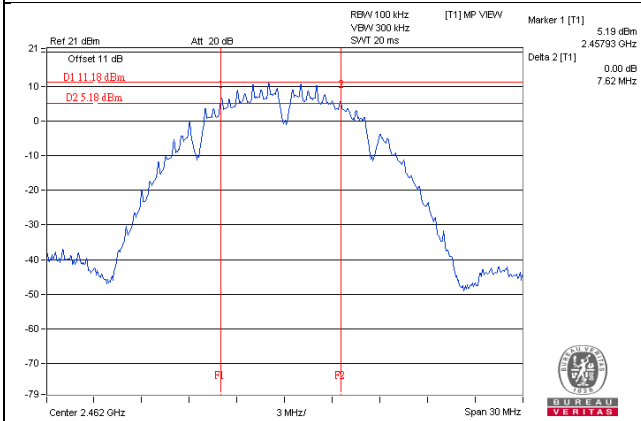

802.11g / Chain 1 : CH11

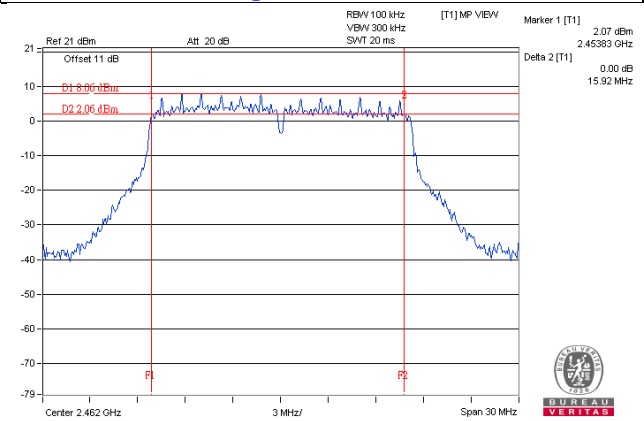

802.11n (HT20) / Chain 1 : CH1

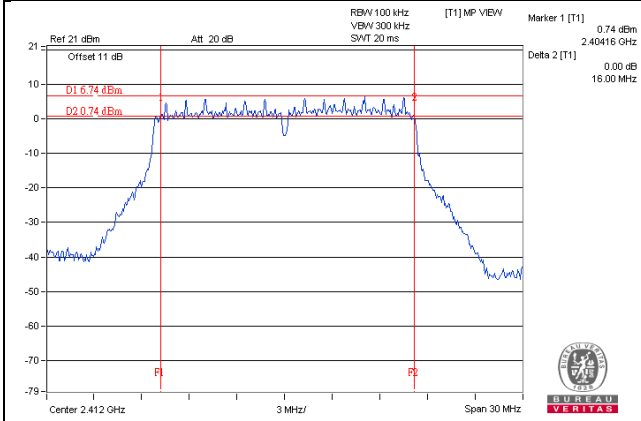

802.11n (HT40) / Chain 2 : CH3

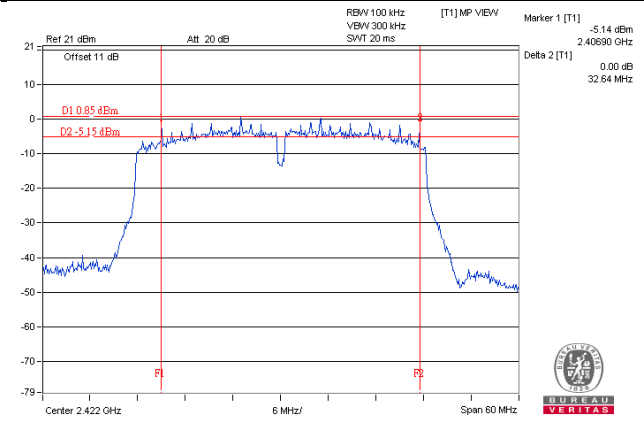

4.4 Conducted Output Power Measurement

4.4.1 Limits of Conducted Output Power Measurement

For systems using digital modulation in the 2400–2483.5 MHz bands: 1 Watt (30dBm)

Per KDB 662911 D01 Multiple Transmitter Output Method of conducted output power measurement on IEEE 802.11 devices,

Array Gain = 0 dB (i.e., no array gain) for $N_{ANT} \leq 4$;

Array Gain = 0 dB (i.e., no array gain) for channel widths ≥ 40 MHz for any N_{ANT} ;

Array Gain = $5 \log(N_{ANT}/N_{SS})$ dB or 3 dB, whichever is less for 20-MHz channel widths with $N_{ANT} \geq 5$.

For power measurements on all other devices: Array Gain = $10 \log(N_{ANT}/N_{SS})$ dB.

4.4.2 Test Setup

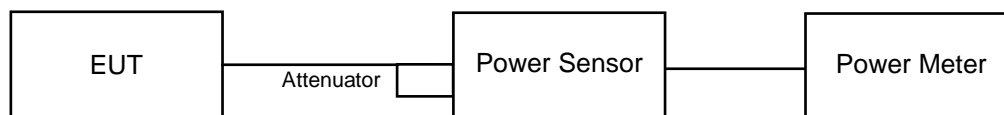

4.4.3 Test Instruments

Refer to section 4.1.2 to get information of above instrument.

4.4.4 Test Procedures

An average power sensor was used on the output port of the EUT. A power meter was used to read the response of the average power sensor. Record the power level.

4.4.5 Deviation from Test Standard

No deviation.

4.4.6 EUT Operating Conditions

Same as Item 4.3.6.

4.4.7 Test Results

CDD Mode

802.11b

Chan.	Frequency (MHz)	Avg. Power (dBm)				Total Power (mW)	Total Power (dBm)	Limit (dBm)	Pass/Fail
		Chain 0	Chain 1	Chain 2	Chain 3				
1	2412	19.93	19.44	19.27	19.36	357.129	25.53	30	Pass
6	2437	23.40	23.46	23.32	23.32	870.162	29.40	30	Pass
11	2462	19.70	19.80	18.75	19.88	361.088	25.58	30	Pass

802.11g

Chan.	Frequency (MHz)	Avg. Power (dBm)				Total Power (mW)	Total Power (dBm)	Limit (dBm)	Pass/Fail
		Chain 0	Chain 1	Chain 2	Chain 3				
1	2412	17.83	17.81	17.55	17.64	236.03	23.73	30	Pass
6	2437	23.42	23.58	23.46	23.32	884.423	29.47	30	Pass
11	2462	18.12	18.45	18.07	18.06	262.941	24.20	30	Pass

802.11n (HT20)

Chan.	Frequency (MHz)	Avg. Power (dBm)				Total Power (mW)	Total Power (dBm)	Limit (dBm)	Pass/Fail
		Chain 0	Chain 1	Chain 2	Chain 3				
1	2412	17.18	17.29	16.85	16.87	202.878	23.07	30	Pass
6	2437	23.45	23.46	23.52	23.24	878.897	29.44	30	Pass
11	2462	18.16	18.52	18.17	18.12	267.063	24.27	30	Pass

802.11n (HT40)

Chan.	Frequency (MHz)	Avg. Power (dBm)				Total Power (mW)	Total Power (dBm)	Limit (dBm)	Pass/Fail
		Chain 0	Chain 1	Chain 2	Chain 3				
3	2422	14.33	14.10	13.98	13.94	102.583	20.11	30	Pass
6	2437	16.96	16.67	16.73	16.56	188.499	22.75	30	Pass
9	2452	16.44	16.37	16.44	16.38	174.912	22.43	30	Pass

Beamforming Mode

802.11n (HT20)

Chan.	Frequency (MHz)	Avg. Power (dBm)				Total Power (mW)	Total Power (dBm)	Limit (dBm)	Pass/Fail
		Chain 0	Chain 1	Chain 2	Chain 3				
1	2412	17.18	17.29	16.85	16.87	202.878	23.07	26.67	Pass
6	2437	20.10	20.24	20.34	20.17	420.146	26.23	26.67	Pass
11	2462	18.16	18.52	18.17	18.12	267.063	24.27	26.67	Pass

Note: Directional gain = $10 \log[(10^{G1/20} + 10^{G2/20} + 10^{G3/20} + 10^{G4/20})^2 / 4] = 9.33\text{dBi} > 6\text{dBi}$, so the power limit shall be reduced to $30 - (9.33 - 6) = 26.67\text{dBm}$.

802.11n (HT40)

Chan.	Frequency (MHz)	Avg. Power (dBm)				Total Power (mW)	Total Power (dBm)	Limit (dBm)	Pass/Fail
		Chain 0	Chain 1	Chain 2	Chain 3				
3	2422	14.33	14.10	13.98	13.94	102.583	20.11	26.67	Pass
6	2437	16.96	16.67	16.73	16.56	188.499	22.75	26.67	Pass
9	2452	16.44	16.37	16.44	16.38	174.912	22.43	26.67	Pass

Note: Directional gain = $10 \log[(10^{G1/20} + 10^{G2/20} + 10^{G3/20} + 10^{G4/20})^2 / 4] = 9.33\text{dBi} > 6\text{dBi}$, so the power limit shall be reduced to $30 - (9.33 - 6) = 26.67\text{dBm}$.

4.5 Power Spectral Density Measurement

4.5.1 Limits of Power Spectral Density Measurement

The Maximum of Power Spectral Density Measurement is 8dBm.

4.5.2 Test Setup



4.5.3 Test Instruments

Refer to section 4.1.2 to get information of above instrument.

4.5.4 Test Procedure

For 802.11b, 802.11b, 802.11n (HT20)

- Set instrument center frequency to DTS channel center frequency.
- Set span to at least 1.5 times the OBW.
- Set RBW to: $3 \text{ kHz} \leq \text{RBW} \leq 100 \text{ kHz}$.
- Set VBW $\geq 3 \times \text{RBW}$.
- Detector = power averaging (RMS) or sample detector (when RMS not available).
- Ensure that the number of measurement points in the sweep $\geq 2 \times \text{span}/\text{RBW}$.
- Sweep time = auto couple.
- Employ trace averaging (RMS) mode over a minimum of 100 traces.
- Use the peak marker function to determine the maximum amplitude level.

For 802.11n (HT40)

- Measure the duty cycle (x).
- Set instrument center frequency to DTS channel center frequency.
- Set span to at least 1.5 times the OBW.
- Set RBW to: $3 \text{ kHz} \leq \text{RBW} \leq 100 \text{ kHz}$.
- Set VBW $\geq 3 \times \text{RBW}$.
- Detector = power averaging (RMS) or sample detector (when RMS not available).
- Ensure that the number of measurement points in the sweep $\geq 2 \times \text{span}/\text{RBW}$.
- Sweep time = auto couple.
- Do not use sweep triggering. Allow sweep to "free run".
- Employ trace averaging (RMS) mode over a minimum of 100 traces.
- Use the peak marker function to determine the maximum amplitude level.
- Add $10 \log (1/x)$, where x is the duty cycle measured in step (a), to the measured PSD to compute the average PSD during the actual transmission time.

4.5.5 Deviation from Test Standard

No deviation.

4.5.6 EUT Operating Condition

Same as Item 4.3.6

4.5.7 Test Results

802.11b

TX chain	Channel	Freq. (MHz)	PSD (dBm/10kHz)	10 log (N=4) dB	Total PSD (dBm/10kHz)	Limit (dBm/3kHz)	Pass /Fail
0	1	2412	-8.16	6.02	-2.14	4.67	Pass
	6	2437	-3.99	6.02	2.03	4.67	Pass
	11	2462	-8.02	6.02	-2.00	4.67	Pass
1	1	2412	-7.65	6.02	-1.63	4.67	Pass
	6	2437	-4.82	6.02	1.20	4.67	Pass
	11	2462	-7.42	6.02	-1.40	4.67	Pass
2	1	2412	-7.92	6.02	-1.90	4.67	Pass
	6	2437	-4.23	6.02	1.79	4.67	Pass
	11	2462	-7.02	6.02	-1.00	4.67	Pass
3	1	2412	-7.51	6.02	-1.49	4.67	Pass
	6	2437	-4.29	6.02	1.73	4.67	Pass
	11	2462	-7.49	6.02	-1.47	4.67	Pass

NOTE: Directional gain = $10 \log[(10^{G1/20} + 10^{G2/20} + 10^{G3/20} + 10^{G4/20})^2 / 4] = 9.33\text{dBi} > 6\text{dBi}$, so the power density limit shall be reduced to $8 - (9.33 - 6) = 4.67\text{dBm}$.

802.11g

TX chain	Channel	Freq. (MHz)	PSD (dBm/10kHz)	10 log (N=4) dB	Total PSD (dBm/10kHz)	Limit (dBm/3kHz)	Pass /Fail
0	1	2412	-12.16	6.02	-6.14	4.67	Pass
	6	2437	-7.23	6.02	-1.21	4.67	Pass
	11	2462	-11.63	6.02	-5.61	4.67	Pass
1	1	2412	-11.86	6.02	-5.84	4.67	Pass
	6	2437	-6.27	6.02	-0.25	4.67	Pass
	11	2462	-10.99	6.02	-4.97	4.67	Pass
2	1	2412	-12.43	6.02	-6.41	4.67	Pass
	6	2437	-6.11	6.02	-0.09	4.67	Pass
	11	2462	-11.81	6.02	-5.79	4.67	Pass
3	1	2412	-12.11	6.02	-6.09	4.67	Pass
	6	2437	-6.60	6.02	-0.58	4.67	Pass
	11	2462	-12.00	6.02	-5.98	4.67	Pass

NOTE: Directional gain = $10 \log[(10^{G1/20} + 10^{G2/20} + 10^{G3/20} + 10^{G4/20})^2 / 4] = 9.33\text{dBi} > 6\text{dBi}$, so the power density limit shall be reduced to $8 - (9.33 - 6) = 4.67\text{dBm}$.

802.11n (HT20)

TX chain	Channel	Freq. (MHz)	PSD (dBm/10kHz)	10 log (N=4) dB	Total PSD (dBm/10kHz)	Limit (dBm/3kHz)	Pass /Fail
0	1	2412	-12.80	6.02	-6.78	4.67	Pass
	6	2437	-6.97	6.02	-0.95	4.67	Pass
	11	2462	-11.60	6.02	-5.58	4.67	Pass
1	1	2412	-12.09	6.02	-6.07	4.67	Pass
	6	2437	-6.45	6.02	-0.43	4.67	Pass
	11	2462	-10.57	6.02	-4.55	4.67	Pass
2	1	2412	-13.12	6.02	-7.10	4.67	Pass
	6	2437	-7.20	6.02	-1.18	4.67	Pass
	11	2462	-11.92	6.02	-5.90	4.67	Pass
3	1	2412	-12.68	6.02	-6.66	4.67	Pass
	6	2437	-7.06	6.02	-1.04	4.67	Pass
	11	2462	-11.94	6.02	-5.92	4.67	Pass

NOTE: Directional gain = $10 \log[(10^{G1/20} + 10^{G2/20} + 10^{G3/20} + 10^{G4/20})^2 / 4]$ = 9.33dBi > 6dBi , so the power density limit shall be reduced to $8-(9.33-6) = 4.67$ dBm.

802.11n (HT40)

TX chain	Channel	Freq. (MHz)	PSD W/O Duty Factor (dBm/10kHz)	10 log (N=4) dB	Duty Factor (dB)	TOTAL PSD With Duty Factor (dBm/10kHz)	Limit (dBm/3kHz)	Pass /Fail
0	3	2422	-17.86	6.02	0.12	-11.72	4.67	Pass
	6	2437	-16.18	6.02	0.12	-10.04	4.67	Pass
	9	2452	-16.30	6.02	0.12	-10.16	4.67	Pass
1	3	2422	-18.15	6.02	0.12	-12.01	4.67	Pass
	6	2437	-15.75	6.02	0.12	-9.61	4.67	Pass
	9	2452	-15.50	6.02	0.12	-9.36	4.67	Pass
2	3	2422	-18.01	6.02	0.12	-11.87	4.67	Pass
	6	2437	-16.08	6.02	0.12	-9.94	4.67	Pass
	9	2452	-16.29	6.02	0.12	-10.15	4.67	Pass
3	3	2422	-18.68	6.02	0.12	-12.54	4.67	Pass
	6	2437	-16.38	6.02	0.12	-10.24	4.67	Pass
	9	2452	-16.17	6.02	0.12	-10.03	4.67	Pass

Note: 1. Directional gain = $10 \log[(10^{G1/20} + 10^{G2/20} + 10^{G3/20} + 10^{G4/20})^2 / 4]$ = 9.33dBi > 6dBi , so the power density limit shall be reduced to $8-(9.33-6) = 4.67$ dBm.

2. Refer to section 3.3 for duty cycle spectrum plot.

Spectrum Plot of Worst Value

802.11b / Chain 0 : CH6

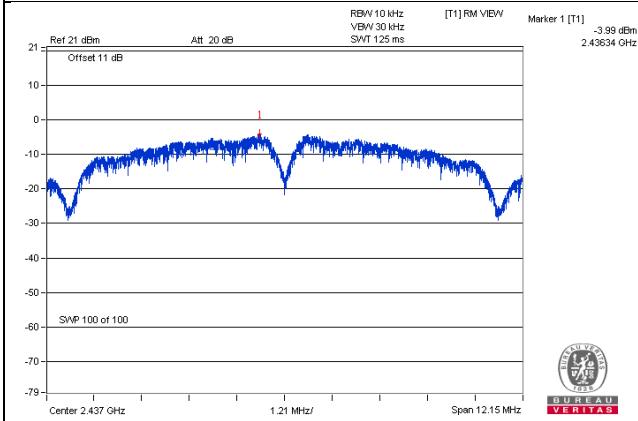

802.11g / Chain 2 : CH6

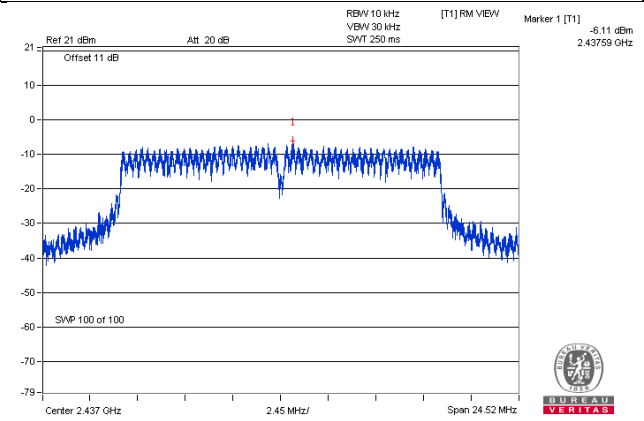

802.11n (HT20) / Chain 1 : CH6

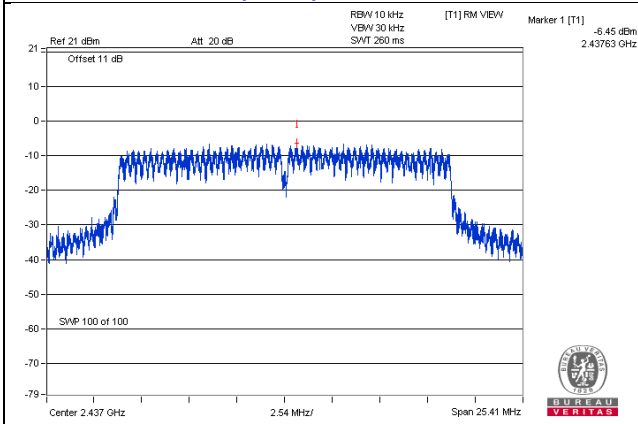

802.11n (HT40) / Chain 1 : CH9

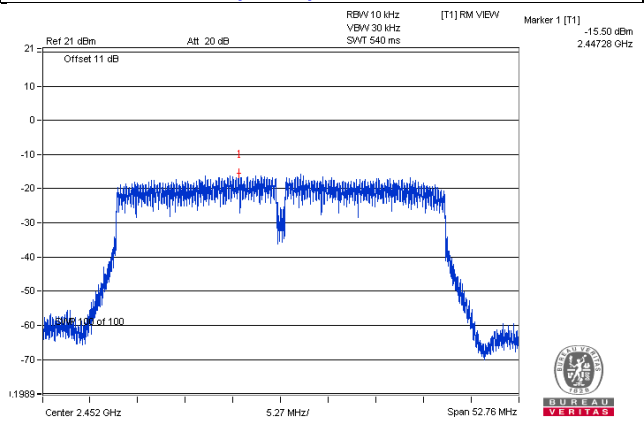

4.6 Conducted Out of Band Emission Measurement

4.6.1 Limits of Conducted Out of Band Emission Measurement

Below 30dB of the highest emission level of operating band (in 100kHz Resolution Bandwidth).

4.6.2 Test Setup

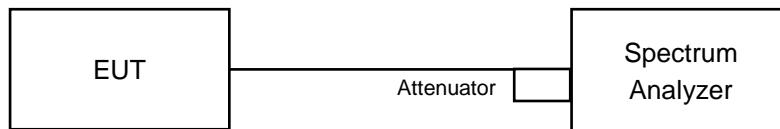

4.6.3 Test Instruments

Refer to section 4.1.2 to get information of above instrument.

4.6.4 Test Procedure

MEASUREMENT PROCEDURE REF

1. Set the RBW = 100 kHz.
2. Set the VBW \geq 300 kHz.
3. Detector = peak.
4. Sweep time = auto couple.
5. Trace mode = max hold.
6. Allow trace to fully stabilize.
7. Use the peak marker function to determine the maximum power level in any 100 kHz band segment within the fundamental EBW.

MEASUREMENT PROCEDURE OOBE

1. Set RBW = 100 kHz.
2. Set VBW \geq 300 kHz.
3. Detector = peak.
4. Sweep = auto couple.
5. Trace Mode = max hold.
6. Allow trace to fully stabilize.
7. Use the peak marker function to determine the maximum amplitude level.

4.6.5 Deviation from Test Standard

No deviation.

4.6.6 EUT Operating Condition

Same as Item 4.3.6

4.6.7 Test Results (Overall Spurious Emission Test)

The spectrum plots are attached on the following pages. D1 line indicates the highest level, and D2 line indicates the 30dB offset below D1. It shows compliance with the requirement.

802.11b

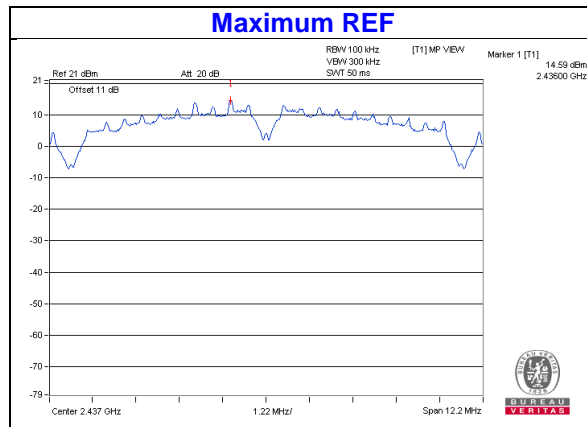

Chain 0

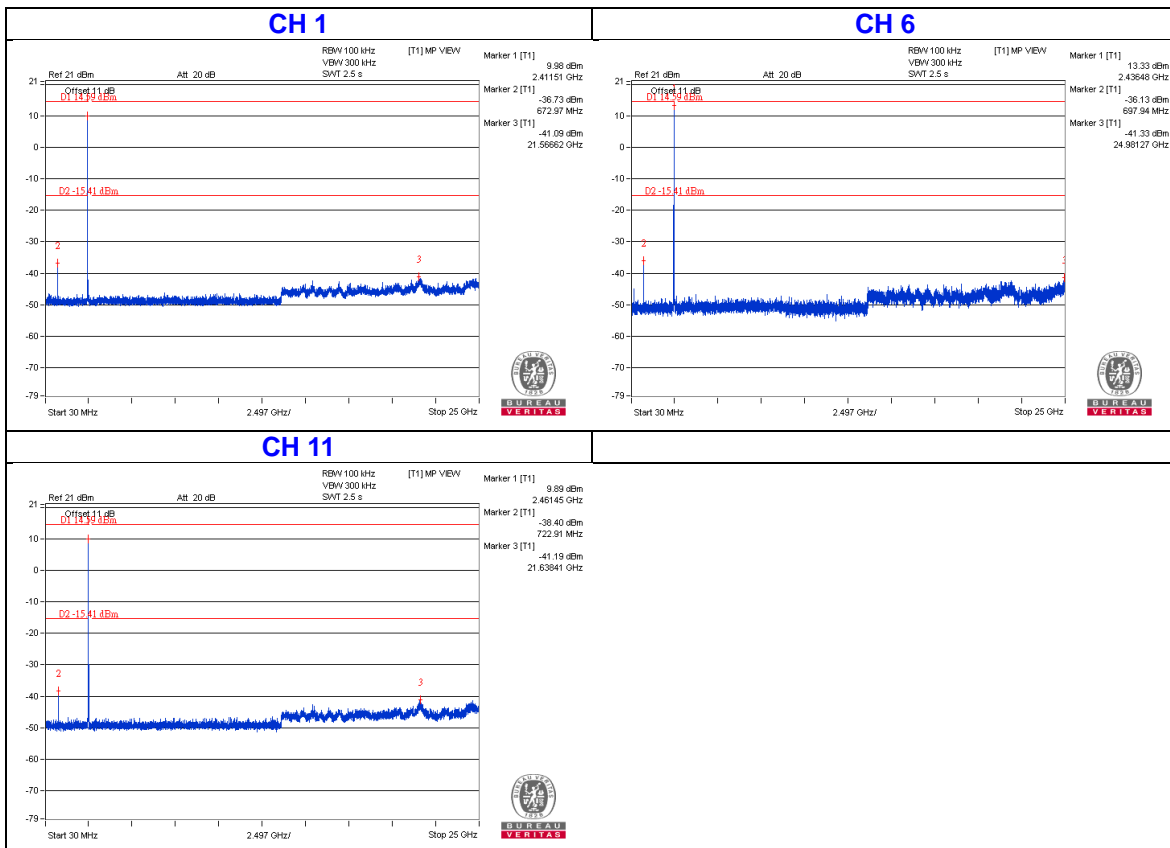

Chain 1

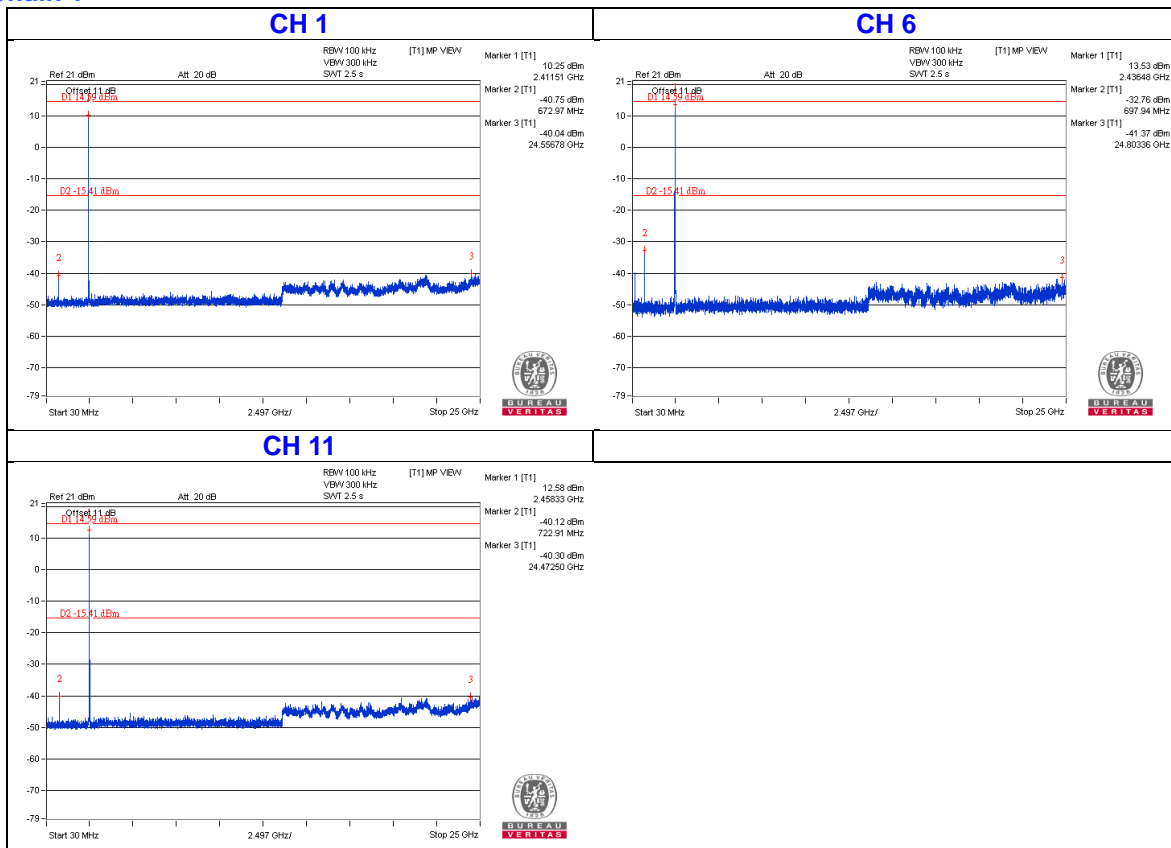

Chain 2

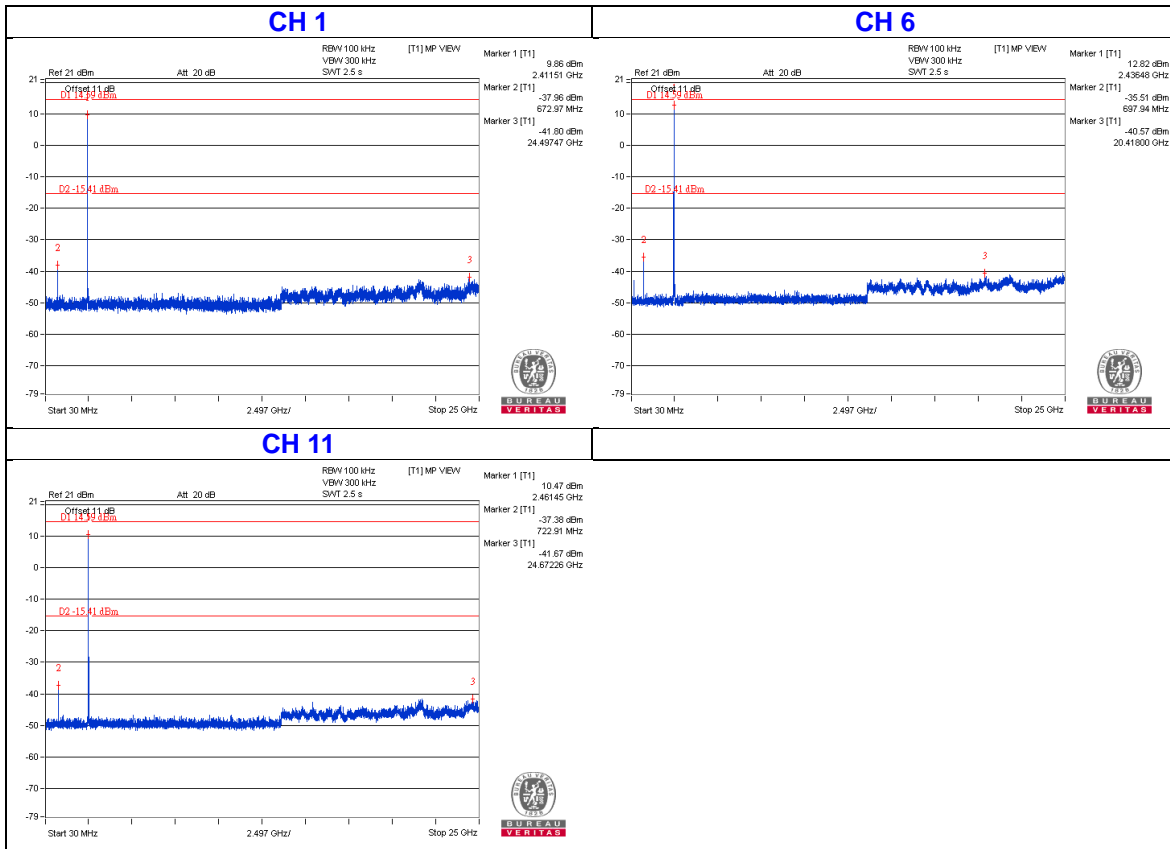

Chain 3

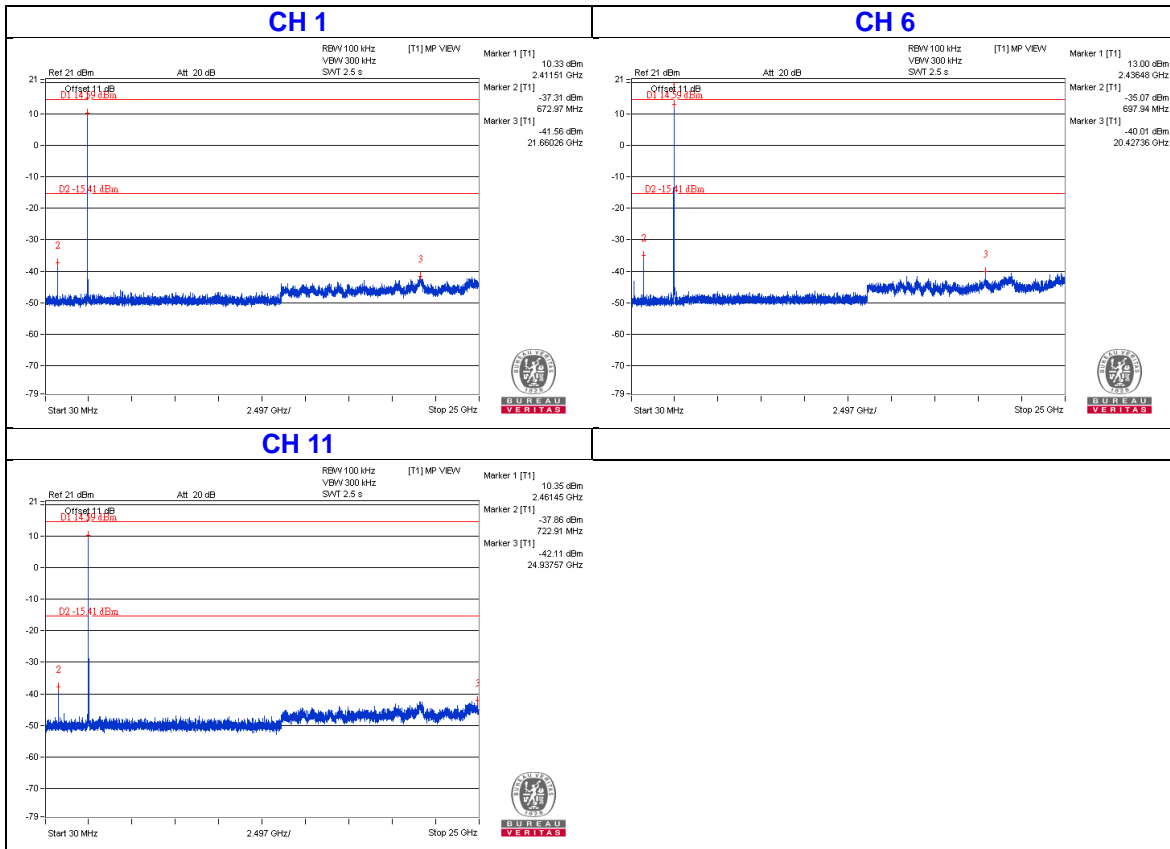

802.11g

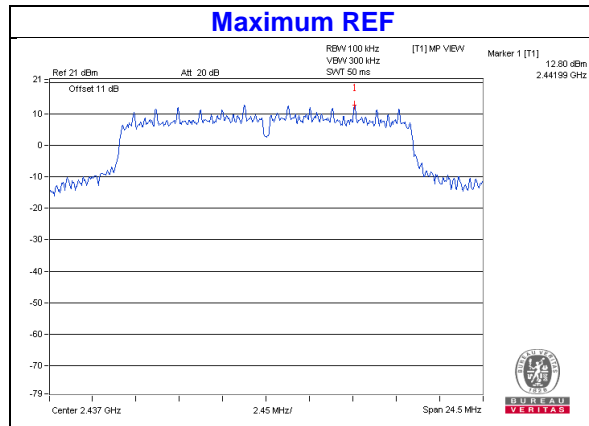

Chain 0

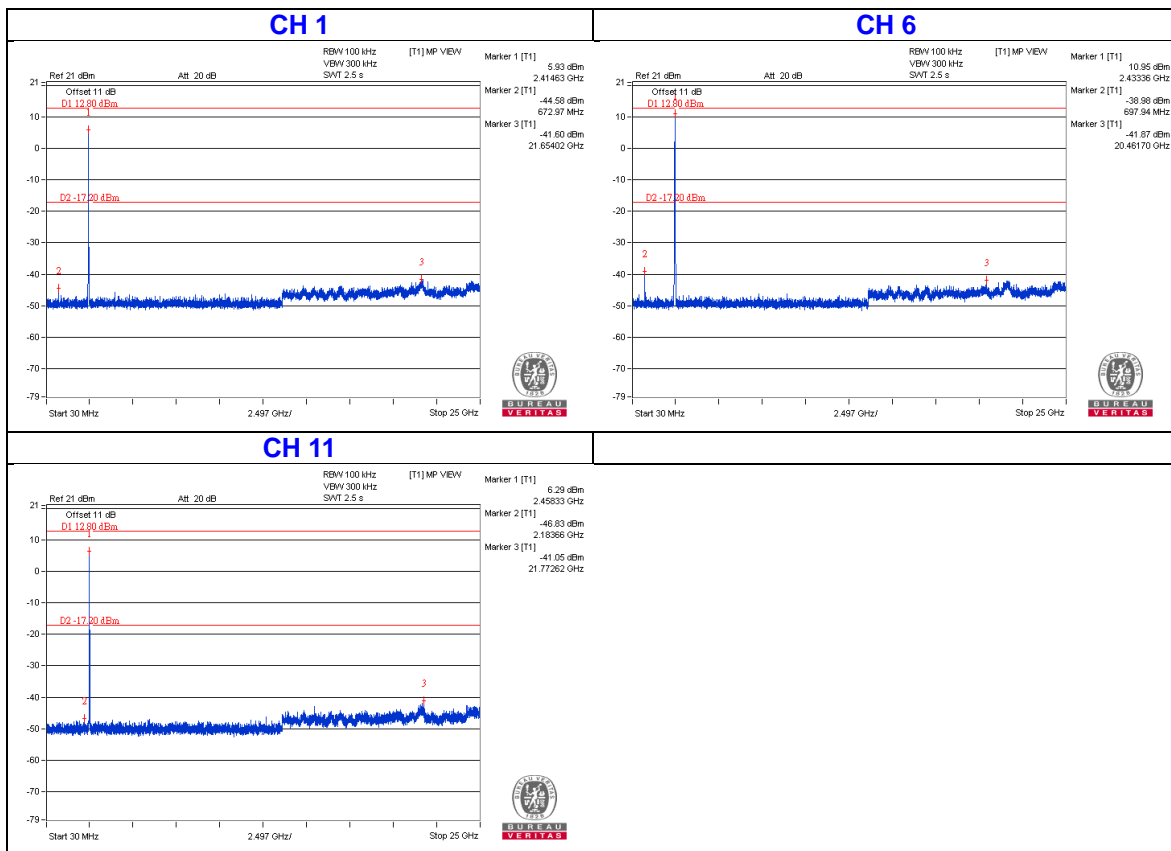

Chain 1

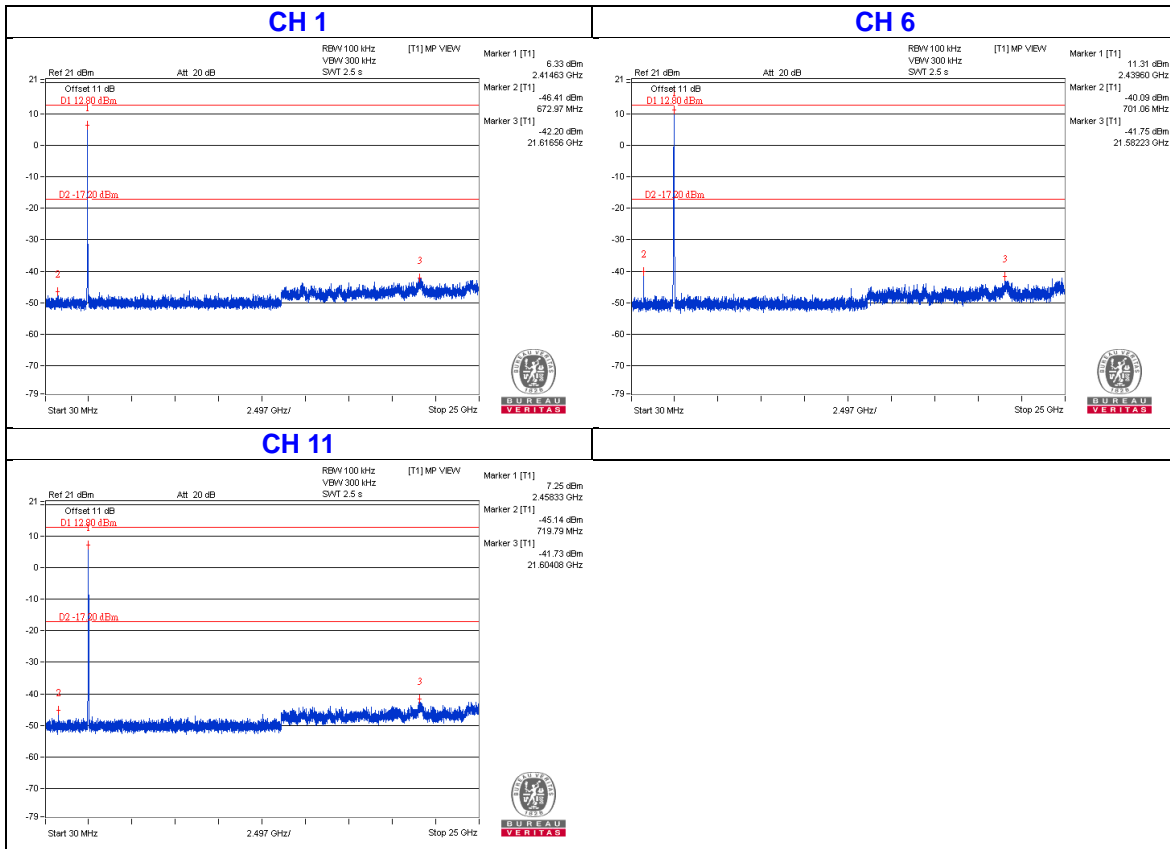

Chain 2

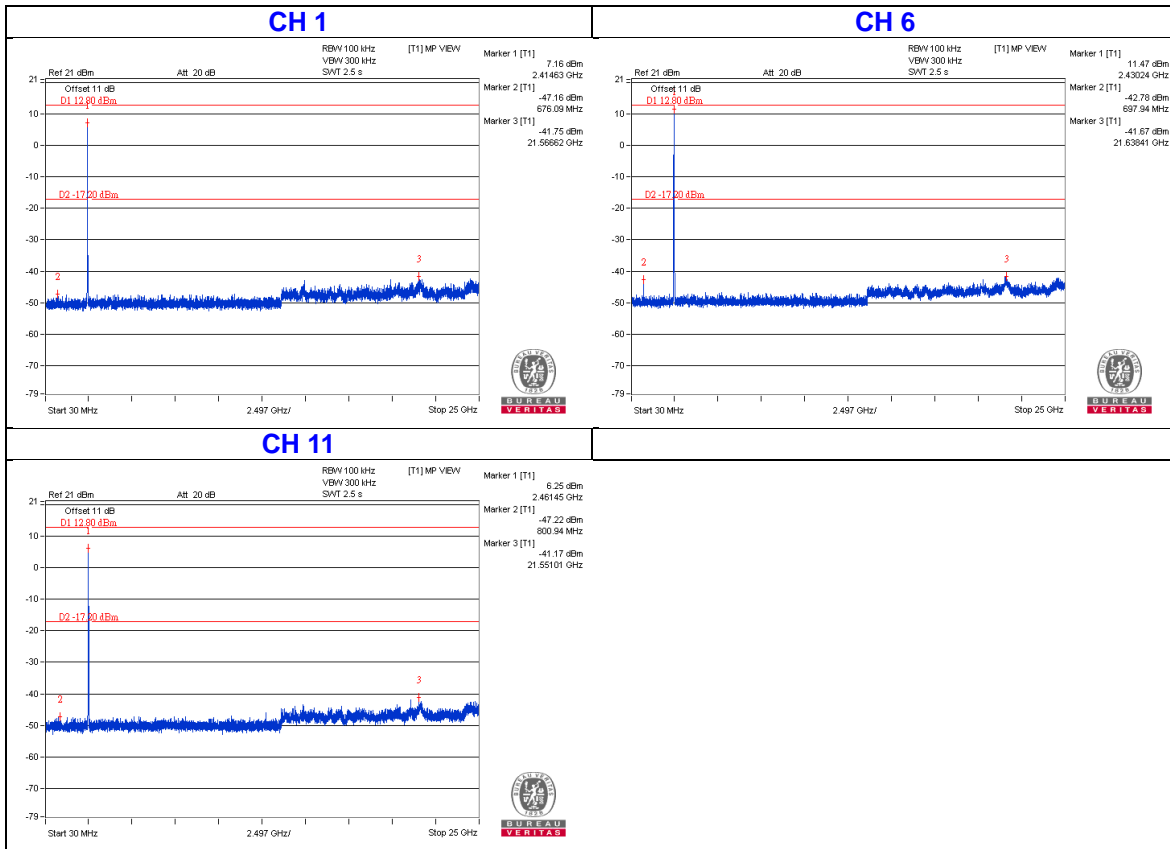

Chain 3

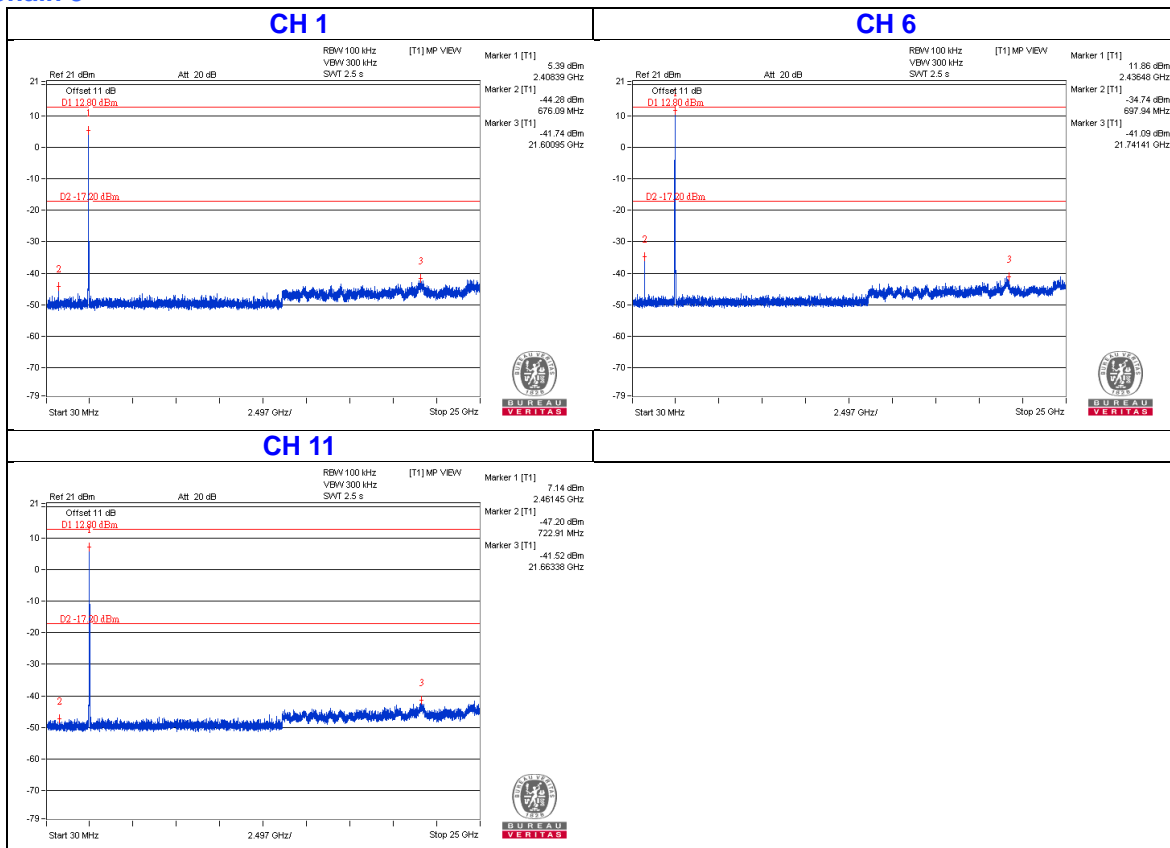

802.11n (HT20)

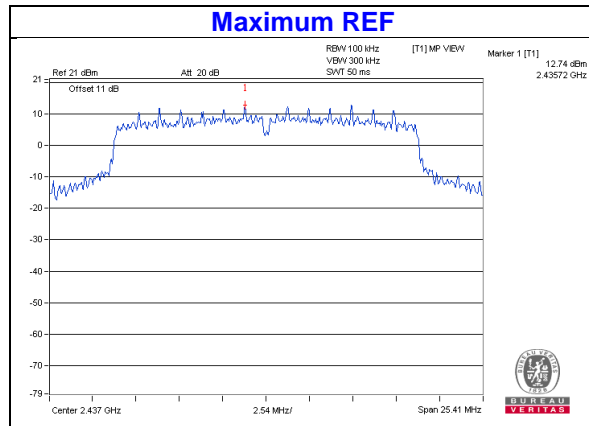

Chain 0

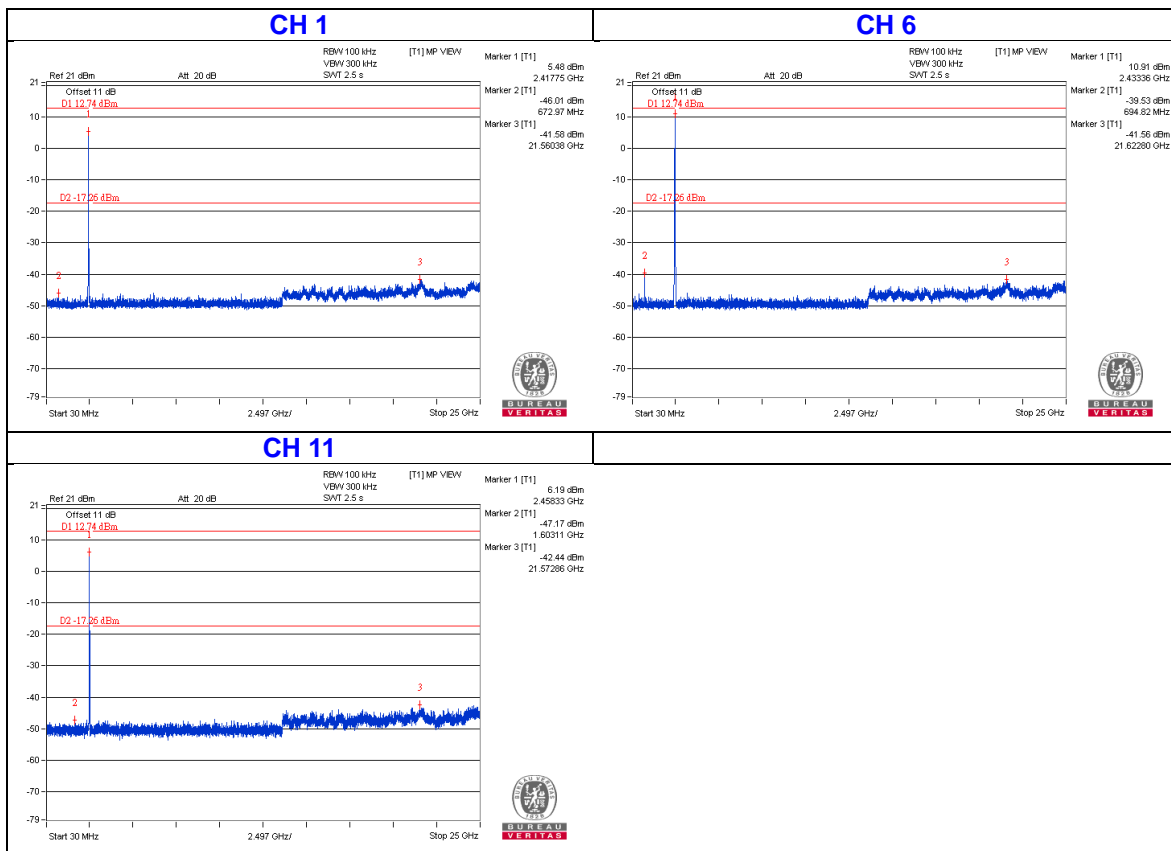

Chain 1

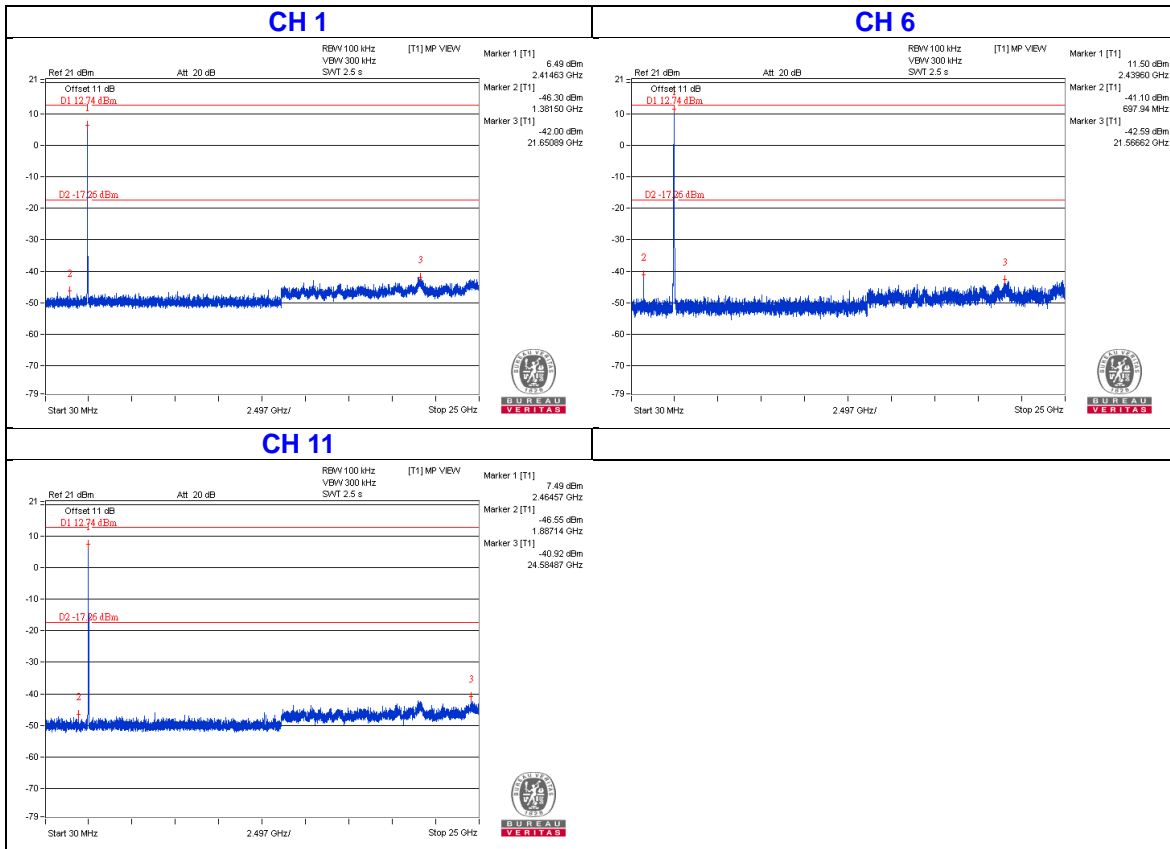

Chain 2

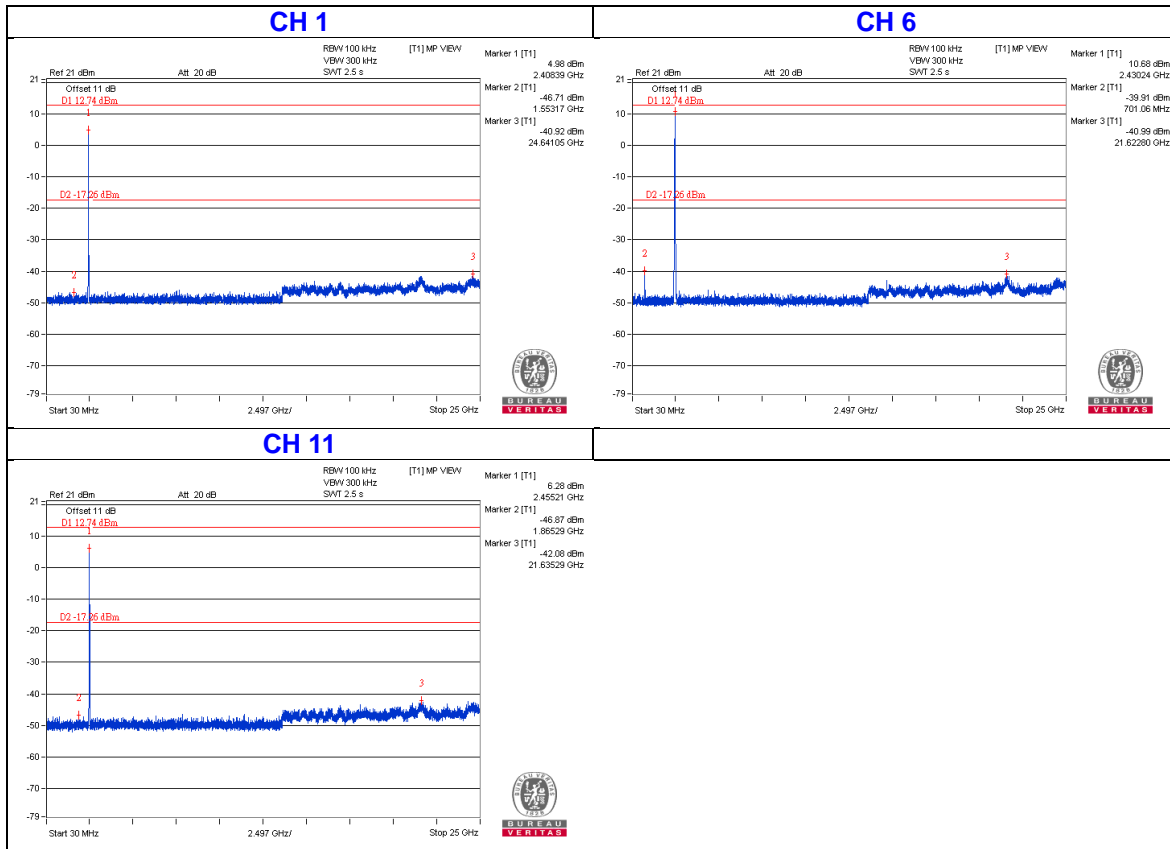

Chain 3

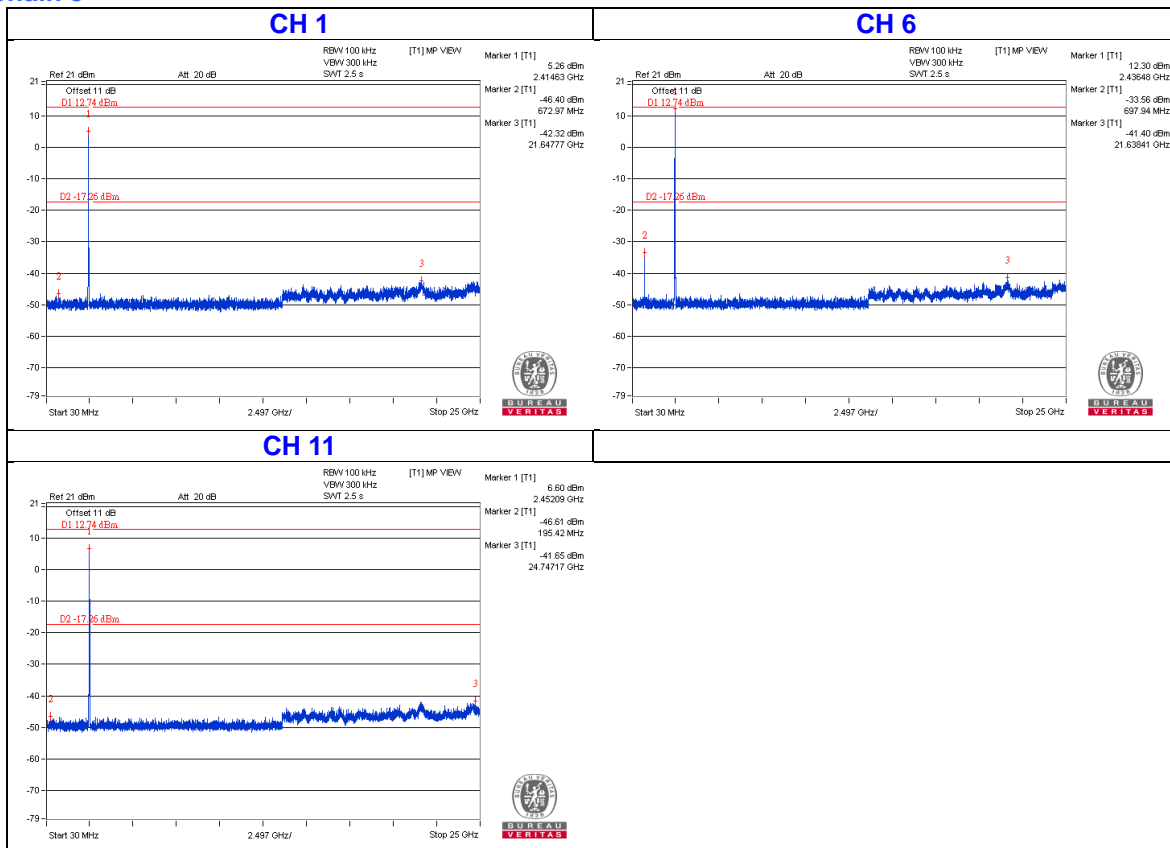

802.11n (HT40)

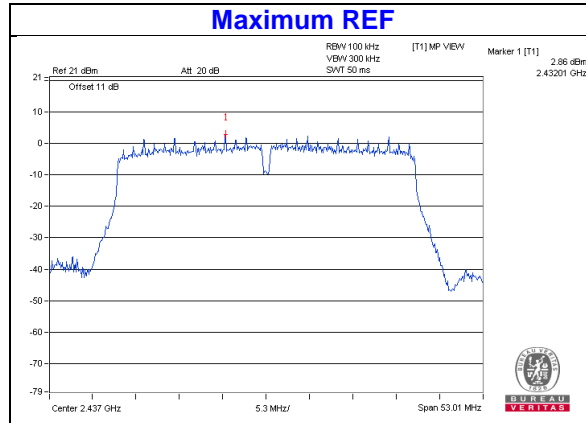

Chain 0

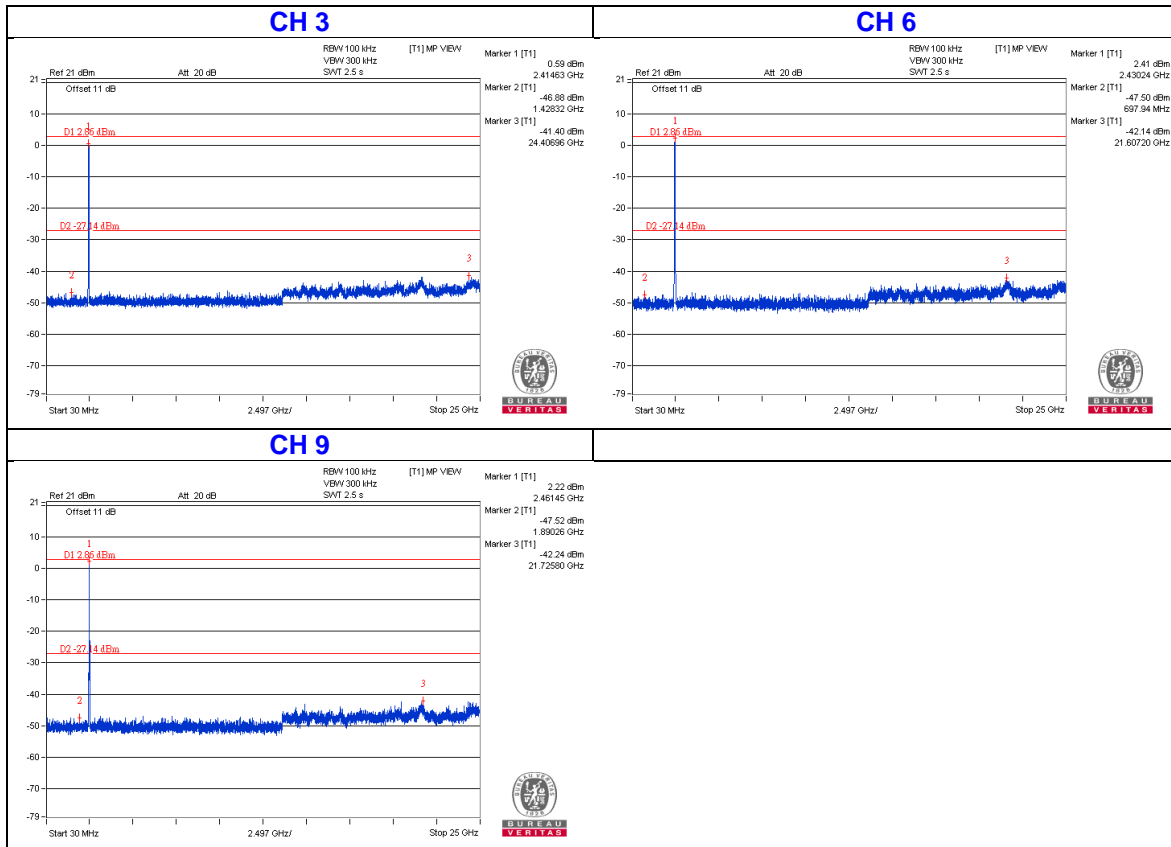

Chain 1

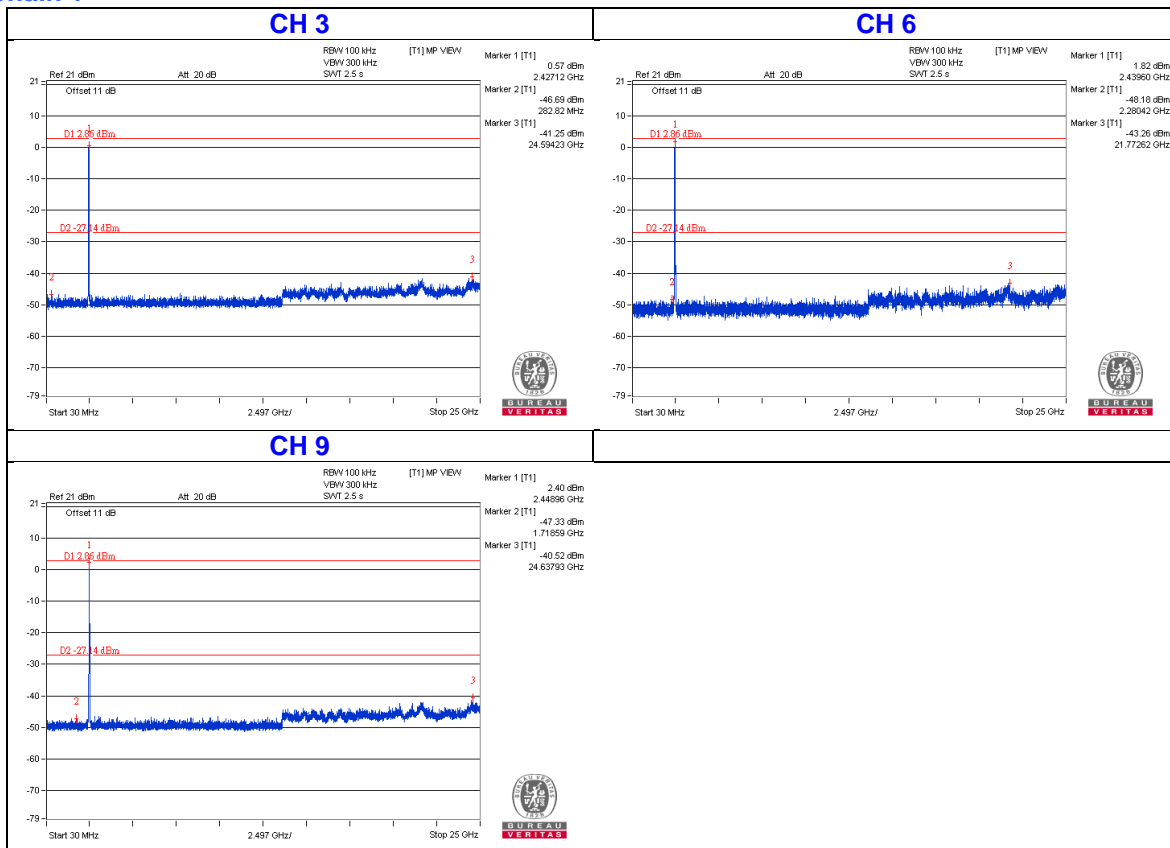

Chain 2

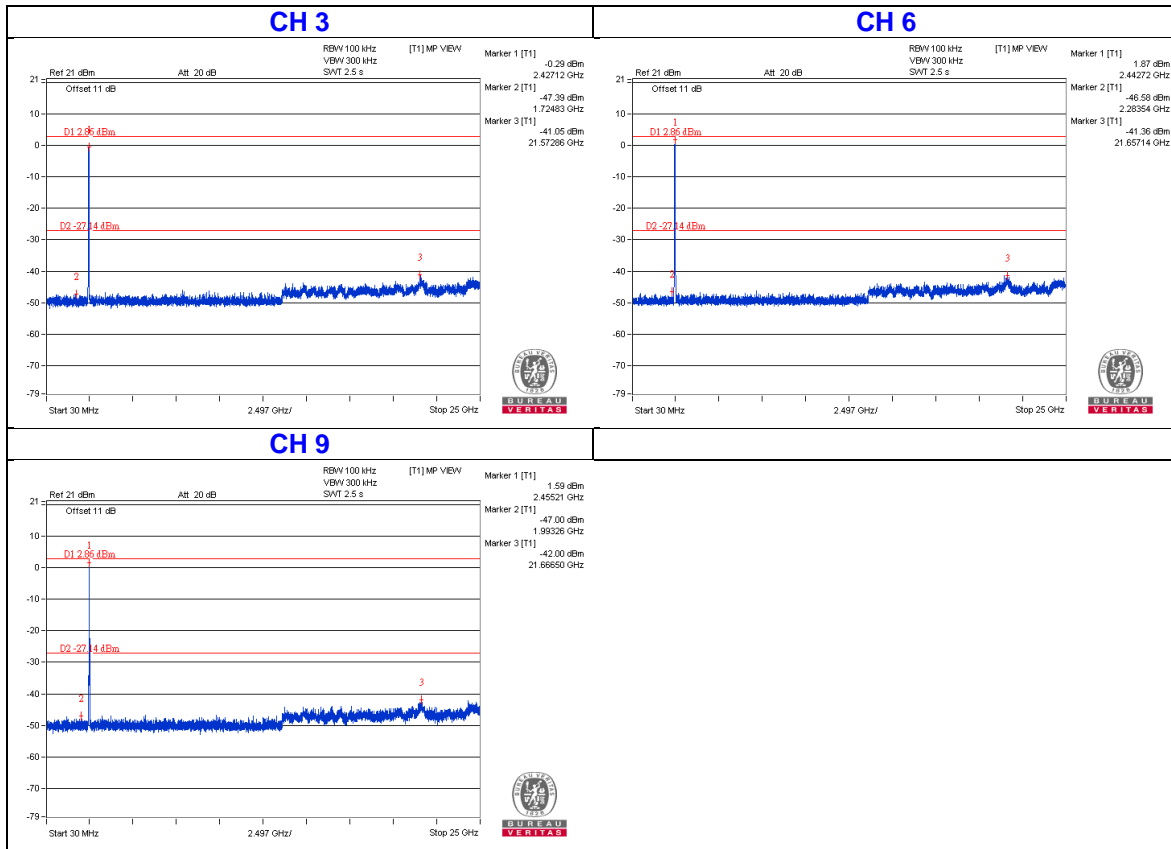

Chain 3

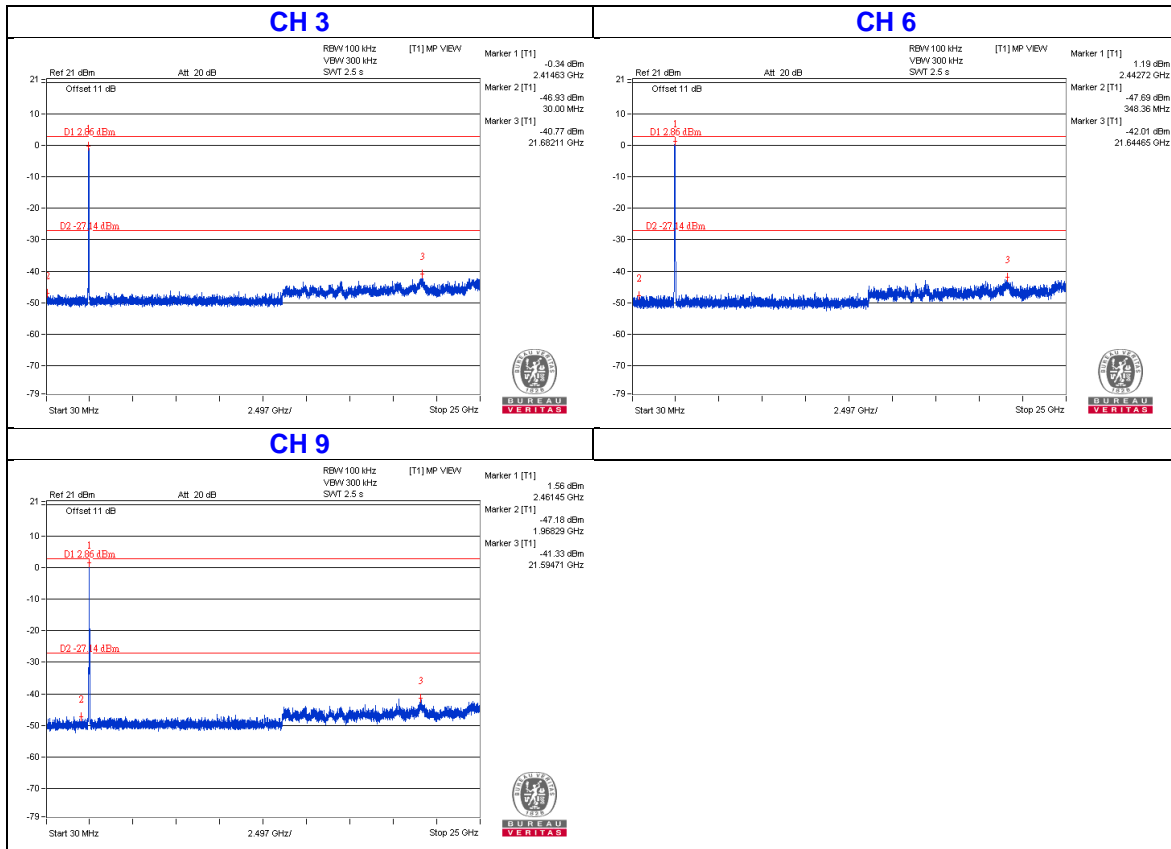

4.6.8 Test Results (Band Edge Test)

The spectrum plots are attached on the following pages. D1 line indicates the highest level, and D2 line indicates the 30dB offset below D1. It shows compliance with the requirement.

802.11b
Chain 0

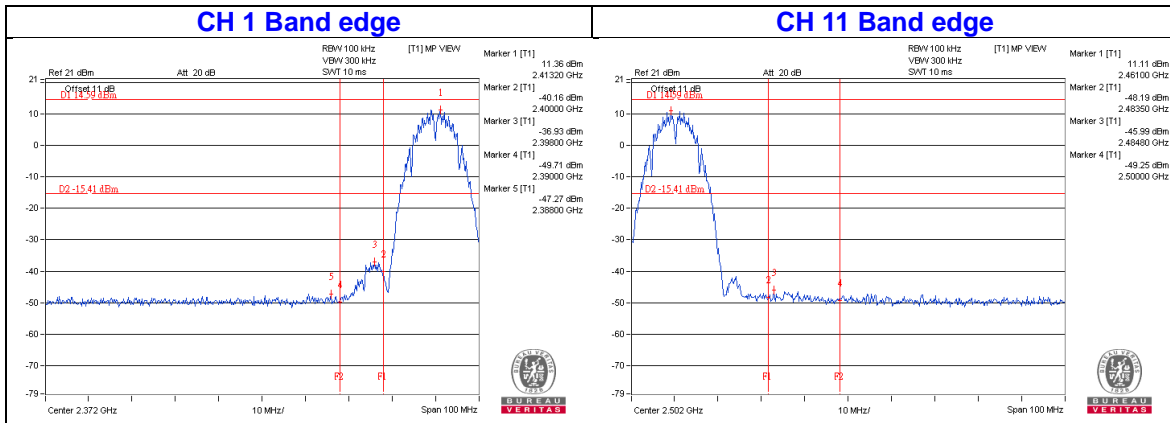

Chain 1

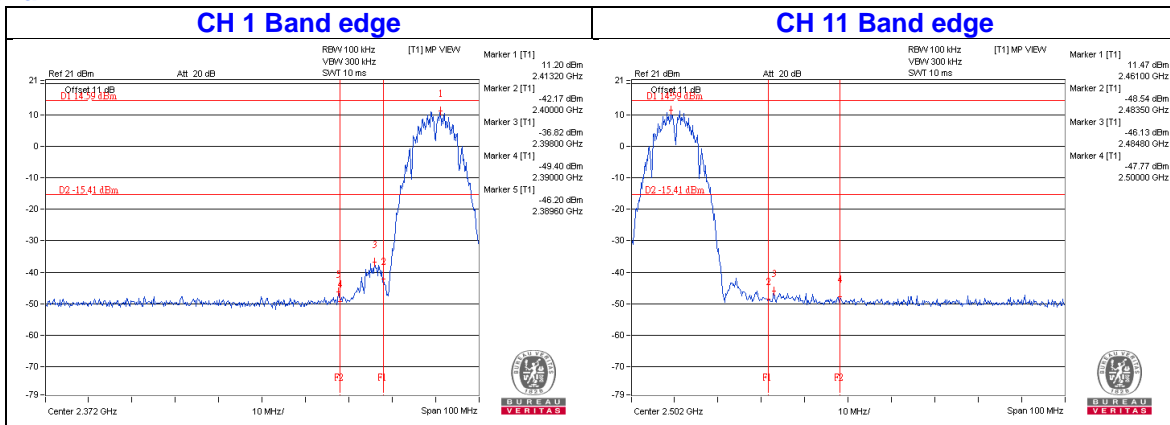

Chain 2

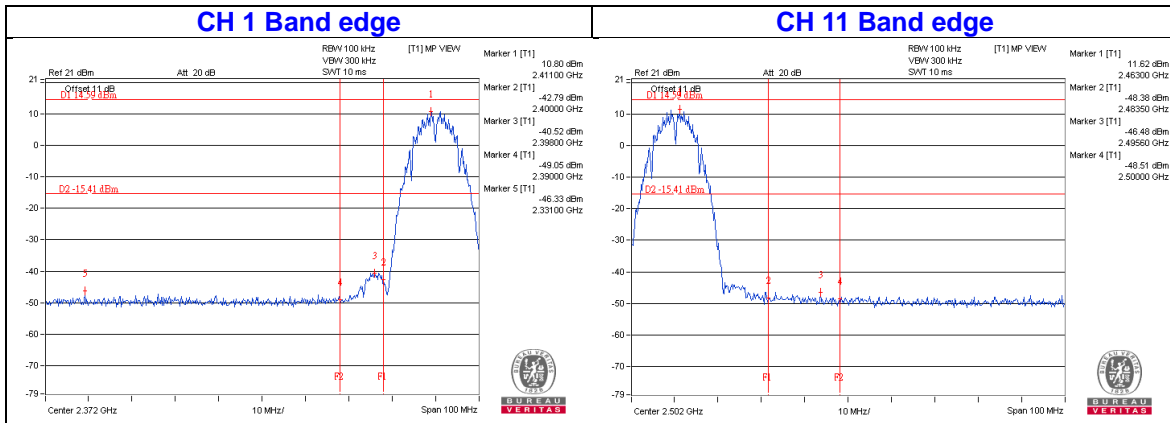

Chain 3

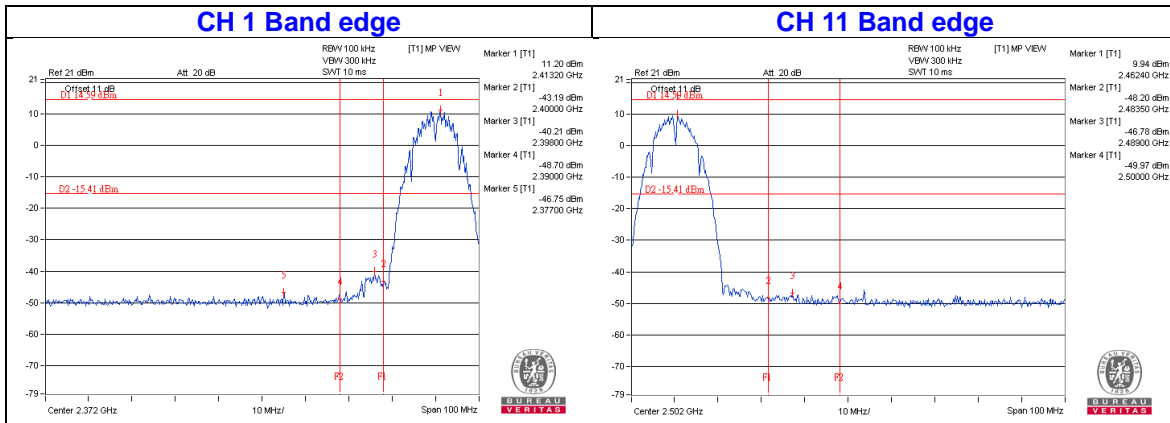

802.11g
Chain 0

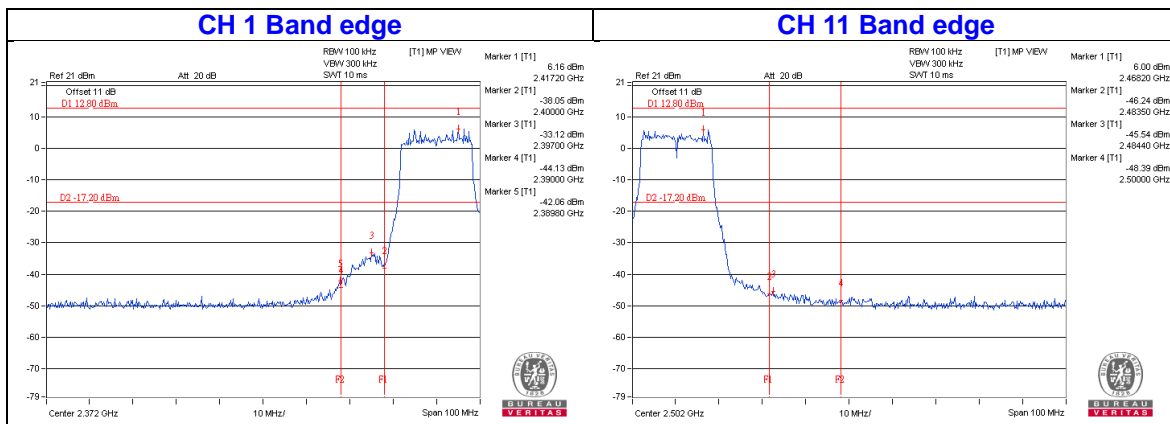

Chain 1

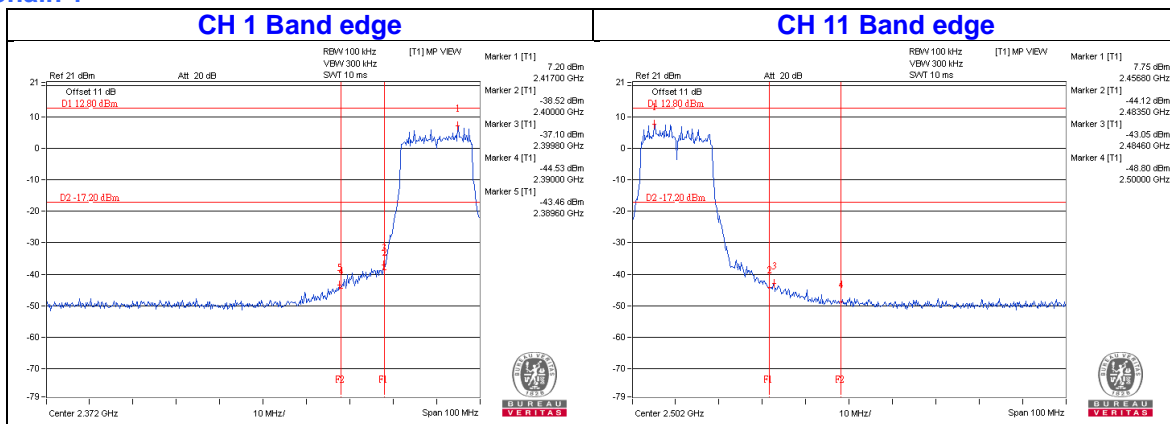

Chain 2

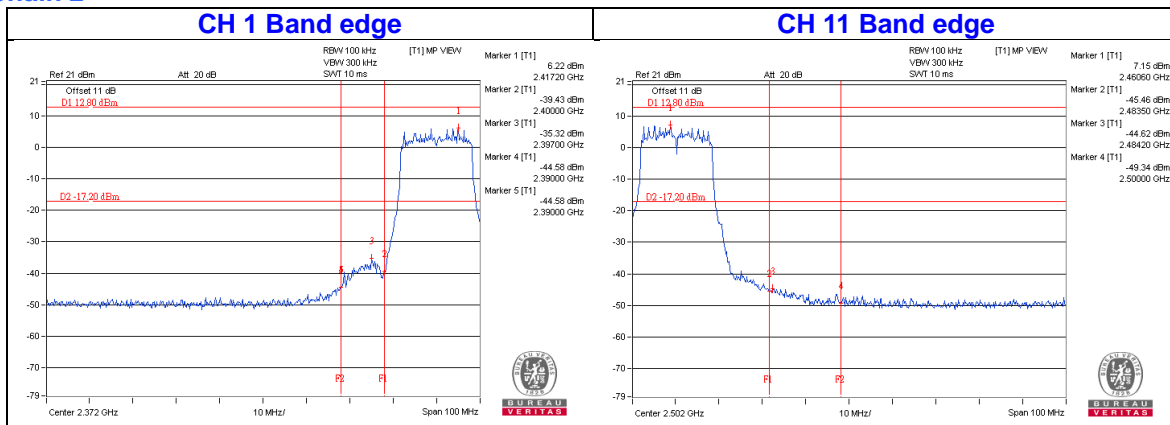

Chain 3

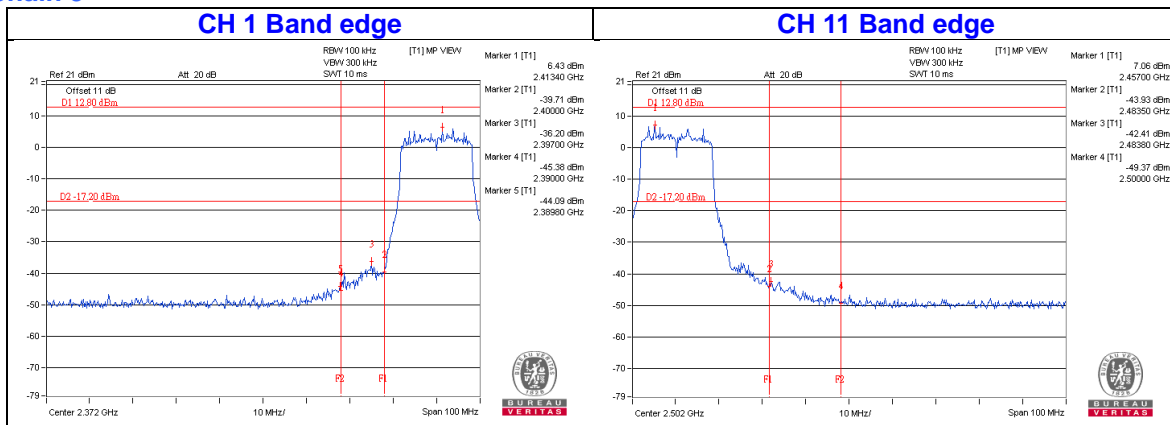

802.11n (HT20)
Chain 0

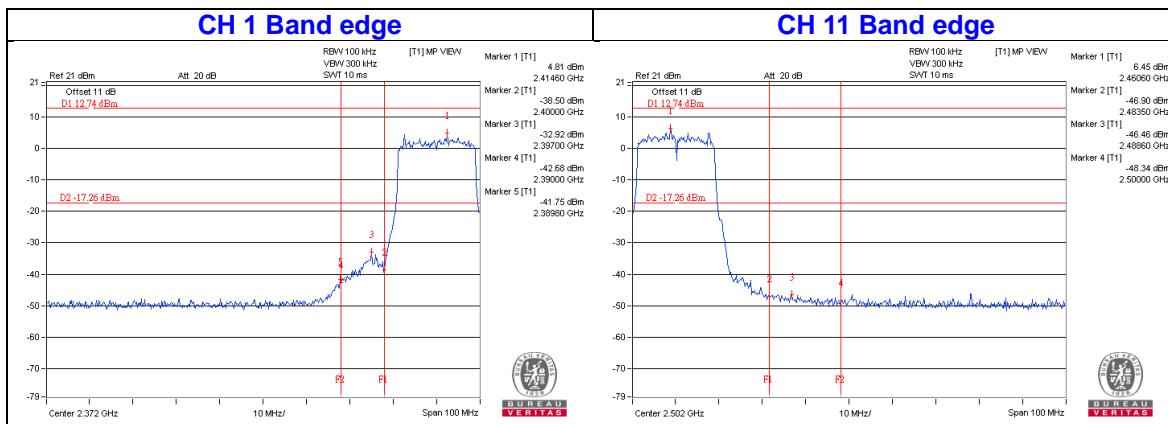

Chain 1

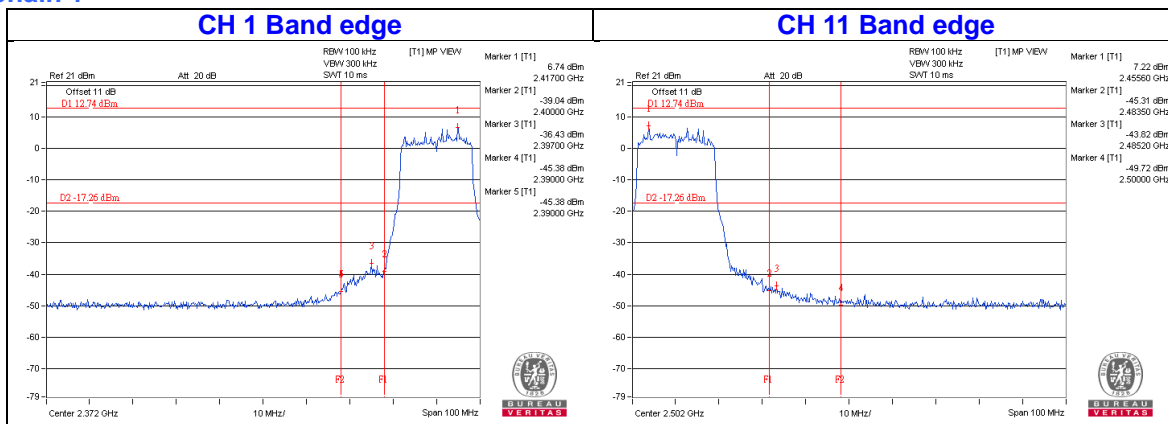

Chain 2

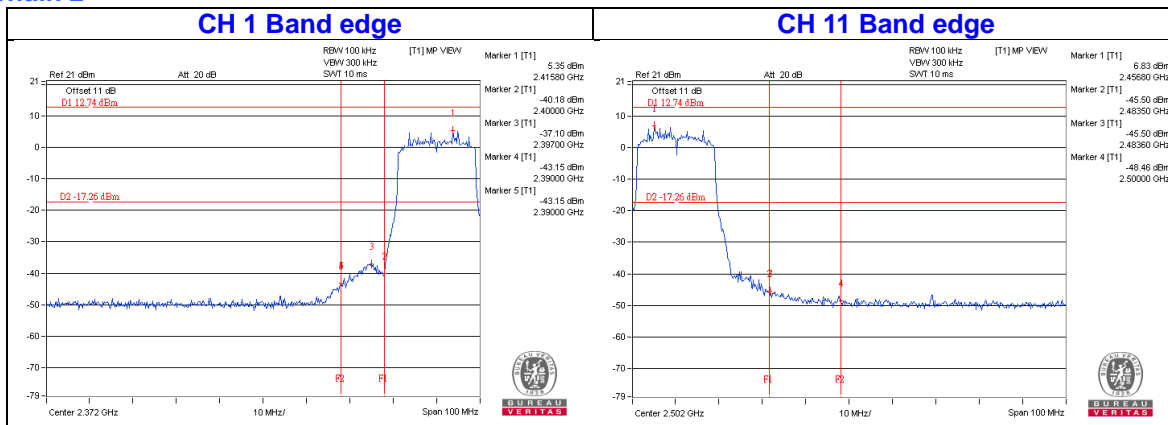

Chain 3

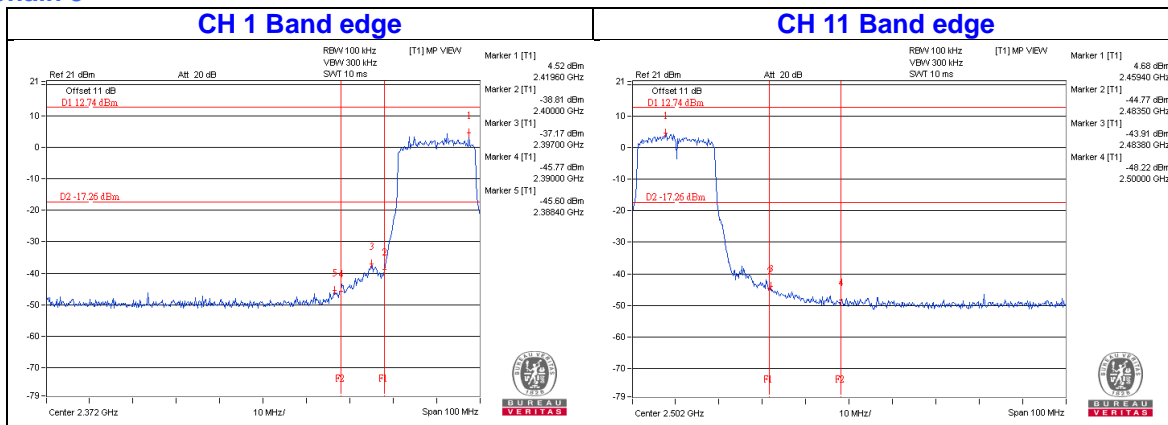

802.11n (HT40)
Chain 0

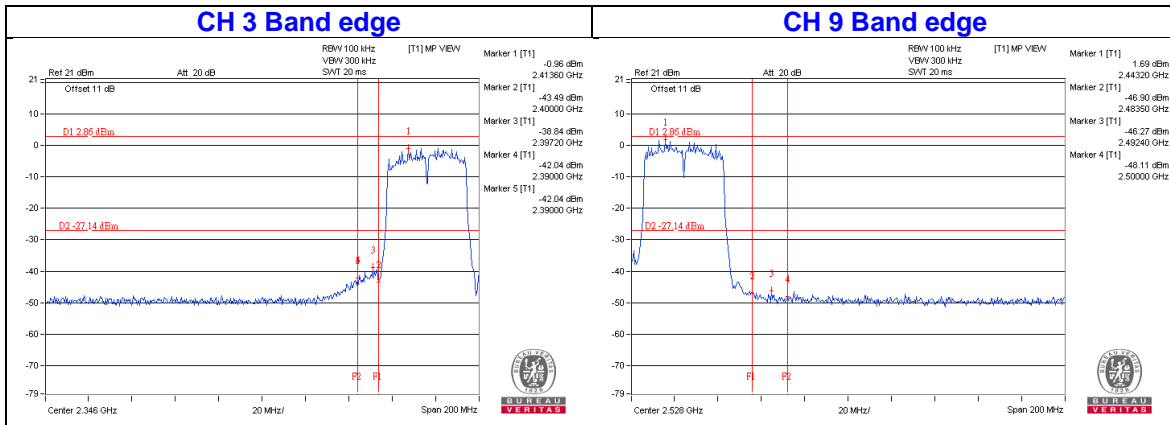

Chain 1

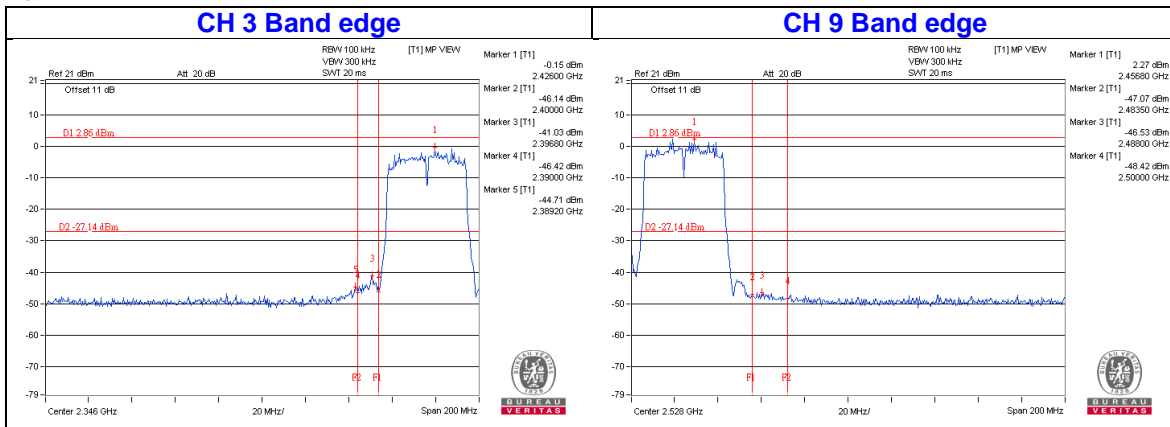

Chain 2

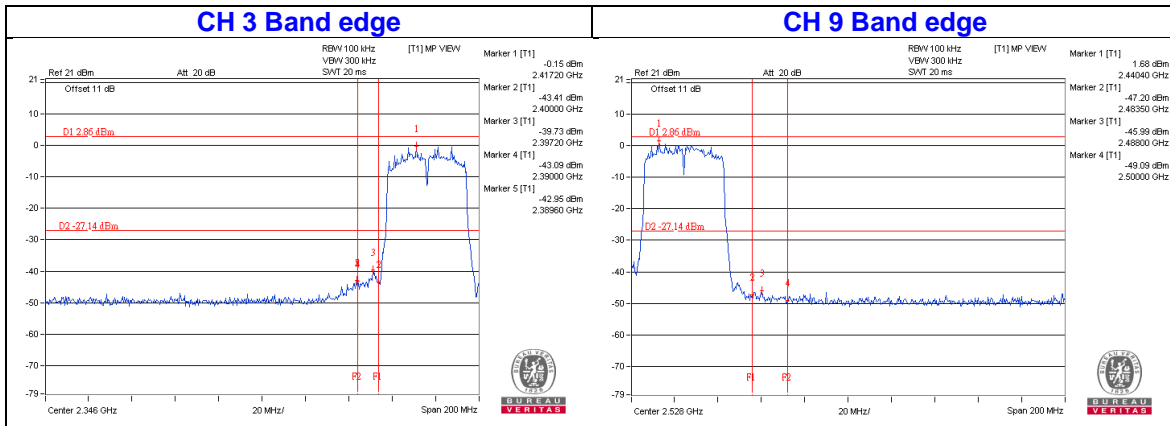

Chain 3

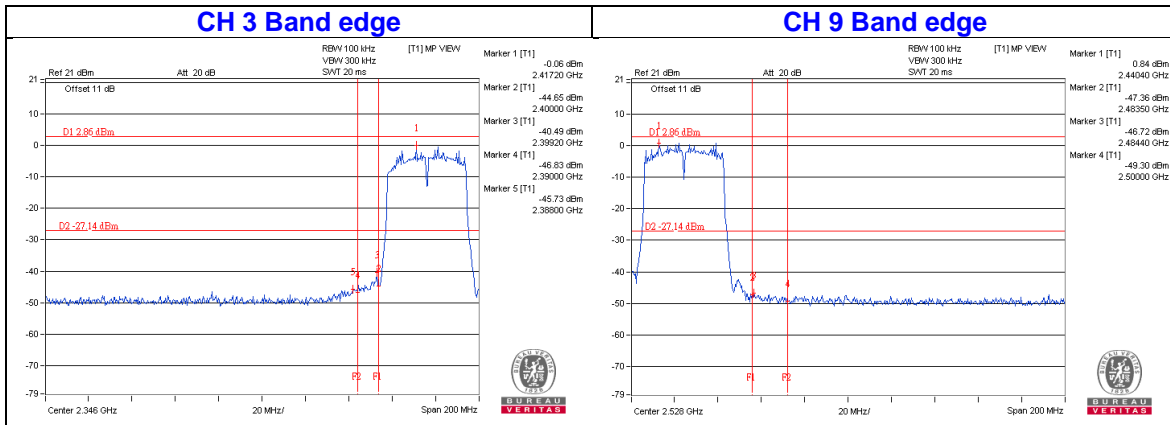

5 Pictures of Test Arrangements

Please refer to the attached file (Test Setup Photo).

Appendix – Information on the Testing Laboratories

We, Bureau Veritas Consumer Products Services (H.K.) Ltd., Taoyuan Branch, were founded in 1988 to provide our best service in EMC, Radio, Telecom and Safety consultation. Our laboratories are accredited and approved according to ISO/IEC 17025.

If you have any comments, please feel free to contact us at the following:

Linko EMC/RF Lab

Tel: 886-2-26052180

Fax: 886-2-26051924

Hsin Chu EMC/RF/Telecom Lab

Tel: 886-3-6668565

Fax: 886-3-6668323

Hwa Ya EMC/RF/Safety Lab

Tel: 886-3-3183232

Fax: 886-3-3270892

Email: service.adt@tw.bureauveritas.com

Web Site: www.bureauveritas-adt.com

The address and road map of all our labs can be found in our web site also.

--- END ---