

Supplemental “Transmit Simultaneously” Test Report

Report No.: RF160530E01-2

FCC ID: 2AD8UFZCWI4A1

Test Model: WI4A-AC400i

Received Date: May 30, 2016

Test Date: June 21 to Aug. 18, 2016

Issued Date: Sep. 30, 2016

Applicant: Nokia Solutions and Networks.OY

Address: 1455 West Shure Drive, Arlington Heights, IL 60004, USA

Issued By: Bureau Veritas Consumer Products Services (H.K.) Ltd., Taoyuan Branch
Hsin Chu Laboratory

Lab Address: E-2, No.1, Li Hsin 1st Road, Hsinchu Science Park, Hsinchu City 300,
Taiwan R.O.C.

Test Location (1): E-2, No.1, Li Hsin 1st Road, Hsinchu Science Park, Hsinchu City 300,
Taiwan R.O.C.

Test Location (2): No. 49, Ln. 206, Wende Rd., Shangshan Tsuen, Chiung Lin Hsiang, Hsin
Chu Hsien 307, Taiwan R.O.C.



This report is for your exclusive use. Any copying or replication of this report to or for any other person or entity, or use of our name or trademark, is permitted only with our prior written permission. This report sets forth our findings solely with respect to the test samples identified herein. The results set forth in this report are not indicative or representative of the quality or characteristics of the lot from which a test sample was taken or any similar or identical product unless specifically and expressly noted. Our report includes all of the tests requested by you and the results thereof based upon the information that you provided to us. You have 60 days from date of issuance of this report to notify us of any material error or omission caused by our negligence, provided, however, that such notice shall be in writing and shall specifically address the issue you wish to raise. A failure to raise such issue within the prescribed time shall constitute your unqualified acceptance of the completeness of this report, the tests conducted and the correctness of the report contents. Unless specific mention, the uncertainty of measurement has been explicitly taken into account to declare the compliance or non-compliance to the specification. The report must not be used by the client to claim product certification, approval, or endorsement by TAF or any government agencies.

Table of Contents

Release Control Record	3
1 Certificate of Conformity	4
2 Summary of Test Results	5
2.1 Measurement Uncertainty	5
2.2 Modification Record	5
3 General Information	6
3.1 General Description of EUT	6
3.1.1 Test Mode Applicability and Tested Channel Detail	10
3.2 Duty Cycle of Test Signal	12
3.3 Description of Support Units	13
3.3.1 Configuration of System under Test	14
3.4 General Description of Applied Standards	16
4 Test Types and Results	17
4.1 Radiated Emission and Bandedge Measurement	17
4.1.1 Limits of Radiated Emission and Bandedge Measurement	17
4.1.2 Test Instruments	18
4.1.3 Test Procedures	19
4.1.4 Deviation from Test Standard	19
4.1.5 Test Setup	20
4.1.6 EUT Operating Conditions	20
4.1.7 Test Results (Mode 1)	21
4.1.8 Test Results (Mode 2)	23
4.2 Conducted Emission Measurement	24
4.2.1 Limits of Conducted Emission Measurement	24
4.2.2 Test Instruments	24
4.2.3 Test Procedures	25
4.2.4 Deviation from Test Standard	25
4.2.5 Test Setup	25
4.2.6 EUT Operating Conditions	25
4.2.7 Test Results (Mode 1)	26
4.2.8 Test Results (Mode 2)	28
4.3 Conducted Out of Band Emission Measurement	30
4.3.1 Limits of Conducted Out of Band Emission Measurement	30
4.3.2 Test Setup	30
4.3.3 Test Instruments	30
4.3.4 Test Procedure	30
4.3.5 Deviation from Test Standard	30
4.3.6 EUT Operating Condition	30
4.3.7 Test Results (Overall Spurious Emission Test)	31
5 Pictures of Test Arrangements	32
Appendix – Information on the Testing Laboratories	33

Release Control Record

Issue No.	Description	Date Issued
RF160530E01-2	Original release.	Sep. 30, 2016



1 Certificate of Conformity

Product: Wireless Access Point
Brand: NOKIA
Test Model: WI4A-AC400i
Sample Status: ENGINEERING SAMPLE
Applicant: Nokia Solutions and Networks.OY
Test Date: June 21 to Aug. 18, 2016
Standards: 47 CFR FCC Part 15, Subpart C (Section 15.247)
ANSI C63.10: 2013

The above equipment has been tested by **Bureau Veritas Consumer Products Services (H.K.) Ltd., Taoyuan Branch**, and found compliance with the requirement of the above standards. The test record, data evaluation & Equipment Under Test (EUT) configurations represented herein are true and accurate accounts of the measurements of the sample's EMC characteristics under the conditions specified in this report.

Prepared by : Midoli Peng , **Date:** Sep. 30, 2016
Midoli Peng / Specialist

Approved by : May Chen , **Date:** Sep. 30, 2016
May Chen / Manager

2 Summary of Test Results

47 CFR FCC Part 15, Subpart C (SECTION 15.247)

FCC Clause	FCC KDB 558074	Test Item	Result	Remarks
15.207	-	AC Power Conducted Emission	PASS	Meet the requirement of limit. Minimum passing margin is -4.80dB at 24.00000MHz.
15.205 / 15.209 / 15.247(d)	Section 11, 12 &13	Radiated Emissions and Band Edge Measurement	PASS	Meet the requirement of limit. Minimum passing margin is -1.2dB at 40.54MHz

2.1 Measurement Uncertainty

Where relevant, the following measurement uncertainty levels have been estimated for tests performed on the EUT as specified in CISPR 16-4-2:

Measurement	Frequency	Expanded Uncertainty (k=2) (±)
Conducted Emissions at mains ports	150kHz ~ 30MHz	1.83 dB
Radiated Emissions up to 1 GHz	30MHz ~ 1GHz	5.31 dB
Radiated Emissions above 1 GHz	1GHz ~ 6GHz	3.40 dB
	6GHz ~ 18GHz	3.73 dB
	18GHz ~ 40GHz	4.11 dB

2.2 Modification Record

There were no modifications required for compliance.

3 General Information

3.1 General Description of EUT

Product	Wireless Access Point
Brand	NOKIA
Test Model	WI4A-AC400i
Test Sample S/N	NH162800087
Hardware Version	AM2
Status of EUT	ENGINEERING SAMPLE
Power Supply Rating	12Vdc from power adapter or 54Vdc from POE
Modulation Type	CCK, DQPSK, DBPSK for DSSS 64QAM, 16QAM, QPSK, BPSK for OFDM 256QAM for OFDM in 11ac mode
Modulation Technology	DSSS, OFDM
Transfer Rate	802.11b: up to 11Mbps 802.11a/g: up to 54Mbps 802.11n: up to 600Mbps 802.11ac: up to 1733.3Mbps
Operating Frequency	For 15.407 5.18 ~ 5.24GHz, 5.745 ~ 5.825GHz
	For 15.247 2.412 ~ 2.462GHz
Number of Channel	For 15.407 802.11a, 802.11n (HT20), 802.11ac (VHT20): 9 802.11n (HT40), 802.11ac (VHT40): 4 802.11ac (VHT80): 2 802.11ac (VHT80+80): 2
	For 15.247 802.11b, 802.11g, 802.11n (HT20): 11 802.11n (HT40): 7
Output Power	For 15.407 5.18GHz ~ 5.24GHz: CDD Mode: 534.298mW Beamforming Mode: 283.263mW 5.745GHz ~ 5.825GHz: CDD Mode: 951.593mW Beamforming Mode: 280.374mW
	For 15.247 CDD Mode 884.423mW Beamforming Mode 420.146mW
Antenna Type	Refer to Note
Antenna Connector	Refer to Note
Accessory Device	Adapter x1
Data Cable Supplied	NA

Note:

1. The antennas provided to the EUT, please refer to the following table:

Antenna spec.

Antenna No	PCB Chain No.	Brand	Model	Antenna Type	Gain(dBi)	Frequency (MHz)
1	Chain 2	Galtronics	02102140-06226A1	PIFA	3.92	2400
					3.99	2450
					4.28	2500
					3.81	5150
					3.71	5250
					4.06	5350
					5.83	5725
2	Chain 3	Galtronics	02102140-06226A2	PIFA	6.21	5825
					2.27	2400
					1.81	2450
					1.84	2500
					5.67	5150
					5.95	5250
					5.83	5350
3	Chain 1	Galtronics	02102140-06226A3	PIFA	5.38	5725
					5.38	5825
					2.42	2400
					2.45	2450
					2.71	2500
					5.69	5150
					5.41	5250
4	Chain 0	Galtronics	02102140-06226A4	PIFA	5.2	5350
					4.92	5725
					5.07	5825
					2.88	2400
					3.22	2450
					3.82	2500
					4.85	5150
4.66	5250					
4.32	5350					
5.02	5725					
4.87	5825					

Cable Spec.

Antenna No	Brand	Model	Connector Type	Cable Loss(dB)	Cable Length (mm)
1	Galtronics	RG-137	i-pex(MHF)	1.5	175
2	Galtronics	RG-137	i-pex(MHF)	1.3	130
3	Galtronics	RG-137	i-pex(MHF)	0.5	50
4	Galtronics	RG-137	i-pex(MHF)	0.8	75

2. Simultaneously transmission condition.

Condition	Technology	
1	WLAN (2.4GHz)	WLAN (5GHz)

3. The EUT incorporates a MIMO function.

2.4GHZ Band			
MODULATION MODE	DATA RATE (MCS)	TX & RX CONFIGURATION	
802.11b	1 ~ 11Mbps	4TX	4RX
802.11g	6 ~ 54Mbps	4TX	4RX
802.11n (HT20)	MCS 0~7	4TX	4RX
	MCS 8~15	4TX	4RX
	MCS16~23	4TX	4RX
	MCS 24~31	4TX	4RX
802.11n (HT40)	MCS 0~7	4TX	4RX
	MCS 8~15	4TX	4RX
	MCS16~23	4TX	4RX
	MCS 24~31	4TX	4RX
5GHz Band			
MODULATION MODE	DATA RATE (MCS)	TX & RX CONFIGURATION	
802.11a	6 ~ 54Mbps	4TX	4RX
802.11n (HT20)	MCS 0~7	4TX	4RX
	MCS 8~15		
	MCS16~23		
	MCS 24~31		
802.11n (HT40)	MCS 0~7	4TX	4RX
	MCS 8~15		
	MCS16~23		
	MCS 24~31		
802.11ac (VHT20)	MCS 0~8, Nss=1	4TX	4RX
	MCS 0~8, Nss=2		
	MCS 0~9, Nss=3		
	MCS 0~8, Nss=4		
802.11ac (VHT40)	MCS 0~9, Nss=1	4TX	4RX
	MCS 0~9, Nss=2		
	MCS 0~9, Nss=3		
	MCS 0~9, Nss=4		
802.11ac (VHT80)	MCS 0~9, Nss=1	4TX	4RX
	MCS 0~9, Nss=2		
	MCS 0~9, Nss=3		
	MCS 0~9, Nss=4		
802.11ac (VHT80+VHT80) noncontiguous	MCS 0~9, Nss=1	4TX	4RX
	MCS 0~9, Nss=2	4TX	4RX

Note:

1. All of modulation mode support beamforming function except 802.11a/b/g modulation mode.

4. The EUT was tested in both DC powered and PoE powered modes of operation using the representative AC/DC power converter and PoE injector listed below:

POE		
Brand	Model No.	Spec.
UE	PoE35-54A	Input: 100-240V, 1.0A, 50/60Hz AC input cable(1.0m, unshielded) Output: 54V, 0.65A
Adapter		
Brand	Model No.	Spec.
UE	UES36-120300SPA	Input: 100-240V, 1.0A, 50/60Hz AC input cable(1.5m, unshielded) Output: 12V, 3.0A DC output cable(1.0m, unshielded, with one core)

5. The EUT was pre-tested under following test modes :

Test Mode	Description
Mode 1	With POE
Mode 2	With adapter

For the above modes, the worst radiated emission (above 1GHz) test was found in **Mode 1**. Therefore only the test data of the modes were recorded in this report.

6. The above EUT information is declared by manufacturer and for more detailed features description, please refer to the manufacturer's specifications or user's manual.

3.1.1 Test Mode Applicability and Tested Channel Detail

EUT CONFIGURE MODE	APPLICABLE TO				DESCRIPTION
	RE \geq 1G	RE<1G	PLC	OB	
1	√	√	√	√	With POE
2	-	√	√	-	With adapter

Where **RE \geq 1G: Radiated Emission above 1GHz** **RE<1G: Radiated Emission below 1GHz**
PLC: Power Line Conducted Emission **OB: Conducted Out-Band Emission Measurement**

Radiated Emission Test (Above 1GHz):

Following channel(s) was (were) selected for the final test as listed below.

MODE	AVAILABLE CHANNEL	TESTED CHANNEL	MODULATION TECHNOLOGY	MODULATION TYPE	DATA RATE (Mbps)
2.4GHz (802.11g) + 5GHz (802.11ac(VHT20))	1 to 11	6	OFDM	BPSK	6
	149 to 165	165	OFDM	BPSK	6.5

Radiated Emission Test (Below 1GHz):

Following channel(s) was (were) selected for the final test as listed below.

MODE	AVAILABLE CHANNEL	TESTED CHANNEL	MODULATION TECHNOLOGY	MODULATION TYPE	DATA RATE (Mbps)
2.4GHz (802.11g) + 5GHz (802.11ac(VHT20))	1 to 11	6	OFDM	BPSK	6
	149 to 165	165	OFDM	BPSK	6.5

Power Line Conducted Emission Test:

Following channel(s) was (were) selected for the final test as listed below.

MODE	AVAILABLE CHANNEL	TESTED CHANNEL	MODULATION TECHNOLOGY	MODULATION TYPE	DATA RATE (Mbps)
2.4GHz (802.11g) + 5GHz (802.11ac(VHT20))	1 to 11	6	OFDM	BPSK	6
	149 to 165	165	OFDM	BPSK	6.5

Conducted Out-Band Emission Measurement:

Following channel(s) was (were) selected for the final test as listed below.

MODE	AVAILABLE CHANNEL	TESTED CHANNEL	MODULATION TECHNOLOGY	MODULATION TYPE	DATA RATE (Mbps)
2.4GHz (802.11g) + 5GHz (802.11ac(VHT20))	1 to 11	6	OFDM	BPSK	6
	149 to 165	165	OFDM	BPSK	6.5

Test Condition:**Input Power to POE**

APPLICABLE TO	ENVIRONMENTAL CONDITIONS	INPUT POWER	TESTED BY
RE \geq 1G	23deg. C, 63%RH	120Vac, 60Hz	Jyunchun Lin
RE $<$ 1G	24deg. C, 62%RH	120Vac, 60Hz	Jyunchun Lin
PLC	25deg. C, 61%RH	120Vac, 60Hz	Jyunchun Lin
OB	25deg. C, 60%RH	120Vac, 60Hz	Robert Cheng

Input Power to Adapter

APPLICABLE TO	ENVIRONMENTAL CONDITIONS	INPUT POWER	TESTED BY
RE $<$ 1G	24deg. C, 62%RH	120Vac, 60Hz	Jyunchun Lin
PLC	25deg. C, 61%RH	120Vac, 60Hz	Jyunchun Lin

3.2 Duty Cycle of Test Signal

Duty cycle of test signal is $\geq 98\%$, duty factor is not required.

2.4GHz: 802.11g: Duty cycle = $2.062/2.100 = 0.982$

5GHz: 802.11ac (VHT20): Duty cycle = $5.002\text{ms}/2.087\text{ms} = 0.983$

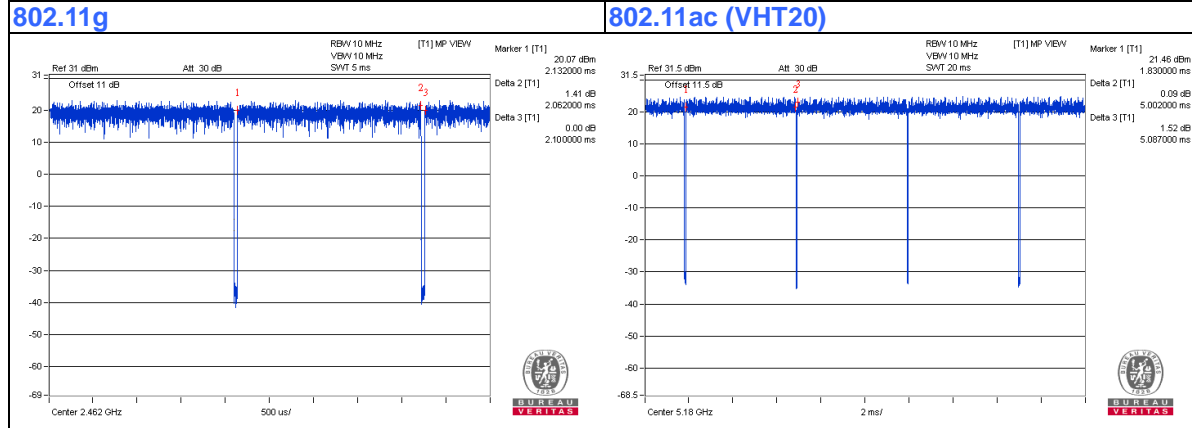

3.3 Description of Support Units

The EUT has been tested as an independent unit together with other necessary accessories or support units. The following support units or accessories were used to form a representative test configuration during the tests.

ID	Product	Brand	Model No.	Serial No.	FCC ID	Remarks
A.	Notebook Computer	DELL	E5430	HYV4VY1	FCC DoC	Provided by Lab
B.	HUB	ZyXEL	ES-116P	S060H02000215	FCC DoC	Provided by Lab
C.	iPod shuffle	Apple	MC749TA/A	CC4DMFKUDFDM	NA	Provided by Lab

Note:

1. All power cords of the above support units are non-shielded (1.8m).

ID	Descriptions	Qty.	Length (m)	Shielding (Yes/No)	Cores (Qty.)	Remarks
1.	RJ-45 Cable	1	10	No	0	Provided by Lab
2.	RJ-45 Cable	1	10	No	0	Provided by Lab
3.	DC Cable	1	1.0	No	0	Supplied by client
4.	AC Cable	1	1.5	No	0	Supplied by client
5.	USB Cable	1	0.1	Yes	0	Provided by Lab
6.	RJ-45 Cable	1	1.5	No	0	Provided by Lab

3.3.1 Configuration of System under Test

With adapter mode:

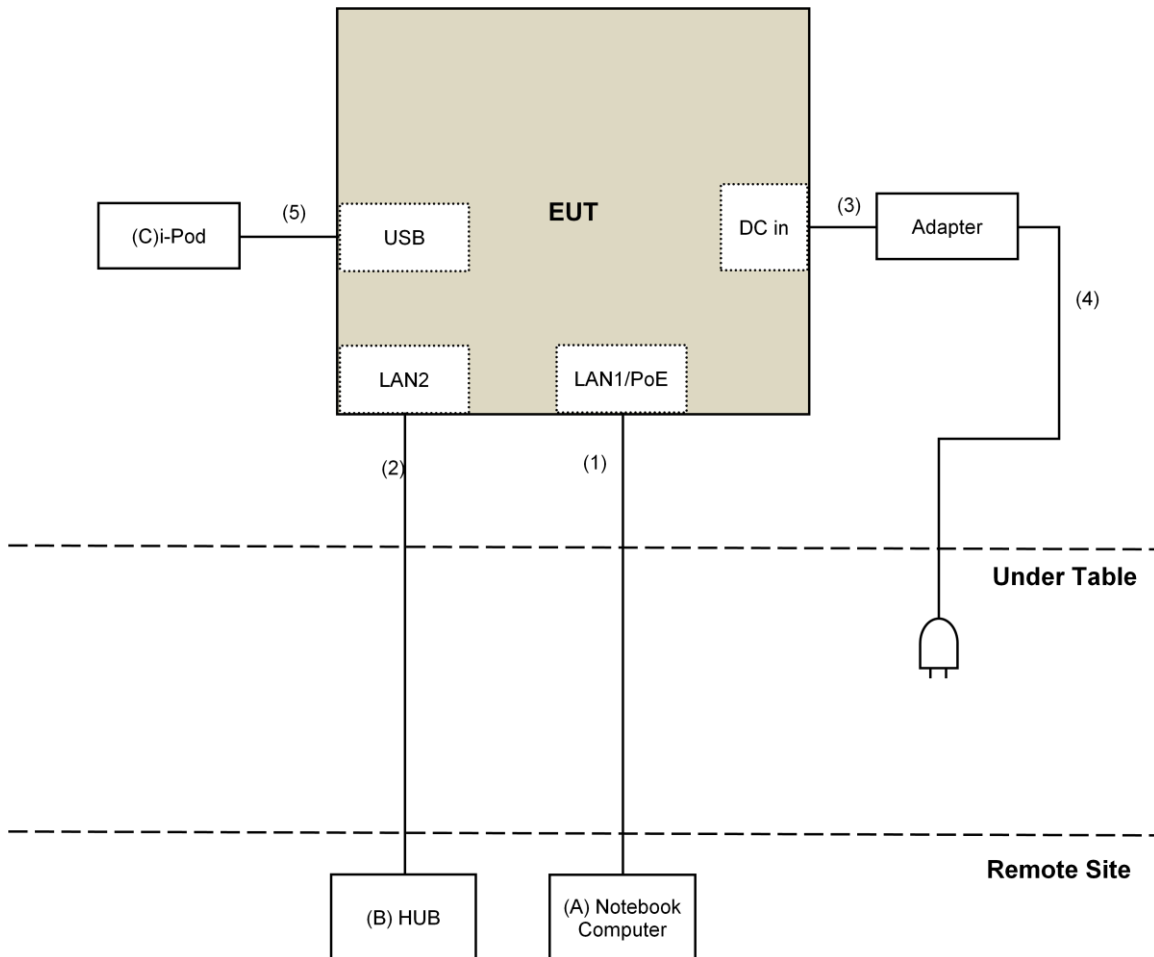

With POE mode:

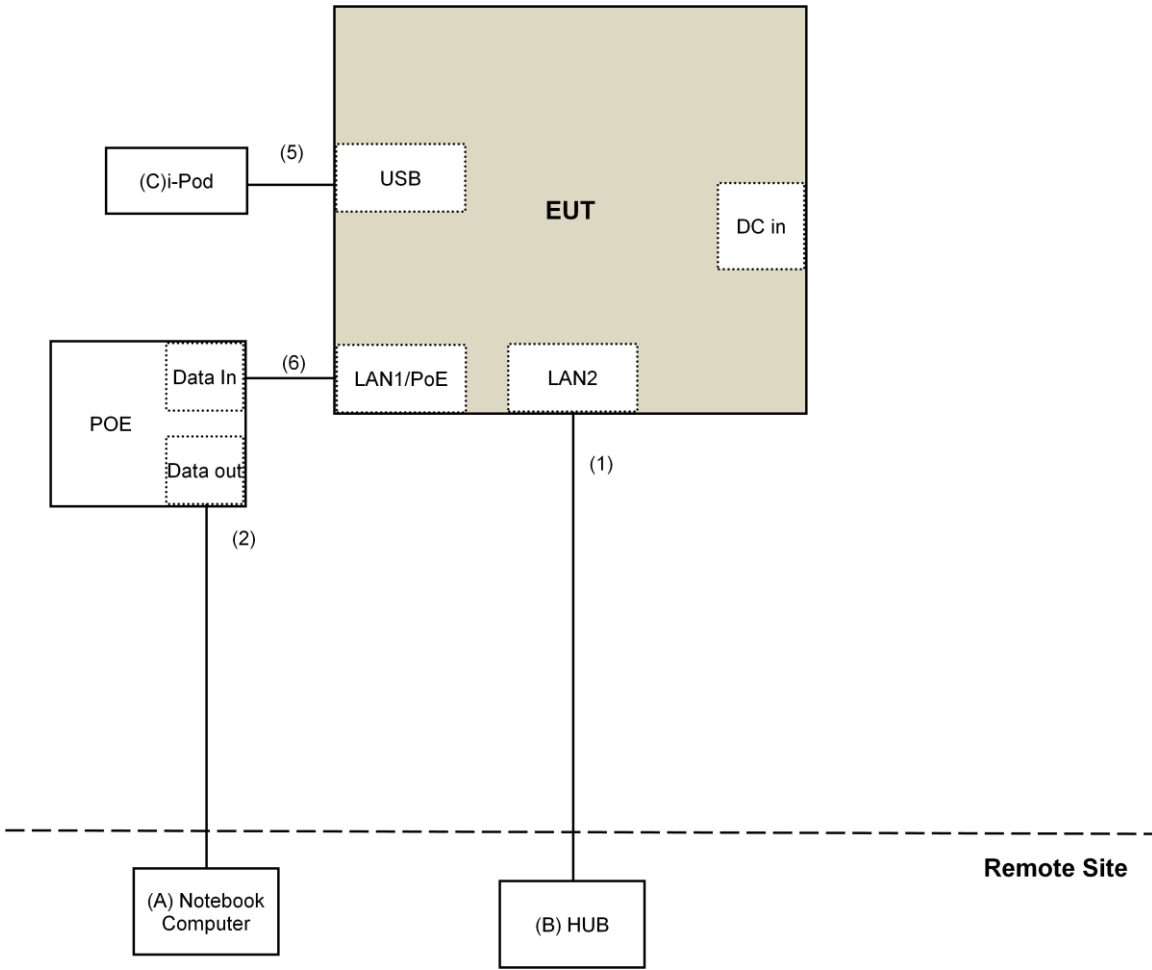



3.4 General Description of Applied Standards

The EUT is a RF Product. According to the specifications of the manufacturer, it must comply with the requirements of the following standards:

FCC Part 15, Subpart C (15.247)
ANSI C63.10-2013

All test items have been performed and recorded as per the above standards.

4 Test Types and Results

4.1 Radiated Emission and Bandedge Measurement

4.1.1 Limits of Radiated Emission and Bandedge Measurement

Radiated emissions which fall in the restricted bands must comply with the radiated emission limits specified as below table. Other emissions shall be at least 30dB below the highest level of the desired power:

Frequencies (MHz)	Field Strength (microvolts/meter)	Measurement Distance (meters)
0.009 ~ 0.490	2400/F(kHz)	300
0.490 ~ 1.705	24000/F(kHz)	30
1.705 ~ 30.0	30	30
30 ~ 88	100	3
88 ~ 216	150	3
216 ~ 960	200	3
Above 960	500	3

NOTE:

1. The lower limit shall apply at the transition frequencies.
2. Emission level (dBuV/m) = 20 log Emission level (uV/m).
3. For frequencies above 1000MHz, the field strength limits are based on average detector, however, the peak field strength of any emission shall not exceed the maximum permitted average limits, specified above by more than 20dB under any condition of modulation.

4.1.2 Test Instruments

DESCRIPTION & MANUFACTURER	MODEL NO.	SERIAL NO.	CALIBRATED DATE	CALIBRATED UNTIL
Pre-Amplifier ^(*) EMCI	EMC001340	980142	Jan. 20, 2016	Jan. 19, 2018
Loop Antenna ^(*) Electro-Metrics	EM-6879	264	Dec. 16, 2014	Dec. 15, 2016
RF Cable	NA	LOOPCAB-001 LOOPCAB-002	Jan. 18, 2016	Jan. 17, 2017
Pre-Amplifier Mini-Circuits	ZFL-1000VH2 B	AMP-ZFL-05	May 07, 2016	May 06, 2017
Trilog Broadband Antenna SCHWARZBECK	VULB 9168	9168-156	Jan. 04, 2016	Jan. 03, 2017
RF Cable	8D	966-3-1 966-3-2 966-3-3	Apr. 02, 2016	Apr. 01, 2017
Horn_Antenna SCHWARZBECK	BBHA9120-D	9120D-406	Jan. 20, 2016	Jan. 19, 2017
Pre-Amplifier Agilent	8449B	3008A02465	Apr. 05, 2016	Apr. 04, 2017
RF Cable	EMC104-SM- SM-2000 EMC104-SM- SM-5000 EMC104-SM- SM-5000	150317 150321 150322	Mar. 30, 2016	Mar. 29, 2017
Spectrum Analyzer Keysight	N9030A	MY54490520	July 29, 2016	July 28, 2017
Pre-Amplifier EMCI	EMC184045	980143	Jan. 15, 2016	Jan. 14, 2017
Horn_Antenna SCHWARZBECK	BBHA 9170	BBHA9170608	Jan. 08, 2016	Jan. 07, 2017
RF Cable	SUCOFLEX 102	36432/2 36441/2	Jan. 16, 2016	Jan. 15, 2017
Software	ADT_Radiated _V8.7.07	NA	NA	NA
Antenna Tower & Turn Table Max-Full	MF-7802	MF780208406	NA	NA
Boresight Antenna Fixture	FBA-01	FBA-SIP01	NA	NA
Spectrum Analyzer R&S	FSP40	100036	Jan. 27, 2016	Jan. 26, 2017

Note:

1. The calibration interval of the above test instruments is 12 months and the calibrations are traceable to NML/ROC and NIST/USA.
2. *The calibration interval of the above test instruments is 24 months and the calibrations are traceable to NML/ROC and NIST/USA.
3. Loop antenna was used for all emissions below 30 MHz.
4. The test was performed in 966 Chamber No. 3.
5. The FCC Site Registration No. is 147459
6. The CANADA Site Registration No. is 20331-1
7. Tested Date: Aug. 16 to 18, 2016

4.1.3 Test Procedures

- a. The EUT was placed on the top of a rotating table 0.8 meters (for below 1GHz) / 1.5 meters (for above 1GHz) above the ground at 3 meter chamber room for test. The table was rotated 360 degrees to determine the position of the highest radiation.
- b. The EUT was set 3 meters away from the interference-receiving antenna, which was mounted on the top of a variable-height antenna tower.
- c. The height of antenna is varied from one meter to four meters above the ground to determine the maximum value of the field strength. Both horizontal and vertical polarizations of the antenna are set to make the measurement.
- d. For each suspected emission, the EUT was arranged to its worst case and then the antenna was tuned to heights from 1 meter to 4 meters and the rotatable table was turned from 0 degrees to 360 degrees to find the maximum reading.
- e. The test-receiver system was set to quasi-peak detect function and specified bandwidth with maximum hold mode when the test frequency is below 1 GHz.
- f. The test-receiver system was set to peak and average detect function and specified bandwidth with maximum hold mode when the test frequency is above 1 GHz. If the peak reading value also meets average limit, measurement with the average detector is unnecessary.

Note:

1. The resolution bandwidth and video bandwidth of test receiver/spectrum analyzer is 120kHz for Quasi-peak detection (QP) at frequency below 1GHz.
2. The resolution bandwidth of test receiver/spectrum analyzer is 1 MHz and the video bandwidth is 3 MHz for Peak detection (PK) at frequency above 1GHz.
3. The resolution bandwidth of test receiver/spectrum analyzer is 1MHz and the video bandwidth is $\geq 1/T$ (Duty cycle < 98%) or 10Hz (Duty cycle $\geq 98\%$) for Average detection (AV) at frequency above 1GHz.
4. All modes of operation were investigated and the worst-case emissions are reported.

4.1.4 Deviation from Test Standard

No deviation.

4.1.5 Test Setup

<Frequency Range below 1GHz>

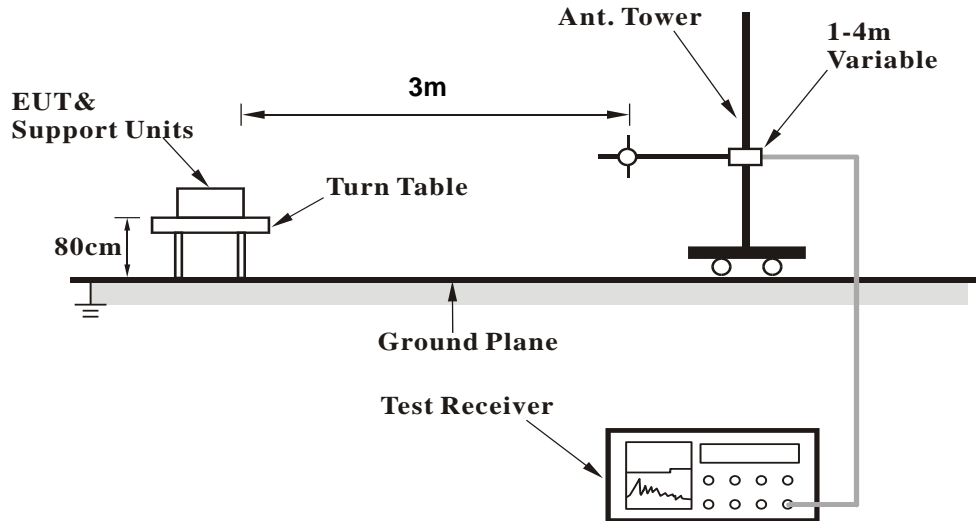

<Frequency Range above 1GHz>

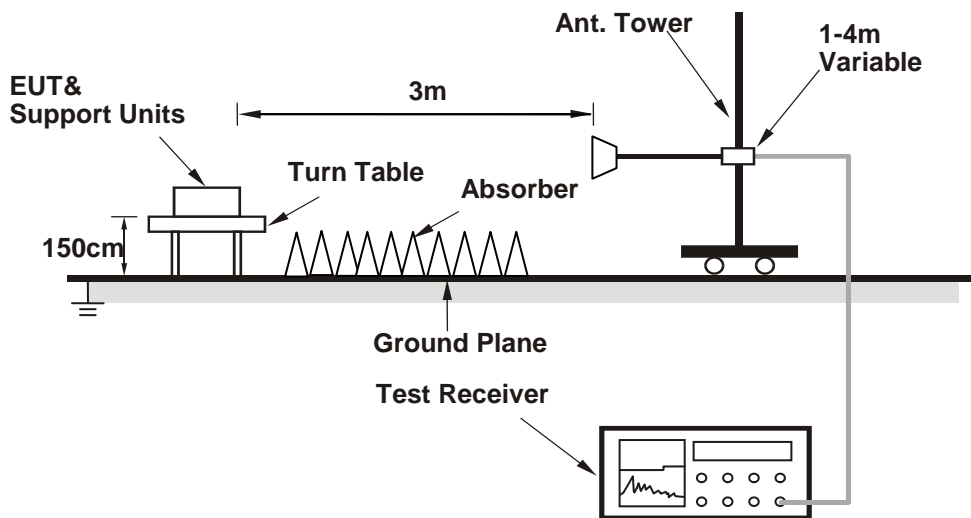

For the actual test configuration, please refer to the attached file (Test Setup Photo).

4.1.6 EUT Operating Conditions

- Connect the EUT with the support unit A (Notebook Computer) which is placed outside of testing area.
- The communication partner run test program "QRCT.exe[Ver3.0.174.0]" to enable EUT under transmission/receiving condition continuously at specific channel frequency.
- Support unit C (iPod shuffle) was connected to EUT via one USB cable to simulate real connection.

4.1.7 Test Results (Mode 1)

Above 1GHz Data:

FREQUENCY RANGE	1GHz ~40GHz	DETECTOR FUNCTION	Peak (PK) Average (AV)
------------------------	-------------	--------------------------	---------------------------

ANTENNA POLARITY & TEST DISTANCE: HORIZONTAL AT 3 M

NO.	FREQ. (MHz)	EMISSION LEVEL (dBuV/m)	LIMIT (dBuV/m)	MARGIN (dB)	ANTENNA HEIGHT (m)	TABLE ANGLE (Degree)	RAW VALUE (dBuV)	CORRECTION FACTOR (dB/m)
1	4874.00	45.4 PK	74.0	-28.6	1.02 H	132	42.9	2.5
2	4874.00	34.0 AV	54.0	-20.0	1.02 H	132	31.5	2.5
3	7311.00	49.1 PK	74.0	-24.9	2.12 H	225	40.2	8.9
4	7311.00	37.4 AV	54.0	-16.6	2.12 H	225	28.5	8.9
5	11590.00	53.3 PK	74.0	-20.7	1.22 H	209	38.2	15.1
6	11590.00	41.1 AV	54.0	-12.9	1.22 H	209	26.0	15.1
7	17385.00	59.6 PK	74.0	-14.4	3.36 H	257	39.0	20.6
8	17385.00	48.2 AV	54.0	-5.8	3.36 H	257	27.6	20.6

ANTENNA POLARITY & TEST DISTANCE: VERTICAL AT 3 M

NO.	FREQ. (MHz)	EMISSION LEVEL (dBuV/m)	LIMIT (dBuV/m)	MARGIN (dB)	ANTENNA HEIGHT (m)	TABLE ANGLE (Degree)	RAW VALUE (dBuV)	CORRECTION FACTOR (dB/m)
1	4874.00	45.8 PK	74.0	-28.2	1.00 V	151	43.3	2.5
2	4874.00	34.6 AV	54.0	-19.4	1.00 V	151	32.1	2.5
3	7311.00	48.0 PK	74.0	-26.0	1.50 V	196	39.1	8.9
4	7311.00	36.6 AV	54.0	-17.4	1.50 V	196	27.7	8.9
5	11590.00	50.0 PK	74.0	-24.0	1.25 V	172	34.9	15.1
6	11590.00	40.5 AV	54.0	-13.5	1.25 V	172	25.4	15.1
7	17385.00	60.4 PK	74.0	-13.6	2.10 V	210	39.8	20.6
8	17385.00	47.0 AV	54.0	-7.0	2.10 V	210	26.4	20.6

REMARKS:

1. Emission Level(dBuV/m) = Raw Value(dBuV) + Correction Factor(dB/m)
2. Correction Factor(dB/m) = Antenna Factor(dB/m) + Cable Factor(dB) – Pre-Amplifier Factor(dB)
3. The other emission levels were very low against the limit.
4. Margin value = Emission Level – Limit value

Below 1GHz Data:

FREQUENCY RANGE	Below 1GHz	DETECTOR FUNCTION	Quasi-Peak (QP)
------------------------	------------	--------------------------	-----------------

ANTENNA POLARITY & TEST DISTANCE: HORIZONTAL AT 3 M								
NO.	FREQ. (MHz)	EMISSION LEVEL (dBUV/m)	LIMIT (dBUV/m)	MARGIN (dB)	ANTENNA HEIGHT (m)	TABLE ANGLE (Degree)	RAW VALUE (dBUV)	CORRECTION FACTOR (dB/m)
1	80.71	31.7 QP	40.0	-8.3	2.00 H	199	44.6	-12.9
2	153.72	40.0 QP	43.5	-3.5	2.00 H	87	48.3	-8.3
3	216.83	38.1 QP	46.0	-7.9	1.50 H	180	49.4	-11.3
4	257.96	36.8 QP	46.0	-9.2	1.00 H	271	46.0	-9.2
5	375.02	40.0 QP	46.0	-6.0	1.00 H	217	45.5	-5.5
6	500.03	37.9 QP	46.0	-8.1	2.00 H	181	40.2	-2.3

ANTENNA POLARITY & TEST DISTANCE: VERTICAL AT 3 M								
NO.	FREQ. (MHz)	EMISSION LEVEL (dBUV/m)	LIMIT (dBUV/m)	MARGIN (dB)	ANTENNA HEIGHT (m)	TABLE ANGLE (Degree)	RAW VALUE (dBUV)	CORRECTION FACTOR (dB/m)
1	52.85	36.4 QP	40.0	-3.6	1.00 V	238	44.7	-8.3
2	73.50	36.5 QP	40.0	-3.5	1.00 V	205	47.6	-11.1
3	125.00	34.9 QP	43.5	-8.6	1.00 V	236	45.4	-10.5
4	154.92	35.4 QP	43.5	-8.1	1.00 V	161	43.8	-8.4
5	375.02	35.4 QP	46.0	-10.6	1.00 V	328	40.9	-5.5
6	500.00	33.7 QP	46.0	-12.3	1.00 V	56	36.0	-2.3

REMARKS:

1. Emission Level(dBUV/m) = Raw Value(dBUV) + Correction Factor(dB/m)
2. Correction Factor(dB/m) = Antenna Factor(dB/m) + Cable Factor(dB) – Pre-Amplifier Factor(dB)
3. The other emission levels were very low against the limit.
4. Margin value = Emission Level – Limit value

4.1.8 Test Results (Mode 2)
Below 1GHz Data:

FREQUENCY RANGE	Below 1GHz	DETECTOR FUNCTION	Quasi-Peak (QP)
------------------------	------------	--------------------------	-----------------

ANTENNA POLARITY & TEST DISTANCE: HORIZONTAL AT 3 M

NO.	FREQ. (MHz)	EMISSION LEVEL (dBuV/m)	LIMIT (dBuV/m)	MARGIN (dB)	ANTENNA HEIGHT (m)	TABLE ANGLE (Degree)	RAW VALUE (dBuV)	CORRECTION FACTOR (dB/m)
1	66.44	31.8 QP	40.0	-8.2	1.00 H	340	41.6	-9.8
2	93.45	30.8 QP	43.5	-12.7	1.00 H	200	44.7	-13.9
3	209.22	33.9 QP	43.5	-9.6	1.00 H	211	45.3	-11.4
4	236.10	36.5 QP	46.0	-9.5	1.00 H	202	46.7	-10.2
5	330.62	36.5 QP	46.0	-9.5	1.50 H	110	43.0	-6.5
6	370.10	33.8 QP	46.0	-12.2	1.00 H	280	39.4	-5.6

ANTENNA POLARITY & TEST DISTANCE: VERTICAL AT 3 M

NO.	FREQ. (MHz)	EMISSION LEVEL (dBuV/m)	LIMIT (dBuV/m)	MARGIN (dB)	ANTENNA HEIGHT (m)	TABLE ANGLE (Degree)	RAW VALUE (dBuV)	CORRECTION FACTOR (dB/m)
1	40.54	38.8 QP	40.0	-1.2	1.00 V	100	47.8	-9.0
2	66.40	35.8 QP	40.0	-4.2	1.50 V	210	45.6	-9.8
3	125.11	33.8 QP	43.5	-9.7	1.00 V	114	44.3	-10.5
4	146.34	32.4 QP	43.5	-11.1	1.40 V	120	41.0	-8.6
5	329.77	30.5 QP	46.0	-15.5	1.00 V	112	37.0	-6.5
6	625.11	30.4 QP	46.0	-15.6	1.50 V	160	30.0	0.4

4.2 Conducted Emission Measurement

4.2.1 Limits of Conducted Emission Measurement

Frequency (MHz)	Conducted Limit (dBuV)	
	Quasi-peak	Average
0.15 - 0.5	66 - 56	56 - 46
0.50 - 5.0	56	46
5.0 - 30.0	60	50

Note: 1. The lower limit shall apply at the transition frequencies.

2. The limit decreases in line with the logarithm of the frequency in the range of 0.15 to 0.50MHz.

4.2.2 Test Instruments

DESCRIPTION & MANUFACTURER	MODEL NO.	SERIAL NO.	CALIBRATED DATE	CALIBRATED UNTIL
Test Receiver R&S	ESCS 30	847124/029	Oct. 23, 2015	Oct. 22, 2016
Line-Impedance Stabilization Network (for EUT) R&S	ESH3-Z5	848773/004	Oct. 28, 2015	Oct. 27, 2016
RF Cable	5D-FB	COACAB-002	Mar. 04, 2016	Mar. 03, 2017
10 dB PAD Mini-Circuits	HAT-10+	CONATT-004	Jun. 20, 2016	Jun. 19, 2017
Software BVADT	BVADT_Cond_ V7.3.7.3	NA	NA	NA

Note:

1. The calibration interval of the above test instruments are 12 months and the calibrations are traceable to NML/ROC and NIST/USA.
2. The test was performed in Shielded Room No. 1.
- 3 Tested Date: June 21 to Aug. 16, 2016

4.2.3 Test Procedures

- a. The EUT was placed 0.4 meters from the conducting wall of the shielded room with EUT being connected to the power mains through a line impedance stabilization network (LISN). Other support units were connected to the power mains through another LISN. The two LISNs provide 50 ohm/ 50uH of coupling impedance for the measuring instrument.
- b. Both lines of the power mains connected to the EUT were checked for maximum conducted interference.
- c. The frequency range from 150kHz to 30MHz was searched. Emission levels under (Limit - 20dB) was not recorded.

NOTE: The resolution bandwidth and video bandwidth of test receiver is 9kHz for quasi-peak detection (QP) and average detection (AV) at frequency 0.15MHz-30MHz.

4.2.4 Deviation from Test Standard

No deviation.

4.2.5 Test Setup

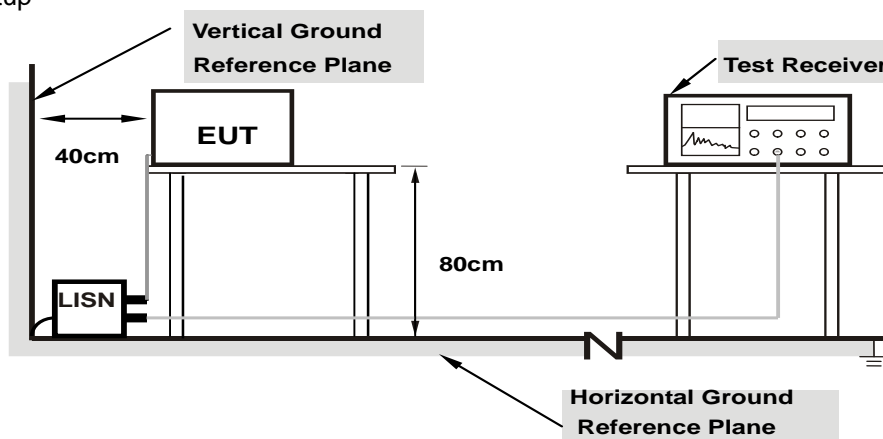

Note: 1.Support units were connected to second LISN.

For the actual test configuration, please refer to the attached file (Test Setup Photo).

4.2.6 EUT Operating Conditions

Same as 4.1.6.

4.2.7 Test Results (Mode 1)

Phase	Line (L)	Detector Function	Quasi-Peak (QP) / Average (AV)
-------	----------	-------------------	--------------------------------

Phase Of Power : Line (L)										
No	Frequency (MHz)	Correction Factor (dB)	Reading Value (dBuV)		Emission Level (dBuV)		Limit (dBuV)		Margin (dB)	
			Q.P.	AV.	Q.P.	AV.	Q.P.	AV.	Q.P.	AV.
1	0.15391	10.21	32.97	22.59	43.18	32.80	65.79	55.79	-22.61	-22.99
2	0.22812	10.22	31.97	24.34	42.19	34.56	62.52	52.52	-20.33	-17.96
3	0.25938	10.22	31.10	26.58	41.32	36.80	61.45	51.45	-20.13	-14.65
4	0.73984	10.24	18.98	10.13	29.22	20.37	56.00	46.00	-26.78	-25.63
5	7.17969	10.46	22.99	17.42	33.45	27.88	60.00	50.00	-26.55	-22.12
6	24.00000	11.43	33.77	33.77	45.20	45.20	60.00	50.00	-14.80	-4.80

Remarks:

1. Q.P. and AV. are abbreviations of quasi-peak and average individually.
2. The emission levels of other frequencies were very low against the limit.
3. Margin value = Emission level – Limit value
4. Correction factor = Insertion loss + Cable loss
5. Emission Level = Correction Factor + Reading Value

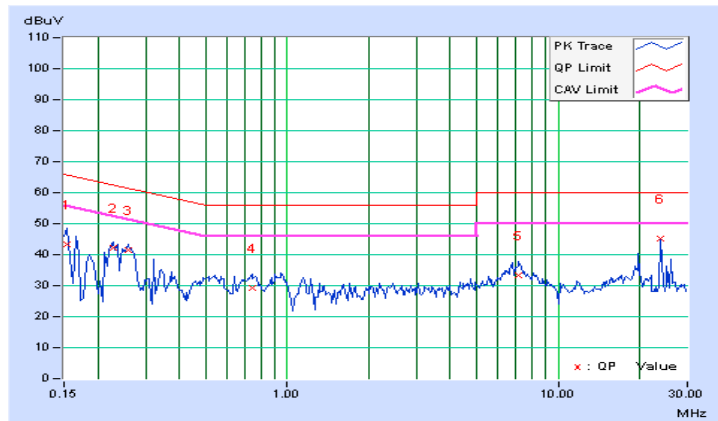

Phase	Neutral (N)	Detector Function	Quasi-Peak (QP) / Average (AV)
-------	-------------	-------------------	--------------------------------

Phase Of Power : Neutral (N)										
No	Frequency (MHz)	Correction Factor (dB)	Reading Value (dBuV)		Emission Level (dBuV)		Limit (dBuV)		Margin (dB)	
			Q.P.	AV.	Q.P.	AV.	Q.P.	AV.	Q.P.	AV.
1	0.15000	10.19	34.49	25.09	44.68	35.28	66.00	56.00	-21.32	-20.72
2	0.22594	10.21	32.19	25.31	42.40	35.52	62.60	52.60	-20.20	-17.08
3	0.25938	10.21	31.19	26.82	41.40	37.03	61.45	51.45	-20.05	-14.42
4	0.73984	10.22	18.72	10.21	28.94	20.43	56.00	46.00	-27.06	-25.57
5	6.97656	10.37	22.47	16.98	32.84	27.35	60.00	50.00	-27.16	-22.65
6	24.00000	11.13	33.77	33.04	44.90	44.17	60.00	50.00	-15.10	-5.83

Remarks:

1. Q.P. and AV. are abbreviations of quasi-peak and average individually.
2. The emission levels of other frequencies were very low against the limit.
3. Margin value = Emission level – Limit value
4. Correction factor = Insertion loss + Cable loss
5. Emission Level = Correction Factor + Reading Value

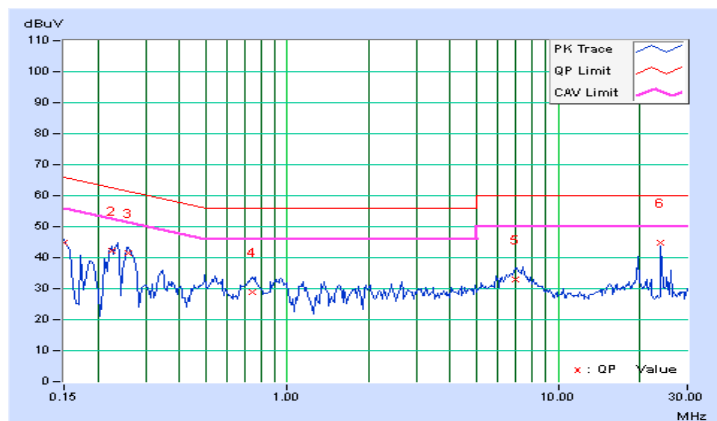

4.2.8 Test Results (Mode 2)

Phase	Line (L)	Detector Function	Quasi-Peak (QP) / Average (AV)
-------	----------	-------------------	--------------------------------

Phase Of Power : Line (L)										
No	Frequency (MHz)	Correction Factor (dB)	Reading Value (dBuV)		Emission Level (dBuV)		Limit (dBuV)		Margin (dB)	
			Q.P.	AV.	Q.P.	AV.	Q.P.	AV.	Q.P.	AV.
1	0.15391	10.21	41.65	28.33	51.86	38.54	65.79	55.79	-13.93	-17.25
2	0.19297	10.22	36.35	22.09	46.57	32.31	63.91	53.91	-17.34	-21.60
3	0.27109	10.22	28.05	14.79	38.27	25.01	61.08	51.08	-22.81	-26.07
4	0.59531	10.23	19.82	13.84	30.05	24.07	56.00	46.00	-25.95	-21.93
5	15.16797	11.07	19.66	14.65	30.73	25.72	60.00	50.00	-29.27	-24.28
6	25.23047	11.45	23.72	21.22	35.17	32.67	60.00	50.00	-24.83	-17.33

Remarks:

1. Q.P. and AV. are abbreviations of quasi-peak and average individually.
2. The emission levels of other frequencies were very low against the limit.
3. Margin value = Emission level – Limit value
4. Correction factor = Insertion loss + Cable loss
5. Emission Level = Correction Factor + Reading Value

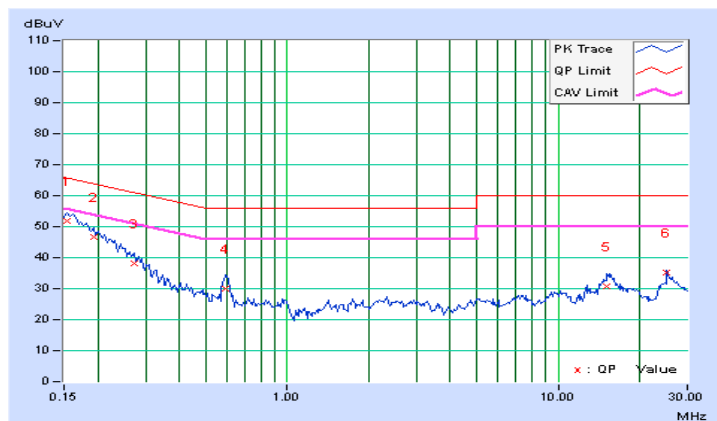

Phase	Neutral (N)	Detector Function	Quasi-Peak (QP) / Average (AV)
-------	-------------	-------------------	--------------------------------

Phase Of Power : Neutral (N)										
No	Frequency (MHz)	Correction Factor (dB)	Reading Value (dBuV)		Emission Level (dBuV)		Limit (dBuV)		Margin (dB)	
			Q.P.	AV.	Q.P.	AV.	Q.P.	AV.	Q.P.	AV.
1	0.16172	10.19	40.55	26.62	50.74	36.81	65.38	55.38	-14.63	-18.56
2	0.19297	10.21	36.23	21.99	46.44	32.20	63.91	53.91	-17.47	-21.71
3	0.27109	10.21	27.88	15.07	38.09	25.28	61.08	51.08	-23.00	-25.81
4	0.59922	10.21	18.82	13.24	29.03	23.45	56.00	46.00	-26.97	-22.55
5	15.48047	10.91	21.93	17.85	32.84	28.76	60.00	50.00	-27.16	-21.24
6	25.23047	11.13	24.10	21.72	35.23	32.85	60.00	50.00	-24.77	-17.15

Remarks:

1. Q.P. and AV. are abbreviations of quasi-peak and average individually.
2. The emission levels of other frequencies were very low against the limit.
3. Margin value = Emission level – Limit value
4. Correction factor = Insertion loss + Cable loss
5. Emission Level = Correction Factor + Reading Value

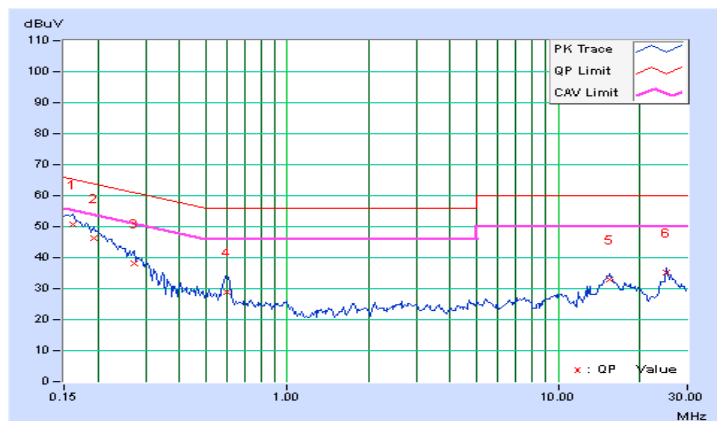

4.3 Conducted Out of Band Emission Measurement

4.3.1 Limits of Conducted Out of Band Emission Measurement

Below 30dB of the highest emission level of operating band (in 100kHz Resolution Bandwidth).

4.3.2 Test Setup

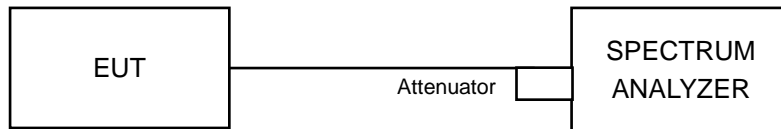

4.3.3 Test Instruments

Refer to section 4.1.2 to get information of above instrument.

4.3.4 Test Procedure

MEASUREMENT PROCEDURE REF

1. Set the RBW = 100 kHz.
2. Set the VBW \geq 300 kHz.
3. Detector = peak.
4. Sweep time = auto couple.
5. Trace mode = max hold.
6. Allow trace to fully stabilize.
7. Use the peak marker function to determine the maximum power level in any 100 kHz band segment within the fundamental EBW.

MEASUREMENT PROCEDURE OOBE

1. Set RBW = 100 kHz.
2. Set VBW \geq 300 kHz.
3. Detector = peak.
4. Sweep = auto couple.
5. Trace Mode = max hold.
6. Allow trace to fully stabilize.
7. Use the peak marker function to determine the maximum amplitude level.

4.3.5 Deviation from Test Standard

No deviation.

4.3.6 EUT Operating Condition

Same as Item 4.3.6

4.3.7 Test Results (Overall Spurious Emission Test)

The spectrum plots are attached on the following pages. D1 line indicates the highest level, and D2 line indicates the 30dB offset below D1. It shows compliance with the requirement.

2.4GHz 802.11g CH 6 + 5GHz 802.11ac(VHT20) CH 165

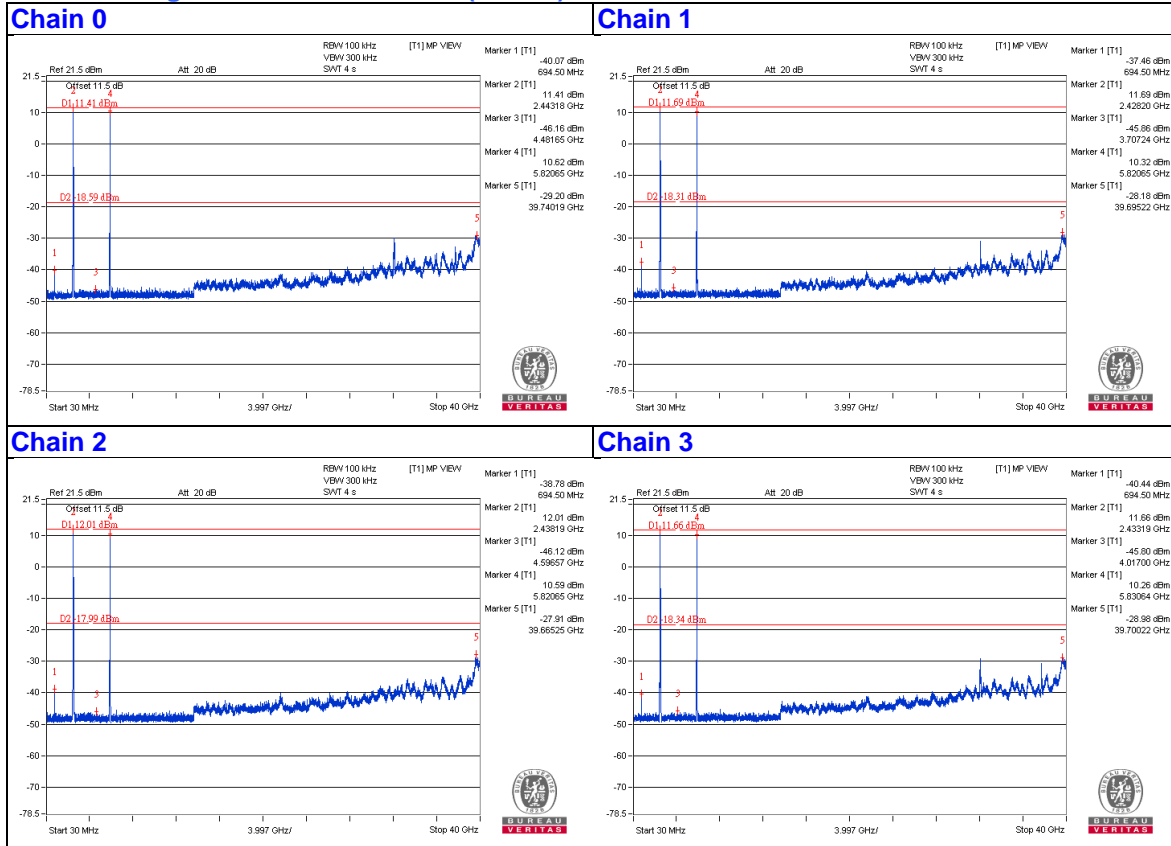



5 Pictures of Test Arrangements

Please refer to the attached file (Test Setup Photo).

Appendix – Information on the Testing Laboratories

We, Bureau Veritas Consumer Products Services (H.K.) Ltd., Taoyuan Branch, were founded in 1988 to provide our best service in EMC, Radio, Telecom and Safety consultation. Our laboratories are accredited and approved according to ISO/IEC 17025.

If you have any comments, please feel free to contact us at the following:

Linko EMC/RF Lab

Tel: 886-2-26052180

Fax: 886-2-26051924

Hsin Chu EMC/RF/Telecom Lab

Tel: 886-3-6668565

Fax: 886-3-6668323

Hwa Ya EMC/RF/Safety Lab

Tel: 886-3-3183232

Fax: 886-3-3270892

Email: service.adt@tw.bureauveritas.com

Web Site: www.bureauveritas-adt.com

The address and road map of all our labs can be found in our web site also.

--- END ---