

DFS MEASUREMENT REPORT

FCC PART 15 Subpart E & IC RSS-247

FCC ID: 2AD8UFZCWI2B1
IC: 109D-FZCWI2B1
Applicant: Nokia Solutions and Networks, OY

Application Type: Certification
Product: AC220i Wi-Fi AP ID omni antenna US
Model No.: WI2B-AC220i
Brand Name: NOKIA
FCC Classification: Unlicensed National Information Infrastructure (UNII)
FCC Rule Part(s): Part 15 Subpart E - 15.407 Section (h)(2)
KDB 905462 D02v02, KDB 905462 D04v01

Type of Device: Master Device
 Client Device (No radar detection)
 Client Device with radar detection

Test Date: December 13 ~ 18, 2018

Reviewed By:



(Paddy Chen)

Approved By:



(Chenz Ker)



Testing Laboratory
3261

The test results relate only to the samples tested.

This equipment has been shown to be capable of compliance with the applicable technical standards as indicated in the measurement report and was tested in accordance with the measurement procedures specified in KDB 905462 D02v02. Test results reported herein relate only to the item(s) tested.

The test report shall not be reproduced except in full without the written approval of MRT Technology (Taiwan) Co., Ltd.

Revision History

Report No.	Version	Description	Issue Date	Note
1812TW0111-U1	Rev. 01	Initial Report	01-11-2019	Valid

This report is supplemented to MRT Original "1708TW0101-U6" Report adding "MESH mode" and related data

CONTENTS

Description	Page
Revision History	2
§2.1033 General Information	5
1. INTRODUCTION	6
1.1. Scope	6
1.2. MRT Test Location	6
2. PRODUCT INFORMATION	7
2.1. Equipment Description.....	7
2.2. Description of Available Antennas.....	8
2.3. Description of Antenna RF Port	9
2.4. DFS Band Carrier Frequencies Operation	10
2.5. Test Mode	10
2.6. Configuration of Mesh Mode.....	11
3. DFS DETECTION THRESHOLDS AND RADAR TEST WAVEFORMS	12
3.1. Applicability	12
3.2. DFS Devices Requirements.....	13
3.3. DFS Detection Threshold Values	14
3.4. Parameters of DFS Test Signals	15
3.5. Radiated Test Setup	18
4. TEST EQUIPMENT CALIBRATION DATE	19
5. TEST RESULT	20
5.1. Summary	20
5.2. Radar Waveform Calibration.....	21
5.2.1. Calibration Setup	21
5.2.2. Calibration Procedure	21
5.2.3. Cablibration Result	22
5.2.4. Channel Loading Test Result	26
5.3. UNII Detection Bandwidth Measurement	27
5.3.1. Test Limit	27
5.3.2. Test Procedure	27
5.3.3. Test Result.....	28
5.4. Statistical Performance Check Measurement.....	31
5.4.1. Test Limit	31
5.4.2. Test Procedure	31

5.4.3. Test Result..... 32

6. CONCLUSION.....115

§2.1033 General Information

Applicant:	Nokia Solutions and Networks, OY
Applicant Address:	2000 W. Lucent Lane, Naperville, Illinois, United States, 60563
Manufacturer:	Nokia Solutions and Networks, OY
Manufacturer Address:	2000 W. Lucent Lane, Naperville, Illinois, United States, 60563
Test Site:	MRT Technology (Taiwan) Co., Ltd
Test Site Address:	No. 38, Fuxing Second Rd., Guishan Dist., Taoyuan City 333, Taiwan (R.O.C)
MRT Registration No.:	153292
MRT IC Registration No.:	21723-1
Test Device Serial No.:	NH1739000044 <input checked="" type="checkbox"/> Production <input type="checkbox"/> Pre-Production <input type="checkbox"/> Engineering

Test Facility / Accreditations

Measurements were performed at MRT Laboratory located in Fuxing Rd., Taoyuan, Taiwan (R.O.C)

- MRT facility is a FCC registered (Reg. No. 153292) test facility with the site description report on file and is designated by the FCC as an Accredited Test Film.
- MRT facility is an IC registered (MRT Reg. No. 21723-1) test laboratory with the site description on file at Industry Canada.
- MRT Lab is accredited to ISO 17025 by the American Association for Laboratory Accreditation (TAF) under the American Association for Laboratory Accreditation Program (TAF Cert. No. 3261) in EMC, Telecommunications and Radio testing for FCC, Industry Taiwan, EU and TELEC Rules.

1. INTRODUCTION

1.1. Scope

Measurement and determination of electromagnetic emissions (EMC) of radio frequency devices including intentional and/or unintentional radiators for compliance with the technical rules and regulations of the Federal Communications Commission and the Industry Canada Certification and Engineering Bureau.

1.2. MRT Test Location

The map below shows the location of the MRT LABORATORY, its proximity to the Taoyuan City. These measurement tests were conducted at the MRT Technology (Taiwan) Co., Ltd. Facility located at No.38, Fuxing 2nd Rd., Guishan Dist., Taoyuan City 33377, Taiwan (R.O.C).

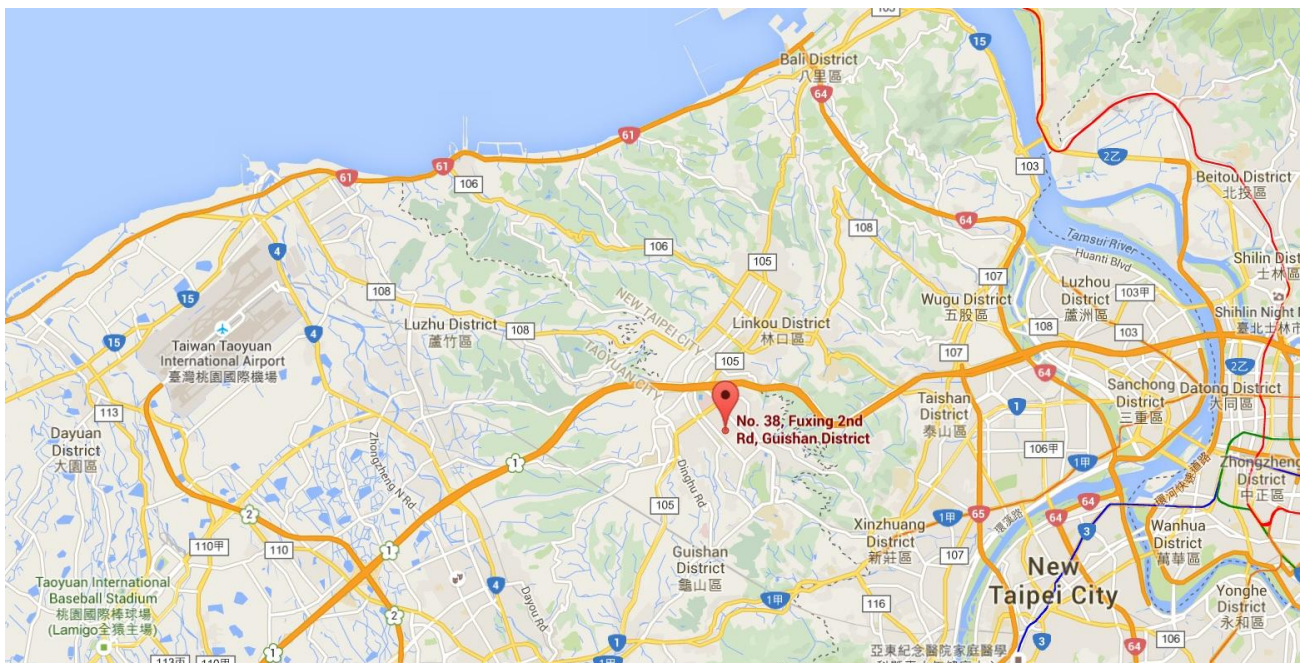

2. PRODUCT INFORMATION

2.1. Equipment Description

Product Name	AC220i Wi-Fi AP ID omni antenna US
Model No.	WI2B-AC220i
Brand Name:	NOKIA
Test Device Serial No.	NH1739000044
Software Version	NWF.5D.12
Wi-Fi Specification:	802.11a/b/g/n/ac
Frequency Range	<p><u>2.4GHz:</u> For 802.11b/g/n-HT20: 2412 ~ 2462 MHz For 802.11n-HT40: 2422 ~ 2452 MHz</p> <p><u>5GHz:</u> For 802.11a/n-HT20/ac-VHT20:5180~5320MHz, 5500~5720MHz, 5745~5825MHz For 802.11n-HT40/ac-VHT40:5190~5310MHz, 5510~5710MHz, 5755~5795MHz For 802.11ac-VHT80:5210MHz, 5290MHz, 5530MHz, 5610MHz, 5690MHz, 5775MHz</p>
Type of Modulation	802.11a/n/ac: OFDM;
Modulation Type	16QAM, 64QAM, QPSK, BPSK for OFDM 802.11a/n/ac: OFDM
Power-on cycle	Requires 45.3 seconds to complete its power-on cycle
Uniform Spreading (For DFS Frequency Band)	For the 5250-5350MHz, 5470-5725 MHz bands, the Master device provides, on aggregate, uniform loading of the spectrum across all devices by selecting an operating channel among the available channels using a random algorithm.

2.2. Description of Available Antennas

Antenna Type	Frequency Band (MHz)	TX Paths	Per Chain Max Antenna Gain (dBi)		Beam Forming Directional Gain (dBi)	CDD Directional Gain(dBi)	
			Ant 1	Ant 2		For Power	For PSD
Omni Antenna	2412 ~ 2462	2	3.5	4.0	6.76	4.00	6.76
	5150 ~ 5250	2	3.8	3.6	6.71	3.80	6.71
	5250 ~ 5350	2	4.0	3.6	6.81	4.00	6.81
	5470 ~ 5725	2	5.1	3.9	7.53	5.10	7.53
	5725 ~ 5850	2	5.2	4.3	7.77	5.20	7.77

Note:

1. The EUT supports Cyclic Delay Diversity (CDD) mode, and CDD signals are correlated. For CDD transmissions, directional gain is calculated as follows, $N_{ANT} = 2$, $N_{SS} = 1$.
 - 1) If all antennas have the same gain, G_{ANT} , Directional gain = $G_{ANT} + \text{Array Gain}$, where Array Gain is as follows.
 - For power spectral density (PSD) measurements on all devices, Array Gain = $10 \log(N_{ANT}/N_{SS})$ dB = 3.01;
 - For power measurements on IEEE 802.11 devices, Array Gain = 0 dB for $N_{ANT} \leq 4$;
 - 2) If antenna gains are not equal, the user may use either of the following methods to calculate directional gain, provided that each transmit antenna is driven by only one spatial stream:
 - Directional gain may be calculated by using the formulas applicable to equal gain antennas with G_{ANT} set equal to the gain of the antenna having the highest gain;

$$\bullet \text{ DirectionalGain} = 10 \cdot \log \left[\frac{\sum_{j=1}^{N_{SS}} \left\{ \sum_{k=1}^{N_{ANT}} g_{j,k} \right\}^2}{N_{ANT}} \right]$$

$g_{j,k} = 10^{G_k/20}$ if the kth antenna is being fed by spatial stream j, or zero if it is not;

G_k is the gain in dBi of the kth antenna.

2. The EUT also supports Beam Forming mode, and the Beam Forming support 802.11n, not include 802.11a/ac.

Correlated signals include, but are not limited to, signals transmitted in any of the following modes:

- Any transmit Beam Forming mode, whether fixed or adaptive (e.g., phased array modes, closed loop MIMO modes, Transmitter Adaptive Antenna modes, Maximum Ratio Transmission (MRT) modes, and Statistical Eigen Beam Forming (EBF) modes).

Unequal antenna gains, with equal transmit powers. For antenna gains given by G_1, G_2, \dots, G_N dBi.

- transmit signals are correlated, then
- Directional gain = $10 \cdot \log[(10^{G_1/20} + 10^{G_2/20} + \dots + 10^{G_N/20})^2 / N_{ANT}]$ dBi [Note the “20”s in the denominator of each exponent and the square of the sum of terms; the object is to combine the signal levels coherently.]

2.3. Description of Antenna RF Port

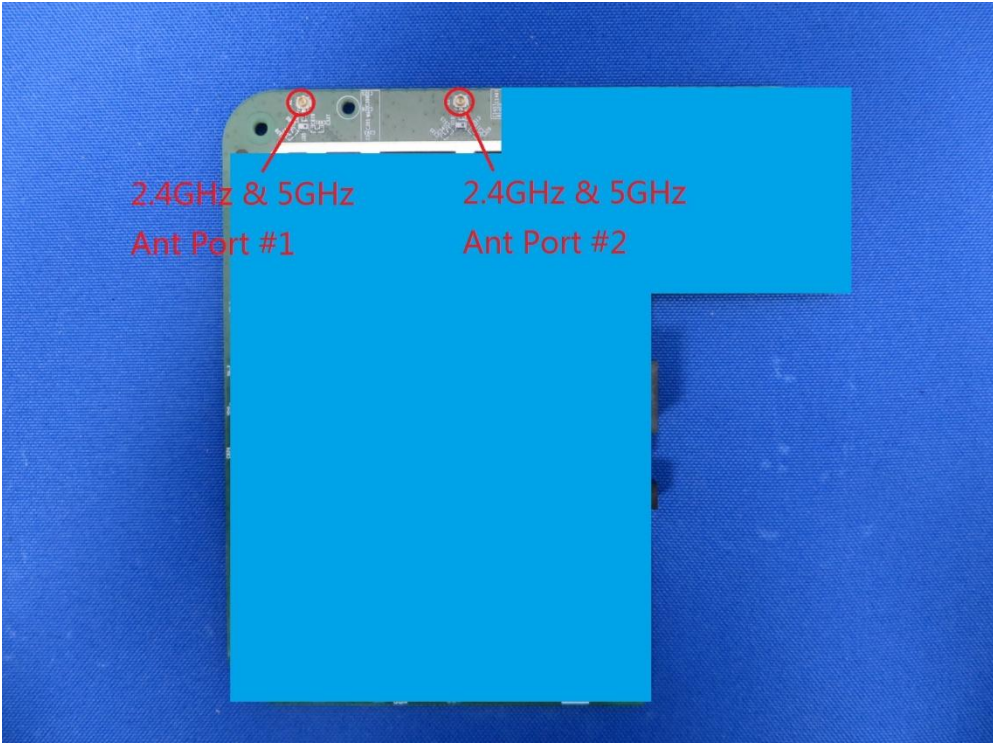
Antenna RF Port				
--	2.4GHz RF Port		5GHz RF Port	
Software Control Port	Ant 1	Ant 2	Ant 1	Ant 2
 <p>The photograph shows a blue PCB antenna array. Two ports are highlighted with red circles and arrows. The left port is labeled '2.4GHz & 5GHz Ant Port #1' and the right port is labeled '2.4GHz & 5GHz Ant Port #2'. The antenna array is mounted on a blue background.</p>				

2.4. DFS Band Carrier Frequencies Operation

802.11 a/n-HT20/ac-VHT20 Center Working Frequency of Each Channel

Channel	Frequency	Channel	Frequency	Channel	Frequency
52	5260 MHz	56	5280 MHz	60	5300 MHz
64	5320 MHz	100	5500 MHz	104	5520 MHz
108	5540 MHz	112	5560 MHz	116	5580 MHz
120	5600 MHz	124	5620 MHz	128	5640 MHz
132	5660 MHz	136	5680 MHz	140	5700 MHz
144	5720 MHz	--	--	--	--

802.11n-HT40/ ac-VHT40 Center Working Frequency of Each Channel

Channel	Frequency	Channel	Frequency	Channel	Frequency
54	5270 MHz	62	5310 MHz	102	5510 MHz
110	5550 MHz	118	5590 MHz	126	5630 MHz
134	5670 MHz	--	--	--	--

802.11ac-VHT80 Center Working Frequency of Each Channel

Channel	Frequency	Channel	Frequency	Channel	Frequency
58	5290 MHz	106	5530 MHz	122	5610 MHz
138	5690 MHz	--	--	--	--

Note: The device can't operate in 5600~5650 MHz band in Canada (The frequency of blue font).

2.5. Test Mode

Test Mode	Mode 1: Communication with client device by MESH mode
-----------	---

2.6. Configuration of Mesh Mode

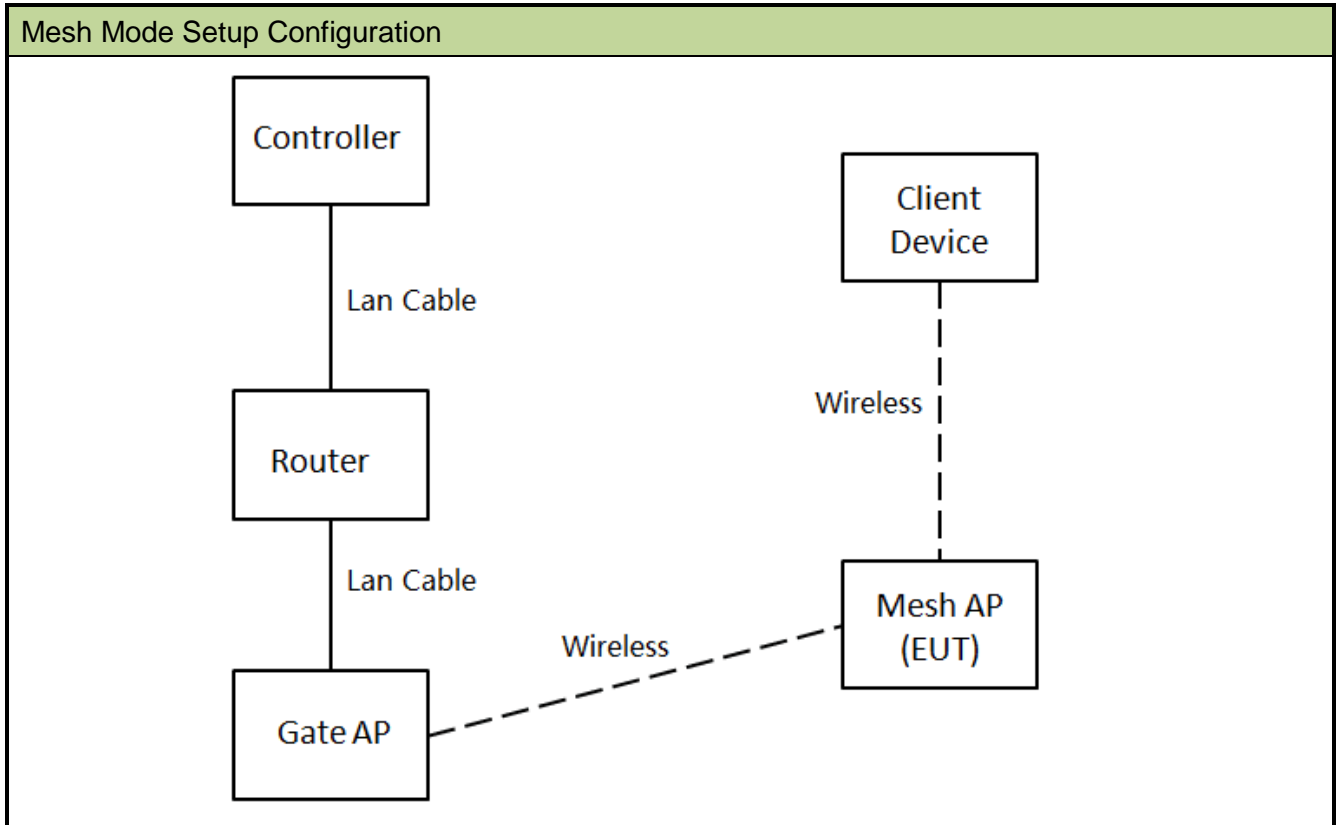

3. DFS DETECTION THRESHOLDS AND RADAR TEST WAVEFORMS

3.1. Applicability

The following table from FCC KDB 905462 D02 UNII DFS Compliance Procedures New Rules v02 lists the applicable requirements for the DFS testing.

Requirement	Operational Mode		
	Master	Client Without Radar Detection	Client With Radar Detection
Non-Occupancy Period	Yes	Not required	Yes
DFS Detection Threshold	Yes	Not required	Yes
Channel Availability Check Time	Yes	Not required	Not required
U-NII Detection Bandwidth	Yes	Not required	Yes

Table 3-1: Applicability of DFS Requirements Prior to Use of a Channel

Requirement	Operational Mode	
	Master Device or Client With Radar Detection	Client Without Radar Detection
DFS Detection Threshold	Yes	Not required
Channel Closing Transmission Time	Yes	Yes
Channel Move Time	Yes	Yes
U-NII Detection Bandwidth	Yes	Not required

Additional requirements for devices with multiple bandwidth modes	Master Device or Client with Radar Detection	Client Without Radar Detection
U-NII Detection Bandwidth and Statistical Performance Check	All BW modes must be tested	Not required
Channel Move Time and Channel Closing Transmission Time	Test using widest BW mode available	Test using the widest BW mode available for the link
All other tests	Any single BW mode	Not required

Note: Frequencies selected for statistical performance check should include several frequencies within the radar detection bandwidth and frequencies near the edge of the radar detection bandwidth. For 802.11 devices it is suggested to select frequencies in each of the bonded 20 MHz channels and the channel center frequency.

Table 3-2: Applicability of DFS Requirements during normal operation

3.2. DFS Devices Requirements

Per FCC KDB 905462 D02 UNII DFS Compliance Procedures New Rules v02 the following are the requirements for Master Devices:

- (a) The Master Device will use DFS in order to detect Radar Waveforms with received signal strength above the DFS Detection Threshold in the 5250 ~ 5350 MHz and 5470 ~ 5725 MHz bands. DFS is not required in the 5150 ~ 5250 MHz or 5725 ~ 5825 MHz bands.
- (b) Before initiating a network on a Channel, the Master Device will perform a Channel Availability Check for a specified time duration (Channel Availability Check Time) to ensure that there is no radar system operating on the Channel, using DFS described under subsection a) above.
- (c) The Master Device initiates a U-NII network by transmitting control signals that will enable other U-NII devices to Associate with the Master Device.
- (d) During normal operation, the Master Device will monitor the Channel (In-Service Monitoring) to ensure that there is no radar system operating on the Channel, using DFS described under a).
- (e) If the Master Device has detected a Radar Waveform during In-Service Monitoring as described under d), the Operating Channel of the U-NII network is no longer an Available Channel. The Master Device will instruct all associated Client Device(s) to stop transmitting on this Channel within the Channel Move Time. The transmissions during the Channel Move Time will be limited to the Channel Closing Transmission Time.
- (f) Once the Master Device has detected a Radar Waveform it will not utilize the Channel for the duration of the Non-Occupancy Period.
- (g) If the Master Device delegates the In-Service Monitoring to a Client Device, then the combination will be tested to the requirements described under d) through f) above.

Channel Move Time and Channel Closing Transmission Time requirements are listed in the following table.

Parameter	Value
Non-occupancy period	Minimum 30 minutes
Channel Availability Check Time	60 seconds
Channel Move Time	10 seconds See Note 1.
Channel Closing Transmission Time	200 milliseconds + an aggregate of 60 milliseconds over remaining 10 second period. See Notes 1 and 2.
U-NII Detection Bandwidth	Minimum 100% of the U-NII 99% transmission power bandwidth. See Note 3.
Note 1: Channel Move Time and the Channel Closing Transmission Time should be performed with Radar Type 0. The measurement timing begins at the end of the Radar Type 0 burst.	

Note 2: The Channel Closing Transmission Time is comprised of 200 milliseconds starting at the beginning of the Channel Move Time plus any additional intermittent control signals required to facilitate a Channel move (an aggregate of 60 milliseconds) during the remainder of the 10 second period. The aggregate duration of control signals will not count quiet periods in between transmissions.

Note 3: During the U-NII Detection Bandwidth detection test, radar type 0 should be used. For each frequency step the minimum percentage of detection is 90 percent. Measurements are performed with no data traffic.

Table 3-3: DFS Response Requirements

3.3. DFS Detection Threshold Values

The DFS detection thresholds are defined for Master devices and Client Devices with In-service monitoring. These detection thresholds are listed in the following table.

Maximum Transmit Power	Value (See Notes 1, 2, and 3)
EIRP \geq 200 milliwatt	-64 dBm
EIRP < 200 milliwatt and power spectral density < 10 dBm/MHz	-62 dBm
EIRP < 200 milliwatt that do not meet the power spectral density requirement	-64 dBm

Note 1: This is the level at the input of the receiver assuming a 0 dBi receive antenna.

Note 2: Throughout these test procedures an additional 1 dB has been added to the amplitude of the test transmission waveforms to account for variations in measurement equipment. This will ensure that the test signal is at or above the detection threshold level to trigger a DFS response.

Note3: EIRP is based on the highest antenna gain. For MIMO devices refer to KDB Publication 662911 D01.

Table 3-4: Detection Thresholds for Master Devices and Client Devices with Radar Detection

3.4. Parameters of DFS Test Signals

This section provides the parameters for required test waveforms, minimum percentage of successful detections, and the minimum number of trials that must be used for determining DFS conformance. Step intervals of 0.1 microsecond for Pulse Width, 1 microsecond for PRI, 1 MHz for chirp width and 1 for the number of pulses will be utilized for the random determination of specific test waveforms.

Short Pulse Radar Test Waveforms

Radar Type	Pulse Width (μsec)	PRI (μsec)	Number of Pulses	Minimum Percentage of Successful Detection	Minimum Number of Trials
0	1	1428	18	See Note 1	See Note 1
1	1	Test A: 15 unique PRI values randomly selected from the list of 23 PRI values in Table 3-6	$\text{Roundup} \left\{ \left(\frac{1}{360} \right) \cdot \left(\frac{19 \cdot 10^6}{\text{PRI}_{\mu\text{sec}}} \right) \right\}$	60%	30
		Test B: 15 unique PRI values randomly selected within the range of 518-3066 μsec, with a minimum increment of 1 μsec, excluding PRI values selected in Test A			
2	1-5	150-230	23-29	60%	30
3	6-10	200-500	16-18	60%	30
4	11-20	200-500	12-16	60%	30
Aggregate (Radar Types 1-4)				80%	120
Note 1: Short Pulse Radar Type 0 should be used for the detection bandwidth test, channel move time, and channel closing time tests.					

Table 3-5: Parameters for Short Pulse Radar Waveforms

A minimum of 30 unique waveforms are required for each of the Short Pulse Radar Types 2 through 4. If more than 30 waveforms are used for Short Pulse Radar Types 2 through 4, then each additional waveform must also be unique and not repeated from the previous waveforms.

Pulse Repetition Frequency Number	Pulse Repetition Frequency (Pulses Per Second)	Pulse Repetition Interval (Microseconds)
1	1930.5	518
2	1858.7	538
3	1792.1	558
4	1730.1	578
5	1672.2	598
6	1618.1	618
7	1567.4	638
8	1519.8	658
9	1474.9	678
10	1432.7	698
11	1392.8	718
12	1355	738
13	1319.3	758
14	1285.3	778
15	1253.1	798
16	1222.5	818
17	1193.3	838
18	1165.6	858
19	1139	878
20	1113.6	898
21	1089.3	918
22	1066.1	938
23	326.2	3066

Table 3-6: Pulse Repetition Intervals Values for Test A

Long Pulse Radar Test Waveform

Radar Type	Pulse Width (μsec)	Chirp Width (MHz)	PRI (μsec)	Number of Pulses per Burst	Number of Bursts	Minimum Percentage of Successful Detection	Minimum Number of Trials
5	50 - 100	5 - 20	1000 - 2000	1 - 3	8 - 20	80%	30

Table 3-7: Parameters for Long Pulse Radar Waveforms

The parameters for this waveform are randomly chosen. Thirty unique waveforms are required for the Long Pulse Radar Type waveforms. If more than 30 waveforms are used for the Long Pulse Radar Type waveforms, then each additional waveform must also be unique and not repeated from the previous waveforms.

Frequency Hopping Radar Test Waveform

Radar Type	Pulse Width (μsec)	PRI (μsec)	Pulses Per Hop	Hopping Rate (kHz)	Hopping Sequence Length (msec)	Minimum Percentage of Successful Detection	Minimum Number of Trials
6	1	333	9	0.333	300	70%	30

Table 3-8: Parameters for Frequency Hopping Radar Waveforms

For the Frequency Hopping Radar Type, the same Burst parameters are used for each waveform. The hopping sequence is different for each waveform and a 100-length segment is selected from the hopping sequence defined by the following algorithm:

The first frequency in a hopping sequence is selected randomly from the group of 475 integer frequencies from 5250 – 5724MHz. Next, the frequency that was just chosen is removed from the group and a frequency is randomly selected from the remaining 474 frequencies in the group. This process continues until all 475 frequencies are chosen for the set. For selection of a random frequency, the frequencies remaining within the group are always treated as equally likely.

3.5. Radiated Test Setup

The FCC KDB 905462 D02 UNII DFS Compliance Procedures New Rules v02 describes a radiated test setup. The radiated test setup was used for this testing. Figure 3-1 shows the typical test setup.

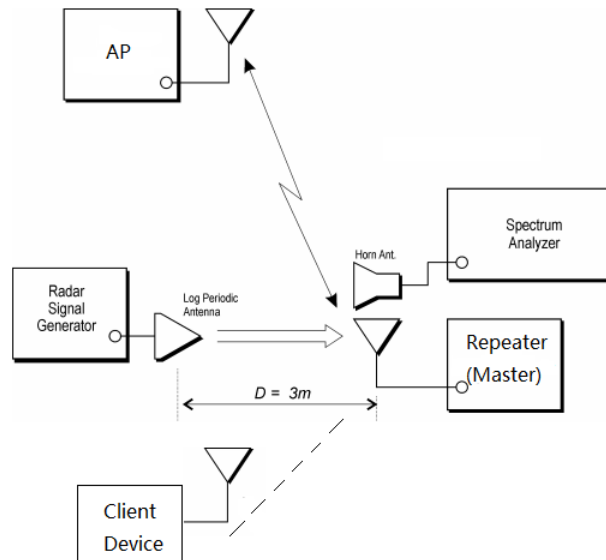

Figure 3-1: Radiated Test Setup where UUT is a Master and Radar Test Waveforms are injected into the Masters

4. TEST EQUIPMENT CALIBRATION DATE

Dynamic Frequency Selection (DFS) – TR3

Instrument	Manufacturer	Type No.	Asset No.	Cali. Interval	Cali. Due Date
EXA Signal Analyzer	Keysight	N9010A	MRTTWA00012	1 year	2019/7/30
Vector Signal Generator	Keysight	N5182B	MRTTWA00010	1 year	2019/4/23
Combiner	WOKEN	0120A04208001S	MRTTWE00008	1 year	2019/6/11
Broadband Hornantenna	SCHWARZBECK	BBHA 9120D	MRTTWA00003	1 year	2019/04/05

Client Information

Instrument	Manufacturer	Type No.
Wireless Network Adapter	Intel	7260HMW

Software	Version	Manufacturer	Function
Pulse Building	N/A	Agilent	Radar Signal Generation Software
DFS Tool	V 6.9.2	Agilent	DFS Test Software

5. TEST RESULT

5.1. Summary

Company Name: Nokia Solutions and Networks, OY
FCC ID: 2AD8UFZCWI2B1
IC: 109D-FZCWI2B1

Parameter	Limit	Test Result	Reference
UNII Detection Bandwidth Measurement	Refer Table 3-3	Pass	Section 5.3
Statistical Performance Check	Refer Table 3-3	Pass	Section 5.4

5.2. Radar Waveform Calibration

5.2.1. Calibration Setup

The conducted test setup was used for this calibration testing. Figure 3-2 shows the typical test setup.

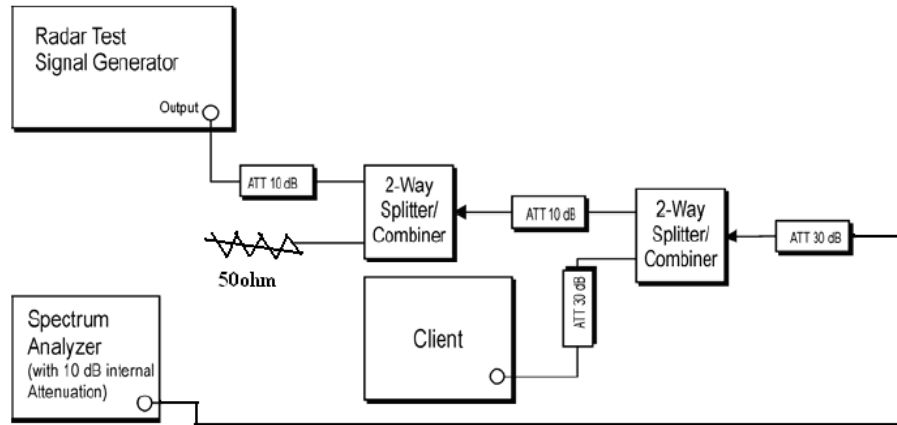

Figure 3-2: Conducted Test Setup

5.2.2. Calibration Procedure

The Interference Radar Detection Threshold Level is $(-64\text{dBm}) + (0) [\text{dBi}] + 1 \text{ dB} = -63 \text{ dBm}$ that had been taken into account the output power range and antenna gain. The above equipment setup was used to calibrate the conducted Radar Waveform. A vector signal generator was utilized to establish the test signal level for each radar type. During this process there were replace 50ohm terminal form Master and Client device and no transmissions by either the Master or Client Device. The spectrum analyzer was switched to the zero span (Time Domain) at the frequency of the Radar Waveform generator. Peak detection was used. The spectrum analyzer resolution bandwidth (RBW) and video bandwidth (VBW) were set to at least 3MHz. The vector signal generator amplitude was set so that the power level measured at the spectrum analyzer was $(-64\text{dBm}) + (0) [\text{dBi}] + 1 \text{ dB} = -63\text{dBm}$. Capture the spectrum analyzer plots on short pulse radar types, long pulse radar type and hopping radar waveform.

5.2.3. Cablibration Result

Radar #0 DFS detection threshold level and the burst of pulses on the Channel frequency

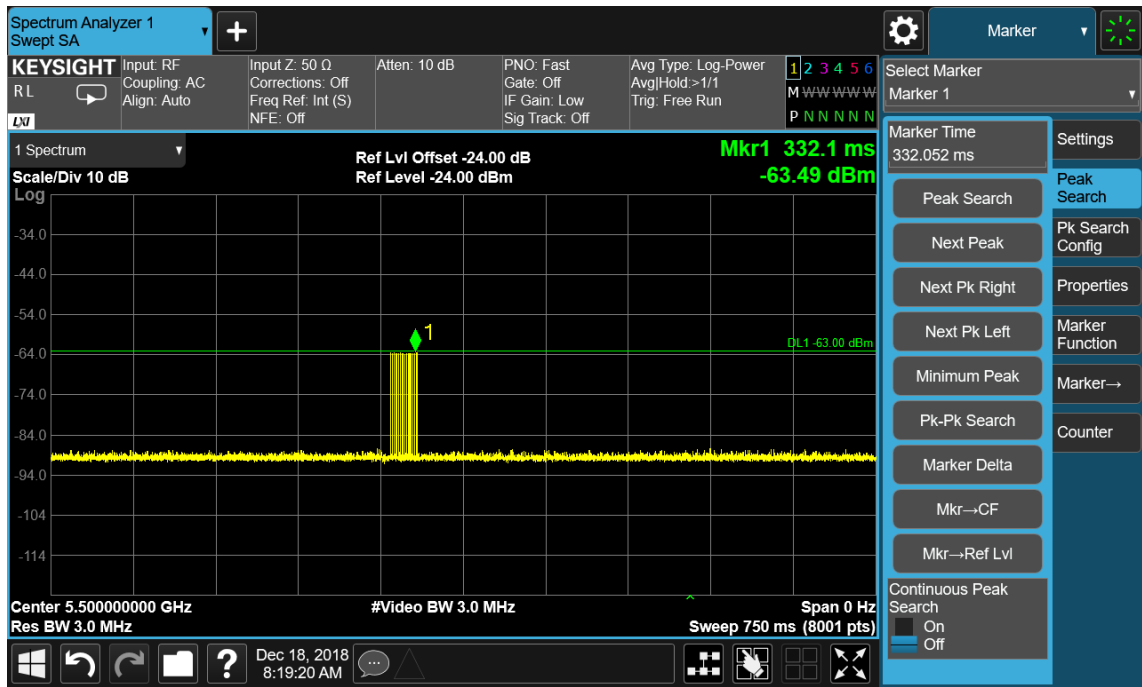

Radar #1(Test A) DFS detection threshold level and the burst of pulses on the Channel frequency

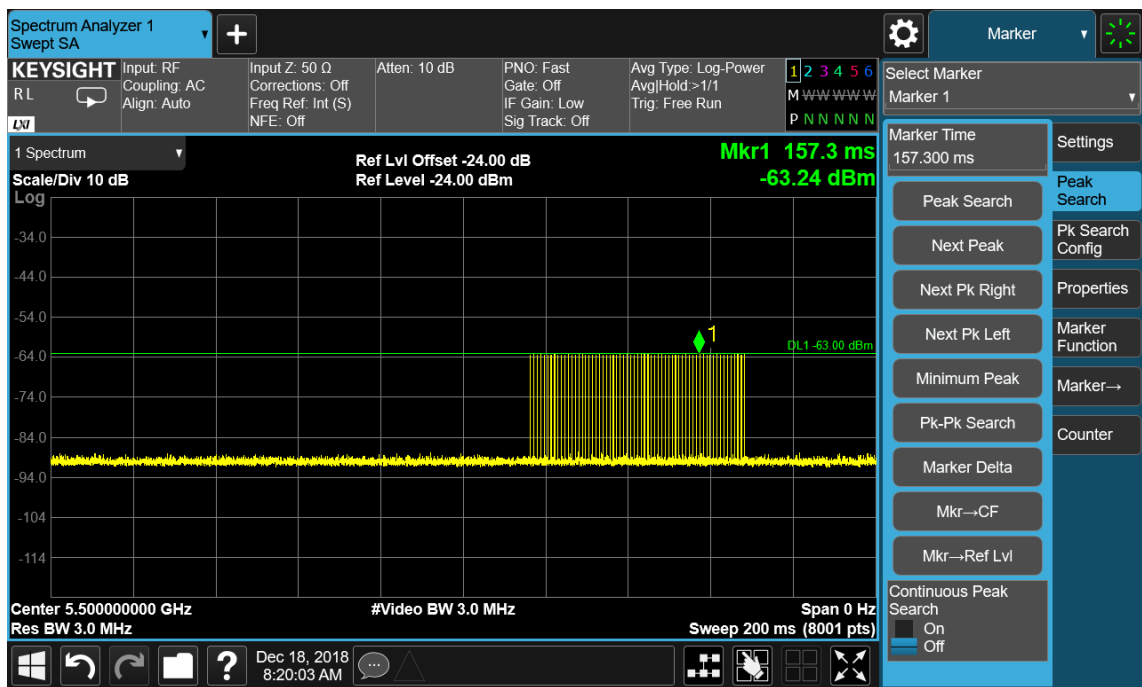

PRI = 838us and the number of pulses = 63

Radar #1(Test B) DFS detection threshold level and the burst of pulses on the Channel frequency

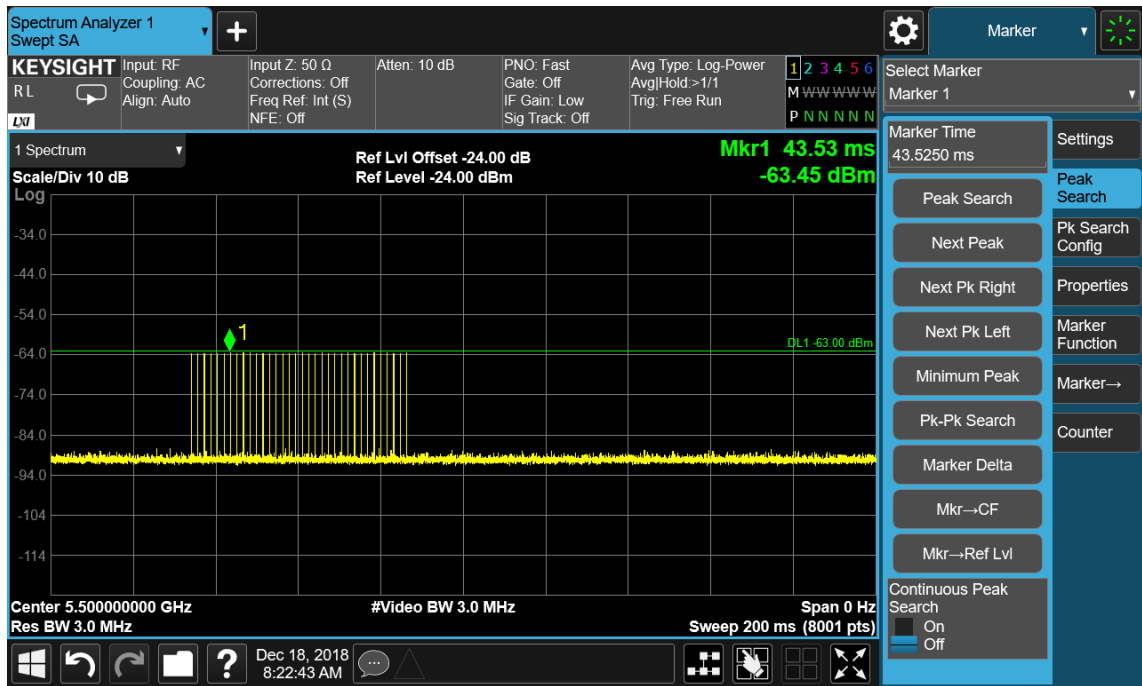

PRI = 1.583ms and the number of pulses = 34

Radar #2 DFS detection threshold level and the burst of pulses on the Channel frequency

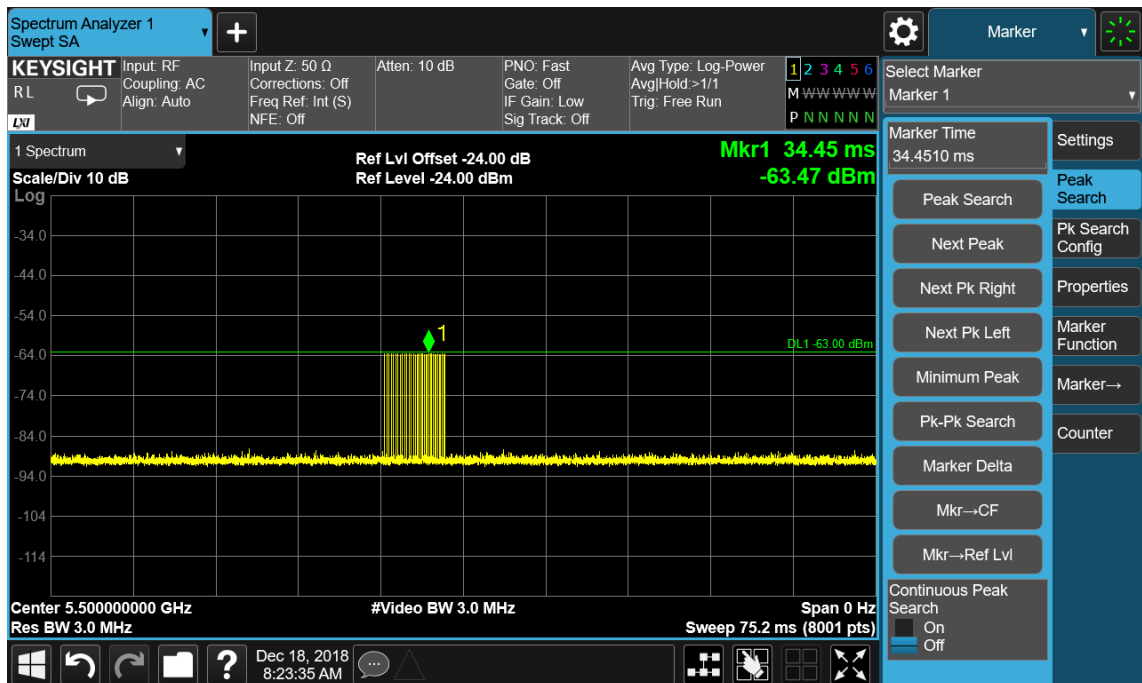

Radar #3 DFS detection threshold level and the burst of pulses on the Channel frequency

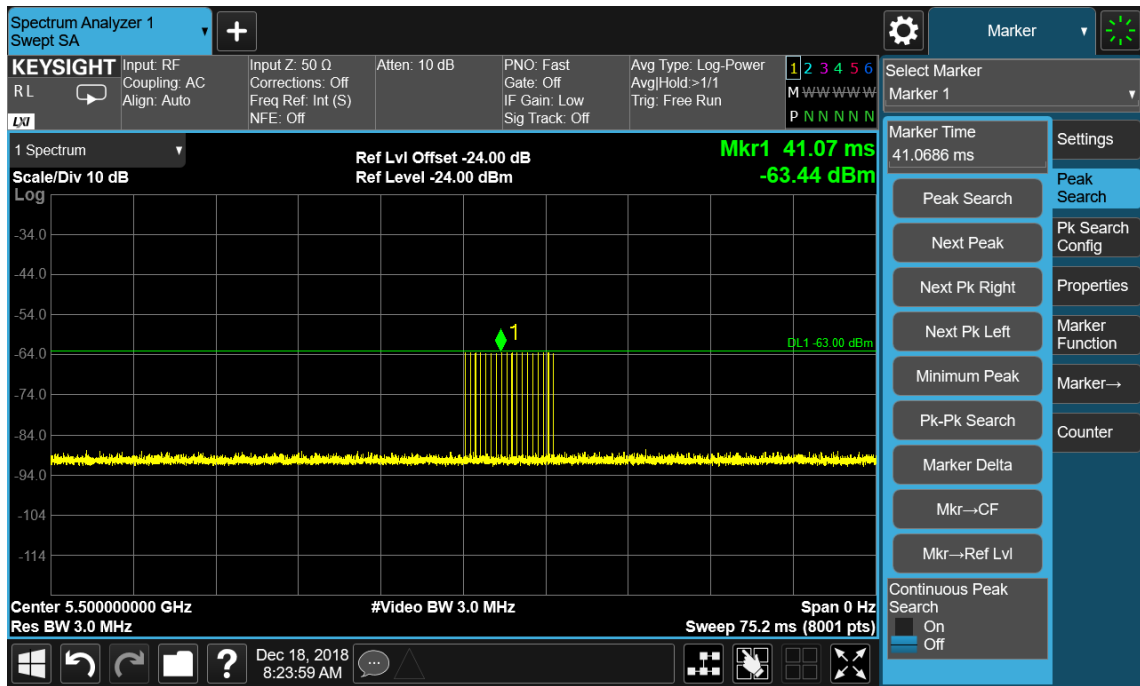

Radar #4 DFS detection threshold level and the burst of pulses on the Channel frequency

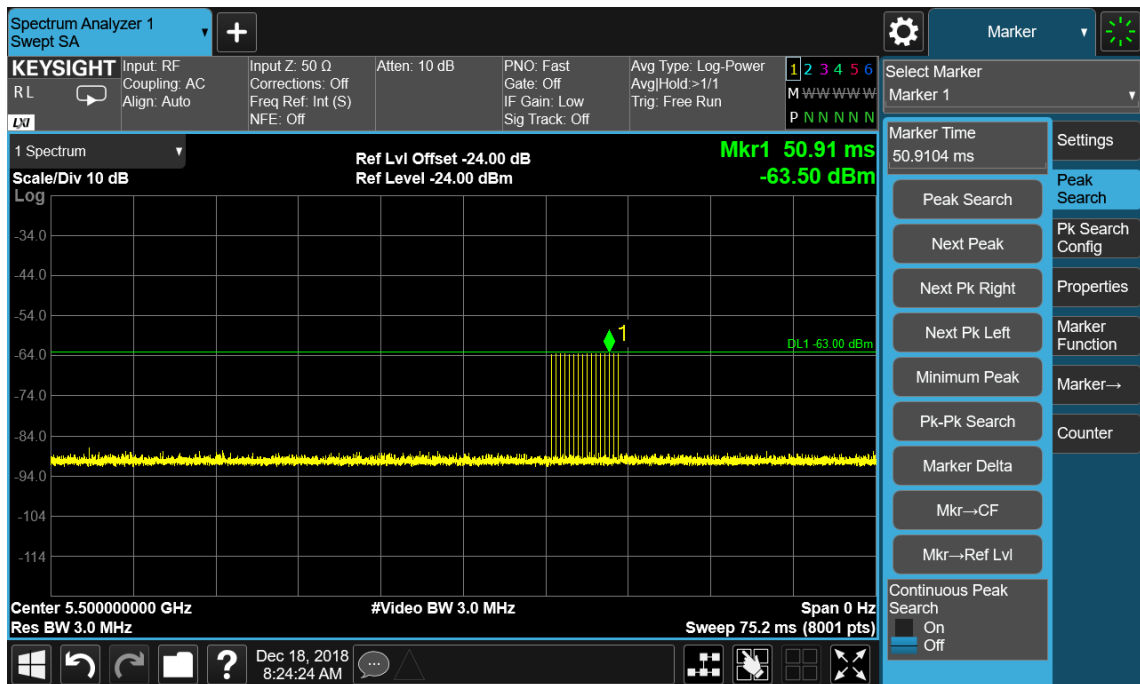

Radar #5 DFS detection threshold level and 12sec long burst on the Channel frequency



Radar #6 DFS detection threshold level and a single hop (9 pulses) on the Channel frequency within UNII detection bandwidth

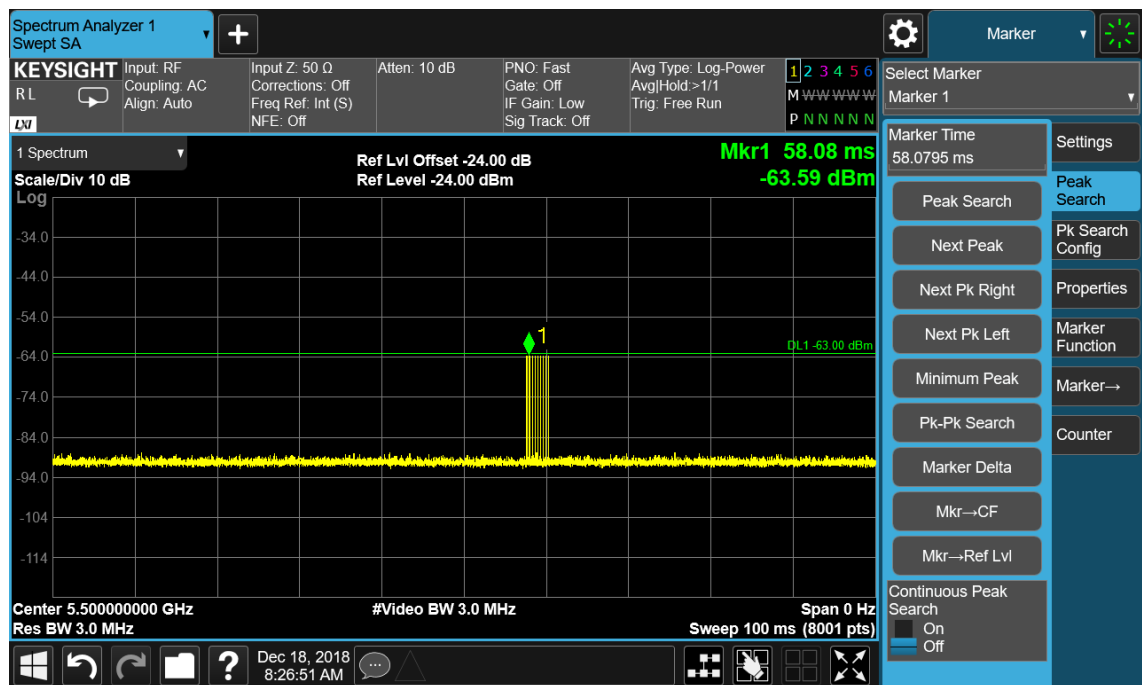

5.2.4. Channel Loading Test Result

System testing was performed with the designated MPEG test file that streams full motion video from the **AC220i Wi-Fi AP ID omni antenna US** to the Client in full motion video mode using the media player with the V2.61 Codec package. This file is used by IP and Frame based systems for loading the test channel during the In-service compliance testing of the U-NII device. Packet ratio = Time On / (Time On + Off Time).

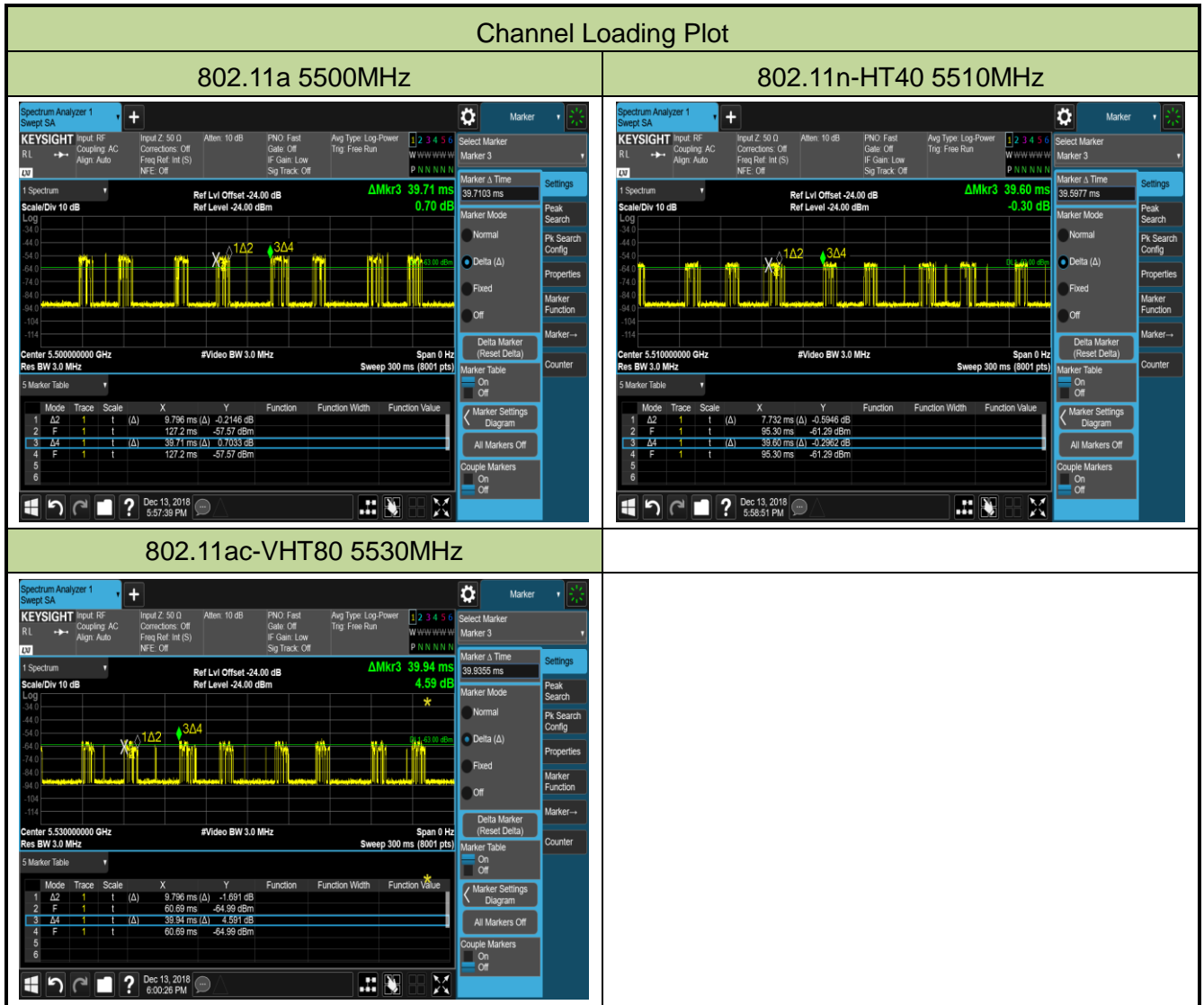

Test Mode	Test Frequency	Packet ratio	Requirement ratio	Test Result
802.11a	5500 MHz	24.67%	≥ 17%	Pass
802.11n-HT40	5510 MHz	19.53%	≥ 17%	Pass
802.11ac-VHT80	5530 MHz	24.53%	≥ 17%	Pass

5.3. UNII Detection Bandwidth Measurement

5.3.1. Test Limit

Minimum 100% of the UNII 99% transmission power bandwidth. During the U-NII Detection Bandwidth detection test, each frequency step the minimum percentage of detection is 90 percent. Measurements are performed with no data traffic.

5.3.2. Test Procedure

1. Adjust the equipment to produce a single Burst of any one of the Short Pulse Radar Types 0-4 in Table 3-5 at the center frequency of the EUT Operating Channel at the specified DFS Detection Threshold level.
2. The generating equipment is configured as shown in the Conducted Test Setup above section 3.5.
3. The EUT is set up as a stand-alone device (no associated Client or Master, as appropriate) and no traffic. Frame based systems will be set to a talk/listen ratio reflecting the worst case (maximum) that is user configurable during this test.
4. Generate a single radar Burst, and note the response of the EUT. Repeat for a minimum of 10 trials. The EUT must detect the Radar Waveform using the specified U-NII Detection Bandwidth criterion shown in Table 3-5. In cases where the channel bandwidth may exceed past the DFS band edge on specific channels (i.e., 802.11ac or wideband frame based systems) select a channel that has the entire emission bandwidth within the DFS band. If this is not possible, test the detection BW to the DFS band edge.
5. Starting at the center frequency of the UUT operating Channel, increase the radar frequency in 5 MHz steps, repeating the above test sequence, until the detection rate falls below the U-NII Detection Bandwidth criterion specified in Table 3-3. Repeat this measurement in 1MHz steps at frequencies 5 MHz below where the detection rate begins to fall. Record the highest frequency (denote as FH) at which detection is greater than or equal to the U-NII Detection Bandwidth criterion. Recording the detection rate at frequencies above FH is not required to demonstrate compliance.
6. Starting at the center frequency of the EUT operating Channel, decrease the radar frequency in 1 MHz steps, repeating the above item 4 test sequence, until the detection rate falls below the U-NII Detection Bandwidth criterion. Record the lowest frequency (denote as FL) at which detection is greater than or equal to the U-NII Detection Bandwidth criterion. Recording the detection rate at frequencies below FL is not required to demonstrate compliance.
7. The U-NII Detection Bandwidth is calculated as follows: $U\text{-NII Detection Bandwidth} = FH - FL$
8. The U-NII Detection Bandwidth must be at least 100% of the EUT transmitter 99% power, otherwise, the EUT does not comply with DFS requirements.

5.3.3. Test Result

EUT Frequency = 5500MHz for 802.11a											
Radar Frequency (MHz)	DFS Detection Trials (1=Detection, 0= No Detection)										Detection Rate (%)
	1	2	3	4	5	6	7	8	9	10	
5490	0	0	0	0	0	0	0	0	0	0	0%
5491 FL	1	1	1	1	1	1	1	1	1	1	100%
5492	1	1	1	1	1	1	1	1	1	1	100%
5493	1	1	1	1	1	1	1	1	1	1	100%
5494	1	1	1	1	1	1	1	1	1	1	100%
5495	1	1	1	1	1	1	1	1	1	1	100%
5500	1	1	1	1	1	1	1	1	1	1	100%
5505	1	1	1	1	1	1	1	1	1	1	100%
5506	1	1	1	1	1	1	1	1	1	1	100%
5507	1	1	1	1	1	1	1	1	1	1	100%
5508	1	1	1	1	1	1	1	1	1	1	100%
5509 FH	1	1	1	1	1	1	1	1	1	1	100%
5510	0	0	0	0	0	0	0	0	0	0	0%
Detection Bandwidth = FH - FL = 5509MHz - 5491MHz = 18MHz											
EUT 99% Bandwidth = 16.47MHz (see note)											
UNII Detection Bandwidth Min. Limit (MHz): 16.48MHz x 100% = 16.47MHz											

Note: All UNII channels for this device have identical Channel bandwidths. Therefore, all DFS testing was done at 5500MHz. The 99% channel bandwidth is 16.47MHz. (See the 99% BW section of the RF report for further measurement details).

EUT Frequency = 5510MHz for 802.11n-HT40											
Radar Frequency (MHz)	DFS Detection Trials (1=Detection, 0= No Detection)										Detection Rate (%)
	1	2	3	4	5	6	7	8	9	10	
5490	0	0	0	0	0	0	0	0	0	0	0%
5491 FL	1	1	1	1	1	1	1	1	1	1	100%
5492	1	1	1	1	1	1	1	1	1	1	100%
5493	1	1	1	1	1	1	1	1	1	1	100%
5494	1	1	1	1	1	1	1	1	1	1	100%
5495	1	1	1	1	1	1	1	1	1	1	100%
5500	1	1	1	1	1	1	1	1	1	1	100%
5505	1	1	1	1	1	1	1	1	1	1	100%
5510	1	1	1	1	1	1	1	1	1	1	100%
5515	1	1	1	1	1	1	1	1	1	1	100%
5520	1	1	1	1	1	1	1	1	1	1	100%
5525	1	1	1	1	1	1	1	1	1	1	100%
5526	1	1	1	1	1	1	1	1	1	1	100%
5527	1	1	1	1	1	1	1	1	1	1	100%
5528	1	1	1	1	1	1	1	1	1	1	100%
5529 FH	1	1	1	1	1	1	1	1	1	1	100%
5530	0	0	0	0	0	0	0	0	0	0	0%
Detection Bandwidth = FH - FL = 5529MHz - 5491MHz = 38MHz											
EUT 99% Bandwidth = 35.91MHz (see note)											
UNII Detection Bandwidth Min. Limit (MHz): 35.91MHz x 100% = 35.91MHz											

Note: All UNII channels for this device have identical Channel bandwidths. Therefore, all DFS testing was done at 5510MHz. The 99% channel bandwidth is 35.91MHz. (See the 99% BW section of the RF report for further measurement details).



EUT Frequency = 5530MHz for 802.11ac-VHT80											
Radar Frequency (MHz)	DFS Detection Trials (1=Detection, 0= No Detection)										Detection Rate (%)
	1	2	3	4	5	6	7	8	9	10	
5490	0	0	0	0	0	0	0	0	0	0	0%
5491 FL	1	1	1	1	1	1	1	1	1	1	100%
5492	1	1	1	1	1	1	1	1	1	1	100%
5493	1	1	1	1	1	1	1	1	1	1	100%
5494	1	1	1	1	1	1	1	1	1	1	100%
5495	1	1	1	1	1	1	1	1	1	1	100%
5500	1	1	1	1	1	1	1	1	1	1	100%
5505	1	1	1	1	1	1	1	1	1	1	100%
5510	1	1	1	1	1	1	1	1	1	1	100%
5515	1	1	1	1	1	1	1	1	1	1	100%
5520	1	1	1	1	1	1	1	1	1	1	100%
5525	1	1	1	1	1	1	1	1	1	1	100%
5530	1	1	1	1	1	1	1	1	1	1	100%
5535	1	1	1	1	1	1	1	1	1	1	100%
5540	1	1	1	1	1	1	1	1	1	1	100%
5545	1	1	1	1	1	1	1	1	1	1	100%
5550	1	1	1	1	1	1	1	1	1	1	100%
5555	1	1	1	1	1	1	1	1	1	1	100%
5560	1	1	1	1	1	1	1	1	1	1	100%
5565	1	1	1	1	1	1	1	1	1	1	100%
5566	1	1	1	1	1	1	1	1	1	1	100%
5567	1	1	1	1	1	1	1	1	1	1	100%
5568	1	1	1	1	1	1	1	1	1	1	100%
5569 FH	1	1	1	1	1	1	1	1	1	1	100%
5570	0	0	0	0	0	0	0	0	0	0	0%
Detection Bandwidth = FH - FL = 5569MHz - 5491MHz = 78MHz											
EUT 99% Bandwidth = 75.66MHz (see note)											
UNII Detection Bandwidth Min. Limit (MHz): 75.66MHz x 100% = 75.66MHz											

Note: All UNII channels for this device have identical Channel bandwidths. Therefore, all DFS testing was done at 5530MHz. The 99% channel bandwidth is 75.66MHz. (See the 99% BW section of the RF report for further measurement details).

5.4. Statistical Performance Check Measurement

5.4.1. Test Limit

The minimum percentage of successful detection requirements found in below table when a radar burst with a level equal to the DFS Detection Threshold + 1dB is generated on the Operating Channel of the U-NII device (In- Service Monitoring).

Radar Type	Minimum Number of Trails	Detection Probability
0	30	Pd > 60%
1	30(15 of test A and 15 of test B)	Pd > 60%
2	30	Pd > 60%
3	30	Pd > 60%
4	30	Pd > 60%
Aggregate (Radar Types 1-4)	120	Pd > 80%
5	30	Pd > 80%
6	30	Pd > 70%

The percentage of successful detection is calculated by:

$(\text{Total Waveform Detections} / \text{Total Waveform Trails}) * 100 = \text{Probability of Detection Radar}$

Waveform In addition an aggregate minimum percentage of successful detection across all Short Pulse Radar Types 1-4 is required and is calculated as follows: $(Pd1 + Pd2 + Pd3 + Pd4) / 4$.

5.4.2. Test Procedure

1. Stream the MPEG test file from the Master Device to the Client Device on the test Channel for the entire period of the test.
2. At time T0 the Radar Waveform generator sends the individual waveform for each of the Radar Types 1-6, at levels equal to the DFS Detection Threshold + 1dB, on the Operating Channel.
3. Observe the transmissions of the EUT at the end of the Burst on the Operating Channel for duration greater than 10 seconds for Short Pulse Radar Types 0 to ensure detection occurs.
4. Observe the transmissions of the EUT at the end of the Burst on the Operating Channel for duration greater than 22 seconds for Long Pulse Radar Type 5 to ensure detection occurs.
5. The device can utilize a test mode to demonstrate when detection occurs to prevent the need to reset the device between trial runs.
6. The Minimum number of trails, minimum percentage of successful detection and the average minimum percentage of successful detection are found in below table.

5.4.3. Test Result

Statistical Performance Check for 802.11a

Radar Type 1 - Radar Statistical Performance

Trail #	Test Freq. (MHz)	Pulse Width (us)	PRI (us)	Pulses / Burst	1=Detection 0=No Detection
1	5491	1	618	86	1
2	5491	1	938	57	1
3	5491	1	918	58	1
4	5491	1	698	76	1
5	5491	1	718	74	1
6	5491	1	558	95	1
7	5491	1	518	102	1
8	5491	1	838	63	1
9	5491	1	738	72	1
10	5491	1	878	61	1
11	5500	1	818	65	1
12	5500	1	798	67	1
13	5500	1	858	62	1
14	5500	1	778	68	1
15	5500	1	3066	18	1
16	5500	1	529	100	1
17	5500	1	2129	25	1
18	5500	1	2899	19	1
19	5500	1	2540	21	1
20	5500	1	1786	30	1
21	5509	1	2701	20	1
22	5509	1	2514	21	1
23	5509	1	2683	20	1
24	5509	1	2832	19	1
25	5509	1	2464	22	1
26	5509	1	1218	44	1
27	5509	1	1017	52	1
28	5509	1	762	70	1
29	5509	1	1984	27	1
30	5509	1	929	57	1
Detection Percentage (%)					100%



Radar Type 2 - Radar Statistical Performance

Trail #	Test Freq. (MHz)	Pulse Width (us)	PRI (us)	Pulses / Burst	1=Detection 0=No Detection
1	5491	4.1	224	25	1
2	5491	3.8	201	29	1
3	5491	3.4	170	27	1
4	5491	1.0	229	25	1
5	5491	1.8	173	29	1
6	5491	4.0	195	27	1
7	5491	1.5	150	23	1
8	5491	2.7	174	25	1
9	5491	4.2	167	28	1
10	5491	2.2	190	28	1
11	5500	2.9	216	28	1
12	5500	3.5	180	23	1
13	5500	2.0	220	25	1
14	5500	1.5	200	24	1
15	5500	3.0	188	26	1
16	5500	2.2	216	29	1
17	5500	2.6	199	26	1
18	5500	3.6	158	26	1
19	5500	4.4	216	23	1
20	5500	1.9	214	26	1
21	5509	3.7	184	28	1
22	5509	2.6	200	25	1
23	5509	2.6	185	23	1
24	5509	2.5	181	25	1
25	5509	3.0	150	27	1
26	5509	2.9	152	23	1
27	5509	4.8	172	23	1
28	5509	3.3	189	28	1
29	5509	2.7	206	29	1
30	5509	4.3	202	23	1
Detection Percentage (%)					100%



Radar Type 3 - Radar Statistical Performance

Trail #	Test Freq. (MHz)	Pulse Width (us)	PRI (us)	Pulses / Burst	1=Detection 0=No Detection
1	5491	8.9	278	18	1
2	5491	7.7	391	16	1
3	5491	9.7	408	17	1
4	5491	9.4	453	17	1
5	5491	8.8	429	18	1
6	5491	6.4	328	17	1
7	5491	6.8	441	16	1
8	5491	8.6	314	17	1
9	5491	6.5	307	18	1
10	5491	7.3	259	16	1
11	5500	6.8	495	17	1
12	5500	8.3	436	18	1
13	5500	8.7	303	17	1
14	5500	7.0	334	17	1
15	5500	6.8	310	17	1
16	5500	7.1	451	18	1
17	5500	6.1	279	18	1
18	5500	8.4	497	16	1
19	5500	8.2	401	16	1
20	5500	9.6	427	18	1
21	5509	6.0	312	18	1
22	5509	7.2	450	18	1
23	5509	0.0	0	0	1
24	5509	9.9	371	16	1
25	5509	7.3	478	18	1
26	5509	7.1	449	18	1
27	5509	10.0	370	17	1
28	5509	9.7	441	18	1
29	5509	6.8	406	17	1
30	5509	9.7	386	17	1
Detection Percentage (%)					100%



Radar Type 4 - Radar Statistical Performance

Trail #	Test Freq. (MHz)	Pulse Width (us)	PRI (us)	Pulses / Burst	1=Detection 0=No Detection
1	5491	13.1	491	12	1
2	5491	15.1	285	13	1
3	5491	14.6	292	16	1
4	5491	18.4	283	16	1
5	5491	16.6	361	15	1
6	5491	16.7	474	16	1
7	5491	12.6	368	15	1
8	5491	18.9	346	15	1
9	5491	15.9	468	14	1
10	5491	17.9	480	13	1
11	5500	14.0	308	15	1
12	5500	15.0	252	14	1
13	5500	18.3	457	12	1
14	5500	16.3	406	14	1
15	5500	16.4	500	13	1
16	5500	13.9	292	13	1
17	5500	19.4	255	15	1
18	5500	16.0	485	14	1
19	5500	12.2	423	12	1
20	5500	11.8	499	13	1
21	5509	14.2	295	14	1
22	5509	12.7	397	15	1
23	5509	13.2	377	16	1
24	5509	17.2	427	13	1
25	5509	12.0	469	13	1
26	5509	11.4	337	12	1
27	5509	14.7	388	12	1
28	5509	18.6	322	13	1
29	5509	12.2	389	16	1
30	5509	11.1	403	14	1
Detection Percentage (%)					100%

Note: In addition an average minimum percentage of successful detection across all four Short pulse radar test

waveforms is as follows: $\frac{P_d1 + P_d2 + P_d3 + P_d4}{4} = (100\% + 100\% + 100\% + 100\%) / 4 = 100\% (>80\%)$



Radar Type 5 - Radar Statistical Performance

Trail #	Test Freq. (MHz)	1=Detection 0=No Detection	Trail #	Test Freq. (MHz)	1=Detection 0=No Detection
1	5493.0	1	16	5500.0	1
2	5493.4	1	17	5500.0	1
3	5494.6	1	18	5500.0	1
4	5495.0	1	19	5500.0	1
5	5496.6	1	20	5500.0	1
6	5498.6	1	21	5504.2	1
7	5494.2	1	22	5506.6	1
8	5498.2	1	23	5505.4	1
9	5497.8	1	24	5501.4	1
10	5495.8	1	25	5507.0	1
11	5500.0	1	26	5505.0	1
12	5500.0	1	27	5503.4	1
13	5500.0	1	28	5505.8	1
14	5500.0	1	29	5502.2	1
15	5500.0	1	30	5501.8	1
Detection Percentage (%)					100%

Type 5 Radar Waveform_1										
Num of Bursts = 8										
Burst Interval (us)= 1500000										
Burst #	Off Time (us)	# Pulses	Chirp (MHz)	PW (us)	Pulse 1 Pri(us)	Pulse 2 Pri(us)	Pulse 3 Pri(us)	Start Loc (us)	Start Burst Interval(us)	End Burst Interval(us)
1	450918	3	5	70	1360	1171	1922	450918	0	1499999
2	1424859	3	5	95	1688	1221	1241	1880230	1500000	2999999
3	1949180	1	5	85	1206	0	0	3833560	3000000	4499999
4	1706299	2	5	85	1856	1184	0	5541065	4500000	5999999
5	1872869	2	5	65	1580	1619	0	7416974	6000000	7499999
6	1431068	1	5	95	1357	0	0	8851241	7500000	8999999
7	1620383	2	5	95	1937	1338	0	10472981	9000000	10499999
8	492663	3	5	50	1765	1182	1342	10968919	10500000	11999999
Total number of pulses in waveform = 17										



Type 5 Radar Waveform_2

Num of Bursts = 19
Burst Interval (us) = 631579

Burst #	Off Time (us)	# Pulses	Chirp (MHz)	PW (us)	Pulse 1 Pri (us)	Pulse 2 Pri (us)	Pulse 3 Pri (us)	Start Loc (us)	Start Burst Interval (us)	End Burst Interval (us)
1	273824	2	6	60	1177	1705	0	273824	0	631578
2	905950	1	6	75	1401	0	0	1182656	631579	1263157
3	248352	3	6	70	1144	1347	1935	1432409	1263158	1894736
4	690370	3	6	100	1313	1516	1467	2127705	1894737	2526315
5	553358	1	6	50	1069	0	0	2685359	2526316	3157894
6	521154	2	6	80	1920	1296	0	3207582	3157895	3789473
7	1086268	2	6	75	1501	1030	0	4297066	3789474	4421052
8	315438	1	6	80	1335	0	0	4615035	4421053	5052631
9	785543	1	6	55	1075	0	0	5401913	5052632	5684210
10	377366	2	6	90	1535	1257	0	5780354	5684211	6315789
11	892515	1	6	65	1270	0	0	6675661	6315790	6947368
12	735278	1	6	80	1223	0	0	7412209	6947369	7578947
13	238784	1	6	55	1210	0	0	7652216	7578948	8210526
14	614036	3	6	95	1491	1920	1752	8267462	8210527	8842105
15	663043	1	6	100	1962	0	0	8935668	8842106	9473684
16	895653	3	6	70	1925	1135	1307	9833283	9473685	10105263
17	746472	3	6	75	1237	1298	1083	10584122	10105264	10736842
18	226208	3	6	95	1405	1320	1249	10813948	10736843	11368421
19	1010440	2	6	65	1068	1758	0	11828362	11368422	12000000

Total number of pulses in waveform = 36

Type 5 Radar Waveform_3

Num of Bursts = 16
Burst Interval (us) = 750000

Burst #	Off Time (us)	# Pulses	Chirp (MHz)	PW (us)	Pulse 1 Pri (us)	Pulse 2 Pri (us)	Pulse 3 Pri (us)	Start Loc (us)	Start Burst Interval (us)	End Burst Interval (us)
1	613354	2	9	60	1026	1084	0	613354	0	749999
2	866541	2	9	60	1471	1870	0	1488005	750000	1499999
3	379657	3	9	70	1068	1805	1878	1871003	1500000	2249999
4	602695	1	9	60	1128	0	0	2478449	2250000	2999999
5	522196	2	9	80	1145	1126	0	3001773	3000000	3749999
6	1484805	2	9	55	1880	1173	0	4488849	3750000	4499999
7	679007	2	9	70	1126	1130	0	5170909	4500000	5249999
8	454462	3	9	55	1410	1172	1971	5627627	5250000	5999999
9	586869	2	9	50	1413	1707	0	6219049	6000000	6749999
10	804346	1	9	65	1898	0	0	7026515	6750000	7499999
11	1089206	1	9	60	1505	0	0	8117619	7500000	8249999
12	447294	3	9	85	1221	1029	1083	8566418	8250000	8999999
13	766461	1	9	90	1382	0	0	9336212	9000000	9749999
14	900599	3	9	80	1398	1898	1034	10238193	9750000	10499999
15	335023	3	9	60	1720	1839	1308	10577546	10500000	11249999
16	886582	1	9	50	1487	0	0	11468995	11250000	11999999

Total number of pulses in waveform = 32

Type 5 Radar Waveform_4

Num of Bursts = 13
Burst Interval (us) = 923077

Burst #	Off Time (us)	# Pulses	Chirp (MHz)	PW (us)	Pulse 1 Pri (us)	Pulse 2 Pri (us)	Pulse 3 Pri (us)	Start Loc (us)	Start Burst Interval (us)	End Burst Interval (us)
1	313603	3	10	90	1685	1322	1159	313603	0	923076
2	1403880	3	10	70	1212	1077	1699	1721649	923077	1846153
3	313711	1	10	55	1131	0	0	2039348	1846154	2769230
4	1495680	3	10	85	1987	1295	1168	3536159	2769231	3692307
5	940986	3	10	50	1614	1209	1096	4481595	3692308	4615384
6	259488	3	10	75	1884	1303	1418	4745002	4615385	5538461
7	1270814	1	10	80	1008	0	0	6020421	5538462	6461538
8	1358616	2	10	75	1447	1654	0	7380045	6461539	7384615
9	78092	1	10	90	1422	0	0	7461238	7384616	8307692
10	1312356	2	10	95	1441	1380	0	8775016	8307693	9230769
11	974698	1	10	80	1054	0	0	9752535	9230770	10153846
12	414949	1	10	50	1033	0	0	10168538	10153847	11076923
13	1489404	2	10	80	1376	1289	0	11658975	11076924	12000000

Total number of pulses in waveform = 26



Type 5 Radar Waveform_5

Num of Bursts = 20
Burst Interval (us)= 600000

Burst #	Off Time (us)	# Pulses	Chirp (MHz)	PW (us)	Pulse 1 Pri (us)	Pulse 2 Pri (us)	Pulse 3 Pri (us)	Start Loc (us)	Start Burst Interval (us)	End Burst Interval (us)
1	888721	1	14	50	1799	0	0	8932	0	599999
2	384710	3	14	90	1941	1893	1996	899452	600000	1199999
3	690990	2	14	100	1907	1261	0	1289992	1200000	1799999
4	512820	1	14	85	1289	0	0	1984150	1800000	2399999
5	516773	3	14	80	1998	1271	1837	2498259	2400000	2999999
6	630268	2	14	90	1028	1787	0	3020138	3000000	3599999
7	1057879	2	14	75	1650	1908	0	3653221	3600000	4199999
8	679065	1	14	70	1278	0	0	4714658	4200000	4799999
9	556485	1	14	85	1881	0	0	5395001	4800000	5399999
10	113373	1	14	95	1281	0	0	5953367	5400000	5999999
11	730374	1	14	90	1980	0	0	6068021	6000000	6599999
12	619490	2	14	85	1996	1285	0	6800375	6600000	7199999
13	704355	2	14	80	1938	1928	0	7423146	7200000	7799999
14	556197	1	14	85	1376	0	0	8131367	7800000	8399999
15	580506	1	14	70	1192	0	0	8688942	8400000	8999999
16	829187	1	14	65	1108	0	0	9270640	9000000	9599999
17	626070	3	14	85	1884	1029	1942	10100935	9600000	10199999
18	231012	1	14	50	1110	0	0	10731860	10200000	10799999
19	1007150	3	14	75	1283	1904	1850	10963982	10800000	11399999
20	1007150	1	14	55	1620	0	0	11976169	11400000	11999999

Total number of pulses in waveform = 33

Type 5 Radar Waveform_6

Num of Bursts = 14
Burst Interval (us)= 857143

Burst #	Off Time (us)	# Pulses	Chirp (MHz)	PW (us)	Pulse 1 Pri (us)	Pulse 2 Pri (us)	Pulse 3 Pri (us)	Start Loc (us)	Start Burst Interval (us)	End Burst Interval (us)
1	314855	2	19	65	1706	1870	0	314855	0	857142
2	660406	1	19	50	1074	0	0	978837	857143	1714285
3	1476688	1	19	100	1600	0	0	2456599	1714286	2571428
4	175591	1	19	80	1991	0	0	2633790	2571429	3428571
5	1199409	2	19	90	1552	1156	0	3835190	3428572	4285714
6	817101	2	19	50	1262	1161	0	4654999	4285715	5142857
7	825534	2	19	100	1613	1870	0	5482956	5142858	6000000
8	1133604	2	19	85	1339	1788	0	6620043	6000001	6857143
9	1059301	1	19	75	1850	0	0	7682471	6857144	7714286
10	285136	2	19	55	1170	1623	0	7969457	7714287	8571429
11	850577	3	19	70	1061	1742	1444	8822827	8571430	9428572
12	1294392	1	19	65	1388	0	0	10121466	9428573	10285715
13	468545	2	19	100	1593	1416	0	10591399	10285716	11142858
14	690492	2	19	50	1213	1330	0	11284900	11142859	12000001

Total number of pulses in waveform = 24

Type 5 Radar Waveform_7

Num of Bursts = 18
Burst Interval (us)= 666667

Burst #	Off Time (us)	# Pulses	Chirp (MHz)	PW (us)	Pulse 1 Pri (us)	Pulse 2 Pri (us)	Pulse 3 Pri (us)	Start Loc (us)	Start Burst Interval (us)	End Burst Interval (us)
1	166654	3	8	70	1283	1672	1545	166654	0	666666
2	907218	3	8	80	1497	1252	1456	1078372	666667	1333333
3	688066	1	8	100	1188	0	0	1770643	1333334	2000000
4	297728	2	8	100	1603	1109	0	2069559	2000001	2666667
5	925896	3	8	100	1390	1040	1316	2998167	2666668	3333334
6	838689	3	8	100	1563	1689	1934	3840602	3333335	4000001
7	732633	1	8	75	1078	0	0	4578421	4000002	4666668
8	290909	2	8	65	1812	1044	0	4870408	4666669	5333335
9	956107	1	8	75	1836	0	0	5829371	5333336	6000002
10	275570	1	8	80	1198	0	0	6106777	6000003	6666669
11	1132780	3	8	95	1827	1192	1287	7240755	6666670	7333336
12	336645	1	8	60	1795	0	0	7581706	7333337	8000003
13	935077	3	8	60	1091	1020	1684	8518578	8000004	8666670
14	782785	3	8	75	1551	1287	1263	9305158	8666671	9333337
15	165401	2	8	100	1860	1926	0	9474660	9333338	10000004
16	898106	3	8	60	1669	1236	1437	10376552	10000005	10666671
17	429631	2	8	55	1367	1111	0	10810525	10666672	11333338
18	718570	1	8	65	1733	0	0	11531573	11333339	12000005

Total number of pulses in waveform = 38



Type 5 Radar Waveform_8

Num of Bursts = 16
Burst Interval (us)= 750000

Burst #	Off Time (us)	# Pulses	Chirp (MHz)	PW (us)	Pulse 1 Pri (us)	Pulse 2 Pri (us)	Pulse 3 Pri (us)	Start Loc (us)	Start Burst Interval (us)	End Burst Interval (us)
1	658085	2	18	60	1005	1741	0	658085	0	749999
2	436831	3	18	65	1307	1583	1497	1097662	750000	1499999
3	949984	2	18	90	1108	1309	0	2052033	1500000	2249999
4	899994	1	18	60	1732	0	0	2954444	2250000	2999999
5	265462	1	18	90	1117	0	0	3221638	3000000	3749999
6	864904	1	18	65	1645	0	0	4087659	3750000	4499999
7	988727	1	18	80	1065	0	0	5078031	4500000	5249999
8	516331	1	18	65	1100	0	0	5595427	5250000	5999999
9	1056853	1	18	75	1618	0	0	6653380	6000000	6749999
10	654932	1	18	95	1281	0	0	7309930	6750000	7499999
11	784202	3	18	70	1435	1783	1141	8095413	7500000	8249999
12	831456	3	18	70	1767	1025	1519	8931228	8250000	8999999
13	542867	1	18	95	1808	0	0	9478406	9000000	9749999
14	442403	2	18	50	1041	1452	0	9922617	9750000	10499999
15	1271182	2	18	95	1416	1919	0	11196292	10500000	11249999
16	716227	2	18	95	1338	1022	0	11915854	11250000	11999999

Total number of pulses in waveform = 27

Type 5 Radar Waveform_9

Num of Bursts = 10
Burst Interval (us)= 1200000

Burst #	Off Time (us)	# Pulses	Chirp (MHz)	PW (us)	Pulse 1 Pri (us)	Pulse 2 Pri (us)	Pulse 3 Pri (us)	Start Loc (us)	Start Burst Interval (us)	End Burst Interval (us)
1	886755	3	17	70	1816	1802	1727	886755	0	1199999
2	904748	1	17	95	1679	0	0	1796848	1200000	2399999
3	1174381	1	17	100	1720	0	0	2972908	2400000	3599999
4	1568989	1	17	90	1339	0	0	4543617	3600000	4799999
5	1051076	2	17	50	1759	1459	0	5596032	4800000	5999999
6	1240697	1	17	60	1100	0	0	6839947	6000000	7199999
7	359655	2	17	60	1380	1149	0	7200702	7200000	8399999
8	1754448	2	17	65	1830	1377	0	8957679	8400000	9599999
9	1752411	1	17	95	1805	0	0	10713297	9600000	10799999
10	754851	1	17	50	1332	0	0	11469953	10800000	11999999

Total number of pulses in waveform = 15

Type 5 Radar Waveform_10

Num of Bursts = 15
Burst Interval (us)= 800000

Burst #	Off Time (us)	# Pulses	Chirp (MHz)	PW (us)	Pulse 1 Pri (us)	Pulse 2 Pri (us)	Pulse 3 Pri (us)	Start Loc (us)	Start Burst Interval (us)	End Burst Interval (us)
1	173069	3	12	65	1401	1620	1795	173069	0	799999
2	1067396	3	12	75	1666	1801	1644	1245281	800000	1599999
3	680348	3	12	50	1539	1866	1956	1930740	1600000	2399999
4	966238	1	12	60	1312	0	0	2902339	2400000	3199999
5	864209	1	12	90	1261	0	0	3767860	3200000	3999999
6	364154	1	12	90	1293	0	0	4133275	4000000	4799999
7	1280300	1	12	100	1110	0	0	5414868	4800000	5599999
8	467558	3	12	50	1035	1263	1171	5883536	5600000	6399999
9	1114221	1	12	80	1211	0	0	7001226	6400000	7199999
10	892314	3	12	90	1104	1098	1291	7894751	7200000	7999999
11	330204	2	12	55	1267	1531	0	8228448	8000000	8799999
12	1244995	3	12	75	1569	1759	1586	9476241	8800000	9599999
13	314938	1	12	75	1750	0	0	9796093	9600000	10399999
14	986264	3	12	60	1328	1550	1753	10784107	10400000	11199999
15	1149618	2	12	70	1794	1124	0	11938356	11200000	11999999

Total number of pulses in waveform = 31



Type 5 Radar Waveform_11

Num of Bursts = 13
Burst Interval (us)= 923077

Burst #	Off Time (us)	# Pulses	Chirp (MHz)	PW (us)	Pulse 1 Pri (us)	Pulse 2 Pri (us)	Pulse 3 Pri (us)	Start Loc (us)	Start Burst Interval (us)	End Burst Interval (us)
1	297543	3	8	50	1424	1991	1492	297543	0	923076
2	1533895	1	8	70	1489	0	0	1836345	923077	1846153
3	541800	3	8	50	1676	1525	1773	2379634	1846154	2769230
4	631244	3	8	100	1001	1059	1450	3015852	2769231	3692307
5	957080	3	8	100	1574	1938	1095	3976442	3692308	4615384
6	1550611	1	8	100	1934	0	0	5531660	4615385	5538461
7	149634	3	8	75	1112	1178	1551	5683228	5538462	6461538
8	1064381	3	8	55	1662	1411	1520	6751450	6461539	7384615
9	877325	3	8	80	1922	1078	1745	7633368	7384616	8307692
10	1313869	1	8	60	1205	0	0	8951982	8307693	9230769
11	621429	1	8	50	1084	0	0	9574616	9230770	10153846
12	776756	1	8	65	1471	0	0	10352456	10153847	11076923
13	804929	3	8	75	1786	1689	1671	11158856	11076924	12000000

Total number of pulses in waveform = 29

Type 5 Radar Waveform_12

Num of Bursts = 20
Burst Interval (us)= 600000

Burst #	Off Time (us)	# Pulses	Chirp (MHz)	PW (us)	Pulse 1 Pri (us)	Pulse 2 Pri (us)	Pulse 3 Pri (us)	Start Loc (us)	Start Burst Interval (us)	End Burst Interval (us)
1	27162	3	9	90	1023	1973	1336	27162	0	599999
2	876771	1	9	100	1121	0	0	908265	600000	1199999
3	828307	2	9	80	1920	1492	0	1737693	1200000	1799999
4	134996	3	9	50	1307	1709	1490	1876101	1800000	2399999
5	973897	2	9	80	1675	1748	0	2854304	2400000	2999999
6	365081	3	9	90	1500	1339	1659	3222808	3000000	3599999
7	765868	2	9	50	1013	1663	0	3993164	3600000	4199999
8	264523	3	9	75	1236	1020	1880	4260363	4200000	4799999
9	579350	3	9	70	1172	1586	1381	4843849	4800000	5399999
10	974705	1	9	75	1899	0	0	5822693	5400000	5999999
11	547951	3	9	90	1788	1179	1023	6372543	6000000	6599999
12	619900	3	9	60	1344	1663	1677	6996433	6600000	7199999
13	301829	3	9	70	1115	1411	1064	7302946	7200000	7799999
14	961534	2	9	75	1303	1020	0	8269070	7800000	8399999
15	450379	1	9	75	1506	0	0	8720772	8400000	8999999
16	546474	1	9	90	1683	0	0	9268752	9000000	9599999
17	685949	2	9	60	1052	1260	0	9956384	9600000	10199999
18	415893	1	9	75	1811	0	0	10374589	10200000	10799999
19	549500	3	9	55	1649	1998	1365	10925900	10800000	11399999
20	578985	1	9	95	1241	0	0	11509897	11400000	11999999

Total number of pulses in waveform = 43

Type 5 Radar Waveform_13

Num of Bursts = 16
Burst Interval (us)= 750000

Burst #	Off Time (us)	# Pulses	Chirp (MHz)	PW (us)	Pulse 1 Pri (us)	Pulse 2 Pri (us)	Pulse 3 Pri (us)	Start Loc (us)	Start Burst Interval (us)	End Burst Interval (us)
1	61652	3	12	90	1158	1435	1094	61652	0	749999
2	1343474	3	12	60	1474	1567	1774	1408813	750000	1499999
3	404391	3	12	75	1069	1807	1543	1818019	1500000	2249999
4	607101	3	12	65	1426	1580	1508	2429539	2250000	2999999
5	1016043	2	12	95	1502	1793	0	3450096	3000000	3749999
6	753291	2	12	85	1405	1333	0	4206682	3750000	4499999
7	408387	2	12	85	1875	1266	0	4617807	4500000	5249999
8	862842	3	12	55	1868	1688	1073	5483790	5250000	5999999
9	693509	2	12	85	1321	1614	0	6181928	6000000	6749999
10	722640	2	12	55	1963	1637	0	6907503	6750000	7499999
11	1119027	3	12	65	1905	1815	1535	8030130	7500000	8249999
12	311742	1	12	95	1476	0	0	8347127	8250000	8999999
13	697761	2	12	90	1861	1918	0	9046364	9000000	9749999
14	1007124	2	12	100	1784	1288	0	10057267	9750000	10499999
15	722182	1	12	65	1601	0	0	10782521	10500000	11249999
16	1143855	2	12	60	1492	1945	0	11927977	11250000	11999999

Total number of pulses in waveform = 36



Type 5 Radar Waveform_14

Num of Bursts = 15
Burst Interval (us)= 800000

Burst #	Off Time (us)	# Pulses	Chirp (MHz)	PW (us)	Pulse 1 Pri (us)	Pulse 2 Pri (us)	Pulse 3 Pri (us)	Start Loc (us)	Start Burst Interval (us)	End Burst Interval (us)
1	413148	2	5	85	1030	1003	0	413148	0	799999
2	901189	2	5	90	1139	1131	0	1316370	800000	1599999
3	701510	3	5	100	1615	1907	1595	2020150	1600000	2399999
4	387702	3	5	55	1049	1594	1617	2412969	2400000	3199999
5	1502027	1	5	70	1578	0	0	3919256	3200000	3999999
6	85693	2	5	80	1723	1311	0	4006527	4000000	4799999
7	1039819	3	5	100	1112	1559	1392	5049380	4800000	5599999
8	914066	2	5	90	1476	1637	0	5967509	5600000	6399999
9	586274	3	5	80	1721	1642	1110	6556896	6400000	7199999
10	1431549	3	5	100	1530	1349	1133	7992918	7200000	7999999
11	718093	3	5	70	1990	1069	1497	8715023	8000000	8799999
12	361096	2	5	70	1622	1322	0	9080675	8800000	9599999
13	1225357	1	5	55	1263	0	0	10308976	9600000	10399999
14	273252	2	5	60	1614	1448	0	10583491	10400000	11199999
15	1376978	1	5	75	1012	0	0	11963531	11200000	11999999

Total number of pulses in waveform = 33

Type 5 Radar Waveform_15

Num of Bursts = 13
Burst Interval (us)= 923077

Burst #	Off Time (us)	# Pulses	Chirp (MHz)	PW (us)	Pulse 1 Pri (us)	Pulse 2 Pri (us)	Pulse 3 Pri (us)	Start Loc (us)	Start Burst Interval (us)	End Burst Interval (us)
1	248560	3	19	50	1226	1772	1527	248560	0	923076
2	1324815	2	19	55	1258	1954	0	1577900	923077	1846153
3	1057439	3	19	60	1903	1531	1822	2638551	1846154	2769230
4	559437	3	19	60	1374	1122	1342	3203244	2769231	3692307
5	1191132	1	19	90	1940	0	0	4398214	3692308	4615384
6	677876	3	19	75	1469	1999	1982	5078030	4615385	5538461
7	815994	3	19	80	1185	1415	1594	5899474	5538462	6461538
8	892396	1	19	50	1038	0	0	6796064	6461539	7384615
9	1076775	1	19	75	1965	0	0	7873877	7384616	8307692
10	778516	2	19	95	1370	1831	0	8654358	8307693	9230769
11	583114	1	19	70	1072	0	0	9240673	9230770	10153846
12	1017438	3	19	55	1764	1648	1750	10259183	10153847	11076923
13	924985	1	19	85	1630	0	0	11189330	11076924	12000000

Total number of pulses in waveform = 27

Type 5 Radar Waveform_16

Num of Bursts = 17
Burst Interval (us)= 705882

Burst #	Off Time (us)	# Pulses	Chirp (MHz)	PW (us)	Pulse 1 Pri (us)	Pulse 2 Pri (us)	Pulse 3 Pri (us)	Start Loc (us)	Start Burst Interval (us)	End Burst Interval (us)
1	309378	2	10	65	1569	1272	0	309378	0	705881
2	490905	1	10	55	1596	0	0	803124	705882	1411763
3	1082804	3	10	65	1833	1622	1778	1887524	1411764	2117645
4	398030	1	10	100	1271	0	0	2290787	2117646	2823527
5	1162103	3	10	1955	1081	1677	0	3454161	2823528	3529409
6	692684	2	10	65	1332	1282	0	4151558	3529410	4235291
7	270820	2	10	100	1092	1724	0	4424992	4235292	4941173
8	795838	2	10	60	1186	1707	0	5223646	4941174	5647055
9	1047329	1	10	80	1059	0	0	6273868	5647056	6352937
10	605774	1	10	65	1853	0	0	6880701	6352938	7058819
11	492672	2	10	60	1070	1038	0	7375226	7058820	7764701
12	533528	3	10	85	1166	1888	1363	7910862	7764702	8470583
13	1143421	1	10	85	1815	0	0	9058700	8470584	9176465
14	796314	2	10	100	1441	1167	0	9856829	9176466	9882347
15	371057	3	10	55	1710	1873	1192	10230494	9882348	10588229
16	400344	3	10	95	1517	1523	1091	10635613	10588230	11294111
17	882237	3	10	60	1446	1630	1398	11521981	11294112	11999993

Total number of pulses in waveform = 35



Type 5 Radar Waveform_17

Num of Bursts = 17
Burst Interval (us)= 705882

Burst #	Off Time (us)	# Pulses	Chirp (MHz)	PW (us)	Pulse 1 Pri (us)	Pulse 2 Pri (us)	Pulse 3 Pri (us)	Start Loc (us)	Start Burst Interval (us)	End Burst Interval (us)
1	106904	3	14	70	1284	1002	1117	106904	0	705881
2	666422	2	14	80	1868	1224	0	776729	705882	1411763
3	767042	2	14	65	1061	1314	0	1546863	1411764	2117645
4	854126	1	14	95	1231	0	0	2403364	2117646	2823527
5	1108093	2	14	80	1985	1392	0	3512688	2823528	3529409
6	26764	3	14	85	1506	1086	1994	3542829	3529410	4235291
7	1010050	2	14	65	1061	1354	0	4557465	4235292	4941173
8	865349	2	14	75	1278	1385	0	5425229	4941174	5647055
9	849056	3	14	70	1379	1941	1826	6276948	5647056	6352937
10	697853	1	14	100	1178	0	0	6979947	6352938	7058819
11	212336	1	14	60	1008	0	0	7193461	7058820	7764701
12	1252005	2	14	85	1397	1129	0	8446474	7764702	8470583
13	249277	1	14	75	1871	0	0	8698277	8470584	9176465
14	477224	2	14	65	1984	1629	0	9177372	9176466	9882347
15	715443	2	14	100	1046	1761	0	9896428	9882348	10588229
16	996043	3	14	60	1114	1582	1857	10895278	10588230	11294111
17	1081197	1	14	50	1019	0	0	11981028	11294112	11999993

Total number of pulses in waveform = 33

Type 5 Radar Waveform_18

Num of Bursts = 8
Burst Interval (us)= 1500000

Burst #	Off Time (us)	# Pulses	Chirp (MHz)	PW (us)	Pulse 1 Pri (us)	Pulse 2 Pri (us)	Pulse 3 Pri (us)	Start Loc (us)	Start Burst Interval (us)	End Burst Interval (us)
1	233264	3	6	90	1963	1605	1275	233264	0	1499999
2	1279096	3	6	95	1243	1984	1534	1517203	1500000	2999999
3	2170494	3	6	55	1607	1748	1990	3692458	3000000	4499999
4	1851488	3	6	80	1916	1067	1855	5549291	4500000	5999999
5	1265273	3	6	90	1223	1311	1443	6819402	6000000	7499999
6	1583767	3	6	75	1588	1863	1907	8407146	7500000	8999999
7	1350510	3	6	85	1183	1885	1735	9763014	9000000	10499999
8	864837	2	6	90	1536	1724	0	10632654	10500000	11999999

Total number of pulses in waveform = 23

Type 5 Radar Waveform_19

Num of Bursts = 10
Burst Interval (us)= 1200000

Burst #	Off Time (us)	# Pulses	Chirp (MHz)	PW (us)	Pulse 1 Pri (us)	Pulse 2 Pri (us)	Pulse 3 Pri (us)	Start Loc (us)	Start Burst Interval (us)	End Burst Interval (us)
1	464604	1	18	85	1799	0	0	464604	0	1199999
2	1572194	2	18	100	1495	1809	0	2038597	1200000	2399999
3	975853	2	18	100	1617	1551	0	3017754	2400000	3599999
4	631456	3	18	90	1297	1476	1227	3652378	3600000	4799999
5	1956329	2	18	95	1215	1992	0	5612707	4800000	5999999
6	1106362	1	18	90	1127	0	0	6722276	6000000	7199999
7	1598631	3	18	60	1301	1764	1585	8322034	7200000	8399999
8	800548	1	18	55	1231	0	0	9127232	8400000	9599999
9	1130987	2	18	100	1894	1673	0	10259450	9600000	10799999
10	576897	3	18	50	1807	1317	1842	10839914	10800000	11999999

Total number of pulses in waveform = 20



Type 5 Radar Waveform_20

Num of Bursts = 18
Burst Interval (us)= 666667

Burst #	Off Time (us)	# Pulses	Chirp (MHz)	PW (us)	Pulse 1 Pri (us)	Pulse 2 Pri (us)	Pulse 3 Pri (us)	Start Loc (us)	Start Burst Interval (us)	End Burst Interval (us)
1	161067	2	17	65	1461	1352	0	161067	0	666666
2	1127511	3	17	75	1037	1143	1681	1291391	666667	1333333
3	91533	1	17	75	1835	0	0	1386785	1333334	2000000
4	917408	1	17	60	1025	0	0	2306028	2000001	2666667
5	791413	2	17	80	1629	1834	0	3098466	2666668	3333334
6	686372	2	17	85	1965	1638	0	3788301	3333335	4000001
7	409482	2	17	90	1272	1052	0	4201386	4000002	4666668
8	798196	2	17	80	1186	1794	0	5001906	4666669	5333335
9	846755	3	17	100	1051	1755	1822	5851641	5333336	6000002
10	240945	2	17	50	1029	1745	0	6097214	6000003	6666669
11	1116422	3	17	90	1217	1311	1427	7216410	6666670	7333336
12	469583	2	17	80	1049	1848	0	7689948	7333337	8000003
13	649165	3	17	55	1751	1647	1298	8342010	8000004	8666670
14	956243	3	17	90	1594	1018	1052	9302949	8666671	9333337
15	633459	2	17	100	1703	1180	0	9940072	9333338	10000004
16	546821	3	17	60	1719	1286	1011	10489776	10000005	10666671
17	315205	1	17	100	1579	0	0	10808997	10666672	11333338
18	650926	1	17	70	1169	0	0	11461502	11333339	12000005

Total number of pulses in waveform = 38

Type 5 Radar Waveform_21

Num of Bursts = 15
Burst Interval (us)= 800000

Burst #	Off Time (us)	# Pulses	Chirp (MHz)	PW (us)	Pulse 1 Pri (us)	Pulse 2 Pri (us)	Pulse 3 Pri (us)	Start Loc (us)	Start Burst Interval (us)	End Burst Interval (us)
1	296980	2	12	85	1644	1109	0	296980	0	799999
2	1275357	1	12	100	1429	0	0	1575090	800000	1599999
3	300637	1	12	80	1610	0	0	1877156	1600000	2399999
4	754363	2	12	85	1229	1744	0	2633129	2400000	3199999
5	1203135	1	12	60	1312	0	0	3839237	3200000	3999999
6	562596	1	12	75	1543	0	0	4403145	4000000	4799999
7	737456	1	12	95	1402	0	0	5142144	4800000	5599999
8	856067	2	12	75	1801	1008	0	5999613	5600000	6399999
9	1044673	2	12	80	1290	1284	0	7047095	6400000	7199999
10	703193	1	12	60	1056	0	0	7752862	7200000	7999999
11	826736	3	12	50	1147	1186	1245	8580654	8000000	8799999
12	932971	3	12	55	1940	1499	1799	9517203	8800000	9599999
13	252215	3	12	60	1652	1765	1608	9774656	9600000	10399999
14	891729	3	12	60	1177	1850	1429	10671410	10400000	11199999
15	754170	2	12	100	1530	1564	0	11430036	11200000	11999999

Total number of pulses in waveform = 28

Type 5 Radar Waveform_22

Num of Bursts = 17
Burst Interval (us)= 705882

Burst #	Off Time (us)	# Pulses	Chirp (MHz)	PW (us)	Pulse 1 Pri (us)	Pulse 2 Pri (us)	Pulse 3 Pri (us)	Start Loc (us)	Start Burst Interval (us)	End Burst Interval (us)
1	175795	1	6	85	1379	0	0	175795	0	705881
2	976070	1	6	80	1060	0	0	1153244	705882	1411763
3	623685	3	6	80	1597	1741	1813	1777989	1411764	2117645
4	434262	1	6	60	1649	0	0	2217402	2117646	2823527
5	1089441	1	6	55	1990	0	0	3308492	2823528	3529409
6	674117	2	6	100	1485	1176	0	3984599	3529410	4235291
7	690395	1	6	70	1672	0	0	4677655	4235292	4941173
8	496958	1	6	50	1433	0	0	5176285	4941174	5647055
9	721898	2	6	85	1168	1532	0	5899616	5647056	6352937
10	841882	3	6	55	1510	1983	1454	6744198	6352938	7058819
11	570678	1	6	65	1439	0	0	7319823	7058820	7764701
12	801018	1	6	95	1787	0	0	8122280	7764702	8470583
13	978234	2	6	80	1882	1216	0	9102301	8470584	9176465
14	87764	1	6	70	1851	0	0	9193163	9176466	9882347
15	1145947	3	6	65	1310	1229	1528	10340961	9882348	10588229
16	540094	2	6	80	1092	1333	0	10885122	10588230	11294111
17	665803	2	6	60	1859	1589	0	11553350	11294112	11999993

Total number of pulses in waveform = 28



Type 5 Radar Waveform_23

Num of Bursts = 20
Burst Interval (us) = 600000

Burst #	Off Time (us)	# Pulses	Chirp (MHz)	PW (us)	Pulse 1 Pri (us)	Pulse 2 Pri (us)	Pulse 3 Pri (us)	Start Loc (us)	Start Burst Interval (us)	End Burst Interval (us)
1	4411	3	9	70	1918	1035	1467	4411	0	599999
2	673280	1	9	85	1712	0	0	682111	600000	1199999
3	793873	1	9	90	1420	0	0	1477696	1200000	1799999
4	790036	1	9	80	1178	0	0	2209152	1800000	2399999
5	348977	2	9	55	1376	1861	0	2559307	2400000	2999999
6	486852	1	9	85	1289	0	0	3049396	3000000	3599999
7	921464	2	9	70	1006	1909	0	3972149	3600000	4199999
8	469499	2	9	100	1981	1045	0	4444563	4200000	4799999
9	437750	2	9	100	1619	1361	0	4885339	4800000	5399999
10	887849	1	9	70	1944	0	0	5776168	5400000	5999999
11	636534	3	9	100	1789	1078	1872	6413646	6000000	6599999
12	673068	1	9	55	1600	0	0	7092353	6600000	7199999
13	679508	3	9	100	1063	1196	1443	7773461	7200000	7799999
14	293829	1	9	50	1968	0	0	8070992	7800000	8399999
15	389940	1	9	60	1467	0	0	8462920	8400000	8999999
16	599143	1	9	75	1820	0	0	9063530	9000000	9599999
17	707147	2	9	55	1538	1322	0	9772497	9600000	10199999
18	681461	1	9	80	1586	0	0	10456818	10200000	10799999
19	555552	1	9	80	1803	0	0	11013956	10800000	11399999
20	955850	3	9	95	1864	1907	1939	11971409	11400000	11999999

Total number of pulses in waveform = 33

Type 5 Radar Waveform_24

Num of Bursts = 18
Burst Interval (us) = 666667

Burst #	Off Time (us)	# Pulses	Chirp (MHz)	PW (us)	Pulse 1 Pri (us)	Pulse 2 Pri (us)	Pulse 3 Pri (us)	Start Loc (us)	Start Burst Interval (us)	End Burst Interval (us)
1	38365	1	19	60	1359	0	0	38365	0	666666
2	1064881	3	19	80	1873	1338	1624	1104605	666667	1333333
3	435264	1	19	70	1038	0	0	1544704	1333334	2000000
4	766845	1	19	90	1481	0	0	2312587	2000001	2666667
5	1015959	1	19	75	1034	0	0	3330027	2666668	3333334
6	114674	1	19	65	1245	0	0	3445735	3333335	4000001
7	753160	2	19	55	1936	1640	0	4200140	4000002	4666668
8	553356	3	19	100	1719	1717	1675	4757072	4666669	5333335
9	704724	1	19	65	1656	0	0	5466907	5333336	6000002
10	1132873	3	19	80	1242	1244	1546	6601436	6000003	6666669
11	635706	2	19	90	1507	1722	0	7241174	6666670	7333336
12	370320	1	19	95	1094	0	0	7614723	7333337	8000003
13	813955	3	19	90	1847	1270	1570	8429772	8000004	8666670
14	840880	2	19	80	1589	1778	0	9275339	8666671	9333337
15	433153	3	19	75	1604	1716	1530	9711859	9333338	10000004
16	404935	1	19	60	1587	0	0	10121644	10000005	10666671
17	940992	3	19	80	1475	1186	1611	11064223	10666672	11333338
18	275346	1	19	100	1255	0	0	11343841	11333339	12000005

Total number of pulses in waveform = 33

Type 5 Radar Waveform_25

Num of Bursts = 14
Burst Interval (us) = 857143

Burst #	Off Time (us)	# Pulses	Chirp (MHz)	PW (us)	Pulse 1 Pri (us)	Pulse 2 Pri (us)	Pulse 3 Pri (us)	Start Loc (us)	Start Burst Interval (us)	End Burst Interval (us)
1	335758	2	5	75	1459	1194	0	335758	0	857142
2	849870	3	5	65	1179	1587	1430	1188281	857143	1714285
3	1047487	3	5	65	1334	1751	1116	2239964	1714286	2571428
4	867961	1	5	70	1503	0	0	3112126	2571429	3428571
5	1051011	2	5	95	1154	1855	0	4164640	3428572	4285714
6	278512	3	5	90	1874	1810	1036	4446161	4285715	5142857
7	1363774	2	5	85	1011	1779	0	5814655	5142858	6000000
8	568808	2	5	95	1006	1823	0	6386253	6000001	6857143
9	515460	2	5	80	1676	1197	0	6904542	6857144	7714286
10	1053006	3	5	85	1823	1987	1869	7960421	7714287	8571429
11	666074	1	5	55	1993	0	0	8632174	8571430	9428572
12	1424321	2	5	60	1863	1907	0	10058488	9428573	10285715
13	900759	2	5	65	1342	1825	0	10963017	10285716	11142858
14	353376	1	5	75	1647	0	0	11319560	11142859	12000001

Total number of pulses in waveform = 29



Type 5 Radar Waveform_26

Num of Bursts = 18
Burst Interval (us)= 666667

Burst #	Off Time (us)	# Pulses	Chirp (MHz)	PW (us)	Pulse 1 Pri (us)	Pulse 2 Pri (us)	Pulse 3 Pri (us)	Start Loc (us)	Start Burst Interval (us)	End Burst Interval (us)
1	645250	2	10	70	1726	1344	0	645250	0	666666
2	142417	1	10	70	1790	0	0	790737	666667	1333333
3	1130598	1	10	60	1399	0	0	1923125	1333334	2000000
4	298500	3	10	60	1967	1122	1136	2223024	2000001	2666667
5	1014113	3	10	55	1306	1223	1532	3241362	2666668	3333334
6	167359	3	10	60	1202	1509	1071	3412782	3333335	4000001
7	1117804	1	10	80	1089	0	0	4534368	4000002	4666668
8	739216	3	10	55	1839	1329	1166	5274673	4666669	5333335
9	669256	1	10	50	1420	0	0	5948263	5333336	6000002
10	523062	3	10	60	1805	1715	1913	6472745	6000003	6666669
11	312728	2	10	100	1735	1534	0	6790906	6666670	7333336
12	574125	1	10	65	1232	0	0	7368300	7333337	8000003
13	1123975	3	10	95	1043	1669	1665	8493507	8000004	8666670
14	533439	1	10	90	1704	0	0	9031323	8666671	9333337
15	551398	2	10	55	1150	1515	0	9584425	9333338	10000004
16	419232	2	10	85	1026	1074	0	10006322	10000005	10666671
17	1127054	1	10	95	1336	0	0	11135476	10666672	11333338
18	418476	1	10	55	1221	0	0	11555288	11333339	12000005

Total number of pulses in waveform = 34

Type 5 Radar Waveform_27

Num of Bursts = 14
Burst Interval (us)= 857143

Burst #	Off Time (us)	# Pulses	Chirp (MHz)	PW (us)	Pulse 1 Pri (us)	Pulse 2 Pri (us)	Pulse 3 Pri (us)	Start Loc (us)	Start Burst Interval (us)	End Burst Interval (us)
1	218164	1	14	50	1822	0	0	218164	0	857142
2	1450486	3	14	80	1747	1585	1339	1670472	857143	1714285
3	97423	2	14	65	1090	1291	0	1772566	1714286	2571428
4	1167433	1	14	95	1551	0	0	2942380	2571429	3428571
5	1043847	2	14	95	1830	1178	0	3987778	3428572	4285714
6	576280	3	14	95	1834	1035	1351	4567066	4285715	5142857
7	1379669	2	14	90	1895	1356	0	5950955	5142858	6000000
8	848700	3	14	65	1940	1325	1095	6802906	6000001	6857143
9	335454	1	14	70	1300	0	0	7142720	6857144	7714286
10	1214006	2	14	70	1557	1415	0	8358026	7714287	8571429
11	845414	3	14	80	1398	1963	1277	9206412	8571430	9428572
12	911487	3	14	65	1300	1449	1547	10122537	9428573	10285715
13	579419	3	14	65	1577	1628	1550	10706252	10285716	11142858
14	563998	3	14	65	1790	1275	1563	11275005	11142859	12000001

Total number of pulses in waveform = 32

Type 5 Radar Waveform_28

Num of Bursts = 10
Burst Interval (us)= 1200000

Burst #	Off Time (us)	# Pulses	Chirp (MHz)	PW (us)	Pulse 1 Pri (us)	Pulse 2 Pri (us)	Pulse 3 Pri (us)	Start Loc (us)	Start Burst Interval (us)	End Burst Interval (us)
1	250954	3	8	85	1437	1926	1327	250954	0	1199999
2	1664755	1	8	50	1586	0	0	1920399	1200000	2399999
3	1307257	3	8	75	1707	1506	1167	3229242	2400000	3599999
4	1077124	2	8	55	1762	1696	0	4310746	3600000	4799999
5	815869	1	8	85	1978	0	0	5130073	4800000	5999999
6	1642501	2	8	60	1896	1081	0	6774552	6000000	7199999
7	1373606	3	8	60	1395	1968	1708	8151135	7200000	8399999
8	310506	2	8	85	1673	1504	0	8466712	8400000	9599999
9	2244285	3	8	80	1885	1175	1489	10714174	9600000	10799999
10	1186603	2	8	95	1586	1187	0	11905326	10800000	11999999

Total number of pulses in waveform = 22



Type 5 Radar Waveform_29

Num of Bursts = 18
Burst Interval (us)= 666667

Burst #	Off Time (us)	# Pulses	Chirp (MHz)	PW (us)	Pulse 1 Pri (us)	Pulse 2 Pri (us)	Pulse 3 Pri (us)	Start Loc (us)	Start Burst Interval (us)	End Burst Interval (us)
1	59878	3	17	80	1936	1594	1397	59878	0	666666
2	1227467	2	17	75	1848	1520	0	1292272	666667	1333333
3	500821	2	17	75	1240	1784	0	1796461	1333334	2000000
4	530181	1	17	60	1794	0	0	2329666	2000001	2666667
5	587205	1	17	95	1543	0	0	2918665	2666668	3333334
6	999235	3	17	95	1114	1476	1681	3919443	3333335	4000001
7	243233	3	17	85	1242	1513	1366	4166947	4000002	4666668
8	600245	3	17	100	1973	1489	1262	4771313	4666669	5333335
9	1178449	1	17	55	1941	0	0	5954486	5333336	6000002
10	310455	2	17	55	1298	1602	0	6266882	6000003	6666669
11	504521	1	17	65	1908	0	0	6774303	6666670	7333336
12	637014	2	17	50	1317	1756	0	7413225	7333337	8000003
13	1084695	3	17	85	1613	1059	1003	8500993	8000004	8666670
14	613680	2	17	50	1454	1905	0	9118348	8666671	9333337
15	660999	1	17	80	1088	0	0	9782706	9333338	10000004
16	424497	1	17	80	1082	0	0	10208291	10000005	10666671
17	896341	2	17	85	1833	1839	0	11105714	10666672	11333338
18	500824	3	17	70	1277	1076	1107	11610210	11333339	12000005

Total number of pulses in waveform = 36

Type 5 Radar Waveform_30

Num of Bursts = 8
Burst Interval (us)= 1500000

Burst #	Off Time (us)	# Pulses	Chirp (MHz)	PW (us)	Pulse 1 Pri (us)	Pulse 2 Pri (us)	Pulse 3 Pri (us)	Start Loc (us)	Start Burst Interval (us)	End Burst Interval (us)
1	621587	2	18	65	1387	1946	0	621587	0	1499999
2	1968587	1	18	80	1087	0	0	2593507	1500000	2999999
3	1273745	1	18	60	1810	0	0	3868339	3000000	4499999
4	741059	1	18	80	1740	0	0	4611208	4500000	5999999
5	1714855	2	18	55	1104	1724	0	6327803	6000000	7499999
6	2576710	2	18	85	1862	1363	0	8907341	7500000	8999999
7	393586	2	18	80	1560	1001	0	9304152	9000000	10499999
8	1872961	3	18	70	1833	1638	1312	11179674	10500000	11999999

Total number of pulses in waveform = 14



Radar Type 6 - Radar Statistical Performance

Trail #	Test Freq. (MHz)	1=Detection 0=No Detection	Trail #	Test Freq. (MHz)	1=Detection 0=No Detection
1	5491	1	16	5500	1
2	5491	1	17	5500	1
3	5491	1	18	5500	1
4	5491	1	19	5500	1
5	5491	1	20	5500	1
6	5491	1	21	5509	1
7	5491	1	22	5509	1
8	5491	1	23	5509	1
9	5491	1	24	5509	1
10	5491	1	25	5509	1
11	5500	1	26	5509	1
12	5500	1	27	5509	1
13	5500	1	28	5509	1
14	5500	1	29	5509	1
15	5500	1	30	5509	1
Detection Percentage (%)					100%



Radar waveform #1			Radar waveform #2		
Hopping Number	Frequency (MHz)	Pulse Start (ms)	Hopping Number	Frequency (MHz)	Pulse Start (ms)
2	5512	6	6	5466	18
10	5484	30	26	5461	78
31	5520	93	31	5519	93
34	5482	102	52	5509	156
36	5499	108	54	5508	162
44	5511	132	55	5487	165
48	5474	144	68	5472	204
56	5480	168	72	5518	216
62	5461	186	85	5479	255
84	5460	252	92	5489	276
--	--	--	98	5484	294

Radar waveform #3			Radar waveform #4		
Hopping Number	Frequency (MHz)	Pulse Start (ms)	Hopping Number	Frequency (MHz)	Pulse Start (ms)
2	5499	6	4	5511	12
9	5464	27	5	5472	15
11	5468	33	18	5463	54
15	5475	45	30	5477	90
21	5491	63	32	5515	96
28	5469	84	37	5512	111
29	5481	87	47	5513	141
31	5483	93	65	5518	195
50	5492	150	70	5461	210
53	5484	159	82	5481	246
57	5487	171	95	5500	285
74	5479	222	--	--	--
78	5474	234	--	--	--
98	5506	294	--	--	--



Radar waveform #5			Radar waveform #6		
Hopping Number	Frequency (MHz)	Pulse Start (ms)	Hopping Number	Frequency (MHz)	Pulse Start (ms)
12	5468	36	4	5465	12
17	5490	51	6	5471	18
19	5478	57	11	5462	33
21	5501	63	12	5464	36
24	5520	72	18	5479	54
25	5469	75	23	5486	69
34	5505	102	30	5484	90
43	5518	129	34	5520	102
45	5472	135	35	5497	105
50	5504	150	38	5470	114
53	5462	159	49	5507	147
65	5483	195	68	5472	204
75	5516	225	69	5488	207
--	--	--	76	5463	228
--	--	--	87	5505	261
--	--	--	88	5466	264
--	--	--	98	5491	294



Radar waveform #7			Radar waveform #8		
Hopping Number	Frequency (MHz)	Pulse Start (ms)	Hopping Number	Frequency (MHz)	Pulse Start (ms)
3	5487	9	0	5509	0
4	5493	12	3	5519	9
8	5501	24	4	5494	12
14	5499	42	6	5496	18
23	5472	69	13	5518	39
29	5465	87	21	5503	63
31	5467	93	27	5486	81
45	5517	135	28	5463	84
55	5508	165	39	5498	117
60	5460	180	44	5490	132
71	5504	213	48	5461	144
80	5512	240	57	5460	171
89	5485	267	72	5507	216
93	5495	279	73	5481	219
99	5484	297	75	5464	225
--	--	--	76	5516	228
--	--	--	80	5510	240
--	--	--	86	5478	258
--	--	--	92	5472	276
--	--	--	94	5462	282



Radar waveform #9			Radar waveform #10		
Hopping Number	Frequency (MHz)	Pulse Start (ms)	Hopping Number	Frequency (MHz)	Pulse Start (ms)
6	5473	18	24	5472	72
12	5518	36	27	5483	81
15	5480	45	28	5509	84
17	5504	51	42	5470	126
21	5498	63	44	5478	132
29	5481	87	45	5471	135
54	5496	162	48	5515	144
55	5472	165	67	5460	201
62	5515	186	74	5507	222
76	5512	228	77	5498	231
77	5509	231	81	5516	243
89	5462	267	99	5473	297
93	5495	279	--	--	--

Radar waveform #11			Radar waveform #12		
Hopping Number	Frequency (MHz)	Pulse Start (ms)	Hopping Number	Frequency (MHz)	Pulse Start (ms)
0	5510	0	10	5481	30
8	5473	24	28	5471	84
14	5489	42	34	5503	102
19	5470	57	58	5493	174
20	5523	60	67	5526	201
21	5494	63	73	5517	219
35	5482	105	81	5524	243
46	5526	138	87	5528	261
49	5485	147	89	5473	267
69	5471	207	98	5516	294
87	5488	261	99	5518	297
90	5490	270	--	--	--
99	5477	297	--	--	--

Radar waveform #13			Radar waveform #14		
Hopping Number	Frequency (MHz)	Pulse Start (ms)	Hopping Number	Frequency (MHz)	Pulse Start (ms)
10	5471	30	1	5521	3
16	5472	48	13	5496	39
30	5487	90	22	5499	66
42	5511	126	25	5477	75
51	5479	153	29	5519	87
55	5519	165	30	5474	90
58	5512	174	36	5530	108
63	5520	189	54	5502	162
65	5515	195	57	5510	171
74	5508	222	68	5486	204
76	5489	228	73	5516	219
84	5494	252	75	5472	225
86	5527	258	84	5500	252
95	5522	285	89	5471	267
--	--	--	93	5526	279

Radar waveform #15			Radar waveform #16		
Hopping Number	Frequency (MHz)	Pulse Start (ms)	Hopping Number	Frequency (MHz)	Pulse Start (ms)
1	5489	3	7	5473	21
6	5506	18	28	5490	84
17	5478	51	32	5484	96
27	5509	81	34	5474	102
40	5494	120	48	5497	144
46	5507	138	49	5529	147
49	5505	147	52	5477	156
50	5472	150	65	5525	195
85	5513	255	71	5519	213
87	5501	261	81	5486	243
90	5529	270	91	5498	273
97	5514	291	92	5471	276
--	--	--	93	5495	279
--	--	--	97	5500	291



Radar waveform #17			Radar waveform #18		
Hopping Number	Frequency (MHz)	Pulse Start (ms)	Hopping Number	Frequency (MHz)	Pulse Start (ms)
11	5493	33	4	5517	12
20	5475	60	6	5494	18
26	5506	78	8	5499	24
36	5487	108	15	5518	45
55	5476	165	16	5504	48
67	5481	201	34	5502	102
71	5507	213	41	5501	123
73	5517	219	42	5487	126
88	5477	264	43	5491	129
--	--	--	63	5513	189
--	--	--	64	5486	192
--	--	--	66	5477	198
--	--	--	71	5525	213
--	--	--	76	5509	228
--	--	--	79	5507	237

Radar waveform #19			Radar waveform #20		
Hopping Number	Frequency (MHz)	Pulse Start (ms)	Hopping Number	Frequency (MHz)	Pulse Start (ms)
1	5477	3	1	5476	3
8	5530	24	6	5483	18
9	5499	27	15	5529	45
14	5485	42	21	5501	63
29	5473	87	29	5470	87
38	5521	114	65	5473	195
45	5510	135	67	5495	201
51	5471	153	69	5504	207
69	5491	207	70	5472	210
80	5507	240	78	5487	234
82	5527	246	82	5518	246
--	--	--	85	5489	255
--	--	--	97	5513	291



Radar waveform #21			Radar waveform #22		
Hopping Number	Frequency (MHz)	Pulse Start (ms)	Hopping Number	Frequency (MHz)	Pulse Start (ms)
2	5540	6	1	5527	3
4	5537	12	4	5509	12
8	5524	24	12	5521	36
19	5485	57	21	5499	63
29	5536	87	22	5519	66
31	5526	93	25	5495	75
40	5538	120	37	5531	111
55	5520	165	39	5508	117
64	5497	192	55	5525	165
72	5512	216	59	5529	177
75	5510	225	64	5515	192
76	5505	228	65	5504	195
77	5483	231	70	5494	210
86	5531	258	87	5507	261
96	5502	288	--	--	--

Radar waveform #23			Radar waveform #24		
Hopping Number	Frequency (MHz)	Pulse Start (ms)	Hopping Number	Frequency (MHz)	Pulse Start (ms)
25	5510	75	3	5512	9
26	5523	78	9	5500	27
35	5485	105	20	5530	60
38	5524	114	27	5487	81
48	5499	144	30	5522	90
67	5512	201	36	5538	108
75	5492	225	38	5517	114
79	5526	237	40	5521	120
89	5487	267	50	5536	150
--	--	--	51	5533	153
--	--	--	55	5506	165
--	--	--	80	5481	240
--	--	--	85	5480	255
--	--	--	88	5519	264



Radar waveform #25			Radar waveform #26		
Hopping Number	Frequency (MHz)	Pulse Start (ms)	Hopping Number	Frequency (MHz)	Pulse Start (ms)
3	5513	9	3	5496	9
14	5484	42	8	5481	24
33	5482	99	14	5518	42
52	5491	156	23	5509	69
54	5481	162	29	5529	87
55	5485	165	39	5499	117
56	5493	168	40	5513	120
64	5534	192	41	5497	123
71	5497	213	61	5516	183
77	5506	231	70	5525	210
81	5518	243	73	5515	219
85	5508	255	88	5491	264
89	5540	267	96	5532	288

Radar waveform #27			Radar waveform #28		
Hopping Number	Frequency (MHz)	Pulse Start (ms)	Hopping Number	Frequency (MHz)	Pulse Start (ms)
4	5522	12	1	5503	3
7	5513	21	17	5537	51
13	5518	39	18	5484	54
38	5505	114	28	5492	84
69	5482	207	29	5539	87
78	5526	234	34	5519	102
80	5484	240	35	5506	105
86	5481	258	43	5493	129
87	5495	261	46	5532	138
95	5485	285	47	5485	141
--	--	--	49	5497	147
--	--	--	61	5508	183
--	--	--	63	5523	189
--	--	--	71	5531	213
--	--	--	77	5527	231
--	--	--	84	5495	252

Radar waveform #29			Radar waveform #30		
Hopping Number	Frequency (MHz)	Pulse Start (ms)	Hopping Number	Frequency (MHz)	Pulse Start (ms)
2	5496	6	12	5506	36
10	5517	30	20	5531	60
11	5500	33	27	5481	81
29	5532	87	30	5515	90
41	5510	123	31	5519	93
61	5486	183	33	5483	99
73	5498	219	46	5539	138
75	5481	225	48	5495	144
77	5521	231	64	5510	192
79	5490	237	76	5537	228
83	5506	249	87	5484	261
88	5495	264	90	5514	270
94	5533	282	93	5499	279



Radar Statistical Performance for 802.11n-HT40

Radar Type 1 - Radar Statistical Performance

Trail #	Test Freq. (MHz)	Pulse Width (us)	PRI (us)	Pulses / Burst	1=Detection 0=No Detection
1	5491	1	738	72	1
2	5491	1	678	78	1
3	5491	1	658	81	1
4	5491	1	858	62	1
5	5500	1	918	58	1
6	5500	1	618	86	1
7	5500	1	838	63	1
8	5500	1	538	99	1
9	5509	1	758	70	1
10	5509	1	818	65	1
11	5509	1	578	92	1
12	5509	1	878	61	1
13	5510	1	718	74	1
14	5510	1	638	83	1
15	5510	1	898	59	1
16	5510	1	969	55	1
17	5510	1	2097	26	1
18	5510	1	781	68	1
19	5511	1	3055	18	1
20	5511	1	1968	27	1
21	5511	1	2083	26	1
22	5511	1	675	79	1
23	5520	1	2429	22	1
24	5520	1	736	72	1
25	5520	1	2595	21	1
26	5520	1	2840	19	1
27	5529	1	887	60	1
28	5529	1	1806	30	1
29	5529	1	604	88	1
30	5529	1	2104	26	1
Detection Percentage (%)					100%



Radar Type 2 - Radar Statistical Performance

Trail #	Test Freq. (MHz)	Pulse Width (us)	PRI (us)	Pulses / Burst	1=Detection 0=No Detection
1	5491	1.0	158	25	1
2	5491	1.1	153	29	1
3	5491	1.3	197	28	1
4	5491	4.9	223	28	1
5	5500	5.0	209	27	1
6	5500	1.3	196	23	1
7	5500	1.7	150	24	1
8	5500	1.7	166	27	1
9	5509	4.8	191	23	1
10	5509	1.2	163	26	1
11	5509	1.3	214	29	1
12	5509	1.8	221	24	1
13	5510	2.9	172	26	1
14	5510	3.9	209	29	1
15	5510	2.0	205	29	1
16	5510	3.4	152	27	1
17	5510	4.9	201	27	1
18	5510	3.3	214	27	1
19	5511	1.3	192	23	1
20	5511	2.2	152	29	1
21	5511	1.6	178	26	1
22	5511	4.1	175	25	1
23	5520	1.0	173	29	1
24	5520	2.6	206	28	1
25	5520	4.4	185	26	1
26	5520	3.8	212	23	1
27	5529	2.3	179	25	1
28	5529	2.6	169	25	1
29	5529	1.0	153	29	1
30	5529	2.7	199	24	1
Detection Percentage (%)					100%



Radar Type 3 - Radar Statistical Performance

Trail #	Test Freq. (MHz)	Pulse Width (us)	PRI (us)	Pulses / Burst	1=Detection 0=No Detection
1	5491	6.7	472	16	1
2	5491	8.4	358	16	1
3	5491	8.2	421	16	1
4	5491	8.0	389	18	1
5	5500	8.6	415	16	1
6	5500	8.1	281	17	1
7	5500	8.1	336	16	1
8	5500	7.3	293	16	1
9	5509	8.2	347	17	1
10	5509	7.9	477	18	1
11	5509	9.7	453	18	1
12	5509	8.1	339	16	1
13	5510	7.4	490	17	1
14	5510	6.1	379	16	1
15	5510	6.6	310	17	1
16	5510	9.7	378	17	1
17	5510	6.2	371	18	1
18	5510	9.2	330	16	1
19	5511	8.7	254	16	1
20	5511	9.3	401	17	1
21	5511	9.1	500	16	1
22	5511	7.4	322	16	1
23	5520	6.9	356	17	1
24	5520	8.1	416	17	1
25	5520	9.2	411	18	1
26	5520	7.4	288	17	1
27	5529	9.6	327	18	1
28	5529	9.8	349	16	1
29	5529	7.8	377	17	1
30	5529	7.2	411	18	1
Detection Percentage (%)					100%



Radar Type 4 - Radar Statistical Performance

Trail #	Test Freq. (MHz)	Pulse Width (us)	PRI (us)	Pulses / Burst	1=Detection 0=No Detection
1	5491	11.2	326	13	1
2	5491	15.6	438	15	1
3	5491	15.8	332	14	1
4	5491	11.7	342	12	1
5	5500	18.1	436	15	1
6	5500	18.9	445	16	1
7	5500	19.4	448	16	1
8	5500	19.6	473	16	1
9	5509	13.5	457	14	1
10	5509	17.6	466	14	1
11	5509	14.3	297	14	1
12	5509	13.5	349	15	1
13	5510	11.6	273	14	1
14	5510	13.0	346	15	1
15	5510	15.0	500	14	1
16	5510	15.1	275	15	1
17	5510	14.1	361	15	1
18	5510	19.8	351	14	1
19	5511	12.9	443	15	1
20	5511	12.9	349	15	1
21	5511	12.5	373	15	1
22	5511	17.2	468	12	1
23	5520	18.6	258	13	1
24	5520	13.2	359	16	1
25	5520	16.4	493	15	1
26	5520	13.1	351	15	1
27	5529	18.1	474	13	1
28	5529	19.4	401	15	1
29	5529	17.1	339	14	1
30	5529	13.9	282	13	1
Detection Percentage (%)					100%

Note: In addition an average minimum percentage of successful detection across all four Short pulse radar test

waveforms is as follows:
$$\frac{P_d1+P_d2+P_d3+P_d4}{4} = (100\%+100\%+100\%+100\%)/4 = 100\% (>80\%)$$



Radar Type 5 - Radar Statistical Performance

Trail #	Test Freq. (MHz)	1=Detection 0=No Detection	Trail #	Test Freq. (MHz)	1=Detection 0=No Detection
1	5494.2	1	16	5510.0	1
2	5498.2	1	17	5510.0	1
3	5493.4	1	18	5510.0	1
4	5495.8	1	19	5510.0	1
5	5498.6	1	20	5510.0	1
6	5494.6	1	21	5521.8	1
7	5493.0	1	22	5525.8	1
8	5495.0	1	23	5521.4	1
9	5496.6	1	24	5525.4	1
10	5497.8	1	25	5525.0	1
11	5510.0	1	26	5524.2	1
12	5510.0	1	27	5526.6	1
13	5510.0	1	28	5522.2	1
14	5510.0	1	29	5527.0	1
15	5510.0	1	30	5523.4	1
Detection Percentage (%)					100%

Type 5 Radar Waveform_1										
Num of Bursts = 11										
Burst Interval (us)= 1090909										
Burst #	Off Time (us)	# Pulses	Chirp (MHz)	PW (us)	Pulse 1 Pri (us)	Pulse 2 Pri (us)	Pulse 3 Pri (us)	Start Loc (us)	Start Burst Interval (us)	End Burst Interval (us)
1	1009648	1	8	55	1808	0	0	1009648	0	1090908
2	707453	1	8	75	1693	0	0	1718909	1090909	2181817
3	1208196	1	8	100	1878	0	0	2928798	2181818	3272726
4	401006	1	8	70	1009	0	0	3331682	3272727	4363635
5	2070838	1	8	60	1959	0	0	5403529	4363636	5454544
6	699738	3	8	70	1888	1667	1266	6105226	5454545	6545453
7	842416	2	8	80	1408	1003	0	6952463	6545454	7636362
8	1104648	2	8	100	1607	1515	0	8059522	7636363	8727271
9	681009	1	8	60	1835	0	0	8743653	8727272	9818180
10	1586430	1	8	100	1980	0	0	10331918	9818181	10909089
11	928982	1	8	50	1710	0	0	11262880	10909090	11999998
Total number of pulses in waveform = 15										



Type 5 Radar Waveform_2

Num of Bursts = 19
Burst Interval (us)= 631579

Burst #	Off Time (us)	# Pulses	Chirp (MHz)	PW (us)	Pulse 1 Pri (us)	Pulse 2 Pri (us)	Pulse 3 Pri (us)	Start Loc (us)	Start Burst Interval (us)	End Burst Interval (us)
1	370807	2	18	75	1019	1008	0	370807	0	631578
2	266889	3	18	100	1412	1668	1977	639523	631579	1263157
3	978129	2	18	90	1951	1187	0	1622709	1263158	1894736
4	753742	1	18	65	1309	0	0	2379589	1894737	2526315
5	163498	1	18	60	1592	0	0	2544396	2526316	3157894
6	1185354	3	18	80	1002	1969	1428	3731342	3157895	3789473
7	340726	1	18	60	1394	0	0	4078467	3789474	4421052
8	353343	3	18	100	1514	1346	1302	4431204	4421053	5052631
9	1153097	1	18	65	1839	0	0	5588463	5052632	5684210
10	384869	1	18	90	1323	0	0	5975171	5684211	6315789
11	374254	1	18	90	1217	0	0	6350748	6315790	6947368
12	987418	2	18	65	1610	1378	0	7339383	6947369	7578947
13	244712	3	18	55	1796	1885	1287	7587083	7578948	8210526
14	816331	1	18	90	1497	0	0	8408382	8210527	8842105
15	1001592	1	18	65	1008	0	0	9411471	8842106	9473684
16	332247	1	18	50	1433	0	0	9744726	9473685	10105263
17	849149	1	18	50	1339	0	0	10595308	10105264	10738842
18	253222	2	18	100	1694	1900	0	10849869	10738843	11368421
19	905687	1	18	80	1738	0	0	11759150	11368422	12000000

Total number of pulses in waveform = 31

Type 5 Radar Waveform_3

Num of Bursts = 20
Burst Interval (us)= 600000

Burst #	Off Time (us)	# Pulses	Chirp (MHz)	PW (us)	Pulse 1 Pri (us)	Pulse 2 Pri (us)	Pulse 3 Pri (us)	Start Loc (us)	Start Burst Interval (us)	End Burst Interval (us)
1	169363	1	6	60	1164	0	0	169363	0	599999
2	505519	2	6	75	1990	1079	0	676046	600000	1199999
3	688815	3	6	65	1904	1647	1869	1367930	1200000	1799999
4	811413	2	6	100	1675	1579	0	2184763	1800000	2399999
5	521960	1	6	70	1678	0	0	2709977	2400000	2999999
6	576145	3	6	70	1113	1906	1552	3287800	3000000	3599999
7	858252	1	6	55	1922	0	0	4150623	3600000	4199999
8	470174	3	6	50	1123	1700	1448	4622719	4200000	4799999
9	326057	2	6	65	1457	1534	0	4953047	4800000	5399999
10	1009614	3	6	90	1700	1525	1993	5965652	5400000	5999999
11	604094	2	6	60	1315	1701	0	6574964	6000000	6599999
12	589317	3	6	90	1251	1364	1941	7137297	6600000	7199999
13	518261	2	6	85	1941	1744	0	7660114	7200000	7799999
14	616325	2	6	100	1394	1637	0	8280124	7800000	8399999
15	157432	2	6	95	1421	1097	0	8440487	8400000	8999999
16	1008031	2	6	75	1609	1847	0	9451036	9000000	9599999
17	266903	3	6	60	1982	1703	1141	9721395	9600000	10199999
18	501017	1	6	55	1087	0	0	10227238	10200000	10799999
19	943198	3	6	100	1641	1688	1052	11171523	10800000	11399999
20	564741	2	6	90	1820	1926	0	11740645	11400000	11999999

Total number of pulses in waveform = 43

Type 5 Radar Waveform_4

Num of Bursts = 10
Burst Interval (us)= 1200000

Burst #	Off Time (us)	# Pulses	Chirp (MHz)	PW (us)	Pulse 1 Pri (us)	Pulse 2 Pri (us)	Pulse 3 Pri (us)	Start Loc (us)	Start Burst Interval (us)	End Burst Interval (us)
1	1035537	1	12	80	1807	0	0	1035537	0	1199999
2	307961	3	12	50	1670	1974	1385	1345305	1200000	2399999
3	2223635	1	12	60	1813	0	0	3573969	2400000	3599999
4	1098253	3	12	90	1164	1263	1946	4674035	3600000	4799999
5	266526	1	12	80	1858	0	0	4944934	4800000	5999999
6	1503731	2	12	55	1564	1718	0	6450523	6000000	7199999
7	1041635	3	12	85	1129	1053	1639	7495440	7200000	8399999
8	957227	1	12	50	1609	0	0	8456488	8400000	9599999
9	2107476	3	12	55	1566	1785	1074	10565573	9600000	10799999
10	400524	2	12	60	1410	1727	0	10970522	10800000	11999999

Total number of pulses in waveform = 20



Type 5 Radar Waveform_5

Num of Bursts = 16
Burst Interval (us)= 750000

Burst #	Off Time (us)	# Pulses	Chirp (MHz)	PW (us)	Pulse 1 Pri (us)	Pulse 2 Pri (us)	Pulse 3 Pri (us)	Start Loc (us)	Start Burst Interval (us)	End Burst Interval (us)
1	705977	1	19	95	1361	0	0	705977	0	749999
2	357544	3	19	70	1532	1119	1439	1064882	750000	1499999
3	1132771	1	19	80	1884	0	0	2201743	1500000	2249999
4	629610	3	19	75	1798	1443	1852	2833237	2250000	2999999
5	553670	3	19	50	1856	1840	1519	3392000	3000000	3749999
6	1024949	2	19	50	1631	1749	0	4422164	3750000	4499999
7	376460	2	19	100	1672	1749	0	4802004	4500000	5249999
8	990653	3	19	90	1333	1338	1788	5796078	5250000	5999999
9	471041	3	19	80	1218	1724	1573	6271578	6000000	6749999
10	530405	2	19	50	1954	1756	0	6806498	6750000	7499999
11	1164783	1	19	55	1294	0	0	7974991	7500000	8249999
12	372317	2	19	100	1779	1977	0	8348602	8250000	8999999
13	698569	2	19	80	1676	1038	0	9050927	9000000	9749999
14	1243219	1	19	90	1438	0	0	10296860	9750000	10499999
15	326212	2	19	90	1701	1578	0	10624510	10500000	11249999
16	954671	3	19	50	1757	1554	1679	11582460	11250000	11999999

Total number of pulses in waveform = 34

Type 5 Radar Waveform_6

Num of Bursts = 16
Burst Interval (us)= 750000

Burst #	Off Time (us)	# Pulses	Chirp (MHz)	PW (us)	Pulse 1 Pri (us)	Pulse 2 Pri (us)	Pulse 3 Pri (us)	Start Loc (us)	Start Burst Interval (us)	End Burst Interval (us)
1	158221	1	9	70	1726	0	0	158221	0	749999
2	792690	2	9	65	1332	1833	0	952637	750000	1499999
3	1290349	1	9	55	1975	0	0	2246151	1500000	2249999
4	199089	3	9	90	1484	1298	1176	2447215	2250000	2999999
5	629284	3	9	95	1741	1577	1253	3080457	3000000	3749999
6	1078879	2	9	75	1104	1366	0	4163907	3750000	4499999
7	389202	1	9	50	1787	0	0	4555579	4500000	5249999
8	1189202	1	9	85	1989	0	0	5746568	5250000	5999999
9	883780	2	9	90	1247	1604	0	6632337	6000000	6749999
10	657267	2	9	90	1072	1031	0	7292455	6750000	7499999
11	608985	2	9	55	1662	1658	0	7903543	7500000	8249999
12	927731	2	9	50	1522	1140	0	8834594	8250000	8999999
13	352952	1	9	50	1725	0	0	9190208	9000000	9749999
14	610971	1	9	55	1478	0	0	9802904	9750000	10499999
15	1360767	3	9	80	1990	1346	1332	11165149	10500000	11249999
16	278140	2	9	50	1255	1303	0	11447957	11250000	11999999

Total number of pulses in waveform = 29

Type 5 Radar Waveform_7

Num of Bursts = 18
Burst Interval (us)= 666667

Burst #	Off Time (us)	# Pulses	Chirp (MHz)	PW (us)	Pulse 1 Pri (us)	Pulse 2 Pri (us)	Pulse 3 Pri (us)	Start Loc (us)	Start Burst Interval (us)	End Burst Interval (us)
1	654432	3	5	65	1160	1874	1005	654432	0	666666
2	103256	2	5	75	1539	1710	0	761727	666667	1333333
3	1019213	3	5	85	1502	1492	1160	1784189	1333334	2000000
4	445050	1	5	85	1618	0	0	2233393	2000001	2666667
5	978815	1	5	60	1278	0	0	3213826	2666668	3333334
6	500688	3	5	75	1652	1148	1307	3715792	3333335	4000001
7	490554	2	5	90	1267	1234	0	4210453	4000002	4666668
8	995752	2	5	95	1849	1175	0	5208706	4666669	5333335
9	485028	3	5	70	1781	1235	1442	5896758	5333336	6000002
10	335668	3	5	95	1821	1463	1025	6036884	6000003	6666669
11	1054982	1	5	65	1659	0	0	7096175	6666670	7333336
12	612089	3	5	65	1838	1921	1880	7709923	7333337	8000003
13	651171	1	5	85	1711	0	0	8366733	8000004	8666670
14	861705	3	5	65	1866	1458	1151	9230149	8666671	9333337
15	296395	3	5	90	1235	1293	1376	9531019	9333338	10000004
16	804727	1	5	65	1533	0	0	10339650	10000005	10666671
17	339272	1	5	70	1496	0	0	10680455	10666672	11333338
18	1119291	2	5	100	1761	1106	0	11801242	11333339	12000005

Total number of pulses in waveform = 38



Type 5 Radar Waveform_8

Num of Bursts = 19
Burst Interval (us) = 631579

Burst #	Off Time (us)	# Pulses	Chirp (MHz)	PW (us)	Pulse 1 Pri (us)	Pulse 2 Pri (us)	Pulse 3 Pri (us)	Start Loc (us)	Start Burst Interval (us)	End Burst Interval (us)
1	359436	3	10	85	1950	1265	1623	359436	0	631578
2	422429	3	10	85	1731	1738	1561	786703	631579	1263157
3	696742	2	10	90	1259	1991	0	1488475	1263158	1894736
4	915232	1	10	80	1688	0	0	2406957	1894737	2526315
5	678390	3	10	85	1552	1031	1034	3087035	2526316	3157894
6	145630	1	10	85	1494	0	0	3236282	3157895	3789473
7	969879	2	10	80	1854	1432	0	4207655	3789474	4421052
8	461137	1	10	75	1413	0	0	4672078	4421053	5052631
9	724846	3	10	50	1313	1759	1385	5398337	5052632	5684210
10	656678	1	10	95	1675	0	0	6059472	5684211	6315789
11	718316	3	10	80	1344	1510	1353	6779463	6315790	6947368
12	775325	1	10	95	1051	0	0	7558995	6947369	7578947
13	48560	1	10	60	1030	0	0	7608606	7578948	8210526
14	649606	3	10	80	1870	1671	1585	8259242	8210527	8842105
15	762354	2	10	65	1206	1810	0	9026722	8842106	9473684
16	666872	3	10	90	1654	1685	1383	9696610	9473685	10105263
17	458304	3	10	60	1781	1378	1398	10159636	10105264	10736842
18	871017	1	10	65	1741	0	0	11035210	10736843	11368421
19	525625	3	10	50	1783	1669	1383	11662576	11368422	12000000

Total number of pulses in waveform = 40

Type 5 Radar Waveform_9

Num of Bursts = 9
Burst Interval (us) = 1333333

Burst #	Off Time (us)	# Pulses	Chirp (MHz)	PW (us)	Pulse 1 Pri (us)	Pulse 2 Pri (us)	Pulse 3 Pri (us)	Start Loc (us)	Start Burst Interval (us)	End Burst Interval (us)
1	1009783	2	14	75	1397	1769	0	1009783	0	1333332
2	875159	2	14	85	1214	1079	0	1888108	1333333	2666665
3	1825876	1	14	65	1462	0	0	3716277	2666666	3999998
4	1589610	3	14	65	1615	1742	1151	5307349	3999999	5333331
5	861441	3	14	100	1204	1579	1131	6173298	5333332	6666664
6	1306438	1	14	95	1100	0	0	7483650	6666665	7999997
7	695008	2	14	95	1013	1156	0	8179758	7999998	9333330
8	1206374	1	14	60	1213	0	0	9388301	9333331	10666663
9	2597486	3	14	80	1206	1590	1607	11987000	10666664	11999996

Total number of pulses in waveform = 18

Type 5 Radar Waveform_10

Num of Bursts = 8
Burst Interval (us) = 1500000

Burst #	Off Time (us)	# Pulses	Chirp (MHz)	PW (us)	Pulse 1 Pri (us)	Pulse 2 Pri (us)	Pulse 3 Pri (us)	Start Loc (us)	Start Burst Interval (us)	End Burst Interval (us)
1	1419480	3	17	60	1709	1268	1513	1419480	0	1499999
2	145185	1	17	60	1768	0	0	1569155	1500000	2999999
3	2116883	1	17	100	1287	0	0	3687806	3000000	4499999
4	1674153	3	17	85	1401	1701	1624	5363246	4500000	5999999
5	1823576	3	17	100	1322	1722	1775	7191548	6000000	7499999
6	958096	2	17	55	1310	1265	0	8154463	7500000	8999999
7	1686600	2	17	95	1733	1256	0	9843638	9000000	10499999
8	1942616	1	17	85	1804	0	0	11789243	10500000	11999999

Total number of pulses in waveform = 16



Type 5 Radar Waveform_11

Num of Bursts = 8
Burst Interval (us)= 1500000

Burst #	Off Time (us)	# Pulses	Chirp (MHz)	PW (us)	Pulse 1 Pri (us)	Pulse 2 Pri (us)	Pulse 3 Pri (us)	Start Loc (us)	Start Burst Interval (us)	End Burst Interval (us)
1	634202	3	6	60	1371	1496	1123	634202	0	1499999
2	952449	2	6	55	1906	1966	0	1590641	1500000	2999999
3	1714379	3	6	100	1024	1383	1862	3308892	3000000	4499999
4	1551561	2	6	50	1410	1960	0	4864722	4500000	5999999
5	1645328	3	6	65	1184	1501	1901	6513420	6000000	7499999
6	1773491	1	6	90	1667	0	0	8291497	7500000	8999999
7	1333736	2	6	70	1647	1680	0	9626900	9000000	10499999
8	1025239	2	6	60	1874	1871	0	10655466	10500000	11999999

Total number of pulses in waveform = 18

Type 5 Radar Waveform_12

Num of Bursts = 12
Burst Interval (us)= 1000000

Burst #	Off Time (us)	# Pulses	Chirp (MHz)	PW (us)	Pulse 1 Pri (us)	Pulse 2 Pri (us)	Pulse 3 Pri (us)	Start Loc (us)	Start Burst Interval (us)	End Burst Interval (us)
1	362446	3	19	50	1077	1407	1611	362446	0	999999
2	1112263	1	19	55	1338	0	0	1478804	1000000	1999999
3	798417	2	19	50	1791	1017	0	2278559	2000000	2999999
4	1666792	2	19	85	1086	1693	0	3948159	3000000	3999999
5	130146	2	19	75	1466	1997	0	4081084	4000000	4999999
6	1708113	3	19	85	1991	1149	1821	5792660	5000000	5999999
7	526670	2	19	75	1979	1302	0	6324291	6000000	6999999
8	1555856	2	19	90	1500	1406	0	7883428	7000000	7999999
9	847144	2	19	65	1014	1971	0	8733478	8000000	8999999
10	394021	3	19	75	1946	1787	1340	9130484	9000000	9999999
11	1238233	2	19	95	1969	1757	0	10373790	10000000	10999999
12	970141	1	19	75	1547	0	0	11347657	11000000	11999999

Total number of pulses in waveform = 25

Type 5 Radar Waveform_13

Num of Bursts = 13
Burst Interval (us)= 923077

Burst #	Off Time (us)	# Pulses	Chirp (MHz)	PW (us)	Pulse 1 Pri (us)	Pulse 2 Pri (us)	Pulse 3 Pri (us)	Start Loc (us)	Start Burst Interval (us)	End Burst Interval (us)
1	123828	2	18	75	1672	1367	0	123828	0	923076
2	1547022	3	18	95	1272	1887	1984	1673889	923077	1846153
3	205242	1	18	85	1210	0	0	1884274	1846154	2769230
4	927333	2	18	75	1575	1714	0	2812817	2769231	3692307
5	1193784	3	18	80	1786	1477	1947	4009890	3692308	4615384
6	1324331	2	18	55	1327	1243	0	5339431	4615385	5538461
7	593056	2	18	90	1511	1506	0	5935057	5538462	6461538
8	735344	2	18	85	1434	1634	0	6673418	6461539	7384615
9	1368865	1	18	75	1210	0	0	8045351	7384616	8307692
10	800976	2	18	50	1813	1975	0	8847537	8307693	9230769
11	754787	2	18	70	1507	1193	0	9606112	9230770	10153846
12	1361678	2	18	50	1457	1417	0	10970490	10153847	11076923
13	997279	2	18	55	1062	1225	0	11970643	11076924	12000000

Total number of pulses in waveform = 26



Type 5 Radar Waveform_14

Num of Bursts = 15
Burst Interval (us)= 800000

Burst #	Off Time (us)	# Pulses	Chirp (MHz)	PW (us)	Pulse 1 Pri (us)	Pulse 2 Pri (us)	Pulse 3 Pri (us)	Start Loc (us)	Start Burst Interval (us)	End Burst Interval (us)
1	758394	3	17	90	1725	1578	1204	758394	0	799999
2	292704	1	17	90	1488	0	0	1055605	800000	1599999
3	914150	2	17	50	1975	1117	0	1971243	1600000	2399999
4	706204	1	17	75	1724	0	0	2680539	2400000	3199999
5	801935	1	17	90	1861	0	0	3484198	3200000	3999999
6	851065	3	17	80	1564	1091	1313	4337124	4000000	4799999
7	793487	1	17	50	1177	0	0	5134579	4800000	5599999
8	539526	2	17	55	1131	1402	0	5675282	5600000	6399999
9	1448463	3	17	100	1678	1832	1476	7126278	6400000	7199999
10	176413	2	17	75	1408	1637	0	7307677	7200000	7999999
11	698843	2	17	85	1511	1399	0	8009565	8000000	8799999
12	1137893	1	17	50	1089	0	0	9150368	8800000	9599999
13	797561	3	17	90	1021	1702	1667	9949018	9600000	10399999
14	523327	1	17	65	1059	0	0	10476735	10400000	11199999
15	1457987	1	17	75	1847	0	0	11935781	11200000	11999999

Total number of pulses in waveform = 27

Type 5 Radar Waveform_15

Num of Bursts = 9
Burst Interval (us)= 1333333

Burst #	Off Time (us)	# Pulses	Chirp (MHz)	PW (us)	Pulse 1 Pri (us)	Pulse 2 Pri (us)	Pulse 3 Pri (us)	Start Loc (us)	Start Burst Interval (us)	End Burst Interval (us)
1	797064	3	10	75	1793	1336	1543	797064	0	1333332
2	1079003	3	10	85	1222	1842	1200	1880739	1333333	2666665
3	1604728	1	10	85	1211	0	0	3489731	2666666	3999998
4	800660	2	10	100	1375	1735	0	4291602	3999999	5333331
5	1354434	1	10	55	1166	0	0	5649146	5333332	6666664
6	1278627	2	10	90	1509	1882	0	6928939	6666665	7999997
7	2254798	2	10	85	1688	1977	0	9187128	7999998	9333330
8	901746	3	10	90	1255	1043	1257	10092539	9333331	10666663
9	746571	3	10	55	1552	1158	1960	10842665	10666664	11999996

Total number of pulses in waveform = 20

Type 5 Radar Waveform_16

Num of Bursts = 17
Burst Interval (us)= 705882

Burst #	Off Time (us)	# Pulses	Chirp (MHz)	PW (us)	Pulse 1 Pri (us)	Pulse 2 Pri (us)	Pulse 3 Pri (us)	Start Loc (us)	Start Burst Interval (us)	End Burst Interval (us)
1	338625	2	5	65	1481	1427	0	338625	0	705881
2	675650	1	5	80	1881	0	0	1017183	705882	1411763
3	966400	1	5	60	1633	0	0	1985464	1411764	2117645
4	613209	2	5	70	1000	1782	0	2600306	2117646	2823527
5	617442	2	5	75	1847	1762	0	3220530	2823528	3529409
6	935280	2	5	75	1841	1612	0	4159419	3529410	4235291
7	623852	3	5	70	1808	1064	1846	4786724	4235292	4941173
8	225116	1	5	50	1115	0	0	5016558	4941174	5647055
9	833871	2	5	95	1068	1725	0	5851544	5647056	6352937
10	1054255	3	5	55	1786	1891	1209	6908592	6352938	7058819
11	618526	1	5	85	1549	0	0	7532004	7058820	7764701
12	804157	3	5	60	1288	1025	1628	8337710	7764702	8470583
13	554867	3	5	90	1011	1752	1085	8896518	8470584	9176465
14	827029	3	5	60	1806	1319	1089	9727395	9176466	9882347
15	169732	3	5	70	1104	1445	1453	9901341	9882348	10588229
16	884038	2	5	85	1633	1191	0	10789381	10588230	11294111
17	1112134	1	5	75	1099	0	0	11904339	11294112	11999993

Total number of pulses in waveform = 35



Type 5 Radar Waveform_17

Num of Bursts = 19
Burst Interval (us)= 631579

Burst #	Off Time (us)	# Pulses	Chirp (MHz)	PW (us)	Pulse 1 Pri (us)	Pulse 2 Pri (us)	Pulse 3 Pri (us)	Start Loc (us)	Start Burst Interval (us)	End Burst Interval (us)
1	26489	3	14	85	1823	1736	1123	26489	0	631578
2	643401	2	14	50	1814	1967	0	674662	631579	1263157
3	991183	1	14	80	1841	0	0	1669526	1263158	1894736
4	772739	2	14	100	1387	1108	0	2444106	1894737	2526315
5	101826	3	14	85	1373	1198	1833	2548427	2526316	3157894
6	746220	3	14	75	1323	1632	1995	3299051	3157895	3789473
7	869960	1	14	70	1549	0	0	4173361	3789474	4421052
8	286753	2	14	100	1383	1655	0	4461663	4421053	5052631
9	1025336	2	14	65	1408	1658	0	5490037	5052632	5684210
10	671306	3	14	80	1977	1066	1002	6164409	5684211	6315789
11	578630	1	14	55	1009	0	0	6747084	6315790	6947368
12	771510	2	14	100	1350	1313	0	7519603	6947369	7578947
13	452815	3	14	50	1498	1673	1303	7975081	7578948	8210526
14	493147	3	14	65	1020	1344	1634	8472702	8210527	8842105
15	564560	3	14	70	1170	1440	1017	9041280	8842106	9473684
16	702286	3	14	100	1724	1785	1533	9747173	9473685	10105263
17	827854	2	14	60	1009	1621	0	10580069	10105264	10736842
18	712267	1	14	80	1881	0	0	11294966	10736843	11368421
19	119330	1	14	80	1217	0	0	11416177	11368422	12000000

Total number of pulses in waveform = 41

Type 5 Radar Waveform_18

Num of Bursts = 8
Burst Interval (us)= 1500000

Burst #	Off Time (us)	# Pulses	Chirp (MHz)	PW (us)	Pulse 1 Pri (us)	Pulse 2 Pri (us)	Pulse 3 Pri (us)	Start Loc (us)	Start Burst Interval (us)	End Burst Interval (us)
1	1429745	1	9	70	1377	0	0	1429745	0	1499999
2	860406	1	9	75	1935	0	0	2291528	1500000	2999999
3	1852967	3	9	100	1257	1179	1489	4146430	3000000	4499999
4	868237	1	9	50	1242	0	0	5018592	4500000	5999999
5	995831	3	9	80	1427	1840	1750	6015665	6000000	7499999
6	2571616	3	9	90	1301	1332	1234	8592298	7500000	8999999
7	1419827	1	9	55	1475	0	0	10015992	9000000	10499999
8	1256876	1	9	100	1166	0	0	11274343	10500000	11999999

Total number of pulses in waveform = 14

Type 5 Radar Waveform_19

Num of Bursts = 15
Burst Interval (us)= 800000

Burst #	Off Time (us)	# Pulses	Chirp (MHz)	PW (us)	Pulse 1 Pri (us)	Pulse 2 Pri (us)	Pulse 3 Pri (us)	Start Loc (us)	Start Burst Interval (us)	End Burst Interval (us)
1	22911	1	8	90	1907	0	0	22911	0	799999
2	964997	1	8	85	1230	0	0	989815	800000	1599999
3	1336716	1	8	100	1861	0	0	2327761	1600000	2399999
4	547097	2	8	60	1470	1050	0	2876719	2400000	3199999
5	425930	2	8	60	1642	1766	0	3305169	3200000	3999999
6	1128017	3	8	90	1794	1839	1703	4436594	4000000	4799999
7	514805	2	8	70	1628	1725	0	4956735	4800000	5599999
8	760990	3	8	75	1591	1626	1995	5721078	5600000	6399999
9	902046	3	8	85	1147	1872	1573	6628336	6400000	7199999
10	865380	2	8	100	1965	1898	0	7498308	7200000	7999999
11	524117	1	8	95	1865	0	0	8026288	8000000	8799999
12	1289982	2	8	90	1392	1512	0	9318135	8800000	9599999
13	285612	3	8	50	1388	1955	1411	9606651	9600000	10399999
14	951460	1	8	60	1435	0	0	10562865	10400000	11199999
15	1201821	3	8	80	1774	1533	1218	11766121	11200000	11999999

Total number of pulses in waveform = 30



Type 5 Radar Waveform_20

Num of Bursts = 19
Burst Interval (us)= 631579

Burst #	Off Time (us)	# Pulses	Chirp (MHz)	PW (us)	Pulse 1 Pri (us)	Pulse 2 Pri (us)	Pulse 3 Pri (us)	Start Loc (us)	Start Burst Interval (us)	End Burst Interval (us)
1	217093	1	12	60	1783	0	0	217093	0	631578
2	709806	3	12	70	1832	1212	1812	928682	631579	1263157
3	368031	1	12	70	1642	0	0	1301569	1263158	1894736
4	996687	2	12	90	1825	1375	0	2299898	1894737	2526315
5	689108	3	12	95	1106	1474	1395	2992206	2526316	3157894
6	193687	3	12	60	1148	1774	1780	3189868	3157895	3789473
7	936890	2	12	95	1956	1404	0	4131460	3789474	4421052
8	740229	2	12	60	1123	1936	0	4875049	4421053	5052631
9	793379	3	12	50	1683	1333	1170	5671487	5052632	5684210
10	236326	2	12	70	1355	1637	0	5911999	5684211	6315789
11	796938	3	12	75	1380	1072	1902	6711929	6315790	6947368
12	834761	3	12	75	1896	1398	1118	7551044	6947369	7578947
13	409042	2	12	100	1100	1019	0	7964498	7578948	8210526
14	766071	1	12	50	1997	0	0	8732688	8210527	8842105
15	684481	1	12	90	1512	0	0	9419166	8842106	9473684
16	561480	1	12	70	1667	0	0	9982158	9473685	10105263
17	517347	3	12	50	1368	1173	1970	10501172	10105264	10736842
18	370295	2	12	80	1203	1889	0	10875978	10736843	11368421
19	699242	2	12	90	1346	1385	0	11578312	11368422	12000000

Total number of pulses in waveform = 40

Type 5 Radar Waveform_21

Num of Bursts = 9
Burst Interval (us)= 1333333

Burst #	Off Time (us)	# Pulses	Chirp (MHz)	PW (us)	Pulse 1 Pri (us)	Pulse 2 Pri (us)	Pulse 3 Pri (us)	Start Loc (us)	Start Burst Interval (us)	End Burst Interval (us)
1	272789	3	18	95	1845	1694	1802	272789	0	1333332
2	2308902	3	18	90	1378	1231	1841	2587032	1333333	2666665
3	918857	2	18	95	1632	1270	0	3510339	2666666	3999998
4	686893	3	18	55	1804	1525	1439	4200134	3999999	5333331
5	1553773	2	18	65	1008	1414	0	5758675	5333332	6666664
6	1355981	3	18	75	1779	1727	1886	7117078	6666665	7999997
7	2011905	2	18	100	1945	1452	0	9134375	7999998	9333330
8	933431	2	18	50	1405	1123	0	10071203	9333331	10666663
9	1674773	3	18	75	1388	1490	1380	11748504	10666664	11999996

Total number of pulses in waveform = 23

Type 5 Radar Waveform_22

Num of Bursts = 17
Burst Interval (us)= 705882

Burst #	Off Time (us)	# Pulses	Chirp (MHz)	PW (us)	Pulse 1 Pri (us)	Pulse 2 Pri (us)	Pulse 3 Pri (us)	Start Loc (us)	Start Burst Interval (us)	End Burst Interval (us)
1	648722	1	8	55	1917	0	0	648722	0	705881
2	510939	2	8	60	1606	1191	0	1161578	705882	1411763
3	301935	2	8	55	1942	1513	0	1466310	1411764	2117645
4	665682	3	8	50	1638	1431	1673	2135447	2117646	2823527
5	1355285	3	8	55	1135	1297	1812	3495474	2823528	3529409
6	43603	2	8	80	1332	1478	0	3543321	3529410	4235291
7	1127651	3	8	55	1323	1723	1010	4673782	4235292	4941173
8	670935	2	8	90	1969	1962	0	5348773	4941174	5647055
9	744995	2	8	95	1616	1794	0	6097699	5647056	6352937
10	733595	1	8	60	1080	0	0	6834704	6352938	7058819
11	546648	3	8	55	1437	1618	1112	7382432	7058820	7764701
12	1049394	1	8	95	1120	0	0	8435993	7764702	8470583
13	635208	3	8	90	1890	1384	1187	9072321	8470584	9176465
14	798698	3	8	55	1542	1097	1856	9875480	9176466	9882347
15	201499	1	8	85	1015	0	0	10081474	9882348	10588229
16	903676	2	8	85	1615	1995	0	10986165	10588230	11294111
17	328611	2	8	65	1006	1975	0	11318386	11294112	11999993

Total number of pulses in waveform = 36



Type 5 Radar Waveform_23

Num of Bursts = 10
Burst Interval (us)= 1200000

Burst #	Off Time (us)	# Pulses	Chirp (MHz)	PW (us)	Pulse 1 Pri (us)	Pulse 2 Pri (us)	Pulse 3 Pri (us)	Start Loc (us)	Start Burst Interval (us)	End Burst Interval (us)
1	109028	3	19	95	1158	1450	1384	109028	0	1199999
2	1691937	2	19	60	1852	1358	0	1804957	1200000	2399999
3	1375028	3	19	50	1124	1693	1915	3183195	2400000	3599999
4	1464519	2	19	80	1285	1217	0	4652446	3600000	4799999
5	666464	2	19	100	1457	1596	0	5321412	4800000	5999999
6	1153989	2	19	50	1913	1148	0	6478454	6000000	7199999
7	944977	3	19	50	1634	1700	1972	7426492	7200000	8399999
8	1097104	1	19	50	1763	0	0	8528902	8400000	9599999
9	1079836	3	19	90	1160	1855	1061	9610501	9600000	10799999
10	1699055	1	19	60	1648	0	0	11313632	10800000	11999999

Total number of pulses in waveform = 22

Type 5 Radar Waveform_24

Num of Bursts = 12
Burst Interval (us)= 1000000

Burst #	Off Time (us)	# Pulses	Chirp (MHz)	PW (us)	Pulse 1 Pri (us)	Pulse 2 Pri (us)	Pulse 3 Pri (us)	Start Loc (us)	Start Burst Interval (us)	End Burst Interval (us)
1	860701	3	9	95	1785	1923	1223	860701	0	999999
2	1095026	1	9	80	1701	0	0	1960658	1000000	1999999
3	863425	3	9	75	1723	1887	1742	2825784	2000000	2999999
4	1020211	2	9	100	1953	1533	0	3851347	3000000	3999999
5	620924	1	9	50	1342	0	0	4475757	4000000	4999999
6	1018589	1	9	55	1772	0	0	5495688	5000000	5999999
7	1185251	1	9	75	1774	0	0	6682711	6000000	6999999
8	1244102	2	9	70	1295	1455	0	7928587	7000000	7999999
9	416536	1	9	75	1846	0	0	8347873	8000000	8999999
10	1098105	2	9	85	1880	1044	0	9447824	9000000	9999999
11	1391889	3	9	90	1654	1689	1983	10842637	10000000	10999999
12	325352	1	9	55	1014	0	0	11173315	11000000	11999999

Total number of pulses in waveform = 21

Type 5 Radar Waveform_25

Num of Bursts = 12
Burst Interval (us)= 1000000

Burst #	Off Time (us)	# Pulses	Chirp (MHz)	PW (us)	Pulse 1 Pri (us)	Pulse 2 Pri (us)	Pulse 3 Pri (us)	Start Loc (us)	Start Burst Interval (us)	End Burst Interval (us)
1	574104	2	10	55	1094	1045	0	574104	0	999999
2	1234627	1	10	90	1207	0	0	1810870	1000000	1999999
3	785039	3	10	95	1415	1622	1041	2597116	2000000	2999999
4	1367556	2	10	75	1020	1861	0	3968750	3000000	3999999
5	373189	2	10	85	1332	1476	0	4344820	4000000	4999999
6	1397941	1	10	100	1707	0	0	5745569	5000000	5999999
7	320743	1	10	85	1843	0	0	6068019	6000000	6999999
8	1538262	1	10	75	1395	0	0	7608124	7000000	7999999
9	1162155	3	10	100	1867	1914	1345	8771674	8000000	8999999
10	612437	3	10	75	1734	1196	1161	9389237	9000000	9999999
11	1421813	3	10	80	1011	1806	1562	10815141	10000000	10999999
12	837141	2	10	70	1582	1571	0	11656661	11000000	11999999

Total number of pulses in waveform = 24



Type 5 Radar Waveform_26

Num of Bursts = 9
Burst Interval (us)= 1333333

Burst #	Off Time (us)	# Pulses	Chirp (MHz)	PW (us)	Pulse 1 Pri (us)	Pulse 2 Pri (us)	Pulse 3 Pri (us)	Start Loc (us)	Start Burst Interval (us)	End Burst Interval (us)
1	94413	2	12	60	1157	1816	0	94413	0	1333332
2	1326810	1	12	75	1193	0	0	1424196	1333333	2666665
3	1733891	2	12	85	1908	1067	0	3159280	2666666	3999998
4	1111014	1	12	95	1881	0	0	4273269	3999999	5333331
5	2362334	2	12	60	1699	1581	0	6637484	5333332	6666664
6	58568	2	12	80	1023	1149	0	6699332	6666665	7999997
7	2430358	1	12	55	1666	0	0	9131862	7999998	9333330
8	1002676	2	12	100	1513	1412	0	10136204	9333331	10666663
9	1736727	2	12	85	1937	1538	0	11875856	10666664	11999996

Total number of pulses in waveform = 15

Type 5 Radar Waveform_27

Num of Bursts = 12
Burst Interval (us)= 1000000

Burst #	Off Time (us)	# Pulses	Chirp (MHz)	PW (us)	Pulse 1 Pri (us)	Pulse 2 Pri (us)	Pulse 3 Pri (us)	Start Loc (us)	Start Burst Interval (us)	End Burst Interval (us)
1	81221	2	6	80	1462	1732	0	81221	0	999999
2	1334909	3	6	60	1472	1038	1530	1419324	1000000	1999999
3	585844	3	6	55	1424	1500	2000	2009208	2000000	2999999
4	1635244	2	6	65	1846	1436	0	3649376	3000000	3999999
5	515674	2	6	50	1391	1594	0	4168332	4000000	4999999
6	1101497	3	6	60	1525	1209	1651	5272814	5000000	5999999
7	1170464	1	6	60	1206	0	0	6447663	6000000	6999999
8	1390175	2	6	85	1860	1300	0	7839044	7000000	7999999
9	1035834	1	6	75	1396	0	0	8878038	8000000	8999999
10	1049773	3	6	90	1658	1776	1368	9929207	9000000	9999999
11	975482	2	6	80	1139	1556	0	10909491	10000000	10999999
12	610207	3	6	80	1694	1593	1076	11522393	11000000	11999999

Total number of pulses in waveform = 27

Type 5 Radar Waveform_28

Num of Bursts = 13
Burst Interval (us)= 923077

Burst #	Off Time (us)	# Pulses	Chirp (MHz)	PW (us)	Pulse 1 Pri (us)	Pulse 2 Pri (us)	Pulse 3 Pri (us)	Start Loc (us)	Start Burst Interval (us)	End Burst Interval (us)
1	37640	2	17	100	1496	1980	0	37640	0	923076
2	1481038	3	17	50	1104	1328	1848	1522154	923077	1846153
3	927858	2	17	70	1673	1475	0	2454292	1846154	2769230
4	975331	1	17	70	1204	0	0	3432771	2769231	3692307
5	873814	1	17	95	1761	0	0	4307789	3692308	4615384
6	673001	1	17	95	1553	0	0	4982551	4615385	5538461
7	627801	1	17	80	1796	0	0	5611905	5538462	6461538
8	1351066	3	17	85	1092	1698	1676	6964767	6461539	7384615
9	421294	3	17	50	1328	1283	1606	7390527	7384616	8307692
10	1391393	3	17	95	1304	1138	1498	8786137	8307693	9230769
11	756538	1	17	75	1053	0	0	9546615	9230770	10153846
12	1180459	2	17	70	1537	1560	0	10728127	10153847	11076923
13	743354	3	17	55	1675	1344	1559	11474578	11076924	12000000

Total number of pulses in waveform = 26



Type 5 Radar Waveform_29

Num of Bursts = 14
Burst Interval (us)= 857143

Burst #	Off Time (us)	# Pulses	Chirp (MHz)	PW (us)	Pulse 1 Pri (us)	Pulse 2 Pri (us)	Pulse 3 Pri (us)	Start Loc (us)	Start Burst Interval (us)	End Burst Interval (us)
1	97959	1	5	70	1203	0	0	97959	0	857142
2	1329434	3	5	50	1713	1700	1016	1428596	857143	1714285
3	289184	2	5	85	1763	1178	0	1722209	1714286	2571428
4	901800	2	5	50	1831	1713	0	2626950	2571429	3428571
5	1049614	3	5	65	1107	1251	1220	3680108	3428572	4285714
6	956149	2	5	55	1590	1421	0	4639835	4285715	5142857
7	1311441	3	5	80	1470	1343	1337	5954287	5142858	6000000
8	243817	1	5	65	1635	0	0	6202254	6000001	6857143
9	1448073	3	5	75	1118	1963	1537	7651962	6857144	7714286
10	886478	1	5	75	1832	0	0	8543058	7714287	8571429
11	588040	2	5	95	1240	1386	0	9132930	8571430	9428572
12	865248	1	5	60	1962	0	0	10000804	9428573	10285715
13	307030	3	5	80	1628	1496	1065	10309796	10285716	11142858
14	1533834	2	5	80	1018	1877	0	11847819	11142859	12000001

Total number of pulses in waveform = 29

Type 5 Radar Waveform_30

Num of Bursts = 19
Burst Interval (us)= 631579

Burst #	Off Time (us)	# Pulses	Chirp (MHz)	PW (us)	Pulse 1 Pri (us)	Pulse 2 Pri (us)	Pulse 3 Pri (us)	Start Loc (us)	Start Burst Interval (us)	End Burst Interval (us)
1	63482	2	14	100	1901	1811	0	63482	0	631578
2	858580	3	14	55	1236	1083	1319	925774	631579	1263157
3	360059	3	14	95	1757	1733	1301	1289471	1263158	1894736
4	705056	3	14	85	1681	1011	1122	1999318	1894737	2526315
5	994125	3	14	70	1291	1574	1317	2997257	2526316	3157894
6	489395	1	14	75	1006	0	0	3490834	3157895	3789473
7	920501	2	14	55	1099	1875	0	4412341	3789474	4421052
8	190476	3	14	70	1451	1613	1773	4605791	4421053	5052631
9	633589	3	14	95	1945	1377	1551	5244217	5052632	5684210
10	950954	1	14	65	1880	0	0	6200044	5684211	6315789
11	512814	2	14	90	1851	1963	0	6714738	6315790	6947368
12	520281	1	14	85	1726	0	0	7238833	6947369	7578947
13	504632	2	14	100	1135	1650	0	7745191	7578948	8210526
14	868123	2	14	50	1825	1450	0	8606099	8210527	8842105
15	628184	3	14	70	1496	1558	1319	9237558	8842106	9473684
16	742171	2	14	75	1677	1089	0	9984102	9473685	10105263
17	482716	3	14	50	1377	1412	1452	10469584	10105264	10736842
18	485182	2	14	80	1513	1902	0	10959007	10736843	11368421
19	926126	3	14	55	1065	1223	0	11888548	11368422	12000000

Total number of pulses in waveform = 43



Radar Type 6 - Radar Statistical Performance

Trail #	Test Freq. (MHz)	1=Detection 0=No Detection	Trail #	Test Freq. (MHz)	1=Detection 0=No Detection
1	5491	1	16	5510	1
2	5491	1	17	5510	1
3	5491	1	18	5510	1
4	5491	1	19	5511	1
5	5500	1	20	5511	1
6	5500	1	21	5511	1
7	5500	1	22	5511	1
8	5500	1	23	5520	1
9	5509	1	24	5520	1
10	5509	1	25	5520	1
11	5509	1	26	5520	1
12	5509	1	27	5529	1
13	5510	1	28	5529	1
14	5510	1	29	5529	1
15	5510	1	30	5529	1
Detection Percentage (%)					100%



Radar waveform #1			Radar waveform #2		
Hopping Number	Frequency (MHz)	Pulse Start (ms)	Hopping Number	Frequency (MHz)	Pulse Start (ms)
5	5477	15	42	5503	126
13	5495	39	47	5498	141
15	5476	45	70	5470	210
24	5483	72	78	5515	234
26	5462	78	79	5469	237
46	5487	138	80	5479	240
56	5492	168	89	5487	267
59	5467	177	95	5492	285
68	5500	204	--	--	--
73	5508	219	--	--	--
75	5478	225	--	--	--
78	5484	234	--	--	--
84	5480	252	--	--	--
85	5498	255	--	--	--
89	5519	267	--	--	--
95	5510	285	--	--	--



Radar waveform #3			Radar waveform #4		
Hopping Number	Frequency (MHz)	Pulse Start (ms)	Hopping Number	Frequency (MHz)	Pulse Start (ms)
1	5461	3	4	5485	12
21	5468	63	17	5466	51
25	5515	75	19	5478	57
26	5471	78	31	5467	93
32	5479	96	34	5488	102
34	5476	102	42	5489	126
57	5462	171	61	5479	183
63	5503	189	83	5462	249
74	5488	222	90	5496	270
97	5464	291	92	5502	276



Radar waveform #5			Radar waveform #6		
Hopping Number	Frequency (MHz)	Pulse Start (ms)	Hopping Number	Frequency (MHz)	Pulse Start (ms)
5	5474	15	25	5472	75
9	5509	27	26	5473	78
11	5497	33	27	5479	81
16	5522	48	39	5516	117
21	5487	63	43	5507	129
37	5481	111	55	5477	165
58	5529	174	64	5504	192
59	5515	177	80	5526	240
71	5483	213	81	5513	243
76	5513	228	--	--	--
91	5516	273	--	--	--
93	5482	279	--	--	--

Radar waveform #7			Radar waveform #8		
Hopping Number	Frequency (MHz)	Pulse Start (ms)	Hopping Number	Frequency (MHz)	Pulse Start (ms)
3	5501	9	2	5486	6
14	5506	42	10	5528	30
29	5509	87	12	5481	36
57	5479	171	18	5480	54
58	5490	174	19	5529	57
60	5494	180	21	5495	63
64	5524	192	25	5530	75
67	5503	201	26	5479	78
77	5516	231	27	5504	81
86	5513	258	34	5516	102
87	5481	261	39	5527	117
--	--	--	45	5477	135
--	--	--	50	5484	150
--	--	--	55	5487	165
--	--	--	58	5497	174
--	--	--	94	5472	282
--	--	--	97	5478	291
--	--	--	98	5508	294

Radar waveform #9			Radar waveform #10		
Hopping Number	Frequency (MHz)	Pulse Start (ms)	Hopping Number	Frequency (MHz)	Pulse Start (ms)
13	5531	39	5	5494	15
17	5502	51	19	5499	57
22	5534	66	20	5484	60
32	5526	96	29	5485	87
33	5524	99	36	5539	108
34	5494	102	40	5505	120
58	5480	174	49	5492	147
59	5514	177	51	5532	153
77	5499	231	65	5497	195
80	5522	240	71	5506	213
83	5511	249	93	5518	279
85	5539	255	97	5501	291
86	5519	258	--	--	--
91	5538	273	--	--	--

Radar waveform #11			Radar waveform #12		
Hopping Number	Frequency (MHz)	Pulse Start (ms)	Hopping Number	Frequency (MHz)	Pulse Start (ms)
2	5532	6	1	5482	3
16	5527	48	2	5490	6
45	5497	135	5	5495	15
49	5481	147	12	5493	36
69	5511	207	29	5502	87
81	5507	243	31	5523	93
90	5515	270	34	5480	102
--	--	--	36	5514	108
--	--	--	47	5481	141
--	--	--	48	5505	144
--	--	--	61	5528	183
--	--	--	63	5517	189
--	--	--	73	5485	219
--	--	--	77	5512	231
--	--	--	78	5491	234
--	--	--	80	5487	240
--	--	--	88	5507	264
--	--	--	96	5530	288
--	--	--	98	5538	294



Radar waveform #13			Radar waveform #14		
Hopping Number	Frequency (MHz)	Pulse Start (ms)	Hopping Number	Frequency (MHz)	Pulse Start (ms)
35	5532	105	27	5494	81
37	5486	111	37	5527	111
41	5540	123	40	5510	120
52	5498	156	47	5535	141
57	5501	171	48	5492	144
59	5539	177	52	5500	156
65	5518	195	53	5523	159
78	5505	234	73	5503	219
83	5497	249	76	5481	228
--	--	--	90	5520	270

Radar waveform #15			Radar waveform #16		
Hopping Number	Frequency (MHz)	Pulse Start (ms)	Hopping Number	Frequency (MHz)	Pulse Start (ms)
4	5517	12	2	5519	6
9	5507	27	6	5509	18
10	5483	30	12	5491	36
21	5521	63	14	5532	42
28	5524	84	22	5485	66
40	5494	120	29	5522	87
46	5500	138	50	5526	150
51	5532	153	57	5516	171
56	5529	168	65	5499	195
65	5526	195	69	5524	207
85	5501	255	73	5533	219
89	5496	267	78	5520	234
90	5512	270	80	5488	240
93	5509	279	81	5501	243
95	5514	285	87	5523	261
98	5522	294	95	5495	285
--	--	--	96	5504	288



Radar waveform #17			Radar waveform #18		
Hopping Number	Frequency (MHz)	Pulse Start (ms)	Hopping Number	Frequency (MHz)	Pulse Start (ms)
3	5530	9	11	5480	33
12	5497	36	17	5490	51
32	5528	96	23	5520	69
44	5493	132	33	5489	99
45	5539	135	36	5516	108
57	5507	171	42	5527	126
58	5498	174	57	5519	171
61	5538	183	66	5502	198
64	5494	192	67	5482	201
75	5501	225	68	5481	204
79	5484	237	69	5501	207
80	5535	240	80	5539	240
88	5499	264	83	5513	249
93	5519	279	88	5514	264
99	5524	297	94	5508	282

Radar waveform #19			Radar waveform #20		
Hopping Number	Frequency (MHz)	Pulse Start (ms)	Hopping Number	Frequency (MHz)	Pulse Start (ms)
18	5482	54	8	5499	24
23	5509	69	24	5495	72
36	5481	108	26	5531	78
46	5526	138	28	5488	84
58	5528	174	30	5537	90
63	5500	189	49	5496	147
65	5502	195	56	5508	168
66	5499	198	59	5486	177
70	5505	210	64	5501	192
86	5510	258	65	5520	195
93	5533	279	71	5487	213
99	5523	297	82	5529	246
--	--	--	99	5481	297



Radar waveform #21			Radar waveform #22		
Hopping Number	Frequency (MHz)	Pulse Start (ms)	Hopping Number	Frequency (MHz)	Pulse Start (ms)
8	5483	24	6	5485	18
15	5508	45	8	5504	24
27	5521	81	14	5521	42
34	5485	102	23	5491	69
38	5500	114	26	5501	78
45	5495	135	27	5489	81
57	5513	171	50	5534	150
63	5487	189	54	5503	162
67	5540	201	59	5494	177
81	5510	243	61	5531	183
88	5492	264	64	5523	192
--	--	--	65	5493	195
--	--	--	66	5520	198
--	--	--	69	5487	207
--	--	--	77	5538	231

Radar waveform #23			Radar waveform #24		
Hopping Number	Frequency (MHz)	Pulse Start (ms)	Hopping Number	Frequency (MHz)	Pulse Start (ms)
5	5509	15	9	5518	27
10	5503	30	10	5529	30
12	5506	36	11	5506	33
28	5511	84	12	5505	36
38	5526	114	16	5500	48
40	5516	120	24	5494	72
49	5496	147	36	5497	108
50	5518	150	51	5493	153
65	5493	195	56	5533	168
66	5537	198	75	5498	225
74	5501	222	77	5490	231
77	5542	231	82	5507	246
82	5543	246	83	5515	249
85	5545	255	90	5492	270
86	5541	258	--	--	--

Radar waveform #25			Radar waveform #26		
Hopping Number	Frequency (MHz)	Pulse Start (ms)	Hopping Number	Frequency (MHz)	Pulse Start (ms)
13	5501	39	14	5515	42
27	5548	81	20	5530	60
30	5511	90	22	5533	66
42	5536	126	23	5526	69
43	5530	129	26	5520	78
44	5520	132	33	5510	99
51	5514	153	42	5514	126
53	5490	159	56	5538	168
58	5513	174	59	5517	177
59	5516	177	65	5512	195
66	5509	198	71	5543	213
69	5531	207	73	5507	219
79	5532	237	77	5548	231
81	5543	243	91	5532	273
84	5523	252	94	5495	282
93	5507	279	95	5531	285
96	5544	288	--	--	--
97	5549	291	--	--	--

Radar waveform #27			Radar waveform #28		
Hopping Number	Frequency (MHz)	Pulse Start (ms)	Hopping Number	Frequency (MHz)	Pulse Start (ms)
4	5517	12	7	5558	21
6	5516	18	21	5501	63
15	5520	45	27	5528	81
35	5524	105	29	5500	87
39	5544	117	37	5510	111
48	5554	144	63	5526	189
69	5547	207	66	5521	198
72	5528	216	70	5518	210
91	5534	273	77	5503	231
94	5515	282	79	5520	237
97	5507	291	80	5551	240
99	5503	297	85	5547	255
--	--	--	87	5516	261
--	--	--	91	5529	273
--	--	--	93	5504	279
--	--	--	94	5545	282
--	--	--	99	5537	297

Radar waveform #29			Radar waveform #30		
Hopping Number	Frequency (MHz)	Pulse Start (ms)	Hopping Number	Frequency (MHz)	Pulse Start (ms)
51	5506	153	3	5522	9
57	5558	171	4	5548	12
63	5523	189	62	5546	186
69	5534	207	75	5508	225
72	5515	216	76	5539	228
74	5519	222	77	5506	231
--	--	--	91	5510	273
--	--	--	92	5509	276



Radar Statistical Performance for 802.11ac-VHT80

Radar Type 1 - Radar Statistical Performance

Trail #	Test Freq. (MHz)	Pulse Width (us)	PRI (us)	Pulses / Burst	1=Detection 0=No Detection
1	5491	1	738	72	1
2	5491	1	678	78	1
3	5500	1	778	68	1
4	5500	1	698	76	1
5	5509	1	518	102	1
6	5509	1	938	57	1
7	5510	1	838	63	1
8	5510	1	798	67	1
9	5511	1	3066	18	1
10	5511	1	758	70	1
11	5520	1	918	58	1
12	5520	1	558	95	1
13	5529	1	858	62	1
14	5529	1	878	61	1
15	5530	1	578	92	1
16	5530	1	2966	18	1
17	5531	1	2271	24	1
18	5531	1	1738	31	1
19	5540	1	2569	21	1
20	5540	1	1590	34	1
21	5549	1	1142	47	1
22	5549	1	2679	20	1
23	5550	1	1809	30	1
24	5550	1	1604	33	1
25	5551	1	1383	39	1
26	5551	1	2127	25	1
27	5560	1	849	63	1
28	5560	1	3023	18	1
29	5569	1	899	59	1
30	5569	1	1343	40	1
Detection Percentage (%)					100%



Radar Type 2 - Radar Statistical Performance

Trail #	Test Freq. (MHz)	Pulse Width (us)	PRI (us)	Pulses / Burst	1=Detection 0=No Detection
1	5491	2.7	192	23	1
2	5491	1.6	223	27	1
3	5500	3.3	202	25	1
4	5500	3.4	175	23	1
5	5509	3.9	219	23	1
6	5509	2.2	170	29	1
7	5510	1.3	224	28	1
8	5510	2.8	159	26	1
9	5511	4.1	203	27	1
10	5511	5.0	163	24	1
11	5520	4.5	209	28	1
12	5520	3.0	205	24	1
13	5529	3.8	166	27	1
14	5529	2.3	178	28	1
15	5530	3.9	198	26	1
16	5530	1.2	182	28	1
17	5531	1.2	163	26	1
18	5531	3.3	217	25	1
19	5540	4.3	195	27	1
20	5540	2.6	216	29	1
21	5549	1.4	151	26	1
22	5549	1.7	199	29	1
23	5550	3.8	169	26	1
24	5550	2.9	201	24	1
25	5551	3.7	204	25	1
26	5551	2.7	191	23	1
27	5560	1.2	208	29	1
28	5560	2.4	191	26	1
29	5569	1.0	226	26	1
30	5569	3.1	225	26	1
Detection Percentage (%)					100%



Radar Type 3 - Radar Statistical Performance

Trail #	Test Freq. (MHz)	Pulse Width (us)	PRI (us)	Pulses / Burst	1=Detection 0=No Detection
1	5491	9.7	477	16	1
2	5491	8.3	302	16	1
3	5500	7.7	465	18	1
4	5500	6.7	461	18	1
5	5509	8.0	298	18	1
6	5509	8.8	258	16	1
7	5510	6.0	293	17	1
8	5510	8.8	462	18	1
9	5511	9.1	355	17	1
10	5511	7.2	479	18	1
11	5520	9.3	401	17	1
12	5520	6.0	445	16	1
13	5529	8.7	422	18	1
14	5529	7.1	394	16	1
15	5530	8.4	477	17	1
16	5530	7.0	442	18	1
17	5531	9.2	427	16	1
18	5531	7.5	293	16	1
19	5540	7.7	404	17	1
20	5540	9.0	412	16	1
21	5549	8.1	450	18	1
22	5549	9.6	457	17	1
23	5550	6.1	419	17	1
24	5550	9.9	391	16	1
25	5551	7.6	318	18	1
26	5551	9.0	314	18	1
27	5560	7.8	255	17	1
28	5560	6.7	383	16	1
29	5569	6.3	335	16	1
30	5569	8.9	480	18	1
Detection Percentage (%)					100%



Radar Type 4 - Radar Statistical Performance

Trail #	Test Freq. (MHz)	Pulse Width (us)	PRI (us)	Pulses / Burst	1=Detection 0=No Detection
1	5491	12.4	260	14	1
2	5491	15.7	433	15	1
3	5500	18.2	354	16	1
4	5500	17.1	418	14	1
5	5509	13.2	497	16	1
6	5509	18.6	451	12	1
7	5510	19.8	283	16	1
8	5510	18.8	319	16	1
9	5511	15.3	466	13	1
10	5511	12.1	259	16	1
11	5520	15.4	416	15	1
12	5520	13.7	302	13	1
13	5529	12.1	253	13	1
14	5529	13.1	469	15	1
15	5530	13.1	260	14	1
16	5530	19.3	483	12	1
17	5531	19.2	464	16	1
18	5531	12.2	346	13	1
19	5540	12.1	342	13	1
20	5540	19.2	266	12	1
21	5549	19.0	353	14	1
22	5549	11.0	455	15	1
23	5550	20.0	498	14	1
24	5550	12.7	471	13	1
25	5551	14.6	281	13	1
26	5551	17.4	453	12	1
27	5560	14.4	480	13	1
28	5560	19.0	459	13	1
29	5569	19.6	276	13	1
30	5569	13.1	341	15	1
Detection Percentage (%)					100%

Note: In addition an average minimum percentage of successful detection across all four Short pulse radar test

waveforms is as follows:
$$\frac{P_d1 + P_d2 + P_d3 + P_d4}{4} = (100\% + 100\% + 100\% + 100\%) / 4 = 100\% (>80\%)$$



Radar Type 5 - Radar Statistical Performance

Trail #	Test Freq. (MHz)	1=Detection 0=No Detection	Trail #	Test Freq. (MHz)	1=Detection 0=No Detection
1	5493.4	1	16	5530.0	1
2	5493.0	1	17	5530.0	1
3	5497.8	1	18	5530.0	1
4	5496.6	1	19	5530.0	1
5	5495.8	1	20	5530.0	1
6	5494.2	1	21	5565.8	1
7	5495.0	1	22	5561.4	1
8	5498.6	1	23	5561.8	1
9	5494.6	1	24	5565.0	1
10	5498.2	1	25	5566.6	1
11	5530.0	1	26	5562.2	1
12	5530.0	1	27	5565.4	1
13	5530.0	1	28	5564.2	1
14	5530.0	1	29	5563.4	1
15	5530.0	1	30	5567.0	1
Detection Percentage (%)					100%

Type 5 Radar Waveform_1										
Num of Bursts = 18										
Burst Interval (us) = 666667										
Burst #	Off Time (us)	# Pulses	Chirp (MHz)	PW (us)	Pulse 1 Pri (us)	Pulse 2 Pri (us)	Pulse 3 Pri (us)	Start Loc (us)	Start Burst Interval (us)	End Burst Interval (us)
1	157812	3	6	55	1374	1759	1458	157812	0	666666
2	584162	3	6	75	1720	1983	1319	746565	666667	1333333
3	997414	3	6	95	1686	1999	1096	1749001	1333334	2000000
4	828392	3	6	80	1710	1377	1413	2582174	2000001	2666667
5	652256	3	6	65	1960	1231	1104	3238929	2666668	3333334
6	678977	1	6	75	1980	0	0	3922201	3333335	4000001
7	662789	3	6	60	1804	1054	1323	4586370	4000002	4666668
8	454424	3	6	70	1733	1473	1759	5044975	4666669	5333335
9	859651	2	6	70	1066	1715	0	5909591	5333336	6000002
10	396897	1	6	65	1249	0	0	6311269	6000003	6666669
11	458066	1	6	65	1340	0	0	6770584	6666670	7333336
12	959750	3	6	60	1037	1830	1437	7731674	7333337	8000003
13	759424	2	6	90	1498	1057	0	8495402	8000004	8666670
14	825484	1	6	80	1975	0	0	9323441	8666671	9333337
15	607822	3	6	85	1122	1861	1611	9933238	9333338	10000004
16	688770	1	6	70	1148	0	0	10626602	10000005	10666671
17	211122	1	6	50	1229	0	0	10838872	10666672	11333338
18	712645	1	6	90	1241	0	0	11552746	11333339	12000005
Total number of pulses in waveform = 98										



Type 5 Radar Waveform_2

Num of Bursts = 13
Burst Interval (us)= 923077

Burst #	Off Time (us)	# Pulses	Chirp (MHz)	PW (us)	Pulse 1 Pri (us)	Pulse 2 Pri (us)	Pulse 3 Pri (us)	Start Loc (us)	Start Burst Interval (us)	End Burst Interval (us)
1	73847	1	5	50	1151	0	0	73847	0	923076
2	1384415	2	5	60	1865	1044	0	1459413	923077	1846153
3	800847	1	5	60	1150	0	0	2263169	1846154	2769230
4	951372	3	5	60	1182	1497	1570	3215691	2769231	3692307
5	940203	3	5	75	1072	1979	1229	4160143	3692308	4615384
6	872470	3	5	55	1419	1999	1802	5036893	4615385	5538461
7	1299161	1	5	65	1519	0	0	6341274	5538462	6461538
8	518321	3	5	55	1464	1195	1970	6861114	6461539	7384615
9	1019231	2	5	90	1705	1082	0	7884974	7384616	8307692
10	872890	3	5	85	1762	1155	1967	8760651	8307693	9230769
11	627748	1	5	80	1048	0	0	9393283	9230770	10153846
12	1411747	1	5	60	1228	0	0	10806078	10153847	11076923
13	1138868	1	5	80	1531	0	0	11946174	11076924	12000000

Total number of pulses in waveform = 25

Type 5 Radar Waveform_3

Num of Bursts = 14
Burst Interval (us)= 857143

Burst #	Off Time (us)	# Pulses	Chirp (MHz)	PW (us)	Pulse 1 Pri (us)	Pulse 2 Pri (us)	Pulse 3 Pri (us)	Start Loc (us)	Start Burst Interval (us)	End Burst Interval (us)
1	225065	3	17	60	1631	1384	1589	225065	0	857142
2	985232	1	17	50	1811	0	0	1214901	857143	1714285
3	791669	3	17	60	1152	1853	1831	2008381	1714286	2571428
4	1051994	2	17	50	1833	1384	0	3065211	2571429	3428571
5	1118382	3	17	80	1260	1137	1595	4186810	3428572	4285714
6	568276	1	17	60	1888	0	0	4759078	4285715	5142857
7	702248	1	17	80	1295	0	0	5463214	5142858	6000000
8	665760	2	17	75	1193	1467	0	6130269	6000001	6857143
9	1453930	3	17	95	1329	1416	1109	7586859	6857144	7714286
10	849848	1	17	90	1740	0	0	8440561	7714287	8571429
11	426963	3	17	100	1604	1580	1406	8869264	8571430	9428572
12	563123	1	17	95	1535	0	0	9436977	9428573	10285715
13	1591332	2	17	85	1868	1231	0	11029844	10285716	11142858
14	284099	2	17	100	1430	1144	0	11317042	11142859	12000001

Total number of pulses in waveform = 28

Type 5 Radar Waveform_4

Num of Bursts = 18
Burst Interval (us)= 666667

Burst #	Off Time (us)	# Pulses	Chirp (MHz)	PW (us)	Pulse 1 Pri (us)	Pulse 2 Pri (us)	Pulse 3 Pri (us)	Start Loc (us)	Start Burst Interval (us)	End Burst Interval (us)
1	91304	2	14	70	1084	1434	0	91304	0	666666
2	621796	3	14	100	1083	1836	1121	715558	666667	1333333
3	1171634	2	14	60	1278	1642	0	1891232	1333334	2000000
4	281121	2	14	50	1882	1645	0	2175273	2000001	2666667
5	601282	2	14	95	1928	1403	0	2780082	2666668	3333334
6	1132426	2	14	95	1405	1383	0	3915839	3333335	4000001
7	449425	3	14	90	1324	1791	1034	4368052	4000002	4666668
8	564854	3	14	50	1164	1366	1581	4937055	4666669	5333335
9	867897	3	14	80	1519	1235	1987	5809063	5333336	6000002
10	267425	2	14	75	1628	1726	0	6081229	6000003	6666669
11	1170119	1	14	70	1910	0	0	7254702	6666670	7333336
12	585030	1	14	100	1380	0	0	7841642	7333337	8000003
13	653747	3	14	95	1023	1248	1430	8496769	8000004	8666670
14	287972	3	14	85	1797	1859	1119	8788442	8666671	9333337
15	1079984	3	14	100	1837	1398	1091	9873201	9333338	10000004
16	776854	2	14	55	1656	1822	0	10654381	10000005	10666671
17	614178	1	14	65	1129	0	0	11272037	10666672	11333338
18	657947	1	14	55	1007	0	0	11931113	11333339	12000005

Total number of pulses in waveform = 39



Type 5 Radar Waveform_5

Num of Bursts = 15
Burst Interval (us)= 800000

Burst #	Off Time (us)	# Pulses	Chirp (MHz)	PW (us)	Pulse 1 Pri (us)	Pulse 2 Pri (us)	Pulse 3 Pri (us)	Start Loc (us)	Start Burst Interval (us)	End Burst Interval (us)
1	82487	2	12	50	1912	1200	0	82487	0	799999
2	1146177	1	12	70	1078	0	0	1231776	800000	1599999
3	817753	3	12	75	1264	1979	1313	2050607	1600000	2399999
4	1104744	3	12	75	1770	1449	1011	3159907	2400000	3199999
5	403870	3	12	55	1474	1310	1812	3568007	3200000	3999999
6	779657	2	12	85	1424	1875	0	4352160	4000000	4799999
7	1203631	3	12	50	1568	1268	1157	5559090	4800000	5599999
8	677768	3	12	65	1064	1894	1256	6240851	5600000	6399999
9	352269	3	12	65	1393	1179	1139	6597334	6400000	7199999
10	730821	1	12	65	1808	0	0	7331866	7200000	7999999
11	1042982	1	12	95	1713	0	0	8376656	8000000	8799999
12	1216431	1	12	75	1365	0	0	9594800	8800000	9599999
13	640185	2	12	75	1180	1451	0	10236350	9600000	10399999
14	408654	3	12	55	1540	1064	1259	10647635	10400000	11199999
15	691291	2	12	90	1987	1209	0	11342789	11200000	11999999

Total number of pulses in waveform = 33

Type 5 Radar Waveform_6

Num of Bursts = 16
Burst Interval (us)= 750000

Burst #	Off Time (us)	# Pulses	Chirp (MHz)	PW (us)	Pulse 1 Pri (us)	Pulse 2 Pri (us)	Pulse 3 Pri (us)	Start Loc (us)	Start Burst Interval (us)	End Burst Interval (us)
1	403573	1	8	70	1611	0	0	403573	0	749999
2	1059343	2	8	55	1651	1209	0	1464527	750000	1499999
3	312415	1	8	95	1280	0	0	1779802	1500000	2249999
4	786709	1	8	90	1286	0	0	2567791	2250000	2999999
5	491671	1	8	75	1558	0	0	3060748	3000000	3749999
6	729175	2	8	80	1169	1905	0	3791481	3750000	4499999
7	1291611	2	8	70	1550	1608	0	5086166	4500000	5249999
8	369026	2	8	95	1444	1246	0	5458350	5250000	5999999
9	1055072	3	8	95	1105	1711	1913	6516112	6000000	6749999
10	420613	3	8	80	1443	1235	1042	6941454	6750000	7499999
11	958807	1	8	50	1507	0	0	7903981	7500000	8249999
12	376695	1	8	50	1519	0	0	8282183	8250000	8999999
13	1138252	1	8	100	1058	0	0	9421954	9000000	9749999
14	523196	3	8	65	1838	1850	1683	9946208	9750000	10499999
15	962242	1	8	95	2000	0	0	10913821	10500000	11249999
16	562688	1	8	55	1318	0	0	11478509	11250000	11999999

Total number of pulses in waveform = 26

Type 5 Radar Waveform_7

Num of Bursts = 17
Burst Interval (us)= 705882

Burst #	Off Time (us)	# Pulses	Chirp (MHz)	PW (us)	Pulse 1 Pri (us)	Pulse 2 Pri (us)	Pulse 3 Pri (us)	Start Loc (us)	Start Burst Interval (us)	End Burst Interval (us)
1	496800	3	10	65	1114	1447	1233	496800	0	705881
2	902545	1	10	90	1428	0	0	1403139	705882	1411763
3	306646	3	10	90	1476	1297	1630	1711213	1411764	2117645
4	471078	1	10	60	1685	0	0	2186694	2117646	2823527
5	1040388	2	10	55	1432	1663	0	3228767	2823528	3529409
6	756762	1	10	100	1905	0	0	3988624	3529410	4235291
7	370712	1	10	65	1448	0	0	4361241	4235292	4941173
8	1266682	1	10	95	1523	0	0	5629371	4941174	5647055
9	258810	3	10	85	1577	1487	1765	5889704	5647056	6352937
10	797194	1	10	65	1466	0	0	6691727	6352938	7058819
11	1057201	1	10	80	1708	0	0	7750394	7058820	7764701
12	201773	2	10	60	1037	1785	0	7953875	7764702	8470583
13	1040721	1	10	100	1213	0	0	8997418	8470584	9176465
14	710151	3	10	55	1157	2000	1219	9708782	9176466	9882347
15	753180	1	10	100	1225	0	0	10466338	9882348	10588229
16	192418	3	10	100	1434	1263	1891	10659981	10588230	11294111
17	1240637	3	10	55	1907	1265	1937	11905206	11294112	11999993

Total number of pulses in waveform = 31



Type 5 Radar Waveform_8

Num of Bursts = 20
Burst Interval (us) = 600000

Burst #	Off Time (us)	# Pulses	Chirp (MHz)	PW (us)	Pulse 1 Pri (us)	Pulse 2 Pri (us)	Pulse 3 Pri (us)	Start Loc (us)	Start Burst Interval (us)	End Burst Interval (us)
1	625041	1	19	55	1989	0	0	188898	0	599999
2	716639	2	19	75	1353	1515	0	816628	600000	1199999
3	642527	1	19	90	1022	0	0	1536135	1200000	1799999
4	509017	2	19	75	1089	1459	0	2179584	1800000	2399999
5	702577	2	19	80	1325	1275	0	2691249	2400000	2999999
6	559525	2	19	80	1028	1337	0	3396425	3000000	3599999
7	757991	1	19	90	1523	0	0	3958316	3600000	4199999
8	595230	2	19	85	1351	1788	0	4717830	4200000	4799999
9	642977	2	19	75	1407	1601	0	5316199	4800000	5399999
10	362559	3	19	80	1998	1395	1158	5961884	5400000	5999999
11	808476	2	19	55	1539	1820	0	6328994	6000000	6599999
12	101068	1	19	90	1012	0	0	7140829	6600000	7199999
13	1146422	2	19	60	1820	1696	0	7242909	7200000	7799999
14	444151	2	19	50	1730	1740	0	8392847	7800000	8399999
15	385016	1	19	50	1516	0	0	8840468	8400000	8999999
16	736564	1	19	50	1792	0	0	9227900	9000000	9599999
17	305599	2	19	75	1453	1052	0	9966356	9600000	10199999
18	1069209	3	19	65	1717	1107	1288	10274460	10200000	10799999
19	244435	1	19	55	1034	0	0	11347781	10800000	11399999
20		3	19	85	1801	1226	1368	11593250	11400000	11999999

Total number of pulses in waveform = 36

Type 5 Radar Waveform_9

Num of Bursts = 14
Burst Interval (us) = 857143

Burst #	Off Time (us)	# Pulses	Chirp (MHz)	PW (us)	Pulse 1 Pri (us)	Pulse 2 Pri (us)	Pulse 3 Pri (us)	Start Loc (us)	Start Burst Interval (us)	End Burst Interval (us)
1	51574	1	9	100	1865	0	0	51574	0	857142
2	1527774	2	9	85	1192	1957	0	1581213	857143	1714285
3	833764	1	9	75	1103	0	0	2418126	1714286	2571428
4	792164	1	9	95	1299	0	0	3211393	2571429	3428571
5	229846	2	9	100	1395	1957	0	3442538	3428572	4285714
6	1360994	1	9	65	1490	0	0	4806884	4285715	5142857
7	1013269	1	9	100	1634	0	0	5821643	5142858	6000000
8	1009156	1	9	75	1865	0	0	6832433	6000001	6857143
9	872459	3	9	65	1627	1758	1062	7706757	6857144	7714286
10	624074	3	9	55	1295	1313	1535	8335278	7714287	8571429
11	527320	2	9	50	1007	1120	0	8866741	8571430	9428572
12	954860	2	9	75	1592	1118	0	9823728	9428573	10285715
13	786188	2	9	75	1173	1489	0	10612626	10285716	11142858
14	672246	2	9	65	1538	1207	0	11287534	11142859	12000001

Total number of pulses in waveform = 24

Type 5 Radar Waveform_10

Num of Bursts = 16
Burst Interval (us) = 750000

Burst #	Off Time (us)	# Pulses	Chirp (MHz)	PW (us)	Pulse 1 Pri (us)	Pulse 2 Pri (us)	Pulse 3 Pri (us)	Start Loc (us)	Start Burst Interval (us)	End Burst Interval (us)
1	554750	1	18	85	1486	0	0	554750	0	749999
2	690964	1	18	90	1591	0	0	1247200	750000	1499999
3	294556	3	18	60	1429	1950	1629	1543347	1500000	2249999
4	794689	3	18	70	1111	1851	1653	2343044	2250000	2999999
5	816808	1	18	90	1267	0	0	3164467	3000000	3749999
6	1068196	3	18	65	1608	1423	1498	4233930	3750000	4499999
7	851873	1	18	60	1777	0	0	5090332	4500000	5249999
8	224230	2	18	80	1467	1159	0	5316339	5250000	5999999
9	1128765	1	18	65	1324	0	0	6447730	6000000	6749999
10	826953	1	18	50	1905	0	0	7276007	6750000	7499999
11	344287	3	18	90	1017	1131	1308	7622199	7500000	8249999
12	1291137	2	18	70	1839	1938	0	8916792	8250000	8999999
13	230236	3	18	90	1428	1504	1065	9150805	9000000	9749999
14	758256	3	18	55	1639	1493	1798	9913058	9750000	10499999
15	589229	1	18	100	1480	0	0	10507217	10500000	11249999
16	1123899	3	18	95	1603	1307	1987	11632596	11250000	11999999

Total number of pulses in waveform = 32



Type 5 Radar Waveform_11

Num of Bursts = 13
Burst Interval (us)= 923077

Burst #	Off Time (us)	# Pulses	Chirp (MHz)	PW (us)	Pulse 1 Pri (us)	Pulse 2 Pri (us)	Pulse 3 Pri (us)	Start Loc (us)	Start Burst Interval (us)	End Burst Interval (us)
1	419982	3	8	50	1696	1583	1998	419982	0	923076
2	532463	1	8	50	1507	0	0	957722	923077	1846153
3	1045154	3	8	90	1567	1264	1816	2004383	1846154	2769230
4	1184334	1	8	75	1872	0	0	3193364	2769231	3692307
5	1099294	3	8	95	1248	1021	1890	4294530	3692308	4615384
6	836084	2	8	95	1868	1950	0	5134773	4615385	5538461
7	1131368	3	8	70	1894	1298	1108	6269959	5538462	6461538
8	1075691	3	8	80	1895	1120	1732	7349950	6461539	7384615
9	866685	1	8	55	1567	0	0	8221382	7384616	8307692
10	902999	3	8	80	1263	1407	1440	9125948	8307693	9230769
11	877068	1	8	95	1570	0	0	10007126	9230770	10153846
12	284103	3	8	70	1340	1515	1860	10292799	10153847	11076923
13	1450574	2	8	50	1084	1387	0	11748088	11076924	12000000

Total number of pulses in waveform = 29

Type 5 Radar Waveform_12

Num of Bursts = 17
Burst Interval (us)= 705882

Burst #	Off Time (us)	# Pulses	Chirp (MHz)	PW (us)	Pulse 1 Pri (us)	Pulse 2 Pri (us)	Pulse 3 Pri (us)	Start Loc (us)	Start Burst Interval (us)	End Burst Interval (us)
1	202055	1	6	50	1015	0	0	202055	0	705881
2	1047094	1	6	50	1008	0	0	1250164	705882	1411763
3	764072	3	6	80	1587	1064	1835	2015244	1411764	2117645
4	522801	3	6	85	1394	1304	1944	2542531	2117646	2823527
5	974492	3	6	75	1235	1473	1427	3521665	2823528	3529409
6	342059	3	6	65	1836	1505	1142	3867859	3529410	4235291
7	613074	1	6	90	1251	0	0	4485416	4235292	4941173
8	510982	3	6	90	1004	1625	1654	4997649	4941174	5647055
9	1013351	3	6	70	1822	1416	1111	6015283	5647056	6352937
10	464580	3	6	75	1110	1986	1909	6484212	6352938	7058819
11	887193	1	6	65	1259	0	0	7376410	7058820	7764701
12	1056743	3	6	55	1125	1048	1144	8434412	7764702	8470583
13	322574	1	6	90	1178	0	0	8760303	8470584	9176465
14	574002	2	6	85	1581	1310	0	9335483	9176466	9882347
15	1195695	3	6	90	1815	1136	1036	10534069	9882348	10588229
16	395611	3	6	65	1983	1454	1186	10933667	10588230	11294111
17	933729	1	6	70	1932	0	0	11872019	11294112	11999993

Total number of pulses in waveform = 38

Type 5 Radar Waveform_13

Num of Bursts = 14
Burst Interval (us)= 857143

Burst #	Off Time (us)	# Pulses	Chirp (MHz)	PW (us)	Pulse 1 Pri (us)	Pulse 2 Pri (us)	Pulse 3 Pri (us)	Start Loc (us)	Start Burst Interval (us)	End Burst Interval (us)
1	661435	1	17	75	1597	0	0	661435	0	857142
2	1030637	2	17	85	1754	1687	0	1693669	857143	1714285
3	609451	1	17	90	1618	0	0	2306561	1714286	2571428
4	654987	2	17	55	1394	1907	0	2963166	2571429	3428571
5	890511	3	17	75	1063	1147	1864	3856978	3428572	4285714
6	867950	1	17	60	1142	0	0	4729002	4285715	5142857
7	591351	3	17	60	1965	1733	1992	5321495	5142858	6000000
8	1326075	2	17	60	1306	1769	0	6653260	6000001	6857143
9	561824	1	17	80	1908	0	0	7218159	6857144	7714286
10	726090	3	17	80	1413	1045	1700	7946157	7714287	8571429
11	967103	2	17	55	1528	1516	0	8917418	8571430	9428572
12	553714	1	17	75	1927	0	0	9474176	9428573	10285715
13	1390877	3	17	65	1529	1519	1442	10866980	10285716	11142858
14	602955	3	17	50	1790	1750	1781	11474425	11142859	12000001

Total number of pulses in waveform = 28



Type 5 Radar Waveform_14

Num of Bursts = 8
Burst Interval (us)= 1500000

Burst #	Off Time (us)	# Pulses	Chirp (MHz)	PW (us)	Pulse 1 Pri (us)	Pulse 2 Pri (us)	Pulse 3 Pri (us)	Start Loc (us)	Start Burst Interval (us)	End Burst Interval (us)
1	204436	1	5	50	1361	0	0	204436	0	1499999
2	2709706	3	5	60	1135	1918	1842	2915503	1500000	2999999
3	909458	3	5	100	1497	1571	1729	3829856	3000000	4499999
4	1246778	3	5	50	1397	1054	1041	5081431	4500000	5999999
5	1505639	3	5	100	1438	1568	1156	6590562	6000000	7499999
6	1518635	3	5	85	1998	1757	1797	8113359	7500000	8999999
7	1482815	1	5	60	1420	0	0	9601726	9000000	10499999
8	1035531	1	5	65	1784	0	0	10638677	10500000	11999999

Total number of pulses in waveform = 18

Type 5 Radar Waveform_15

Num of Bursts = 8
Burst Interval (us)= 1500000

Burst #	Off Time (us)	# Pulses	Chirp (MHz)	PW (us)	Pulse 1 Pri (us)	Pulse 2 Pri (us)	Pulse 3 Pri (us)	Start Loc (us)	Start Burst Interval (us)	End Burst Interval (us)
1	984159	1	14	55	1478	0	0	984159	0	1499999
2	752850	3	14	55	1346	1146	1390	1738487	1500000	2999999
3	1927691	1	14	85	1250	0	0	3670060	3000000	4499999
4	2146137	3	14	85	1271	1312	1812	5817447	4500000	5999999
5	384622	2	14	80	1313	1914	0	6206464	6000000	7499999
6	2211739	2	14	70	1938	1377	0	8421430	7500000	8999999
7	1011099	3	14	75	1469	1842	1920	9435844	9000000	10499999
8	1163166	3	14	80	1188	1991	1117	10604241	10500000	11999999

Total number of pulses in waveform = 18

Type 5 Radar aveform_16

Num of Bursts = 8
Burst Interval (us)= 1500000

Burst #	Off Time (us)	# Pulses	Chirp (MHz)	PW (us)	Pulse 1 Pri (us)	Pulse 2 Pri (us)	Pulse 3 Pri (us)	Start Loc (us)	Start Burst Interval (us)	End Burst Interval (us)
1	1319150	2	19	60	1673	1886	0	1319150	0	1499999
2	1234157	3	19	60	1362	1366	1177	2556866	1500000	2999999
3	1440958	3	19	80	1027	1136	1872	4001729	3000000	4499999
4	1966641	3	19	95	1167	1908	1548	5972405	4500000	5999999
5	606867	3	19	95	1204	1566	1086	6583895	6000000	7499999
6	1664464	3	19	100	1061	1024	1682	8252215	7500000	8999999
7	944843	2	19	80	1251	1048	0	9200825	9000000	10499999
8	2354870	2	19	75	1248	1105	0	11557994	10500000	11999999

Total number of pulses in waveform = 21



Type 5 Radar Waveform_17

Num of Bursts = 20
Burst Interval (us)= 600000

Burst #	Off Time (us)	# Pulses	Chirp (MHz)	PW (us)	Pulse 1 Pri (us)	Pulse 2 Pri (us)	Pulse 3 Pri (us)	Start Loc (us)	Start Burst Interval (us)	End Burst Interval (us)
1	36912	1	18	70	1270	0	0	36912	0	699999
2	808602	3	18	50	1544	1221	1100	846784	600000	1199999
3	875187	2	18	55	1864	1964	0	1725836	1200000	1799999
4	143552	3	18	75	1344	1272	1019	1873206	1800000	2399999
5	988817	3	18	95	1056	1885	1762	2865658	2400000	2999999
6	278357	3	18	80	1968	1558	1966	3148708	3000000	3599999
7	607230	2	18	75	1991	1794	0	3760830	3600000	4199999
8	760380	2	18	70	1417	1086	0	4524995	4200000	4799999
9	717304	2	18	95	1854	1544	0	5244802	4800000	5399999
10	519361	2	18	50	1417	1866	0	5767561	5400000	5999999
11	587349	3	18	60	1000	1244	1972	6368193	6000000	6599999
12	817095	3	18	95	1089	1045	1927	7179504	6600000	7199999
13	20487	3	18	50	1873	1566	1567	7204022	7200000	7799999
14	773590	1	18	85	1507	0	0	7982618	7800000	8399999
15	943497	2	18	90	1657	1462	0	8927622	8400000	8999999
16	302713	3	18	70	1059	1303	1084	9233454	9000000	9599999
17	627551	3	18	60	1222	1797	1221	9864451	9600000	10199999
18	656375	2	18	85	1601	1478	0	10525066	10200000	10799999
19	309487	3	18	85	1859	1814	1082	10837632	10800000	11399999
20	908895	1	18	80	1930	0	0	11751282	11400000	11999999

Total number of pulses in waveform = 47

Type 5 Radar Waveform_18

Num of Bursts = 10
Burst Interval (us)= 1200000

Burst #	Off Time (us)	# Pulses	Chirp (MHz)	PW (us)	Pulse 1 Pri (us)	Pulse 2 Pri (us)	Pulse 3 Pri (us)	Start Loc (us)	Start Burst Interval (us)	End Burst Interval (us)
1	785857	3	9	60	1169	1639	1277	785857	0	1199999
2	1072456	1	9	90	1718	0	0	1862398	1200000	2399999
3	1390608	1	9	50	1577	0	0	3254724	2400000	3599999
4	801112	3	9	80	1154	1136	1858	4057413	3600000	4799999
5	1594762	3	9	55	1255	1450	1133	5656323	4800000	5999999
6	572810	3	9	65	1086	1243	1208	6232971	6000000	7199999
7	965385	1	9	65	1249	0	0	7201893	7200000	8399999
8	1684456	3	9	95	1679	1500	1078	8887598	8400000	9599999
9	1446911	2	9	70	1659	1535	0	10338766	9600000	10799999
10	806266	1	9	55	1968	0	0	11148226	10800000	11999999

Total number of pulses in waveform = 21

Type 5 Radar Waveform_19

Num of Bursts = 16
Burst Interval (us)= 750000

Burst #	Off Time (us)	# Pulses	Chirp (MHz)	PW (us)	Pulse 1 Pri (us)	Pulse 2 Pri (us)	Pulse 3 Pri (us)	Start Loc (us)	Start Burst Interval (us)	End Burst Interval (us)
1	258984	1	10	85	1998	0	0	258984	0	749999
2	991985	2	10	90	1548	1182	0	1252967	750000	1499999
3	904791	1	10	100	1972	0	0	2160488	1500000	2249999
4	201945	2	10	70	1195	1766	0	2364405	2250000	2999999
5	1028652	2	10	80	1833	1976	0	3396018	3000000	3749999
6	570372	2	10	50	1658	1006	0	3970199	3750000	4499999
7	998016	2	10	65	1735	1064	0	4970879	4500000	5249999
8	451842	3	10	60	1789	1435	1298	5425520	5250000	5999999
9	1058857	1	10	70	1310	0	0	6488899	6000000	6749999
10	361523	1	10	75	1538	0	0	6851732	6750000	7499999
11	947072	1	10	90	1982	0	0	7800342	7500000	8249999
12	752395	3	10	65	1570	1299	1452	8554719	8250000	8999999
13	755831	3	10	85	1556	1692	1539	9314871	9000000	9749999
14	891652	3	10	100	1156	1316	1955	10211310	9750000	10499999
15	758261	1	10	50	1158	0	0	10973998	10500000	11249999
16	752718	3	10	55	1088	1480	1330	11727874	11250000	11999999

Total number of pulses in waveform = 31



Type 5 Radar Waveform_20

Num of Bursts = 14
Burst Interval (us)= 857143

Burst #	Off Time (us)	# Pulses	Chirp (MHz)	PW (us)	Pulse 1 Pri (us)	Pulse 2 Pri (us)	Pulse 3 Pri (us)	Start Loc (us)	Start Burst Interval (us)	End Burst Interval (us)
1	188121	2	12	90	1752	1253	0	188121	0	857142
2	1130809	3	12	50	1444	1761	1321	1321935	857143	1714285
3	642750	3	12	90	1238	1674	1002	1969211	1714286	2571428
4	757550	1	12	80	1986	0	0	2730675	2571429	3428571
5	1087512	3	12	70	1884	1824	1042	3820173	3428572	4285714
6	860031	2	12	50	1227	1166	0	4684954	4285715	5142857
7	790370	1	12	75	1007	0	0	5477717	5142858	6000000
8	761668	2	12	85	1416	1090	0	6240392	6000001	6857143
9	1429812	3	12	85	1316	1478	1729	7672710	6857144	7714286
10	713521	3	12	80	1688	1139	1984	8390754	7714287	8571429
11	404612	2	12	90	1913	1055	0	8800177	8571430	9428572
12	709776	2	12	55	1202	1963	0	9512921	9428573	10285715
13	977397	2	12	60	1149	1831	0	10493483	10285716	11142858
14	670139	1	12	100	1086	0	0	11166602	11142859	12000001

Total number of pulses in waveform = 30

Type 5 Radar Waveform_21

Num of Bursts = 8
Burst Interval (us)= 1500000

Burst #	Off Time (us)	# Pulses	Chirp (MHz)	PW (us)	Pulse 1 Pri (us)	Pulse 2 Pri (us)	Pulse 3 Pri (us)	Start Loc (us)	Start Burst Interval (us)	End Burst Interval (us)
1	390751	1	8	90	1241	0	0	390751	0	1499999
2	1889091	2	8	90	1014	1267	0	2281083	1500000	2999999
3	1814358	2	8	70	1275	1070	0	4097722	3000000	4499999
4	1458133	1	8	90	1715	0	0	5558200	4500000	5999999
5	1177359	2	8	90	1032	1234	0	6737274	6000000	7499999
6	1624819	1	8	95	1258	0	0	8364359	7500000	8999999
7	1971099	1	8	50	1000	0	0	10336716	9000000	10499999
8	1527852	2	8	60	1294	1773	0	11865568	10500000	11999999

Total number of pulses in waveform = 12

Type 5 Radar Waveform_22

Num of Bursts = 9
Burst Interval (us)= 1333333

Burst #	Off Time (us)	# Pulses	Chirp (MHz)	PW (us)	Pulse 1 Pri (us)	Pulse 2 Pri (us)	Pulse 3 Pri (us)	Start Loc (us)	Start Burst Interval (us)	End Burst Interval (us)
1	71251	1	19	75	1085	0	0	71251	0	1333332
2	2193931	2	19	75	1238	1183	0	2266267	1333333	2666665
3	932330	1	19	50	1252	0	0	3201018	2666666	3999998
4	1681517	1	19	90	1183	0	0	4883787	3999999	5333331
5	1023752	1	19	95	1319	0	0	5908722	5333332	6666664
6	1550930	2	19	100	1959	1693	0	7460971	6666665	7999997
7	788403	3	19	85	1457	1310	1786	8253026	7999998	9333330
8	1699127	3	19	70	1189	1495	1889	9956706	9333331	10666663
9	1520185	2	19	60	1333	1169	0	11481464	10666664	11999996

Total number of pulses in waveform = 16



Type 5 Radar Waveform_23

Num of Bursts = 18
Burst Interval (us) = 666667

Burst #	Off Time (us)	# Pulses	Chirp (MHz)	PW (us)	Pulse 1 Pri (us)	Pulse 2 Pri (us)	Pulse 3 Pri (us)	Start Loc (us)	Start Burst Interval (us)	End Burst Interval (us)
1	18842	2	18	80	1257	1934	0	18842	0	666666
2	829829	2	18	75	1770	1601	0	851862	666667	1333333
3	929251	2	18	65	1219	1339	0	1784484	1333334	2000000
4	805903	3	18	50	1518	1966	1111	2592945	2000001	2666667
5	143984	3	18	100	1884	1263	1097	2741524	2666668	3333334
6	1004477	1	18	60	1751	0	0	3750245	3333335	4000001
7	596381	2	18	55	1961	1035	0	4348377	4000002	4666668
8	333861	2	18	55	1667	1121	0	4685234	4666669	5333335
9	665963	2	18	65	1972	1226	0	5353985	5333336	6000002
10	761582	2	18	85	1086	1925	0	6118765	6000003	6666669
11	850123	1	18	55	1188	0	0	6971899	6666670	7333336
12	486551	2	18	75	1640	1103	0	7459638	7333337	8000003
13	1109889	1	18	75	1539	0	0	8572270	8000004	8666670
14	743526	2	18	60	1295	1708	0	9317335	8666671	9333337
15	305255	1	18	85	1227	0	0	9625593	9333338	10000004
16	937549	2	18	70	1255	1549	0	10564369	10000005	10666671
17	347559	2	18	60	1593	1434	0	10914732	10666672	11333338
18	848315	3	18	90	1097	1042	1057	11766074	11333339	12000005

Total number of pulses in waveform = 35

Type 5 Radar Waveform_24

Num of Bursts = 20
Burst Interval (us) = 600000

Burst #	Off Time (us)	# Pulses	Chirp (MHz)	PW (us)	Pulse 1 Pri (us)	Pulse 2 Pri (us)	Pulse 3 Pri (us)	Start Loc (us)	Start Burst Interval (us)	End Burst Interval (us)
1	438170	3	10	55	1036	1521	1243	438170	0	599999
2	210492	3	10	50	1070	1075	1070	652462	600000	1199999
3	949196	1	10	60	1682	0	0	1605217	1200000	1799999
4	232990	3	10	65	1378	1583	1105	1839889	1800000	2399999
5	811465	3	10	75	1610	1291	1575	2655420	2400000	2999999
6	461623	3	10	55	1298	1484	1295	3111419	3000000	3599999
7	798318	1	10	80	1743	0	0	3913814	3600000	4199999
8	358924	2	10	80	1423	1449	0	4274481	4200000	4799999
9	666398	1	10	65	1256	0	0	4933751	4800000	5399999
10	688992	2	10	55	1431	1157	0	5623999	5400000	5999999
11	743312	3	10	60	1799	1672	1848	6369899	6000000	6599999
12	288924	2	10	80	1683	1146	0	6664142	6600000	7199999
13	641893	2	10	100	1109	1724	0	7308864	7200000	7799999
14	850035	3	10	90	1554	1543	1637	8161732	7800000	8399999
15	582204	2	10	60	1785	1424	0	8748670	8400000	8999999
16	815696	1	10	90	1916	0	0	9567575	9000000	9599999
17	382446	1	10	50	1846	0	0	9951937	9600000	10199999
18	376536	3	10	80	1710	1285	1099	10330319	10200000	10799999
19	479265	2	10	80	1843	1358	0	10813678	10800000	11399999
20	939471	1	10	60	1324	0	0	11756350	11400000	11999999

Total number of pulses in waveform = 42

Type 5 Radar Waveform_25

Num of Bursts = 19
Burst Interval (us) = 631579

Burst #	Off Time (us)	# Pulses	Chirp (MHz)	PW (us)	Pulse 1 Pri (us)	Pulse 2 Pri (us)	Pulse 3 Pri (us)	Start Loc (us)	Start Burst Interval (us)	End Burst Interval (us)
1	299682	2	6	50	1414	1551	0	299682	0	631578
2	396924	2	6	100	1946	1710	0	699571	631579	1263157
3	954776	1	6	60	1249	0	0	1658003	1263158	1894736
4	822693	1	6	100	1053	0	0	2481945	1894737	2526315
5	607585	2	6	90	1426	1525	0	3090583	2526316	3157894
6	610080	1	6	95	1439	0	0	3703614	3157895	3789473
7	132509	1	6	95	1763	0	0	3837562	3789474	4421052
8	1126403	1	6	80	1085	0	0	4965728	4421053	5052631
9	580677	3	6	95	1154	1541	1934	5547490	5052632	5684210
10	414312	1	6	90	1713	0	0	5966431	5684211	6315789
11	504967	2	6	90	1136	1975	0	6473111	6315790	6947368
12	1076265	3	6	95	1832	1290	1967	7552487	6947369	7578947
13	148146	1	6	60	1322	0	0	7705722	7578948	8210526
14	951398	2	6	50	1003	1533	0	8658442	8210527	8842105
15	271425	1	6	95	1768	0	0	8932403	8842106	9473684
16	831520	1	6	75	1328	0	0	9765691	9473685	10105263
17	758516	1	6	70	1415	0	0	10525535	10105264	10736842
18	836700	1	6	70	1951	0	0	11363650	10736843	11368421
19	339125	3	6	65	1698	1501	1786	11704726	11368422	12000000

Total number of pulses in waveform = 30



Type 5 Radar Waveform_26

Num of Bursts = 20
Burst Interval (us) = 600000

Burst #	Off Time (us)	# Pulses	Chirp (MHz)	PW (us)	Pulse 1 Pri (us)	Pulse 2 Pri (us)	Pulse 3 Pri (us)	Start Loc (us)	Start Burst Interval (us)	End Burst Interval (us)
1	241278	1	17	90	1029	0	0	241278	0	599999
2	406728	3	17	60	1962	1010	1878	649035	600000	1199999
3	672746	1	17	60	1282	0	0	1326621	1200000	1799999
4	631507	2	17	55	1073	1054	0	1959410	1800000	2399999
5	954663	1	17	90	1802	0	0	2916200	2400000	2999999
6	175419	1	17	70	1275	0	0	3093421	3000000	3599999
7	771087	3	17	95	1586	1265	1394	3865783	3600000	4199999
8	911107	1	17	100	1005	0	0	4781135	4200000	4799999
9	417786	1	17	95	1167	0	0	5199926	4800000	5399999
10	673305	2	17	90	1017	1206	0	5874398	5400000	5999999
11	131219	3	17	95	1858	1382	1049	6007840	6000000	6599999
12	868808	1	17	60	1734	0	0	6880937	6600000	7199999
13	570866	3	17	70	1932	1797	1652	7453537	7200000	7799999
14	720799	1	17	90	1817	0	0	8179717	7800000	8399999
15	273541	3	17	90	1523	1741	1416	8455075	8400000	8999999
16	576841	3	17	90	1589	1333	1335	9036596	9000000	9599999
17	931210	2	17	50	1780	1883	0	9972063	9600000	10199999
18	782803	2	17	70	1972	1022	0	10758329	10200000	10799999
19	52801	3	17	50	1728	1037	1920	10814124	10800000	11399999
20	999930	3	17	75	1639	1280	1830	11812739	11400000	11999999

Total number of pulses in waveform = 40

Type 5 Radar Waveform_27

Num of Bursts = 14
Burst Interval (us) = 857143

Burst #	Off Time (us)	# Pulses	Chirp (MHz)	PW (us)	Pulse 1 Pri (us)	Pulse 2 Pri (us)	Pulse 3 Pri (us)	Start Loc (us)	Start Burst Interval (us)	End Burst Interval (us)
1	583322	3	9	65	1625	1436	1514	583322	0	857142
2	321634	1	9	55	1772	0	0	909531	857143	1714285
3	1142087	1	9	100	1315	0	0	2053390	1714286	2571428
4	922108	1	9	60	1546	0	0	2976813	2571429	3428571
5	539617	3	9	95	1909	1046	1674	3517976	3428572	4285714
6	1180407	2	9	50	1758	1856	0	4703012	4285715	5142857
7	747435	3	9	85	1636	1331	1610	5454061	5142858	6000000
8	609640	1	9	75	1571	0	0	6068278	6000001	6857143
9	1100096	3	9	80	1489	1651	1755	7169945	6857144	7714286
10	548446	3	9	90	1956	1134	1725	7723286	7714287	8571429
11	967975	3	9	100	1470	1956	1481	8696076	8571430	9428572
12	1275378	3	9	65	1652	1797	1355	9976361	9428573	10285715
13	536716	1	9	80	1610	0	0	10517881	10285716	11142858
14	1315591	3	9	50	1688	1389	1229	11835082	11142859	12000001

Total number of pulses in waveform = 31

Type 5 Radar Waveform_28

Num of Bursts = 18
Burst Interval (us) = 666667

Burst #	Off Time (us)	# Pulses	Chirp (MHz)	PW (us)	Pulse 1 Pri (us)	Pulse 2 Pri (us)	Pulse 3 Pri (us)	Start Loc (us)	Start Burst Interval (us)	End Burst Interval (us)
1	367003	3	12	60	1577	1212	1787	367003	0	666666
2	923951	3	12	85	1108	1658	1147	1295530	666667	1333333
3	260377	3	12	75	1564	1448	1366	1558620	1333334	2000000
4	725762	3	12	60	1530	1365	1484	2289960	2000001	2666667
5	828392	1	12	55	1405	0	0	3122731	2666668	3333334
6	466792	1	12	55	1122	0	0	3590928	3333335	4000001
7	505700	3	12	50	1234	1304	1698	4097750	4000002	4666668
8	1053936	2	12	85	1076	1753	0	5155922	4666669	5333335
9	247495	3	12	100	1640	1888	1735	5406246	5333336	6000002
10	683577	1	12	85	1693	0	0	6095086	6000003	6666669
11	980064	3	12	50	1985	1133	1906	7076843	6666670	7333336
12	861706	1	12	90	1043	0	0	7943573	7333337	8000003
13	184073	3	12	85	1763	1849	1362	8128689	8000004	8666670
14	753385	2	12	55	1601	1107	0	8887048	8666671	9333337
15	834191	3	12	85	1678	1104	1026	9723947	9333338	10000004
16	443507	1	12	90	1048	0	0	10171262	10000005	10666671
17	850449	2	12	75	1738	1722	0	11022759	10666672	11333338
18	866559	3	12	100	1234	1783	1071	11892878	11333339	12000005

Total number of pulses in waveform = 41



Type 5 Radar Waveform_29

Num of Bursts = 10
Burst Interval (us)= 1200000

Burst #	Off Time (us)	# Pulses	Chirp (MHz)	PW (us)	Pulse 1 Pri (us)	Pulse 2 Pri (us)	Pulse 3 Pri (us)	Start Loc (us)	Start Burst Interval (us)	End Burst Interval (us)
1	881911	3	14	95	1976	1945	1929	881911	0	1199999
2	1239266	3	14	55	1757	1229	1507	2127027	1200000	2399999
3	874185	1	14	80	1956	0	0	3005705	2400000	3599999
4	614537	2	14	60	1950	1480	0	3622198	3600000	4799999
5	2108638	1	14	90	1897	0	0	5734266	4800000	5999999
6	1283583	2	14	75	1313	1431	0	7019746	6000000	7199999
7	1328770	1	14	100	1120	0	0	8351260	7200000	8399999
8	133580	3	14	65	1195	1867	1355	8485960	8400000	9599999
9	1484787	1	14	55	1160	0	0	9975164	9600000	10799999
10	1797540	1	14	60	1690	0	0	11773864	10800000	11999999

Total number of pulses in waveform = 18

Type 5 Radar Waveform_30

Num of Bursts = 11
Burst Interval (us)= 1090909

Burst #	Off Time (us)	# Pulses	Chirp (MHz)	PW (us)	Pulse 1 Pri (us)	Pulse 2 Pri (us)	Pulse 3 Pri (us)	Start Loc (us)	Start Burst Interval (us)	End Burst Interval (us)
1	170930	2	5	90	1330	1469	0	170930	0	1090908
2	1434837	3	5	70	1448	1878	1522	1608566	1090909	2181817
3	629498	3	5	100	1778	1334	1876	2242912	2181818	3272726
4	1550120	3	5	85	1910	1710	1752	3798020	3272727	4363635
5	1588800	1	5	85	1516	0	0	5392192	4363636	5454544
6	602374	2	5	85	1234	1056	0	5996082	5454545	6545453
7	1009257	2	5	95	1556	1397	0	7007629	6545454	7636362
8	982704	2	5	55	1088	1929	0	7993286	7636363	8727271
9	1796055	2	5	85	1172	1673	0	9792358	8727272	9818180
10	530073	1	5	50	1154	0	0	10325276	9818181	10909089
11	1568224	1	5	75	1843	0	0	11894654	10909090	11999998

Total number of pulses in waveform = 22



Radar Type 6 - Radar Statistical Performance

Trail #	Test Freq. (MHz)	1=Detection 0=No Detection	Trail #	Test Freq. (MHz)	1=Detection 0=No Detection
1	5491	1	16	5530	1
2	5491	1	17	5531	1
3	5500	1	18	5531	1
4	5500	1	19	5540	1
5	5509	1	20	5540	1
6	5509	1	21	5549	1
7	5510	1	22	5549	1
8	5510	1	23	5550	1
9	5511	1	24	5550	1
10	5511	1	25	5551	1
11	5520	1	26	5551	1
12	5520	1	27	5560	1
13	5529	1	28	5560	1
14	5529	1	29	5569	1
15	5530	1	30	5569	1
Detection Percentage (%)					100%



Radar waveform #1			Radar waveform #2		
Hopping Number	Frequency (MHz)	Pulse Start (ms)	Hopping Number	Frequency (MHz)	Pulse Start (ms)
7	5491	21	24	5505	72
10	5514	30	31	5470	93
13	5500	39	41	5487	123
14	5471	42	42	5486	126
15	5461	45	61	5508	183
43	5469	129	82	5506	246
49	5464	147	94	5466	282
60	5511	180	--	--	--
61	5497	183	--	--	--
71	5468	213	--	--	--
85	5499	255	--	--	--
92	5516	276	--	--	--

Radar waveform #3			Radar waveform #4		
Hopping Number	Frequency (MHz)	Pulse Start (ms)	Hopping Number	Frequency (MHz)	Pulse Start (ms)
1	5503	3	0	5518	0
13	5512	39	3	5521	9
18	5527	54	10	5517	30
20	5494	60	15	5480	45
27	5523	81	40	5505	120
32	5518	96	43	5514	129
44	5502	132	46	5510	138
52	5497	156	55	5511	165
60	5475	180	58	5519	174
61	5506	183	60	5471	180
94	5493	282	64	5474	192
--	--	--	72	5508	216
--	--	--	89	5476	267



Radar waveform #5			Radar waveform #6		
Hopping Number	Frequency (MHz)	Pulse Start (ms)	Hopping Number	Frequency (MHz)	Pulse Start (ms)
29	5493	87	1	5488	3
32	5532	96	20	5522	60
37	5494	111	23	5539	69
40	5511	120	25	5526	75
44	5487	132	58	5538	174
45	5528	135	85	5508	255
49	5539	147	97	5525	291
63	5526	189	99	5520	297
81	5490	243	--	--	--
91	5520	273	--	--	--
98	5521	294	--	--	--
99	5486	297	--	--	--



Radar waveform #7			Radar waveform #8		
Hopping Number	Frequency (MHz)	Pulse Start (ms)	Hopping Number	Frequency (MHz)	Pulse Start (ms)
4	5504	12	6	5487	18
9	5538	27	8	5493	24
17	5525	51	27	5536	81
34	5517	102	30	5505	90
61	5489	183	34	5513	102
68	5480	204	42	5528	126
72	5493	216	60	5511	180
73	5523	219	61	5504	183
87	5516	261	91	5519	273
90	5500	270	--	--	--
95	5539	285	--	--	--

Radar waveform #9			Radar waveform #10		
Hopping Number	Frequency (MHz)	Pulse Start (ms)	Hopping Number	Frequency (MHz)	Pulse Start (ms)
7	5528	21	11	5525	33
9	5491	27	16	5483	48
12	5509	36	19	5485	57
13	5481	39	23	5524	69
15	5536	45	25	5529	75
31	5540	93	29	5533	87
44	5526	132	39	5537	117
47	5513	141	41	5510	123
50	5505	150	42	5534	126
64	5496	192	56	5508	168
74	5503	222	57	5514	171
78	5538	234	77	5484	231
85	5510	255	95	5499	285
94	5504	282	96	5505	288
99	5492	297	--	--	--



Radar waveform #11			Radar waveform #12		
Hopping Number	Frequency (MHz)	Pulse Start (ms)	Hopping Number	Frequency (MHz)	Pulse Start (ms)
2	5545	6	13	5525	39
3	5512	9	18	5533	54
17	5539	51	20	5541	60
20	5500	60	28	5491	84
28	5529	84	35	5498	105
36	5516	108	37	5529	111
39	5525	117	43	5546	129
48	5535	144	47	5522	141
55	5531	165	62	5500	186
62	5521	186	91	5537	273
66	5513	198	99	5528	297
68	5520	204	--	--	--
75	5542	225	--	--	--
76	5498	228	--	--	--
80	5530	240	--	--	--
87	5546	261	--	--	--
90	5548	270	--	--	--
98	5507	294	--	--	--

Radar waveform #13			Radar waveform #14		
Hopping Number	Frequency (MHz)	Pulse Start (ms)	Hopping Number	Frequency (MHz)	Pulse Start (ms)
1	5519	3	19	5551	57
8	5555	24	37	5517	111
11	5529	33	38	5503	114
17	5522	51	43	5499	129
19	5526	57	44	5535	132
25	5547	75	51	5520	153
60	5517	180	56	5523	168
72	5534	216	63	5545	189
77	5554	231	72	5549	216
80	5523	240	85	5527	255
90	5553	270	94	5546	282
93	5551	279	--	--	--
98	5537	294	--	--	--



Radar waveform #15			Radar waveform #16		
Hopping Number	Frequency (MHz)	Pulse Start (ms)	Hopping Number	Frequency (MHz)	Pulse Start (ms)
7	5537	21	1	5500	3
16	5557	48	10	5506	30
33	5556	99	13	5518	39
36	5512	108	15	5503	45
53	5553	159	17	5505	51
57	5534	171	23	5517	69
59	5500	177	36	5516	108
65	5511	195	44	5512	132
72	5527	216	56	5557	168
81	5558	243	57	5551	171
84	5507	252	63	5542	189
88	5535	264	76	5538	228
89	5538	267	90	5548	270
--	--	--	94	5560	282

Radar waveform #17			Radar waveform #18		
Hopping Number	Frequency (MHz)	Pulse Start (ms)	Hopping Number	Frequency (MHz)	Pulse Start (ms)
3	5538	9	0	5518	0
16	5517	48	6	5528	18
21	5505	63	7	5544	21
28	5516	84	12	5505	36
31	5543	93	18	5543	54
32	5560	96	40	5520	120
35	5546	105	51	5509	153
40	5535	120	57	5556	171
41	5534	123	59	5501	177
56	5501	168	63	5557	189
61	5540	183	71	5504	213
95	5502	285	79	5548	237
--	--	--	87	5546	261
--	--	--	94	5529	282
--	--	--	95	5506	285
--	--	--	98	5538	294



Radar waveform #19			Radar waveform #20		
Hopping Number	Frequency (MHz)	Pulse Start (ms)	Hopping Number	Frequency (MHz)	Pulse Start (ms)
1	5542	3	0	5564	0
8	5523	24	3	5518	9
20	5519	60	20	5526	60
22	5531	66	27	5522	81
34	5555	102	33	5555	99
40	5543	120	40	5540	120
48	5559	144	48	5550	144
54	5562	162	50	5563	150
60	5540	180	60	5553	180
63	5570	189	69	5532	207
83	5516	249	80	5548	240
85	5517	255	84	5567	252
--	--	--	90	5523	270
--	--	--	92	5514	276

Radar waveform #21			Radar waveform #22		
Hopping Number	Frequency (MHz)	Pulse Start (ms)	Hopping Number	Frequency (MHz)	Pulse Start (ms)
3	5556	9	2	5578	6
9	5572	27	4	5577	12
21	5548	63	9	5541	27
30	5577	90	16	5557	48
38	5560	114	17	5549	51
57	5544	171	18	5579	54
79	5555	237	31	5534	93
83	5578	249	44	5553	132
--	--	--	47	5521	141
--	--	--	49	5552	147
--	--	--	50	5524	150
--	--	--	63	5542	189
--	--	--	68	5527	204
--	--	--	76	5522	228
--	--	--	82	5526	246



Radar waveform #23			Radar waveform #24		
Hopping Number	Frequency (MHz)	Pulse Start (ms)	Hopping Number	Frequency (MHz)	Pulse Start (ms)
5	5529	15	11	5532	33
9	5562	27	12	5541	36
10	5524	30	13	5543	39
12	5532	36	14	5523	42
20	5540	60	16	5545	48
23	5556	69	20	5539	60
43	5575	129	21	5572	63
57	5559	171	22	5560	66
68	5574	204	40	5542	120
84	5564	252	42	5535	126
90	5579	270	43	5555	129
96	5526	288	46	5554	138
97	5533	291	54	5556	162
--	--	--	64	5525	192
--	--	--	81	5571	243
--	--	--	82	5561	246
--	--	--	84	5574	252
--	--	--	99	5577	297

Radar waveform #25			Radar waveform #26		
Hopping Number	Frequency (MHz)	Pulse Start (ms)	Hopping Number	Frequency (MHz)	Pulse Start (ms)
0	5561	0	2	5568	6
3	5553	9	3	5579	9
5	5541	15	9	5557	27
6	5552	18	12	5531	36
9	5539	27	24	5522	72
11	5521	33	25	5561	75
17	5529	51	27	5537	81
23	5573	69	42	5554	126
32	5544	96	43	5556	129
52	5562	156	50	5564	150
55	5522	165	54	5545	162
56	5557	168	66	5529	198
64	5565	192	67	5544	201
67	5571	201	94	5526	282
86	5572	258	97	5546	291
90	5556	270	--	--	--

Radar waveform #27			Radar waveform #28		
Hopping Number	Frequency (MHz)	Pulse Start (ms)	Hopping Number	Frequency (MHz)	Pulse Start (ms)
5	5545	15	16	5531	48
11	5566	33	17	5571	51
18	5548	54	18	5552	54
19	5588	57	19	5536	57
24	5571	72	27	5539	81
33	5578	99	30	5551	90
34	5589	102	33	5550	99
37	5582	111	43	5584	129
40	5559	120	60	5556	180
49	5563	147	62	5582	186
59	5572	177	66	5580	198
60	5570	180	71	5535	213
67	5565	201	87	5570	261
72	5543	216	92	5559	276
86	5553	258	97	5590	291
87	5552	261	99	5573	297
89	5585	267	--	--	--



Radar waveform #29			Radar waveform #30		
Hopping Number	Frequency (MHz)	Pulse Start (ms)	Hopping Number	Frequency (MHz)	Pulse Start (ms)
6	5587	18	8	5580	24
8	5588	24	10	5556	30
10	5560	30	23	5567	69
12	5567	36	28	5544	84
21	5555	63	31	5572	93
28	5586	84	35	5594	105
38	5554	114	37	5553	111
45	5543	135	43	5549	129
69	5552	207	45	5574	135
75	5540	225	47	5583	141
84	5570	252	49	5581	147
89	5568	267	63	5547	189
--	--	--	82	5598	246
--	--	--	88	5585	264
--	--	--	90	5564	270

6. CONCLUSION

The data collected relate only the item(s) tested and show that the **AC220i Wi-Fi AP ID omni antenna US** is in compliance with FCC Rules and ISED Rules.

_____ The End _____