

FCC Test Report

Report No.: RF160815E05D

FCC ID: 2AD8UFW2RADPM01

Test Model: FW2RADPM01

Received Date: Sep. 14, 2018

Test Date: Oct. 03 to 26, 2018

Issued Date: Mar. 08, 2019

Applicant: Nokia Solutions and Networks, OY

Address: 2000 W. Lucent Lane, Naperville, IL 60563, USA

Issued By: Bureau Veritas Consumer Products Services (H.K.) Ltd., Taoyuan Branch
Hsin Chu Laboratory

Lab Address: E-2, No.1, Li Hsin 1st Road, Hsinchu Science Park, Hsinchu City 300,
Taiwan R.O.C.

Test Location: E-2, No.1, Li Hsin 1st Road, Hsinchu Science Park, Hsinchu City 300,
Taiwan R.O.C.

**FCC Registration /
Designation Number:** 723255 / TW2022



This report is for your exclusive use. Any copying or replication of this report to or for any other person or entity, or use of our name or trademark, is permitted only with our prior written permission. This report sets forth our findings solely with respect to the test samples identified herein. The results set forth in this report are not indicative or representative of the quality or characteristics of the lot from which a test sample was taken or any similar or identical product unless specifically and expressly noted. Our report includes all of the tests requested by you and the results thereof based upon the information that you provided to us. You have 60 days from date of issuance of this report to notify us of any material error or omission caused by our negligence, provided, however, that such notice shall be in writing and shall specifically address the issue you wish to raise. A failure to raise such issue within the prescribed time shall constitute your unqualified acceptance of the completeness of this report, the tests conducted and the correctness of the report contents. Unless specific mention, the uncertainty of measurement has been explicitly taken into account to declare the compliance or non-compliance to the specification. The report must not be used by the client to claim product certification, approval, or endorsement by TAF or any government agencies.

Table of Contents

Release Control Record	4
1 Certificate of Conformity	5
2 Summary of Test Results	6
2.1 Measurement Uncertainty	6
2.2 Modification Record	6
3 General Information	7
3.1 General Description of EUT	7
3.2 Description of Test Modes	9
3.2.1 Test Mode Applicability and Tested Channel Detail	11
3.3 Duty Cycle of Test Signal	13
3.4 Description of Support Units	14
3.4.1 Configuration of System under Test	14
3.5 General Description of Applied Standard	15
4 Test Types and Results	16
4.1 Radiated Emission and Bandedge Measurement	16
4.1.1 Limits of Radiated Emission and Bandedge Measurement	16
4.1.2 Test Instruments	17
4.1.3 Test Procedure	19
4.1.4 Deviation from Test Standard	19
4.1.5 Test Setup	20
4.1.6 EUT Operating Condition	21
4.1.7 Test Results	22
4.2 Conducted Emission Measurement	45
4.2.1 Limits of Conducted Emission Measurement	45
4.2.2 Test Instruments	45
4.2.3 Test Procedure	46
4.2.4 Deviation from Test Standard	46
4.2.5 Test Setup	46
4.2.6 EUT Operating Condition	46
4.2.7 Test Results	47
4.3 Transmit Power Measurement	49
4.3.1 Limits of Transmit Power Measurement	49
4.3.2 Test Setup	49
4.3.3 Test Instruments	49
4.3.4 Test Procedure	50
4.3.5 Deviation from Test Standard	50
4.3.6 EUT Operating Condition	50
4.3.7 Test Result	51
4.4 Occupied Bandwidth Measurement	57
4.4.1 Test Setup	57
4.4.2 Test Instruments	57
4.4.3 Test Procedure	57
4.4.4 Test Results	58
4.5 Peak Power Spectral Density Measurement	61
4.5.1 Limits of Peak Power Spectral Density Measurement	61
4.5.2 Test Setup	61
4.5.3 Test Instruments	61
4.5.4 Test Procedure	62
4.5.5 Deviation from Test Standard	62
4.5.6 EUT Operating Condition	62
4.5.7 Test Results	63
4.6 Frequency Stability Measurement	68
4.6.1 Limits of Frequency Stability Measurement	68

4.6.2	Test Setup.....	68
4.6.3	Test Instruments	68
4.6.4	Test Procedure	68
4.6.5	Deviation from Test Standard	68
4.6.6	EUT Operating Condition	68
4.6.7	Test Results	69
4.7	6dB Bandwidth Measurement	70
4.7.1	Limits of 6dB Bandwidth Measurement.....	70
4.7.2	Test Setup.....	70
4.7.3	Test Instruments	70
4.7.4	Test Procedure	70
4.7.5	Deviation from Test Standard	70
4.7.6	EUT Operating Condition	70
4.7.7	Test Results	71
4.8	26dB Bandwidth Measurement	73
4.8.1	Test Setup.....	73
4.8.2	Test Instruments	73
4.8.3	Test Procedure	73
4.8.4	Deviation from Test Standard	73
4.8.5	EUT Operating Condition	73
4.8.6	Test Results	74
5	Pictures of Test Arrangements.....	77
	Appendix – Information of the Testing Laboratories	78

Release Control Record

Issue No.	Description	Date Issued
RF160815E05D	Original release.	Mar. 08, 2019

1 Certificate of Conformity

Product: Nokia FW2R LTE module

Brand: Nokia

Test Model: FW2RADPM01

Sample Status: MASS-PRODUCTION

Applicant: Nokia Solutions and Networks, OY

Test Date: Oct. 03 to 26, 2018

Standard: 47 CFR FCC Part 15, Subpart E (Section 15.407)
ANSI C63.10: 2013

The above equipment has been tested by **Bureau Veritas Consumer Products Services (H.K.) Ltd., Taoyuan Branch**, and found compliance with the requirement of the above standards. The test record, data evaluation & Equipment Under Test (EUT) configurations represented herein are true and accurate accounts of the measurements of the sample's EMC characteristics under the conditions specified in this report.

Prepared by :  , **Date:** Mar. 08, 2019
Claire Kuan / Specialist

Approved by :  , **Date:** Mar. 08, 2019
May Chen / Manager

2 Summary of Test Results

47 CFR FCC Part 15, Subpart E (Section 15.407)			
FCC Clause	Test Item	Result	Remarks
15.407(b)(6)	AC Power Conducted Emissions	PASS	Meet the requirement of limit. Minimum passing margin is -24.86dB at 29.80469MHz.
15.407(b) (1/2/3/4(i/ii)/6)	Radiated Emissions & Band Edge Measurement*	PASS	Meet the requirement of limit. Minimum passing margin is -0.5dB at 5350.00MHz.
15.407(a)(1/2/3)	Max Average Transmit Power	PASS	Meet the requirement of limit.
---	Occupied Bandwidth Measurement	-	Reference only.
15.407(a)(1/2/3)	Peak Power Spectral Density	PASS	Meet the requirement of limit.
15.407(e)	6dB bandwidth	PASS	Meet the requirement of limit. (U-NII-3 Band only)
15.407(g)	Frequency Stability	PASS	Meet the requirement of limit.
15.203	Antenna Requirement	PASS	Antenna connector is Right angle MMCX Plug not a standard connector.

*For ch144 U-NII-3 band compliance with rule part 15.407(b)(4)(i), the OOB test plots were recorded in Annex A.

2.1 Measurement Uncertainty

Where relevant, the following measurement uncertainty levels have been estimated for tests performed on the EUT as specified in CISPR 16-4-2:

Measurement	Frequency	Expanded Uncertainty (k=2) (±)
Conducted Emissions at mains ports	150kHz ~ 30MHz	1.84 dB
Radiated Emissions up to 1 GHz	30MHz ~ 1GHz	5.33 dB
Radiated Emissions above 1 GHz	1GHz ~ 6GHz	5.10 dB
	6GHz ~ 18GHz	4.85 dB
	18GHz ~ 40GHz	5.24 dB

2.2 Modification Record

There were no modifications required for compliance.

3 General Information

3.1 General Description of EUT

Product	Nokia FW2R LTE module
Brand	Nokia
Test Model	FW2RADPM01
Test Sample S/N	EB171810287
Hardware Version	95.1659T00 X36
Status of EUT	MASS-PRODUCTION
Power Supply Rating	12Vdc from power adapter
Modulation Technology	OFDM
Modulation Type	QPSK, 16QAM, 64QAM, 256QAM
Operating Frequency	5.25 ~ 5.35GHz and 5.47 ~ 5.725GHz
Number of Channel	LAA-single carrier: 18 LAA-2 carriers (CA_46C): 16 LAA-2 carriers (CA_46A-46A): 14
Output Power	LAA-single carrier: 5.25 ~ 5.35GHz: 235.251 mW 5.47 ~ 5.725GHz: 191.255 mW LAA-2 carriers (CA_46C): 5.25 ~ 5.35GHz: 239.628 mW 5.47 ~ 5.725GHz: 217.833 mW LAA-2 carriers (CA_46A-46A): 5.25 ~ 5.35GHz: 240.189 mW 5.47 ~ 5.725GHz: 218.794 mW
Antenna Type	Refer to Note
Antenna Connector	Refer to Note
Accessory Device	Adapter x1
Data Cable Supplied	NA

Note:

1. This report is prepared for FCC Class II permissive change. The difference compared with the Report No.: RF160815E05B design is as the following information:
 - ◆ Added the DFS Band (5.25 ~ 5.35GHz and 5.47 ~ 5.725GHz).
2. According to above conditions, all test items need to be performed. And all data were verified to meet the requirements.

3. The antennas provided to the EUT, please refer to the following table:

Antenna spec.					
Antenna No	Brand	Model	Antenna Type	Gain(dBi)	Frequency range (MHz)
1	Nokia	NA	Loop (LAA#4(Main))	7.67	5250~ 5750
2	Nokia	NA	Loop (LAA#2(DIV))	3.66	5250~ 5750

Cable Spec.						
Antenna No	Brand	Model	Connector Type	Cable Loss(dB)	Cable Length (mm)	Note
1	NA	NA	Right angle MMCX Plug	peak gain included	263	This cable will be equipped with Loop(LAA#4) antenna
2	NA	NA	Right angle MMCX Plug	peak gain included	263	This cable will be equipped with Loop(LAA#2) antenna

4. Directional gain(composite gain) :

Frequency range (MHz)	Directional Gain(dBi)
5250 ~ 5750	6.11

Note:

- Directional gain calculation is based on FCC document KDB662911

all transmit signals are *completely uncorrelated*

$$\text{Directional gain} = 10 \log[(10^{G1/10} + 10^{G2/10} + \dots + 10^{GN/10})/N_{ANT}] \text{ dBi,}$$

where

N_{ANT} = the total number of antennas

- Two directional gain values are calculated, directional gain values based on actual measurement data.

3. The EUT power needs to be supplied from one power adapter, the information is as below table:

Brand	Model	Spec.
DVE	DSA-60PFE-12 1 120500	Input: 100-240Vac, 50/60Hz, 2A Output: 12Vdc, 5A DC output cable (Shielded, 1.8m with one core)

- The device (LAA) support 2x2MIMO, MIMO (uncorrelated signal) operation is considered while two LTE carriers are active (Chain 0 and Chain1) in the same band and same channel.
- The host under test is called FW2XXXX host. The whole unit in the market is named "Flexi Zone Multiband Indoor Pico BTS", FW2XXXX as model name, for different LTE/WiFi function.
- The above EUT information is declared by manufacturer and for more detailed features description, please refer to the manufacturer's specifications or user's manual.

3.2 Description of Test Modes

LAA-single carrier

FOR 5250 ~ 5350MHz:

5 channels are provided for EUT.

U-NII Channel Number	3GPP Channel Number	Frequency	U-NII Channel Number	3GPP Channel Number	Frequency
52	47889	5259.9	64	48489	5319.9
56	48090	5280	68	48690	5340
60	48288	5299.8			

FOR 5470 ~ 5725MHz:

13 channels are provided for for EUT.

U-NII Channel Number	3GPP Channel Number	Frequency	U-NII Channel Number	3GPP Channel Number	Frequency
96	50090	5480	124	51491	5620.1
100	50291	5500.1	128	51689	5639.9
104	50489	5519.9	132	51890	5660
108	50690	5540	136	52091	5680.1
112	50891	5560.1	140	52289	5699.9
116	51089	5579.9	144	52490	5720
120	51290	5600			

LAA-2 carriers (CA_46C)

FOR 5250 ~ 5350MHz:

4 channels are provided for EUT.

U-NII Channel Number	3GPP Channel Number	Frequency	U-NII Channel Number	3GPP Channel Number	Frequency
52+56	47889+48090	5259.9+5280	56+60	48090+48288	5280+5299.8
60+64	48288+48489	5299.8+5319.9	64+68	48489+48690	5319.9+5340

FOR 5470 ~ 5725MHz:

12 channels are provided for for EUT.

U-NII Channel Number	3GPP Channel Number	Frequency	U-NII Channel Number	3GPP Channel Number	Frequency
100+104	50291+50489	5500.1+5519.9	96+100	50090+50291	5480+5500.1
108+112	50690+50891	5540+5560.1	104+108	50489+50690	5519.9+5540
116+120	51290+51491	5579.9+5600	112+116	50891+51089	5560.1+5579.9
124+128	51689+51890	5620.1+5639.9	120+124	51290+51491	5600+5620.1
132+136	51890+52091	5660+5680.1	128+132	51689+51890	5639.9+5660
140+144	52289+52490	5699.9+5720	136+140	52091+52289	5680.1+5699.9

LAA-2 carriers (CA_46A-46A)

3 channels are provided for EUT.

U-NII Channel Number	3GPP Channel Number	Frequency	U-NII Channel Number	3GPP Channel Number	Frequency
52+60	47889+48288	5259.9+5299.8	60+68	48288+48690	5299.8+5340
56+64	48090+48489	5280+5319.9			

FOR 5470 ~ 5725MHz:

11 channels are provided for for EUT.

U-NII Channel Number	3GPP Channel Number	Frequency	U-NII Channel Number	3GPP Channel Number	Frequency
96+104	50090+50489	5480+5519.9	124+132	51491+51890	5620.1+5660
108+116	50690+51089	5540+5579.9	136+144	52091+52490	5680.1+5720
120+128	51290+51689	5600+5639.9	104+112	50489+50891	5519.9+5560.1
132+140	51890+52289	5660+5699.9	116+124	51089+51491	5579.9+5620.1
100+108	50291+50690	5500.1+5540	128+136	51689+52091	5639.9+5680.1
112+120	50891+51290	5560.1+5600			

Note: For single carrier operation, one 20MHz 3GPP channels are used.

For 2 carriers (CA_46C or CA_46A-46A) operation, two 20MHz 3GPP channels are used to generate the 40MHz.

3.2.1 Test Mode Applicability and Tested Channel Detail

EUT Configure Mode	Applicable To				Description
	RE≥1G	RE<1G	PLC	APCM	
-	√	√	√	√	-

Where **RE≥1G**: Radiated Emission above 1GHz **RE<1G**: Radiated Emission below 1GHz

PLC: Power Line Conducted Emission **APCM**: Antenna Port Conducted Measurement

NOTE: Internal original test report, the EUT had been pre-tested on the positioned of each 3 axis. The worst case was found when positioned on **Z-plane(below 1GHz) & X-plane(above 1GHz)**

Radiated Emission Test (Above 1GHz):

- Pre-Scan has been conducted to determine the worst-case mode from all possible combinations between available modulations, data rates and antenna ports (if EUT with antenna diversity architecture).
- Following channel(s) was (were) selected for the final test as listed below.

Mode	FREQ. Band (MHz)	Available Channel	U-NII Tested Channel	Modulation Technology
LAA-single carrier	5250-5350	52 to 68	52, 60, 68	OFDM
LAA-2 carriers (CA_46C)			52+56 60+64 64+68	OFDM
LAA-2 carriers (CA_46A-46A)			52+60 56+64 60+68	OFDM
LAA-single carrier	5470-5725	96 to 5720	96, 116, 140, 144	OFDM
LAA-2 carriers (CA_46C)			96+100 108+112 132+136 140+144	OFDM
LAA-2 carriers (CA_46A-46A)			96+104 108+116 132+140 136+144	OFDM

Radiated Emission Test (Below 1GHz):

- Pre-Scan has been conducted to determine the worst-case mode from all possible combinations between available modulations, data rates and antenna ports (if EUT with antenna diversity architecture).
- Following channel(s) was (were) selected for the final test as listed below.

Mode	FREQ. Band (MHz)	Available Channel	U-NII Tested Channel	Modulation Technology
LAA-2 carriers (CA_46A-46A)	5250-5350	52 to 68	60+68	OFDM
	5470-5725	96 to 5720		

Power Line Conducted Emission Test:

- Pre-Scan has been conducted to determine the worst-case mode from all possible combinations between available modulations, data rates and antenna ports (if EUT with antenna diversity architecture).
- Following channel(s) was (were) selected for the final test as listed below.

Mode	FREQ. Band (MHz)	Available Channel	U-NII Tested Channel	Modulation Technology
LAA-single carrier	5250-5350	52 to 68	52	OFDM
	5470-5725	96 to 5720		

Antenna Port Conducted Measurement:

- This item includes all test value of each mode, but only includes spectrum plot of worst value of each mode.
- Pre-Scan has been conducted to determine the worst-case mode from all possible combinations between available modulations, data rates and antenna ports (if EUT with antenna diversity architecture).
- Following channel(s) was (were) selected for the final test as listed below.

Mode	FREQ. Band (MHz)	Available Channel	U-NII Tested Channel	Modulation Technology
LAA-single carrier	5250-5350	52 to 68	52, 60, 68	OFDM
LAA-2 carriers (CA_46C)			52+56 60+64 64+68	OFDM
LAA-2 carriers (CA_46A-46A)			52+60 56+64 60+68	OFDM
LAA-single carrier	5470-5725	96 to 5720	96, 116, 140, 144	OFDM
LAA-2 carriers (CA_46C)			96+100 108+112 132+136 140+144	OFDM
LAA-2 carriers (CA_46A-46A)			96+104 108+116 132+140 136+144	OFDM

Test Condition:

Applicable To	Environmental Conditions	Input Power	Tested By
RE \geq 1G	20deg. C, 64%RH	120Vac, 60Hz	Robert Cheng
RE<1G	25deg. C, 72%RH	120Vac, 60Hz	Steven Chiang
PLC	24deg. C, 76%RH	120Vac, 60Hz	Andy Ho
APCM	25deg. C, 60%RH	120Vac, 60Hz	Robert Cheng

3.3 Duty Cycle of Test Signal

Duty cycle of test signal is 100 %, duty factor is not required.

LAA-single carrier

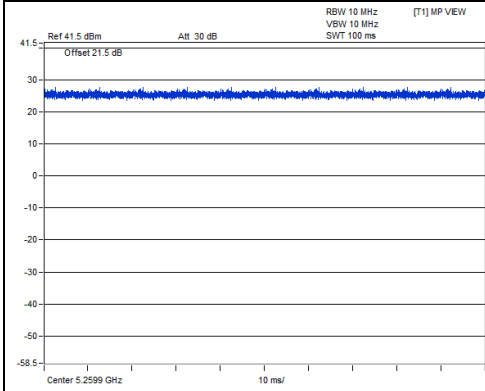

LAA-2 carriers (CA_46C)

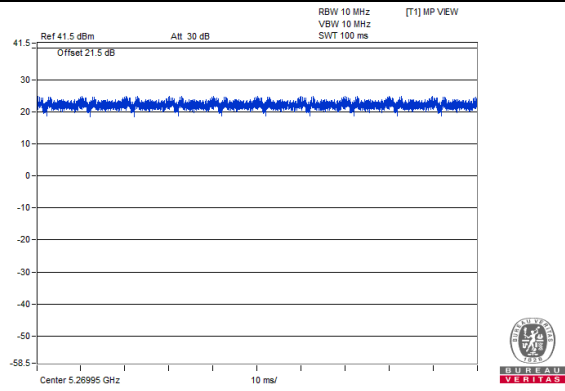

LAA-2 carriers (CA_46A-46A)

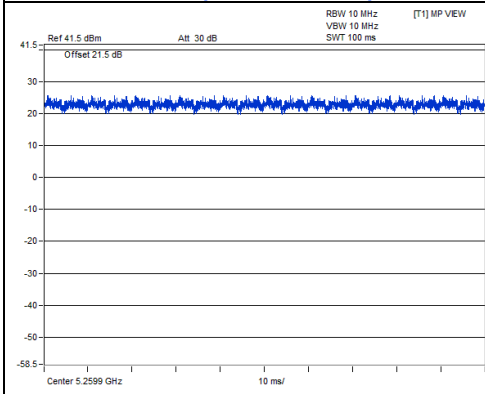

3.4 Description of Support Units

The EUT has been tested as an independent unit together with other necessary accessories or support units. The following support units or accessories were used to form a representative test configuration during the tests.

ID	Product	Brand	Model No.	Serial No.	FCC ID	Remarks
A.	Flexi Zone Multiband Indoor Pico BTS	Nokia	FW2XXXX	NA	NA	Supplied by client
B.	Adapter	DVE	DSA-60PFE-12 1 120500	NA	NA	Supplied by client

Note:

1. All power cords of the above support units are non-shielded (1.8m).

ID	Descriptions	Qty.	Length (m)	Shielding (Yes/No)	Cores (Qty.)	Remarks
1.	AC Cable	1	1.1	No	1	Supplied by client
2.	DC Cable	1	3.1	Yes	0	Provided by Lab

3.4.1 Configuration of System under Test

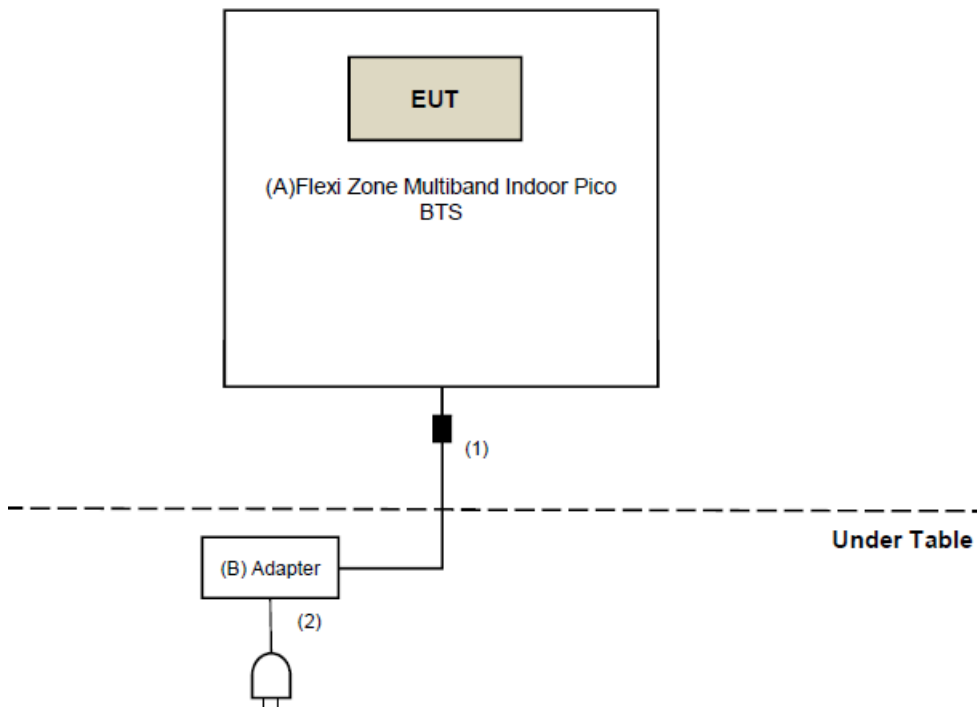

3.5 General Description of Applied Standard

The EUT is a RF Product. According to the specifications of the manufacturer, it must comply with the requirements of the following standards:

FCC Part 15, Subpart E (15.407)

KDB 789033 D02 General UNII Test Procedure New Rules v02r01

KDB 662911 D01 Multiple Transmitter Output v02r01

ANSI C63.10-2013

All test items have been performed and recorded as per the above standards.

4 Test Types and Results

4.1 Radiated Emission and Bandedge Measurement

4.1.1 Limits of Radiated Emission and Bandedge Measurement

Radiated emissions which fall in the restricted bands must comply with the radiated emission limits specified as below table.

Frequencies (MHz)	Field Strength (microvolts/meter)	Measurement Distance (meters)
0.009 ~ 0.490	2400/F(kHz)	300
0.490 ~ 1.705	24000/F(kHz)	30
1.705 ~ 30.0	30	30
30 ~ 88	100	3
88 ~ 216	150	3
216 ~ 960	200	3
Above 960	500	3

NOTE:

- The lower limit shall apply at the transition frequencies.
- Emission level (dBuV/m) = 20 log Emission level (uV/m).
- For frequencies above 1000MHz, the field strength limits are based on average detector, however, the peak field strength of any emission shall not exceed the maximum permitted average limits, specified above by more than 20dB under any condition of modulation.

Limits of unwanted emission out of the restricted bands

Applicable To		Limit	
789033 D02 General UNII Test Procedure New Rules v02r01		Field Strength at 3m	
		PK:74 (dBuV/m)	AV:54 (dBuV/m)
Frequency Band	Applicable To	EIRP Limit	Equivalent Field Strength at 3m
5150~5250 MHz	15.407(b)(1)	PK:-27 (dBm/MHz)	PK:68.2(dBuV/m)
5250~5350 MHz	15.407(b)(2)		
5470~5725 MHz	15.407(b)(3)		
5725~5850 MHz	<input checked="" type="checkbox"/> 15.407(b)(4)(i)	PK:-27 (dBm/MHz) ^{*1} PK:10 (dBm/MHz) ^{*2} PK:15.6 (dBm/MHz) ^{*3} PK:27 (dBm/MHz) ^{*4}	PK: 68.2(dBuV/m) ^{*1} PK:105.2 (dBuV/m) ^{*2} PK: 110.8(dBuV/m) ^{*3} PK:122.2 (dBuV/m) ^{*4}
	<input type="checkbox"/> 15.407(b)(4)(ii)	Emission limits in section 15.247(d)	
^{*1} beyond 75 MHz or more above of the band edge.		^{*2} below the band edge increasing linearly to 10 dBm/MHz at 25 MHz above.	
^{*3} below the band edge increasing linearly to a level of 15.6 dBm/MHz at 5 MHz above.		^{*4} from 5 MHz above or below the band edge increasing linearly to a level of 27 dBm/MHz at the band edge.	

Note:

The following formula is used to convert the equipment isotropic radiated power (eirp) to field strength:

$$E = \frac{1000000\sqrt{30P}}{3} \mu\text{V/m, where P is the eirp (Watts).}$$

4.1.2 Test Instruments

DESCRIPTION & MANUFACTURER	MODEL NO.	SERIAL NO.	CALIBRATED DATE	CALIBRATED UNTIL
Test Receiver Keysight	N9038A	MY54450088	July 05, 2018	July 04, 2019
Pre-Amplifier EMCI	EMC001340	980142	Feb. 09, 2018	Feb. 08, 2019
Loop Antenna ^(*) Electro-Metrics	EM-6879	264	Dec. 16, 2016	Dec. 15, 2018
RF Cable	NA	LOOPCAB-001	Jan. 15, 2018	Jan. 14, 2019
RF Cable	NA	LOOPCAB-002	Jan. 15, 2018	Jan. 14, 2019
Pre-Amplifier Mini-Circuits	ZFL-1000VH2B	AMP-ZFL-01	Nov. 09, 2017	Nov. 08, 2018
Trilog Broadband Antenna SCHWARZBECK	VULB 9168	9168-406	Nov. 29, 2017	Nov. 28, 2018
RF Cable	8D	966-4-1	Mar. 21, 2018	Mar. 20, 2019
RF Cable	8D	966-4-2	Mar. 21, 2018	Mar. 20, 2019
RF Cable	8D	966-4-3	Mar. 21, 2018	Mar. 20, 2019
Fixed attenuator Mini-Circuits	UNAT-5+	PAD-3m-4-01	Sep. 27, 2018	Sep. 26, 2019
Horn_Antenna SCHWARZBECK	BBHA 9120D	9120D-783	Dec. 12, 2017	Dec. 11, 2018
Pre-Amplifier Mini-Circuits	ZVA-183-S+	AMP-ZVA-03	May 10, 2018	May 09, 2019
RF Cable	EMC104-SM-SM-1200	160923	Jan. 29, 2018	Jan. 28, 2019
RF Cable	EMC104-SM-SM-2000	150318	Jan. 29, 2018	Jan. 28, 2019
RF Cable	EMC104-SM-SM-5000	150321	Jan. 29, 2018	Jan. 28, 2019
Pre-Amplifier EMCI	EMC184045SE	980387	Jan. 29, 2018	Jan. 28, 2019
Horn_Antenna SCHWARZBECK	BBHA 9170	BBHA9170608	Dec. 14, 2017	Dec. 13, 2018
RF Cable	EMC102-KM-KM-1200	160925	Jan. 29, 2018	Jan. 28, 2019
Software	ADT_Radiated_V8.7.08	NA	NA	NA
Boresight Antenna Tower & Turn Table Max-Full	MF-7802BS	MF780208530	NA	NA
Spectrum Analyzer R&S	FSV40	100964	June 20, 2018	June 19, 2019
Power meter Anritsu	ML2495A	1014008	May 09, 2018	May 08, 2019
Power sensor Anritsu	MA2411B	0917122	May 09, 2018	May 08, 2019
AC Power Source Extech Electronics	6205	1440452	NA	NA
DC Power Supply Topward	6603D	795558	NA	NA
Temperature & Humidity Chamber Giant Force	GTH-150-40-SP-AR	MAA0812-008	Jan. 10, 2018	Jan. 09, 2019
True RMS Clamp Meter FLUKE	325	31130711WS	May 22, 2018	May 21, 2019

Note:

1. The calibration interval of the above test instruments is 12 months and the calibrations are traceable to NML/ROC and NIST/USA.
2. *The calibration interval of the above test instruments is 24 months and the calibrations are traceable to NML/ROC and NIST/USA.
3. The test was performed in 966 Chamber No. 4.
4. The CANADA Site Registration No. is 20331-2
5. Loop antenna was used for all emissions below 30 MHz.
6. Tested Date: Oct. 03 to 26, 2018

4.1.3 Test Procedure

For Radiated emission below 30MHz

- a. The EUT was placed on the top of a rotating table 0.8 meters above the ground at a 3 meter chamber room. The table was rotated 360 degrees to determine the position of the highest radiation.
- b. The EUT was set 3 meters away from the interference-receiving antenna, which was mounted on the top of a variable-height antenna tower.
- c. Parallel, perpendicular, and ground-parallel orientations of the antenna are set to make the measurement.
- d. For each suspected emission, the EUT was arranged to its worst case and the rotatable table was turned from 0 degrees to 360 degrees to find the maximum reading.
- e. The test-receiver system was set to Quasi-Peak Detect Function and Specified Bandwidth with Maximum Hold Mode.

NOTE:

1. The resolution bandwidth and video bandwidth of test receiver/spectrum analyzer is 9kHz at frequency below 30MHz.

For Radiated emission above 30MHz

- a. The EUT was placed on the top of a rotating table 0.8 meters (for 30MHz ~ 1GHz) / 1.5 meters (for above 1GHz) above the ground at 3 meter chamber room for test. The table was rotated 360 degrees to determine the position of the highest radiation.
- b. The EUT was set 3 meters away from the interference-receiving antenna, which was mounted on the top of a variable-height antenna tower.
- c. The height of antenna is varied from one meter to four meters above the ground to determine the maximum value of the field strength. Both horizontal and vertical polarizations of the antenna are set to make the measurement.
- d. For each suspected emission, the EUT was arranged to its worst case and then the antenna was tuned to heights from 1 meter to 4 meters and the rotatable table was turned from 0 degrees to 360 degrees to find the maximum reading.
- e. The test-receiver system was set to quasi-peak detect function and specified bandwidth with maximum hold mode when the test frequency is below 1 GHz.
- f. The test-receiver system was set to peak and average detects function and specified bandwidth with maximum hold mode when the test frequency is above 1 GHz. If the peak reading value also meets average limit, measurement with the average detector is unnecessary.

Note:

1. The resolution bandwidth and video bandwidth of test receiver/spectrum analyzer is 120kHz for Quasi-peak detection (QP) at frequency below 1GHz.
2. The resolution bandwidth of test receiver/spectrum analyzer is 1 MHz and the video bandwidth is 3 MHz for Peak detection (PK) at frequency above 1GHz.
3. The resolution bandwidth of test receiver/spectrum analyzer is 1MHz and the video bandwidth is $\geq 1/T$ (Duty cycle $< 98\%$) or 10Hz (Duty cycle $\geq 98\%$) for Average detection (AV) at frequency above 1GHz.
4. All modes of operation were investigated and the worst-case emissions are reported.

4.1.4 Deviation from Test Standard

No deviation.

4.1.5 Test Setup

For Radiated emission below 30MHz

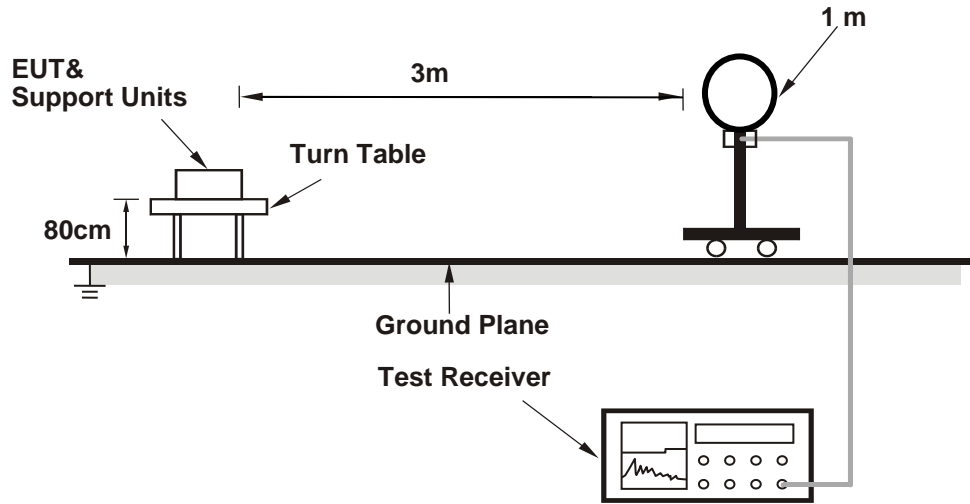

For Radiated emission 30MHz to 1GHz

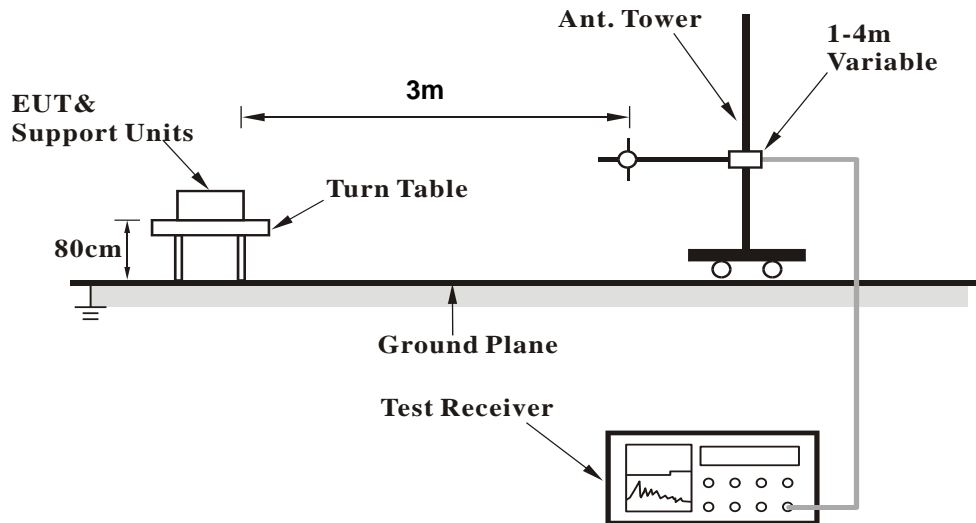

For Radiated emission above 1GHz

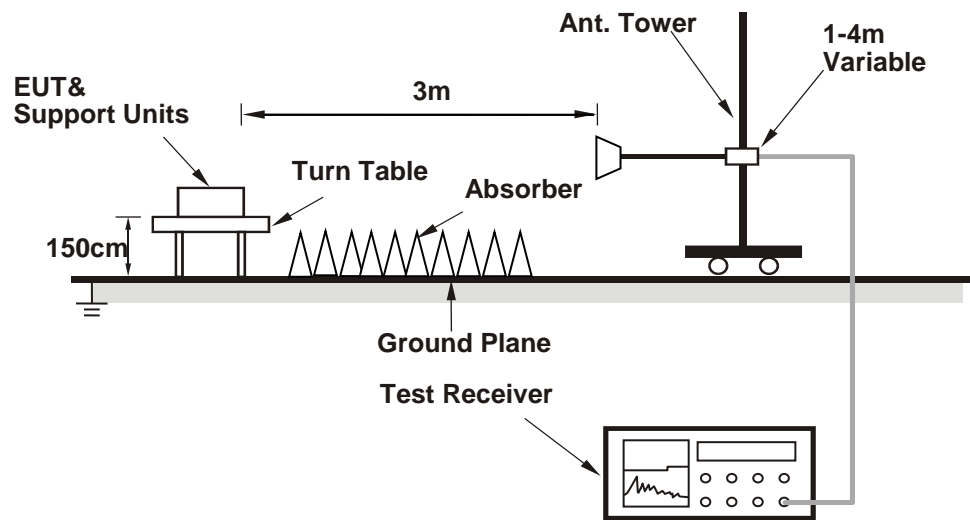

For the actual test configuration, please refer to the attached file (Test Setup Photo).

4.1.6 EUT Operating Condition

- a. Placed the EUT on the testing table.
- a. Controlling software (python-2.7.2.msi) has been activated to set the EUT on specific status.

4.1.7 Test Results

Above 1GHz Data:

LAA-single carrier

CHANNEL	TX Channel 52	DETECTOR FUNCTION	Peak (PK)
FREQUENCY RANGE	1GHz ~ 40GHz		Average (AV)

ANTENNA POLARITY & TEST DISTANCE: HORIZONTAL AT 3 M								
NO.	FREQ. (MHz)	EMISSION LEVEL (dBuV/m)	LIMIT (dBuV/m)	MARGIN (dB)	ANTENNA HEIGHT (m)	TABLE ANGLE (Degree)	RAW VALUE (dBuV)	CORRECTION FACTOR (dB/m)
1	5150.00	55.9 PK	74.0	-18.1	2.37 H	156	52.9	3.0
2	5150.00	44.8 AV	54.0	-9.2	2.37 H	156	41.8	3.0
3	*5259.90	116.3 PK			2.37 H	156	113.9	2.4
4	*5259.90	103.3 AV			2.37 H	156	100.9	2.4
5	#10519.80	51.5 PK	68.2	-16.7	2.04 H	165	38.6	12.9
6	15779.70	58.6 PK	74.0	-15.4	2.41 H	302	46.1	12.5
7	15779.70	43.7 AV	54.0	-10.3	2.41 H	302	31.2	12.5
ANTENNA POLARITY & TEST DISTANCE: VERTICAL AT 3 M								
NO.	FREQ. (MHz)	EMISSION LEVEL (dBuV/m)	LIMIT (dBuV/m)	MARGIN (dB)	ANTENNA HEIGHT (m)	TABLE ANGLE (Degree)	RAW VALUE (dBuV)	CORRECTION FACTOR (dB/m)
1	5150.00	56.5 PK	74.0	-17.5	1.88 V	331	53.5	3.0
2	5150.00	45.3 AV	54.0	-8.7	1.88 V	331	42.3	3.0
3	*5259.90	118.3 PK			1.88 V	331	115.9	2.4
4	*5259.90	105.2 AV			1.88 V	331	102.8	2.4
5	#10519.80	53.3 PK	68.2	-14.9	1.61 V	159	40.4	12.9
6	15779.70	58.8 PK	74.0	-15.2	1.65 V	248	46.3	12.5
7	15779.70	43.8 AV	54.0	-10.2	1.65 V	248	31.3	12.5

REMARKS:

1. Emission Level(dBuV/m) = Raw Value(dBuV) + Correction Factor(dB/m)
2. Correction Factor(dB/m) = Antenna Factor(dB/m) + Cable Factor(dB) – Pre-Amplifier Factor(dB)
3. The other emission levels were very low against the limit.
4. Margin value = Emission Level – Limit value
5. " * ": Fundamental frequency.
6. " # ": The radiated frequency is out of the restricted band.

CHANNEL	TX Channel 60	DETECTOR FUNCTION	Peak (PK)
FREQUENCY RANGE	1GHz ~ 40GHz		Average (AV)

ANTENNA POLARITY & TEST DISTANCE: HORIZONTAL AT 3 M

NO.	FREQ. (MHz)	EMISSION LEVEL (dBuV/m)	LIMIT (dBuV/m)	MARGIN (dB)	ANTENNA HEIGHT (m)	TABLE ANGLE (Degree)	RAW VALUE (dBuV)	CORRECTION FACTOR (dB/m)
1	*5299.80	116.1 PK			2.33 H	145	113.7	2.4
2	*5299.80	103.0 AV			2.33 H	145	100.6	2.4
3	#10599.60	51.3 PK	68.2	-16.9	2.07 H	154	38.9	12.4
4	15899.40	59.2 PK	74.0	-14.8	2.37 H	314	46.9	12.3
5	15899.40	44.2 AV	54.0	-9.8	2.37 H	314	31.9	12.3

ANTENNA POLARITY & TEST DISTANCE: VERTICAL AT 3 M

NO.	FREQ. (MHz)	EMISSION LEVEL (dBuV/m)	LIMIT (dBuV/m)	MARGIN (dB)	ANTENNA HEIGHT (m)	TABLE ANGLE (Degree)	RAW VALUE (dBuV)	CORRECTION FACTOR (dB/m)
1	*5299.80	117.7 PK			1.82 V	337	115.3	2.4
2	*5299.80	104.7 AV			1.82 V	337	102.3	2.4
3	#10599.60	53.2 PK	68.2	-15.0	1.65 V	167	40.8	12.4
4	15899.40	58.7 PK	74.0	-15.3	1.61 V	240	46.4	12.3
5	15899.40	44.0 AV	54.0	-10.0	1.61 V	240	31.7	12.3

REMARKS:

1. Emission Level(dBuV/m) = Raw Value(dBuV) + Correction Factor(dB/m)
2. Correction Factor(dB/m) = Antenna Factor(dB/m) + Cable Factor(dB) – Pre-Amplifier Factor(dB)
3. The other emission levels were very low against the limit.
4. Margin value = Emission Level – Limit value
5. " * ": Fundamental frequency.
6. " # ": The radiated frequency is out of the restricted band.

CHANNEL	TX Channel 68	DETECTOR FUNCTION	Peak (PK)
FREQUENCY RANGE	1GHz ~ 40GHz		Average (AV)

ANTENNA POLARITY & TEST DISTANCE: HORIZONTAL AT 3 M

NO.	FREQ. (MHz)	EMISSION LEVEL (dBuV/m)	LIMIT (dBuV/m)	MARGIN (dB)	ANTENNA HEIGHT (m)	TABLE ANGLE (Degree)	RAW VALUE (dBuV)	CORRECTION FACTOR (dB/m)
1	*5340.00	115.2 PK			2.42 H	141	112.6	2.6
2	*5340.00	102.6 AV			2.42 H	141	100.0	2.6
3	5350.00	61.5 PK	74.0	-12.5	2.42 H	141	58.9	2.6
4	5350.00	50.7 AV	54.0	-3.3	2.42 H	141	48.1	2.6
5	10680.00	51.7 PK	74.0	-22.3	2.02 H	176	38.9	12.8
6	10680.00	40.9 AV	54.0	-13.1	2.02 H	176	28.1	12.8
7	16020.00	57.9 PK	74.0	-16.1	2.36 H	296	45.1	12.8
8	16020.00	43.3 AV	54.0	-10.7	2.36 H	296	30.5	12.8

ANTENNA POLARITY & TEST DISTANCE: VERTICAL AT 3 M

NO.	FREQ. (MHz)	EMISSION LEVEL (dBuV/m)	LIMIT (dBuV/m)	MARGIN (dB)	ANTENNA HEIGHT (m)	TABLE ANGLE (Degree)	RAW VALUE (dBuV)	CORRECTION FACTOR (dB/m)
1	*5340.00	117.2 PK			2.18 V	163	114.6	2.6
2	*5340.00	104.1 AV			2.18 V	163	101.5	2.6
3	5350.00	64.8 PK	74.0	-9.2	2.18 V	163	62.2	2.6
4	5350.00	53.5 AV	54.0	-0.5	2.18 V	163	50.9	2.6
5	10680.00	53.5 PK	74.0	-20.5	1.64 V	170	40.7	12.8
6	10680.00	42.5 AV	54.0	-11.5	1.64 V	170	29.7	12.8
7	16020.00	58.6 PK	74.0	-15.4	1.66 V	252	45.8	12.8
8	16020.00	43.7 AV	54.0	-10.3	1.66 V	252	30.9	12.8

REMARKS:

1. Emission Level(dBuV/m) = Raw Value(dBuV) + Correction Factor(dB/m)
2. Correction Factor(dB/m) = Antenna Factor(dB/m) + Cable Factor(dB) – Pre-Amplifier Factor(dB)
3. The other emission levels were very low against the limit.
4. Margin value = Emission Level – Limit value
5. " * ": Fundamental frequency.

CHANNEL	TX Channel 96	DETECTOR FUNCTION	Peak (PK)
FREQUENCY RANGE	1GHz ~ 40GHz		Average (AV)

ANTENNA POLARITY & TEST DISTANCE: HORIZONTAL AT 3 M

NO.	FREQ. (MHz)	EMISSION LEVEL (dBuV/m)	LIMIT (dBuV/m)	MARGIN (dB)	ANTENNA HEIGHT (m)	TABLE ANGLE (Degree)	RAW VALUE (dBuV)	CORRECTION FACTOR (dB/m)
1	5460.00	57.3 PK	74.0	-16.7	2.41 H	171	54.4	2.9
2	5460.00	47.2 AV	54.0	-6.8	2.41 H	171	44.3	2.9
3	#5470.00	62.9 PK	68.2	-5.3	2.41 H	171	60.0	2.9
4	*5480.00	114.9 PK			2.41 H	171	112.0	2.9
5	*5480.00	102.6 AV			2.41 H	171	99.7	2.9
6	10960.00	51.6 PK	74.0	-22.4	2.10 H	159	38.4	13.2
7	10960.00	40.7 AV	54.0	-13.3	2.10 H	159	27.5	13.2
8	#16440.00	58.8 PK	68.2	-9.4	2.43 H	298	44.0	14.8

ANTENNA POLARITY & TEST DISTANCE: VERTICAL AT 3 M

NO.	FREQ. (MHz)	EMISSION LEVEL (dBuV/m)	LIMIT (dBuV/m)	MARGIN (dB)	ANTENNA HEIGHT (m)	TABLE ANGLE (Degree)	RAW VALUE (dBuV)	CORRECTION FACTOR (dB/m)
1	5460.00	60.2 PK	74.0	-13.8	2.44 V	208	57.3	2.9
2	5460.00	49.8 AV	54.0	-4.2	2.44 V	208	46.9	2.9
3	#5470.00	65.9 PK	68.2	-2.3	2.44 V	208	63.0	2.9
4	*5480.00	117.4 PK			2.44 V	208	114.5	2.9
5	*5480.00	105.1 AV			2.44 V	208	102.2	2.9
6	10960.00	53.5 PK	74.0	-20.5	1.63 V	156	40.3	13.2
7	10960.00	42.4 AV	54.0	-11.6	1.63 V	156	29.2	13.2
8	#16440.00	59.0 PK	68.2	-9.2	1.63 V	252	44.2	14.8

REMARKS:

1. Emission Level(dBuV/m) = Raw Value(dBuV) + Correction Factor(dB/m)
2. Correction Factor(dB/m) = Antenna Factor(dB/m) + Cable Factor(dB) – Pre-Amplifier Factor(dB)
3. The other emission levels were very low against the limit.
4. Margin value = Emission Level – Limit value
5. " * ": Fundamental frequency.
6. " # ": The radiated frequency is out of the restricted band.

CHANNEL	TX Channel 116	DETECTOR FUNCTION	Peak (PK)
FREQUENCY RANGE	1GHz ~ 40GHz		Average (AV)

ANTENNA POLARITY & TEST DISTANCE: HORIZONTAL AT 3 M

NO.	FREQ. (MHz)	EMISSION LEVEL (dBuV/m)	LIMIT (dBuV/m)	MARGIN (dB)	ANTENNA HEIGHT (m)	TABLE ANGLE (Degree)	RAW VALUE (dBuV)	CORRECTION FACTOR (dB/m)
1	*5579.50	115.3 PK			2.32 H	170	112.1	3.2
2	*5579.50	102.8 AV			2.32 H	170	99.6	3.2
3	11159.00	51.1 PK	74.0	-22.9	2.01 H	155	38.0	13.1
4	11159.00	40.4 AV	54.0	-13.6	2.01 H	155	27.3	13.1
5	#16738.50	58.4 PK	68.2	-9.8	2.47 H	299	42.0	16.4

ANTENNA POLARITY & TEST DISTANCE: VERTICAL AT 3 M

NO.	FREQ. (MHz)	EMISSION LEVEL (dBuV/m)	LIMIT (dBuV/m)	MARGIN (dB)	ANTENNA HEIGHT (m)	TABLE ANGLE (Degree)	RAW VALUE (dBuV)	CORRECTION FACTOR (dB/m)
1	*5579.50	118.1 PK			1.84 V	332	114.9	3.2
2	*5579.50	105.5 AV			1.84 V	332	102.3	3.2
3	11159.00	52.9 PK	74.0	-21.1	1.58 V	154	39.8	13.1
4	11159.00	42.1 AV	54.0	-11.9	1.58 V	154	29.0	13.1
5	#16738.50	59.2 PK	68.2	-9.0	1.62 V	246	42.8	16.4

REMARKS:

1. Emission Level(dBuV/m) = Raw Value(dBuV) + Correction Factor(dB/m)
2. Correction Factor(dB/m) = Antenna Factor(dB/m) + Cable Factor(dB) – Pre-Amplifier Factor(dB)
3. The other emission levels were very low against the limit.
4. Margin value = Emission Level – Limit value
5. " * ": Fundamental frequency.
6. " # ": The radiated frequency is out of the restricted band.

CHANNEL	TX Channel 140	DETECTOR FUNCTION	Peak (PK)
FREQUENCY RANGE	1GHz ~ 40GHz		Average (AV)

ANTENNA POLARITY & TEST DISTANCE: HORIZONTAL AT 3 M

NO.	FREQ. (MHz)	EMISSION LEVEL (dBuV/m)	LIMIT (dBuV/m)	MARGIN (dB)	ANTENNA HEIGHT (m)	TABLE ANGLE (Degree)	RAW VALUE (dBuV)	CORRECTION FACTOR (dB/m)
1	*5699.90	116.4 PK			2.40 H	143	113.0	3.4
2	*5699.90	103.7 AV			2.40 H	143	100.3	3.4
3	#5725.00	57.3 PK	68.2	-10.9	2.40 H	143	54.0	3.3
4	11399.80	51.3 PK	74.0	-22.7	2.02 H	165	37.8	13.5
5	11399.80	40.3 AV	54.0	-13.7	2.02 H	165	26.8	13.5
6	#17099.70	58.8 PK	68.2	-9.4	2.39 H	310	42.7	16.1

ANTENNA POLARITY & TEST DISTANCE: VERTICAL AT 3 M

NO.	FREQ. (MHz)	EMISSION LEVEL (dBuV/m)	LIMIT (dBuV/m)	MARGIN (dB)	ANTENNA HEIGHT (m)	TABLE ANGLE (Degree)	RAW VALUE (dBuV)	CORRECTION FACTOR (dB/m)
1	*5699.90	119.1 PK			2.46 V	174	115.7	3.4
2	*5699.90	106.0 AV			2.46 V	174	102.6	3.4
3	#5725.00	60.2 PK	68.2	-8.0	2.46 V	174	56.9	3.3
4	11399.80	53.5 PK	74.0	-20.5	1.66 V	147	40.0	13.5
5	11399.80	42.4 AV	54.0	-11.6	1.66 V	147	28.9	13.5
6	#17099.70	59.1 PK	68.2	-9.1	1.60 V	244	43.0	16.1

REMARKS:

1. Emission Level(dBuV/m) = Raw Value(dBuV) + Correction Factor(dB/m)
2. Correction Factor(dB/m) = Antenna Factor(dB/m) + Cable Factor(dB) – Pre-Amplifier Factor(dB)
3. The other emission levels were very low against the limit.
4. Margin value = Emission Level – Limit value
5. " * ": Fundamental frequency.
6. " # ": The radiated frequency is out of the restricted band.

CHANNEL	TX Channel 144	DETECTOR FUNCTION	Peak (PK)
FREQUENCY RANGE	1GHz ~ 40GHz		Average (AV)

ANTENNA POLARITY & TEST DISTANCE: HORIZONTAL AT 3 M

NO.	FREQ. (MHz)	EMISSION LEVEL (dBuV/m)	LIMIT (dBuV/m)	MARGIN (dB)	ANTENNA HEIGHT (m)	TABLE ANGLE (Degree)	RAW VALUE (dBuV)	CORRECTION FACTOR (dB/m)
1	*5720.00	115.9 PK			2.35 H	141	112.6	3.3
2	*5720.00	103.1 AV			2.35 H	141	99.8	3.3
3	#5850.00	50.9 PK	68.2	-17.3	2.35 H	141	47.3	3.6
4	11440.00	51.6 PK	74.0	-22.4	1.98 H	158	38.2	13.4
5	11440.00	40.6 AV	54.0	-13.4	1.98 H	158	27.2	13.4
6	#17160.00	59.0 PK	68.2	-9.2	2.35 H	311	42.7	16.3

ANTENNA POLARITY & TEST DISTANCE: VERTICAL AT 3 M

NO.	FREQ. (MHz)	EMISSION LEVEL (dBuV/m)	LIMIT (dBuV/m)	MARGIN (dB)	ANTENNA HEIGHT (m)	TABLE ANGLE (Degree)	RAW VALUE (dBuV)	CORRECTION FACTOR (dB/m)
1	*5720.00	118.6 PK			2.46 V	166	115.3	3.3
2	*5720.00	105.7 AV			2.46 V	166	102.4	3.3
3	#5850.00	53.6 PK	68.2	-14.6	2.46 V	166	50.0	3.6
4	11440.00	52.9 PK	74.0	-21.1	1.55 V	171	39.5	13.4
5	11440.00	42.1 AV	54.0	-11.9	1.55 V	171	28.7	13.4
6	#17160.00	59.2 PK	68.2	-9.0	1.69 V	240	42.9	16.3

REMARKS:

1. Emission Level(dBuV/m) = Raw Value(dBuV) + Correction Factor(dB/m)
2. Correction Factor(dB/m) = Antenna Factor(dB/m) + Cable Factor(dB) – Pre-Amplifier Factor(dB)
3. The other emission levels were very low against the limit.
4. Margin value = Emission Level – Limit value
5. " * ": Fundamental frequency.
6. " # ": The radiated frequency is out of the restricted band.

LAA-2 carriers (CA_46C)

CHANNEL	TX Channel 52+56	DETECTOR FUNCTION	Peak (PK)
FREQUENCY RANGE	1GHz ~ 40GHz		Average (AV)

ANTENNA POLARITY & TEST DISTANCE: HORIZONTAL AT 3 M

NO.	FREQ. (MHz)	EMISSION LEVEL (dBuV/m)	LIMIT (dBuV/m)	MARGIN (dB)	ANTENNA HEIGHT (m)	TABLE ANGLE (Degree)	RAW VALUE (dBuV)	CORRECTION FACTOR (dB/m)
1	5150.00	51.2 PK	74.0	-22.8	2.19 H	134	48.2	3.0
2	5150.00	38.2 AV	54.0	-15.8	2.19 H	134	35.2	3.0
3	*5269.95	113.5 PK			2.19 H	134	111.1	2.4
4	*5269.95	100.5 AV			2.19 H	134	98.1	2.4
5	#10539.90	51.8 PK	68.2	-16.4	2.08 H	171	39.0	12.8
6	15809.85	58.5 PK	74.0	-15.5	2.41 H	302	46.1	12.4
7	15809.85	43.8 AV	54.0	-10.2	2.41 H	302	31.4	12.4

ANTENNA POLARITY & TEST DISTANCE: VERTICAL AT 3 M

NO.	FREQ. (MHz)	EMISSION LEVEL (dBuV/m)	LIMIT (dBuV/m)	MARGIN (dB)	ANTENNA HEIGHT (m)	TABLE ANGLE (Degree)	RAW VALUE (dBuV)	CORRECTION FACTOR (dB/m)
1	5150.00	53.5 PK	74.0	-20.5	2.14 V	175	50.5	3.0
2	5150.00	41.1 AV	54.0	-12.9	2.14 V	175	38.1	3.0
3	*5269.95	115.7 PK			2.14 V	175	113.3	2.4
4	*5269.95	102.8 AV			2.14 V	175	100.4	2.4
5	#10539.90	53.3 PK	68.2	-14.9	1.59 V	167	40.5	12.8
6	15809.85	58.8 PK	74.0	-15.2	1.70 V	236	46.4	12.4
7	15809.85	43.8 AV	54.0	-10.2	1.70 V	236	31.4	12.4

REMARKS:

- Emission Level(dBuV/m) = Raw Value(dBuV) + Correction Factor(dB/m)
- Correction Factor(dB/m) = Antenna Factor(dB/m) + Cable Factor(dB) – Pre-Amplifier Factor(dB)
- The other emission levels were very low against the limit.
- Margin value = Emission Level – Limit value
- " * ": Fundamental frequency.
- " # ": The radiated frequency is out of the restricted band.

CHANNEL	TX Channel 60+64	DETECTOR FUNCTION	Peak (PK)
FREQUENCY RANGE	1GHz ~ 40GHz		Average (AV)

ANTENNA POLARITY & TEST DISTANCE: HORIZONTAL AT 3 M

NO.	FREQ. (MHz)	EMISSION LEVEL (dBuV/m)	LIMIT (dBuV/m)	MARGIN (dB)	ANTENNA HEIGHT (m)	TABLE ANGLE (Degree)	RAW VALUE (dBuV)	CORRECTION FACTOR (dB/m)
1	*5309.85	113.8 PK			2.21 H	151	111.4	2.4
2	*5309.85	101.1 AV			2.21 H	151	98.7	2.4
3	5350.00	55.9 PK	74.0	-18.1	2.21 H	151	53.3	2.6
4	5350.00	45.1 AV	54.0	-8.9	2.21 H	151	42.5	2.6
5	10619.70	51.8 PK	74.0	-22.2	2.04 H	159	39.3	12.5
6	10619.70	41.2 AV	54.0	-12.8	2.04 H	159	28.7	12.5
7	15929.55	58.4 PK	74.0	-15.6	2.40 H	310	46.0	12.4
8	15929.55	43.3 AV	54.0	-10.7	2.40 H	310	30.9	12.4

ANTENNA POLARITY & TEST DISTANCE: VERTICAL AT 3 M

NO.	FREQ. (MHz)	EMISSION LEVEL (dBuV/m)	LIMIT (dBuV/m)	MARGIN (dB)	ANTENNA HEIGHT (m)	TABLE ANGLE (Degree)	RAW VALUE (dBuV)	CORRECTION FACTOR (dB/m)
1	*5309.85	115.6 PK			2.15 V	163	113.2	2.4
2	*5309.85	102.9 AV			2.15 V	163	100.5	2.4
3	5350.00	58.4 PK	74.0	-15.6	2.15 V	163	55.8	2.6
4	5350.00	47.9 AV	54.0	-6.1	2.15 V	163	45.3	2.6
5	10619.70	52.8 PK	74.0	-21.2	1.54 V	166	40.3	12.5
6	10619.70	41.9 AV	54.0	-12.1	1.54 V	166	29.4	12.5
7	15929.55	59.2 PK	74.0	-14.8	1.73 V	246	46.8	12.4
8	15929.55	44.2 AV	54.0	-9.8	1.73 V	246	31.8	12.4

REMARKS:

1. Emission Level(dBuV/m) = Raw Value(dBuV) + Correction Factor(dB/m)
2. Correction Factor(dB/m) = Antenna Factor(dB/m) + Cable Factor(dB) – Pre-Amplifier Factor(dB)
3. The other emission levels were very low against the limit.
4. Margin value = Emission Level – Limit value
5. " * ": Fundamental frequency.

CHANNEL	TX Channel 64+68	DETECTOR FUNCTION	Peak (PK)
FREQUENCY RANGE	1GHz ~ 40GHz		Average (AV)

ANTENNA POLARITY & TEST DISTANCE: HORIZONTAL AT 3 M

NO.	FREQ. (MHz)	EMISSION LEVEL (dBuV/m)	LIMIT (dBuV/m)	MARGIN (dB)	ANTENNA HEIGHT (m)	TABLE ANGLE (Degree)	RAW VALUE (dBuV)	CORRECTION FACTOR (dB/m)
1	*5329.95	113.1 PK			2.20 H	146	110.5	2.6
2	*5329.95	100.9 AV			2.20 H	146	98.3	2.6
3	5350.00	59.4 PK	74.0	-14.6	2.20 H	146	56.8	2.6
4	5350.00	47.8 AV	54.0	-6.2	2.20 H	146	45.2	2.6
5	10659.90	51.5 PK	74.0	-22.5	2.06 H	162	38.8	12.7
6	10659.90	41.0 AV	54.0	-13.0	2.06 H	162	28.3	12.7
7	15989.85	58.5 PK	74.0	-15.5	2.43 H	304	45.7	12.8
8	15989.85	44.0 AV	54.0	-10.0	2.43 H	304	31.2	12.8

ANTENNA POLARITY & TEST DISTANCE: VERTICAL AT 3 M

NO.	FREQ. (MHz)	EMISSION LEVEL (dBuV/m)	LIMIT (dBuV/m)	MARGIN (dB)	ANTENNA HEIGHT (m)	TABLE ANGLE (Degree)	RAW VALUE (dBuV)	CORRECTION FACTOR (dB/m)
1	*5329.95	115.4 PK			2.06 V	159	112.8	2.6
2	*5329.95	102.5 AV			2.06 V	159	99.9	2.6
3	5350.00	61.9 PK	74.0	-12.1	2.06 V	159	59.3	2.6
4	5350.00	50.9 AV	54.0	-3.1	2.06 V	159	48.3	2.6
5	10659.90	52.8 PK	74.0	-21.2	1.62 V	170	40.1	12.7
6	10659.90	41.8 AV	54.0	-12.2	1.62 V	170	29.1	12.7
7	15989.85	59.0 PK	74.0	-15.0	1.64 V	239	46.2	12.8
8	15989.85	43.7 AV	54.0	-10.3	1.64 V	239	30.9	12.8

REMARKS:

1. Emission Level(dBuV/m) = Raw Value(dBuV) + Correction Factor(dB/m)
2. Correction Factor(dB/m) = Antenna Factor(dB/m) + Cable Factor(dB) – Pre-Amplifier Factor(dB)
3. The other emission levels were very low against the limit.
4. Margin value = Emission Level – Limit value
5. " * ": Fundamental frequency.

CHANNEL	TX Channel 96+100	DETECTOR FUNCTION	Peak (PK)
FREQUENCY RANGE	1GHz ~ 40GHz		Average (AV)

ANTENNA POLARITY & TEST DISTANCE: HORIZONTAL AT 3 M

NO.	FREQ. (MHz)	EMISSION LEVEL (dBuV/m)	LIMIT (dBuV/m)	MARGIN (dB)	ANTENNA HEIGHT (m)	TABLE ANGLE (Degree)	RAW VALUE (dBuV)	CORRECTION FACTOR (dB/m)
1	5460.00	58.6 PK	74.0	-15.4	2.23 H	134	55.7	2.9
2	5460.00	48.7 AV	54.0	-5.3	2.23 H	134	45.8	2.9
3	#5470.00	64.2 PK	68.2	-4.0	2.23 H	134	61.3	2.9
4	*5490.05	112.9 PK			2.23 H	134	110.0	2.9
5	*5490.05	100.5 AV			2.23 H	134	97.6	2.9
6	10980.10	51.3 PK	74.0	-22.7	2.00 H	156	38.2	13.1
7	10980.10	40.4 AV	54.0	-13.6	2.00 H	156	27.3	13.1
8	#16470.15	58.2 PK	68.2	-10.0	2.45 H	307	43.4	14.8

ANTENNA POLARITY & TEST DISTANCE: VERTICAL AT 3 M

NO.	FREQ. (MHz)	EMISSION LEVEL (dBuV/m)	LIMIT (dBuV/m)	MARGIN (dB)	ANTENNA HEIGHT (m)	TABLE ANGLE (Degree)	RAW VALUE (dBuV)	CORRECTION FACTOR (dB/m)
1	5460.00	61.4 PK	74.0	-12.6	1.91 V	172	58.5	2.9
2	5460.00	51.0 AV	54.0	-3.0	1.91 V	172	48.1	2.9
3	#5470.00	66.6 PK	68.2	-1.6	1.91 V	172	63.7	2.9
4	*5490.05	115.0 PK			1.91 V	171	112.1	2.9
5	*5490.05	102.4 AV			1.91 V	171	99.5	2.9
6	10980.10	53.0 PK	74.0	-21.0	1.60 V	152	39.9	13.1
7	10980.10	42.1 AV	54.0	-11.9	1.60 V	152	29.0	13.1
8	#16470.15	58.7 PK	68.2	-9.5	1.74 V	231	43.9	14.8

REMARKS:

1. Emission Level(dBuV/m) = Raw Value(dBuV) + Correction Factor(dB/m)
2. Correction Factor(dB/m) = Antenna Factor(dB/m) + Cable Factor(dB) – Pre-Amplifier Factor(dB)
3. The other emission levels were very low against the limit.
4. Margin value = Emission Level – Limit value
5. " * ": Fundamental frequency.
6. " # ": The radiated frequency is out of the restricted band.

CHANNEL	TX Channel 108+112	DETECTOR FUNCTION	Peak (PK)
FREQUENCY RANGE	1GHz ~ 40GHz		Average (AV)

ANTENNA POLARITY & TEST DISTANCE: HORIZONTAL AT 3 M

NO.	FREQ. (MHz)	EMISSION LEVEL (dBuV/m)	LIMIT (dBuV/m)	MARGIN (dB)	ANTENNA HEIGHT (m)	TABLE ANGLE (Degree)	RAW VALUE (dBuV)	CORRECTION FACTOR (dB/m)
1	#5470.00	55.1 PK	68.2	-13.1	2.22 H	138	52.2	2.9
2	*5550.50	111.5 PK			2.22 H	138	108.5	3.0
3	*5550.50	99.7 AV			2.22 H	138	96.7	3.0
4	#5725.00	54.7 PK	68.2	-13.5	2.22 H	138	51.4	3.3
5	11100.00	51.1 PK	74.0	-22.9	2.00 H	157	38.1	13.0
6	11100.00	40.5 AV	54.0	-13.5	2.00 H	157	27.5	13.0
7	#16650.00	58.8 PK	68.2	-9.4	2.42 H	303	43.2	15.6

ANTENNA POLARITY & TEST DISTANCE: VERTICAL AT 3 M

NO.	FREQ. (MHz)	EMISSION LEVEL (dBuV/m)	LIMIT (dBuV/m)	MARGIN (dB)	ANTENNA HEIGHT (m)	TABLE ANGLE (Degree)	RAW VALUE (dBuV)	CORRECTION FACTOR (dB/m)
1	#5470.00	60.4 PK	68.2	-7.8	2.16 V	229	57.5	2.9
2	*5550.50	114.5 PK			2.16 V	229	111.5	3.0
3	*5550.50	101.8 AV			2.16 V	229	98.8	3.0
4	#5725.00	55.5 PK	68.2	-12.7	2.16 V	229	52.2	3.3
5	11100.00	52.6 PK	74.0	-21.4	1.62 V	170	39.6	13.0
6	11100.00	41.9 AV	54.0	-12.1	1.62 V	170	28.9	13.0
7	#16650.00	58.6 PK	68.2	-9.6	1.66 V	245	43.0	15.6

REMARKS:

1. Emission Level(dBuV/m) = Raw Value(dBuV) + Correction Factor(dB/m)
2. Correction Factor(dB/m) = Antenna Factor(dB/m) + Cable Factor(dB) – Pre-Amplifier Factor(dB)
3. The other emission levels were very low against the limit.
4. Margin value = Emission Level – Limit value
5. " # ": The radiated frequency is out of the restricted band.

CHANNEL	TX Channel 132+136	DETECTOR FUNCTION	Peak (PK)
FREQUENCY RANGE	1GHz ~ 40GHz		Average (AV)

ANTENNA POLARITY & TEST DISTANCE: HORIZONTAL AT 3 M

NO.	FREQ. (MHz)	EMISSION LEVEL (dBuV/m)	LIMIT (dBuV/m)	MARGIN (dB)	ANTENNA HEIGHT (m)	TABLE ANGLE (Degree)	RAW VALUE (dBuV)	CORRECTION FACTOR (dB/m)
1	*5670.05	114.3 PK			2.25 H	125	111.0	3.3
2	*5670.05	102.1 AV			2.25 H	125	98.8	3.3
3	#5725.00	58.1 PK	68.2	-10.1	2.25 H	125	54.8	3.3
4	11340.10	50.9 PK	74.0	-23.1	2.05 H	165	37.4	13.5
5	11340.10	40.3 AV	54.0	-13.7	2.05 H	165	26.8	13.5
6	#17010.15	59.1 PK	68.2	-9.1	2.42 H	311	42.6	16.5

ANTENNA POLARITY & TEST DISTANCE: VERTICAL AT 3 M

NO.	FREQ. (MHz)	EMISSION LEVEL (dBuV/m)	LIMIT (dBuV/m)	MARGIN (dB)	ANTENNA HEIGHT (m)	TABLE ANGLE (Degree)	RAW VALUE (dBuV)	CORRECTION FACTOR (dB/m)
1	*5670.05	116.5 PK			2.16 V	172	113.2	3.3
2	*5670.05	103.8 AV			2.16 V	172	100.5	3.3
3	#5725.00	60.4 PK	68.2	-7.8	2.16 V	172	57.1	3.3
4	11340.10	53.0 PK	74.0	-21.0	1.61 V	162	39.5	13.5
5	11340.10	42.1 AV	54.0	-11.9	1.61 V	162	28.6	13.5
6	#17010.15	58.3 PK	68.2	-9.9	1.65 V	225	41.8	16.5

REMARKS:

1. Emission Level(dBuV/m) = Raw Value(dBuV) + Correction Factor(dB/m)
2. Correction Factor(dB/m) = Antenna Factor(dB/m) + Cable Factor(dB) – Pre-Amplifier Factor(dB)
3. The other emission levels were very low against the limit.
4. Margin value = Emission Level – Limit value
5. " * ": Fundamental frequency.
6. " # ": The radiated frequency is out of the restricted band.

CHANNEL	TX Channel 140+144	DETECTOR FUNCTION	Peak (PK)
FREQUENCY RANGE	1GHz ~ 40GHz		Average (AV)

ANTENNA POLARITY & TEST DISTANCE: HORIZONTAL AT 3 M

NO.	FREQ. (MHz)	EMISSION LEVEL (dBuV/m)	LIMIT (dBuV/m)	MARGIN (dB)	ANTENNA HEIGHT (m)	TABLE ANGLE (Degree)	RAW VALUE (dBuV)	CORRECTION FACTOR (dB/m)
1	*5709.95	114.3 PK			2.27 H	135	111.0	3.3
2	*5709.95	102.1 AV			2.27 H	135	98.8	3.3
3	#5850.00	49.5 PK	68.2	-18.7	2.27 H	135	45.9	3.6
4	11419.90	51.8 PK	74.0	-22.2	2.02 H	172	38.4	13.4
5	11419.90	40.8 AV	54.0	-13.2	2.02 H	172	27.4	13.4
6	#17129.85	58.4 PK	68.2	-9.8	2.43 H	303	42.1	16.3

ANTENNA POLARITY & TEST DISTANCE: VERTICAL AT 3 M

NO.	FREQ. (MHz)	EMISSION LEVEL (dBuV/m)	LIMIT (dBuV/m)	MARGIN (dB)	ANTENNA HEIGHT (m)	TABLE ANGLE (Degree)	RAW VALUE (dBuV)	CORRECTION FACTOR (dB/m)
1	*5709.95	116.5 PK			2.19 V	164	113.2	3.3
2	*5709.95	104.1 AV			2.19 V	164	100.8	3.3
3	#5850.00	51.6 PK	68.2	-16.6	2.19 V	164	48.0	3.6
4	11419.90	53.4 PK	74.0	-20.6	1.58 V	163	40.0	13.4
5	11419.90	42.3 AV	54.0	-11.7	1.58 V	163	28.9	13.4
6	#17129.85	58.5 PK	68.2	-9.7	1.65 V	238	42.2	16.3

REMARKS:

1. Emission Level(dBuV/m) = Raw Value(dBuV) + Correction Factor(dB/m)
2. Correction Factor(dB/m) = Antenna Factor(dB/m) + Cable Factor(dB) – Pre-Amplifier Factor(dB)
3. The other emission levels were very low against the limit.
4. Margin value = Emission Level – Limit value
5. " * ": Fundamental frequency.
6. " # ": The radiated frequency is out of the restricted band.

LAA-2 carriers (CA_46A-46A)

CHANNEL	TX Channel 52+60	DETECTOR FUNCTION	Peak (PK)
FREQUENCY RANGE	1GHz ~ 40GHz		Average (AV)

ANTENNA POLARITY & TEST DISTANCE: HORIZONTAL AT 3 M

NO.	FREQ. (MHz)	EMISSION LEVEL (dBuV/m)	LIMIT (dBuV/m)	MARGIN (dB)	ANTENNA HEIGHT (m)	TABLE ANGLE (Degree)	RAW VALUE (dBuV)	CORRECTION FACTOR (dB/m)
1	5150.00	52.9 PK	74.0	-21.1	2.15 H	135	49.9	3.0
2	5150.00	40.1 AV	54.0	-13.9	2.15 H	135	37.1	3.0
3	*5259.90	113.2 PK			2.15 H	135	110.8	2.4
4	*5259.90	100.8 AV			2.15 H	135	98.4	2.4
5	*5299.80	110.1 PK			2.15 H	135	107.7	2.4
6	*5299.80	97.5 AV			2.15 H	135	95.1	2.4
7	#10519.80	52.3 PK	68.2	-15.9	1.98 H	167	39.4	12.9
8	#10599.60	52.7 PK	68.2	-15.5	2.11 H	184	40.3	12.4
9	15779.70	57.9 PK	74.0	-16.1	2.37 H	322	45.4	12.5
10	15779.70	42.9 AV	54.0	-11.1	2.37 H	322	30.4	12.5
11	15899.40	59.1 PK	74.0	-14.9	2.40 H	300	46.8	12.3
12	15899.40	44.2 AV	54.0	-9.8	2.40 H	300	31.9	12.3

ANTENNA POLARITY & TEST DISTANCE: VERTICAL AT 3 M

NO.	FREQ. (MHz)	EMISSION LEVEL (dBuV/m)	LIMIT (dBuV/m)	MARGIN (dB)	ANTENNA HEIGHT (m)	TABLE ANGLE (Degree)	RAW VALUE (dBuV)	CORRECTION FACTOR (dB/m)
1	5150.00	55.1 PK	74.0	-18.9	2.27 V	262	52.1	3.0
2	5150.00	42.3 AV	54.0	-11.7	2.27 V	262	39.3	3.0
3	*5259.90	115.5 PK			2.27 V	262	113.1	2.4
4	*5259.90	102.5 AV			2.27 V	262	100.1	2.4
5	*5299.80	112.3 PK			2.27 V	262	109.9	2.4
6	*5299.80	99.7 AV			2.27 V	262	97.3	2.4
7	#10519.80	53.1 PK	68.2	-15.1	1.56 V	169	40.2	12.9
8	#10599.60	53.4 PK	68.2	-14.8	1.57 V	160	41.0	12.4
9	15779.70	58.3 PK	74.0	-15.7	1.68 V	225	45.8	12.5
10	15779.70	43.3 AV	54.0	-10.7	1.68 V	225	30.8	12.5
11	15899.40	59.5 PK	74.0	-14.5	1.75 V	242	47.2	12.3
12	15899.40	44.7 AV	54.0	-9.3	1.75 V	242	32.4	12.3

REMARKS:

- Emission Level(dBuV/m) = Raw Value(dBuV) + Correction Factor(dB/m)
- Correction Factor(dB/m) = Antenna Factor(dB/m) + Cable Factor(dB) – Pre-Amplifier Factor(dB)
- The other emission levels were very low against the limit.
- Margin value = Emission Level – Limit value
- " * ": Fundamental frequency.
- " # ": The radiated frequency is out of the restricted band.

CHANNEL	TX Channel 56+64	DETECTOR FUNCTION	Peak (PK)
FREQUENCY RANGE	1GHz ~ 40GHz		Average (AV)

ANTENNA POLARITY & TEST DISTANCE: HORIZONTAL AT 3 M

NO.	FREQ. (MHz)	EMISSION LEVEL (dBuV/m)	LIMIT (dBuV/m)	MARGIN (dB)	ANTENNA HEIGHT (m)	TABLE ANGLE (Degree)	RAW VALUE (dBuV)	CORRECTION FACTOR (dB/m)
1	*5280.00	112.8 PK			2.14 H	128	110.4	2.4
2	*5280.00	100.5 AV			2.14 H	128	98.1	2.4
3	*5319.90	110.6 PK			2.14 H	128	108.1	2.5
4	*5319.90	98.2 AV			2.14 H	128	95.7	2.5
5	#10560.00	52.2 PK	68.2	-16.0	2.02 H	172	39.5	12.7
6	10639.80	52.5 PK	74.0	-21.5	2.05 H	173	39.9	12.6
7	10639.80	41.0 AV	54.0	-13.0	2.05 H	173	28.4	12.6
8	15840.00	58.2 PK	74.0	-15.8	2.45 H	310	45.8	12.4
9	15840.00	42.9 AV	54.0	-11.1	2.45 H	310	30.5	12.4
10	15959.70	58.6 PK	74.0	-15.4	2.47 H	307	46.1	12.5
11	15959.70	43.7 AV	54.0	-10.3	2.47 H	307	31.2	12.5

ANTENNA POLARITY & TEST DISTANCE: VERTICAL AT 3 M

NO.	FREQ. (MHz)	EMISSION LEVEL (dBuV/m)	LIMIT (dBuV/m)	MARGIN (dB)	ANTENNA HEIGHT (m)	TABLE ANGLE (Degree)	RAW VALUE (dBuV)	CORRECTION FACTOR (dB/m)
1	*5280.00	115.2 PK			2.25 V	257	112.8	2.4
2	*5280.00	102.1 AV			2.25 V	257	99.7	2.4
3	*5319.90	112.4 PK			2.25 V	257	109.9	2.5
4	*5319.90	100.4 AV			2.25 V	257	97.9	2.5
5	#10560.00	52.8 PK	68.2	-15.4	1.55 V	151	40.1	12.7
6	10639.80	53.1 PK	74.0	-20.9	1.52 V	164	40.5	12.6
7	10639.80	42.0 AV	54.0	-12.0	1.52 V	164	29.4	12.6
8	15840.00	59.2 PK	74.0	-14.8	1.64 V	251	46.8	12.4
9	15840.00	44.0 AV	54.0	-10.0	1.64 V	251	31.6	12.4
10	15959.70	59.7 PK	74.0	-14.3	1.70 V	238	47.2	12.5
11	15959.70	44.4 AV	54.0	-9.6	1.70 V	238	31.9	12.5

REMARKS:

1. Emission Level(dBuV/m) = Raw Value(dBuV) + Correction Factor(dB/m)
2. Correction Factor(dB/m) = Antenna Factor(dB/m) + Cable Factor(dB) – Pre-Amplifier Factor(dB)
3. The other emission levels were very low against the limit.
4. Margin value = Emission Level – Limit value
5. " * ": Fundamental frequency.
6. " # ": The radiated frequency is out of the restricted band.

CHANNEL	TX Channel 60+68	DETECTOR FUNCTION	Peak (PK)
FREQUENCY RANGE	1GHz ~ 40GHz		Average (AV)

ANTENNA POLARITY & TEST DISTANCE: HORIZONTAL AT 3 M

NO.	FREQ. (MHz)	EMISSION LEVEL (dBuV/m)	LIMIT (dBuV/m)	MARGIN (dB)	ANTENNA HEIGHT (m)	TABLE ANGLE (Degree)	RAW VALUE (dBuV)	CORRECTION FACTOR (dB/m)
1	*5299.80	112.2 PK			2.22 H	146	109.8	2.4
2	*5299.80	100.1 AV			2.22 H	146	97.7	2.4
3	*5340.00	110.6 PK			2.22 H	146	108.0	2.6
4	*5340.00	98.0 AV			2.22 H	146	95.4	2.6
5	5350.00	56.1 PK	74.0	-17.9	2.22 H	146	53.5	2.6
6	5350.00	45.9 AV	54.0	-8.1	2.22 H	146	43.3	2.6
7	#10599.60	52.0 PK	68.2	-16.2	2.02 H	173	39.6	12.4
8	10680.00	52.2 PK	74.0	-21.8	2.05 H	179	39.4	12.8
9	10680.00	41.3 AV	54.0	-12.7	2.05 H	179	28.5	12.8
10	15899.40	58.5 PK	74.0	-15.5	2.36 H	297	46.2	12.3
11	15899.40	43.3 AV	54.0	-10.7	2.36 H	297	31.0	12.3
12	16020.00	58.7 PK	74.0	-15.3	2.36 H	293	45.9	12.8
13	16020.00	43.4 AV	54.0	-10.6	2.36 H	293	30.6	12.8

ANTENNA POLARITY & TEST DISTANCE: VERTICAL AT 3 M

NO.	FREQ. (MHz)	EMISSION LEVEL (dBuV/m)	LIMIT (dBuV/m)	MARGIN (dB)	ANTENNA HEIGHT (m)	TABLE ANGLE (Degree)	RAW VALUE (dBuV)	CORRECTION FACTOR (dB/m)
1	*5299.80	115.6 PK			2.22 V	257	113.2	2.4
2	*5299.80	102.6 AV			2.22 V	257	100.2	2.4
3	*5340.00	112.4 PK			2.22 V	257	109.8	2.6
4	*5340.00	100.1 AV			2.22 V	257	97.5	2.6
5	5350.00	58.6 PK	74.0	-15.4	2.22 V	257	56.0	2.6
6	5350.00	48.3 AV	54.0	-5.7	2.22 V	257	45.7	2.6
7	#10599.60	53.1 PK	68.2	-15.1	1.61 V	164	40.7	12.4
8	10680.00	53.2 PK	74.0	-20.8	1.54 V	177	40.4	12.8
9	10680.00	42.4 AV	54.0	-11.6	1.54 V	177	29.6	12.8
10	15899.40	58.7 PK	74.0	-15.3	1.64 V	220	46.4	12.3
11	15899.40	43.6 AV	54.0	-10.4	1.64 V	220	31.3	12.3
12	16020.00	59.6 PK	74.0	-14.4	1.79 V	246	46.8	12.8
13	16020.00	44.4 AV	54.0	-9.6	1.79 V	246	31.6	12.8

REMARKS:

- Emission Level(dBuV/m) = Raw Value(dBuV) + Correction Factor(dB/m)
- Correction Factor(dB/m) = Antenna Factor(dB/m) + Cable Factor(dB) – Pre-Amplifier Factor(dB)
- The other emission levels were very low against the limit.
- Margin value = Emission Level – Limit value
- " * ": Fundamental frequency.
- " # ": The radiated frequency is out of the restricted band.

CHANNEL	TX Channel 96+104	DETECTOR FUNCTION	Peak (PK)
FREQUENCY RANGE	1GHz ~ 40GHz		Average (AV)

ANTENNA POLARITY & TEST DISTANCE: HORIZONTAL AT 3 M

NO.	FREQ. (MHz)	EMISSION LEVEL (dBuV/m)	LIMIT (dBuV/m)	MARGIN (dB)	ANTENNA HEIGHT (m)	TABLE ANGLE (Degree)	RAW VALUE (dBuV)	CORRECTION FACTOR (dB/m)
1	5460.00	58.6 PK	74.0	-15.4	2.17 H	140	55.7	2.9
2	5460.00	48.5 AV	54.0	-5.5	2.17 H	140	45.6	2.9
3	#5470.00	63.8 PK	68.2	-4.4	2.17 H	140	60.9	2.9
4	*5480.00	113.8 PK			2.17 H	140	110.9	2.9
5	*5480.00	100.7 AV			2.17 H	140	97.8	2.9
6	*5519.90	112.0 PK			2.17 H	140	109.0	3.0
7	*5519.90	99.8 AV			2.17 H	140	96.8	3.0
8	10960.00	51.8 PK	74.0	-22.2	2.04 H	151	38.6	13.2
9	10960.00	41.1 AV	54.0	-12.9	2.04 H	151	27.9	13.2
10	11039.80	52.2 PK	74.0	-21.8	2.12 H	155	39.1	13.1
11	11039.80	41.6 AV	54.0	-12.4	2.12 H	155	28.5	13.1
12	#16440.00	57.9 PK	68.2	-10.3	2.39 H	312	43.1	14.8
13	#16559.70	58.2 PK	68.2	-10.0	2.40 H	295	43.2	15.0

ANTENNA POLARITY & TEST DISTANCE: VERTICAL AT 3 M

NO.	FREQ. (MHz)	EMISSION LEVEL (dBuV/m)	LIMIT (dBuV/m)	MARGIN (dB)	ANTENNA HEIGHT (m)	TABLE ANGLE (Degree)	RAW VALUE (dBuV)	CORRECTION FACTOR (dB/m)
1	5460.00	61.9 PK	74.0	-12.1	2.25 V	157	59.0	2.9
2	5460.00	50.8 AV	54.0	-3.2	2.25 V	157	47.9	2.9
3	#5470.00	65.5 PK	68.2	-2.7	2.25 V	157	62.6	2.9
4	*5480.00	116.2 PK			2.25 V	157	113.3	2.9
5	*5480.00	102.9 AV			2.25 V	157	100.0	2.9
6	*5519.90	113.8 PK			2.38 V	201	110.8	3.0
7	*5519.90	101.5 AV			2.38 V	201	98.5	3.0
8	10960.00	53.4 PK	74.0	-20.6	1.61 V	157	40.2	13.2
9	10960.00	42.2 AV	54.0	-11.8	1.61 V	157	29.0	13.2
10	11039.80	53.8 PK	74.0	-20.2	1.55 V	155	40.7	13.1
11	11039.80	42.5 AV	54.0	-11.5	1.55 V	155	29.4	13.1
12	#16440.00	58.4 PK	68.2	-9.8	1.65 V	245	43.6	14.8
13	#16559.70	59.1 PK	68.2	-9.1	1.78 V	235	44.1	15.0

REMARKS:

1. Emission Level(dBuV/m) = Raw Value(dBuV) + Correction Factor(dB/m)
2. Correction Factor(dB/m) = Antenna Factor(dB/m) + Cable Factor(dB) – Pre-Amplifier Factor(dB)
3. The other emission levels were very low against the limit.
4. Margin value = Emission Level – Limit value
5. " * ": Fundamental frequency.
6. " # ": The radiated frequency is out of the restricted band.

CHANNEL	TX Channel 108+116	DETECTOR FUNCTION	Peak (PK)
FREQUENCY RANGE	1GHz ~ 40GHz		Average (AV)

ANTENNA POLARITY & TEST DISTANCE: HORIZONTAL AT 3 M

NO.	FREQ. (MHz)	EMISSION LEVEL (dBuV/m)	LIMIT (dBuV/m)	MARGIN (dB)	ANTENNA HEIGHT (m)	TABLE ANGLE (Degree)	RAW VALUE (dBuV)	CORRECTION FACTOR (dB/m)
1	*5540.00	114.5 PK			2.24 H	123	111.5	3.0
2	*5540.00	102.1 AV			2.24 H	123	99.1	3.0
3	*5579.90	113.3 PK			2.24 H	123	110.1	3.2
4	*5579.90	101.0 AV			2.24 H	123	97.8	3.2
5	11080.00	51.7 PK	74.0	-22.3	2.01 H	143	38.6	13.1
6	11080.00	41.4 AV	54.0	-12.6	2.01 H	143	28.3	13.1
7	11159.80	52.2 PK	74.0	-21.8	2.03 H	167	39.1	13.1
8	11159.80	41.9 AV	54.0	-12.1	2.03 H	167	28.8	13.1
9	#16620.00	58.6 PK	68.2	-9.6	2.35 H	303	43.3	15.3
10	#16739.70	59.1 PK	68.2	-9.1	2.44 H	297	42.7	16.4

ANTENNA POLARITY & TEST DISTANCE: VERTICAL AT 3 M

NO.	FREQ. (MHz)	EMISSION LEVEL (dBuV/m)	LIMIT (dBuV/m)	MARGIN (dB)	ANTENNA HEIGHT (m)	TABLE ANGLE (Degree)	RAW VALUE (dBuV)	CORRECTION FACTOR (dB/m)
1	*5540.00	116.7 PK			2.30 V	246	113.7	3.0
2	*5540.00	104.6 AV			2.30 V	246	101.6	3.0
3	*5579.90	115.7 PK			2.30 V	246	112.5	3.2
4	*5579.90	103.2 AV			2.30 V	246	100.0	3.2
5	11080.00	53.6 PK	74.0	-20.4	1.59 V	155	40.5	13.1
6	11080.00	42.3 AV	54.0	-11.7	1.59 V	155	29.2	13.1
7	11159.80	54.1 PK	74.0	-19.9	1.56 V	171	41.0	13.1
8	11159.80	42.8 AV	54.0	-11.2	1.56 V	171	29.7	13.1
9	#16620.00	59.1 PK	68.2	-9.1	1.71 V	234	43.8	15.3
10	#16739.70	59.8 PK	68.2	-8.4	1.71 V	232	43.4	16.4

REMARKS:

1. Emission Level(dBuV/m) = Raw Value(dBuV) + Correction Factor(dB/m)
2. Correction Factor(dB/m) = Antenna Factor(dB/m) + Cable Factor(dB) – Pre-Amplifier Factor(dB)
3. The other emission levels were very low against the limit.
4. Margin value = Emission Level – Limit value
5. " * ": Fundamental frequency.
6. " # ": The radiated frequency is out of the restricted band.

CHANNEL	TX Channel 132+140	DETECTOR FUNCTION	Peak (PK)
FREQUENCY RANGE	1GHz ~ 40GHz		Average (AV)

ANTENNA POLARITY & TEST DISTANCE: HORIZONTAL AT 3 M

NO.	FREQ. (MHz)	EMISSION LEVEL (dBuV/m)	LIMIT (dBuV/m)	MARGIN (dB)	ANTENNA HEIGHT (m)	TABLE ANGLE (Degree)	RAW VALUE (dBuV)	CORRECTION FACTOR (dB/m)
1	*5660.00	114.7 PK			2.21 H	130	111.4	3.3
2	*5660.00	102.3 AV			2.21 H	130	99.0	3.3
3	*5699.90	113.4 PK			2.21 H	130	110.0	3.4
4	*5699.90	101.1 AV			2.21 H	130	97.7	3.4
5	#5725.00	55.8 PK	68.2	-12.4	2.21 H	130	52.5	3.3
6	11320.00	51.8 PK	74.0	-22.2	1.99 H	155	38.3	13.5
7	11320.00	41.3 AV	54.0	-12.7	1.99 H	155	27.8	13.5
8	11399.80	52.4 PK	74.0	-21.6	2.07 H	166	38.9	13.5
9	11399.80	41.5 AV	54.0	-12.5	2.07 H	166	28.0	13.5
10	#16980.00	58.1 PK	68.2	-10.1	2.39 H	306	41.5	16.6
11	#17099.70	58.8 PK	68.2	-9.4	2.40 H	295	42.7	16.1

ANTENNA POLARITY & TEST DISTANCE: VERTICAL AT 3 M

NO.	FREQ. (MHz)	EMISSION LEVEL (dBuV/m)	LIMIT (dBuV/m)	MARGIN (dB)	ANTENNA HEIGHT (m)	TABLE ANGLE (Degree)	RAW VALUE (dBuV)	CORRECTION FACTOR (dB/m)
1	*5660.00	117.1 PK			2.41 V	193	113.8	3.3
2	*5660.00	104.9 AV			2.41 V	193	101.6	3.3
3	*5699.90	115.1 PK			2.41 V	193	111.7	3.4
4	*5699.90	102.7 AV			2.41 V	193	99.3	3.4
5	#5725.00	57.8 PK	68.2	-10.4	2.41 V	193	54.5	3.3
6	11320.00	53.8 PK	74.0	-20.2	1.53 V	152	40.3	13.5
7	11320.00	42.5 AV	54.0	-11.5	1.53 V	152	29.0	13.5
8	11399.80	54.3 PK	74.0	-19.7	1.51 V	156	40.8	13.5
9	11399.80	42.8 AV	54.0	-11.2	1.51 V	156	29.3	13.5
10	#16980.00	58.8 PK	68.2	-9.4	1.73 V	221	42.2	16.6
11	#17099.70	59.1 PK	68.2	-9.1	1.79 V	247	43.0	16.1

REMARKS:

- Emission Level(dBuV/m) = Raw Value(dBuV) + Correction Factor(dB/m)
- Correction Factor(dB/m) = Antenna Factor(dB/m) + Cable Factor(dB) – Pre-Amplifier Factor(dB)
- The other emission levels were very low against the limit.
- Margin value = Emission Level – Limit value
- " * ": Fundamental frequency.
- " # ": The radiated frequency is out of the restricted band.

CHANNEL	TX Channel 136+144	DETECTOR FUNCTION	Peak (PK)
FREQUENCY RANGE	1GHz ~ 40GHz		Average (AV)

ANTENNA POLARITY & TEST DISTANCE: HORIZONTAL AT 3 M

NO.	FREQ. (MHz)	EMISSION LEVEL (dBuV/m)	LIMIT (dBuV/m)	MARGIN (dB)	ANTENNA HEIGHT (m)	TABLE ANGLE (Degree)	RAW VALUE (dBuV)	CORRECTION FACTOR (dB/m)
1	*5680.10	114.3 PK			2.14 H	131	111.0	3.3
2	*5680.10	101.6 AV			2.14 H	131	98.3	3.3
3	*5720.00	113.0 PK			2.14 H	131	109.7	3.3
4	*5720.00	100.8 AV			2.14 H	131	97.5	3.3
5	#5850.00	51.1 PK	68.2	-17.1	2.14 H	131	47.5	3.6
6	11360.20	51.7 PK	74.0	-22.3	2.05 H	144	38.3	13.4
7	11360.20	41.4 AV	54.0	-12.6	2.05 H	144	28.0	13.4
8	11440.00	52.2 PK	74.0	-21.8	2.10 H	174	38.8	13.4
9	11440.00	41.7 AV	54.0	-12.3	2.10 H	174	28.3	13.4
10	#17040.30	57.9 PK	68.2	-10.3	2.45 H	297	41.5	16.4
11	#17160.00	58.8 PK	68.2	-9.4	2.46 H	301	42.5	16.3

ANTENNA POLARITY & TEST DISTANCE: VERTICAL AT 3 M

NO.	FREQ. (MHz)	EMISSION LEVEL (dBuV/m)	LIMIT (dBuV/m)	MARGIN (dB)	ANTENNA HEIGHT (m)	TABLE ANGLE (Degree)	RAW VALUE (dBuV)	CORRECTION FACTOR (dB/m)
1	*5680.10	117.1 PK			2.30 V	253	113.8	3.3
2	*5680.10	104.8 AV			2.30 V	253	101.5	3.3
3	*5720.00	115.5 PK			2.30 V	253	112.2	3.3
4	*5720.00	103.1 AV			2.30 V	253	99.8	3.3
5	#5850.00	52.3 PK	68.2	-15.9	2.30 V	253	48.7	3.6
6	11360.20	53.6 PK	74.0	-20.4	1.56 V	176	40.2	13.4
7	11360.20	42.6 AV	54.0	-11.4	1.56 V	176	29.2	13.4
8	11440.00	53.8 PK	74.0	-20.2	1.55 V	179	40.4	13.4
9	11440.00	42.9 AV	54.0	-11.1	1.55 V	179	29.5	13.4
10	#17040.30	59.0 PK	68.2	-9.2	1.74 V	227	42.6	16.4
11	#17160.00	59.2 PK	68.2	-9.0	1.71 V	253	42.9	16.3

REMARKS:

- Emission Level(dBuV/m) = Raw Value(dBuV) + Correction Factor(dB/m)
- Correction Factor(dB/m) = Antenna Factor(dB/m) + Cable Factor(dB) – Pre-Amplifier Factor(dB)
- The other emission levels were very low against the limit.
- Margin value = Emission Level – Limit value
- " * ": Fundamental frequency.
- " # ": The radiated frequency is out of the restricted band.

Below 1GHz Data:

LAA-2 carriers (CA_46A-46A)

CHANNEL	TX Channel 60+68	DETECTOR FUNCTION	Quasi-Peak (QP)
FREQUENCY RANGE	9kHz ~ 1GHz		

ANTENNA POLARITY & TEST DISTANCE: HORIZONTAL AT 3 M

NO.	FREQ. (MHz)	EMISSION LEVEL (dBuV/m)	LIMIT (dBuV/m)	MARGIN (dB)	ANTENNA HEIGHT (m)	TABLE ANGLE (Degree)	RAW VALUE (dBuV)	CORRECTION FACTOR (dB/m)
1	88.90	31.3 QP	43.5	-12.2	1.50 H	81	44.9	-13.6
2	221.11	28.9 QP	46.0	-17.1	1.50 H	299	40.2	-11.3
3	252.28	39.2 QP	46.0	-6.8	1.00 H	337	48.0	-8.8
4	297.16	39.7 QP	46.0	-6.3	1.00 H	0	46.9	-7.2
5	387.83	24.7 QP	46.0	-21.3	1.00 H	95	29.2	-4.5
6	775.57	27.5 QP	46.0	-18.5	1.00 H	4	24.6	2.9

REMARKS:

1. Emission Level(dBuV/m) = Raw Value(dBuV) + Correction Factor(dB/m)
2. Correction Factor(dB/m) = Antenna Factor(dB/m) + Cable Factor(dB) – Pre-Amplifier Factor(dB)
3. Margin value = Emission Level – Limit value
4. The emission levels were very low against the limit of frequency range 9kHz~30MHz: the amplitude of spurious emissions attenuated more than 20 dB below the permissible value to be report.

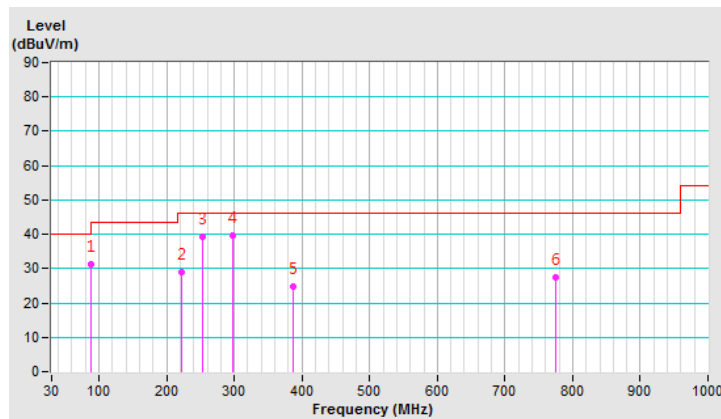

CHANNEL	TX Channel 60+68	DETECTOR FUNCTION	Quasi-Peak (QP)
FREQUENCY RANGE	9kHz ~ 1GHz		

ANTENNA POLARITY & TEST DISTANCE: VERTICAL AT 3 M

NO.	FREQ. (MHz)	EMISSION LEVEL (dBuV/m)	LIMIT (dBuV/m)	MARGIN (dB)	ANTENNA HEIGHT (m)	TABLE ANGLE (Degree)	RAW VALUE (dBuV)	CORRECTION FACTOR (dB/m)
1	67.83	26.9 QP	40.0	-13.1	1.00 V	305	36.0	-9.1
2	93.22	31.2 QP	43.5	-12.3	1.50 V	37	44.7	-13.5
3	103.26	28.2 QP	43.5	-15.3	1.00 V	29	40.0	-11.8
4	283.27	35.9 QP	46.0	-10.1	1.50 V	45	43.4	-7.5
5	297.48	34.5 QP	46.0	-11.5	1.50 V	49	41.7	-7.2
6	943.89	29.5 QP	46.0	-16.5	1.50 V	185	23.3	6.2

REMARKS:

1. Emission Level(dBuV/m) = Raw Value(dBuV) + Correction Factor(dB/m)
2. Correction Factor(dB/m) = Antenna Factor(dB/m) + Cable Factor(dB) – Pre-Amplifier Factor(dB)
3. Margin value = Emission Level – Limit value
4. The emission levels were very low against the limit of frequency range 9kHz~30MHz: the amplitude of spurious emissions attenuated more than 20 dB below the permissible value to be report.

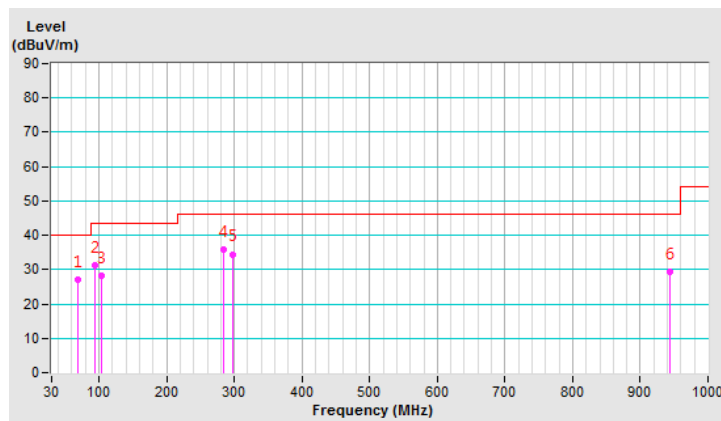

4.2 Conducted Emission Measurement

4.2.1 Limits of Conducted Emission Measurement

Frequency (MHz)	Conducted Limit (dBuV)	
	Quasi-peak	Average
0.15 - 0.5	66 - 56	56 - 46
0.50 - 5.0	56	46
5.0 - 30.0	60	50

Note: 1. The lower limit shall apply at the transition frequencies.

2. The limit decreases in line with the logarithm of the frequency in the range of 0.15 to 0.50MHz.

4.2.2 Test Instruments

DESCRIPTION & MANUFACTURER	MODEL NO.	SERIAL NO.	CALIBRATED DATE	CALIBRATED UNTIL
Test Receiver R&S	ESCS 30	847124/029	Nov. 01, 2017	Oct. 31, 2018
Line-Impedance Stabilization Network (for EUT) R&S	ESH3-Z5	848773/004	Nov. 15, 2017	Nov. 14, 2018
Line-Impedance Stabilization Network (for Peripheral) R&S	ENV216	100072	June 04, 2018	June 03, 2019
50 ohms Terminator	N/A	EMC-04	Nov. 01, 2017	Oct. 31, 2018
RF Cable	5D-FB	COCCAB-001	Sep. 28, 2018	Sep. 27, 2019
Fixed attenuator EMCI	STI02-2200-10	003	Mar. 16, 2018	Mar. 15, 2019
Software BVADT	BVADT_Cond_ V7.3.7.4	NA	NA	NA

Note:

1. The calibration interval of the above test instruments are 12 months and the calibrations are traceable to NML/ROC and NIST/USA.
2. The test was performed in Conduction 1.
3. Tested Date: Oct. 26, 2018

4.2.3 Test Procedure

- The EUT was placed 0.4 meters from the conducting wall of the shielded room with EUT being connected to the power mains through a line impedance stabilization network (LISN). Other support units were connected to the power mains through another LISN. The two LISNs provide 50 ohm/ 50uH of coupling impedance for the measuring instrument.
- Both lines of the power mains connected to the EUT were checked for maximum conducted interference.
- The frequency range from 150kHz to 30MHz was searched. Emission levels under (Limit - 20dB) was not recorded.

NOTE: All modes of operation were investigated and the worst-case emissions are reported.

4.2.4 Deviation from Test Standard

No deviation.

4.2.5 Test Setup

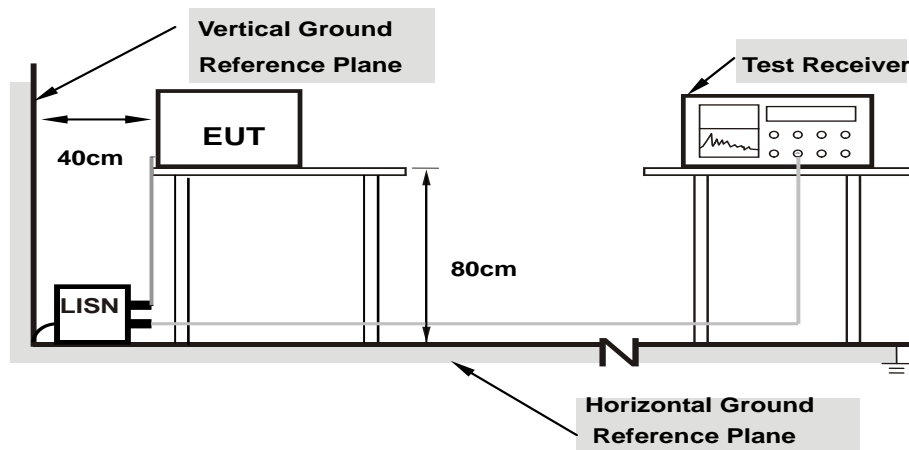

Note: 1.Support units were connected to second LISN.

For the actual test configuration, please refer to the attached file (Test Setup Photo).

4.2.6 EUT Operating Condition

Same as 4.1.6.

4.2.7 Test Results

Phase	Line (L)	Detector Function	Quasi-Peak (QP) / Average (AV)
-------	----------	-------------------	--------------------------------

No	Freq. [MHz]	Corr.	Reading Value		Emission Level		Limit		Margin	
		Factor (dB)	[dB (uV)]		[dB (uV)]		[dB (uV)]		(dB)	
			Q.P.	AV.	Q.P.	AV.	Q.P.	AV.	Q.P.	AV.
1	0.15000	10.02	29.62	8.54	39.64	18.56	66.00	56.00	-26.36	-37.44
2	0.17344	10.03	28.68	11.84	38.71	21.87	64.79	54.79	-26.08	-32.92
3	0.22031	10.04	24.09	10.52	34.13	20.56	62.81	52.81	-28.68	-32.25
4	0.93906	10.11	16.44	6.86	26.55	16.97	56.00	46.00	-29.45	-29.03
5	7.47656	10.41	11.49	4.86	21.90	15.27	60.00	50.00	-38.10	-34.73
6	29.80469	11.23	20.16	13.91	31.39	25.14	60.00	50.00	-28.61	-24.86

REMARKS:

1. Q.P. and AV. are abbreviations of quasi-peak and average individually.
2. The emission levels of other frequencies were very low against the limit.
3. Margin value = Emission level - Limit value
4. Correction factor = Insertion loss + Cable loss
5. Emission Level = Correction Factor + Reading Value.

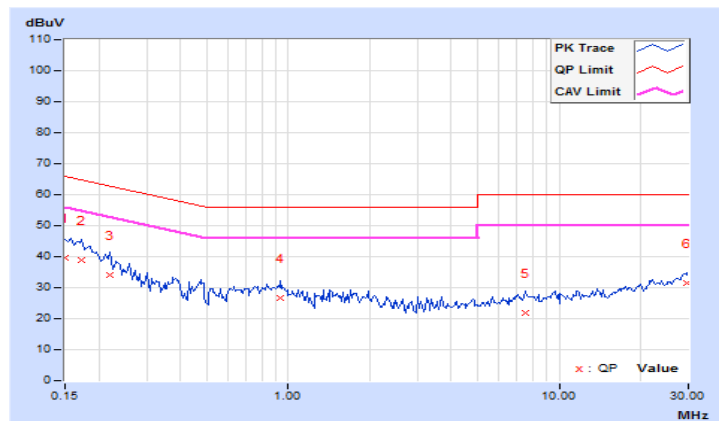

Phase	Neutral (N)	Detector Function	Quasi-Peak (QP) / Average (AV)
-------	-------------	-------------------	--------------------------------

No	Freq. [MHz]	Corr.	Reading Value		Emission Level		Limit		Margin	
		Factor	[dB (uV)]		[dB (uV)]		[dB (uV)]		(dB)	
	(dB)	Q.P.	AV.	Q.P.	AV.	Q.P.	AV.	Q.P.	AV.	
1	0.15391	9.93	28.44	5.00	38.37	14.93	65.79	55.79	-27.42	-40.86
2	0.17344	9.93	28.68	10.68	38.61	20.61	64.79	54.79	-26.18	-34.18
3	0.26328	9.95	19.81	5.79	29.76	15.74	61.33	51.33	-31.57	-35.59
4	0.37656	9.96	19.15	9.76	29.11	19.72	58.35	48.35	-29.24	-28.63
5	1.81250	10.03	12.21	3.32	22.24	13.35	56.00	46.00	-33.76	-32.65
6	29.75391	10.98	19.42	13.26	30.40	24.24	60.00	50.00	-29.60	-25.76

REMARKS:

1. Q.P. and AV. are abbreviations of quasi-peak and average individually.
2. The emission levels of other frequencies were very low against the limit.
3. Margin value = Emission level - Limit value
4. Correction factor = Insertion loss + Cable loss
5. Emission Level = Correction Factor + Reading Value.

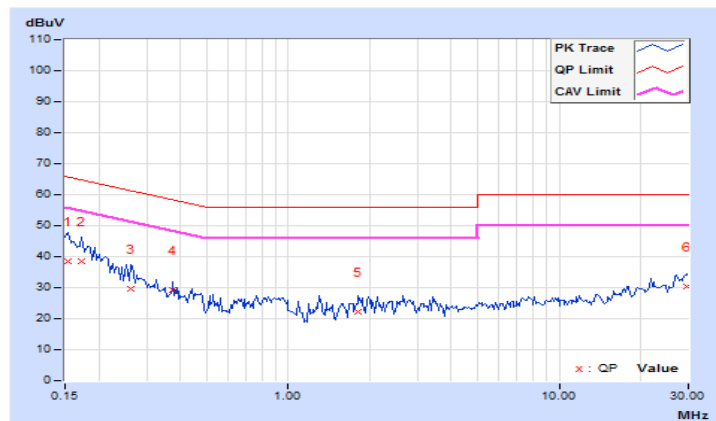

4.3 Transmit Power Measurement

4.3.1 Limits of Transmit Power Measurement

Operation Band	EUT Category		Limit
U-NII-1		Outdoor Access Point	1 Watt (30 dBm) (Max. e.i.r.p \leq 125mW(21 dBm) at any elevation angle above 30 degrees as measured from the horizon)
		Fixed point-to-point Access Point	1 Watt (30 dBm)
		Indoor Access Point	1 Watt (30 dBm)
		Client device	250mW (24 dBm)
U-NII-2A		√	250mW (24 dBm) or 11 dBm+10 log B*
U-NII-2C		√	250mW (24 dBm) or 11 dBm+10 log B*
U-NII-3			1 Watt (30 dBm)

*B is the 26 dB emission bandwidth in megahertz

Per KDB 662911 Method of conducted output power measurement on IEEE 802.11 devices,

Array Gain = 0 dB (i.e., no array gain) for $N_{ANT} \leq 4$;

Array Gain = 0 dB (i.e., no array gain) for channel widths ≥ 40 MHz for any N_{ANT} ;

Array Gain = $5 \log(N_{ANT}/N_{SS})$ dB or 3 dB, whichever is less for 20-MHz channel widths with $N_{ANT} \geq 5$.

For power measurements on all other devices: Array Gain = $10 \log(N_{ANT}/N_{SS})$ dB.

4.3.2 Test Setup

FOR POWER OUTPUT MEASUREMENT

For channel straddling 5725MHz:

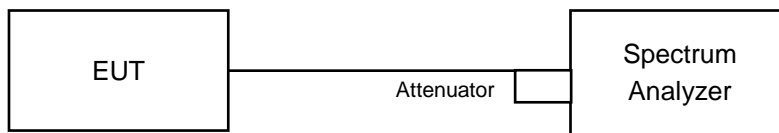

For other channels:

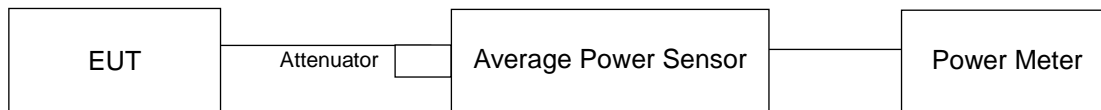

FOR 26dB OCCUPIED BANDWIDTH

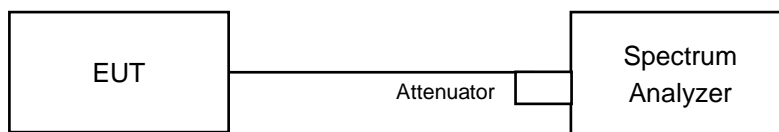

4.3.3 Test Instruments

Refer to section 4.1.2 to get information of above instrument.

4.3.4 Test Procedure

For Average Power Measurement

For channel straddling 5725MHz:

Follow FCC KDB 789033 UNII test procedure:

Method SA-1

1. Set span to encompass the entire emission bandwidth (EBW) of the signal.
2. Set RBW =1MHz.
3. Set the VBW $\geq 3 \times$ RBW.
4. Number of points in sweep ≥ 2 Span / RBW.
5. Sweep time = auto.
6. Set trigger to free run (duty cycle ≥ 98 percent)
7. Detector = RMS.
8. Trace average at least 100 traces in power averaging mode
9. Compute power by integrating the spectrum across the 26 dB EBW of the signal.

Other Modulation mode

Method PM is used to perform output power measurement, trigger and gating function of wide band power meter is enabled to measure max output power of TX on burst. Duty factor is not added to measured value.

FOR 26dB OCCUPIED BANDWIDTH

1. Set RBW = approximately 1% of the emission bandwidth.
2. Set the VBW $>$ RBW.
3. Detector = Peak.
4. Trace mode = max hold.
5. Measure the maximum width of the emission that is 26 dB down from the peak of the emission. Compare this with the RBW setting of the analyzer. Readjust RBW and repeat measurement as needed until the RBW/EBW ratio is approximately 1%.

4.3.5 Deviation from Test Standard

No deviation.

4.3.6 EUT Operating Condition

The software provided by client to enable the EUT under transmission condition continuously at lowest, middle and highest channel frequencies individually.

4.3.7 Test Result

LAA-single carrier

Chan.	Chan. Freq. (MHz)	Maximum Conducted Power (dBm)		Total Power (mW)	Total Power (dBm)	Limit (dBm)	Pass / Fail
		Chain 0	Chain 1				
52	5259.9	20.70	20.71	235.251	23.72	23.73	Pass
60	5299.8	20.67	20.72	234.713	23.71	23.72	Pass
68	5340	19.61	19.92	189.586	22.78	23.73	Pass
96	5480	19.54	19.86	186.778	22.71	23.74	Pass
116	5579.5	19.72	19.89	191.255	22.82	23.75	Pass
140	5699.9	19.61	19.87	188.462	22.75	23.74	Pass
144 (U-NII-2C Band)	5720	17.83	17.67	119.153	20.76	22.56	Pass
144 (U-NII-3 Band)	5720	12.14	12.12	32.661	15.14	29.89	Pass

Note: 1. For UNII-2A & UNII-2C: The directional gain is 6.11dBi > 6dBi, therefore the limit needs to reduce, so the power limit shall be reduced to "Determined Conducted Limit-(6.11-6)".

2. For UNII-3: Directional gain = 6.11dBi > 6dBi, so the power density limit shall be reduced to $30-(6.11-6) = 29.89\text{dBm}$.

* Test was performed in accordance with Measurement follow FCC KDB 789033 UNII test procedure Method SA-1 and use spectrum analyzer test.

26dB OCCUPIED BANDWIDTH

Channel	Frequency (MHz)	26dBc Bandwidth (MHz)	
		Chain 0	Chain 1
52	5260	19.25	19.28
60	5300	19.35	19.19
64	5320	19.28	19.25
100	5500	19.30	19.28
116	5580	19.33	19.34
140	5700	19.35	19.29
144 (UNII-2C Band)	5720	14.72	14.73

Note: For U-NII-2A, U-NII-2C Band output power limitation is determined based on 26dBc bandwidth

Power Limit = $11\text{dBm} + 10\log B < \text{U-NII-2A, U-NII-2C} >$

Channel Number	Freq.(MHz)	Min. B(MHz)	Determined Conducted Limit (dBm)
52	5260	19.25	23.84 < 24
60	5300	19.19	23.83 < 24
64	5320	19.25	23.84 < 24
100	5500	19.28	23.85 < 24
116	5580	19.33	23.86 < 24
140	5700	19.29	23.85 < 24
144 (UNII-2C Band)	5720	14.72	22.67 < 24

LAA-2 carriers (CA_46C)

Chan.	Chan. Freq. (MHz)	Maximum Conducted Power (dBm)		Total Power (mW)	Total Power (dBm)	Limit (dBm)	Pass / Fail
		Chain 0	Chain 1				
52+56	5269.95	20.72	20.66	234.445	23.70	23.89	Pass
60+64	5309.85	20.77	20.71	237.16	23.75	23.89	Pass
64+68	5329.95	20.81	20.76	239.628	23.80	23.89	Pass
96+100	5490.05	20.10	20.35	210.722	23.24	23.89	Pass
108+112	5550.05	20.28	20.46	217.833	23.38	23.89	Pass
132+136	5670.05	20.18	20.15	207.746	23.18	23.89	Pass
140+144 (U-NII-2C Band)	5709.95	18.49	18.51	141.59	21.51	23.89	Pass
140+144 (U-NII-3 Band)	5709.95	9.52	9.44	17.744	12.49	29.89	Pass

Note: 1. For UNII-2A & UNII-2C: The directional gain is 6.11dBi > 6dBi, therefore the limit needs to reduce, so the power limit shall be reduced to "Determined Conducted Limit-(6.11-6)".

2. For UNII-3: Directional gain = 6.11dBi > 6dBi, so the power density limit shall be reduced to 30-(6.11-6) = 29.89dBm.

* Test was performed in accordance with Measurement follow FCC KDB 789033 UNII test procedure Method SA-1 and use spectrum analyzer test.

26dB OCCUPIED BANDWIDTH

Channel	Frequency (MHz)	26dBc Bandwidth (MHz)	
		Chain 0	Chain 1
52	5260	40.75	40.72
60	5300	40.67	40.77
64	5320	40.69	40.68
100	5500	40.73	40.66
116	5580	40.73	40.72
140	5700	40.69	40.77
144 (UNII-2C Band)	5720	35.45	35.46

Note: For U-NII-2A, U-NII-2C Band output power limitation is determined based on 26dBc bandwidth

Power Limit = $11\text{dBm} + 10\log B < \text{U-NII-2A, U-NII-2C} >$

Channel Number	Freq.(MHz)	Min. B(MHz)	Determined Conducted Limit (dBm)
52	5260	40.72	27.09 > 24
60	5300	40.67	27.09 > 24
64	5320	40.68	27.09 > 24
100	5500	40.66	27.09 > 24
116	5580	40.72	27.09 > 24
140	5700	40.69	27.09 > 24
144 (UNII-2C Band)	5720	35.45	26.49 > 24

LAA-2 carriers (CA_46A-46A)

Chan.	Chan. Freq. (MHz)	Maximum Conducted Power (dBm)		Total Power (mW)	Total Power (dBm)	Limit (dBm)	Pass / Fail
		Chain 0	Chain 1				
52+60	5259.9+5299.8	20.81	20.72	238.536	23.78	23.89	Pass
56+64	5280+5319.9	20.83	20.71	238.821	23.78	23.89	Pass
60+68	5299.8+5340	20.84	20.75	240.189	23.81	23.89	Pass
96+104	5480+5519.9	20.45	20.31	218.316	23.39	23.89	Pass
108+116	5540+5579.9	20.31	20.39	216.795	23.36	23.89	Pass
132+140	5660+5699.9	20.41	20.37	218.794	23.40	23.89	Pass
136+144 (U-NII-2C Band)	5680.1	15.90	15.98	140.568	21.48	23.89	Pass
136+144 (U-NII-2C Band)	5720	14.82	15.01				Pass
136+144 (U-NII-3 Band)	5720	9.12	9.35	16.776	12.25	29.89	Pass

Note: 1. For UNII-2A & UNII-2C: The directional gain is 6.11dBi > 6dBi, therefore the limit needs to reduce, so the power limit shall be reduced to "Determined Conducted Limit-(6.11-6)".

2. For UNII-3: Directional gain = 6.11dBi > 6dBi, so the power density limit shall be reduced to $30-(6.11-6) = 29.89\text{dBm}$.

* Test was performed in accordance with Measurement follow FCC KDB 789033 UNII test procedure Method SA-1 and use spectrum analyzer test.

26dB OCCUPIED BANDWIDTH

Channel	Frequency (MHz)	26dBc Bandwidth (MHz)			
		Chain 0	Chain 1	Total-C0	Total-C1
52+60(L)	5259.9	19.41	19.43	38.69	38.71
52+60(H)	5299.8	19.28	19.28		
56+64(L)	5280	19.39	19.39	38.71	38.67
56+64(H)	5319.9	19.32	19.28		
60+68(L)	5299.8	19.44	19.40	38.69	38.76
60+68(H)	5340	19.25	19.36		
96+104(L)	5480	19.48	19.43	38.76	38.75
96+104(H)	5519.9	19.28	19.32		
108+116(L)	5540	19.42	19.37	38.62	38.73
108+116(H)	5579.9	19.20	19.36		
132+140(L)	5660	19.45	19.45	38.74	38.72
132+140(H)	5699.9	19.29	19.27		
136+144(L) (U-NII-2C Band)	5680.1	19.45	19.40	34.16	34.09
136+144(H) (U-NII-2C Band)	5720	14.71	14.69		

Note: For U-NII-2A, U-NII-2C Band output power limitation is determined based on 26dBc bandwidth

Power Limit = 11dBm + 10logB < U-NII-2A, U-NII-2C >			
Channel Number	Freq.(MHz)	Min. B(MHz)	Determined Conducted Limit (dBm)
52+60	5259.9+5299.8	38.69	26.87 > 24
56+64	5280+5319.9	38.67	26.87 > 24
60+68	5299.8+5340	38.69	26.87 > 24
96+104	5480+5519.9	38.75	26.88 > 24
108+116	5540+5579.9	38.62	26.86 > 24
132+140	5660+5699.9	38.72	26.87 > 24
136+144 (U-NII-2C Band)	5680.1+5720	34.09	26.32 > 24

4.4 Occupied Bandwidth Measurement

4.4.1 Test Setup



4.4.2 Test Instruments

Refer to section 4.1.2 to get information of above instrument.

4.4.3 Test Procedure

The transmitter output was connected to the spectrum analyzer through an attenuator. The bandwidth of the fundamental frequency was measured by spectrum analyzer with resolution bandwidth in the range of 1% to 5% of the anticipated emission bandwidth, and a video bandwidth at least 3x the resolution bandwidth and set the detector to SAMPLE. The width of a frequency band such that, below the lower and above the upper frequency limits, the mean powers emitted are each equal to a specified percentage 0.5 %of the total mean power of a given emission.

4.4.4 Test Results

LAA-single carrier

Channel	Channel Frequency (MHz)	Occupied Bandwidth (MHz)	
		Chain 0	Chain 1
52	5259.9	18.00	17.88
60	5299.8	17.88	18.00
68	5340	17.88	17.88
96	5480	17.88	18.00
116	5579.5	17.88	17.88
140	5699.9	17.88	17.88
144 (U-NII-2C Band)	5720	14.00	14.00
144 (U-NII-3 Band)	5720	3.88	3.88

LAA-2 carriers (CA_46C)

Channel	Channel Frequency (MHz)	Occupied Bandwidth (MHz)	
		Chain 0	Chain 1
52+56	5269.95	39.12	38.88
60+64	5309.85	38.16	38.16
64+68	5329.95	39.12	38.16
96+100	5490.05	38.16	38.16
108+112	5550.05	38.16	38.16
132+136	5670.05	38.16	38.16
140+144 (U-NII-2C Band)	5709.95	34.25	34.25

LAA-2 carriers (CA_46A-46A)

Channel	Frequency (MHz)	Occupied Bandwidth (MHz)			
		Chain 0	Chain 1	Total-C0	Total-C1
52+60(L)	5259.9	18.00	18.00	35.88	36.00
52+60(H)	5299.8	17.88	18.00		
56+64(L)	5280	18.00	18.00	36.00	35.88
56+64(H)	5319.9	18.00	17.88		
60+68(L)	5299.8	18.00	18.00	36.00	35.88
60+68(H)	5340	18.00	17.88		
96+104(L)	5480	18.00	18.00	35.88	35.88
96+104(H)	5519.9	17.88	17.88		
108+116(L)	5540	18.00	18.00	35.88	35.88
108+116(H)	5579.9	17.88	17.88		
132+140(L)	5660	18.00	18.00	36.00	36.00
132+140(H)	5699.9	18.00	18.00		
136+144(L)	5680.1	18.00	18.00	32.00	32.00
136+144(H) (U-NII-2C Band)	5720	14.00	14.00		

Note: For U-NII-2A, U-NII-2C Band output power limitation is determined based on 26dBc bandwidth

Spectrum Plot of Worst Value

LAA-single carrier / Chain 0 : CH52

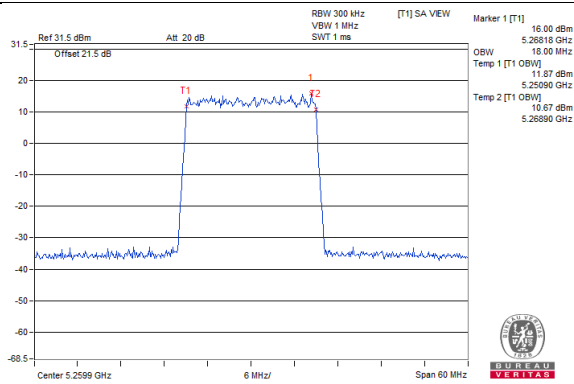

LAA-2 carriers (CA_46C) / Chain 0 : CH52+56

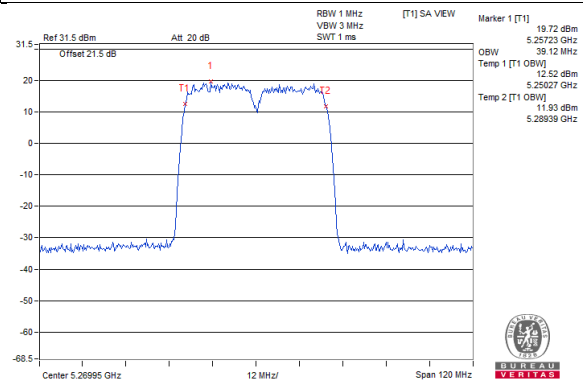

LAA-2 carriers (CA_46A-46A) / Chain 0 : CH136+144(L)

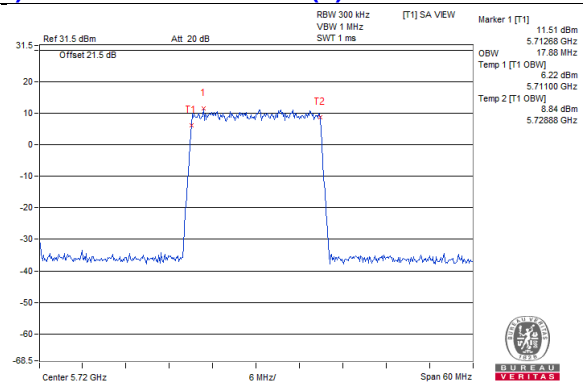
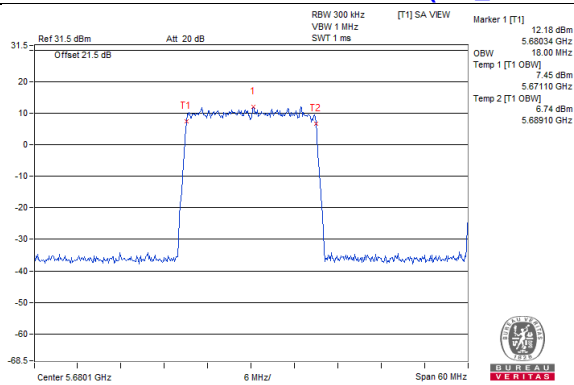

4.5 Peak Power Spectral Density Measurement

4.5.1 Limits of Peak Power Spectral Density Measurement

Operation Band	EUT Category		Limit
U-NII-1		Outdoor Access Point	17dBm/ MHz
		Fixed point-to-point Access Point	
		Indoor Access Point	
		Client device	11dBm/ MHz
U-NII-2A	√		11dBm/ MHz
U-NII-2C	√		11dBm/ MHz
U-NII-3			30dBm/ 500kHz

4.5.2 Test Setup

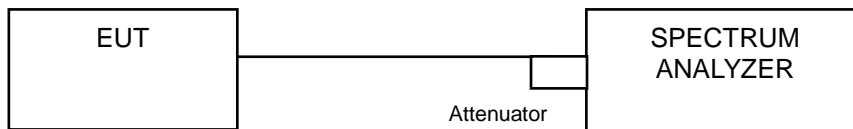

4.5.3 Test Instruments

Refer to section 4.1.2 to get information of above instrument.

4.5.4 Test Procedure

For U-NII-2A, U-NII-2C band:

Using method SA-1

1. Set span to encompass the entire emission bandwidth (EBW) of the signal.
2. Set RBW = 1 MHz, Set VBW \geq 3 MHz, Detector = RMS
3. Sweep time = auto, trigger set to "free run".
4. Trace average at least 100 traces in power averaging mode.
5. Record the max value

For U-NII-3 band:

1. Set span to encompass the entire emission bandwidth (EBW) of the signal.
2. Set RBW = 300 kHz, Set VBW \geq 1 MHz, Detector = RMS
3. Use the peak marker function to determine the maximum power level in any 300 kHz band segment within the fundamental EBW.
4. Scale the observed power level to an equivalent value in 500 kHz by adjusting (reducing) the measured power by a bandwidth correction factor (BWCF) where $BWCF = 10\log(500 \text{ kHz}/300\text{kHz})$
5. Sweep time = auto, trigger set to "free run".
6. Trace average at least 100 traces in power averaging mode.
7. Record the max value

4.5.5 Deviation from Test Standard

No deviation.

4.5.6 EUT Operating Condition

Same as Item 4.3.6.

4.5.7 Test Results
For U-NII-2A, U-NII-2C:
LAA-single carrier

Chan.	Chan. Freq. (MHz)	PSD (dBm/MHz)		Total Power Density (dBm/MHz)	MAX. Limit (dBm/MHz)	Pass / Fail
		Chain 0	Chain 1			
52	5259.9	7.57	8.15	10.88	10.89	Pass
60	5299.8	7.77	7.96	10.88	10.89	Pass
68	5340	6.73	7.16	9.96	10.89	Pass
96	5480	6.74	6.96	9.86	10.89	Pass
116	5579.5	6.61	7.04	9.84	10.89	Pass
140	5699.9	6.52	6.80	9.67	10.89	Pass
144 (U-NII-2C Band)	5720	6.79	6.58	9.70	10.89	Pass

Note: 1. Method a) of power density measurement of KDB 662911 is using for calculating total power density. Total power density is summing entire spectra across corresponding frequency bins on the various outputs by computer.
 2. Directional gain = 6.11dBi > 6dBi , so the power density limit shall be reduced to 11-(6.11-6) = 10.89dBm.

LAA-2 carriers (CA_46C)

Chan.	Chan. Freq. (MHz)	PSD (dBm/MHz)		Total Power Density (dBm/MHz)	MAX. Limit (dBm/MHz)	Pass / Fail
		Chain 0	Chain 1			
52+56	5259.9+5280	5.54	4.60	8.11	10.89	Pass
60+64	5299.8+5319.9	5.68	4.56	8.17	10.89	Pass
64+68	5319.9+5340	5.66	4.79	8.26	10.89	Pass
96+100	5480+5500.1	4.94	4.69	7.83	10.89	Pass
108+112	5540+5560.1	4.58	4.79	7.70	10.89	Pass
132+136	5660+5680.1	4.43	4.79	7.62	10.89	Pass
140+144 (U-NII-2C Band)	5699.9+5720	4.78	4.86	7.83	10.89	Pass

Note: 1. Method a) of power density measurement of KDB 662911 is using for calculating total power density. Total power density is summing entire spectra across corresponding frequency bins on the various outputs by computer.
 2. Directional gain = 6.11dBi > 6dBi , so the power density limit shall be reduced to 11-(6.11-6) = 10.89dBm.

LAA-2 carriers (CA_46A-46A)

Chan.	Chan. Freq. (MHz)	PSD (dBm/MHz)		Total Power Density (dBm/MHz)	MAX. Limit (dBm/MHz)	Pass / Fail
		Chain 0	Chain 1			
52+60(L)	5259.9	5.57	5.06	8.33	10.89	Pass
52+60(H)	5299.8	4.73	4.82	7.79	10.89	Pass
56+64(L)	5280	5.32	5.36	8.35	10.89	Pass
56+64(H)	5319.9	5.01	4.70	7.87	10.89	Pass
96+104(L)	5480	5.34	5.30	8.33	10.89	Pass
96+104(H)	5519.9	4.56	4.67	7.63	10.89	Pass
108+116(L)	5540	4.54	4.73	7.65	10.89	Pass
108+116(H)	5579.9	3.80	3.96	6.89	10.89	Pass
132+140(L)	5660	4.80	4.99	7.91	10.89	Pass
132+140(H)	5699.9	4.15	4.23	7.20	10.89	Pass
136+144(L)	5680.1	4.95	4.70	7.84	10.89	Pass
136+144(H) (U-NII-2C Band)	5720	3.93	4.26	7.11	10.89	Pass

- Note:** 1. Method a) of power density measurement of KDB 662911 is using for calculating total power density. Total power density is summing entire spectra across corresponding frequency bins on the various outputs by computer.
2. Directional gain = 6.11dBi > 6dBi , so the power density limit shall be reduced to 11-(6.11-6) = 10.89dBm.

Spectrum Plot of Worst Value

LAA-single carrier / Chain 1 : CH52

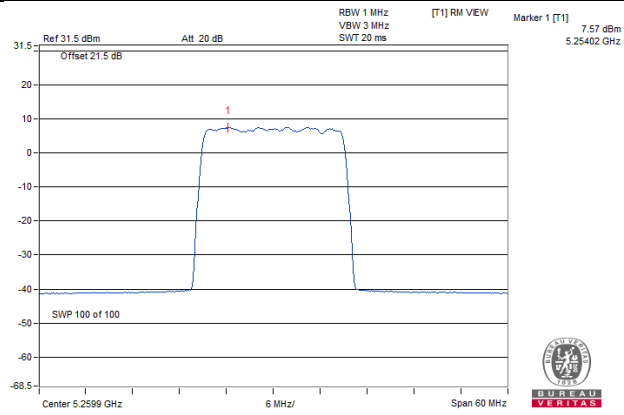

LAA-2 carriers (CA_46C) / Chain 0 : CH60+64

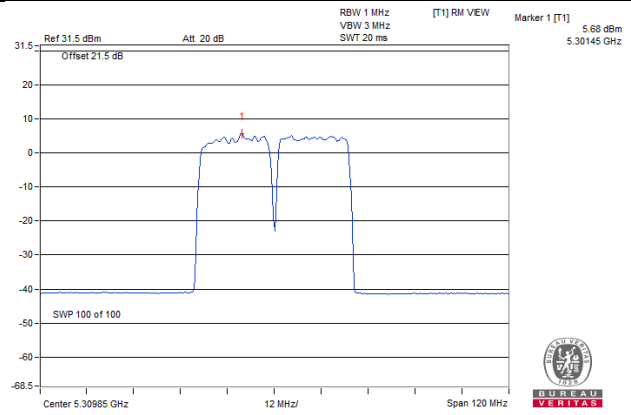

LAA-2 carriers (CA_46A-46A) / Chain 0 : CH52+60(L)

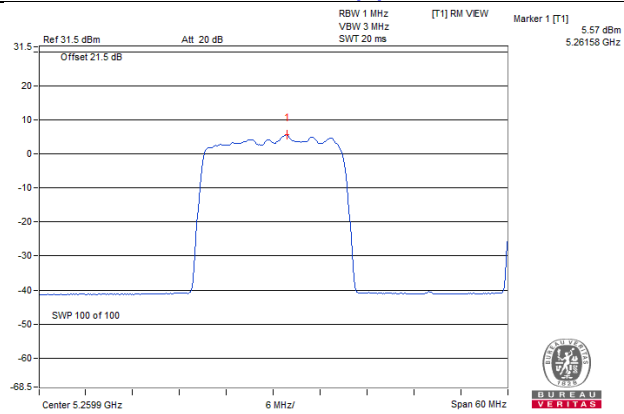

For U-NII-3:

LAA-single carrier

Chan.	Freq. (MHz)	PSD (dBm/300kHz)		Total PSD		Total PSD (dBm/500kHz)	Limit (dBm/500kHz)	Pass /Fail
		Chain 0	Chain 1	mW/300kHz	dBm/300kHz			
144 (U-NII-3 Band)	5720	-2.60	-2.51	1.1106	0.46	2.68	29.89	Pass

Note: 1. Method b) Measure and sum spectral maxima across the outputs of KDB 662911 is using for calculating total power density.

2. Directional gain = 6.11dBi > 6dBi, so the power density limit shall be reduced to $30-(6.11-6) = 29.89$ dBm.

LAA-2 carriers (CA_46C)

Chan.	Freq. (MHz)	PSD (dBm/300kHz)		Total PSD		Total PSD (dBm/500kHz)	Limit (dBm/500kHz)	Pass /Fail
		Chain 0	Chain 1	mW/300kHz	dBm/300kHz			
140+144 (U-NII-3 Band)	5709.95	-4.87	-5.05	0.6384	-1.95	0.27	29.89	Pass

Note: 1. Method b) Measure and sum spectral maxima across the outputs of KDB 662911 is using for calculating total power density.

2. Directional gain = 6.11dBi > 6dBi, so the power density limit shall be reduced to $30-(6.11-6) = 29.89$ dBm.

LAA-2 carriers (CA_46A-46A)

Chan.	Freq. (MHz)	PSD (dBm/300kHz)		Total PSD		Total PSD (dBm/500kHz)	Limit (dBm/500kHz)	Pass /Fail
		Chain 0	Chain 1	mW/300kHz	dBm/300kHz			
136+144 (U-NII-3 Band)	5720	-5.45	-5.22	0.5857	-2.32	-0.10	29.89	Pass

Note: 1. Method b) Measure and sum spectral maxima across the outputs of KDB 662911 is using for calculating total power density.

2. Directional gain = 6.11dBi > 6dBi, so the power density limit shall be reduced to $30-(6.11-6) = 29.89$ dBm.

Spectrum Plot of Worst Value

LAA-single carrier _Chain 1: 144 (U-NII-3 Band)

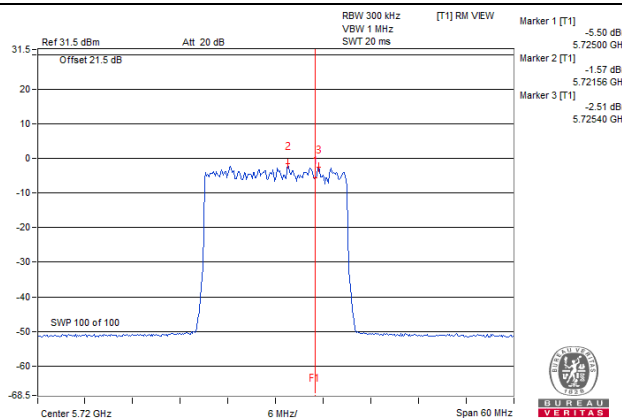

LAA-2 carriers (CA_46C) _Chain 0: 140+144 (U-NII-3 Band)

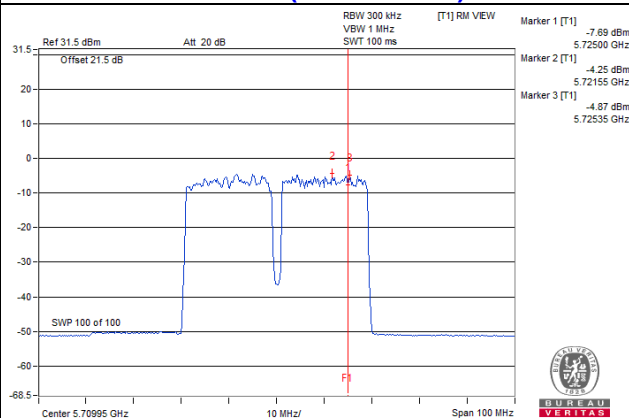

LAA-2 carriers (CA_46A-46A) _Chain 1: 136+144 (U-NII-3 Band)

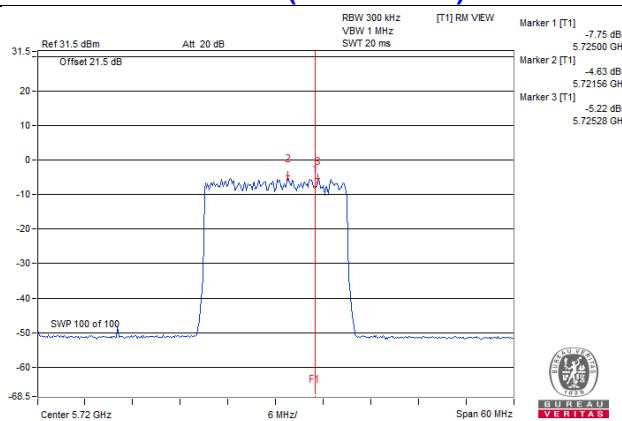

4.6 Frequency Stability Measurement

4.6.1 Limits of Frequency Stability Measurement

The frequency of the carrier signal shall be maintained within band of operation

4.6.2 Test Setup

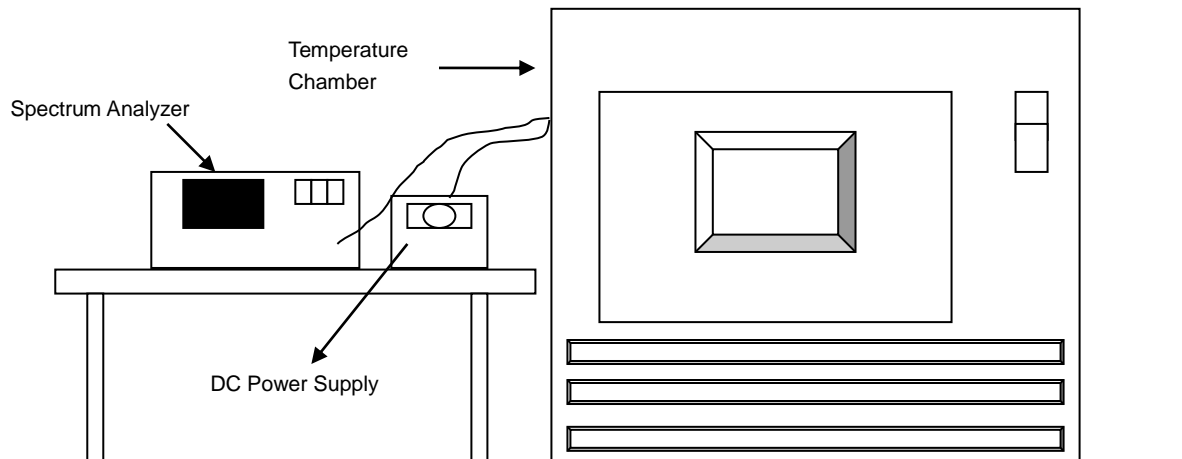

4.6.3 Test Instruments

Refer to section 4.1.2 to get information of above instrument.

4.6.4 Test Procedure

- The EUT was placed inside the environmental test chamber and powered by nominal DC voltage.
- Turn the EUT on and couple its output to a spectrum analyzer.
- Turn the EUT off and set the chamber to the highest temperature specified.
- Allow sufficient time (approximately 30 min) for the temperature of the chamber to stabilize, turn the EUT on and measure the operating frequency after 2, 5, and 10 Minutes.
- Repeat step 2 and 3 with the temperature chamber set to the lowest temperature.
- The test chamber was allowed to stabilize at +20 degree C for a minimum of 30 Minutes. The supply voltage was then adjusted on the EUT from 85% to 115% and the frequency record.

4.6.5 Deviation from Test Standard

No deviation.

4.6.6 EUT Operating Condition

Set the EUT transmit at un-modulation mode to test frequency stability.

4.6.7 Test Results

Frequency Stability Versus Temp.									
Operating Frequency: 5260 MHz									
TEMP. (°C)	Power Supply (Vdc)	0 Minute		2 Minutes		5 Minutes		10 Minutes	
		Measured Frequency (MHz)	Pass/Fail	Measured Frequency (MHz)	Pass/Fail	Measured Frequency (MHz)	Pass/Fail	Measured Frequency (MHz)	Pass/Fail
50	12	5259.8823	PASS	5259.8782	PASS	5259.8831	PASS	5259.8784	PASS
40	12	5259.9267	PASS	5259.9273	PASS	5259.9255	PASS	5259.9247	PASS
30	12	5259.9056	PASS	5259.9016	PASS	5259.9033	PASS	5259.9041	PASS
20	12	5259.8886	PASS	5259.8884	PASS	5259.8847	PASS	5259.8843	PASS
10	12	5259.8954	PASS	5259.894	PASS	5259.8938	PASS	5259.8956	PASS
0	12	5259.9266	PASS	5259.9256	PASS	5259.9257	PASS	5259.9235	PASS
-10	12	5259.9238	PASS	5259.9227	PASS	5259.9232	PASS	5259.9262	PASS
-20	12	5259.881	PASS	5259.8813	PASS	5259.8796	PASS	5259.8784	PASS
-30	12	5259.892	PASS	5259.8871	PASS	5259.892	PASS	5259.8897	PASS

Frequency Stability Versus Voltage									
Operating Frequency: 5260 MHz									
TEMP. (°C)	Power Supply (Vdc)	0 Minute		2 Minutes		5 Minutes		10 Minutes	
		Measured Frequency (MHz)	Pass/Fail	Measured Frequency (MHz)	Pass/Fail	Measured Frequency (MHz)	Pass/Fail	Measured Frequency (MHz)	Pass/Fail
20	13.8	5259.8892	PASS	5259.8877	PASS	5259.8845	PASS	5259.8848	PASS
	12	5259.8886	PASS	5259.8884	PASS	5259.8847	PASS	5259.8843	PASS
	10.2	5259.8883	PASS	5259.8874	PASS	5259.8848	PASS	5259.8834	PASS

4.7 6dB Bandwidth Measurement

4.7.1 Limits of 6dB Bandwidth Measurement

The minimum of 6dB Bandwidth Measurement is 0.5MHz.

4.7.2 Test Setup

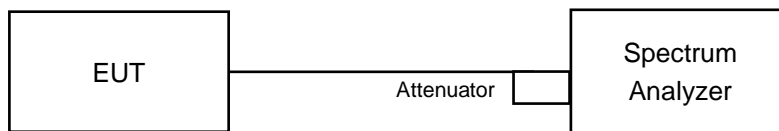

4.7.3 Test Instruments

Refer to section 4.1.2 to get information of above instrument.

4.7.4 Test Procedure

MEASUREMENT PROCEDURE REF

- a. Set resolution bandwidth (RBW) = 100kHz
- b. Set the video bandwidth (VBW) $\geq 3 \times$ RBW, Detector = Peak.
- c. Trace mode = max hold.
- d. Sweep = auto couple.
- e. Measure the maximum width of the emission that is constrained by the frequencies associated with the two amplitude points (upper and lower) that are attenuated by 6 dB relative to the maximum level measured in the fundamental emission

4.7.5 Deviation from Test Standard

No deviation.

4.7.6 EUT Operating Condition

The software provided by client to enable the EUT under transmission condition continuously at lowest, middle and highest channel frequencies individually.

4.7.7 Test Results

LAA-single carrier

Channel	Frequency (MHz)	6dB Bandwidth (MHz)		Minimum Limit (MHz)	Pass / Fail
		Chain 0	Chain 1		
144 (U-NII-3 Band)	5720	4.03	4.04	0.5	Pass

LAA-2 carriers (CA_46C)

Channel	Frequency (MHz)	6dB Bandwidth (MHz)		Minimum Limit (MHz)	Pass / Fail
		Chain 0	Chain 1		
140+144 (U-NII-3 Band)	5699.9+5720	4.06	4.06	0.5	Pass

LAA-2 carriers (CA_46A-46A)

Channel	Frequency (MHz)	6dB Bandwidth (MHz)		Minimum Limit (MHz)	Pass / Fail
		Chain 0	Chain 1		
136+144 (U-NII-3 Band)	5680.1+5720	4.05	4.05	0.5	Pass

Spectrum Plot of Worst Value

**LAA-single carrier / Chain 1 :
144 (U-NII-3 Band)**

**LAA-2 carriers (CA_46C) / Chain 1 : 140+144
(U-NII-3 Band)**

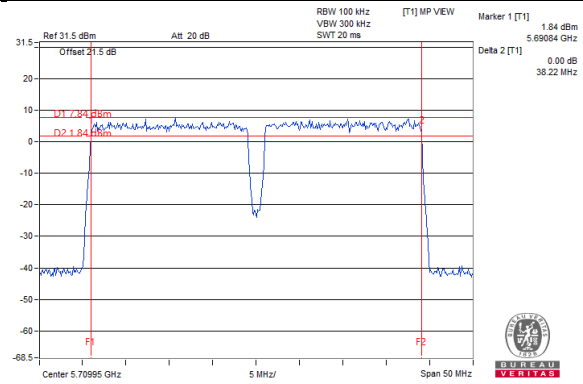
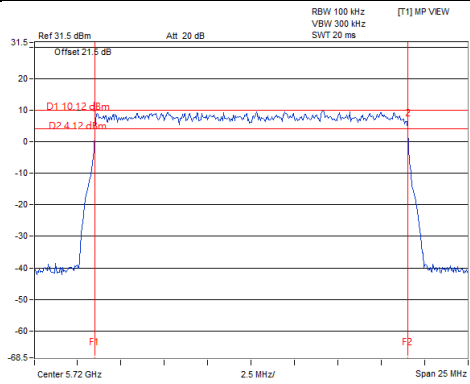

**LAA-2 carriers (CA_46A-46A) / Chain 1 :
136+144 (U-NII-3 Band)**

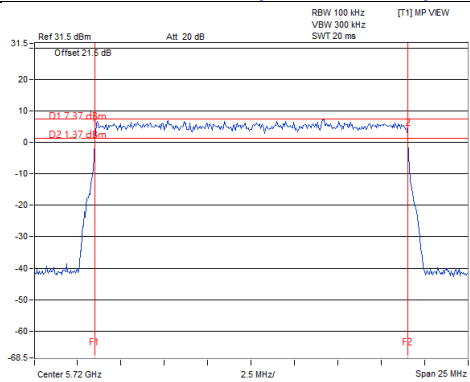

NOTE:

For CH144 (UNII-2C Band) = 5725MHz - Marker 1

4.8 26dB Bandwidth Measurement

4.8.1 Test Setup

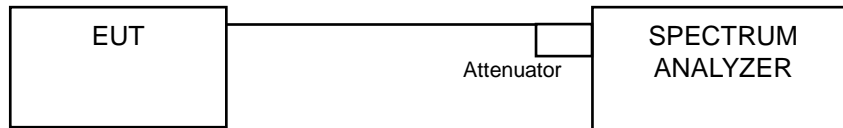

4.8.2 Test Instruments

Refer to section 4.1.2 to get information of above instrument.

4.8.3 Test Procedure

1. Set RBW = approximately 1% of the emission bandwidth.
2. Set the VBW > RBW.
3. Detector = Peak.
4. Trace mode = max hold.
5. Measure the maximum width of the emission that is 26 dB down from the peak of the emission. Compare this with the RBW setting of the analyzer. Readjust RBW and repeat measurement as needed until the RBW/EBW ratio is approximately 1%.

4.8.4 Deviation from Test Standard

No deviation.

4.8.5 EUT Operating Condition

The software provided by client to enable the EUT under transmission condition continuously at lowest, middle and highest channel frequencies individually.

4.8.6 Test Results

LAA-single carrier

Channel	Channel Frequency (MHz)	26dB Bandwidth (MHz)	
		Chain 0	Chain 1
52	5259.9	19.25	19.28
60	5299.8	19.35	19.19
68	5340	19.28	19.25
96	5480	19.30	19.28
116	5579.5	19.33	19.34
140	5699.9	19.35	19.29
144 (U-NII-2C Band)	5720	14.72	14.73
144 (U-NII-3 Band)	5720	4.61	4.58

LAA-2 carriers (CA_46C)

Channel	Channel Frequency (MHz)	26dB Bandwidth (MHz)	
		Chain 0	Chain 1
52+56	5259.9+5280	40.75	40.72
60+64	5299.8+5319.9	40.67	40.77
64+68	5319.9+5340	40.69	40.68
96+100	5480+5500.1	40.73	40.66
108+112	5540+5560.1	40.73	40.72
132+136	5660+5680.1	40.69	40.77
140+144 (U-NII-2C Band)	5699.9+5720	35.45	35.46
140+144 (U-NII-3 Band)	5699.9+5720	5.22	5.21

LAA-2 carriers (CA_46A-46A)

Channel	Channel Frequency (MHz)	26dB Bandwidth (MHz)			
		Chain 0	Chain 1	Total-C0	Total-C1
52+60(L)	5259.9	19.41	19.43	38.69	38.71
52+60(H)	5299.8	19.28	19.28		
56+64(L)	5280	19.39	19.39	38.71	38.67
56+64(H)	5319.9	19.32	19.28		
60+68(L)	5299.8	19.44	19.40	38.69	38.76
60+68(H)	5340	19.25	19.36		
96+104(L)	5480	19.48	19.43	38.76	38.75
96+104(H)	5519.9	19.28	19.32		
108+116(L)	5540	19.42	19.37	38.62	38.73
108+116(H)	5579.9	19.20	19.36		
132+140(L)	5660	19.45	19.45	38.74	38.72
132+140(H)	5699.9	19.29	19.27		
136+144(L) (U-NII-2C Band)	5680.1	19.45	19.40	34.16	34.09
136+144(H) (U-NII-2C Band)	5720	14.71	14.69		
136+144(H) (U-NII-3 Band)	5720	4.59	4.63		

Spectrum Plot of Worst Value

LAA-single carrier / Chain 0 : CH60

LAA-2 carriers (CA_46C) / Chain 1 : CH60+64

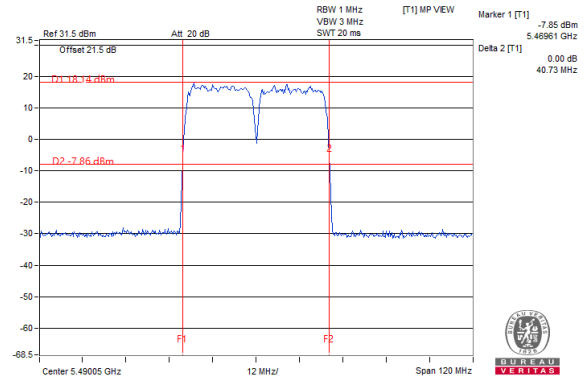
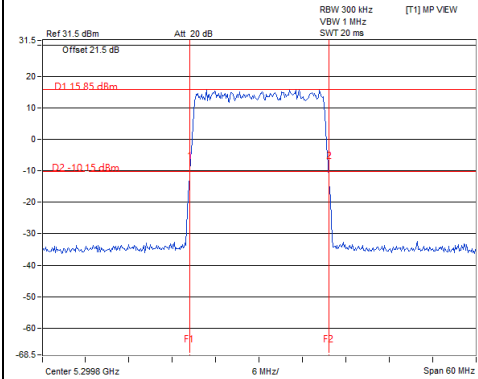

LAA-2 carriers (CA_46A-46A) / Chain 0 : CH96+104

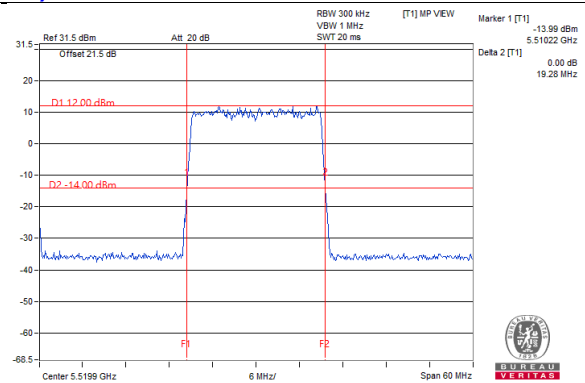
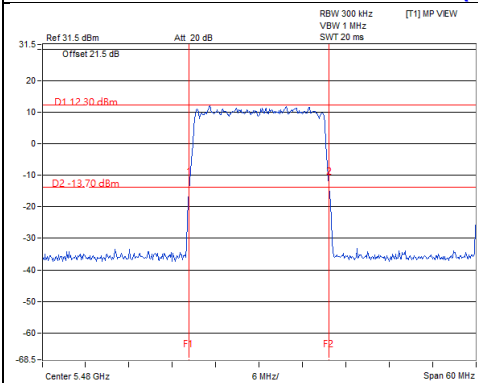

5 Pictures of Test Arrangements

Please refer to the attached file (Test Setup Photo).

Appendix – Information of the Testing Laboratories

We, Bureau Veritas Consumer Products Services (H.K.) Ltd., Taoyuan Branch, were founded in 1988 to provide our best service in EMC, Radio, Telecom and Safety consultation. Our laboratories are FCC recognized accredited test firms and accredited according to ISO/IEC 17025.

If you have any comments, please feel free to contact us at the following:

Lin Kou EMC/RF Lab

Tel: 886-2-26052180

Fax: 886-2-26051924

Hsin Chu EMC/RF/Telecom Lab

Tel: 886-3-6668565

Fax: 886-3-6668323

Hwa Ya EMC/RF/Safety Lab

Tel: 886-3-3183232

Fax: 886-3-3270892

Email: service.adt@tw.bureauveritas.com

Web Site: www.bureauveritas-adt.com

The address and road map of all our labs can be found in our web site also.

--- END ---