

FCC Test Report

Report No.: RF160815E05

FCC ID: 2AD8UFW2RADPM01

Test Model: FW2RADPM01

Received Date: Aug. 15, 2016

Test Date: Nov. 02 to 09, 2016

Issued Date: Nov. 25, 2016

Applicant: Nokia Solutions and Networks

Address: 1455 West Shure Drive, Arlington Heights, IL 60004, USA

Issued By: Bureau Veritas Consumer Products Services (H.K.) Ltd., Taoyuan Branch
Hsin Chu Laboratory

Lab Address: E-2, No.1, Li Hsin 1st Road, Hsinchu Science Park, Hsinchu City 300,
Taiwan R.O.C.

Test Location (1): E-2, No.1, Li Hsin 1st Road, Hsinchu Science Park, Hsinchu City 300,
Taiwan R.O.C.

Test Location (2): No. 49, Ln. 206, Wende Rd., Shangshan Tsuen, Chiung Lin Hsiang, Hsin
Chu Hsien 307, Taiwan R.O.C.



This report is for your exclusive use. Any copying or replication of this report to or for any other person or entity, or use of our name or trademark, is permitted only with our prior written permission. This report sets forth our findings solely with respect to the test samples identified herein. The results set forth in this report are not indicative or representative of the quality or characteristics of the lot from which a test sample was taken or any similar or identical product unless specifically and expressly noted. Our report includes all of the tests requested by you and the results thereof based upon the information that you provided to us. You have 60 days from date of issuance of this report to notify us of any material error or omission caused by our negligence, provided, however, that such notice shall be in writing and shall specifically address the issue you wish to raise. A failure to raise such issue within the prescribed time shall constitute your unqualified acceptance of the completeness of this report, the tests conducted and the correctness of the report contents. Unless specific mention, the uncertainty of measurement has been explicitly taken into account to declare the compliance or non-compliance to the specification. The report must not be used by the client to claim product certification, approval, or endorsement by TAF or any government agencies.

Table of Contents

Release Control Record	4
1 Certificate of Conformity	5
2 Summary of Test Results	6
2.1 Measurement Uncertainty.....	6
2.2 Modification Record.....	6
3 General Information	7
3.1 General Description of EUT.....	7
3.2 Description of Test Modes.....	9
3.2.1 Test Mode Applicability and Tested Channel Detail.....	10
3.3 Duty Cycle of Test Signal.....	13
3.4 Description of Support Units.....	14
3.4.1 Configuration of System under Test.....	14
3.5 General Description of Applied Standard.....	15
4 Test Types and Results	16
4.1 Radiated Emission and Bandedge Measurement.....	16
4.1.1 Limits of Radiated Emission and Bandedge Measurement.....	16
4.1.2 Test Instruments.....	17
4.1.3 Test Procedure.....	19
4.1.4 Deviation from Test Standard.....	19
4.1.5 Test Setup.....	20
4.1.6 EUT Operating Condition.....	20
4.1.7 Test Results.....	21
4.2 Conducted Emission Measurement.....	52
4.2.1 Limits of Conducted Emission Measurement.....	52
4.2.2 Test Instruments.....	52
4.2.3 Test Procedure.....	53
4.2.4 Deviation from Test Standard.....	53
4.2.5 Test Setup.....	53
4.2.6 EUT Operating Condition.....	53
4.2.7 Test Results.....	54
4.3 Transmit Power Measurement.....	56
4.3.1 Limits of Transmit Power Measurement.....	56
4.3.2 Test Setup.....	56
4.3.3 Test Instruments.....	56
4.3.4 Test Procedure.....	56
4.3.5 Deviation from Test Standard.....	56
4.3.6 EUT Operating Condition.....	56
4.3.7 Test Result.....	57
4.4 Occupied Bandwidth Measurement.....	59
4.4.1 Test Setup.....	59
4.4.2 Test Instruments.....	59
4.4.3 Test Procedure.....	59
4.5 Peak Power Spectral Density Measurement.....	64
4.5.1 Limits of Peak Power Spectral Density Measurement.....	64
4.5.2 Test Setup.....	64
4.5.3 Test Instruments.....	64
4.5.4 Test Procedure.....	64
4.5.5 Deviation from Test Standard.....	65
4.5.6 EUT Operating Condition.....	65
4.5.7 Test Results.....	66
4.6 Frequency Stability Measurement.....	72
4.6.1 Limits of Frequency Stability Measurement.....	72
4.6.2 Test Setup.....	72

4.6.3	Test Instruments	72
4.6.4	Test Procedure	72
4.6.5	Deviation from Test Standard	72
4.6.6	EUT Operating Condition	72
4.6.7	Test Results	73
4.7	6dB Bandwidth Measurement	74
4.7.1	Limits of 6dB Bandwidth Measurement	74
4.7.2	Test Setup	74
4.7.3	Test Instruments	74
4.7.4	Test Procedure	74
4.7.5	Deviation from Test Standard	74
4.7.6	EUT Operating Condition	74
4.7.7	Test Results	75
4.8	26dB Bandwidth Measurement	77
4.8.1	Test Setup	77
4.8.2	Test Instruments	77
4.8.3	Test Procedure	77
4.8.4	Deviation from Test Standard	77
4.8.5	EUT Operating Condition	77
4.8.6	Test Results	78
5	Pictures of Test Arrangements	81
	Annex A- Radiated Out of Band Emission (OOBE) Measurement (For U-NII-3 band)	82
	Appendix – Information on the Testing Laboratories	112

Release Control Record

Issue No.	Description	Date Issued
RF160815E05	Original release.	Nov. 25, 2016

1 Certificate of Conformity

Product: Nokia FW2R LTE module

Brand: Nokia

Test Model: FW2RADPM01

Sample Status: MASS-PRODUCTION

Applicant: Nokia Solutions and Networks

Test Date: Nov. 02 to 09, 2016

Standard: 47 CFR FCC Part 15, Subpart E (Section 15.407)
ANSI C63.10: 2013

The above equipment has been tested by **Bureau Veritas Consumer Products Services (H.K.) Ltd., Taoyuan Branch**, and found compliance with the requirement of the above standards. The test record, data evaluation & Equipment Under Test (EUT) configurations represented herein are true and accurate accounts of the measurements of the sample's EMC characteristics under the conditions specified in this report.

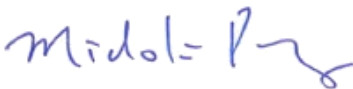
Prepared by :  , **Date:** Nov. 25, 2016
Midoli Peng / Specialist

Approved by :  , **Date:** Nov. 25, 2016
May Chen / Manager

2 Summary of Test Results

47 CFR FCC Part 15, Subpart E (SECTION 15.407)				
FCC Clause	FCC KDB 789033	Test Item	Result	Remarks
15.407(b)(6)	-	AC Power Conducted Emissions	Pass	Meet the requirement of limit. Minimum passing margin is -17.35dB at 29.00781MHz.
15.407(b) (1/2/3/4(i/ii)/6)	Section G	Radiated Emissions & Band Edge Measurement*	PASS	Meet the requirement of limit. Minimum passing margin is -0.1dB at 5150.00MHz, 5148.00MHz, 5627.90MHz, 5941.40MHz.
15.407(a)(1/2/3)	Section E.3	Transmit Output Power	PASS	Meet the requirement of limit.
15.407(a)(1/2/3)	Section F	Peak Power Spectral Density	PASS	Meet the requirement of limit.
15.407(e)	Section C.2	6dB bandwidth	PASS	Meet the requirement of limit. (U-NII-3 Band only)
-	Section D	Occupied Bandwidth Measurement	PASS	Meet the requirement.
15.407(g)	-	Frequency Stability	PASS	Meet the requirement of limit.
15.203	-	Antenna Requirement	Pass	Antenna connector is Right angle MMCX Plug not a standard connector.

NOTE: * For U-NII-3 band compliance with rule part 15.407(b)(4)(i), the OOB test plots were recorded in Annex A.

2.1 Measurement Uncertainty

Where relevant, the following measurement uncertainty levels have been estimated for tests performed on the EUT as specified in CISPR 16-4-2:

Measurement	Frequency	Expanded Uncertainty (k=2) (±)
Conducted Emissions at mains ports	150kHz ~ 30MHz	1.83 dB
Radiated Emissions up to 1 GHz	30MHz ~ 1GHz	5.34 dB
Radiated Emissions above 1 GHz	1GHz ~ 6GHz	3.41 dB
	6GHz ~ 18GHz	3.49 dB
	18GHz ~ 40GHz	3.30 dB

2.2 Modification Record

There were no modifications required for compliance.

3 General Information

3.1 General Description of EUT

Product	Nokia FW2R LTE module
Brand	Nokia
Test Model	FW2RADPM01
Test Sample S/N	EB1627M5421
Hardware Version	95.1659T00 X36
Status of EUT	MASS-PRODUCTION
Power Supply Rating	12Vdc from power adapter
Modulation Technology	OFDM
Operating Frequency	5.16 ~ 5.24GHz and 5.745 ~ 5.825GHz
Number of Channel	10
Output Power	5.16GHz ~ 5.24GHz: 581.477mW 5.745GHz ~ 5.825GHz: 582.879mW
Antenna Type	Refer to Note
Antenna Connector	Refer to Note
Accessory Device	Adapter x1
Data Cable Supplied	NA

Note:

1. The antennas provided to the EUT, please refer to the following table:

Antenna spec.

Antenna No	Brand	Model	Antenna Type	Gain(dBi)	Frequency range (MHz)
1	Nokia	NA	Loop (LAA#4(Main))	5.24	5150 ~ 5250, 5725 ~ 5825
2	Nokia	NA	Loop (LAA#2(DIV))	8.26	5150 ~ 5250, 5725 ~ 5825

Cable Spec.

Antenna No	Brand	Model	Connector Type	Cable Loss(dB)	Cable Length (mm)	Note
1	NA	NA	Right angle MMCX Plug	peak gain included	263	This cable will be equipped with Loop(LAA#4) antenna
2	NA	NA	Right angle MMCX Plug	peak gain included	263	This cable will be equipped with Loop(LAA#2) antenna

2. Directional gain(composite gain) :

Directional Gain.

Frequency range (MHz)	Max Gain(dBi)
5150 ~ 5250, 5725 ~ 5825	7.66

Note:

1. Directional gain calculation is based on FCC document KDB662911

$$\text{Directional gain} = \text{GANT MAX} + 10 \log(\text{NANT/NSS}) \text{ dBi,}$$

where

NSS = the number of independent spatial streams of data ;

GANT MAX is the gain of the antenna having the highest gain (in dBi).

2. Two directional gain values are calculated, directional gain values based on actual measurement data.

3. The EUT power needs to be supplied from one power adapter, the information is as below table:

Brand	Model	Spec.
DVE	DSA-60PFE-12 1 120500	Input: 100-240Vac, 50/60Hz, 2A Output: 12Vdc, 5A DC output cable (Shielded, 1.8m with one core)

4. The EUT is the LAA transmitter, the 3GPP Band 46 supports device operation only in U-NII-1 and U-NII-3.
5. The device (LAA) support 2x2MIMO, MIMO operation is considered while two LTE carriers are active (Chain 0 and Chain1) in the same band and same channel.
6. The above EUT information is declared by manufacturer and for more detailed features description, please refer to the manufacturer's specifications or user's manual.

3.2 Description of Test Modes

FOR 5160 ~ 5240MHz:

5 channels are provided for EUT.

U-NII Channel Number	3GPP Channel Number	Frequency	U-NII Channel Number	3GPP Channel Number	Frequency
32	46890	5160 MHz	44	47490	5220 MHz
36	47090	5180 MHz	48	47690	5240 MHz
40	47290	5200 MHz			

FOR 5745 ~ 5825MHz:

5 channels are provided for for EUT.

U-NII Channel Number	3GPP Channel Number	Frequency	U-NII Channel Number	3GPP Channel Number	Frequency
149	52740	5745MHz	161	53340	5805MHz
153	52940	5765MHz	165	53540	5825MHz
157	53140	5785MHz			

Note: For single carrier operation, one 20MHz 3GPP channels are used.

For 2 carriers (CA_46C or CA_46A-46A) operation, two 20MHz 3GPP channels are used to generate the 40MHz.

For 3 carriers (CA_46D) operation, three 20MHz 3GPP channels are used to generate the 60MHz

3.2.1 Test Mode Applicability and Tested Channel Detail

EUT CONFIGURE MODE	APPLICABLE TO				DESCRIPTION
	RE \geq 1G	RE<1G	PLC	APCM	
-	√	√	√	√	-

Where RE \geq 1G: Radiated Emission above 1GHz & Bandedge Measurement
 RE<1G: Radiated Emission below 1GHz

PLC: Power Line Conducted Emission
 APCM: Antenna Port Conducted Measurement

NOTE: The EUT had been pre-tested on the positioned of each 3 axis. The worst case was found when positioned on **Z-plane(below 1GHz) & X-plane(above 1GHz)**

Radiated Emission Test (Above 1GHz):

- Pre-Scan has been conducted to determine the worst-case mode from all possible combinations between available modulations, data rates and antenna ports (if EUT with antenna diversity architecture).
- Following channel(s) was (were) selected for the final test as listed below.

Mode	FREQ. Band (MHz)	Available Channel	U-NII Tested Channel	Modulation Technology
LAA-single carrier	5160-5240	32 to 48	32, 36, 40, 44, 48	OFDM
LAA-2 carriers (CA_46C)			32+36 36+40 40+44 44+48	OFDM
LAA-2 carriers (CA_46A-46A)			32+40 36+44 40+48	OFDM
LAA-3 carriers (CA_46D)			32+36+40 36+40+44 40+44+48	OFDM
LAA-single carrier			5745-5825	149 to 165
LAA-2 carriers (CA_46C)	149+153 153+157 157+161 161+165	OFDM		
LAA-2 carriers (CA_46A-46A)	149+157 153+161 157+165	OFDM		
LAA-3 carriers (CA_46D)	149+153+157 153+157+161 157+161+165	OFDM		

Radiated Emission Test (Below 1GHz):

- Pre-Scan has been conducted to determine the worst-case mode from all possible combinations between available modulations, data rates and antenna ports (if EUT with antenna diversity architecture).
- Following channel(s) was (were) selected for the final test as listed below.

Mode	FREQ. Band (MHz)	Available Channel	U-NII Tested Channel	Modulation Technology
LAA-single carrier	5160-5240	32 to 48	161	OFDM
	5745-5825	149 to 165		

Power Line Conducted Emission Test:

- Pre-Scan has been conducted to determine the worst-case mode from all possible combinations between available modulations, data rates and antenna ports (if EUT with antenna diversity architecture).
- Following channel(s) was (were) selected for the final test as listed below.

Mode	FREQ. Band (MHz)	Available Channel	U-NII Tested Channel	Modulation Technology
LAA-single carrier	5160-5240	32 to 48	161	OFDM
	5745-5825	149 to 165		

Antenna Port Conducted Measurement:

- This item includes all test value of each mode, but only includes spectrum plot of worst value of each mode.
- Pre-Scan has been conducted to determine the worst-case mode from all possible combinations between available modulations, data rates and antenna ports (if EUT with antenna diversity architecture).

Mode	FREQ. Band (MHz)	Available Channel	U-NII Tested Channel	Modulation Technology
LAA-single carrier	5160-5240	32 to 48	32, 36, 40, 44, 48	OFDM
LAA-2 carriers (CA_46C)			32+36 36+40 40+44 44+48	OFDM
LAA-2 carriers (CA_46A-46A)			32+40 36+44 40+48	OFDM
LAA-3 carriers (CA_46D)			32+36+40 36+40+44 40+44+48	OFDM
LAA-single carrier	5745-5825	149 to 165	149, 153, 157, 161, 165	OFDM
LAA-2 carriers (CA_46C)			149+153 153+157 157+161 161+165	OFDM
LAA-2 carriers (CA_46A-46A)			149+157 153+161 157+165	OFDM
LAA-3 carriers (CA_46D)			149+153+157 153+157+161 157+161+165	OFDM

Test Condition:

Applicable To	Environmental Conditions	Input Power	Tested By
RE \geq 1G	25deg. C, 71%RH	120Vac, 60Hz	Weiwei Lo
RE<1G	25deg. C, 73%RH	120Vac, 60Hz	Andy Ho
PLC	26deg. C, 62%RH	120Vac, 60Hz	Eagle Chen
APCM	25deg. C, 60%RH	120Vac, 60Hz	Anderson Chen

3.3 Duty Cycle of Test Signal

Duty cycle of test signal is 100 %, duty factor is not required.

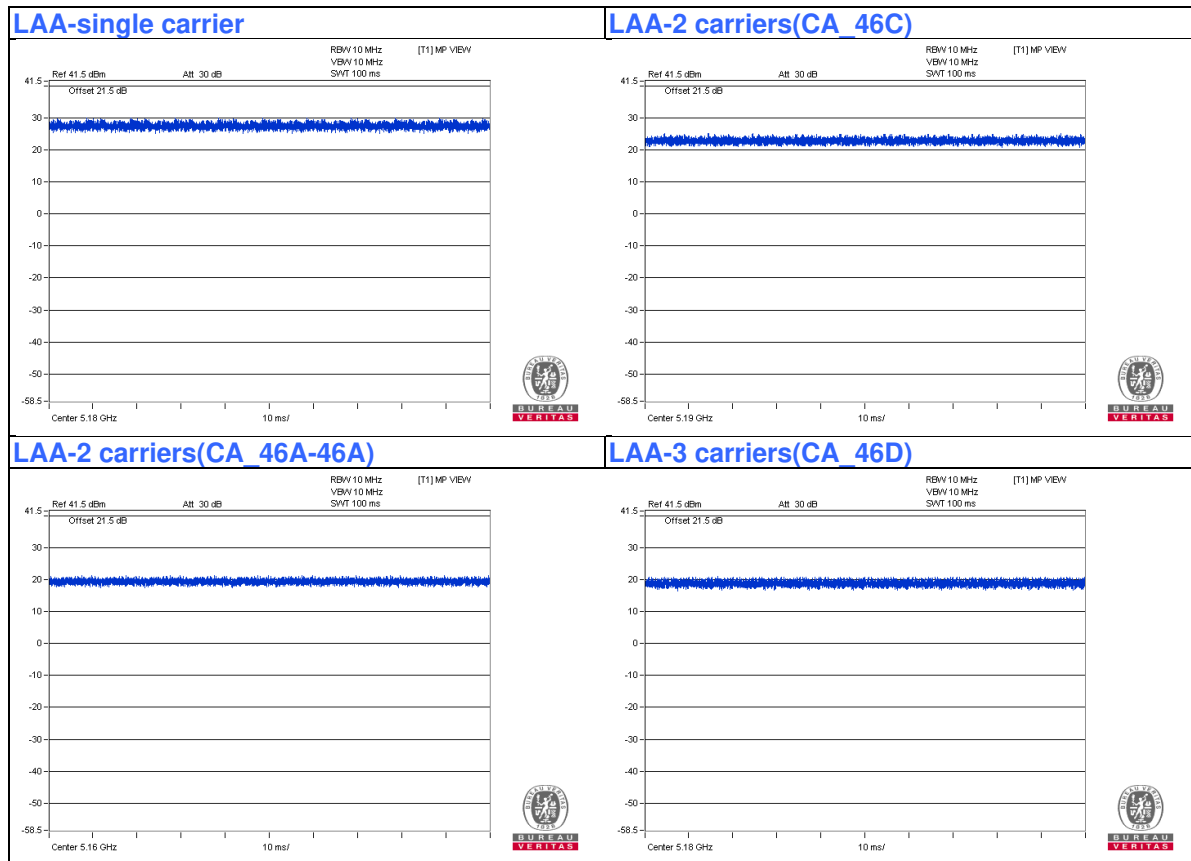

3.4 Description of Support Units

The EUT has been tested as an independent unit together with other necessary accessories or support units. The following support units or accessories were used to form a representative test configuration during the tests.

ID	Product	Brand	Model No.	Serial No.	FCC ID	Remarks
A.	Flexi Zone Multiband Indoor Pico BTS	Nokia	FW2XXXX	NA	NA	Supplied by client
B.	Adapter	DVE	DSA-60PFE-12 1 120500	NA	NA	Supplied by client

Note:

1. All power cords of the above support units are non-shielded (1.8m).

ID	Descriptions	Qty.	Length (m)	Shielding (Yes/No)	Cores (Qty.)	Remarks
1.	DC Cable	1	1.1	No	1	Supplied by client
2.	AC Cable	1	1.8	No	0	Provided by Lab

NOTE:

1. The core(s) is(are) originally attached to the cable(s).

3.4.1 Configuration of System under Test

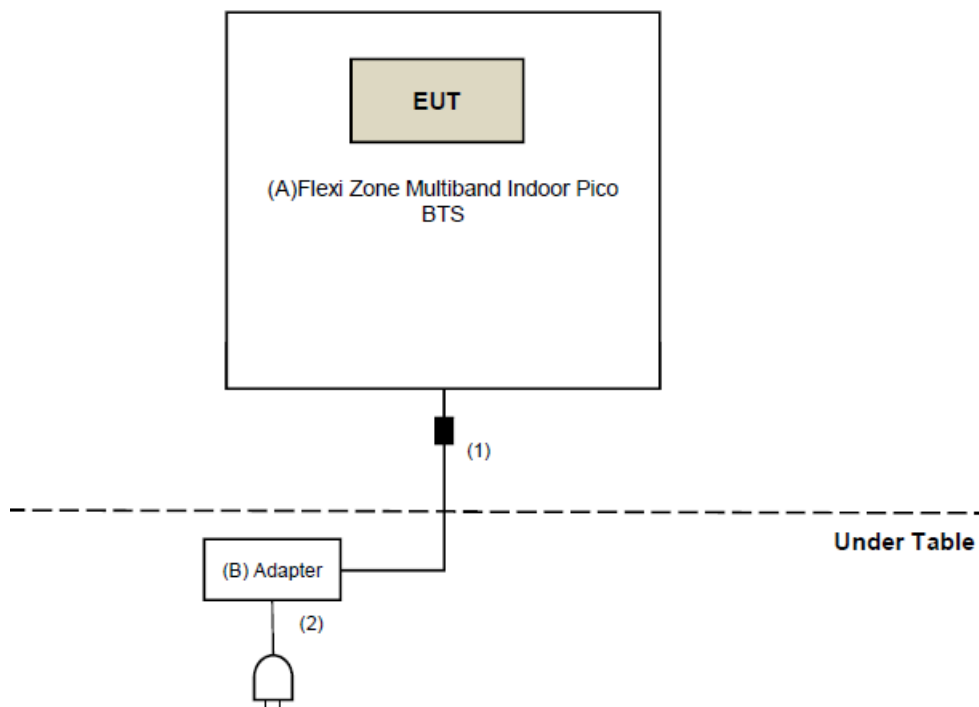

3.5 General Description of Applied Standard

The EUT is a RF Product. According to the specifications of the manufacturer, it must comply with the requirements of the following standards:

FCC Part 15, Subpart E (15.407)
KDB 789033 D02 General UNII Test Procedure New Rules v01r03
KDB 662911 D01 Multiple Transmitter Output v02r01
KDB 644545 D03 Guidance for IEEE 802.11ac v01
ANSI C63.10-2013

All test items have been performed and recorded as per the above standards.

4 Test Types and Results

4.1 Radiated Emission and Bandedge Measurement

4.1.1 Limits of Radiated Emission and Bandedge Measurement

Radiated emissions which fall in the restricted bands must comply with the radiated emission limits specified as below table.

Frequencies (MHz)	Field Strength (microvolts/meter)	Measurement Distance (meters)
0.009 ~ 0.490	2400/F(kHz)	300
0.490 ~ 1.705	24000/F(kHz)	30
1.705 ~ 30.0	30	30
30 ~ 88	100	3
88 ~ 216	150	3
216 ~ 960	200	3
Above 960	500	3

NOTE:

1. The lower limit shall apply at the transition frequencies.
2. Emission level (dBuV/m) = 20 log Emission level (uV/m).
3. For frequencies above 1000MHz, the field strength limits are based on average detector, however, the peak field strength of any emission shall not exceed the maximum permitted average limits, specified above by more than 20dB under any condition of modulation.

Limits of unwanted emission out of the restricted bands

Applicable To		Limit	
789033 D02 General UNII Test Procedure New Rules v01r03		Field Strength at 3m	
		PK:74 (dBuV/m)	AV:54 (dBuV/m)
Frequency Band	Applicable To	EIRP Limit	Equivalent Field Strength at 3m
5150~5250 MHz	15.407(b)(1)	PK:-27 (dBm/MHz)	PK:68.2(dBμV/m)
5250~5350 MHz	15.407(b)(2)		
5470~5725 MHz	15.407(b)(3)		
5725~5850 MHz	<input checked="" type="checkbox"/> 15.407(b)(4)(i)	PK:-27 (dBm/MHz) ^{*1} PK:10 (dBm/MHz) ^{*2} PK:15.6 (dBm/MHz) ^{*3} PK:27 (dBm/MHz) ^{*4}	PK: 68.2(dBμV/m) ^{*1} PK:105.2 (dBμV/m) ^{*2} PK: 110.8(dBμV/m) ^{*3} PK:122.2 (dBμV/m) ^{*4}
	<input type="checkbox"/> 15.407(b)(4)(ii)	Emission limits in section 15.247(d)	
^{*1} beyond 75 MHz or more above of the band edge.		^{*2} below the band edge increasing linearly to 10 dBm/MHz at 25 MHz above.	
^{*3} below the band edge increasing linearly to a level of 15.6 dBm/MHz at 5 MHz above.		^{*4} from 5 MHz above or below the band edge increasing linearly to a level of 27 dBm/MHz at the band edge.	

Note:

The following formula is used to convert the equipment isotropic radiated power (eirp) to field strength:

$$E = \frac{1000000\sqrt{30P}}{3} \mu\text{V/m, where } P \text{ is the eirp (Watts).}$$

4.1.2 Test Instruments

DESCRIPTION & MANUFACTURER	MODEL NO.	SERIAL NO.	CALIBRATED DATE	CALIBRATED UNTIL
Test Receiver Keysight	N9038A	MY54450088	July 20, 2016	July 19, 2017
Pre-Amplifier ^(*) EMCI	EMC001340	980142	Jan. 20, 2016	Jan. 19, 2018
Loop Antenna ^(*) Electro-Metrics	EM-6879	264	Dec. 16, 2014	Dec. 15, 2016
RF Cable	NA	LOOPCAB-001 LOOPCAB-002	Jan. 18, 2016	Jan. 17, 2017
Pre-Amplifier Mini-Circuits	ZFL-1000VH2 B	AMP-ZFL-01	Nov. 11, 2015	Nov. 10, 2016
Trilog Broadband Antenna SCHWARZBECK	VULB 9168	9168-406	Jan. 04, 2016	Jan. 03, 2017
RF Cable	8D	966-4-1 966-4-2 966-4-3	Apr. 02, 2016	Apr. 01, 2017
Fixed attenuator Mini-Circuits	UNAT-5+	PAD-3m-4-01	Oct. 05, 2016	Oct. 04, 2017
Horn_Antenna SCHWARZBECK	BBHA 9120D	9120D-783	Jan. 19, 2016	Jan. 18, 2017
Pre-Amplifier Agilent	8449B	3008A01922	Sep. 18, 2016	Sep. 17, 2017
RF Cable	EMC104-SM- SM-2000 EMC104-SM- SM-5000 EMC104-SM- SM-5000	150318 150323 150324	Mar. 30, 2016	Mar. 29, 2017
Pre-Amplifier EMCI	EMC184045	980143	Jan. 15, 2016	Jan. 14, 2017
Horn_Antenna SCHWARZBECK	BBHA 9170	BBHA9170608	Jan. 08, 2016	Jan. 07, 2017
RF Cable	SUCOFLEX 102	36432/2 36441/2	Jan. 16, 2016	Jan. 15, 2017
Software	ADT_Radiated _V8.7.08	NA	NA	NA
Antenna Tower & Turn Table Max-Full	MF-7802	MF780208410	NA	NA
Boresight Antenna Fixture	FBA-01	FBA-SIP02	NA	NA
Spectrum Analyzer R&S	FSP40	100036	Jan. 27, 2016	Jan. 26, 2017
AC Power Source Extech Electronics	6502	1140503	NA	NA
Temperature & Humidity Chamber TERCHY	MHU-225AU	911033	Dec. 03, 2015	Dec. 02, 2016
Power meter Anritsu	ML2495A	0824006	May 26, 2016	May 25, 2017
Power sensor Anritsu	MA2411B	0738172	May 26, 2016	May 25, 2017
Digital Multimeter FLUKE	87III	73680266	Nov. 10, 2015	Nov. 09, 2016

Note:

1. The calibration interval of the above test instruments is 12 months and the calibrations are traceable to NML/ROC and NIST/USA.
2. *The calibration interval of the above test instruments is 24 months and the calibrations are traceable to NML/ROC and NIST/USA.
3. The test was performed in 966 Chamber No. 4.
4. The FCC Site Registration No. is 292998
5. The CANADA Site Registration No. is 20331-2
- 6 Loop antenna was used for all emissions below 30 MHz.
7. Tested Date: Nov. 02 to 06, 2016

4.1.3 Test Procedure

- a. The EUT was placed on the top of a rotating table 0.8 meters (for below 1GHz) / 1.5 meters (for above 1GHz) above the ground at 3 meter chamber room for test. The table was rotated 360 degrees to determine the position of the highest radiation.
- b. The EUT was set 3 meters away from the interference-receiving antenna, which was mounted on the top of a variable-height antenna tower.
- c. The height of antenna is varied from one meter to four meters above the ground to determine the maximum value of the field strength. Both horizontal and vertical polarizations of the antenna are set to make the measurement.
- d. For each suspected emission, the EUT was arranged to its worst case and then the antenna was tuned to heights from 1 meter to 4 meters and the rotatable table was turned from 0 degrees to 360 degrees to find the maximum reading.
- e. The test-receiver system was set to quasi-peak detect function and specified bandwidth with maximum hold mode when the test frequency is below 1 GHz.
- f. The test-receiver system was set to peak and average detect function and specified bandwidth with maximum hold mode when the test frequency is above 1 GHz. If the peak reading value also meets average limit, measurement with the average detector is unnecessary.

Note:

1. The resolution bandwidth and video bandwidth of test receiver/spectrum analyzer is 120kHz for Quasi-peak detection (QP) at frequency below 1GHz.
2. The resolution bandwidth of test receiver/spectrum analyzer is 1 MHz and the video bandwidth is 3 MHz for Peak detection (PK) at frequency above 1GHz.
3. The resolution bandwidth of test receiver/spectrum analyzer is 1MHz and the video bandwidth is $\geq 1/T$ (Duty cycle < 98%) or 10Hz (Duty cycle $\geq 98\%$) for Average detection (AV) at frequency above 1GHz.
4. All modes of operation were investigated and the worst-case emissions are reported.

4.1.4 Deviation from Test Standard

No deviation.

4.1.5 Test Setup

<Frequency Range below 1GHz>

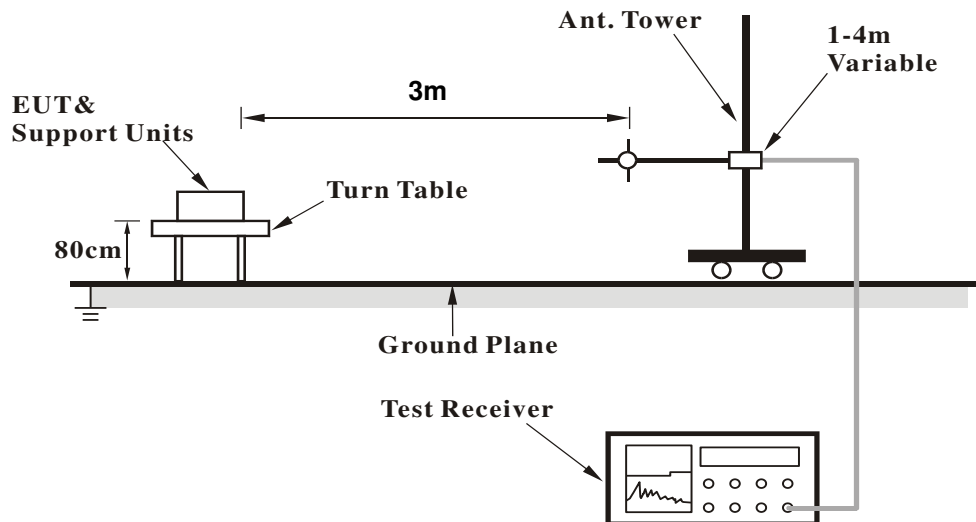

<Frequency Range above 1GHz>

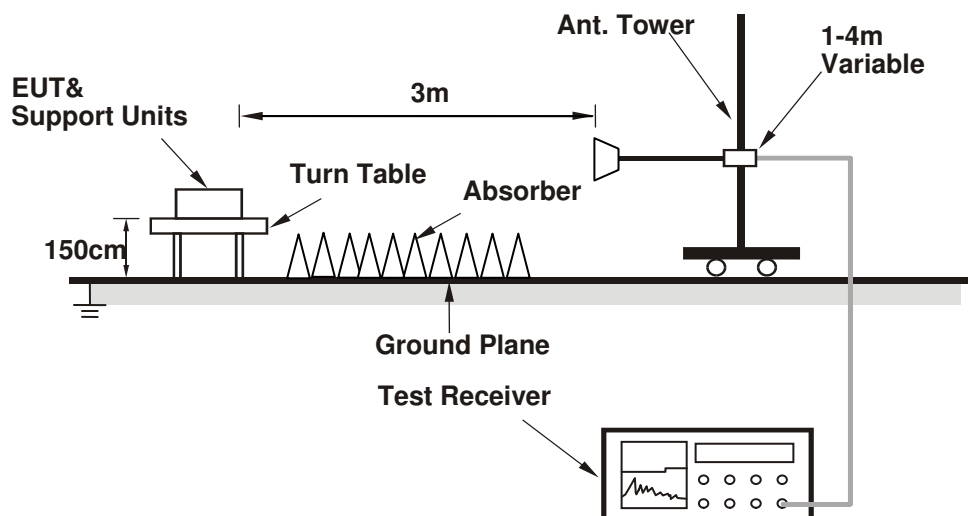

For the actual test configuration, please refer to the attached file (Test Setup Photo).

4.1.6 EUT Operating Condition

- Connect the EUT with the support unit A (Test Tool) and placed them on the testing table..
- The communication partner run test program "HyperTerminal paste Multi-carrier DSP_Tx.txt & Single-carrier DSP command _Tx.txt command" to enable EUT under transmission/receiving condition continuously at specific channel frequency.

4.1.7 Test Results

Above 1GHz Data :

LAA-single carrier

CHANNEL	TX Channel 32	DETECTOR FUNCTION	Peak (PK)
FREQUENCY RANGE	1GHz ~ 40GHz		Average (AV)

ANTENNA POLARITY & TEST DISTANCE: HORIZONTAL AT 3 M

NO.	FREQ. (MHz)	EMISSION LEVEL (dBuV/m)	LIMIT (dBuV/m)	MARGIN (dB)	ANTENNA HEIGHT (m)	TABLE ANGLE (Degree)	RAW VALUE (dBuV)	CORRECTION FACTOR (dB/m)
1	4915.30	53.1 PK	74.0	-20.9	1.70 H	115	52.1	1.0
2	4915.30	42.1 AV	54.0	-11.9	1.70 H	115	41.1	1.0
3	5150.00	52.5 PK	74.0	-21.5	1.14 H	33	51.0	1.5
4	5150.00	49.1 AV	54.0	-4.9	1.14 H	33	47.6	1.5
5	*5160.00	108.1 PK			1.14 H	33	106.6	1.5
6	*5160.00	96.6 AV			1.14 H	33	95.1	1.5
7	5406.00	51.3 PK	74.0	-22.7	1.71 H	50	49.2	2.1
8	5406.00	40.1 AV	54.0	-13.9	1.71 H	50	38.0	2.1
9	#10320.00	49.6 PK	74.0	-24.4	1.75 H	176	38.2	11.4
10	#10320.00	38.2 AV	54.0	-15.8	1.75 H	176	26.8	11.4
11	15480.00	50.7 PK	74.0	-23.3	1.60 H	201	37.4	13.3
12	15480.00	39.6 AV	54.0	-14.4	1.60 H	201	26.3	13.3

ANTENNA POLARITY & TEST DISTANCE: VERTICAL AT 3 M

NO.	FREQ. (MHz)	EMISSION LEVEL (dBuV/m)	LIMIT (dBuV/m)	MARGIN (dB)	ANTENNA HEIGHT (m)	TABLE ANGLE (Degree)	RAW VALUE (dBuV)	CORRECTION FACTOR (dB/m)
1	4915.30	53.7 PK	74.0	-20.3	2.76 V	331	52.7	1.0
2	4915.30	45.8 AV	54.0	-8.2	2.76 V	331	44.8	1.0
3	5150.00	65.3 PK	74.0	-8.7	2.60 V	359	63.8	1.5
4	5150.00	53.1 AV	54.0	-0.9	2.60 V	359	51.6	1.5
5	*5160.00	110.9 PK			2.60 V	359	109.4	1.5
6	*5160.00	98.2 AV			2.60 V	359	96.7	1.5
7	5406.00	52.4 PK	74.0	-21.6	2.75 V	0	50.3	2.1
8	5406.00	43.7 AV	54.0	-10.3	2.75 V	0	41.6	2.1
9	#10320.00	50.1 PK	74.0	-23.9	3.37 V	203	38.7	11.4
10	#10320.00	41.7 AV	54.0	-12.3	3.37 V	203	30.3	11.4
11	15480.00	50.7 PK	74.0	-23.3	2.96 V	192	37.4	13.3
12	15480.00	39.6 AV	54.0	-14.4	2.96 V	192	26.3	13.3

REMARKS:

1. Emission Level(dBuV/m) = Raw Value(dBuV) + Correction Factor(dB/m)
2. Correction Factor(dB/m) = Antenna Factor(dB/m) + Cable Factor(dB) – Pre-Amplifier Factor(dB)
3. The other emission levels were very low against the limit.
4. Margin value = Emission Level – Limit value
5. " * ": Fundamental frequency.
6. " # ": The radiated frequency is out of the restricted band.

CHANNEL	TX Channel 36	DETECTOR FUNCTION	Peak (PK)
FREQUENCY RANGE	1GHz ~ 40GHz		Average (AV)

ANTENNA POLARITY & TEST DISTANCE: HORIZONTAL AT 3 M

NO.	FREQ. (MHz)	EMISSION LEVEL (dBuV/m)	LIMIT (dBuV/m)	MARGIN (dB)	ANTENNA HEIGHT (m)	TABLE ANGLE (Degree)	RAW VALUE (dBuV)	CORRECTION FACTOR (dB/m)
1	4915.30	53.5 PK	74.0	-20.5	2.13 H	121	52.5	1.0
2	4915.30	42.4 AV	54.0	-11.6	2.13 H	121	41.4	1.0
3	5150.00	58.2 PK	74.0	-15.8	2.13 H	121	56.7	1.5
4	5150.00	44.7 AV	54.0	-9.3	2.13 H	121	43.2	1.5
5	*5180.00	115.0 PK			2.13 H	121	113.4	1.6
6	*5180.00	103.5 AV			2.13 H	121	101.9	1.6
7	#10360.00	49.8 PK	74.0	-24.2	1.75 H	165	38.3	11.5
8	#10360.00	38.6 AV	54.0	-15.4	1.75 H	165	27.1	11.5
9	15540.00	51.0 PK	74.0	-23.0	1.65 H	188	37.9	13.1
10	15540.00	39.6 AV	54.0	-14.4	1.65 H	188	26.5	13.1

ANTENNA POLARITY & TEST DISTANCE: VERTICAL AT 3 M

NO.	FREQ. (MHz)	EMISSION LEVEL (dBuV/m)	LIMIT (dBuV/m)	MARGIN (dB)	ANTENNA HEIGHT (m)	TABLE ANGLE (Degree)	RAW VALUE (dBuV)	CORRECTION FACTOR (dB/m)
1	4915.30	54.1 PK	74.0	-19.9	3.64 V	246	53.1	1.0
2	4915.30	48.5 AV	54.0	-5.5	3.64 V	246	47.5	1.0
3	5150.00	58.9 PK	74.0	-15.1	3.61 V	245	57.4	1.5
4	5150.00	47.3 AV	54.0	-6.7	3.61 V	245	45.8	1.5
5	*5180.00	116.7 PK			3.61 V	245	115.1	1.6
6	*5180.00	106.6 AV			3.61 V	245	105.0	1.6
7	#10360.00	50.5 PK	74.0	-23.5	3.37 V	204	39.0	11.5
8	#10360.00	42.0 AV	54.0	-12.0	3.37 V	204	30.5	11.5
9	15540.00	50.8 PK	74.0	-23.2	3.00 V	205	37.7	13.1
10	15540.00	39.7 AV	54.0	-14.3	3.00 V	205	26.6	13.1

REMARKS:

1. Emission Level(dBuV/m) = Raw Value(dBuV) + Correction Factor(dB/m)
2. Correction Factor(dB/m) = Antenna Factor(dB/m) + Cable Factor(dB) – Pre-Amplifier Factor(dB)
3. The other emission levels were very low against the limit.
4. Margin value = Emission Level – Limit value
5. " * ": Fundamental frequency.
6. " # ": The radiated frequency is out of the restricted band.

CHANNEL	TX Channel 40	DETECTOR FUNCTION	Peak (PK)
FREQUENCY RANGE	1GHz ~ 40GHz		Average (AV)

ANTENNA POLARITY & TEST DISTANCE: HORIZONTAL AT 3 M

NO.	FREQ. (MHz)	EMISSION LEVEL (dBuV/m)	LIMIT (dBuV/m)	MARGIN (dB)	ANTENNA HEIGHT (m)	TABLE ANGLE (Degree)	RAW VALUE (dBuV)	CORRECTION FACTOR (dB/m)
1	*5200.00	115.6 PK			2.17 H	134	113.9	1.7
2	*5200.00	104.0 AV			2.17 H	134	102.3	1.7
3	#10400.00	49.5 PK	74.0	-24.5	1.73 H	164	37.9	11.6
4	#10400.00	38.5 AV	54.0	-15.5	1.73 H	164	26.9	11.6
5	15600.00	51.4 PK	74.0	-22.6	1.70 H	201	38.3	13.1
6	15600.00	40.1 AV	54.0	-13.9	1.70 H	201	27.0	13.1

ANTENNA POLARITY & TEST DISTANCE: VERTICAL AT 3 M

NO.	FREQ. (MHz)	EMISSION LEVEL (dBuV/m)	LIMIT (dBuV/m)	MARGIN (dB)	ANTENNA HEIGHT (m)	TABLE ANGLE (Degree)	RAW VALUE (dBuV)	CORRECTION FACTOR (dB/m)
1	*5200.00	117.3 PK			3.57 V	231	115.6	1.7
2	*5200.00	107.1 AV			3.57 V	231	105.4	1.7
3	#10400.00	50.4 PK	74.0	-23.6	3.37 V	211	38.8	11.6
4	#10400.00	42.0 AV	54.0	-12.0	3.37 V	211	30.4	11.6
5	15600.00	50.7 PK	74.0	-23.3	3.05 V	204	37.6	13.1
6	15600.00	39.9 AV	54.0	-14.1	3.05 V	204	26.8	13.1

REMARKS:

1. Emission Level(dBuV/m) = Raw Value(dBuV) + Correction Factor(dB/m)
2. Correction Factor(dB/m) = Antenna Factor(dB/m) + Cable Factor(dB) – Pre-Amplifier Factor(dB)
3. The other emission levels were very low against the limit.
4. Margin value = Emission Level – Limit value
5. " * " : Fundamental frequency.
6. " # " : The radiated frequency is out of the restricted band.

CHANNEL	TX Channel 44	DETECTOR FUNCTION	Peak (PK)
FREQUENCY RANGE	1GHz ~ 40GHz		Average (AV)

ANTENNA POLARITY & TEST DISTANCE: HORIZONTAL AT 3 M

NO.	FREQ. (MHz)	EMISSION LEVEL (dBuV/m)	LIMIT (dBuV/m)	MARGIN (dB)	ANTENNA HEIGHT (m)	TABLE ANGLE (Degree)	RAW VALUE (dBuV)	CORRECTION FACTOR (dB/m)
1	*5220.00	116.7 PK			2.13 H	119	115.0	1.7
2	*5220.00	102.5 AV			2.13 H	119	100.8	1.7
3	5406.00	51.2 PK	74.0	-22.8	2.13 H	119	49.1	2.1
4	5406.00	40.6 AV	54.0	-13.4	2.13 H	119	38.5	2.1
5	#10440.00	49.6 PK	74.0	-24.4	1.77 H	148	37.7	11.9
6	#10440.00	38.4 AV	54.0	-15.6	1.77 H	148	26.5	11.9
7	15660.00	51.5 PK	74.0	-22.5	1.65 H	195	38.2	13.3
8	15660.00	40.1 AV	54.0	-13.9	1.65 H	195	26.8	13.3

ANTENNA POLARITY & TEST DISTANCE: VERTICAL AT 3 M

NO.	FREQ. (MHz)	EMISSION LEVEL (dBuV/m)	LIMIT (dBuV/m)	MARGIN (dB)	ANTENNA HEIGHT (m)	TABLE ANGLE (Degree)	RAW VALUE (dBuV)	CORRECTION FACTOR (dB/m)
1	*5220.00	118.4 PK			1.00 V	250	116.7	1.7
2	*5220.00	105.6 AV			1.00 V	250	103.9	1.7
3	5406.00	55.4 PK	74.0	-18.6	1.00 V	250	53.3	2.1
4	5406.00	46.7 AV	54.0	-7.3	1.00 V	250	44.6	2.1
5	#10440.00	51.1 PK	74.0	-22.9	3.41 V	211	39.2	11.9
6	#10440.00	42.4 AV	54.0	-11.6	3.41 V	211	30.5	11.9
7	15660.00	51.0 PK	74.0	-23.0	3.09 V	208	37.7	13.3
8	15660.00	40.4 AV	54.0	-13.6	3.09 V	208	27.1	13.3

REMARKS:

1. Emission Level(dBuV/m) = Raw Value(dBuV) + Correction Factor(dB/m)
2. Correction Factor(dB/m) = Antenna Factor(dB/m) + Cable Factor(dB) – Pre-Amplifier Factor(dB)
3. The other emission levels were very low against the limit.
4. Margin value = Emission Level – Limit value
5. " * ": Fundamental frequency.
6. " # ": The radiated frequency is out of the restricted band.

CHANNEL	TX Channel 48	DETECTOR FUNCTION	Peak (PK)
FREQUENCY RANGE	1GHz ~ 40GHz		Average (AV)

ANTENNA POLARITY & TEST DISTANCE: HORIZONTAL AT 3 M

NO.	FREQ. (MHz)	EMISSION LEVEL (dBuV/m)	LIMIT (dBuV/m)	MARGIN (dB)	ANTENNA HEIGHT (m)	TABLE ANGLE (Degree)	RAW VALUE (dBuV)	CORRECTION FACTOR (dB/m)
1	*5240.00	115.1 PK			2.16 H	154	113.5	1.6
2	*5240.00	103.7 AV			2.16 H	154	102.1	1.6
3	5350.00	56.4 PK	74.0	-17.6	2.16 H	154	54.5	1.9
4	5350.00	40.5 AV	54.0	-13.5	2.16 H	154	38.6	1.9
5	#10480.00	49.1 PK	74.0	-24.9	1.73 H	144	37.1	12.0
6	#10480.00	38.1 AV	54.0	-15.9	1.73 H	144	26.1	12.0
7	15720.00	51.5 PK	74.0	-22.5	1.64 H	199	38.3	13.2
8	15720.00	40.0 AV	54.0	-14.0	1.64 H	199	26.8	13.2

ANTENNA POLARITY & TEST DISTANCE: VERTICAL AT 3 M

NO.	FREQ. (MHz)	EMISSION LEVEL (dBuV/m)	LIMIT (dBuV/m)	MARGIN (dB)	ANTENNA HEIGHT (m)	TABLE ANGLE (Degree)	RAW VALUE (dBuV)	CORRECTION FACTOR (dB/m)
1	*5240.00	116.8 PK			3.63 V	234	115.2	1.6
2	*5240.00	106.8 AV			3.63 V	234	105.2	1.6
3	5350.00	57.4 PK	74.0	-16.6	3.63 V	234	55.5	1.9
4	5350.00	46.5 AV	54.0	-7.5	3.63 V	234	44.6	1.9
5	#10480.00	50.4 PK	74.0	-23.6	3.38 V	195	38.4	12.0
6	#10480.00	42.2 AV	54.0	-11.8	3.38 V	195	30.2	12.0
7	15720.00	50.2 PK	74.0	-23.8	3.00 V	195	37.0	13.2
8	15720.00	39.7 AV	54.0	-14.3	3.00 V	195	26.5	13.2

REMARKS:

1. Emission Level(dBuV/m) = Raw Value(dBuV) + Correction Factor(dB/m)
2. Correction Factor(dB/m) = Antenna Factor(dB/m) + Cable Factor(dB) – Pre-Amplifier Factor(dB)
3. The other emission levels were very low against the limit.
4. Margin value = Emission Level – Limit value
5. " * ": Fundamental frequency.
6. " # ": The radiated frequency is out of the restricted band.

CHANNEL	TX Channel 149	DETECTOR FUNCTION	Peak (PK)
FREQUENCY RANGE	1GHz ~ 40GHz		Average (AV)

ANTENNA POLARITY & TEST DISTANCE: HORIZONTAL AT 3 M

NO.	FREQ. (MHz)	EMISSION LEVEL (dBuV/m)	LIMIT (dBuV/m)	MARGIN (dB)	ANTENNA HEIGHT (m)	TABLE ANGLE (Degree)	RAW VALUE (dBuV)	CORRECTION FACTOR (dB/m)
1	#5647.85	60.9 PK	68.2	-7.3	1.65 H	234	58.3	2.6
2	*5745.00	111.0 PK			1.65 H	234	108.3	2.7
3	*5745.00	99.8 AV			1.65 H	234	97.1	2.7
4	#5949.00	58.9 PK	68.2	-9.3	1.65 H	234	55.7	3.2
5	11490.00	51.6 PK	74.0	-22.4	1.75 H	177	38.2	13.4
6	11490.00	40.9 AV	54.0	-13.1	1.75 H	177	27.5	13.4
7	#17235.00	56.2 PK	74.0	-17.8	1.60 H	175	37.9	18.3
8	#17235.00	44.1 AV	54.0	-9.9	1.60 H	175	25.8	18.3

ANTENNA POLARITY & TEST DISTANCE: VERTICAL AT 3 M

NO.	FREQ. (MHz)	EMISSION LEVEL (dBuV/m)	LIMIT (dBuV/m)	MARGIN (dB)	ANTENNA HEIGHT (m)	TABLE ANGLE (Degree)	RAW VALUE (dBuV)	CORRECTION FACTOR (dB/m)
1	#5633.12	67.4 PK	68.2	-0.8	2.65 V	5	64.8	2.6
2	*5745.00	117.3 PK			2.68 V	3	114.6	2.7
3	*5745.00	107.2 AV			2.68 V	3	104.5	2.7
4	#5984.62	58.8 PK	68.2	-9.4	2.65 V	5	55.5	3.3
5	11490.00	52.5 PK	74.0	-21.5	3.37 V	209	39.1	13.4
6	11490.00	42.3 AV	54.0	-11.7	3.37 V	209	28.9	13.4
7	#17235.00	56.6 PK	74.0	-17.4	3.00 V	205	38.3	18.3
8	#17235.00	44.2 AV	54.0	-9.8	3.00 V	205	25.9	18.3

REMARKS:

1. Emission Level(dBuV/m) = Raw Value(dBuV) + Correction Factor(dB/m)
2. Correction Factor(dB/m) = Antenna Factor(dB/m) + Cable Factor(dB) – Pre-Amplifier Factor(dB)
3. The other emission levels were very low against the limit.
4. Margin value = Emission Level – Limit value
5. " * ": Fundamental frequency.
6. " # ": The radiated frequency is out of the restricted band.

CHANNEL	TX Channel 153	DETECTOR FUNCTION	Peak (PK)
FREQUENCY RANGE	1GHz ~ 40GHz		Average (AV)

ANTENNA POLARITY & TEST DISTANCE: HORIZONTAL AT 3 M

NO.	FREQ. (MHz)	EMISSION LEVEL (dBuV/m)	LIMIT (dBuV/m)	MARGIN (dB)	ANTENNA HEIGHT (m)	TABLE ANGLE (Degree)	RAW VALUE (dBuV)	CORRECTION FACTOR (dB/m)
1	#5634.55	55.9 PK	68.2	-12.3	1.50 H	360	53.4	2.5
2	*5765.00	113.0 PK			1.50 H	360	110.3	2.7
3	*5765.00	100.8 AV			1.50 H	360	98.1	2.7
4	#5980.82	56.3 PK	68.2	-11.9	1.50 H	360	53.1	3.2
5	11530.00	50.9 PK	74.0	-23.1	1.69 H	191	37.7	13.2
6	11530.00	40.5 AV	54.0	-13.5	1.69 H	191	27.3	13.2
7	#17295.00	56.2 PK	74.0	-17.8	1.60 H	166	37.8	18.4
8	#17295.00	43.8 AV	54.0	-10.2	1.60 H	166	25.4	18.4

ANTENNA POLARITY & TEST DISTANCE: VERTICAL AT 3 M

NO.	FREQ. (MHz)	EMISSION LEVEL (dBuV/m)	LIMIT (dBuV/m)	MARGIN (dB)	ANTENNA HEIGHT (m)	TABLE ANGLE (Degree)	RAW VALUE (dBuV)	CORRECTION FACTOR (dB/m)
1	#5594.65	59.5 PK	68.2	-8.7	3.28 V	35	57.2	2.3
2	*5765.00	122.4 PK			3.28 V	35	119.7	2.7
3	*5765.00	109.9 AV			3.28 V	35	107.2	2.7
4	#5958.98	60.1 PK	68.2	-8.1	3.28 V	35	57.1	3.0
5	11530.00	52.5 PK	74.0	-21.5	3.32 V	221	39.3	13.2
6	11530.00	42.3 AV	54.0	-11.7	3.32 V	221	29.1	13.2
7	#17295.00	56.3 PK	74.0	-17.7	2.96 V	213	37.9	18.4
8	#17295.00	44.1 AV	54.0	-9.9	2.96 V	213	25.7	18.4

REMARKS:

1. Emission Level(dBuV/m) = Raw Value(dBuV) + Correction Factor(dB/m)
2. Correction Factor(dB/m) = Antenna Factor(dB/m) + Cable Factor(dB) – Pre-Amplifier Factor(dB)
3. The other emission levels were very low against the limit.
4. Margin value = Emission Level – Limit value
5. " * ": Fundamental frequency.
6. " # ": The radiated frequency is out of the restricted band.

CHANNEL	TX Channel 157	DETECTOR FUNCTION	Peak (PK)
FREQUENCY RANGE	1GHz ~ 40GHz		Average (AV)

ANTENNA POLARITY & TEST DISTANCE: HORIZONTAL AT 3 M

NO.	FREQ. (MHz)	EMISSION LEVEL (dBuV/m)	LIMIT (dBuV/m)	MARGIN (dB)	ANTENNA HEIGHT (m)	TABLE ANGLE (Degree)	RAW VALUE (dBuV)	CORRECTION FACTOR (dB/m)
1	#5574.70	59.6 PK	68.2	-8.6	1.05 H	120	57.1	2.5
2	*5785.00	115.6 PK			1.05 H	120	112.9	2.7
3	*5785.00	104.0 AV			1.05 H	120	101.3	2.7
4	#5987.00	58.0 PK	68.2	-10.2	1.05 H	120	54.7	3.3
5	11570.00	51.9 PK	74.0	-22.1	1.76 H	161	38.8	13.1
6	11570.00	41.4 AV	54.0	-12.6	1.76 H	161	28.3	13.1
7	#17355.00	56.0 PK	74.0	-18.0	1.58 H	187	37.2	18.8
8	#17355.00	43.9 AV	54.0	-10.1	1.58 H	187	25.1	18.8

ANTENNA POLARITY & TEST DISTANCE: VERTICAL AT 3 M

NO.	FREQ. (MHz)	EMISSION LEVEL (dBuV/m)	LIMIT (dBuV/m)	MARGIN (dB)	ANTENNA HEIGHT (m)	TABLE ANGLE (Degree)	RAW VALUE (dBuV)	CORRECTION FACTOR (dB/m)
1	#5580.87	59.0 PK	68.2	-9.2	2.16 V	360	56.5	2.5
2	*5785.00	120.6 PK			2.16 V	360	117.9	2.7
3	*5785.00	108.9 AV			2.16 V	360	106.2	2.7
4	#5937.12	59.8 PK	68.2	-8.4	2.16 V	360	56.7	3.1
5	11570.00	52.2 PK	74.0	-21.8	3.30 V	225	39.1	13.1
6	11570.00	42.3 AV	54.0	-11.7	3.30 V	225	29.2	13.1
7	#17355.00	56.1 PK	74.0	-17.9	2.90 V	228	37.3	18.8
8	#17355.00	44.2 AV	54.0	-9.8	2.90 V	228	25.4	18.8

REMARKS:

1. Emission Level(dBuV/m) = Raw Value(dBuV) + Correction Factor(dB/m)
2. Correction Factor(dB/m) = Antenna Factor(dB/m) + Cable Factor(dB) – Pre-Amplifier Factor(dB)
3. The other emission levels were very low against the limit.
4. Margin value = Emission Level – Limit value
5. " * ": Fundamental frequency.
6. " # ": The radiated frequency is out of the restricted band.

CHANNEL	TX Channel 161	DETECTOR FUNCTION	Peak (PK)
FREQUENCY RANGE	1GHz ~ 40GHz		Average (AV)

ANTENNA POLARITY & TEST DISTANCE: HORIZONTAL AT 3 M

NO.	FREQ. (MHz)	EMISSION LEVEL (dBuV/m)	LIMIT (dBuV/m)	MARGIN (dB)	ANTENNA HEIGHT (m)	TABLE ANGLE (Degree)	RAW VALUE (dBuV)	CORRECTION FACTOR (dB/m)
1	#5598.93	55.4 PK	68.2	-12.8	1.05 H	120	53.1	2.3
2	*5805.00	113.2 PK			1.05 H	120	110.5	2.7
3	*5805.00	101.2 AV			1.05 H	120	98.5	2.7
4	#5967.05	55.6 PK	68.2	-12.6	1.05 H	120	52.6	3.0
5	11610.00	51.4 PK	74.0	-22.6	1.78 H	163	38.4	13.0
6	11610.00	40.9 AV	54.0	-13.1	1.78 H	163	27.9	13.0
7	#17415.00	55.9 PK	74.0	-18.1	1.56 H	178	36.8	19.1
8	#17415.00	44.0 AV	54.0	-10.0	1.56 H	178	24.9	19.1

ANTENNA POLARITY & TEST DISTANCE: VERTICAL AT 3 M

NO.	FREQ. (MHz)	EMISSION LEVEL (dBuV/m)	LIMIT (dBuV/m)	MARGIN (dB)	ANTENNA HEIGHT (m)	TABLE ANGLE (Degree)	RAW VALUE (dBuV)	CORRECTION FACTOR (dB/m)
1	#5693.93	64.3 PK	100.7	-36.4	2.15 V	72	61.6	2.7
2	*5805.00	120.2 PK			2.15 V	72	117.5	2.7
3	*5805.00	108.2 AV			2.15 V	72	105.5	2.7
4	#5948.05	57.6 PK	68.2	-10.6	2.15 V	72	54.6	3.0
5	11610.00	52.0 PK	74.0	-22.0	3.28 V	228	39.0	13.0
6	11610.00	41.9 AV	54.0	-12.1	3.28 V	228	28.9	13.0
7	#17415.00	55.8 PK	74.0	-18.2	2.96 V	239	36.7	19.1
8	#17415.00	44.0 AV	54.0	-10.0	2.96 V	239	24.9	19.1

REMARKS:

1. Emission Level(dBuV/m) = Raw Value(dBuV) + Correction Factor(dB/m)
2. Correction Factor(dB/m) = Antenna Factor(dB/m) + Cable Factor(dB) – Pre-Amplifier Factor(dB)
3. The other emission levels were very low against the limit.
4. Margin value = Emission Level – Limit value
5. " * ": Fundamental frequency.
6. " # ": The radiated frequency is out of the restricted band.

CHANNEL	TX Channel 165	DETECTOR FUNCTION	Peak (PK)
FREQUENCY RANGE	1GHz ~ 40GHz		Average (AV)

ANTENNA POLARITY & TEST DISTANCE: HORIZONTAL AT 3 M

NO.	FREQ. (MHz)	EMISSION LEVEL (dBuV/m)	LIMIT (dBuV/m)	MARGIN (dB)	ANTENNA HEIGHT (m)	TABLE ANGLE (Degree)	RAW VALUE (dBuV)	CORRECTION FACTOR (dB/m)
1	#5616.98	59.1 PK	68.2	-9.1	1.05 H	120	56.5	2.6
2	*5825.00	114.4 PK			1.05 H	120	111.7	2.7
3	*5825.00	103.3 AV			1.05 H	120	100.6	2.7
4	#5940.45	57.9 PK	68.2	-10.3	1.05 H	120	54.8	3.1
5	11650.00	51.7 PK	74.0	-22.3	1.73 H	167	38.6	13.1
6	11650.00	40.9 AV	54.0	-13.1	1.73 H	167	27.8	13.1
7	#17475.00	56.7 PK	74.0	-17.3	1.60 H	187	37.5	19.2
8	#17475.00	44.4 AV	54.0	-9.6	1.60 H	187	25.2	19.2

ANTENNA POLARITY & TEST DISTANCE: VERTICAL AT 3 M

NO.	FREQ. (MHz)	EMISSION LEVEL (dBuV/m)	LIMIT (dBuV/m)	MARGIN (dB)	ANTENNA HEIGHT (m)	TABLE ANGLE (Degree)	RAW VALUE (dBuV)	CORRECTION FACTOR (dB/m)
1	#5583.73	58.2 PK	68.2	-10.0	2.45 V	360	55.7	2.5
2	*5825.00	120.4 PK			2.46 V	360	117.7	2.7
3	*5825.00	109.0 AV			2.46 V	360	106.3	2.7
4	#5998.87	58.3 PK	68.2	-9.9	2.45 V	360	54.9	3.4
5	11650.00	51.8 PK	74.0	-22.2	3.30 V	217	38.7	13.1
6	11650.00	41.7 AV	54.0	-12.3	3.30 V	217	28.6	13.1
7	#17475.00	55.6 PK	74.0	-18.4	3.00 V	234	36.4	19.2
8	#17475.00	43.6 AV	54.0	-10.4	3.00 V	234	24.4	19.2

REMARKS:

1. Emission Level(dBuV/m) = Raw Value(dBuV) + Correction Factor(dB/m)
2. Correction Factor(dB/m) = Antenna Factor(dB/m) + Cable Factor(dB) – Pre-Amplifier Factor(dB)
3. The other emission levels were very low against the limit.
4. Margin value = Emission Level – Limit value
5. " * ": Fundamental frequency.
6. " # ": The radiated frequency is out of the restricted band.

LAA-2 carriers (CA_46C)

CHANNEL	TX Channel 32+36	DETECTOR FUNCTION	Peak (PK)
FREQUENCY RANGE	1GHz ~ 40GHz		Average (AV)

ANTENNA POLARITY & TEST DISTANCE: HORIZONTAL AT 3 M

NO.	FREQ. (MHz)	EMISSION LEVEL (dBuV/m)	LIMIT (dBuV/m)	MARGIN (dB)	ANTENNA HEIGHT (m)	TABLE ANGLE (Degree)	RAW VALUE (dBuV)	CORRECTION FACTOR (dB/m)
1	4915.00	51.7 PK	74.0	-22.3	2.42 H	229	50.7	1.0
2	4915.00	40.6 AV	54.0	-13.4	2.42 H	229	39.6	1.0
3	5150.00	57.5 PK	74.0	-16.5	2.37 H	235	56.0	1.5
4	5150.00	48.3 AV	54.0	-5.7	2.37 H	235	46.8	1.5
5	*5170.00	105.0 PK			2.37 H	235	103.5	1.5
6	*5170.00	94.4 AV			2.37 H	235	92.9	1.5
7	5406.80	51.0 PK	74.0	-23.0	2.42 H	242	48.9	2.1
8	5406.80	39.9 AV	54.0	-14.1	2.42 H	242	37.8	2.1
9	#10340.00	48.8 PK	74.0	-25.2	2.15 H	27	37.4	11.4
10	#10340.00	37.8 AV	54.0	-16.2	2.15 H	27	26.4	11.4
11	15510.00	47.9 PK	74.0	-26.1	2.05 H	5	34.7	13.2
12	15510.00	37.6 AV	54.0	-16.4	2.05 H	5	24.4	13.2

ANTENNA POLARITY & TEST DISTANCE: VERTICAL AT 3 M

NO.	FREQ. (MHz)	EMISSION LEVEL (dBuV/m)	LIMIT (dBuV/m)	MARGIN (dB)	ANTENNA HEIGHT (m)	TABLE ANGLE (Degree)	RAW VALUE (dBuV)	CORRECTION FACTOR (dB/m)
1	4915.00	52.9 PK	74.0	-21.1	1.59 V	332	51.9	1.0
2	4915.00	44.9 AV	54.0	-9.1	1.59 V	332	43.9	1.0
3	5150.00	62.6 PK	74.0	-11.4	2.30 V	353	61.1	1.5
4	5150.00	53.5 AV	54.0	-0.5	2.30 V	353	52.0	1.5
5	*5170.00	112.7 PK			2.30 V	353	111.2	1.5
6	*5170.00	100.7 AV			2.30 V	353	99.2	1.5
7	5406.80	53.6 PK	74.0	-20.4	2.82 V	336	51.5	2.1
8	5406.80	45.5 AV	54.0	-8.5	2.82 V	336	43.4	2.1
9	#10340.00	51.6 PK	74.0	-22.4	2.16 V	249	40.2	11.4
10	#10340.00	43.0 AV	54.0	-11.0	2.16 V	249	31.6	11.4
11	15510.00	51.4 PK	74.0	-22.6	2.08 V	321	38.2	13.2
12	15510.00	38.9 AV	54.0	-15.1	2.08 V	321	25.7	13.2

REMARKS:

1. Emission Level(dBuV/m) = Raw Value(dBuV) + Correction Factor(dB/m)
2. Correction Factor(dB/m) = Antenna Factor(dB/m) + Cable Factor(dB) – Pre-Amplifier Factor(dB)
3. The other emission levels were very low against the limit.
4. Margin value = Emission Level – Limit value
5. " * ": Fundamental frequency.
6. " # ": The radiated frequency is out of the restricted band.

CHANNEL	TX Channel 36+40	DETECTOR FUNCTION	Peak (PK)
FREQUENCY RANGE	1GHz ~ 40GHz		Average (AV)

ANTENNA POLARITY & TEST DISTANCE: HORIZONTAL AT 3 M

NO.	FREQ. (MHz)	EMISSION LEVEL (dBuV/m)	LIMIT (dBuV/m)	MARGIN (dB)	ANTENNA HEIGHT (m)	TABLE ANGLE (Degree)	RAW VALUE (dBuV)	CORRECTION FACTOR (dB/m)
1	5150.00	62.0 PK	74.0	-12.0	3.00 H	122	60.5	1.5
2	5150.00	50.8 AV	54.0	-3.2	3.00 H	122	49.3	1.5
3	*5190.00	112.4 PK			3.00 H	122	110.7	1.7
4	*5190.00	100.2 AV			3.00 H	122	98.5	1.7
5	5406.80	55.6 PK	74.0	-18.4	3.00 H	122	53.5	2.1
6	5406.80	41.9 AV	54.0	-12.1	3.00 H	122	39.8	2.1
7	#10380.00	48.6 PK	74.0	-25.4	2.14 H	15	37.1	11.5
8	#10380.00	37.7 AV	54.0	-16.3	2.14 H	15	26.2	11.5
9	15570.00	48.5 PK	74.0	-25.5	2.03 H	11	35.4	13.1
10	15570.00	38.2 AV	54.0	-15.8	2.03 H	11	25.1	13.1

ANTENNA POLARITY & TEST DISTANCE: VERTICAL AT 3 M

NO.	FREQ. (MHz)	EMISSION LEVEL (dBuV/m)	LIMIT (dBuV/m)	MARGIN (dB)	ANTENNA HEIGHT (m)	TABLE ANGLE (Degree)	RAW VALUE (dBuV)	CORRECTION FACTOR (dB/m)
1	5150.00	68.7 PK	74.0	-5.3	3.80 V	69	67.2	1.5
2	5150.00	53.9 AV	54.0	-0.1	3.80 V	69	52.4	1.5
3	*5190.00	117.4 PK			3.80 V	69	115.7	1.7
4	*5190.00	104.7 AV			3.80 V	69	103.0	1.7
5	5406.80	58.9 PK	74.0	-15.1	3.80 V	69	56.8	2.1
6	5406.80	45.3 AV	54.0	-8.7	3.80 V	69	43.2	2.1
7	#10380.00	51.4 PK	74.0	-22.6	2.20 V	262	39.9	11.5
8	#10380.00	42.7 AV	54.0	-11.3	2.20 V	262	31.2	11.5
9	15570.00	51.5 PK	74.0	-22.5	2.07 V	336	38.4	13.1
10	15570.00	39.2 AV	54.0	-14.8	2.07 V	336	26.1	13.1

REMARKS:

- Emission Level(dBuV/m) = Raw Value(dBuV) + Correction Factor(dB/m)
- Correction Factor(dB/m) = Antenna Factor(dB/m) + Cable Factor(dB) – Pre-Amplifier Factor(dB)
- The other emission levels were very low against the limit.
- Margin value = Emission Level – Limit value
- " * ": Fundamental frequency.
- " # ": The radiated frequency is out of the restricted band.

CHANNEL	TX Channel 40+44	DETECTOR FUNCTION	Peak (PK)
FREQUENCY RANGE	1GHz ~ 40GHz		Average (AV)

ANTENNA POLARITY & TEST DISTANCE: HORIZONTAL AT 3 M

NO.	FREQ. (MHz)	EMISSION LEVEL (dBuV/m)	LIMIT (dBuV/m)	MARGIN (dB)	ANTENNA HEIGHT (m)	TABLE ANGLE (Degree)	RAW VALUE (dBuV)	CORRECTION FACTOR (dB/m)
1	5150.00	56.1 PK	74.0	-17.9	2.99 H	137	54.6	1.5
2	5150.00	47.5 AV	54.0	-6.5	2.99 H	137	46.0	1.5
3	*5210.00	114.1 PK			2.99 H	137	112.4	1.7
4	*5210.00	101.7 AV			2.99 H	137	100.0	1.7
5	5350.00	59.0 PK	74.0	-15.0	2.99 H	137	57.1	1.9
6	5350.00	49.4 AV	54.0	-4.6	2.99 H	137	47.5	1.9
7	#10420.00	48.5 PK	74.0	-25.5	2.16 H	30	36.8	11.7
8	#10420.00	37.8 AV	54.0	-16.2	2.16 H	30	26.1	11.7
9	15630.00	48.5 PK	74.0	-25.5	2.00 H	22	35.3	13.2
10	15630.00	38.4 AV	54.0	-15.6	2.00 H	22	25.2	13.2

ANTENNA POLARITY & TEST DISTANCE: VERTICAL AT 3 M

NO.	FREQ. (MHz)	EMISSION LEVEL (dBuV/m)	LIMIT (dBuV/m)	MARGIN (dB)	ANTENNA HEIGHT (m)	TABLE ANGLE (Degree)	RAW VALUE (dBuV)	CORRECTION FACTOR (dB/m)
1	5150.00	62.4 PK	74.0	-11.6	2.20 V	104	60.9	1.5
2	5150.00	50.6 AV	54.0	-3.4	2.20 V	104	49.1	1.5
3	*5210.00	119.1 PK			2.20 V	104	117.4	1.7
4	*5210.00	106.2 AV			2.20 V	104	104.5	1.7
5	5350.00	64.3 PK	74.0	-9.7	2.20 V	104	62.4	1.9
6	5350.00	52.4 AV	54.0	-1.6	2.20 V	104	50.5	1.9
7	#10420.00	51.5 PK	74.0	-22.5	2.15 V	274	39.8	11.7
8	#10420.00	42.5 AV	54.0	-11.5	2.15 V	274	30.8	11.7
9	15630.00	51.4 PK	74.0	-22.6	2.09 V	329	38.2	13.2
10	15630.00	38.9 AV	54.0	-15.1	2.09 V	329	25.7	13.2

REMARKS:

1. Emission Level(dBuV/m) = Raw Value(dBuV) + Correction Factor(dB/m)
2. Correction Factor(dB/m) = Antenna Factor(dB/m) + Cable Factor(dB) – Pre-Amplifier Factor(dB)
3. The other emission levels were very low against the limit.
4. Margin value = Emission Level – Limit value
5. " * ": Fundamental frequency.
6. " # ": The radiated frequency is out of the restricted band.

CHANNEL	TX Channel 44+48	DETECTOR FUNCTION	Peak (PK)
FREQUENCY RANGE	1GHz ~ 40GHz		Average (AV)

ANTENNA POLARITY & TEST DISTANCE: HORIZONTAL AT 3 M

NO.	FREQ. (MHz)	EMISSION LEVEL (dBuV/m)	LIMIT (dBuV/m)	MARGIN (dB)	ANTENNA HEIGHT (m)	TABLE ANGLE (Degree)	RAW VALUE (dBuV)	CORRECTION FACTOR (dB/m)
1	*5230.00	113.1 PK			2.95 H	136	111.5	1.6
2	*5230.00	101.7 AV			2.95 H	136	100.1	1.6
3	5350.00	59.3 PK	74.0	-14.7	2.95 H	136	57.4	1.9
4	5350.00	44.3 AV	54.0	-9.7	2.95 H	136	42.4	1.9
5	#10460.00	48.3 PK	74.0	-25.7	2.12 H	16	36.4	11.9
6	#10460.00	37.6 AV	54.0	-16.4	2.12 H	16	25.7	11.9
7	15690.00	48.7 PK	74.0	-25.3	1.97 H	38	35.4	13.3
8	15690.00	38.6 AV	54.0	-15.4	1.97 H	38	25.3	13.3

ANTENNA POLARITY & TEST DISTANCE: VERTICAL AT 3 M

NO.	FREQ. (MHz)	EMISSION LEVEL (dBuV/m)	LIMIT (dBuV/m)	MARGIN (dB)	ANTENNA HEIGHT (m)	TABLE ANGLE (Degree)	RAW VALUE (dBuV)	CORRECTION FACTOR (dB/m)
1	*5230.00	118.1 PK			2.19 V	91	116.5	1.6
2	*5230.00	106.2 AV			2.19 V	91	104.6	1.6
3	5350.00	65.6 PK	74.0	-8.4	2.19 V	91	63.7	1.9
4	5350.00	47.4 AV	54.0	-6.6	2.19 V	91	45.5	1.9
5	#10460.00	51.2 PK	74.0	-22.8	2.12 V	276	39.3	11.9
6	#10460.00	42.3 AV	54.0	-11.7	2.12 V	276	30.4	11.9
7	15690.00	51.8 PK	74.0	-22.2	2.04 V	317	38.5	13.3
8	15690.00	39.0 AV	54.0	-15.0	2.04 V	317	25.7	13.3

REMARKS:

1. Emission Level(dBuV/m) = Raw Value(dBuV) + Correction Factor(dB/m)
2. Correction Factor(dB/m) = Antenna Factor(dB/m) + Cable Factor(dB) – Pre-Amplifier Factor(dB)
3. The other emission levels were very low against the limit.
4. Margin value = Emission Level – Limit value
5. " * ": Fundamental frequency.
6. " # ": The radiated frequency is out of the restricted band.

CHANNEL	TX Channel 149+153	DETECTOR FUNCTION	Peak (PK)
FREQUENCY RANGE	1GHz ~ 40GHz		Average (AV)

ANTENNA POLARITY & TEST DISTANCE: HORIZONTAL AT 3 M

NO.	FREQ. (MHz)	EMISSION LEVEL (dBuV/m)	LIMIT (dBuV/m)	MARGIN (dB)	ANTENNA HEIGHT (m)	TABLE ANGLE (Degree)	RAW VALUE (dBuV)	CORRECTION FACTOR (dB/m)
1	#5603.20	57.0 PK	68.2	-11.2	1.02 H	161	54.5	2.5
2	*5755.00	106.7 PK			1.02 H	161	104.0	2.7
3	*5755.00	95.5 AV			1.02 H	161	92.8	2.7
4	#5926.20	58.1 PK	68.2	-10.1	1.02 H	161	55.0	3.1
5	11510.00	48.4 PK	74.0	-25.6	2.16 H	28	35.0	13.4
6	11510.00	37.5 AV	54.0	-16.5	2.16 H	28	24.1	13.4
7	#17265.00	49.1 PK	74.0	-24.9	1.99 H	42	30.8	18.3
8	#17265.00	38.9 AV	54.0	-15.1	1.99 H	42	20.6	18.3

ANTENNA POLARITY & TEST DISTANCE: VERTICAL AT 3 M

NO.	FREQ. (MHz)	EMISSION LEVEL (dBuV/m)	LIMIT (dBuV/m)	MARGIN (dB)	ANTENNA HEIGHT (m)	TABLE ANGLE (Degree)	RAW VALUE (dBuV)	CORRECTION FACTOR (dB/m)
1	#5648.80	60.9 PK	68.2	-7.3	2.47 V	69	58.3	2.6
2	*5755.00	118.3 PK			2.47 V	69	115.6	2.7
3	*5755.00	106.3 AV			2.47 V	69	103.6	2.7
4	#5943.30	57.4 PK	68.2	-10.8	2.47 V	69	54.3	3.1
5	11510.00	51.1 PK	74.0	-22.9	2.08 V	267	37.7	13.4
6	11510.00	42.5 AV	54.0	-11.5	2.08 V	267	29.1	13.4
7	#17265.00	51.8 PK	74.0	-22.2	2.02 V	328	33.5	18.3
8	#17265.00	38.8 AV	54.0	-15.2	2.02 V	328	20.5	18.3

REMARKS:

1. Emission Level(dBuV/m) = Raw Value(dBuV) + Correction Factor(dB/m)
2. Correction Factor(dB/m) = Antenna Factor(dB/m) + Cable Factor(dB) – Pre-Amplifier Factor(dB)
3. The other emission levels were very low against the limit.
4. Margin value = Emission Level – Limit value
5. " * ": Fundamental frequency.
6. " # ": The radiated frequency is out of the restricted band.

CHANNEL	TX Channel 153+157	DETECTOR FUNCTION	Peak (PK)
FREQUENCY RANGE	1GHz ~ 40GHz		Average (AV)

ANTENNA POLARITY & TEST DISTANCE: HORIZONTAL AT 3 M

NO.	FREQ. (MHz)	EMISSION LEVEL (dBuV/m)	LIMIT (dBuV/m)	MARGIN (dB)	ANTENNA HEIGHT (m)	TABLE ANGLE (Degree)	RAW VALUE (dBuV)	CORRECTION FACTOR (dB/m)
1	#5588.95	56.8 PK	68.2	-11.4	1.25 H	108	54.5	2.3
2	*5775.00	112.8 PK			1.25 H	108	110.1	2.7
3	*5775.00	100.1 AV			1.25 H	108	97.4	2.7
4	#5975.60	56.5 PK	68.2	-11.7	1.25 H	108	53.4	3.1
5	11550.00	49.2 PK	74.0	-24.8	2.18 H	28	36.0	13.2
6	11550.00	38.0 AV	54.0	-16.0	2.18 H	28	24.8	13.2
7	#17325.00	49.3 PK	74.0	-24.7	1.96 H	48	30.7	18.6
8	#17325.00	39.3 AV	54.0	-14.7	1.96 H	48	20.7	18.6

ANTENNA POLARITY & TEST DISTANCE: VERTICAL AT 3 M

NO.	FREQ. (MHz)	EMISSION LEVEL (dBuV/m)	LIMIT (dBuV/m)	MARGIN (dB)	ANTENNA HEIGHT (m)	TABLE ANGLE (Degree)	RAW VALUE (dBuV)	CORRECTION FACTOR (dB/m)
1	#5662.57	62.3 PK	77.5	-15.2	4.00 V	324	59.8	2.5
2	*5775.00	118.2 PK			4.00 V	324	115.5	2.7
3	*5775.00	106.2 AV			4.00 V	324	103.5	2.7
4	#5916.70	57.6 PK	74.3	-16.7	4.00 V	324	54.7	2.9
5	11550.00	51.2 PK	74.0	-22.8	2.10 V	281	38.0	13.2
6	11550.00	42.6 AV	54.0	-11.4	2.10 V	281	29.4	13.2
7	#17325.00	52.3 PK	74.0	-21.7	2.01 V	326	33.7	18.6
8	#17325.00	39.2 AV	54.0	-14.8	2.01 V	326	20.6	18.6

REMARKS:

1. Emission Level(dBuV/m) = Raw Value(dBuV) + Correction Factor(dB/m)
2. Correction Factor(dB/m) = Antenna Factor(dB/m) + Cable Factor(dB) – Pre-Amplifier Factor(dB)
3. The other emission levels were very low against the limit.
4. Margin value = Emission Level – Limit value
5. " * ": Fundamental frequency.
6. " # ": The radiated frequency is out of the restricted band.

CHANNEL	TX Channel 157+161	DETECTOR FUNCTION	Peak (PK)
FREQUENCY RANGE	1GHz ~ 40GHz		Average (AV)

ANTENNA POLARITY & TEST DISTANCE: HORIZONTAL AT 3 M

NO.	FREQ. (MHz)	EMISSION LEVEL (dBuV/m)	LIMIT (dBuV/m)	MARGIN (dB)	ANTENNA HEIGHT (m)	TABLE ANGLE (Degree)	RAW VALUE (dBuV)	CORRECTION FACTOR (dB/m)
1	#5620.30	57.4 PK	68.2	-10.8	1.02 H	146	54.8	2.6
2	*5795.00	106.7 PK			1.02 H	146	104.0	2.7
3	*5795.00	95.1 AV			1.02 H	146	92.4	2.7
4	#5944.25	57.6 PK	68.2	-10.6	1.02 H	146	54.5	3.1
5	11590.00	48.8 PK	74.0	-25.2	2.20 H	25	35.8	13.0
6	11590.00	37.7 AV	54.0	-16.3	2.20 H	25	24.7	13.0
7	#17385.00	49.3 PK	74.0	-24.7	1.90 H	50	30.3	19.0
8	#17385.00	39.2 AV	54.0	-14.8	1.90 H	50	20.2	19.0

ANTENNA POLARITY & TEST DISTANCE: VERTICAL AT 3 M

NO.	FREQ. (MHz)	EMISSION LEVEL (dBuV/m)	LIMIT (dBuV/m)	MARGIN (dB)	ANTENNA HEIGHT (m)	TABLE ANGLE (Degree)	RAW VALUE (dBuV)	CORRECTION FACTOR (dB/m)
1	#5611.75	59.2 PK	68.2	-9.0	2.53 V	68	56.6	2.6
2	*5795.00	118.1 PK			2.53 V	68	115.4	2.7
3	*5795.00	106.0 AV			2.53 V	68	103.3	2.7
4	#5927.62	62.7 PK	68.2	-5.5	2.53 V	68	59.6	3.1
5	11590.00	51.3 PK	74.0	-22.7	2.13 V	269	38.3	13.0
6	11590.00	42.8 AV	54.0	-11.2	2.13 V	269	29.8	13.0
7	#17385.00	52.4 PK	74.0	-21.6	1.99 V	323	33.4	19.0
8	#17385.00	39.3 AV	54.0	-14.7	1.99 V	323	20.3	19.0

REMARKS:

1. Emission Level(dBuV/m) = Raw Value(dBuV) + Correction Factor(dB/m)
2. Correction Factor(dB/m) = Antenna Factor(dB/m) + Cable Factor(dB) – Pre-Amplifier Factor(dB)
3. The other emission levels were very low against the limit.
4. Margin value = Emission Level – Limit value
5. " * ": Fundamental frequency.
6. " # ": The radiated frequency is out of the restricted band.

CHANNEL	TX Channel 161+165	DETECTOR FUNCTION	Peak (PK)
FREQUENCY RANGE	1GHz ~ 40GHz		Average (AV)

ANTENNA POLARITY & TEST DISTANCE: HORIZONTAL AT 3 M

NO.	FREQ. (MHz)	EMISSION LEVEL (dBuV/m)	LIMIT (dBuV/m)	MARGIN (dB)	ANTENNA HEIGHT (m)	TABLE ANGLE (Degree)	RAW VALUE (dBuV)	CORRECTION FACTOR (dB/m)
1	#5568.52	57.4 PK	68.2	-10.8	1.00 H	162	54.9	2.5
2	*5815.00	107.0 PK			1.00 H	162	104.3	2.7
3	*5815.00	95.7 AV			1.00 H	162	93.0	2.7
4	#5930.00	63.5 PK	68.2	-4.7	1.00 H	162	60.4	3.1
5	11630.00	48.9 PK	74.0	-25.1	2.15 H	22	35.8	13.1
6	11630.00	37.6 AV	54.0	-16.4	2.15 H	22	24.5	13.1
7	#17445.00	48.8 PK	74.0	-25.2	1.85 H	60	29.6	19.2
8	#17445.00	38.8 AV	54.0	-15.2	1.85 H	60	19.6	19.2

ANTENNA POLARITY & TEST DISTANCE: VERTICAL AT 3 M

NO.	FREQ. (MHz)	EMISSION LEVEL (dBuV/m)	LIMIT (dBuV/m)	MARGIN (dB)	ANTENNA HEIGHT (m)	TABLE ANGLE (Degree)	RAW VALUE (dBuV)	CORRECTION FACTOR (dB/m)
1	#5639.77	62.7 PK	68.2	-5.5	2.43 V	63	60.1	2.6
2	*5815.00	118.3 PK			2.43 V	63	115.6	2.7
3	*5815.00	106.4 AV			2.43 V	63	103.7	2.7
4	#5940.45	68.0 PK	68.2	-0.2	2.43 V	63	64.9	3.1
5	11630.00	51.0 PK	74.0	-23.0	2.16 V	266	37.9	13.1
6	11630.00	42.5 AV	54.0	-11.5	2.16 V	266	29.4	13.1
7	#17445.00	52.3 PK	74.0	-21.7	1.99 V	312	33.1	19.2
8	#17445.00	39.3 AV	54.0	-14.7	1.99 V	312	20.1	19.2

REMARKS:

1. Emission Level(dBuV/m) = Raw Value(dBuV) + Correction Factor(dB/m)
2. Correction Factor(dB/m) = Antenna Factor(dB/m) + Cable Factor(dB) – Pre-Amplifier Factor(dB)
3. The other emission levels were very low against the limit.
4. Margin value = Emission Level – Limit value
5. " * ": Fundamental frequency.
6. " # ": The radiated frequency is out of the restricted band.

LAA-2 carriers (CA_46A-46A)

CHANNEL	TX Channel 32+40	DETECTOR FUNCTION	Peak (PK)
FREQUENCY RANGE	1GHz ~ 40GHz		Average (AV)

ANTENNA POLARITY & TEST DISTANCE: HORIZONTAL AT 3 M

NO.	FREQ. (MHz)	EMISSION LEVEL (dBuV/m)	LIMIT (dBuV/m)	MARGIN (dB)	ANTENNA HEIGHT (m)	TABLE ANGLE (Degree)	RAW VALUE (dBuV)	CORRECTION FACTOR (dB/m)
1	5150.00	56.8 PK	74.0	-17.2	1.16 H	234	55.3	1.5
2	5150.00	47.9 AV	54.0	-6.1	1.16 H	234	46.4	1.5
3	*5160.00	106.4 PK			1.16 H	234	104.9	1.5
4	*5160.00	94.2 AV			1.16 H	234	92.7	1.5
5	*5200.00	105.5 PK			1.16 H	234	103.8	1.7
6	*5200.00	95.1 AV			1.16 H	234	93.4	1.7
7	5406.80	51.1 PK	74.0	-22.9	2.40 H	255	49.0	2.1
8	5406.80	39.8 AV	54.0	-14.2	2.40 H	255	37.7	2.1
9	#10320.00	48.0 PK	74.0	-26.0	2.15 H	21	36.6	11.4
10	#10320.00	37.3 AV	54.0	-16.7	2.15 H	21	25.9	11.4
11	#10400.00	51.1 PK	74.0	-22.9	2.18 H	248	39.5	11.6
12	#10400.00	42.8 AV	54.0	-11.2	2.18 H	248	31.2	11.6
13	15480.00	47.6 PK	74.0	-26.4	2.10 H	1	34.3	13.3
14	15480.00	37.4 AV	54.0	-16.6	2.10 H	1	24.1	13.3
15	15600.00	51.4 PK	74.0	-22.6	2.07 H	311	38.3	13.1
16	15600.00	39.1 AV	54.0	-14.9	2.07 H	311	26.0	13.1

ANTENNA POLARITY & TEST DISTANCE: VERTICAL AT 3 M

NO.	FREQ. (MHz)	EMISSION LEVEL (dBuV/m)	LIMIT (dBuV/m)	MARGIN (dB)	ANTENNA HEIGHT (m)	TABLE ANGLE (Degree)	RAW VALUE (dBuV)	CORRECTION FACTOR (dB/m)
1	5150.00	63.5 PK	74.0	-10.5	2.59 V	355	62.0	1.5
2	5150.00	53.4 AV	54.0	-0.6	2.59 V	355	51.9	1.5
3	*5160.00	112.3 PK			2.59 V	355	110.8	1.5
4	*5160.00	99.7 AV			2.59 V	355	98.2	1.5
5	*5200.00	112.4 PK			2.59 V	355	110.7	1.7
6	*5200.00	100.9 AV			2.59 V	355	99.2	1.7
7	5406.80	54.8 PK	74.0	-19.2	2.70 V	336	52.7	2.1
8	5406.80	47.3 AV	54.0	-6.7	2.70 V	336	45.2	2.1
9	#10320.00	51.5 PK	74.0	-22.5	2.19 V	251	40.1	11.4
10	#10320.00	43.1 AV	54.0	-10.9	2.19 V	251	31.7	11.4
11	#10400.00	48.4 PK	74.0	-25.6	2.11 V	8	36.8	11.6
12	#10400.00	37.8 AV	54.0	-16.2	2.11 V	8	26.2	11.6
13	15480.00	51.3 PK	74.0	-22.7	2.05 V	308	38.0	13.3
14	15480.00	38.8 AV	54.0	-15.2	2.05 V	308	25.5	13.3
15	15600.00	48.2 PK	74.0	-25.8	2.05 V	11	35.1	13.1
16	15600.00	37.8 AV	54.0	-16.2	2.05 V	11	24.7	13.1

REMARKS:

1. Emission Level(dBuV/m) = Raw Value(dBuV) + Correction Factor(dB/m)
2. Correction Factor(dB/m) = Antenna Factor(dB/m) + Cable Factor(dB) – Pre-Amplifier Factor(dB)
3. The other emission levels were very low against the limit.
4. Margin value = Emission Level – Limit value
5. " * ": Fundamental frequency.
6. " # ": The radiated frequency is out of the restricted band.

CHANNEL	TX Channel 36+44	DETECTOR FUNCTION	Peak (PK)
FREQUENCY RANGE	1GHz ~ 40GHz		Average (AV)

ANTENNA POLARITY & TEST DISTANCE: HORIZONTAL AT 3 M

NO.	FREQ. (MHz)	EMISSION LEVEL (dBuV/m)	LIMIT (dBuV/m)	MARGIN (dB)	ANTENNA HEIGHT (m)	TABLE ANGLE (Degree)	RAW VALUE (dBuV)	CORRECTION FACTOR (dB/m)
1	5148.00	59.9 PK	74.0	-14.1	1.97 H	351	58.4	1.5
2	5148.00	50.8 AV	54.0	-3.2	1.97 H	351	49.3	1.5
3	*5180.00	108.2 PK			1.97 H	351	106.6	1.6
4	*5180.00	96.5 AV			1.97 H	351	94.9	1.6
5	*5220.00	108.6 PK			1.97 H	351	106.9	1.7
6	*5220.00	97.2 AV			1.97 H	351	95.5	1.7
7	5388.00	51.3 PK	74.0	-22.7	1.97 H	351	49.2	2.1
8	5388.00	42.1 AV	54.0	-11.9	1.97 H	351	40.0	2.1
9	#10360.00	48.8 PK	74.0	-25.2	2.10 H	35	37.3	11.5
10	#10360.00	37.6 AV	54.0	-16.4	2.10 H	35	26.1	11.5
11	#10440.00	49.0 PK	74.0	-25.0	2.06 H	23	37.1	11.9
12	#10440.00	38.1 AV	54.0	-15.9	2.06 H	23	26.2	11.9
13	15540.00	48.1 PK	74.0	-25.9	1.83 H	68	35.0	13.1
14	15540.00	38.1 AV	54.0	-15.9	1.83 H	68	25.0	13.1
15	15660.00	47.9 PK	74.0	-26.1	1.86 H	73	34.6	13.3
16	15660.00	37.8 AV	54.0	-16.2	1.86 H	73	24.5	13.3

ANTENNA POLARITY & TEST DISTANCE: VERTICAL AT 3 M

NO.	FREQ. (MHz)	EMISSION LEVEL (dBuV/m)	LIMIT (dBuV/m)	MARGIN (dB)	ANTENNA HEIGHT (m)	TABLE ANGLE (Degree)	RAW VALUE (dBuV)	CORRECTION FACTOR (dB/m)
1	5148.00	66.1 PK	74.0	-7.9	1.01 V	70	64.6	1.5
2	5148.00	53.9 AV	54.0	-0.1	1.01 V	70	52.4	1.5
3	*5180.00	113.2 PK			1.01 V	70	111.6	1.6
4	*5180.00	101.0 AV			1.01 V	70	99.4	1.6
5	*5220.00	113.4 PK			1.01 V	70	111.7	1.7
6	*5220.00	101.6 AV			1.01 V	70	99.9	1.7
7	5388.00	57.4 PK	74.0	-16.6	1.01 V	70	55.3	2.1
8	5388.00	45.2 AV	54.0	-8.8	1.01 V	70	43.1	2.1
9	#10360.00	51.3 PK	74.0	-22.7	2.23 V	265	39.8	11.5
10	#10360.00	41.9 AV	54.0	-12.1	2.23 V	265	30.4	11.5
11	#10440.00	51.7 PK	74.0	-22.3	2.18 V	273	39.8	11.9
12	#10440.00	42.8 AV	54.0	-11.2	2.18 V	273	30.9	11.9
13	15540.00	52.0 PK	74.0	-22.0	2.01 V	323	38.9	13.1
14	15540.00	39.1 AV	54.0	-14.9	2.01 V	323	26.0	13.1
15	15660.00	51.8 PK	74.0	-22.2	2.07 V	316	38.5	13.3
16	15660.00	39.4 AV	54.0	-14.6	2.07 V	316	26.1	13.3

REMARKS:

1. Emission Level(dBuV/m) = Raw Value(dBuV) + Correction Factor(dB/m)
2. Correction Factor(dB/m) = Antenna Factor(dB/m) + Cable Factor(dB) – Pre-Amplifier Factor(dB)
3. The other emission levels were very low against the limit.
4. Margin value = Emission Level – Limit value
5. " * ": Fundamental frequency.
6. " # ": The radiated frequency is out of the restricted band.

CHANNEL	TX Channel 40+48	DETECTOR FUNCTION	Peak (PK)
FREQUENCY RANGE	1GHz ~ 40GHz		Average (AV)

ANTENNA POLARITY & TEST DISTANCE: HORIZONTAL AT 3 M

NO.	FREQ. (MHz)	EMISSION LEVEL (dBuV/m)	LIMIT (dBuV/m)	MARGIN (dB)	ANTENNA HEIGHT (m)	TABLE ANGLE (Degree)	RAW VALUE (dBuV)	CORRECTION FACTOR (dB/m)
1	5150.00	63.3 PK	74.0	-10.7	1.93 H	360	61.8	1.5
2	5150.00	50.1 AV	54.0	-3.9	1.93 H	360	48.6	1.5
3	*5200.00	111.4 PK			1.93 H	360	109.7	1.7
4	*5200.00	99.8 AV			1.93 H	360	98.1	1.7
5	*5240.00	110.8 PK			1.93 H	360	109.2	1.6
6	*5240.00	99.9 AV			1.93 H	360	98.3	1.6
7	5406.00	53.4 PK	74.0	-20.6	1.93 H	360	51.3	2.1
8	5406.00	44.9 AV	54.0	-9.1	1.93 H	360	42.8	2.1
9	#10400.00	49.4 PK	74.0	-24.6	2.08 H	37	37.8	11.6
10	#10400.00	38.0 AV	54.0	-16.0	2.08 H	37	26.4	11.6
11	#10480.00	49.9 PK	74.0	-24.1	2.11 H	27	37.9	12.0
12	#10480.00	38.4 AV	54.0	-15.6	2.11 H	27	26.4	12.0
13	15600.00	48.5 PK	74.0	-25.5	1.78 H	53	35.4	13.1
14	15600.00	38.3 AV	54.0	-15.7	1.78 H	53	25.2	13.1
15	15720.00	48.8 PK	74.0	-25.2	1.80 H	37	35.6	13.2
16	15720.00	38.6 AV	54.0	-15.4	1.80 H	37	25.4	13.2

ANTENNA POLARITY & TEST DISTANCE: VERTICAL AT 3 M

NO.	FREQ. (MHz)	EMISSION LEVEL (dBuV/m)	LIMIT (dBuV/m)	MARGIN (dB)	ANTENNA HEIGHT (m)	TABLE ANGLE (Degree)	RAW VALUE (dBuV)	CORRECTION FACTOR (dB/m)
1	5150.00	69.6 PK	74.0	-4.4	2.17 V	101	68.1	1.5
2	5150.00	53.4 AV	54.0	-0.6	2.17 V	101	51.9	1.5
3	*5200.00	116.4 PK			2.17 V	101	114.7	1.7
4	*5200.00	104.2 AV			2.17 V	101	102.5	1.7
5	*5240.00	115.8 PK			2.17 V	101	114.2	1.6
6	*5240.00	104.2 AV			2.17 V	101	102.6	1.6
7	5406.00	59.2 PK	74.0	-14.8	2.30 V	62	57.1	2.1
8	5406.00	47.9 AV	54.0	-6.1	2.30 V	62	45.8	2.1
9	#10400.00	51.5 PK	74.0	-22.5	2.18 V	264	39.9	11.6
10	#10400.00	42.4 AV	54.0	-11.6	2.18 V	264	30.8	11.6
11	#10480.00	51.5 PK	74.0	-22.5	2.14 V	261	39.5	12.0
12	#10480.00	42.7 AV	54.0	-11.3	2.14 V	261	30.7	12.0
13	15600.00	52.2 PK	74.0	-21.8	2.05 V	307	39.1	13.1
14	15600.00	39.2 AV	54.0	-14.8	2.05 V	307	26.1	13.1
15	15720.00	51.8 PK	74.0	-22.2	2.07 V	320	38.6	13.2
16	15720.00	39.2 AV	54.0	-14.8	2.07 V	320	26.0	13.2

REMARKS:

1. Emission Level(dBuV/m) = Raw Value(dBuV) + Correction Factor(dB/m)
2. Correction Factor(dB/m) = Antenna Factor(dB/m) + Cable Factor(dB) – Pre-Amplifier Factor(dB)
3. The other emission levels were very low against the limit.
4. Margin value = Emission Level – Limit value
5. " * ": Fundamental frequency.
6. " # ": The radiated frequency is out of the restricted band.

CHANNEL	TX Channel 149+157	DETECTOR FUNCTION	Peak (PK)
FREQUENCY RANGE	1GHz ~ 40GHz		Average (AV)

ANTENNA POLARITY & TEST DISTANCE: HORIZONTAL AT 3 M

NO.	FREQ. (MHz)	EMISSION LEVEL (dBuV/m)	LIMIT (dBuV/m)	MARGIN (dB)	ANTENNA HEIGHT (m)	TABLE ANGLE (Degree)	RAW VALUE (dBuV)	CORRECTION FACTOR (dB/m)
1	#5620.30	56.9 PK	68.2	-11.3	1.00 H	150	54.3	2.6
2	*5745.00	107.1 PK			1.00 H	150	104.4	2.7
3	*5745.00	95.6 AV			1.00 H	150	92.9	2.7
4	*5785.00	108.2 PK			1.00 H	150	105.5	2.7
5	*5785.00	96.2 AV			1.00 H	150	93.5	2.7
6	#5948.05	57.5 PK	68.2	-10.7	1.00 H	150	54.3	3.2
7	11490.00	50.2 PK	74.0	-23.8	2.14 H	27	36.8	13.4
8	11490.00	39.2 AV	54.0	-14.8	2.14 H	27	25.8	13.4
9	11570.00	49.4 PK	74.0	-24.6	2.12 H	17	36.3	13.1
10	11570.00	38.0 AV	54.0	-16.0	2.12 H	17	24.9	13.1
11	#17235.00	49.2 PK	74.0	-24.8	1.74 H	53	30.9	18.3
12	#17235.00	38.7 AV	54.0	-15.3	1.74 H	53	20.4	18.3
13	#17355.00	48.8 PK	74.0	-25.2	1.75 H	29	30.0	18.8
14	#17355.00	38.8 AV	54.0	-15.2	1.75 H	29	20.0	18.8

ANTENNA POLARITY & TEST DISTANCE: VERTICAL AT 3 M

NO.	FREQ. (MHz)	EMISSION LEVEL (dBuV/m)	LIMIT (dBuV/m)	MARGIN (dB)	ANTENNA HEIGHT (m)	TABLE ANGLE (Degree)	RAW VALUE (dBuV)	CORRECTION FACTOR (dB/m)
1	#5626.95	66.0 PK	68.2	-2.2	2.46 V	69	63.4	2.6
2	#5649.75	66.3 PK	68.2	-1.9	2.46 V	69	63.7	2.6
3	*5745.00	116.4 PK			2.46 V	69	113.7	2.7
4	*5745.00	105.3 AV			2.46 V	69	102.6	2.7
5	*5785.00	116.8 PK			2.46 V	69	114.1	2.7
6	*5785.00	105.8 AV			2.46 V	69	103.1	2.7
7	#5930.95	60.0 PK	68.2	-8.2	2.46 V	69	56.9	3.1
8	11490.00	51.4 PK	74.0	-22.6	2.23 V	270	38.0	13.4
9	11490.00	42.4 AV	54.0	-11.6	2.23 V	270	29.0	13.4
10	11570.00	51.5 PK	74.0	-22.5	2.19 V	254	38.4	13.1
11	11570.00	42.7 AV	54.0	-11.3	2.19 V	254	29.6	13.1
12	#17235.00	52.0 PK	74.0	-22.0	2.04 V	311	33.7	18.3
13	#17235.00	38.9 AV	54.0	-15.1	2.04 V	311	20.6	18.3
14	#17355.00	52.2 PK	74.0	-21.8	2.13 V	310	33.4	18.8
15	#17355.00	39.4 AV	54.0	-14.6	2.13 V	310	20.6	18.8

REMARKS:

1. Emission Level(dBuV/m) = Raw Value(dBuV) + Correction Factor(dB/m)
2. Correction Factor(dB/m) = Antenna Factor(dB/m) + Cable Factor(dB) – Pre-Amplifier Factor(dB)
3. The other emission levels were very low against the limit.
4. Margin value = Emission Level – Limit value
5. " * ": Fundamental frequency.
6. " # ": The radiated frequency is out of the restricted band.

CHANNEL	TX Channel 153+161	DETECTOR FUNCTION	Peak (PK)
FREQUENCY RANGE	1GHz ~ 40GHz		Average (AV)

ANTENNA POLARITY & TEST DISTANCE: HORIZONTAL AT 3 M

NO.	FREQ. (MHz)	EMISSION LEVEL (dBuV/m)	LIMIT (dBuV/m)	MARGIN (dB)	ANTENNA HEIGHT (m)	TABLE ANGLE (Degree)	RAW VALUE (dBuV)	CORRECTION FACTOR (dB/m)
1	#5563.77	57.1 PK	68.2	-11.1	1.01 H	156	54.6	2.5
2	*5765.00	106.8 PK			1.01 H	156	104.1	2.7
3	*5765.00	95.3 AV			1.01 H	156	92.6	2.7
4	*5805.00	107.4 PK			1.01 H	156	104.7	2.7
5	*5805.00	95.6 AV			1.01 H	156	92.9	2.7
6	#5923.82	56.7 PK	69.1	-12.4	1.01 H	156	53.6	3.1
7	11530.00	49.9 PK	74.0	-24.1	2.20 H	42	36.7	13.2
8	11530.00	38.7 AV	54.0	-15.3	2.20 H	42	25.5	13.2
9	11610.00	49.6 PK	74.0	-24.4	2.16 H	23	36.6	13.0
10	11610.00	38.0 AV	54.0	-16.0	2.16 H	23	25.0	13.0
11	#17295.00	49.0 PK	74.0	-25.0	1.69 H	44	30.6	18.4
12	#17295.00	38.6 AV	54.0	-15.4	1.69 H	44	20.2	18.4
13	#17415.00	48.3 PK	74.0	-25.7	1.75 H	34	29.2	19.1
14	#17415.00	38.4 AV	54.0	-15.6	1.75 H	34	19.3	19.1

ANTENNA POLARITY & TEST DISTANCE: VERTICAL AT 3 M

NO.	FREQ. (MHz)	EMISSION LEVEL (dBuV/m)	LIMIT (dBuV/m)	MARGIN (dB)	ANTENNA HEIGHT (m)	TABLE ANGLE (Degree)	RAW VALUE (dBuV)	CORRECTION FACTOR (dB/m)
1	#5642.62	65.3 PK	68.2	-2.9	4.00 V	53	62.7	2.6
2	*5765.00	116.7 PK			2.45 V	53	114.0	2.7
3	*5765.00	105.3 AV			2.45 V	53	102.6	2.7
4	*5805.00	116.7 PK			2.45 V	53	114.0	2.7
5	*5805.00	105.5 AV			2.45 V	53	102.8	2.7
6	#5923.35	63.0 PK	69.4	-6.4	2.45 V	53	59.9	3.1
7	11530.00	52.0 PK	74.0	-22.0	2.28 V	271	38.8	13.2
8	11530.00	42.8 AV	54.0	-11.2	2.28 V	271	29.6	13.2
9	11610.00	51.6 PK	74.0	-22.4	2.25 V	249	38.6	13.0
10	11610.00	42.7 AV	54.0	-11.3	2.25 V	249	29.7	13.0
11	#17295.00	51.7 PK	74.0	-22.3	2.01 V	321	33.3	18.4
12	#17295.00	38.8 AV	54.0	-15.2	2.01 V	321	20.4	18.4
13	#17415.00	52.8 PK	74.0	-21.2	2.15 V	312	33.7	19.1
14	#17415.00	39.7 AV	54.0	-14.3	2.15 V	312	20.6	19.1

REMARKS:

1. Emission Level(dBuV/m) = Raw Value(dBuV) + Correction Factor(dB/m)
2. Correction Factor(dB/m) = Antenna Factor(dB/m) + Cable Factor(dB) – Pre-Amplifier Factor(dB)
3. The other emission levels were very low against the limit.
4. Margin value = Emission Level – Limit value
5. " * ": Fundamental frequency.
6. " # ": The radiated frequency is out of the restricted band.

CHANNEL	TX Channel 157+165	DETECTOR FUNCTION	Peak (PK)
FREQUENCY RANGE	1GHz ~ 40GHz		Average (AV)

ANTENNA POLARITY & TEST DISTANCE: HORIZONTAL AT 3 M

NO.	FREQ. (MHz)	EMISSION LEVEL (dBuV/m)	LIMIT (dBuV/m)	MARGIN (dB)	ANTENNA HEIGHT (m)	TABLE ANGLE (Degree)	RAW VALUE (dBuV)	CORRECTION FACTOR (dB/m)
1	#5582.77	57.2 PK	68.2	-11.0	1.05 H	141	54.7	2.5
2	*5785.00	107.5 PK			1.05 H	141	104.8	2.7
3	*5785.00	95.8 AV			1.05 H	141	93.1	2.7
4	*5825.00	108.0 PK			1.05 H	141	105.3	2.7
5	*5825.00	96.1 AV			1.05 H	141	93.4	2.7
6	#5930.00	58.3 PK	68.2	-9.9	1.05 H	141	55.2	3.1
7	11570.00	50.1 PK	74.0	-23.9	2.24 H	57	37.0	13.1
8	11570.00	38.7 AV	54.0	-15.3	2.24 H	57	25.6	13.1
9	11650.00	49.4 PK	74.0	-24.6	2.15 H	21	36.3	13.1
10	11650.00	37.7 AV	54.0	-16.3	2.15 H	21	24.6	13.1
11	#17355.00	49.0 PK	74.0	-25.0	1.75 H	58	30.2	18.8
12	#17355.00	38.3 AV	54.0	-15.7	1.75 H	58	19.5	18.8
13	#17475.00	47.8 PK	74.0	-26.2	1.81 H	30	28.6	19.2
14	#17475.00	36.9 AV	54.0	-17.1	1.81 H	30	17.7	19.2

ANTENNA POLARITY & TEST DISTANCE: VERTICAL AT 3 M

NO.	FREQ. (MHz)	EMISSION LEVEL (dBuV/m)	LIMIT (dBuV/m)	MARGIN (dB)	ANTENNA HEIGHT (m)	TABLE ANGLE (Degree)	RAW VALUE (dBuV)	CORRECTION FACTOR (dB/m)
1	#5627.90	62.7 PK	68.2	-5.5	2.50 V	53	60.1	2.6
2	*5785.00	116.0 PK			2.50 V	53	113.3	2.7
3	*5785.00	105.0 AV			2.50 V	53	102.3	2.7
4	*5825.00	116.8 PK			2.50 V	53	114.1	2.7
5	*5825.00	106.0 AV			2.50 V	53	103.3	2.7
6	#5943.30	67.3 PK	68.2	-0.9	2.50 V	53	64.2	3.1
7	11570.00	52.5 PK	74.0	-21.5	2.32 V	281	39.4	13.1
8	11570.00	43.1 AV	54.0	-10.9	2.32 V	281	30.0	13.1
9	11650.00	52.4 PK	74.0	-21.6	2.33 V	279	39.3	13.1
10	11650.00	42.6 AV	54.0	-11.4	2.33 V	279	29.5	13.1
11	#17355.00	51.7 PK	74.0	-22.3	2.06 V	319	32.9	18.8
12	#17355.00	38.8 AV	54.0	-15.2	2.06 V	319	20.0	18.8
13	#17475.00	51.2 PK	74.0	-22.8	2.08 V	321	32.0	19.2
14	#17475.00	39.0 AV	54.0	-15.0	2.08 V	321	19.8	19.2

REMARKS:

1. Emission Level(dBuV/m) = Raw Value(dBuV) + Correction Factor(dB/m)
2. Correction Factor(dB/m) = Antenna Factor(dB/m) + Cable Factor(dB) – Pre-Amplifier Factor(dB)
3. The other emission levels were very low against the limit.
4. Margin value = Emission Level – Limit value
5. " * ": Fundamental frequency.
6. " # ": The radiated frequency is out of the restricted band.

LAA-3 carriers (CA_46D)

CHANNEL	TX Channel 32+36+40	DETECTOR FUNCTION	Peak (PK)
FREQUENCY RANGE	1GHz ~ 40GHz		Average (AV)

ANTENNA POLARITY & TEST DISTANCE: HORIZONTAL AT 3 M

NO.	FREQ. (MHz)	EMISSION LEVEL (dBuV/m)	LIMIT (dBuV/m)	MARGIN (dB)	ANTENNA HEIGHT (m)	TABLE ANGLE (Degree)	RAW VALUE (dBuV)	CORRECTION FACTOR (dB/m)
1	5150.00	57.9 PK	74.0	-16.1	1.02 H	120	56.4	1.5
2	5150.00	48.6 AV	54.0	-5.4	1.02 H	120	47.1	1.5
3	*5180.00	107.4 PK			1.02 H	120	105.8	1.6
4	*5180.00	95.1 AV			1.02 H	120	93.5	1.6
5	#10360.00	48.5 PK	74.0	-25.5	2.18 H	34	37.0	11.5
6	#10360.00	37.8 AV	54.0	-16.2	2.18 H	34	26.3	11.5
7	15540.00	47.6 PK	74.0	-26.4	2.14 H	9	34.5	13.1
8	15540.00	37.4 AV	54.0	-16.6	2.14 H	9	24.3	13.1

ANTENNA POLARITY & TEST DISTANCE: VERTICAL AT 3 M

NO.	FREQ. (MHz)	EMISSION LEVEL (dBuV/m)	LIMIT (dBuV/m)	MARGIN (dB)	ANTENNA HEIGHT (m)	TABLE ANGLE (Degree)	RAW VALUE (dBuV)	CORRECTION FACTOR (dB/m)
1	5150.00	63.3 PK	74.0	-10.7	2.19 V	84	61.8	1.5
2	5150.00	53.4 AV	54.0	-0.6	2.19 V	84	51.9	1.5
3	*5180.00	111.2 PK			2.19 V	84	109.6	1.6
4	*5180.00	99.5 AV			2.19 V	84	97.9	1.6
5	#10360.00	51.4 PK	74.0	-22.6	2.14 V	266	39.9	11.5
6	#10360.00	42.9 AV	54.0	-11.1	2.14 V	266	31.4	11.5
7	15540.00	50.7 PK	74.0	-23.3	2.01 V	309	37.6	13.1
8	15540.00	39.2 AV	54.0	-14.8	2.01 V	309	26.1	13.1

REMARKS:

- Emission Level(dBuV/m) = Raw Value(dBuV) + Correction Factor(dB/m)
- Correction Factor(dB/m) = Antenna Factor(dB/m) + Cable Factor(dB) – Pre-Amplifier Factor(dB)
- The other emission levels were very low against the limit.
- Margin value = Emission Level – Limit value
- " * ": Fundamental frequency.
- " # ": The radiated frequency is out of the restricted band.

CHANNEL	TX Channel 36+40+44	DETECTOR FUNCTION	Peak (PK)
FREQUENCY RANGE	1GHz ~ 40GHz		Average (AV)

ANTENNA POLARITY & TEST DISTANCE: HORIZONTAL AT 3 M

NO.	FREQ. (MHz)	EMISSION LEVEL (dBuV/m)	LIMIT (dBuV/m)	MARGIN (dB)	ANTENNA HEIGHT (m)	TABLE ANGLE (Degree)	RAW VALUE (dBuV)	CORRECTION FACTOR (dB/m)
1	5150.00	56.9 PK	74.0	-17.1	2.28 H	202	55.4	1.5
2	5150.00	48.4 AV	54.0	-5.6	2.28 H	202	46.9	1.5
3	*5200.00	108.8 PK			2.28 H	202	107.1	1.7
4	*5200.00	97.6 AV			2.28 H	202	95.9	1.7
5	5406.00	57.8 PK	74.0	-16.2	2.28 H	202	55.7	2.1
6	5406.00	40.7 AV	54.0	-13.3	2.28 H	202	38.6	2.1
7	#10400.00	49.2 PK	74.0	-24.8	2.21 H	65	37.6	11.6
8	#10400.00	38.1 AV	54.0	-15.9	2.21 H	65	26.5	11.6
9	15600.00	49.2 PK	74.0	-24.8	1.67 H	64	36.1	13.1
10	15600.00	37.4 AV	54.0	-16.6	1.67 H	64	24.3	13.1

ANTENNA POLARITY & TEST DISTANCE: VERTICAL AT 3 M

NO.	FREQ. (MHz)	EMISSION LEVEL (dBuV/m)	LIMIT (dBuV/m)	MARGIN (dB)	ANTENNA HEIGHT (m)	TABLE ANGLE (Degree)	RAW VALUE (dBuV)	CORRECTION FACTOR (dB/m)
1	5150.00	63.2 PK	74.0	-10.8	2.09 V	105	61.7	1.5
2	5150.00	51.5 AV	54.0	-2.5	2.09 V	105	50.0	1.5
3	*5200.00	113.8 PK			2.09 V	105	112.1	1.7
4	*5200.00	102.0 AV			2.09 V	105	100.3	1.7
5	5406.00	54.1 PK	74.0	-19.9	2.09 V	105	52.0	2.1
6	5406.00	44.7 AV	54.0	-9.3	2.09 V	105	42.6	2.1
7	#10400.00	52.4 PK	74.0	-21.6	2.31 V	280	40.8	11.6
8	#10400.00	42.8 AV	54.0	-11.2	2.31 V	280	31.2	11.6
9	15600.00	52.0 PK	74.0	-22.0	2.04 V	305	38.9	13.1
10	15600.00	39.4 AV	54.0	-14.6	2.04 V	305	26.3	13.1

REMARKS:

1. Emission Level(dBuV/m) = Raw Value(dBuV) + Correction Factor(dB/m)
2. Correction Factor(dB/m) = Antenna Factor(dB/m) + Cable Factor(dB) – Pre-Amplifier Factor(dB)
3. The other emission levels were very low against the limit.
4. Margin value = Emission Level – Limit value
5. " * ": Fundamental frequency.
6. " # ": The radiated frequency is out of the restricted band.

CHANNEL	TX Channel 40+44+48	DETECTOR FUNCTION	Peak (PK)
FREQUENCY RANGE	1GHz ~ 40GHz		Average (AV)

ANTENNA POLARITY & TEST DISTANCE: HORIZONTAL AT 3 M

NO.	FREQ. (MHz)	EMISSION LEVEL (dBuV/m)	LIMIT (dBuV/m)	MARGIN (dB)	ANTENNA HEIGHT (m)	TABLE ANGLE (Degree)	RAW VALUE (dBuV)	CORRECTION FACTOR (dB/m)
1	5150.00	57.7 PK	74.0	-16.3	2.23 H	200	56.2	1.5
2	5150.00	48.5 AV	54.0	-5.5	2.23 H	200	47.0	1.5
3	*5220.00	110.9 PK			2.23 H	200	109.2	1.7
4	*5220.00	101.0 AV			2.23 H	200	99.3	1.7
5	5406.70	60.6 PK	74.0	-13.4	2.23 H	200	58.5	2.1
6	5406.70	50.1 AV	54.0	-3.9	2.23 H	200	48.0	2.1
7	#10440.00	48.9 PK	74.0	-25.1	2.22 H	51	37.0	11.9
8	#10440.00	37.7 AV	54.0	-16.3	2.22 H	51	25.8	11.9
9	15660.00	47.8 PK	74.0	-26.2	1.64 H	60	34.5	13.3
10	15660.00	36.7 AV	54.0	-17.3	1.64 H	60	23.4	13.3

ANTENNA POLARITY & TEST DISTANCE: VERTICAL AT 3 M

NO.	FREQ. (MHz)	EMISSION LEVEL (dBuV/m)	LIMIT (dBuV/m)	MARGIN (dB)	ANTENNA HEIGHT (m)	TABLE ANGLE (Degree)	RAW VALUE (dBuV)	CORRECTION FACTOR (dB/m)
1	5150.00	63.6 PK	74.0	-10.4	2.10 V	103	62.1	1.5
2	5150.00	51.6 AV	54.0	-2.4	2.10 V	103	50.1	1.5
3	*5220.00	116.5 PK			2.10 V	103	114.8	1.7
4	*5220.00	104.3 AV			2.10 V	103	102.6	1.7
5	5406.70	66.2 PK	74.0	-7.8	2.10 V	103	64.1	2.1
6	5406.70	53.4 AV	54.0	-0.6	2.10 V	103	51.3	2.1
7	#10440.00	52.4 PK	74.0	-21.6	2.28 V	271	40.5	11.9
8	#10440.00	43.0 AV	54.0	-11.0	2.28 V	271	31.1	11.9
9	15660.00	52.1 PK	74.0	-21.9	1.99 V	295	38.8	13.3
10	15660.00	39.5 AV	54.0	-14.5	1.99 V	295	26.2	13.3

REMARKS:

1. Emission Level(dBuV/m) = Raw Value(dBuV) + Correction Factor(dB/m)
2. Correction Factor(dB/m) = Antenna Factor(dB/m) + Cable Factor(dB) – Pre-Amplifier Factor(dB)
3. The other emission levels were very low against the limit.
4. Margin value = Emission Level – Limit value
5. " * ": Fundamental frequency.
6. " # ": The radiated frequency is out of the restricted band.

CHANNEL	TX Channel 149+153+157	DETECTOR FUNCTION	Peak (PK)
FREQUENCY RANGE	1GHz ~ 40GHz		Average (AV)

ANTENNA POLARITY & TEST DISTANCE: HORIZONTAL AT 3 M

NO.	FREQ. (MHz)	EMISSION LEVEL (dBuV/m)	LIMIT (dBuV/m)	MARGIN (dB)	ANTENNA HEIGHT (m)	TABLE ANGLE (Degree)	RAW VALUE (dBuV)	CORRECTION FACTOR (dB/m)
1	#5647.85	60.8 PK	68.2	-7.4	1.10 H	132	58.2	2.6
2	*5765.00	109.1 PK			1.10 H	132	106.4	2.7
3	*5765.00	97.7 AV			1.10 H	132	95.0	2.7
4	#5968.00	57.1 PK	68.2	-11.1	1.10 H	132	53.9	3.2
5	11530.00	48.7 PK	74.0	-25.3	2.23 H	41	35.5	13.2
6	11530.00	37.5 AV	54.0	-16.5	2.23 H	41	24.3	13.2
7	#17295.00	47.8 PK	74.0	-26.2	1.70 H	54	29.4	18.4
8	#17295.00	37.0 AV	54.0	-17.0	1.70 H	54	18.6	18.4

ANTENNA POLARITY & TEST DISTANCE: VERTICAL AT 3 M

NO.	FREQ. (MHz)	EMISSION LEVEL (dBuV/m)	LIMIT (dBuV/m)	MARGIN (dB)	ANTENNA HEIGHT (m)	TABLE ANGLE (Degree)	RAW VALUE (dBuV)	CORRECTION FACTOR (dB/m)
1	#5627.90	68.1 PK	68.2	-0.1	2.08 V	74	65.5	2.6
2	*5765.00	115.4 PK			2.08 V	74	112.7	2.7
3	*5765.00	102.5 AV			2.08 V	74	99.8	2.7
4	#5930.48	62.4 PK	68.2	-5.8	2.09 V	74	59.3	3.1
5	11530.00	51.9 PK	74.0	-22.1	2.28 V	285	38.7	13.2
6	11530.00	42.6 AV	54.0	-11.4	2.28 V	285	29.4	13.2
7	#17295.00	51.9 PK	74.0	-22.1	2.02 V	301	33.5	18.4
8	#17295.00	39.4 AV	54.0	-14.6	2.02 V	301	21.0	18.4

REMARKS:

- Emission Level(dBuV/m) = Raw Value(dBuV) + Correction Factor(dB/m)
- Correction Factor(dB/m) = Antenna Factor(dB/m) + Cable Factor(dB) – Pre-Amplifier Factor(dB)
- The other emission levels were very low against the limit.
- Margin value = Emission Level – Limit value
- " * ": Fundamental frequency.
- " # ": The radiated frequency is out of the restricted band.

CHANNEL	TX Channel 153+157+161	DETECTOR FUNCTION	Peak (PK)
FREQUENCY RANGE	1GHz ~ 40GHz		Average (AV)

ANTENNA POLARITY & TEST DISTANCE: HORIZONTAL AT 3 M

NO.	FREQ. (MHz)	EMISSION LEVEL (dBuV/m)	LIMIT (dBuV/m)	MARGIN (dB)	ANTENNA HEIGHT (m)	TABLE ANGLE (Degree)	RAW VALUE (dBuV)	CORRECTION FACTOR (dB/m)
1	#5649.75	59.6 PK	68.2	-8.6	1.08 H	113	57.0	2.6
2	*5785.00	109.8 PK			1.08 H	113	107.1	2.7
3	*5785.00	98.1 AV			1.08 H	113	95.4	2.7
4	#5934.27	56.7 PK	68.2	-11.5	1.08 H	113	53.6	3.1
5	11570.00	48.7 PK	74.0	-25.3	2.19 H	36	35.6	13.1
6	11570.00	37.7 AV	54.0	-16.3	2.19 H	36	24.6	13.1
7	#17355.00	47.5 PK	74.0	-26.5	1.75 H	52	28.7	18.8
8	#17355.00	36.8 AV	54.0	-17.2	1.75 H	52	18.0	18.8

ANTENNA POLARITY & TEST DISTANCE: VERTICAL AT 3 M

NO.	FREQ. (MHz)	EMISSION LEVEL (dBuV/m)	LIMIT (dBuV/m)	MARGIN (dB)	ANTENNA HEIGHT (m)	TABLE ANGLE (Degree)	RAW VALUE (dBuV)	CORRECTION FACTOR (dB/m)
1	#5647.85	67.7 PK	68.2	-0.5	2.09 V	73	65.1	2.6
2	*5785.00	115.4 PK			2.09 V	73	112.7	2.7
3	*5785.00	102.6 AV			2.09 V	73	99.9	2.7
4	#5926.68	66.7 PK	68.2	-1.5	2.09 V	73	63.6	3.1
5	11570.00	52.5 PK	74.0	-21.5	2.30 V	280	39.4	13.1
6	11570.00	43.1 AV	54.0	-10.9	2.30 V	280	30.0	13.1
7	#17355.00	51.9 PK	74.0	-22.1	2.02 V	286	33.1	18.8
8	#17355.00	39.3 AV	54.0	-14.7	2.02 V	286	20.5	18.8

REMARKS:

- Emission Level(dBuV/m) = Raw Value(dBuV) + Correction Factor(dB/m)
- Correction Factor(dB/m) = Antenna Factor(dB/m) + Cable Factor(dB) – Pre-Amplifier Factor(dB)
- The other emission levels were very low against the limit.
- Margin value = Emission Level – Limit value
- " * ": Fundamental frequency.
- " # ": The radiated frequency is out of the restricted band.

CHANNEL	TX Channel 157+161+165	DETECTOR FUNCTION	Peak (PK)
FREQUENCY RANGE	1GHz ~ 40GHz		Average (AV)

ANTENNA POLARITY & TEST DISTANCE: HORIZONTAL AT 3 M

NO.	FREQ. (MHz)	EMISSION LEVEL (dBuV/m)	LIMIT (dBuV/m)	MARGIN (dB)	ANTENNA HEIGHT (m)	TABLE ANGLE (Degree)	RAW VALUE (dBuV)	CORRECTION FACTOR (dB/m)
1	#5645.00	63.1 PK	68.2	-5.1	1.06 H	121	60.5	2.6
2	*5805.00	109.3 PK			1.06 H	121	106.6	2.7
3	*5805.00	97.9 AV			1.06 H	121	95.2	2.7
4	#5932.37	62.1 PK	68.2	-6.1	1.06 H	121	59.0	3.1
5	11610.00	48.6 PK	74.0	-25.4	2.19 H	47	35.6	13.0
6	11610.00	37.3 AV	54.0	-16.7	2.19 H	47	24.3	13.0
7	#17415.00	47.5 PK	74.0	-26.5	1.72 H	63	28.4	19.1
8	#17415.00	36.6 AV	54.0	-17.4	1.72 H	63	17.5	19.1

ANTENNA POLARITY & TEST DISTANCE: VERTICAL AT 3 M

NO.	FREQ. (MHz)	EMISSION LEVEL (dBuV/m)	LIMIT (dBuV/m)	MARGIN (dB)	ANTENNA HEIGHT (m)	TABLE ANGLE (Degree)	RAW VALUE (dBuV)	CORRECTION FACTOR (dB/m)
1	#5648.32	66.4 PK	68.2	-1.8	2.11 V	68	63.8	2.6
2	*5805.00	115.6 PK			2.11 V	68	112.9	2.7
3	*5805.00	102.5 AV			2.11 V	68	99.8	2.7
4	#5941.40	68.1 PK	68.2	-0.1	2.11 V	68	65.0	3.1
5	11610.00	52.8 PK	74.0	-21.2	2.35 V	278	39.8	13.0
6	11610.00	43.4 AV	54.0	-10.6	2.35 V	278	30.4	13.0
7	#17415.00	52.4 PK	74.0	-21.6	2.04 V	285	33.3	19.1
8	#17415.00	39.6 AV	54.0	-14.4	2.04 V	285	20.5	19.1

REMARKS:

- Emission Level(dBuV/m) = Raw Value(dBuV) + Correction Factor(dB/m)
- Correction Factor(dB/m) = Antenna Factor(dB/m) + Cable Factor(dB) – Pre-Amplifier Factor(dB)
- The other emission levels were very low against the limit.
- Margin value = Emission Level – Limit value
- " * ": Fundamental frequency.
- " # ": The radiated frequency is out of the restricted band.

Below 1GHz Data :

LAA-single carrier

CHANNEL	TX Channel 161	DETECTOR FUNCTION	Quasi-Peak (QP)
FREQUENCY RANGE	30MHz ~ 1GHz		

ANTENNA POLARITY & TEST DISTANCE: HORIZONTAL AT 3 M

NO.	FREQ. (MHz)	EMISSION LEVEL (dBuV/m)	LIMIT (dBuV/m)	MARGIN (dB)	ANTENNA HEIGHT (m)	TABLE ANGLE (Degree)	RAW VALUE (dBuV)	CORRECTION FACTOR (dB/m)
1	33.86	27.0 QP	40.0	-13.0	1.50 H	284	36.5	-9.5
2	95.50	27.9 QP	43.5	-15.6	2.00 H	83	41.7	-13.8
3	164.20	26.1 QP	43.5	-17.4	1.50 H	94	34.8	-8.7
4	286.16	41.0 QP	46.0	-5.0	1.10 H	358	49.3	-8.3
5	395.37	27.9 QP	46.0	-18.1	1.00 H	316	33.5	-5.6
6	983.02	33.0 QP	54.0	-21.0	2.00 H	19	28.2	4.8

ANTENNA POLARITY & TEST DISTANCE: VERTICAL AT 3 M

NO.	FREQ. (MHz)	EMISSION LEVEL (dBuV/m)	LIMIT (dBuV/m)	MARGIN (dB)	ANTENNA HEIGHT (m)	TABLE ANGLE (Degree)	RAW VALUE (dBuV)	CORRECTION FACTOR (dB/m)
1	33.13	30.0 QP	40.0	-10.0	1.00 V	142	39.7	-9.7
2	93.44	26.4 QP	43.5	-17.1	1.50 V	38	40.6	-14.2
3	161.75	23.0 QP	43.5	-20.5	1.00 V	119	31.7	-8.7
4	290.93	30.7 QP	46.0	-15.3	1.00 V	64	39.0	-8.3
5	737.28	29.1 QP	46.0	-16.9	2.00 V	14	27.4	1.7
6	983.05	34.0 QP	54.0	-20.0	2.00 V	0	29.2	4.8

REMARKS:

1. Emission Level(dBuV/m) = Raw Value(dBuV) + Correction Factor(dB/m)
2. Correction Factor(dB/m) = Antenna Factor(dB/m) + Cable Factor(dB) – Pre-Amplifier Factor(dB)
3. The other emission levels were very low against the limit.
4. Margin value = Emission Level – Limit value

4.2 Conducted Emission Measurement

4.2.1 Limits of Conducted Emission Measurement

Frequency (MHz)	Conducted Limit (dBuV)	
	Quasi-peak	Average
0.15 - 0.5	66 - 56	56 - 46
0.50 - 5.0	56	46
5.0 - 30.0	60	50

Note: 1. The lower limit shall apply at the transition frequencies.

2. The limit decreases in line with the logarithm of the frequency in the range of 0.15 to 0.50MHz.

4.2.2 Test Instruments

DESCRIPTION & MANUFACTURER	MODEL NO.	SERIAL NO.	CALIBRATED DATE	CALIBRATED UNTIL
Test Receiver R&S	ESCS 30	100375	May 09, 2016	May 08, 2017
Line-Impedance Stabilization Network (for EUT) SCHWARZBECK	NSLK-8127	8127-522	Aug. 31, 2016	Aug. 30, 2017
Line-Impedance Stabilization Network (for Peripheral) R&S	ENV216	100072	June 13, 2016	June 12, 2017
RF Cable	5D-FB	COACAB-002	Mar. 04, 2016	Mar. 03, 2017
10 dB PAD Mini-Circuits	HAT-10+	CONATT-003	Sep. 13, 2016	Sep. 12, 2017
50 ohms Terminator	N/A	EMC-03	Sep. 29, 2016	Sep. 28, 2017
50 ohms Terminator	N/A	EMC-02	Sep. 29, 2016	Sep. 28, 2017
Software BVADT	BVADT_Cond_ V7.3.7.4	NA	NA	NA

Note:

1. The calibration interval of the above test instruments are 12 months and the calibrations are traceable to NML/ROC and NIST/USA.
2. The test was performed in Shielded Room No. C.
- 3 The VCCI Con C Registration No. is C-3611.
- 4 Tested Date: Nov. 09, 2016

4.2.3 Test Procedure

- The EUT was placed 0.4 meters from the conducting wall of the shielded room with EUT being connected to the power mains through a line impedance stabilization network (LISN). Other support units were connected to the power mains through another LISN. The two LISNs provide 50 ohm/ 50uH of coupling impedance for the measuring instrument.
- Both lines of the power mains connected to the EUT were checked for maximum conducted interference.
- The frequency range from 150kHz to 30MHz was searched. Emission levels under (Limit - 20dB) was not recorded.

NOTE: All modes of operation were investigated and the worst-case emissions are reported.

4.2.4 Deviation from Test Standard

No deviation.

4.2.5 Test Setup

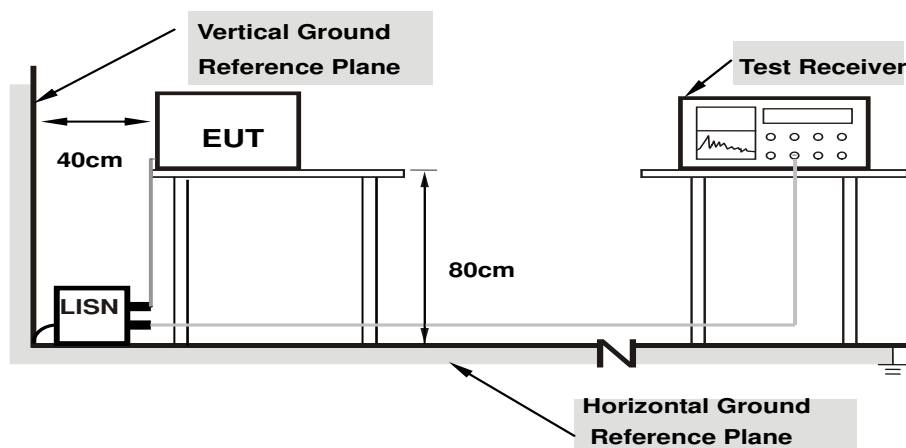

Note: 1.Support units were connected to second LISN.

For the actual test configuration, please refer to the attached file (Test Setup Photo).

4.2.6 EUT Operating Condition

Same as 4.1.6.

4.2.7 Test Results

Phase	Line (L)	Detector Function	Quasi-Peak (QP) / Average (AV)
-------	----------	-------------------	--------------------------------

Phase Of Power : Line (L)										
No	Frequency (MHz)	Correction Factor (dB)	Reading Value (dBuV)		Emission Level (dBuV)		Limit (dBuV)		Margin (dB)	
			Q.P.	AV.	Q.P.	AV.	Q.P.	AV.	Q.P.	AV.
1	0.17344	10.13	27.57	8.69	37.70	18.82	64.79	54.79	-27.09	-35.97
2	0.20469	10.12	23.60	5.10	33.72	15.22	63.42	53.42	-29.70	-38.20
3	0.25547	10.12	19.46	2.08	29.58	12.20	61.58	51.58	-32.00	-39.38
4	0.38828	10.11	21.94	10.82	32.05	20.93	58.10	48.10	-26.05	-27.17
5	0.79844	10.12	14.61	2.75	24.73	12.87	56.00	46.00	-31.27	-33.13
6	2.53906	10.27	16.28	5.64	26.55	15.91	56.00	46.00	-29.45	-30.09
7	29.79688	11.16	24.26	19.51	35.42	30.67	60.00	50.00	-24.58	-19.33

Remarks:

1. Q.P. and AV. are abbreviations of quasi-peak and average individually.
2. The emission levels of other frequencies were very low against the limit.
3. Margin value = Emission level – Limit value
4. Correction factor = Insertion loss + Cable loss
5. Emission Level = Correction Factor + Reading Value

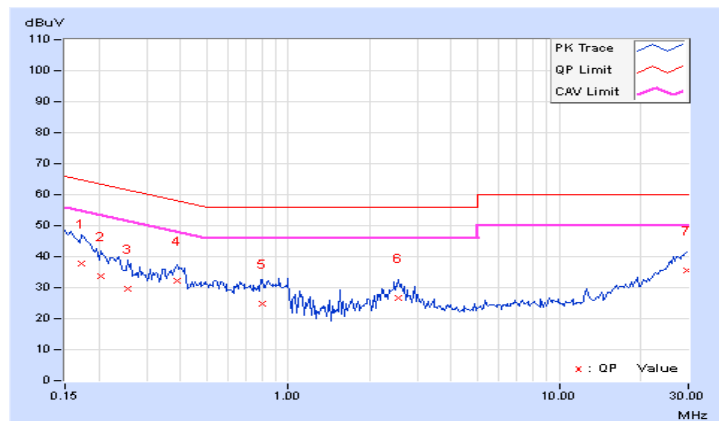

Phase	Neutral (N)	Detector Function	Quasi-Peak (QP) / Average (AV)
-------	-------------	-------------------	--------------------------------

Phase Of Power : Neutral (N)										
No	Frequency (MHz)	Correction Factor (dB)	Reading Value (dBuV)		Emission Level (dBuV)		Limit (dBuV)		Margin (dB)	
			Q.P.	AV.	Q.P.	AV.	Q.P.	AV.	Q.P.	AV.
1	0.16172	10.16	31.37	13.73	41.53	23.89	65.38	55.38	-23.85	-31.49
2	0.19687	10.08	27.22	10.55	37.30	20.63	63.74	53.74	-26.44	-33.11
3	0.29844	10.08	20.77	7.76	30.85	17.84	60.29	50.29	-29.44	-32.45
4	0.40000	10.09	24.18	13.61	34.27	23.70	57.85	47.85	-23.58	-24.15
5	0.72422	10.15	18.36	7.68	28.51	17.83	56.00	46.00	-27.49	-28.17
6	0.87656	10.19	17.63	7.18	27.82	17.37	56.00	46.00	-28.18	-28.63
7	29.00781	11.15	26.30	21.50	37.45	32.65	60.00	50.00	-22.55	-17.35

Remarks:

1. Q.P. and AV. are abbreviations of quasi-peak and average individually.
2. The emission levels of other frequencies were very low against the limit.
3. Margin value = Emission level – Limit value
4. Correction factor = Insertion loss + Cable loss
5. Emission Level = Correction Factor + Reading Value

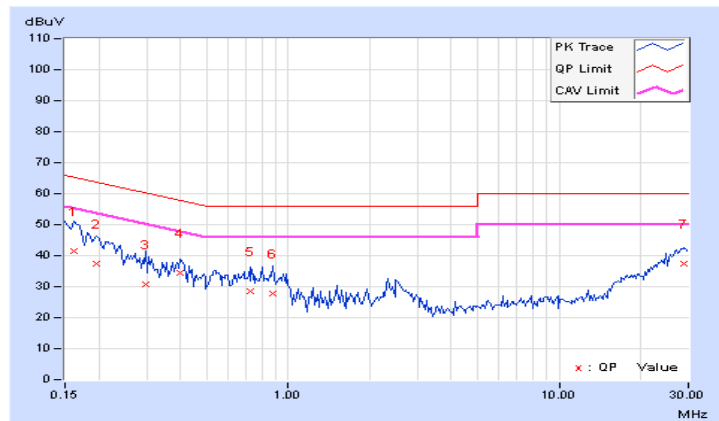

4.3 Transmit Power Measurement

4.3.1 Limits of Transmit Power Measurement

Operation Band	EUT Category		Limit
U-NII-1		Outdoor Access Point	1 Watt (30 dBm) (Max. e.i.r.p \leq 125mW(21 dBm) at any elevation angle above 30 degrees as measured from the horizon)
		Fixed point-to-point Access Point	1 Watt (30 dBm)
	√	Indoor Access Point	1 Watt (30 dBm)
		Mobile and Portable client device	250mW (24 dBm)
U-NII-2A			250mW (24 dBm) or 11 dBm+10 log B*
U-NII-2C			250mW (24 dBm) or 11 dBm+10 log B*
U-NII-3	√		1 Watt (30 dBm)

*B is the 26 dB emission bandwidth in megahertz

4.3.2 Test Setup

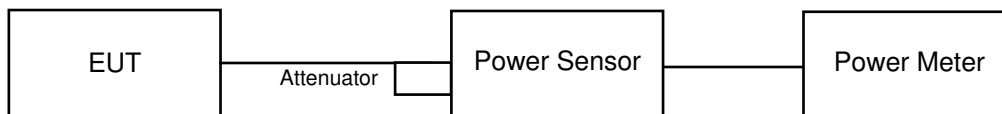

4.3.3 Test Instruments

Refer to section 4.1.2 to get information of above instrument.

4.3.4 Test Procedure

Method PM is used to perform output power measurement, trigger and gating function of wide band power meter is enabled to measure max output power of TX on burst. Duty factor is not added to measured value.

4.3.5 Deviation from Test Standard

No deviation.

4.3.6 EUT Operating Condition

The software provided by client to enable the EUT under transmission condition continuously at lowest, middle and highest channel frequencies individually.

4.3.7 Test Result

LAA-single carrier

Chan.	Chan. Freq. (MHz)	Maximum Conducted Power (dBm)		Total Power (mW)	Total Power (dBm)	Limit (dBm)	Pass / Fail
		Chain 0	Chain 1				
32	5160	18.31	18.23	134.291	21.28	28.34	Pass
36	5180	24.01	24.12	509.994	27.08	28.34	Pass
40	5200	24.21	24.23	528.483	27.23	28.34	Pass
44	5220	24.65	24.62	581.477	27.65	28.34	Pass
48	5240	24.03	24.06	507.613	27.06	28.34	Pass
149	5745	24.19	24.13	521.243	27.17	28.34	Pass
153	5765	24.59	24.36	560.638	27.49	28.34	Pass
157	5785	24.14	24.11	517.05	27.14	28.34	Pass
161	5805	24.58	24.71	582.879	27.66	28.34	Pass
165	5825	24.07	24.08	511.129	27.09	28.34	Pass

Note: Directional gain = 7.66dBi > 6dBi , so the power limit shall be reduced to $30-(7.66-6) = 28.34$ dBm.

LAA-2 carriers (CA_46C)

Chan.	Chan. Freq. (MHz)	Maximum Conducted Power (dBm)		Total Power (mW)	Total Power (dBm)	Limit (dBm)	Pass / Fail
		Chain 0	Chain 1				
32+36	5160 + 5180	19.74	19.77	189.031	22.77	28.34	Pass
36+40	5180 + 5200	23.16	23.20	415.944	26.19	28.34	Pass
40+44	5200 + 5220	23.58	23.12	433.15	26.37	28.34	Pass
44+48	5220 + 5240	23.88	23.90	489.814	26.90	28.34	Pass
149+153	5745 + 5765	23.80	23.95	488.196	26.89	28.34	Pass
153+157	5765 + 5785	23.16	23.04	408.386	26.11	28.34	Pass
157+161	5785 + 5805	23.46	23.36	438.59	26.42	28.34	Pass
161+165	5805 + 5825	23.96	23.75	486.023	26.87	28.34	Pass

Note: Directional gain = 7.66dBi > 6dBi , so the power limit shall be reduced to $30-(7.66-6) = 28.34$ dBm.

LAA-2 carriers (CA_46A-46A)

Chan.	Chan. Freq. (MHz)	Maximum Conducted Power (dBm)		Total Power (mW)	Total Power (dBm)	Limit (dBm)	Pass / Fail
		Chain 0	Chain 1				
32+40	5160 + 5200	20.16	20.24	209.435	23.21	28.34	Pass
36+44	5180 + 5220	22.02	22.10	321.402	25.07	28.34	Pass
40+48	5200 + 5240	23.04	23.17	408.863	26.12	28.34	Pass
149+157	5745 + 5785	22.42	22.16	339.019	25.30	28.34	Pass
153+161	5765 + 5805	22.49	22.17	342.235	25.34	28.34	Pass
157+165	5785 + 5825	22.70	22.39	359.589	25.56	28.34	Pass

Note: Directional gain = 7.66dBi > 6dBi , so the power limit shall be reduced to $30-(7.66-6) = 28.34$ dBm.

LAA-3 carriers (CA_46D)

Chan.	Chan. Freq. (MHz)	Maximum Conducted Power (dBm)		Total Power (mW)	Total Power (dBm)	Limit (dBm)	Pass / Fail
		Chain 0	Chain 1				
32+36+40	5160 + 5180 + 5200	19.60	19.75	185.607	22.69	28.34	Pass
36+40+44	5180 + 5200 + 5220	22.69	22.75	374.145	25.73	28.34	Pass
40+44+48	5200 + 5220 + 5240	24.25	24.24	531.534	27.26	28.34	Pass
149+153+157	5745 + 5765 + 5785	22.92	22.72	382.952	25.83	28.34	Pass
153+157+161	5765 + 5785 + 5805	22.52	22.24	346.143	25.39	28.34	Pass
157+161+165	5785 + 5805 + 5825	22.98	22.91	394.043	25.96	28.34	Pass

Note: Directional gain = 7.66dBi > 6dBi , so the power limit shall be reduced to $30-(7.66-6) = 28.34$ dBm.

4.4 Occupied Bandwidth Measurement

4.4.1 Test Setup

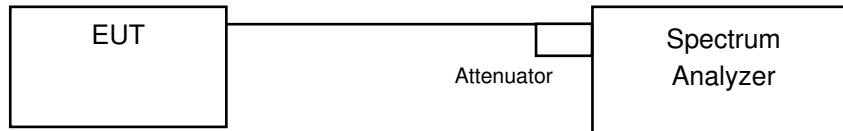

4.4.2 Test Instruments

Refer to section 4.1.2 to get information of above instrument.

4.4.3 Test Procedure

The transmitter output was connected to the spectrum analyzer through an attenuator. The bandwidth of the fundamental frequency was measured by spectrum analyzer with resolution bandwidth in the range of 1% to 5% of the anticipated emission bandwidth, and a video bandwidth at least 3x the resolution bandwidth and set the detector to SAMPLE. The width of a frequency band such that, below the lower and above the upper frequency limits, the mean powers emitted are each equal to a specified percentage 0.5 %of the total mean power of a given emission.

LAA-single carrier

Channel	Channel Frequency (MHz)	Occupied Bandwidth (MHz)	
		Chain 0	Chain 1
32	5160	17.76	17.88
36	5180	17.88	17.88
40	5200	17.88	17.88
44	5220	17.88	18.00
48	5240	17.88	17.88
149	5745	17.88	17.88
153	5765	17.88	17.88
157	5785	17.88	18.00
161	5805	17.88	17.88
165	5825	17.88	18.00

LAA-2 carriers(CA_46C)

Channel	Channel Frequency (MHz)	Occupied Bandwidth (MHz)	
		Chain 0	Chain 1
32+36	5160 + 5180	38.16	38.16
36+40	5180 + 5200	38.16	38.40
40+44	5200 + 5220	38.16	38.16
44+48	5220 + 5240	38.16	38.16
149+153	5745 + 5765	38.16	38.16
153+157	5765 + 5785	38.16	38.16
157+161	5785 + 5805	38.16	38.16
161+165	5805 + 5825	38.16	38.16

LAA-2 carriers(CA_46A-46A)

Channel	Channel Frequency (MHz)	Occupied Bandwidth (MHz)	
		Chain 0	Chain 1
32+40	5160	17.88	17.88
	5200	18.00	18.00
36+44	5180	17.88	18.00
	5220	18.00	17.88
40+48	5200	17.88	18.00
	5240	18.00	18.00
149+157	5745	17.88	17.88
	5785	17.88	18.00
153+161	5765	18.00	17.88
	5805	18.00	18.00
157+165	5785	17.88	18.00
	5825	17.88	18.00

LAA-3 carriers(CA_46D)

Channel	Channel Frequency (MHz)	Occupied Bandwidth (MHz)	
		Chain 0	Chain 1
32+36+40	5160 + 5180 + 5200	58.08	58.08
36+40+44	5180 + 5200 + 5220	58.08	58.08
40+44+48	5200 + 5220 + 5240	58.08	58.08
149+153+157	5745 + 5765 + 5785	57.60	57.12
153+157+161	5765 + 5785 + 5805	58.08	58.08
157+161+165	5785 + 5805 + 5825	58.08	58.08

Spectrum Plot of Worst Value

LAA-single carrier / Chain 1 : CH44

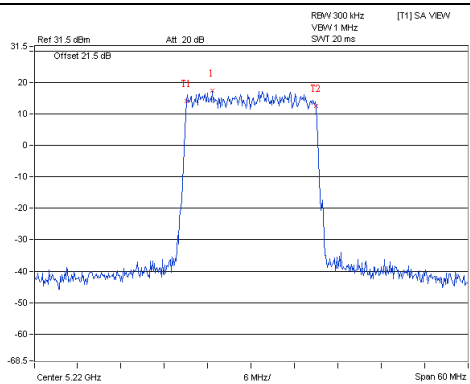

LAA-2 carriers(CA_46C) / Chain 1 : CH36+40

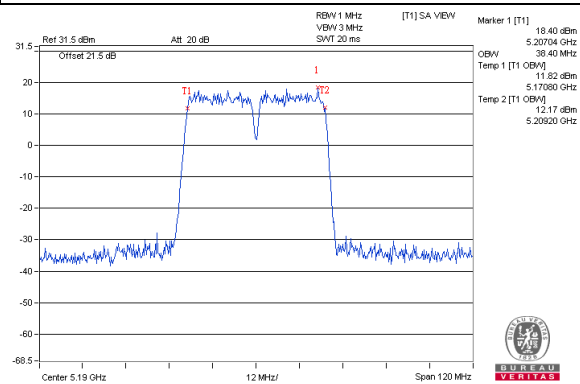

LAA-2 carriers(CA_46A-46A) / Chain 0 : CH153+161

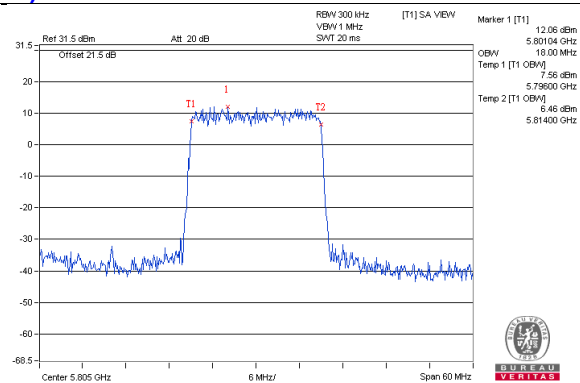
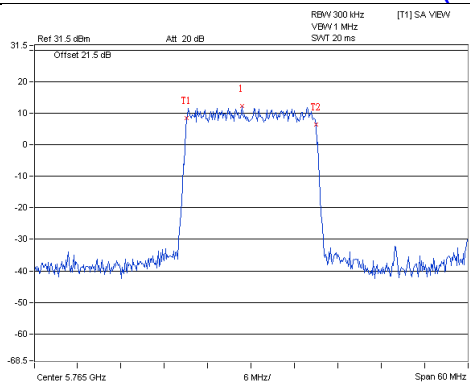

LAA-3 carriers(CA_46D) / Chain 0 : CH32+36+40

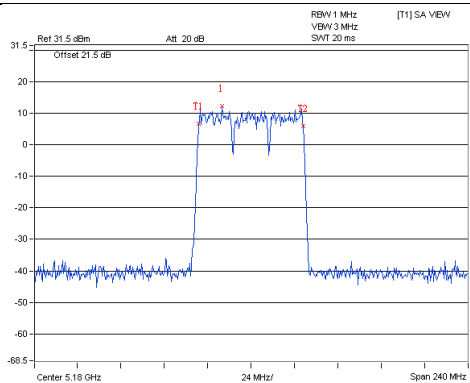

Spectrum Plot for near by DFS band (DFS is required, if 99% OCP straddle into U-NII-2A band)

LAA-single carrier / Chain 0 : CH48

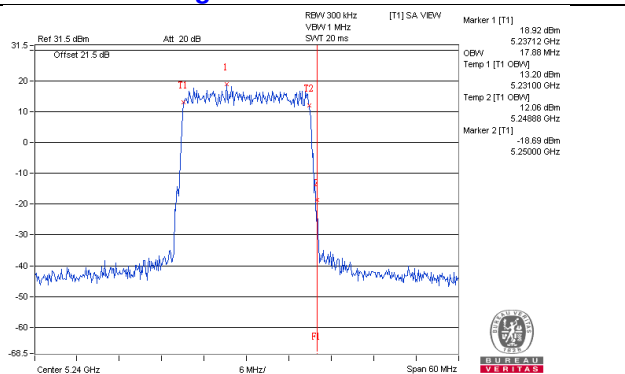

LAA-single carrier / Chain 1 : CH48

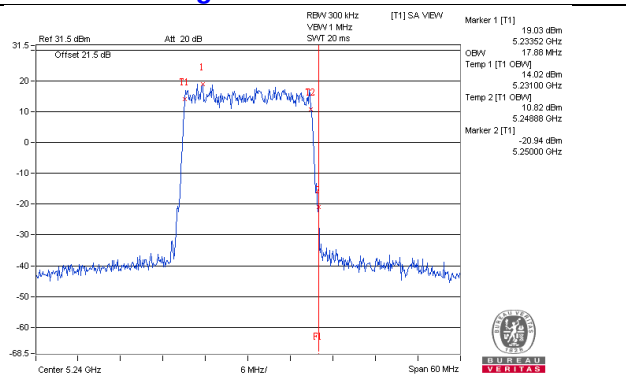

LAA-2 carriers(CA_46C) / Chain 0 : CH40+44

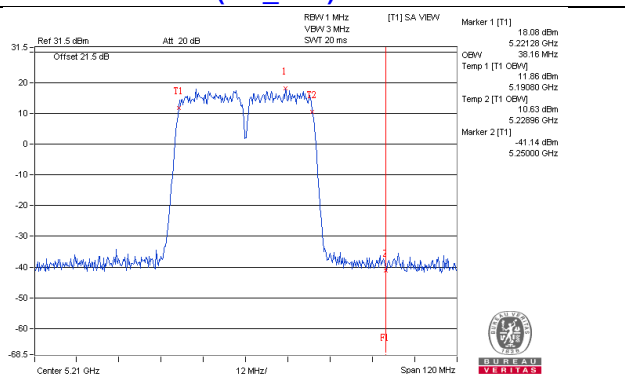

LAA-2 carriers(CA_46C) / Chain 1 : CH40+44

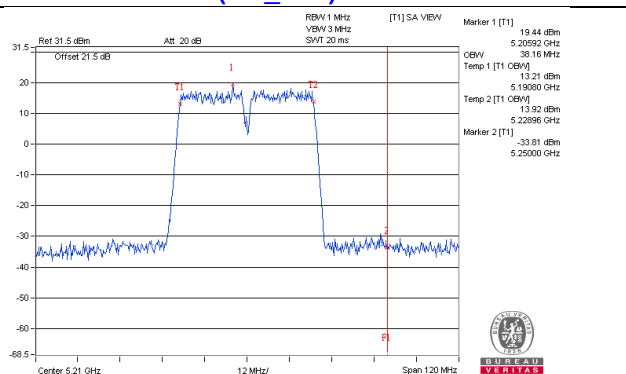

LAA-2 carriers(CA_46C) / Chain 0 : CH44+48

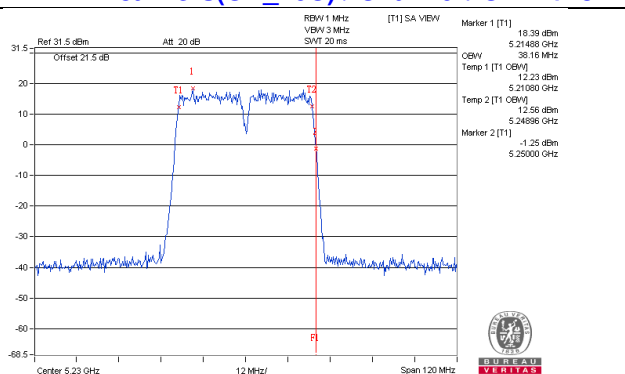

LAA-2 carriers(CA_46C) / Chain 1 : CH44+48

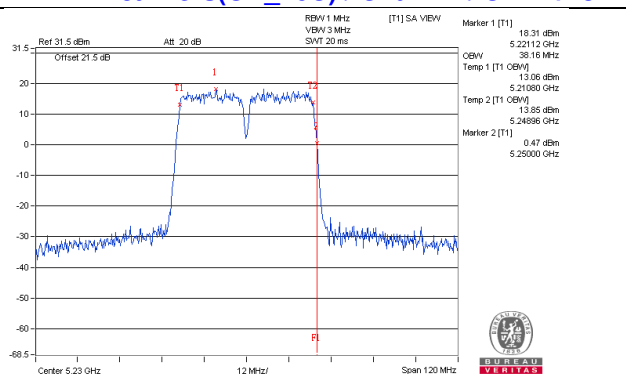

LAA-2 carriers(CA_46A-46A) / Chain 0 : CH48

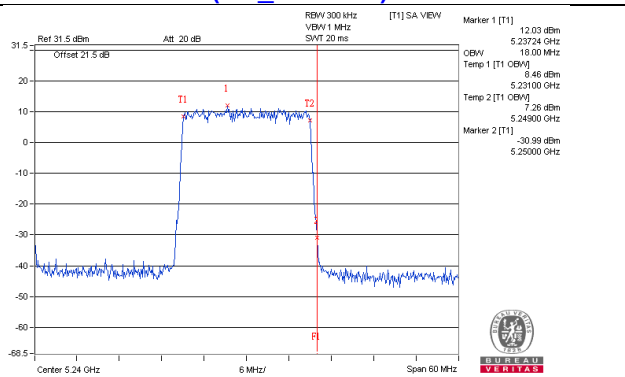

LAA-2 carriers(CA_46A-46A) / Chain 1 : CH48

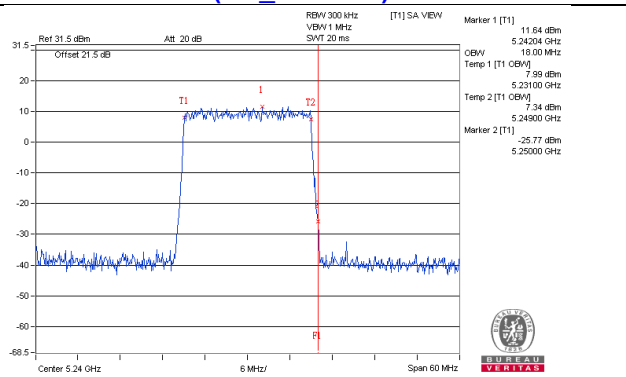

Spectrum Plot for near by DFS band (DFS is required, if 99% OCP straddle into U-NII-2C band)

LAA-single carrier / Chain 0 : CH149

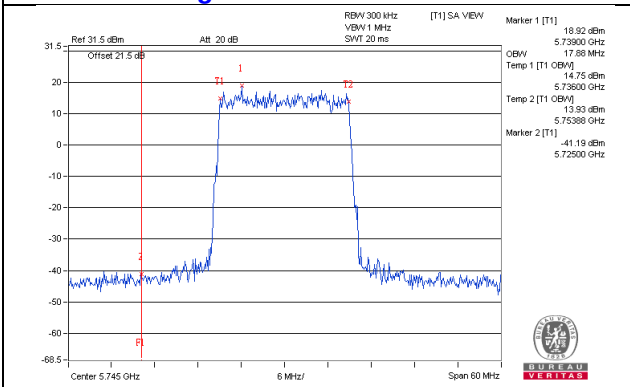

LAA-single carrier / Chain 1 : CH149

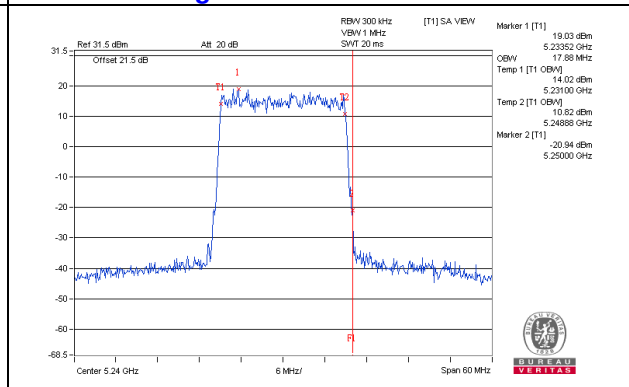

LAA-2 carriers(CA_46C) / Chain 0 : CH149+153

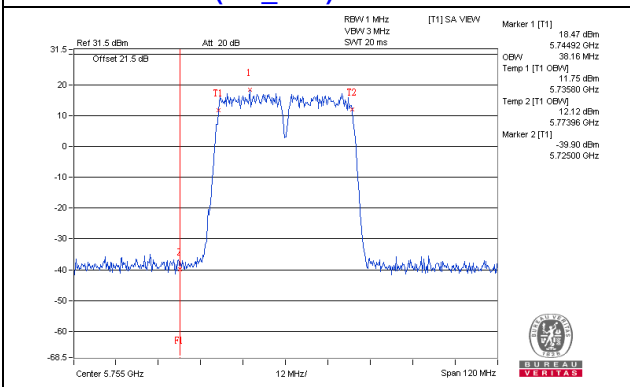

LAA-2 carriers(CA_46C) / Chain 1 : CH149+153

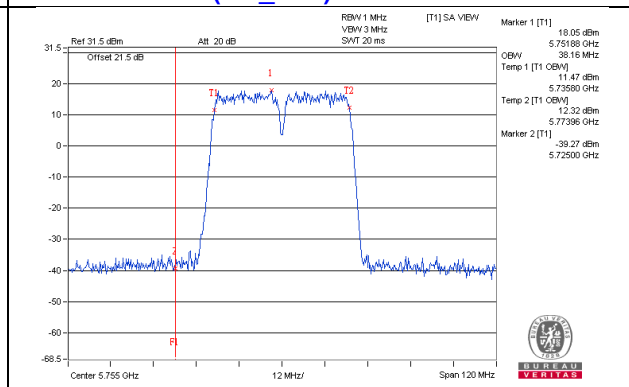

LAA-2 carriers(CA_46C) / Chain 0 : CH153+157

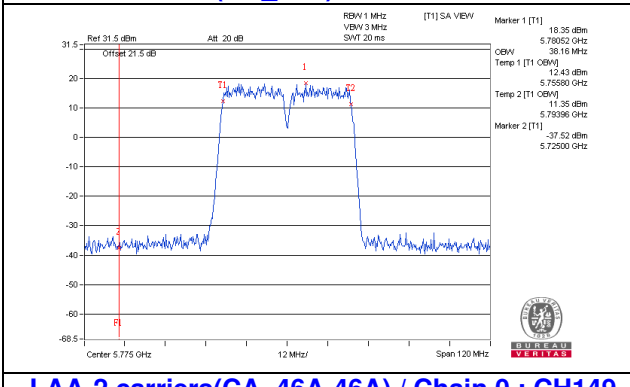

LAA-2 carriers(CA_46C) / Chain 1 : CH153+157

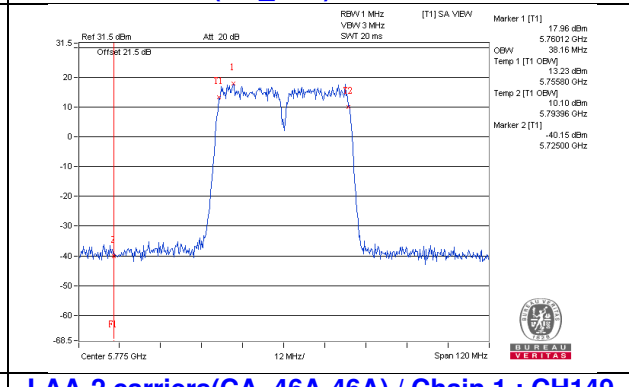

LAA-2 carriers(CA_46A-46A) / Chain 0 : CH149

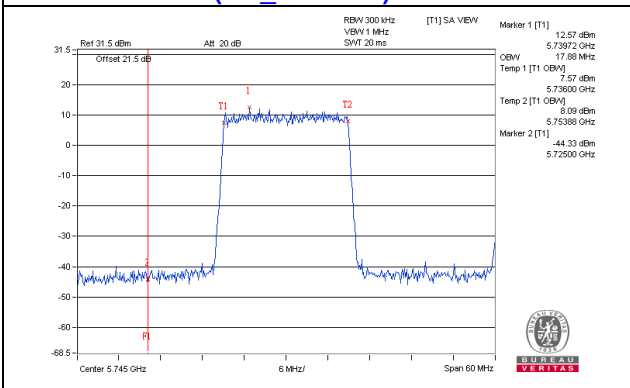

LAA-2 carriers(CA_46A-46A) / Chain 1 : CH149

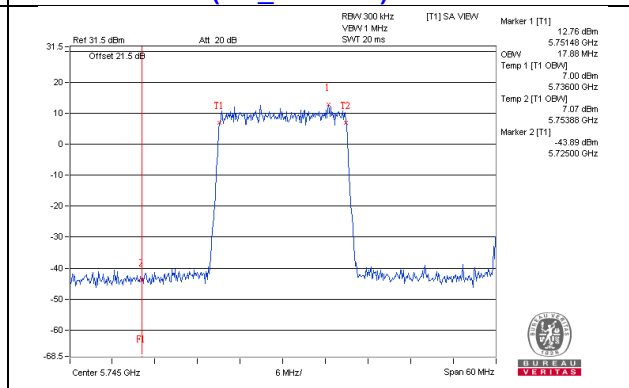

4.5 Peak Power Spectral Density Measurement

4.5.1 Limits of Peak Power Spectral Density Measurement

Operation Band	EUT Category		Limit
U-NII-1		Outdoor Access Point	17dBm/ MHz
		Fixed point-to-point Access Point	
	√	Indoor Access Point	
		Mobile and Portable client device	11dBm/ MHz
U-NII-2A	---		11dBm/ MHz
U-NII-2C	---		11dBm/ MHz
U-NII-3	√		30dBm/ 500kHz

4.5.2 Test Setup

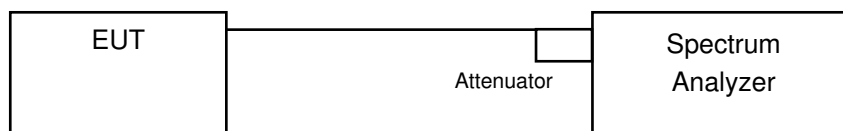

4.5.3 Test Instruments

Refer to section 4.1.2 to get information of above instrument.

4.5.4 Test Procedure

For U-NII-1:

Using method SA-1

1. Set span to encompass the entire emission bandwidth (EBW) of the signal.
2. Set RBW = 1 MHz, Set VBW ≥ 3 MHz, Detector = RMS
3. Sweep time = auto, trigger set to "free run".
4. Trace average at least 100 traces in power averaging mode.
5. Record the max value

For U-NII-3:

1. Set span to encompass the entire emission bandwidth (EBW) of the signal.
2. Set RBW = 300 kHz, Set VBW ≥ 1 MHz, Detector = RMS
3. Use the peak marker function to determine the maximum power level in any 300 kHz band segment within the fundamental EBW.
4. Scale the observed power level to an equivalent value in 500 kHz by adjusting (reducing) the measured power by a bandwidth correction factor (BWCF) where $BWCF = 10\log(500\text{ kHz}/300\text{ kHz})$
5. Sweep time = auto, trigger set to "free run".
6. Trace average at least 100 traces in power averaging mode.
7. Record the max value

4.5.5 Deviation from Test Standard

No deviation.

4.5.6 EUT Operating Condition

Same as Item 4.3.6.

4.5.7 Test Results

For U-NII-1:

LAA-single carrier

Chan.	Chan. Freq. (MHz)	PSD (dBm/MHz)		Total Power Density (dBm/MHz)	MAX. Limit (dBm/MHz)	Pass / Fail
		Chain 0	Chain 1			
32	5160	4.78	4.56	7.68	15.34	Pass
36	5180	10.30	10.72	13.53	15.34	Pass
40	5200	10.82	11.09	13.97	15.34	Pass
44	5220	11.18	11.30	14.25	15.34	Pass
48	5240	11.13	11.81	14.49	15.34	Pass

- Note:** 1. Method a) of power density measurement of KDB 662911 is using for calculating total power density. Total power density is summing entire spectra across corresponding frequency bins on the various outputs by computer.
 2. Directional gain = 7.66dBi > 6dBi , so the power density limit shall be reduced to $17-(7.66-6)$ = 15.34dBm.

LAA-2 carriers (CA_46C)

Chan.	Chan. Freq. (MHz)	PSD (dBm/MHz)		Total Power Density (dBm/MHz)	MAX. Limit (dBm/MHz)	Pass / Fail
		Chain 0	Chain 1			
32+36	5160 + 5180	2.68	3.11	5.91	15.34	Pass
36+40	5180 + 5200	6.42	6.83	9.64	15.34	Pass
40+44	5200 + 5220	7.27	7.57	10.43	15.34	Pass
44+48	5220 + 5240	7.45	7.55	10.51	15.34	Pass

- Note:** 1. Method a) of power density measurement of KDB 662911 is using for calculating total power density. Total power density is summing entire spectra across corresponding frequency bins on the various outputs by computer.
 2. Directional gain = 7.66dBi > 6dBi , so the power density limit shall be reduced to $17-(7.66-6)$ = 15.34dBm.

LAA-2 carriers (CA_46A-46A)

Chan.	Chan. Freq. (MHz)	PSD (dBm/MHz)		Total Power Density (dBm/MHz)	MAX. Limit (dBm/MHz)	Pass / Fail
		Chain 0	Chain 1			
32+40	5160	3.25	3.55	6.41	15.34	Pass
	5200	3.35	3.50	6.44	15.34	Pass
36+44	5180	5.15	5.19	8.18	15.34	Pass
	5220	5.39	5.44	8.43	15.34	Pass
40+48	5200	6.22	6.23	9.24	15.34	Pass
	5240	6.29	6.25	9.28	15.34	Pass

- Note:** 1. Method a) of power density measurement of KDB 662911 is using for calculating total power density. Total power density is summing entire spectra across corresponding frequency bins on the various outputs by computer.
2. Directional gain = 7.66dBi > 6dBi , so the power density limit shall be reduced to $17-(7.66-6) = 15.34\text{dBm}$.

LAA-3 carriers (CA_46D)

Chan.	Chan. Freq. (MHz)	PSD (dBm/MHz)		Total Power Density (dBm/MHz)	MAX. Limit (dBm/MHz)	Pass / Fail
		Chain 0	Chain 1			
32+36+40	5160 + 5180 + 5200	1.01	1.24	4.14	15.34	Pass
36+40+44	5180 + 5200 + 5220	3.43	3.80	6.63	15.34	Pass
40+44+48	5200 + 5220 + 5240	5.66	5.15	8.42	15.34	Pass

- Note:** 1. Method a) of power density measurement of KDB 662911 is using for calculating total power density. Total power density is summing entire spectra across corresponding frequency bins on the various outputs by computer.
2. Directional gain = 7.66dBi > 6dBi , so the power density limit shall be reduced to $17-(7.66-6) = 15.34\text{dBm}$.

Spectrum Plot of Worst Value

LAA-single carrier / Chain 1 : CH48

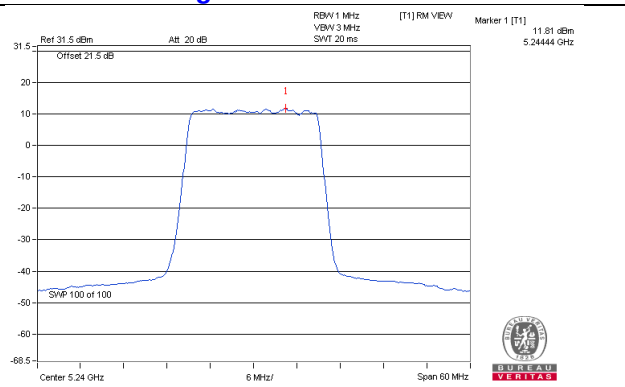

LAA-2 carriers(CA_46C) / Chain 1 : CH40+44

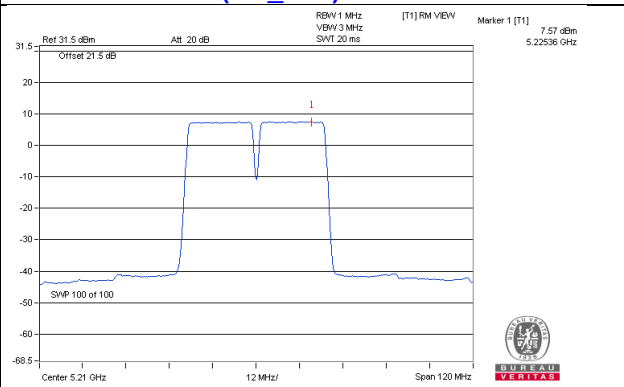

LAA-2 carriers(CA_46A-46A) / Chain 0 : CH40+48

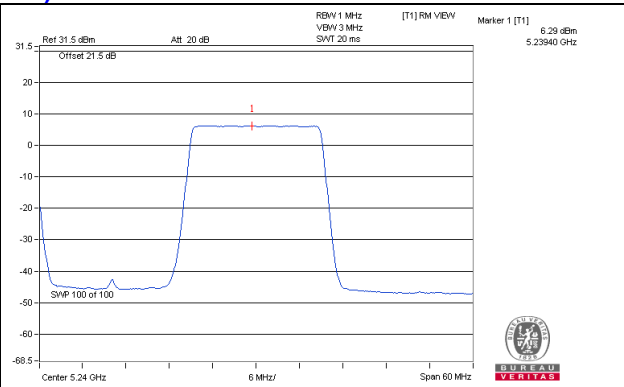
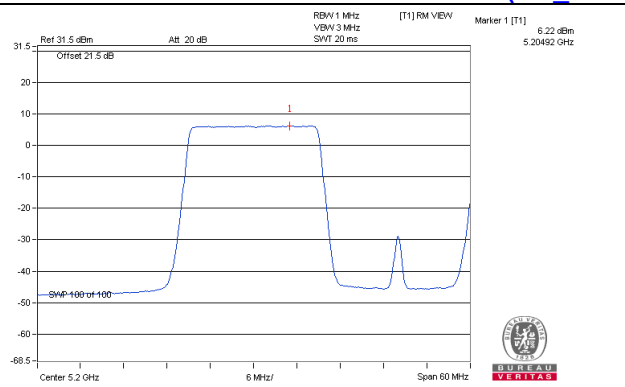

LAA-3 carriers(CA_46D) / Chain 0 : CH40+44+48

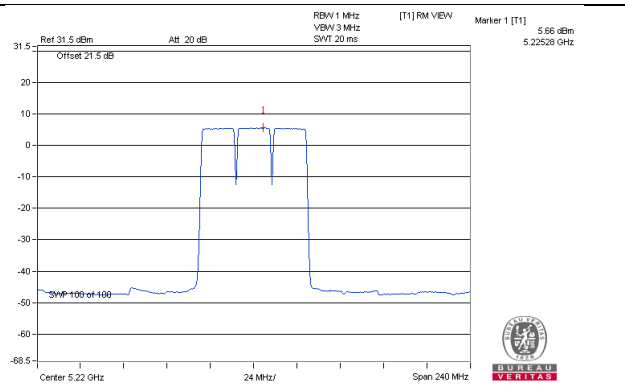

For U-NII-3:

LAA-single carrier

TX chain	Channel	Freq. (MHz)	PSD (dBm/300kHz)	PSD (dBm/500kHz)	10 log (N=2) dB	Total PSD (dBm/500kHz)	Limit (dBm/500kHz)	Pass /Fail
0	149	5745	3.17	5.39	3.01	8.40	28.34	Pass
	153	5765	3.50	5.72	3.01	8.73	28.34	Pass
	157	5785	3.09	5.31	3.01	8.32	28.34	Pass
	161	5805	3.36	5.58	3.01	8.59	28.34	Pass
	165	5825	3.62	5.84	3.01	8.85	28.34	Pass
1	149	5745	4.19	6.41	3.01	9.42	28.34	Pass
	153	5765	3.39	5.61	3.01	8.62	28.34	Pass
	157	5785	3.05	5.27	3.01	8.28	28.34	Pass
	161	5805	3.62	5.84	3.01	8.85	28.34	Pass
	165	5825	3.44	5.66	3.01	8.67	28.34	Pass

Note: Directional gain = 7.66dBi > 6dBi , so the power density limit shall be reduced to $30-(7.66-6)$ = 28.34dBm.

LAA-2 carriers (CA_46C)

TX chain	Channel	Freq. (MHz)	PSD (dBm/300kHz)	PSD (dBm/500kHz)	10 log (N=2) dB	Total PSD (dBm/500kHz)	Limit (dBm/500kHz)	Pass /Fail
0	149+153	5745 + 5765	-1.73	0.49	3.01	3.50	28.34	Pass
	153+157	5765 + 5785	-1.52	0.70	3.01	3.71	28.34	Pass
	157+161	5785 + 5805	-1.80	0.42	3.01	3.43	28.34	Pass
	161+165	5805 + 5825	-1.50	0.72	3.01	3.73	28.34	Pass
1	149+153	5745 + 5765	-1.20	1.02	3.01	4.03	28.34	Pass
	153+157	5765 + 5785	-1.60	0.62	3.01	3.63	28.34	Pass
	157+161	5785 + 5805	-1.70	0.52	3.01	3.53	28.34	Pass
	161+165	5805 + 5825	-1.19	1.03	3.01	4.04	28.34	Pass

Note: Directional gain = 7.66dBi > 6dBi , so the power density limit shall be reduced to $30-(7.66-6)$ = 28.34dBm.

LAA-2 carriers (CA_46C)

TX chain	Channel	Freq. (MHz)	PSD (dBm/300kHz)	PSD (dBm/500kHz)	10 log (N=2) dB	Total PSD (dBm/500kHz)	Limit (dBm/500kHz)	Pass /Fail
0	149+157	5745	-2.72	-0.50	3.01	2.51	28.34	Pass
		5785	-2.74	-0.52	3.01	2.49	28.34	Pass
	153+161	5765	-2.39	-0.17	3.01	2.84	28.34	Pass
		5805	-2.70	-0.48	3.01	2.53	28.34	Pass
	157+165	5785	-2.26	-0.04	3.01	2.97	28.34	Pass
		5825	-2.44	-0.22	3.01	2.79	28.34	Pass
1	149+157	5745	-2.68	-0.46	3.01	2.55	28.34	Pass
		5785	-2.90	-0.68	3.01	2.33	28.34	Pass
	153+161	5765	-2.70	-0.48	3.01	2.53	28.34	Pass
		5805	-2.93	-0.71	3.01	2.30	28.34	Pass
	157+165	5785	-2.33	-0.11	3.01	2.90	28.34	Pass
		5825	-2.45	-0.23	3.01	2.78	28.34	Pass

Note: Directional gain = 7.66dBi > 6dBi , so the power density limit shall be reduced to $30-(7.66-6)$ = 28.34dBm.

LAA-3 carriers (CA_46D)

TX chain	Channel	Freq. (MHz)	PSD (dBm/300kHz)	PSD (dBm/500kHz)	10 log (N=2) dB	Total PSD (dBm/500kHz)	Limit (dBm/500kHz)	Pass /Fail
0	149+153+157	5745 + 5765 + 5785	-4.12	-1.90	3.01	1.11	28.34	Pass
	153+157+161	5765 + 5785 + 5805	-4.35	-2.13	3.01	0.88	28.34	Pass
	157+161+165	5785 + 5805 + 5825	-4.38	-2.16	3.01	0.85	28.34	Pass
1	149+153+157	5745 + 5765 + 5785	-4.24	-2.02	3.01	0.99	28.34	Pass
	153+157+161	5765 + 5785 + 5805	-3.86	-1.64	3.01	1.37	28.34	Pass
	157+161+165	5785 + 5805 + 5825	-3.80	-1.58	3.01	1.43	28.34	Pass

Note: Directional gain = 7.66dBi > 6dBi , so the power density limit shall be reduced to $30-(7.66-6)$ = 28.34dBm.

Spectrum Plot of Worst Value

LAA-single carrier / Chain 0 : CH165

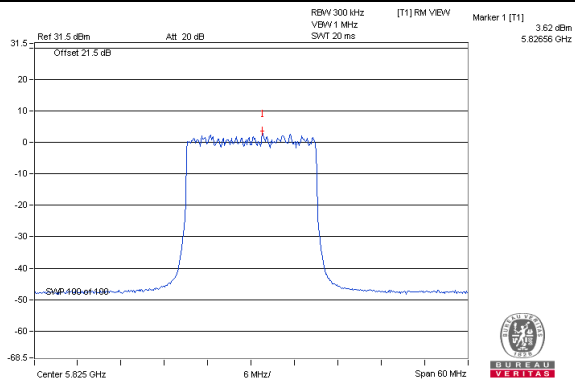

LAA-2 carriers(CA_46C) / Chain 1 : CH161+165

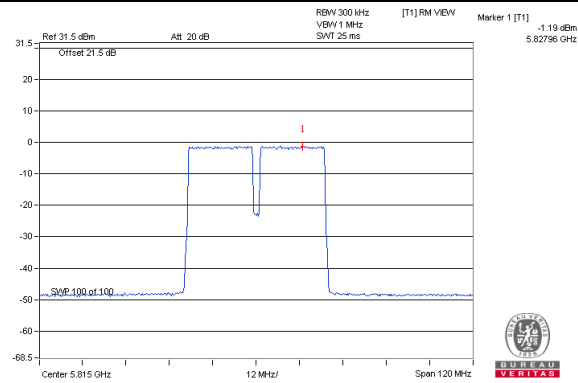

LAA-2 carriers(CA_46A-46A) / Chain 1 : CH157+165

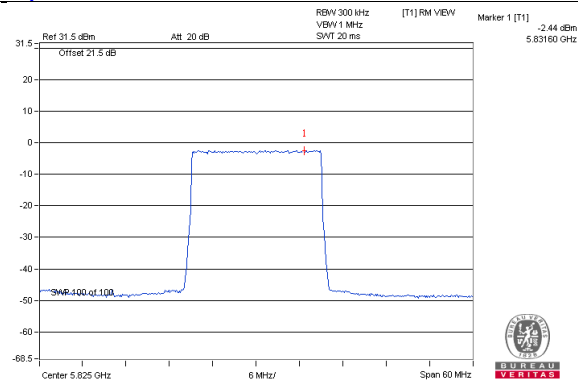
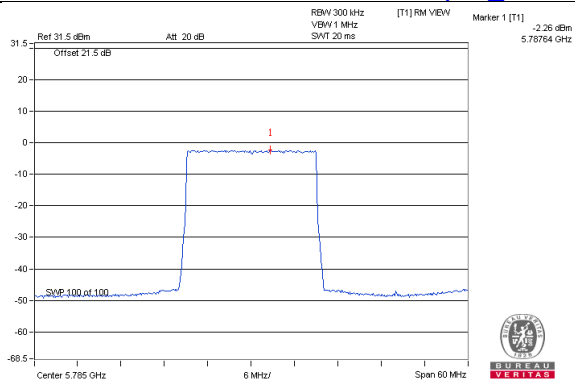

LAA-3 carriers(CA_46D) / Chain 1 : 157+161+165

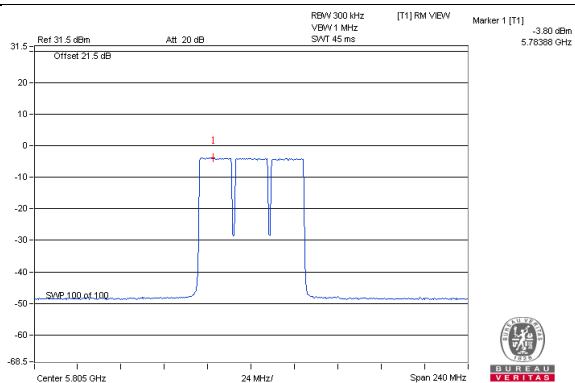

4.6 Frequency Stability Measurement

4.6.1 Limits of Frequency Stability Measurement

The frequency of the carrier signal shall be maintained within band of operation

4.6.2 Test Setup

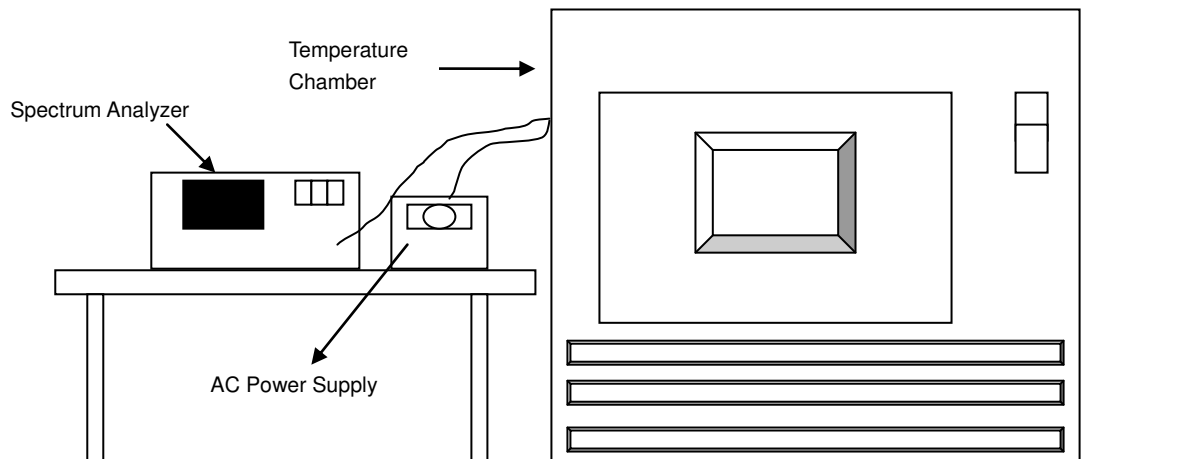

4.6.3 Test Instruments

Refer to section 4.1.2 to get information of above instrument.

4.6.4 Test Procedure

- The EUT was placed inside the environmental test chamber and powered by nominal AC voltage.
- Turn the EUT on and couple its output to a spectrum analyzer.
- Turn the EUT off and set the chamber to the highest temperature specified.
- Allow sufficient time (approximately 30 min) for the temperature of the chamber to stabilize, turn the EUT on and measure the operating frequency after 2, 5, and 10 Minutes.
- Repeat step 2 and 3 with the temperature chamber set to the lowest temperature.
- The test chamber was allowed to stabilize at +20 degree C for a minimum of 30 Minutes. The supply voltage was then adjusted on the EUT from 85% to 115% and the frequency record.

4.6.5 Deviation from Test Standard

No deviation.

4.6.6 EUT Operating Condition

Set the EUT transmit at un-modulation mode to test frequency stability.

4.6.7 Test Results

Frequency Stability Versus Temp.									
Operating Frequency: 5180 MHz									
TEMP. (°C)	Power Supply (Vac)	0 Minute		2 Minute		5 Minute		10 Minute	
		Measured Frequency (MHz)	Pass/Fail	Measured Frequency (MHz)	Pass/Fail	Measured Frequency (MHz)	Pass/Fail	Measured Frequency (MHz)	Pass/Fail
50	120	5180.0182	PASS	5180.0149	PASS	5180.016	PASS	5180.0171	Pass
40	120	5180.003	PASS	5180.0013	PASS	5180.0013	PASS	5180.0011	Pass
30	120	5180.022	PASS	5180.0221	PASS	5180.0228	PASS	5180.0237	Pass
20	120	5179.9867	PASS	5179.9851	PASS	5179.9828	PASS	5179.982	Pass
10	120	5180.0044	PASS	5180.0057	PASS	5180.0061	PASS	5180.006	Pass
0	120	5179.9934	PASS	5179.9919	PASS	5179.9933	PASS	5179.9932	Pass
-10	120	5180.009	PASS	5180.0121	PASS	5180.0114	PASS	5180.0098	Pass
-20	120	5180.0215	PASS	5180.0224	PASS	5180.0212	PASS	5180.0222	Pass
-30	120	5179.9943	PASS	5179.9938	PASS	5179.9942	PASS	5179.9944	Pass

Frequency Stability Versus Voltage									
Operating Frequency: 5180 MHz									
TEMP. (°C)	Power Supply (Vac)	0 Minute		2 Minute		5 Minute		10 Minute	
		Measured Frequency (MHz)	Pass/Fail	Measured Frequency (MHz)	Pass/Fail	Measured Frequency (MHz)	Pass/Fail	Measured Frequency (MHz)	Pass/Fail
20	138	5179.9864	PASS	5179.9843	PASS	5179.982	PASS	5179.9823	Pass
	120	5179.9867	PASS	5179.9851	PASS	5179.9828	PASS	5179.982	Pass
	102	5179.9857	PASS	5179.9844	PASS	5179.9838	PASS	5179.9822	Pass

4.7 6dB Bandwidth Measurement

4.7.1 Limits of 6dB Bandwidth Measurement

The minimum of 6dB Bandwidth Measurement is 0.5MHz.

4.7.2 Test Setup

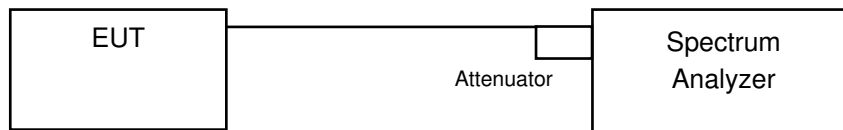

4.7.3 Test Instruments

Refer to section 4.1.2 to get information of above instrument.

4.7.4 Test Procedure

MEASUREMENT PROCEDURE REF

- a. Set resolution bandwidth (RBW) = 100kHz
- b. Set the video bandwidth (VBW) $\geq 3 \times$ RBW, Detector = Peak.
- c. Trace mode = max hold.
- d. Sweep = auto couple.
- e. Measure the maximum width of the emission that is constrained by the frequencies associated with the two amplitude points (upper and lower) that are attenuated by 6 dB relative to the maximum level measured in the fundamental emission

4.7.5 Deviation from Test Standard

No deviation.

4.7.6 EUT Operating Condition

The software provided by client to enable the EUT under transmission condition continuously at lowest, middle and highest channel frequencies individually.

4.7.7 Test Results

LAA-single carrier

Channel	Frequency (MHz)	6dB Bandwidth (MHz)		Minimum Limit (MHz)	Pass / Fail
		Chain 0	Chain 1		
149	5745	18.06	18.03	0.5	Pass
153	5765	18.04	18.02	0.5	Pass
157	5785	18.05	18.06	0.5	Pass
161	5805	18.07	18.04	0.5	Pass
165	5825	18.04	18.04	0.5	Pass

LAA-2 carriers (CA_46C)

Channel	Frequency (MHz)	6dB Bandwidth (MHz)		Minimum Limit (MHz)	Pass / Fail
		Chain 0	Chain 1		
149+153	5745 + 5765	38.18	38.18	0.5	Pass
153+157	5765 + 5785	38.13	38.14	0.5	Pass
157+161	5785 + 5805	38.15	38.12	0.5	Pass
161+165	5805 + 5825	38.15	38.15	0.5	Pass

LAA-2 carriers (CA_46A-46A)

Channel	Frequency (MHz)	6dB Bandwidth (MHz)		Minimum Limit (MHz)	Pass / Fail
		Chain 0	Chain 1		
149+157	5745	18.10	18.10	0.5	Pass
	5785	18.10	18.09	0.5	Pass
153+161	5765	18.07	18.07	0.5	Pass
	5805	18.10	18.09	0.5	Pass
157+165	5785	18.10	18.08	0.5	Pass
	5825	18.07	18.07	0.5	Pass

LAA-3 carriers (CA_46D)

Channel	Frequency (MHz)	6dB Bandwidth (MHz)		Minimum Limit (MHz)	Pass / Fail
		Chain 0	Chain 1		
149+153+157	5745 + 5765 + 5785	58.23	58.19	0.5	Pass
153+157+161	5765 + 5785 + 5805	58.24	58.20	0.5	Pass
157+161+165	5785 + 5805 + 5825	58.31	58.27	0.5	Pass

Spectrum Plot of Worst Value

LAA-single carrier / Chain 1 : CH153

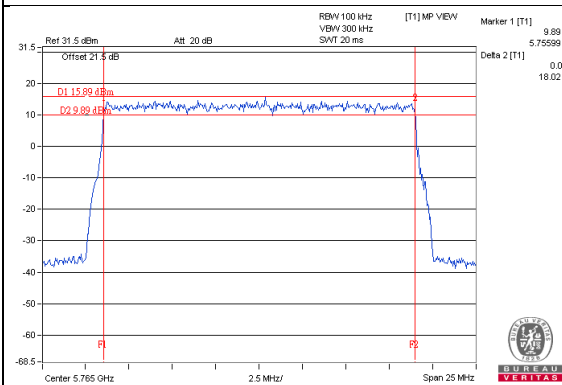

LAA-2 carriers(CA_46C) / Chain 1 : CH157+161

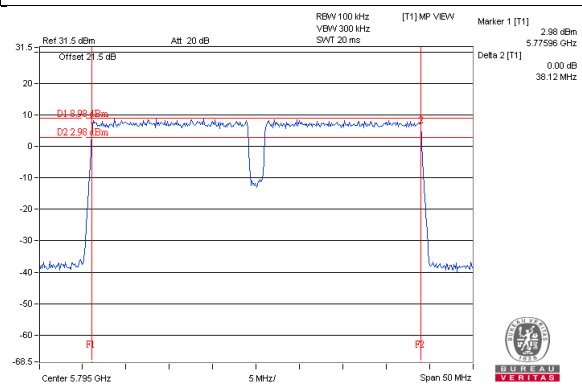

LAA-2 carriers(CA_46A-46A) / Chain 0 : CH157+165

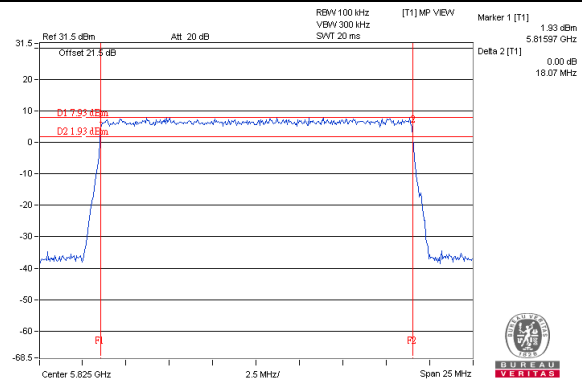
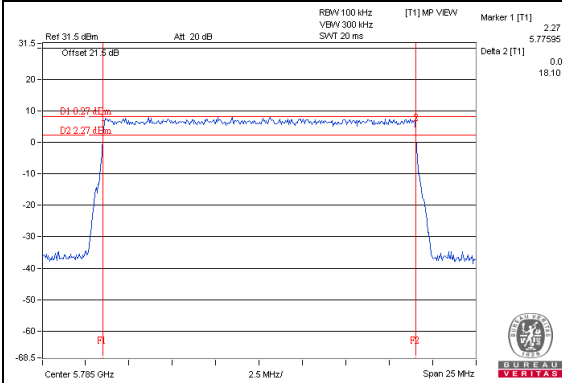

LAA-3 carriers(CA_46D) / Chain 1 : 149+153+157

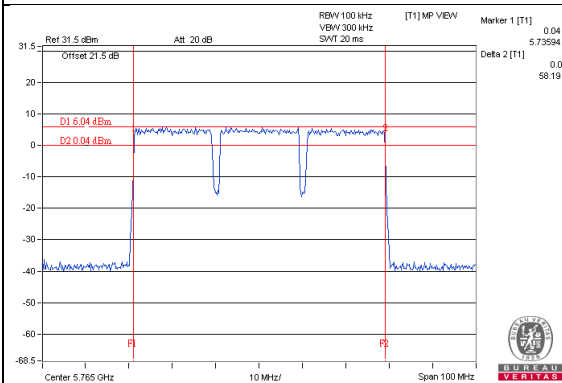

4.8 26dB Bandwidth Measurement

4.8.1 Test Setup



4.8.2 Test Instruments

Refer to section 4.1.2 to get information of above instrument.

4.8.3 Test Procedure

1. Set RBW = approximately 1% of the emission bandwidth.
2. Set the VBW > RBW.
3. Detector = Peak.
4. Trace mode = max hold.
5. Measure the maximum width of the emission that is 26 dB down from the peak of the emission. Compare this with the RBW setting of the analyzer. Readjust RBW and repeat measurement as needed until the RBW/EBW ratio is approximately 1%.

4.8.4 Deviation from Test Standard

No deviation.

4.8.5 EUT Operating Condition

The software provided by client to enable the EUT under transmission condition continuously at lowest, middle and highest channel frequencies individually.

4.8.6 Test Results

LAA-single carrier

Channel	Channel Frequency (MHz)	26dB Bandwidth (MHz)	
		Chain 0	Chain 1
32	5160	19.28	19.41
36	5180	19.46	19.38
40	5200	19.37	19.50
44	5220	19.39	19.39
48	5240	19.49	19.38
149	5745	19.41	19.49
153	5765	19.33	19.33
157	5785	19.40	19.47
161	5805	19.41	19.47
165	5825	19.28	19.46

LAA-2 carriers (CA_46C)

Channel	Channel Frequency (MHz)	26dB Bandwidth (MHz)	
		Chain 0	Chain 1
32+36	5160 + 5180	41.21	41.23
36+40	5180 + 5200	41.32	41.26
40+44	5200 + 5220	41.18	41.30
44+48	5220 + 5240	41.40	41.44
149+153	5745 + 5765	41.23	41.19
153+157	5765 + 5785	41.28	41.27
157+161	5785 + 5805	41.28	41.21
161+165	5805 + 5825	41.22	41.24

LAA-2 carriers (CA_46A-46A)

Channel	Channel Frequency (MHz)	26dB Bandwidth (MHz)	
		Chain 0	Chain 1
32+40	5160	19.37	19.28
	5200	19.31	19.37
36+44	5180	19.37	19.35
	5220	19.28	19.31
40+48	5200	19.33	19.33
	5240	19.30	19.26
149+157	5745	19.26	19.37
	5785	19.24	19.36
153+161	5765	19.41	19.31
	5805	19.33	19.31
157+165	5785	19.41	19.31
	5825	19.36	19.35

LAA-3 carriers (CA_46D)

Channel	Channel Frequency (MHz)	26dB Bandwidth (MHz)	
		Chain 0	Chain 1
32+36+40	5160 + 5180 + 5200	61.53	61.55
36+40+44	5180 + 5200 + 5220	61.43	61.52
40+44+48	5200 + 5220 + 5240	61.36	61.48
149+153+157	5745 + 5765 + 5785	61.32	61.40
153+157+161	5765 + 5785 + 5805	61.63	61.50
157+161+165	5785 + 5805 + 5825	61.49	61.33

Spectrum Plot of Worst Value

LAA-single carrier / Chain 1 : CH40

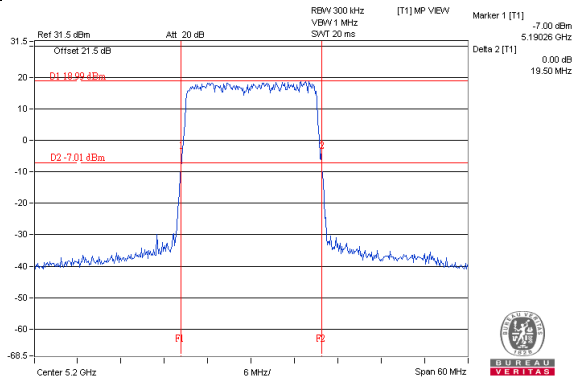

LAA-2 carriers(CA_46C) / Chain 1 : CH44+48

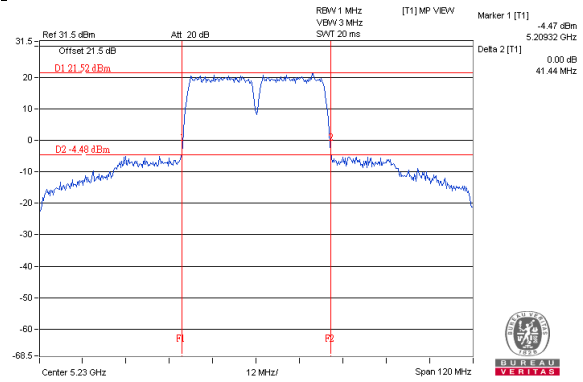

LAA-2 carriers(CA_46A-46A) / Chain 0 : CH157+165

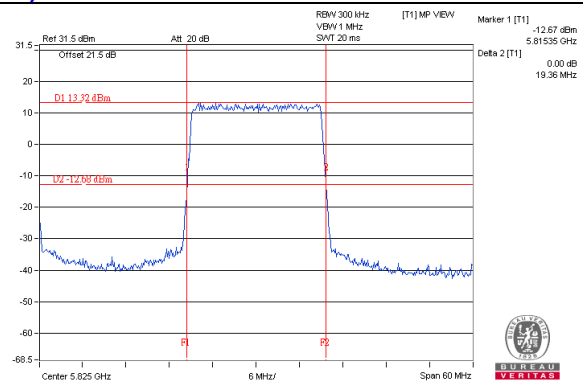
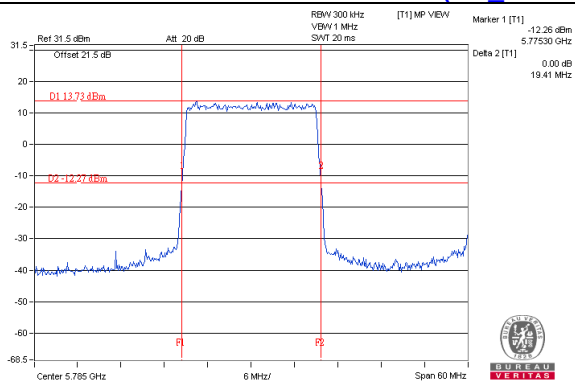

LAA-3 carriers(CA_46D) / Chain 0 : 153+157+161

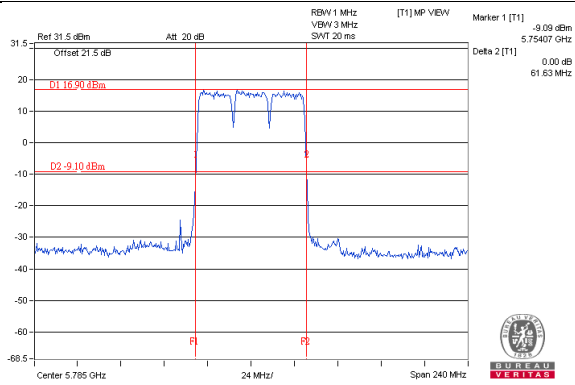

5 Pictures of Test Arrangements

Please refer to the attached file (Test Setup Photo).

Annex A- Radiated Out of Band Emission (OOBE) Measurement (For U-NII-3 band)

LAA-single carrier

CHANNEL	TX Channel 149	DETECTOR FUNCTION	Peak (PK)
FREQUENCY RANGE	1GHz ~ 40GHz		Average (AV)

ANTENNA POLARITY & TEST DISTANCE: HORIZONTAL AT 3 M								
NO.	FREQ. (MHz)	EMISSION LEVEL (dBuV/m)	LIMIT (dBuV/m)	MARGIN (dB)	ANTENNA HEIGHT (m)	TABLE ANGLE (Degree)	RAW VALUE (dBuV)	CORRECTION FACTOR (dB/m)
1	#5647.85	60.9 PK	68.2	-7.3	1.65 H	234	58.3	2.6
2	#5949.00	58.9 PK	68.2	-9.3	1.65 H	234	55.7	3.2

REMARKS:

1. Emission Level(dBuV/m) = Raw Value(dBuV) + Correction Factor(dB/m)
2. Correction Factor(dB/m) = Antenna Factor(dB/m) + Cable Factor(dB) – Pre-Amplifier Factor(dB)
3. The other emission levels were very low against the limit.
4. Margin value = Emission Level – Limit value
5. " # ": The radiated frequency is out of the restricted band.

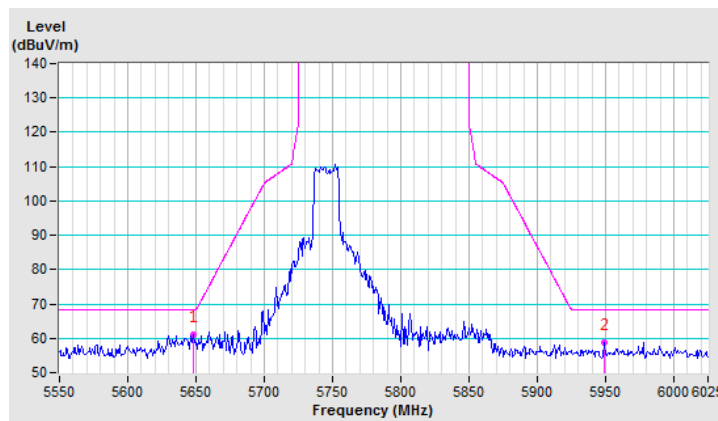

CHANNEL	TX Channel 149	DETECTOR FUNCTION	Peak (PK)
FREQUENCY RANGE	1GHz ~ 40GHz		Average (AV)

ANTENNA POLARITY & TEST DISTANCE: VERTICAL AT 3 M

NO.	FREQ. (MHz)	EMISSION LEVEL (dBuV/m)	LIMIT (dBuV/m)	MARGIN (dB)	ANTENNA HEIGHT (m)	TABLE ANGLE (Degree)	RAW VALUE (dBuV)	CORRECTION FACTOR (dB/m)
1	#5633.12	67.4 PK	68.2	-0.8	2.65 V	5	64.8	2.6
2	#5984.62	58.8 PK	68.2	-9.4	2.65 V	5	55.5	3.3

REMARKS:

1. Emission Level(dBuV/m) = Raw Value(dBuV) + Correction Factor(dB/m)
2. Correction Factor(dB/m) = Antenna Factor(dB/m) + Cable Factor(dB) – Pre-Amplifier Factor(dB)
3. The other emission levels were very low against the limit.
4. Margin value = Emission Level – Limit value
5. " # ": The radiated frequency is out of the restricted band.

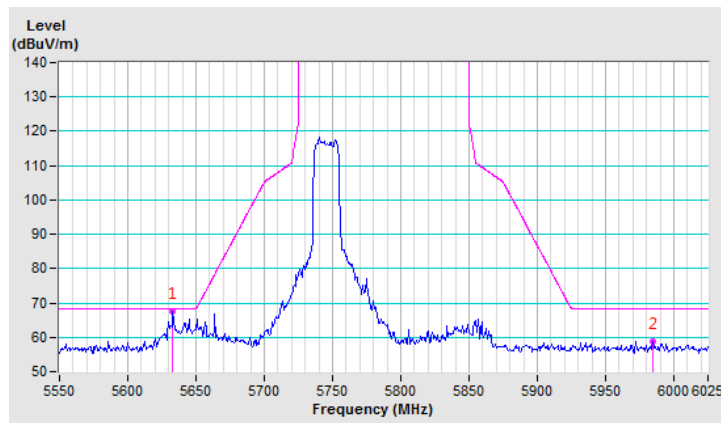

CHANNEL	TX Channel 153	DETECTOR FUNCTION	Peak (PK)
FREQUENCY RANGE	1GHz ~ 40GHz		Average (AV)

ANTENNA POLARITY & TEST DISTANCE: HORIZONTAL AT 3 M

NO.	FREQ. (MHz)	EMISSION LEVEL (dBuV/m)	LIMIT (dBuV/m)	MARGIN (dB)	ANTENNA HEIGHT (m)	TABLE ANGLE (Degree)	RAW VALUE (dBuV)	CORRECTION FACTOR (dB/m)
1	#5634.55	55.9 PK	68.2	-12.3	1.50 H	360	53.4	2.5
2	#5980.82	56.3 PK	68.2	-11.9	1.50 H	360	53.1	3.2

REMARKS:

1. Emission Level(dBuV/m) = Raw Value(dBuV) + Correction Factor(dB/m)
2. Correction Factor(dB/m) = Antenna Factor(dB/m) + Cable Factor(dB) – Pre-Amplifier Factor(dB)
3. The other emission levels were very low against the limit.
4. Margin value = Emission Level – Limit value
5. " # ": The radiated frequency is out of the restricted band.

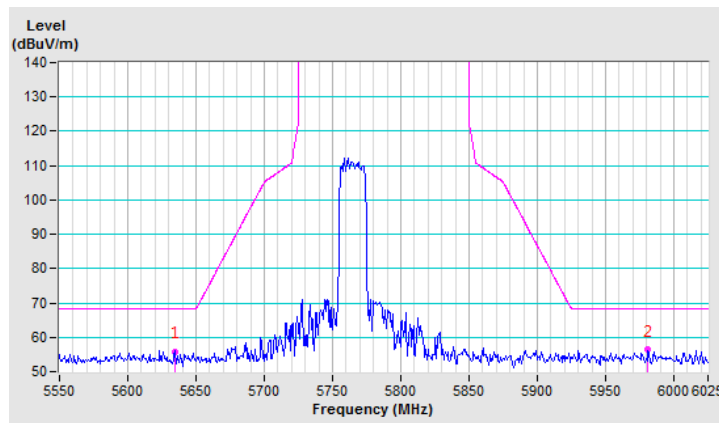

CHANNEL	TX Channel 153	DETECTOR FUNCTION	Peak (PK)
FREQUENCY RANGE	1GHz ~ 40GHz		Average (AV)

ANTENNA POLARITY & TEST DISTANCE: VERTICAL AT 3 M

NO.	FREQ. (MHz)	EMISSION LEVEL (dBuV/m)	LIMIT (dBuV/m)	MARGIN (dB)	ANTENNA HEIGHT (m)	TABLE ANGLE (Degree)	RAW VALUE (dBuV)	CORRECTION FACTOR (dB/m)
1	#5594.65	59.5 PK	68.2	-8.7	3.28 V	35	57.2	2.3
2	#5958.98	60.1 PK	68.2	-8.1	3.28 V	35	57.1	3.0

REMARKS:

1. Emission Level(dBuV/m) = Raw Value(dBuV) + Correction Factor(dB/m)
2. Correction Factor(dB/m) = Antenna Factor(dB/m) + Cable Factor(dB) – Pre-Amplifier Factor(dB)
3. The other emission levels were very low against the limit.
4. Margin value = Emission Level – Limit value
5. " # ": The radiated frequency is out of the restricted band.

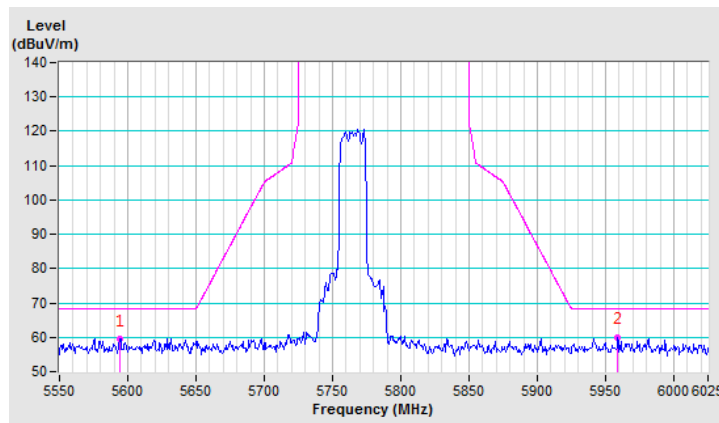

CHANNEL	TX Channel 157	DETECTOR FUNCTION	Peak (PK)
FREQUENCY RANGE	1GHz ~ 40GHz		Average (AV)

ANTENNA POLARITY & TEST DISTANCE: HORIZONTAL AT 3 M

NO.	FREQ. (MHz)	EMISSION LEVEL (dBuV/m)	LIMIT (dBuV/m)	MARGIN (dB)	ANTENNA HEIGHT (m)	TABLE ANGLE (Degree)	RAW VALUE (dBuV)	CORRECTION FACTOR (dB/m)
1	#5574.70	59.6 PK	68.2	-8.6	1.05 H	120	57.1	2.5
2	#5987.00	58.0 PK	68.2	-10.2	1.05 H	120	54.7	3.3

REMARKS:

1. Emission Level(dBuV/m) = Raw Value(dBuV) + Correction Factor(dB/m)
2. Correction Factor(dB/m) = Antenna Factor(dB/m) + Cable Factor(dB) – Pre-Amplifier Factor(dB)
3. The other emission levels were very low against the limit.
4. Margin value = Emission Level – Limit value
5. " # ": The radiated frequency is out of the restricted band.

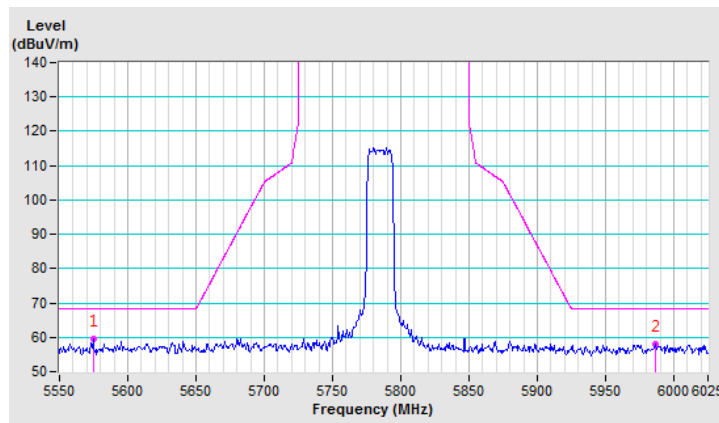

CHANNEL	TX Channel 157	DETECTOR FUNCTION	Peak (PK)
FREQUENCY RANGE	1GHz ~ 40GHz		Average (AV)

ANTENNA POLARITY & TEST DISTANCE: VERTICAL AT 3 M

NO.	FREQ. (MHz)	EMISSION LEVEL (dBuV/m)	LIMIT (dBuV/m)	MARGIN (dB)	ANTENNA HEIGHT (m)	TABLE ANGLE (Degree)	RAW VALUE (dBuV)	CORRECTION FACTOR (dB/m)
1	#5580.87	59.0 PK	68.2	-9.2	2.16 V	360	56.5	2.5
2	#5937.12	59.8 PK	68.2	-8.4	2.16 V	360	56.7	3.1

REMARKS:

1. Emission Level(dBuV/m) = Raw Value(dBuV) + Correction Factor(dB/m)
2. Correction Factor(dB/m) = Antenna Factor(dB/m) + Cable Factor(dB) – Pre-Amplifier Factor(dB)
3. The other emission levels were very low against the limit.
4. Margin value = Emission Level – Limit value
5. " # ": The radiated frequency is out of the restricted band.

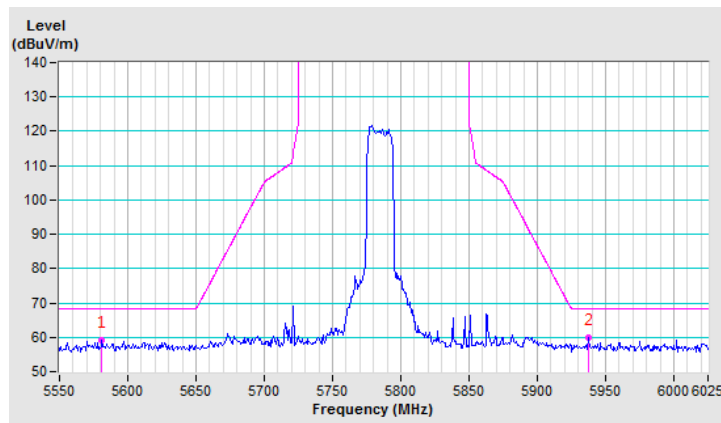

CHANNEL	TX Channel 161	DETECTOR FUNCTION	Peak (PK)
FREQUENCY RANGE	1GHz ~ 40GHz		Average (AV)

ANTENNA POLARITY & TEST DISTANCE: HORIZONTAL AT 3 M

NO.	FREQ. (MHz)	EMISSION LEVEL (dBuV/m)	LIMIT (dBuV/m)	MARGIN (dB)	ANTENNA HEIGHT (m)	TABLE ANGLE (Degree)	RAW VALUE (dBuV)	CORRECTION FACTOR (dB/m)
1	#5598.93	55.4 PK	68.2	-12.8	1.05 H	120	53.1	2.3
2	#5967.05	55.6 PK	68.2	-12.6	1.05 H	120	52.6	3.0

REMARKS:

1. Emission Level(dBuV/m) = Raw Value(dBuV) + Correction Factor(dB/m)
2. Correction Factor(dB/m) = Antenna Factor(dB/m) + Cable Factor(dB) – Pre-Amplifier Factor(dB)
3. The other emission levels were very low against the limit.
4. Margin value = Emission Level – Limit value
5. " # ": The radiated frequency is out of the restricted band.

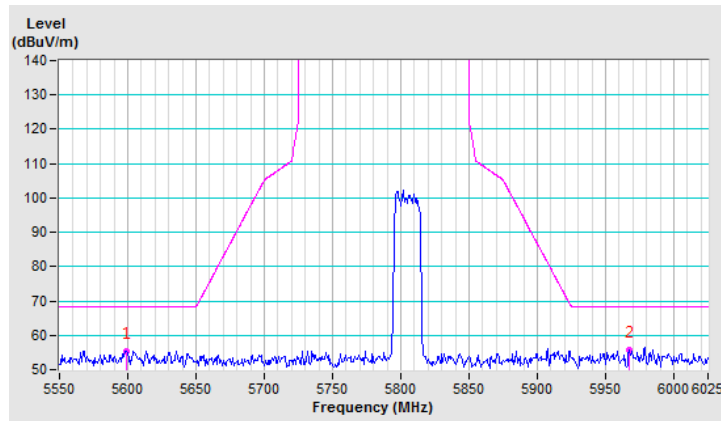

CHANNEL	TX Channel 161	DETECTOR FUNCTION	Peak (PK)
FREQUENCY RANGE	1GHz ~ 40GHz		Average (AV)

ANTENNA POLARITY & TEST DISTANCE: VERTICAL AT 3 M

NO.	FREQ. (MHz)	EMISSION LEVEL (dBuV/m)	LIMIT (dBuV/m)	MARGIN (dB)	ANTENNA HEIGHT (m)	TABLE ANGLE (Degree)	RAW VALUE (dBuV)	CORRECTION FACTOR (dB/m)
1	#5693.93	64.3 PK	100.7	-36.4	2.15 V	72	61.6	2.7
2	#5948.05	57.6 PK	68.2	-10.6	2.15 V	72	54.6	3.0

REMARKS:

1. Emission Level(dBuV/m) = Raw Value(dBuV) + Correction Factor(dB/m)
2. Correction Factor(dB/m) = Antenna Factor(dB/m) + Cable Factor(dB) – Pre-Amplifier Factor(dB)
3. The other emission levels were very low against the limit.
4. Margin value = Emission Level – Limit value
5. " # ": The radiated frequency is out of the restricted band.

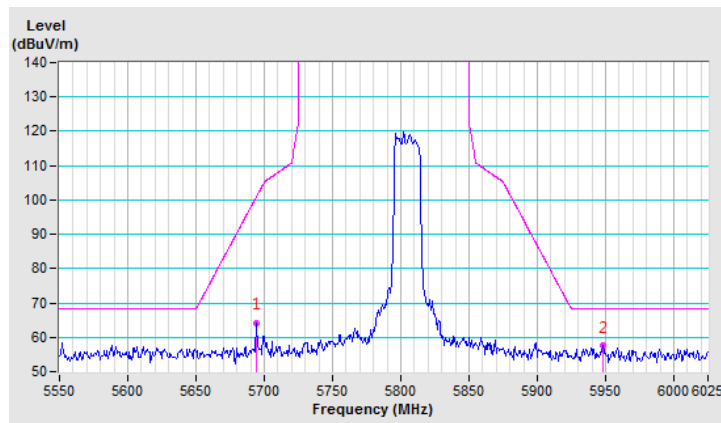

CHANNEL	TX Channel 165	DETECTOR FUNCTION	Peak (PK)
FREQUENCY RANGE	1GHz ~ 40GHz		Average (AV)

ANTENNA POLARITY & TEST DISTANCE: HORIZONTAL AT 3 M

NO.	FREQ. (MHz)	EMISSION LEVEL (dBuV/m)	LIMIT (dBuV/m)	MARGIN (dB)	ANTENNA HEIGHT (m)	TABLE ANGLE (Degree)	RAW VALUE (dBuV)	CORRECTION FACTOR (dB/m)
1	#5616.98	59.1 PK	68.2	-9.1	1.05 H	120	56.5	2.6
2	#5940.45	57.9 PK	68.2	-10.3	1.05 H	120	54.8	3.1

REMARKS:

1. Emission Level(dBuV/m) = Raw Value(dBuV) + Correction Factor(dB/m)
2. Correction Factor(dB/m) = Antenna Factor(dB/m) + Cable Factor(dB) – Pre-Amplifier Factor(dB)
3. The other emission levels were very low against the limit.
4. Margin value = Emission Level – Limit value
5. " # ": The radiated frequency is out of the restricted band.

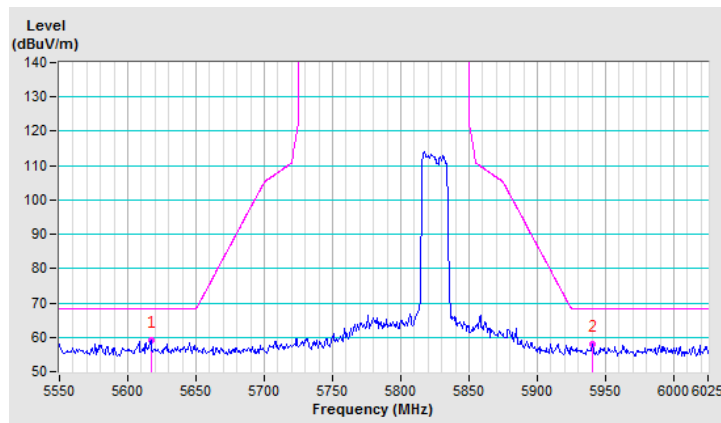

CHANNEL	TX Channel 165	DETECTOR FUNCTION	Peak (PK)
FREQUENCY RANGE	1GHz ~ 40GHz		Average (AV)

ANTENNA POLARITY & TEST DISTANCE: VERTICAL AT 3 M

NO.	FREQ. (MHz)	EMISSION LEVEL (dBuV/m)	LIMIT (dBuV/m)	MARGIN (dB)	ANTENNA HEIGHT (m)	TABLE ANGLE (Degree)	RAW VALUE (dBuV)	CORRECTION FACTOR (dB/m)
1	#5583.73	58.2 PK	68.2	-10.0	2.45 V	360	55.7	2.5
2	#5998.87	58.3 PK	68.2	-9.9	2.45 V	360	54.9	3.4

REMARKS:

1. Emission Level(dBuV/m) = Raw Value(dBuV) + Correction Factor(dB/m)
2. Correction Factor(dB/m) = Antenna Factor(dB/m) + Cable Factor(dB) – Pre-Amplifier Factor(dB)
3. The other emission levels were very low against the limit.
4. Margin value = Emission Level – Limit value
5. " # ": The radiated frequency is out of the restricted band.

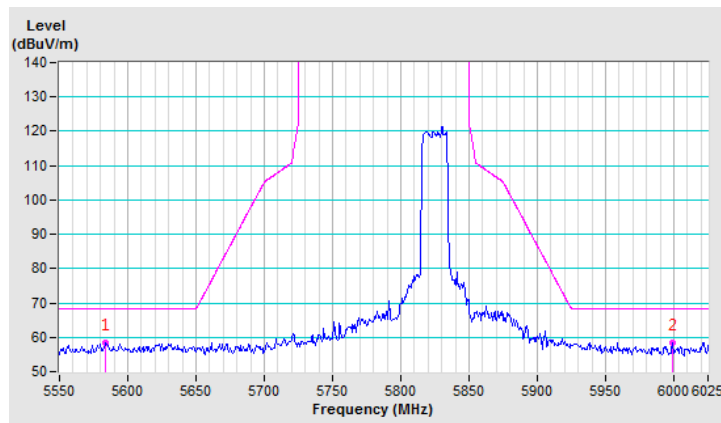

LAA-2 carriers (CA_46C)

CHANNEL	TX Channel 149+153	DETECTOR FUNCTION	Peak (PK)
FREQUENCY RANGE	1GHz ~ 40GHz		Average (AV)

ANTENNA POLARITY & TEST DISTANCE: HORIZONTAL AT 3 M

NO.	FREQ. (MHz)	EMISSION LEVEL (dBuV/m)	LIMIT (dBuV/m)	MARGIN (dB)	ANTENNA HEIGHT (m)	TABLE ANGLE (Degree)	RAW VALUE (dBuV)	CORRECTION FACTOR (dB/m)
1	#5603.20	57.0 PK	68.2	-11.2	1.02 H	161	54.5	2.5
2	#5926.20	58.1 PK	68.2	-10.1	1.02 H	161	55.0	3.1

REMARKS:

1. Emission Level(dBuV/m) = Raw Value(dBuV) + Correction Factor(dB/m)
2. Correction Factor(dB/m) = Antenna Factor(dB/m) + Cable Factor(dB) – Pre-Amplifier Factor(dB)
3. The other emission levels were very low against the limit.
4. Margin value = Emission Level – Limit value
5. " # ": The radiated frequency is out of the restricted band.

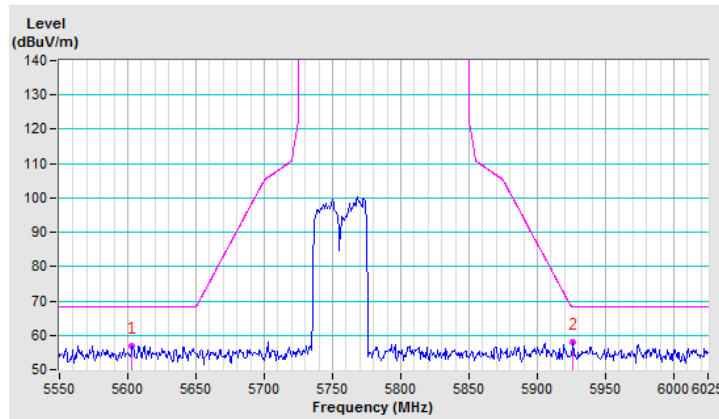

CHANNEL	TX Channel 149+153	DETECTOR FUNCTION	Peak (PK)
FREQUENCY RANGE	1GHz ~ 40GHz		Average (AV)

ANTENNA POLARITY & TEST DISTANCE: VERTICAL AT 3 M

NO.	FREQ. (MHz)	EMISSION LEVEL (dBuV/m)	LIMIT (dBuV/m)	MARGIN (dB)	ANTENNA HEIGHT (m)	TABLE ANGLE (Degree)	RAW VALUE (dBuV)	CORRECTION FACTOR (dB/m)
1	#5648.80	60.9 PK	68.2	-7.3	2.47 V	69	58.3	2.6
2	#5943.30	57.4 PK	68.2	-10.8	2.47 V	69	54.3	3.1

REMARKS:

1. Emission Level(dBuV/m) = Raw Value(dBuV) + Correction Factor(dB/m)
2. Correction Factor(dB/m) = Antenna Factor(dB/m) + Cable Factor(dB) – Pre-Amplifier Factor(dB)
3. The other emission levels were very low against the limit.
4. Margin value = Emission Level – Limit value
5. " # ": The radiated frequency is out of the restricted band.

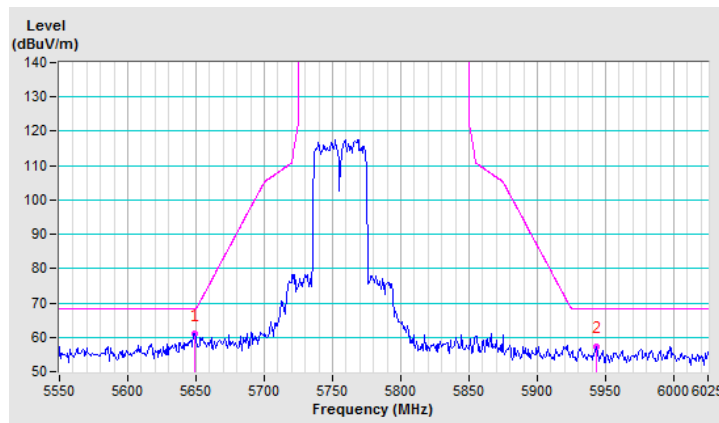

CHANNEL	TX Channel 153+157	DETECTOR FUNCTION	Peak (PK)
FREQUENCY RANGE	1GHz ~ 40GHz		Average (AV)

ANTENNA POLARITY & TEST DISTANCE: HORIZONTAL AT 3 M

NO.	FREQ. (MHz)	EMISSION LEVEL (dBuV/m)	LIMIT (dBuV/m)	MARGIN (dB)	ANTENNA HEIGHT (m)	TABLE ANGLE (Degree)	RAW VALUE (dBuV)	CORRECTION FACTOR (dB/m)
1	#5588.95	56.8 PK	68.2	-11.4	1.25 H	108	54.5	2.3
2	#5975.60	56.5 PK	68.2	-11.7	1.25 H	108	53.4	3.1

REMARKS:

1. Emission Level(dBuV/m) = Raw Value(dBuV) + Correction Factor(dB/m)
2. Correction Factor(dB/m) = Antenna Factor(dB/m) + Cable Factor(dB) – Pre-Amplifier Factor(dB)
3. The other emission levels were very low against the limit.
4. Margin value = Emission Level – Limit value
5. " # ": The radiated frequency is out of the restricted band.

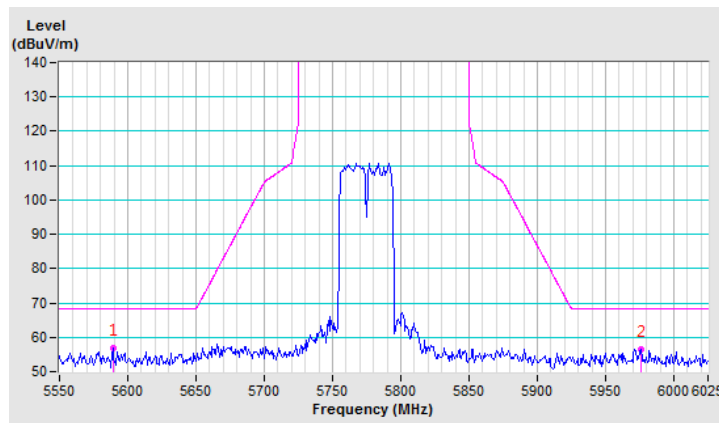

CHANNEL	TX Channel 153+157	DETECTOR FUNCTION	Peak (PK)
FREQUENCY RANGE	1GHz ~ 40GHz		Average (AV)

ANTENNA POLARITY & TEST DISTANCE: VERTICAL AT 3 M

NO.	FREQ. (MHz)	EMISSION LEVEL (dBuV/m)	LIMIT (dBuV/m)	MARGIN (dB)	ANTENNA HEIGHT (m)	TABLE ANGLE (Degree)	RAW VALUE (dBuV)	CORRECTION FACTOR (dB/m)
1	#5662.57	62.3 PK	77.5	-15.2	4.00 V	324	59.8	2.5
2	#5916.70	57.6 PK	74.3	-16.7	4.00 V	324	54.7	2.9

REMARKS:

1. Emission Level(dBuV/m) = Raw Value(dBuV) + Correction Factor(dB/m)
2. Correction Factor(dB/m) = Antenna Factor(dB/m) + Cable Factor(dB) – Pre-Amplifier Factor(dB)
3. The other emission levels were very low against the limit.
4. Margin value = Emission Level – Limit value
5. " # ": The radiated frequency is out of the restricted band.

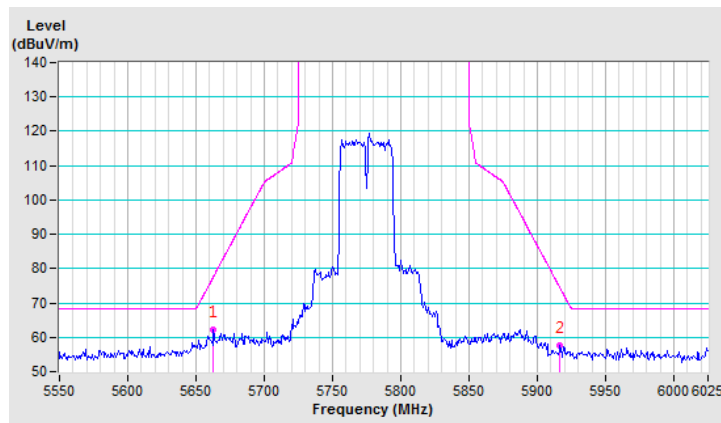

CHANNEL	TX Channel 157+161	DETECTOR FUNCTION	Peak (PK)
FREQUENCY RANGE	1GHz ~ 40GHz		Average (AV)

ANTENNA POLARITY & TEST DISTANCE: HORIZONTAL AT 3 M

NO.	FREQ. (MHz)	EMISSION LEVEL (dBuV/m)	LIMIT (dBuV/m)	MARGIN (dB)	ANTENNA HEIGHT (m)	TABLE ANGLE (Degree)	RAW VALUE (dBuV)	CORRECTION FACTOR (dB/m)
1	#5620.30	57.4 PK	68.2	-10.8	1.02 H	146	54.8	2.6
2	#5944.25	57.6 PK	68.2	-10.6	1.02 H	146	54.5	3.1

REMARKS:

1. Emission Level(dBuV/m) = Raw Value(dBuV) + Correction Factor(dB/m)
2. Correction Factor(dB/m) = Antenna Factor(dB/m) + Cable Factor(dB) – Pre-Amplifier Factor(dB)
3. The other emission levels were very low against the limit.
4. Margin value = Emission Level – Limit value
5. " # ": The radiated frequency is out of the restricted band.

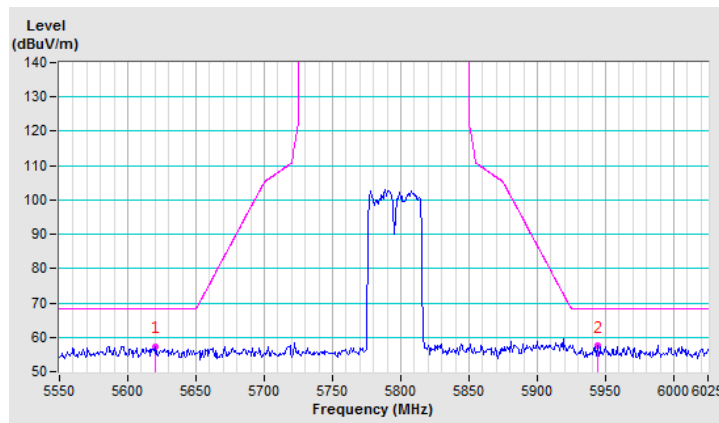

CHANNEL	TX Channel 157+161	DETECTOR FUNCTION	Peak (PK)
FREQUENCY RANGE	1GHz ~ 40GHz		Average (AV)

ANTENNA POLARITY & TEST DISTANCE: VERTICAL AT 3 M

NO.	FREQ. (MHz)	EMISSION LEVEL (dBuV/m)	LIMIT (dBuV/m)	MARGIN (dB)	ANTENNA HEIGHT (m)	TABLE ANGLE (Degree)	RAW VALUE (dBuV)	CORRECTION FACTOR (dB/m)
1	#5611.75	59.2 PK	68.2	-9.0	2.53 V	68	56.6	2.6
2	#5927.62	62.7 PK	68.2	-5.5	2.53 V	68	59.6	3.1

REMARKS:

1. Emission Level(dBuV/m) = Raw Value(dBuV) + Correction Factor(dB/m)
2. Correction Factor(dB/m) = Antenna Factor(dB/m) + Cable Factor(dB) – Pre-Amplifier Factor(dB)
3. The other emission levels were very low against the limit.
4. Margin value = Emission Level – Limit value
5. " # ": The radiated frequency is out of the restricted band.

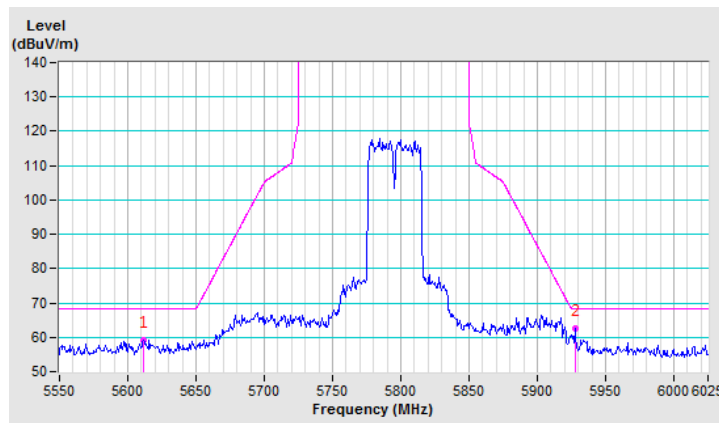

CHANNEL	TX Channel 161+165	DETECTOR FUNCTION	Peak (PK)
FREQUENCY RANGE	1GHz ~ 40GHz		Average (AV)

ANTENNA POLARITY & TEST DISTANCE: HORIZONTAL AT 3 M

NO.	FREQ. (MHz)	EMISSION LEVEL (dBuV/m)	LIMIT (dBuV/m)	MARGIN (dB)	ANTENNA HEIGHT (m)	TABLE ANGLE (Degree)	RAW VALUE (dBuV)	CORRECTION FACTOR (dB/m)
1	#5568.52	57.4 PK	68.2	-10.8	1.00 H	162	54.9	2.5
2	#5930.00	63.5 PK	68.2	-4.7	1.00 H	162	60.4	3.1

REMARKS:

1. Emission Level(dBuV/m) = Raw Value(dBuV) + Correction Factor(dB/m)
2. Correction Factor(dB/m) = Antenna Factor(dB/m) + Cable Factor(dB) – Pre-Amplifier Factor(dB)
3. The other emission levels were very low against the limit.
4. Margin value = Emission Level – Limit value
5. " # ": The radiated frequency is out of the restricted band.

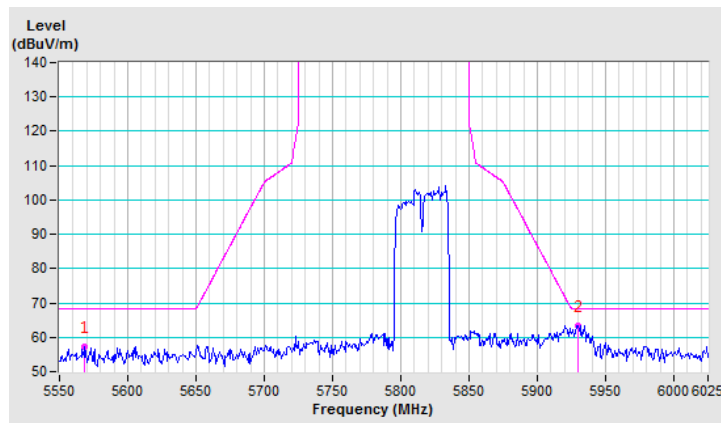

CHANNEL	TX Channel 161+165	DETECTOR FUNCTION	Peak (PK)
FREQUENCY RANGE	1GHz ~ 40GHz		Average (AV)

ANTENNA POLARITY & TEST DISTANCE: VERTICAL AT 3 M

NO.	FREQ. (MHz)	EMISSION LEVEL (dBuV/m)	LIMIT (dBuV/m)	MARGIN (dB)	ANTENNA HEIGHT (m)	TABLE ANGLE (Degree)	RAW VALUE (dBuV)	CORRECTION FACTOR (dB/m)
1	#5639.77	62.7 PK	68.2	-5.5	2.43 V	63	60.1	2.6
2	#5940.45	68.0 PK	68.2	-0.2	2.43 V	63	64.9	3.1

REMARKS:

1. Emission Level(dBuV/m) = Raw Value(dBuV) + Correction Factor(dB/m)
2. Correction Factor(dB/m) = Antenna Factor(dB/m) + Cable Factor(dB) – Pre-Amplifier Factor(dB)
3. The other emission levels were very low against the limit.
4. Margin value = Emission Level – Limit value
5. " # ": The radiated frequency is out of the restricted band.

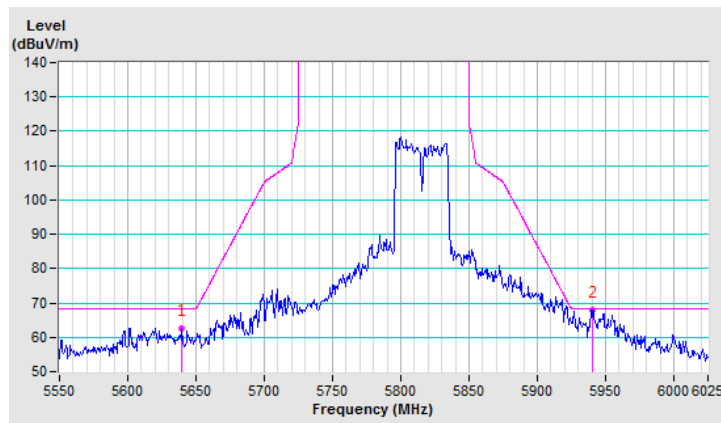

LAA-2 carriers (CA_46A-46A)

CHANNEL	TX Channel 149+157	DETECTOR FUNCTION	Peak (PK)
FREQUENCY RANGE	1GHz ~ 40GHz		Average (AV)

ANTENNA POLARITY & TEST DISTANCE: HORIZONTAL AT 3 M								
NO.	FREQ. (MHz)	EMISSION LEVEL (dBuV/m)	LIMIT (dBuV/m)	MARGIN (dB)	ANTENNA HEIGHT (m)	TABLE ANGLE (Degree)	RAW VALUE (dBuV)	CORRECTION FACTOR (dB/m)
1	#5620.30	56.9 PK	68.2	-11.3	1.00 H	150	54.3	2.6
2	#5948.05	57.5 PK	68.2	-10.7	1.00 H	150	54.3	3.2

REMARKS:

1. Emission Level(dBuV/m) = Raw Value(dBuV) + Correction Factor(dB/m)
2. Correction Factor(dB/m) = Antenna Factor(dB/m) + Cable Factor(dB) – Pre-Amplifier Factor(dB)
3. The other emission levels were very low against the limit.
4. Margin value = Emission Level – Limit value
5. " # ": The radiated frequency is out of the restricted band.

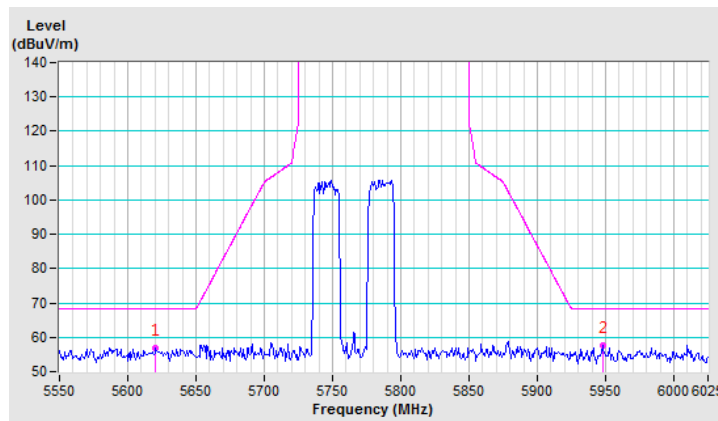

CHANNEL	TX Channel 149+157	DETECTOR FUNCTION	Peak (PK)
FREQUENCY RANGE	1GHz ~ 40GHz		Average (AV)

ANTENNA POLARITY & TEST DISTANCE: VERTICAL AT 3 M

NO.	FREQ. (MHz)	EMISSION LEVEL (dBuV/m)	LIMIT (dBuV/m)	MARGIN (dB)	ANTENNA HEIGHT (m)	TABLE ANGLE (Degree)	RAW VALUE (dBuV)	CORRECTION FACTOR (dB/m)
1	#5626.95	66.0 PK	68.2	-2.2	2.46 V	69	63.4	2.6
2	#5649.75	66.3 PK	68.2	-1.9	2.46 V	69	63.7	2.6
3	#5930.95	60.0 PK	68.2	-8.2	2.46 V	69	56.9	3.1

REMARKS:

1. Emission Level(dBuV/m) = Raw Value(dBuV) + Correction Factor(dB/m)
2. Correction Factor(dB/m) = Antenna Factor(dB/m) + Cable Factor(dB) – Pre-Amplifier Factor(dB)
3. The other emission levels were very low against the limit.
4. Margin value = Emission Level – Limit value
5. " # ": The radiated frequency is out of the restricted band.

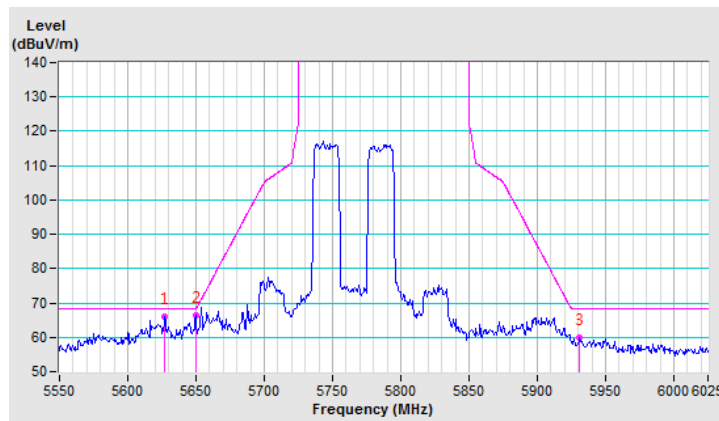

CHANNEL	TX Channel 153+161	DETECTOR FUNCTION	Peak (PK)
FREQUENCY RANGE	1GHz ~ 40GHz		Average (AV)

ANTENNA POLARITY & TEST DISTANCE: HORIZONTAL AT 3 M

NO.	FREQ. (MHz)	EMISSION LEVEL (dBuV/m)	LIMIT (dBuV/m)	MARGIN (dB)	ANTENNA HEIGHT (m)	TABLE ANGLE (Degree)	RAW VALUE (dBuV)	CORRECTION FACTOR (dB/m)
1	#5563.77	57.1 PK	68.2	-11.1	1.01 H	156	54.6	2.5
2	#5923.82	56.7 PK	69.1	-12.4	1.01 H	156	53.6	3.1

REMARKS:

1. Emission Level(dBuV/m) = Raw Value(dBuV) + Correction Factor(dB/m)
2. Correction Factor(dB/m) = Antenna Factor(dB/m) + Cable Factor(dB) – Pre-Amplifier Factor(dB)
3. The other emission levels were very low against the limit.
4. Margin value = Emission Level – Limit value
5. " # ": The radiated frequency is out of the restricted band.

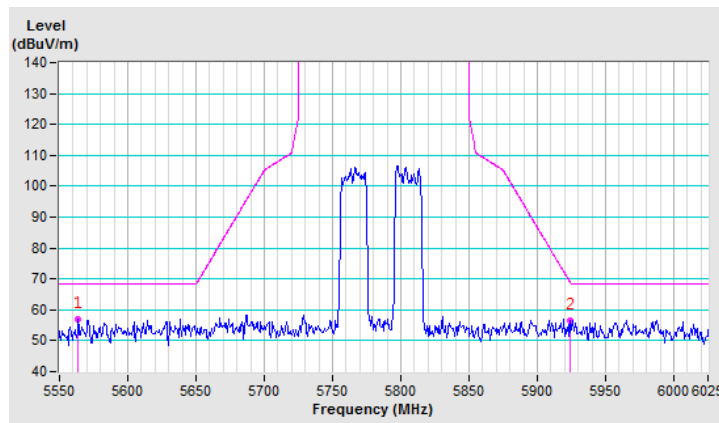

CHANNEL	TX Channel 153+161	DETECTOR FUNCTION	Peak (PK)
FREQUENCY RANGE	1GHz ~ 40GHz		Average (AV)

ANTENNA POLARITY & TEST DISTANCE: VERTICAL AT 3 M

NO.	FREQ. (MHz)	EMISSION LEVEL (dBuV/m)	LIMIT (dBuV/m)	MARGIN (dB)	ANTENNA HEIGHT (m)	TABLE ANGLE (Degree)	RAW VALUE (dBuV)	CORRECTION FACTOR (dB/m)
1	#5642.62	65.3 PK	68.2	-2.9	4.00 V	53	62.7	2.6
2	#5923.35	63.0 PK	69.4	-6.4	2.45 V	53	59.9	3.1

REMARKS:

1. Emission Level(dBuV/m) = Raw Value(dBuV) + Correction Factor(dB/m)
2. Correction Factor(dB/m) = Antenna Factor(dB/m) + Cable Factor(dB) – Pre-Amplifier Factor(dB)
3. The other emission levels were very low against the limit.
4. Margin value = Emission Level – Limit value
5. " # ": The radiated frequency is out of the restricted band.

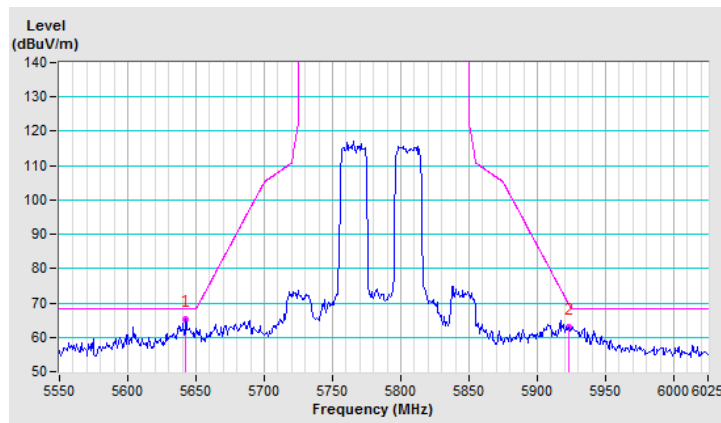

CHANNEL	TX Channel 157+165	DETECTOR FUNCTION	Peak (PK)
FREQUENCY RANGE	1GHz ~ 40GHz		Average (AV)

ANTENNA POLARITY & TEST DISTANCE: HORIZONTAL AT 3 M

NO.	FREQ. (MHz)	EMISSION LEVEL (dBuV/m)	LIMIT (dBuV/m)	MARGIN (dB)	ANTENNA HEIGHT (m)	TABLE ANGLE (Degree)	RAW VALUE (dBuV)	CORRECTION FACTOR (dB/m)
1	#5582.77	57.2 PK	68.2	-11.0	1.05 H	141	54.7	2.5
2	#5930.00	58.3 PK	68.2	-9.9	1.05 H	141	55.2	3.1

REMARKS:

1. Emission Level(dBuV/m) = Raw Value(dBuV) + Correction Factor(dB/m)
2. Correction Factor(dB/m) = Antenna Factor(dB/m) + Cable Factor(dB) – Pre-Amplifier Factor(dB)
3. The other emission levels were very low against the limit.
4. Margin value = Emission Level – Limit value
5. " # ": The radiated frequency is out of the restricted band.

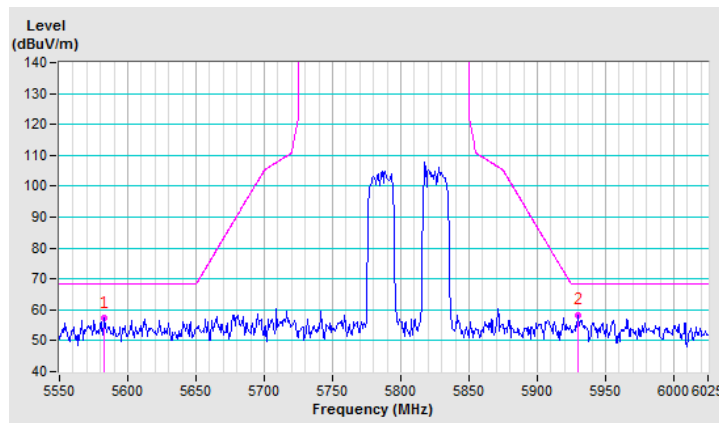

CHANNEL	TX Channel 157+165	DETECTOR FUNCTION	Peak (PK)
FREQUENCY RANGE	1GHz ~ 40GHz		Average (AV)

ANTENNA POLARITY & TEST DISTANCE: VERTICAL AT 3 M

NO.	FREQ. (MHz)	EMISSION LEVEL (dBuV/m)	LIMIT (dBuV/m)	MARGIN (dB)	ANTENNA HEIGHT (m)	TABLE ANGLE (Degree)	RAW VALUE (dBuV)	CORRECTION FACTOR (dB/m)
1	#5627.90	62.7 PK	68.2	-5.5	2.50 V	53	60.1	2.6
2	#5943.30	67.3 PK	68.2	-0.9	2.50 V	53	64.2	3.1

REMARKS:

1. Emission Level(dBuV/m) = Raw Value(dBuV) + Correction Factor(dB/m)
2. Correction Factor(dB/m) = Antenna Factor(dB/m) + Cable Factor(dB) – Pre-Amplifier Factor(dB)
3. The other emission levels were very low against the limit.
4. Margin value = Emission Level – Limit value
5. " # ": The radiated frequency is out of the restricted band.

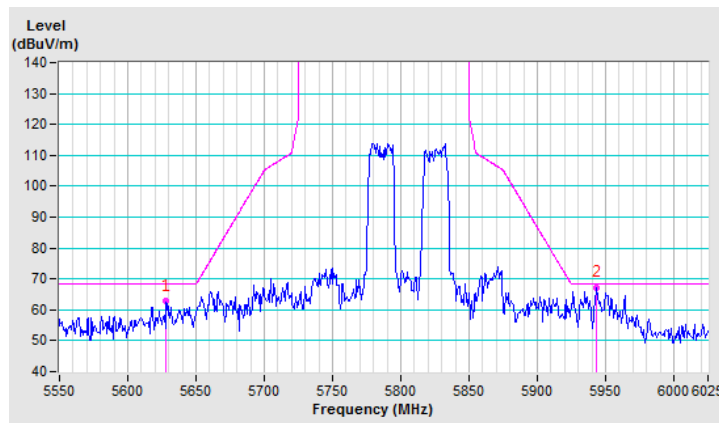

LAA-3 carriers (CA_46D)

CHANNEL	TX Channel 149+153+157	DETECTOR FUNCTION	Peak (PK)
FREQUENCY RANGE	1GHz ~ 40GHz		Average (AV)

ANTENNA POLARITY & TEST DISTANCE: HORIZONTAL AT 3 M								
NO.	FREQ. (MHz)	EMISSION LEVEL (dBuV/m)	LIMIT (dBuV/m)	MARGIN (dB)	ANTENNA HEIGHT (m)	TABLE ANGLE (Degree)	RAW VALUE (dBuV)	CORRECTION FACTOR (dB/m)
1	#5647.85	60.8 PK	68.2	-7.4	1.10 H	132	58.2	2.6
2	#5968.00	57.1 PK	68.2	-11.1	1.10 H	132	53.9	3.2

REMARKS:

1. Emission Level(dBuV/m) = Raw Value(dBuV) + Correction Factor(dB/m)
2. Correction Factor(dB/m) = Antenna Factor(dB/m) + Cable Factor(dB) – Pre-Amplifier Factor(dB)
3. The other emission levels were very low against the limit.
4. Margin value = Emission Level – Limit value
5. " # ": The radiated frequency is out of the restricted band.

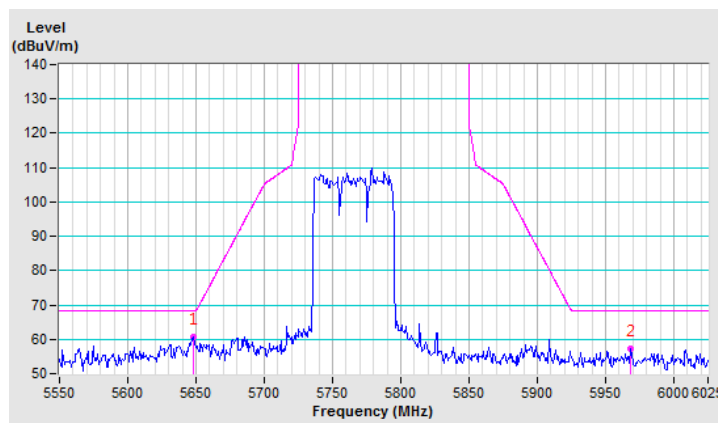

CHANNEL	TX Channel 149+153+157	DETECTOR FUNCTION	Peak (PK)
FREQUENCY RANGE	1GHz ~ 40GHz		Average (AV)

ANTENNA POLARITY & TEST DISTANCE: VERTICAL AT 3 M

NO.	FREQ. (MHz)	EMISSION LEVEL (dBuV/m)	LIMIT (dBuV/m)	MARGIN (dB)	ANTENNA HEIGHT (m)	TABLE ANGLE (Degree)	RAW VALUE (dBuV)	CORRECTION FACTOR (dB/m)
1	#5627.90	68.1 PK	68.2	-0.1	2.08 V	74	65.5	2.6
2	#5930.48	62.4 PK	68.2	-5.8	2.09 V	74	59.3	3.1

REMARKS:

1. Emission Level(dBuV/m) = Raw Value(dBuV) + Correction Factor(dB/m)
2. Correction Factor(dB/m) = Antenna Factor(dB/m) + Cable Factor(dB) – Pre-Amplifier Factor(dB)
3. The other emission levels were very low against the limit.
4. Margin value = Emission Level – Limit value
5. " # ": The radiated frequency is out of the restricted band.

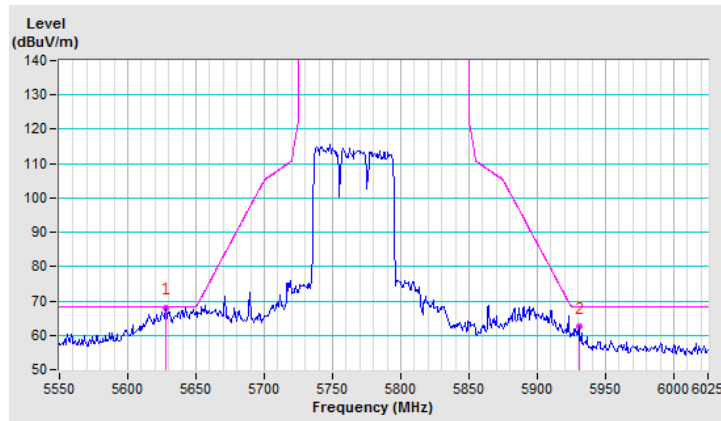

CHANNEL	TX Channel 153+157+161	DETECTOR FUNCTION	Peak (PK)
FREQUENCY RANGE	1GHz ~ 40GHz		Average (AV)

ANTENNA POLARITY & TEST DISTANCE: HORIZONTAL AT 3 M

NO.	FREQ. (MHz)	EMISSION LEVEL (dBuV/m)	LIMIT (dBuV/m)	MARGIN (dB)	ANTENNA HEIGHT (m)	TABLE ANGLE (Degree)	RAW VALUE (dBuV)	CORRECTION FACTOR (dB/m)
1	#5649.75	59.6 PK	68.2	-8.6	1.08 H	113	57.0	2.6
2	#5934.27	56.7 PK	68.2	-11.5	1.08 H	113	53.6	3.1

REMARKS:

1. Emission Level(dBuV/m) = Raw Value(dBuV) + Correction Factor(dB/m)
2. Correction Factor(dB/m) = Antenna Factor(dB/m) + Cable Factor(dB) – Pre-Amplifier Factor(dB)
3. The other emission levels were very low against the limit.
4. Margin value = Emission Level – Limit value
5. " # ": The radiated frequency is out of the restricted band.

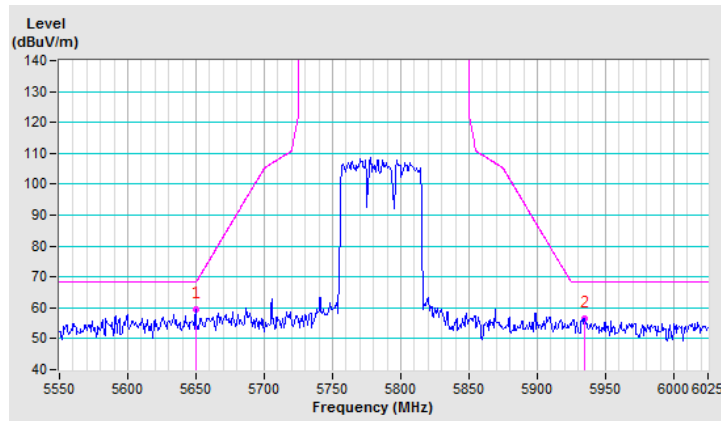

CHANNEL	TX Channel 153+157+161	DETECTOR FUNCTION	Peak (PK)
FREQUENCY RANGE	1GHz ~ 40GHz		Average (AV)

ANTENNA POLARITY & TEST DISTANCE: VERTICAL AT 3 M								
NO.	FREQ. (MHz)	EMISSION LEVEL (dBuV/m)	LIMIT (dBuV/m)	MARGIN (dB)	ANTENNA HEIGHT (m)	TABLE ANGLE (Degree)	RAW VALUE (dBuV)	CORRECTION FACTOR (dB/m)
1	#5647.85	67.7 PK	68.2	-0.5	2.09 V	73	65.1	2.6
2	#5926.68	66.7 PK	68.2	-1.5	2.09 V	73	63.6	3.1

REMARKS:

1. Emission Level(dBuV/m) = Raw Value(dBuV) + Correction Factor(dB/m)
2. Correction Factor(dB/m) = Antenna Factor(dB/m) + Cable Factor(dB) – Pre-Amplifier Factor(dB)
3. The other emission levels were very low against the limit.
4. Margin value = Emission Level – Limit value
5. "#": The radiated frequency is out of the restricted band.

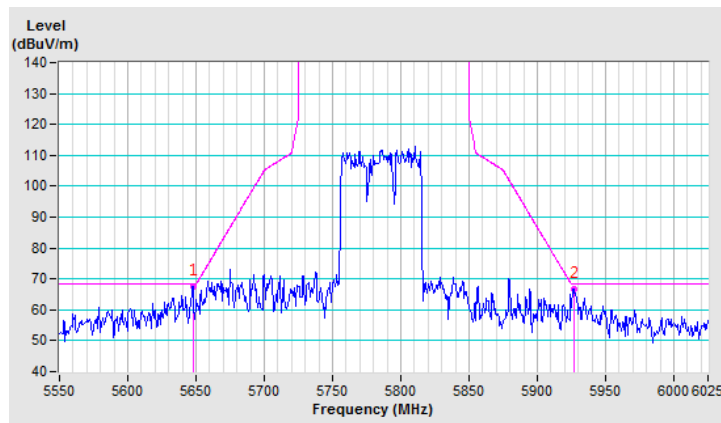

CHANNEL	TX Channel 157+161+165	DETECTOR FUNCTION	Peak (PK)
FREQUENCY RANGE	1GHz ~ 40GHz		Average (AV)

ANTENNA POLARITY & TEST DISTANCE: HORIZONTAL AT 3 M								
NO.	FREQ. (MHz)	EMISSION LEVEL (dBuV/m)	LIMIT (dBuV/m)	MARGIN (dB)	ANTENNA HEIGHT (m)	TABLE ANGLE (Degree)	RAW VALUE (dBuV)	CORRECTION FACTOR (dB/m)
1	#5645.00	63.1 PK	68.2	-5.1	1.06 H	121	60.5	2.6
2	#5932.37	62.1 PK	68.2	-6.1	1.06 H	121	59.0	3.1

REMARKS:

1. Emission Level(dBuV/m) = Raw Value(dBuV) + Correction Factor(dB/m)
2. Correction Factor(dB/m) = Antenna Factor(dB/m) + Cable Factor(dB) – Pre-Amplifier Factor(dB)
3. The other emission levels were very low against the limit.
4. Margin value = Emission Level – Limit value
5. " # ": The radiated frequency is out of the restricted band.

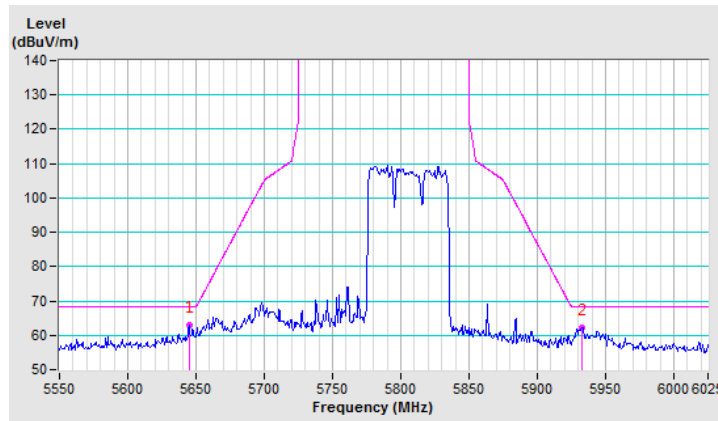

CHANNEL	TX Channel 157+161+165	DETECTOR FUNCTION	Peak (PK)
FREQUENCY RANGE	1GHz ~ 40GHz		Average (AV)

ANTENNA POLARITY & TEST DISTANCE: VERTICAL AT 3 M

NO.	FREQ. (MHz)	EMISSION LEVEL (dBuV/m)	LIMIT (dBuV/m)	MARGIN (dB)	ANTENNA HEIGHT (m)	TABLE ANGLE (Degree)	RAW VALUE (dBuV)	CORRECTION FACTOR (dB/m)
1	#5648.32	66.4 PK	68.2	-1.8	2.11 V	68	63.8	2.6
2	#5941.40	68.1 PK	68.2	-0.1	2.11 V	68	65.0	3.1

REMARKS:

1. Emission Level(dBuV/m) = Raw Value(dBuV) + Correction Factor(dB/m)
2. Correction Factor(dB/m) = Antenna Factor(dB/m) + Cable Factor(dB) – Pre-Amplifier Factor(dB)
3. The other emission levels were very low against the limit.
4. Margin value = Emission Level – Limit value
5. " # ": The radiated frequency is out of the restricted band.

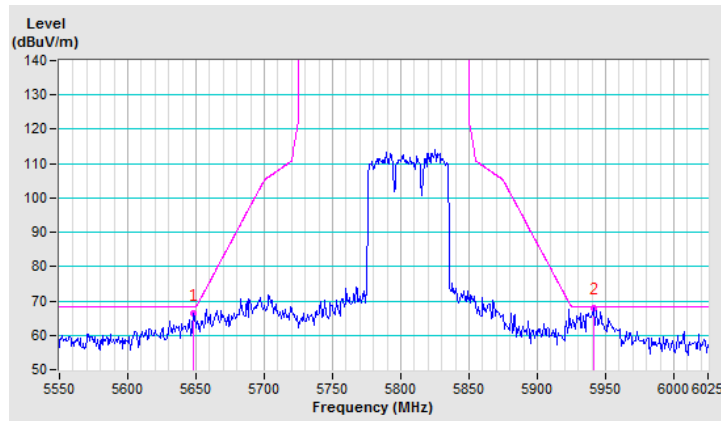

Appendix – Information on the Testing Laboratories

We, Bureau Veritas Consumer Products Services (H.K.) Ltd., Taoyuan Branch, were founded in 1988 to provide our best service in EMC, Radio, Telecom and Safety consultation. Our laboratories are accredited and approved according to ISO/IEC 17025.

If you have any comments, please feel free to contact us at the following:

Linko EMC/RF Lab

Tel: 886-2-26052180

Fax: 886-2-26051924

Hsin Chu EMC/RF/Telecom Lab

Tel: 886-3-6668565

Fax: 886-3-6668323

Hwa Ya EMC/RF/Safety Lab

Tel: 886-3-3183232

Fax: 886-3-3270892

Email: service.adt@tw.bureauveritas.com

Web Site: www.bureauveritas-adt.com

The address and road map of all our labs can be found in our web site also.

--- END ---