

FCC Test Report

(Part 27_C2PC (Class II Permissive Change))

Report No.: RF160112E05E

FCC ID: 2AD8UFW2IADPM01

Test Model: FW2IADPM01

Received Date: Nov. 09, 2018

Test Date: Nov. 27, 2018 ~ Feb. 23, 2019

Issued Date: Feb. 26, 2019

Applicant: Nokia Solutions and Networks

Address: 2000 W. Lucent Lane, Naperville, IL 60563, USA

Issued By: Bureau Veritas Consumer Products Services (H.K.) Ltd., Taoyuan Branch
Hsin Chu Laboratory

Lab Address: No. 47-2, 14th Ling, Chia Pau Vil., Lin Kou Dist., New Taipei City, Taiwan,
R.O.C.

Test Location: No.19, Hwa Ya 2nd Rd., Wen Hwa Vil., Kwei Shan Dist., Taoyuan City
33383, TAIWAN (R.O.C.)



This report is for your exclusive use. Any copying or replication of this report to or for any other person or entity, or use of our name or trademark, is permitted only with our prior written permission. This report sets forth our findings solely with respect to the test samples identified herein. The results set forth in this report are not indicative or representative of the quality or characteristics of the lot from which a test sample was taken or any similar or identical product specifically and expressly noted. Our report includes all of the tests requested by you and the results thereof based upon the information that you provided to us. You have 60 days from date of issuance of this report to notify us of any material error or omission caused by our negligence, provided, however, that such notice shall be in writing and shall specifically address the issue you wish to raise. A failure to raise such issue within the prescribed time shall constitute your unqualified acceptance of the completeness of this report, the tests conducted and the correctness of the report contents. Unless specific mention, the uncertainty of measurement has been explicitly taken into account to declare the compliance or non-compliance to the specification. The report must not be used by the client to claim product certification, approval, or endorsement by TAF or any government agencies

Table of Contents

Release Control Record	4
1 Certificate of Conformity	5
2 Summary of Test Results	6
2.1 Measurement Uncertainty.....	6
2.2 Test Site and Instruments.....	7
3 General Information	9
3.1 General Description of EUT.....	9
3.2 Configuration of System under Test.....	11
3.2.1 Description of Support Units.....	11
3.3 Test Mode Applicability and Tested Channel Detail.....	12
3.4 EUT Operating Conditions.....	14
3.5 General Description of Applied Standards.....	14
4 Test Types and Results	15
4.1 Output Power Measurement.....	15
4.1.1 Limits of Output Power Measurement.....	15
4.1.2 Test Procedures.....	15
4.1.3 Test Setup.....	16
4.1.4 Test Results.....	17
4.2 Modulation Characteristics Measurement.....	29
4.2.1 Limits of Modulation Characteristics.....	29
4.2.2 Test Procedure.....	29
4.2.3 Test Setup.....	29
4.2.4 Test Results.....	30
4.3 Frequency Stability Measurement.....	31
4.3.1 Limits of Frequency Stability Measurement.....	31
4.3.2 Test Procedure.....	31
4.3.3 Test Setup.....	31
4.3.4 Test Results.....	32
4.4 Emission Bandwidth Measurement.....	33
4.4.1 Limits of Emission Bandwidth Measurement.....	33
4.4.2 Test Procedure.....	33
4.4.3 Test Setup.....	33
4.4.4 Test Result.....	34
4.5 Band Edge Measurement.....	42
4.5.1 Limits of Band Edge Measurement.....	42
4.5.2 Test Setup.....	42
4.5.3 Test Procedures.....	42
4.6 Peak to Average Ratio.....	49
4.6.1 Limits of Peak to Average Ratio Measurement.....	49
4.6.2 Test Setup.....	49
4.6.3 Test Procedures.....	49
4.6.4 Test Results.....	50
4.7 Conducted Spurious Emissions.....	54
4.7.1 Limits of Conducted Spurious Emissions Measurement.....	54
4.7.2 Test Setup.....	54
4.7.3 Test Procedure.....	54
4.7.4 Test Results.....	55
4.8 Radiated Emission Measurement.....	103
4.8.1 Limits of Radiated Emission Measurement.....	103
4.8.2 Test Procedure.....	103
4.8.3 Deviation from Test Standard.....	103
4.8.4 Test Setup.....	104
4.8.5 Test Results.....	105

5	Pictures of Test Arrangements.....	127
	Appendix – Information of the Testing Laboratories	128

Release Control Record

Issue No.	Description	Date Issued
RF160112E05E	Original release.	Feb. 26, 2019

1 Certificate of Conformity

Product: Nokia FW2IA LTE Module

Brand: Nokia

Test Model: FW2IADPM01

Sample Status: MASS-PRODUCTION

Applicant: Nokia Solutions and Networks

Test Date: Nov. 27, 2018 ~ Feb. 23, 2019

Standards: FCC Part 27, Subpart C,L
FCC Part 2, Subpart J

The above equipment has been tested by **Bureau Veritas Consumer Products Services (H.K.) Ltd., Taoyuan Branch**, and found compliance with the requirement of the above standards. The test record, data evaluation & Equipment Under Test (EUT) configurations represented herein are true and accurate accounts of the measurements of the sample's RF characteristics under the conditions specified in this report.

Prepared by :

Pettie Chen

Date:

Feb. 26, 2019

Pettie Chen / Senior Specialist

Approved by :

Bruce Chen

Date:

Feb. 26, 2019

Bruce Chen / Project Engineer

2 Summary of Test Results

Applied Standard: FCC Part 27 & Part 2			
FCC Clause	Test Item	Result	Remarks
2.1046 27.50 (d)(2)	Equivalent Isotropically Radiated Power	Pass	Meet the requirement of limit.
2.1047	Modulation Characteristics	Pass	Meet the requirement of limit.
27.50(d)(5)	Peak To Average Ratio	Pass	Meet the requirement of limit.
2.1055 27.54	Frequency Stability Stay with the authorized bands of operation	Pass	Meet the requirement of limit.
2.1049 27.53(h)(3)	Emission Bandwidth	Pass	Meet the requirement of limit.
2.1051 27.53(h)	Band Edge Measurements	Pass	Meet the requirement of limit.
2.1051 27.53(h)	Conducted Spurious Emissions	Pass	Meet the requirement of limit.
2.1053 27.53(h)	Radiated Spurious Emissions	Pass	Meet the requirement of limit. Minimum passing margin is -19.1dB at 6435.00MHz.

Note: Determining compliance based on the results of the compliance measurement, not taking into account measurement instrumentation uncertainty.

2.1 Measurement Uncertainty

Where relevant, the following measurement uncertainty levels have been estimated for tests performed on the EUT as specified in CISPR 16-4-2:

Measurement	Frequency	Expanded Uncertainty (k=2) (±)
Radiated Emissions up to 1 GHz	30MHz ~ 200MHz	3.59 dB
	200MHz ~1000MHz	3.60 dB
Radiated Emissions above 1 GHz	1GHz ~ 18GHz	2.29 dB
	18GHz ~ 40GHz	2.29 dB

2.2 Test Site and Instruments

Description & Manufacturer	Model No.	Serial No.	Cal. Date	Cal. Due
Test Receiver KEYSIGHT	N9038A	MY55420137	Apr. 11, 2018	Apr. 10, 2019
Spectrum Analyzer ROHDE & SCHWARZ	FSP40	100269	May 29, 2018	May 28, 2019
BILOG Antenna SCHWARZBECK	VULB9168	9168-160	Nov. 21, 2018	Nov. 20, 2019
HORN Antenna SCHWARZBECK	BBHA 9120 D	9120D-1169	Nov. 25, 2018	Nov. 24, 2019
HORN Antenna SCHWARZBECK	BBHA 9170	BBHA9170241	Nov. 25, 2018	Nov. 24, 2019
HORN Antenna SCHWARZBECK	BBHA 9170	9170-480	Nov. 25, 2018	Nov. 24, 2019
Loop Antenna TESEQ	HLA 6121	45745	Jun. 14, 2018	Jun. 13, 2019
Pre-Amplifier EMCI	EMC 184045	980116	Oct. 12, 2018	Oct. 11, 2019
Preamplifier Agilent (Below 1GHz)	8447D	2944A10638	Aug. 08, 2018	Aug. 07, 2019
Preamplifier Agilent (Above 1GHz)	8449B	3008A01924	Feb. 22, 2018	Feb. 21, 2019
			Feb. 21, 2019	Feb. 20, 2020
RF signal cable HUBER+SUHNER&EMCI	SUCOFLEX 104 & EMC104-SM-SM8000	CABLE-CH9-02 (248780+171006)	Jan. 15, 2018	Jan. 14, 2019
			Jan. 19, 2019	Jan. 18, 2020
RF signal cable HUBER+SUHNER	SUCOFLEX 104	CABLE-CH9-(250795/4)	Aug. 08, 2018	Aug. 07, 2019
RF signal cable Woken	8D-FB	Cable-CH9-01	Jul. 31, 2018	Jul. 30, 2019
Software BV ADT	ADT_Radiated_ V7.6.15.9.5	NA	NA	NA
Antenna Tower EMCO	2070/2080	512.835.4684	NA	NA
Turn Table EMCO	2087-2.03	NA	NA	NA
Antenna Tower & Turn BV ADT	AT100	AT93021705	NA	NA
Turn Table BV ADT	TT100	TT93021705	NA	NA
Turn Table Controller BV ADT	SC100	SC93021705	NA	NA
Boresight Antenna Fixture	FBA-01	FBA-SIP01	NA	NA
JFW 20dB attenuation	50HF-020-SMA	NA	NA	NA
Radio Communication Analyzer	MT8821C	6261786083	Dec. 21, 2017	Dec. 20, 2018
			Dec. 11, 2018	Dec. 10, 2019
WIT Standard Temperature And Humidity Chamber	TH-4S-C	W981030	Jun. 04, 2018	Jun. 03, 2019
DC Power Supply Topward	6306A	727263	NA	NA
True RMS Clamp Meter / Fluke	325	31130711WS	May 22, 2018	May 21, 2019

- Note:
1. The calibration interval of the above test instruments is 12 months and the calibrations are traceable to NML/ROC and NIST/USA.
 2. The test was performed in HwaYa Chamber 9.
 3. The FCC Designation Number is TW0003. The number will be varied with the Lab location and scope as attached.
 4. The IC Site Registration No. is IC 7450F-9.

3 General Information

3.1 General Description of EUT

Product	Nokia FW2IA LTE Module		
Brand	Nokia		
Test Model	FW2IADPM01		
FCC ID	2AD8UFW2IADPM01		
Status of EUT	MASS-PRODUCTION		
Power Supply Rating	12Vdc		
Modulation Type	QPSK, 16QAM, 64QAM, 256QAM		
Modulation Technology	OFDM, OFDMA, SC-FDMA		
Transfer Rate	Uplink: 75Mbps, Downlink: 300Mbps		
Operating Frequency	Channel Bandwidth: 5MHz	2112.5MHz~2177.5MHz	
	Channel Bandwidth: 10MHz	2115.0MHz~2175.0MHz	
	Channel Bandwidth: 15MHz	2117.5MHz~2172.5MHz	
	Channel Bandwidth: 20MHz	2120.0MHz~2170.0MHz	
Output Power	NB-IOT In-band:		
	Channel Bandwidth: 5MHz	437.522mW (26.41dBm) (QPSK)	
	Channel Bandwidth: 10MHz	435.512mW (26.39dBm) (QPSK)	
	Channel Bandwidth: 15MHz	434.510mW (26.38dBm) (QPSK)	
	Channel Bandwidth: 20MHz	437.522mW (26.41dBm) (QPSK)	
	NB-IOT Guard Band:		
	Channel Bandwidth: 10MHz	439.542mW (26.43dBm) (QPSK)	
	Channel Bandwidth: 15MHz	434.510mW (26.38dBm) (QPSK)	
Channel Bandwidth: 20MHz	442.588mW (26.46dBm) (QPSK)		
Antenna Type	Refer to note as below		
Antenna Connector	Refer to user's manual		
Accessory Device	NA		
Data Cable Supplied	NA		

Note:

- This report is prepared for FCC class II permissive change. This is a supplementary report of Report No.: RF160112E05A. The differences between them are as below information:
 - ◆ LTE B66 add NB-IOT In-band
 - ◆ LTE B66 add NB-IOT Guard Band
- For above changes, only NB-IOT In-band and NB-IOT Guard Band test results has to be performed. The other test items were copied from the original test report (Report No.: RF160112E05, RF160112E05A) and all data was verified to meet the requirements.
- There is LTE technology used for the EUT, which supports 2110~2180MHz frequency band.
- The EUT incorporates a MIMO function for LTE mode

Channel Bandwidth	Modulation	TX & RX configuration	
5MHz	BPSK, QPSK, 16QAM, 64QAM, 256QAM	2TX	2RX
10MHz	BPSK, QPSK, 16QAM, 64QAM, 256QAM	2TX	2RX
15MHz	BPSK, QPSK, 16QAM, 64QAM, 256QAM	2TX	2RX
20MHz	BPSK, QPSK, 16QAM, 64QAM, 256QAM	2TX	2RX

5. The EUT's spec. as below table:

Model name	LTE				
	Freq.(MHz)		Freq.(MHz)		Band
FW2IADPM01	UL	BW 5MHz : 1712.5~1777.5	DL	BW 5MHz : 2112.5~2177.5	
		BW 10MHz : 1715~1775		BW 10MHz : 2115~2175	
		BW 15MHz : 1717.5~1772.5		BW 15MHz : 2117.5~2172.5	
		BW 20MHz : 1720~1770		BW 20MHz : 2120~2170	

6. The antennas provided to the EUT, please refer to the following table:

Antenna Spec.

Antenna No	Brand	Model	Antenna Type	Gain(dBi)	Frequency (GHz)
LTE Ant1(Main)	Nokia	FW2IADPM01	Slot Antenna	6.03	1.7~2.7
Antenna No	Brand	Model	Antenna Type	Gain(dBi)	Frequency (GHz)
LTE Ant2(Aux)	Nokia	FW2IADPM01	Slot Antenna	4.64	1.7~2.7

Cable Spec.

Brand	Model	Connector Type	Cable Loss(dB)	Cable Length (mm)
NA	NA	Right angle MMCX Plug	peak gain included	287

7. The above EUT information is declared by manufacturer and for more detailed features description, please refer to the manufacturer's specifications or user's manual.

3.2 Configuration of System under Test

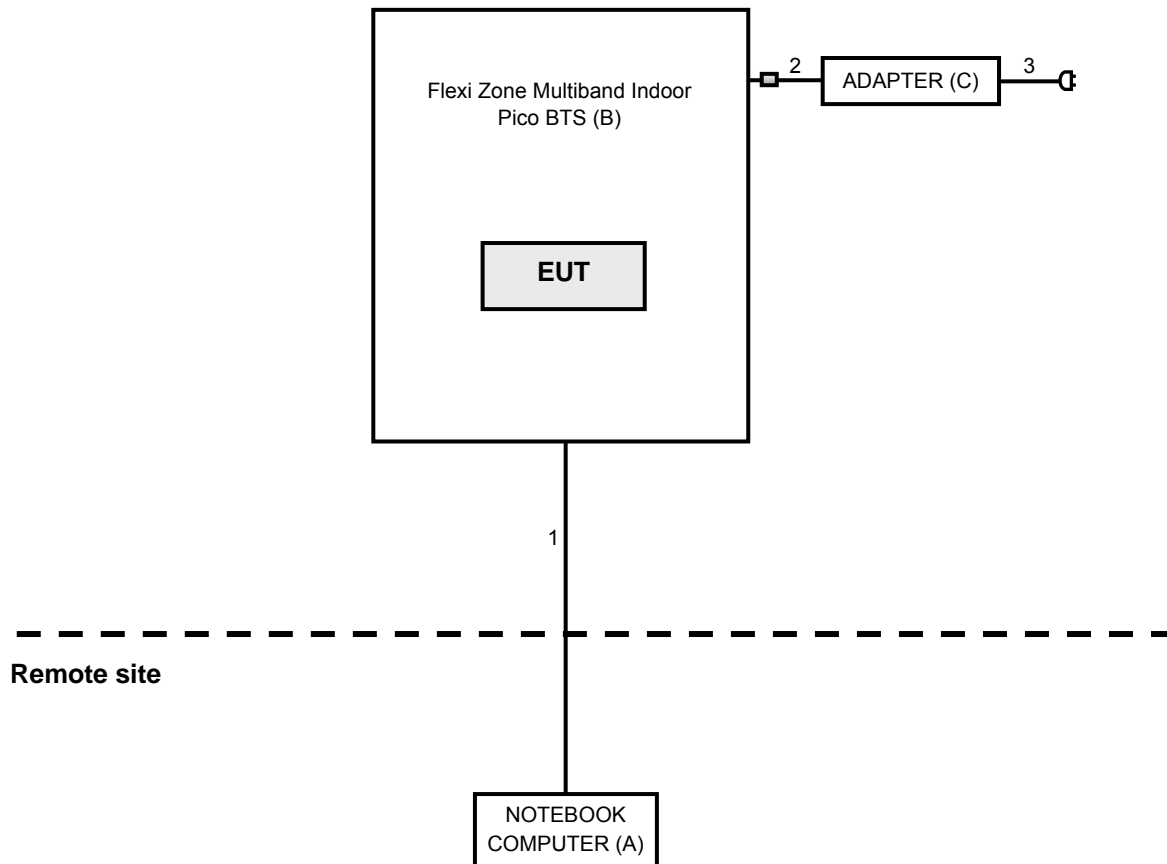

3.2.1 Description of Support Units

The EUT has been tested as an independent unit together with other necessary accessories or support units. The following support units or accessories were used to form a representative test configuration during the tests.

No.	Product	Brand	Model No.	Serial No.	FCC ID	Remark
A	Notebook Computer	DELL	D531	CN-0XM006-48643-86L-4472	QDS-BRCM1019	Provided by Lab
B	Flexi Zone Multiband Indoor Pico BTS	Nokia	FW2IRA	NA	NA	Supplied by Client
C	Adapter	DVE	DSA-60PFE-12	NA	NA	Supplied by Client

NOTE:

1. All power cords of the above support units are non-shielded (1.8 m).

No.	Cable	Qty.	Length (m)	Shielded (Yes/ No)	Cores (Number)	Remark
1	RJ-45	1	10	No	0	Provided by Lab
2	DC	1	1.2	No	1	Supplied by Client
3	AC	1	1.8	No	0	Supplied by Client

NOTE:

1. The core(s) is(are) originally attached to the cable(s).

3.3 Test Mode Applicability and Tested Channel Detail

Pre-Scan has been conducted to determine the worst-case mode from all possible combinations between available modulations, data rates and antenna ports

The worst case was found when positioned on X-plane. Following channel(s) was (were) selected for the final test as listed below:

LTE Band 66

For NB-IOT In-band:

Test Item	Available Frequency (MHz)	Tested Frequency (MHz)	Channel Bandwidth	Modulation
Modulation Characteristics	2110 to 2180	CH 66461 (2112.5MHz)	5MHz	QPSK
Output Power	2110 to 2180	CH 66461 (2112.5MHz), CH 66786 (2145.0MHz), CH 67111 (2177.5MHz)	5MHz	QPSK
		CH 66486 (2115.0MHz), CH 66786 (2145.0MHz), CH 67086 (2175.0MHz)	10MHz	QPSK
		CH 66511 (2117.5MHz), CH 66786 (2145.0MHz), CH 67061 (2172.5MHz)	15MHz	QPSK
		CH 66536 (2120.0MHz), CH 66786 (2145.0MHz), CH 67036 (2170.0MHz)	20MHz	QPSK
Emission Bandwidth	2110 to 2180	CH 66461 (2112.5MHz), CH 66786 (2145.0MHz), CH 67111 (2177.5MHz)	5MHz	QPSK
		CH 66536 (2120.0MHz), CH 66786 (2145.0MHz), CH 67036 (2170.0MHz)	20MHz	QPSK
Conducted Emission	2110 to 2180	CH 66461 (2112.5MHz), CH 66786 (2145.0MHz), CH 67111 (2177.5MHz)	5MHz	QPSK
		CH 66536 (2120.0MHz), CH 66786 (2145.0MHz), CH 67036 (2170.0MHz)	20MHz	QPSK
Radiated Emission Below 1GHz	2110 to 2180	CH 66461 (2112.5MHz)	5MHz	QPSK
Radiated Emission Above 1GHz	2110 to 2180	CH 66461 (2112.5MHz), CH 66786 (2145.0MHz), CH 67111 (2177.5MHz)	5MHz	QPSK

*This module is based on FW2XXXX host assembly provide base band data during testing.

NOTE:

1. All supported modulation types were evaluated. The Worst case emission of QPSK was selected. Therefore, the EIRP power was presented under QPSK mode only.

For NB-IOT Guard Band:

Test Item	Available Frequency (MHz)	Tested Frequency (MHz)	Channel Bandwidth	Modulation
Output Power	2110 to 2180	CH 66486 (2115.0MHz), CH 66786 (2145.0MHz), CH 67086 (2175.0MHz)	10MHz	QPSK
		CH 66511 (2117.5MHz), CH 66786 (2145.0MHz), CH 67061 (2172.5MHz)	15MHz	QPSK
		CH 66536 (2120.0MHz), CH 66786 (2145.0MHz), CH 67036 (2170.0MHz)	20MHz	QPSK
Modulation Characteristics	2110 to 2180	CH 66786 (2145.0MHz)	10MHz	QPSK
Frequency Stability	2110 to 2180	CH 66786 (2145.0MHz)	10MHz	QPSK
Emission Bandwidth	2110 to 2180	CH 66486 (2115.0MHz), CH 66786 (2145.0MHz), CH 67086 (2175.0MHz)	10MHz	QPSK
		CH 66511 (2117.5MHz), CH 66786 (2145.0MHz), CH 67061 (2172.5MHz)	15MHz	QPSK
		CH 66536 (2120.0MHz), CH 66786 (2145.0MHz), CH 67036 (2170.0MHz)	20MHz	QPSK
Channel Edge	2110 to 2180	CH 66486 (2115.0MHz), CH 67086 (2175.0MHz)	10MHz	QPSK
		CH 66511 (2117.5MHz), CH 67061 (2172.5MHz)	15MHz	QPSK
		CH 66536 (2120.0MHz), CH 67036 (2170.0MHz)	20MHz	QPSK
Peak to Average Ratio	2110 to 2180	CH 66486 (2115.0MHz), CH 66786 (2145.0MHz), CH 67086 (2175.0MHz)	10MHz	QPSK
		CH 66511 (2117.5MHz), CH 66786 (2145.0MHz), CH 67061 (2172.5MHz)	15MHz	QPSK
		CH 66536 (2120.0MHz), CH 66786 (2145.0MHz), CH 67036 (2170.0MHz)	20MHz	QPSK
Conducted Emission	2110 to 2180	CH 66536 (2120.0MHz), CH 66786 (2145.0MHz), CH 67036 (2170.0MHz)	20MHz	QPSK
Radiated Emission Below 1GHz	2110 to 2180	CH 66486 (2115.0MHz)	10MHz	QPSK
		CH 66511 (2117.5MHz)	15MHz	QPSK
		CH 66536 (2120.0MHz)	20MHz	QPSK
Radiated Emission Above 1GHz	2110 to 2180	CH 66486 (2115.0MHz), CH 66786 (2145.0MHz), CH 67086 (2175.0MHz)	10MHz	QPSK
		CH 66511 (2117.5MHz), CH 66786 (2145.0MHz), CH 67061 (2172.5MHz)	15MHz	QPSK
		CH 66536 (2120.0MHz), CH 66786 (2145.0MHz), CH 67036 (2170.0MHz)	20MHz	QPSK

Test Condition:

Test Item	Environmental Conditions	Input Power (System)	Tested By
EIRP	20deg. C, 62%RH	120Vac, 60Hz	James Yang
Modulation characteristics	20deg. C, 62%RH	120Vac, 60Hz	James Yang
Frequency Stability	20deg. C, 62%RH	120Vac, 60Hz	James Yang
Occupied Bandwidth	20deg. C, 62%RH	120Vac, 60Hz	James Yang
Band Edge	20deg. C, 62%RH	120Vac, 60Hz	James Yang
Peak To Average Ratio	20deg. C, 62%RH	120Vac, 60Hz	James Yang
Conducted Emission	20deg. C, 62%RH	120Vac, 60Hz	James Yang
Radiated Emission	23deg. C, 68%RH	120Vac, 60Hz	Greg Lin

3.4 EUT Operating Conditions

The communication simulator station system controlled a EUT to export maximum output power under transmission mode and specific channel frequency

3.5 General Description of Applied Standards

The EUT is a RF Product. According to the specifications of the manufacturer, it must comply with the requirements of the following standards:

FCC 47 CFR Part 2

FCC 47 CFR Part 27

KDB 971168 D01 Power Meas License Digital Systems v03r01

ANSI/TIA/EIA-603-E 2016

ANSI 63.26-2015

NOTE: All test items have been performed and recorded as per the above standards.

4 Test Types and Results

4.1 Output Power Measurement

4.1.1 Limits of Output Power Measurement

The radiated peak output power shall be according to the specific rule Part 27.50(d)(2) that are limited to EIRP of 1640 watts/MHz when transmitting with an emission bandwidth greater than 1 MHz.

4.1.2 Test Procedures

Conducted Power Measurement:

The transmitter output was connected to the spectrum analyzer through an attenuator. The bandwidth of the fundamental frequency was measured by spectrum analyzer with RBW = 100kHz and VBW = 300kHz (Channel Bandwidth: 5MHz), RBW = 200kHz and VBW = 620kHz (Channel Bandwidth: 10MHz), RBW = 300kHz and VBW = 1MHz (Channel Bandwidth: 15MHz), RBW = 430kHz and VBW = 1.2MHz (Channel Bandwidth: 20MHz). Record the power level.

EIRP / ERP Measurement:

- a. All measurements were done at low, middle and high operational frequency range. RBW and VBW is 5MHz for LTE Mode.
- b. Substitution method is used for E.I.R.P measurement. In the semi-anechoic chamber, EUT placed on the 0.8m(below or equal 1GHz) and/or 1.5m(above 1GHz) height of Turn Table, rotated the table around 360 degrees to search the maximum radiation power and receiver antenna shall be rotated vertical and horizontal polarization and moved height from 1m to 4m to find the maximum polar radiated power. The "Read Value" is the spectrum reading the maximum power value.
- c. The substitution horn antenna is substituted for EUT at the same position and signals generator export the CW signal to the substitution antenna via a tx cable. Rotated the Turn Table and moved receiving antenna to find the maximum radiation power. Adjust output power level of S.G to get a Value of spectrum reading equal to "Read Value" of step b. Record the power level of S.G
- d. $EIRP = \text{Output power level of S.G} - \text{TX cable loss} + \text{Antenna gain of substitution horn.}$ E.R.P power can be calculated form E.I.R.P power by subtracting the gain of dipole, $E.R.P \text{ power} = E.I.R.P \text{ power} - 2.15\text{dBi}$.

4.1.3 Test Setup

Conducted Power Measurement:

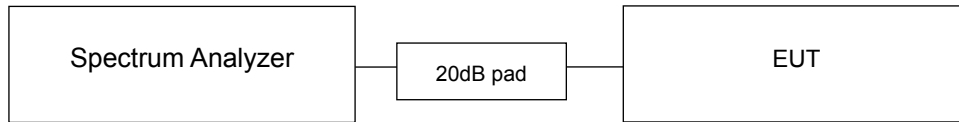

EIRP / ERP MEASUREMENT:

For Radiated Emission below or equal 1GHz

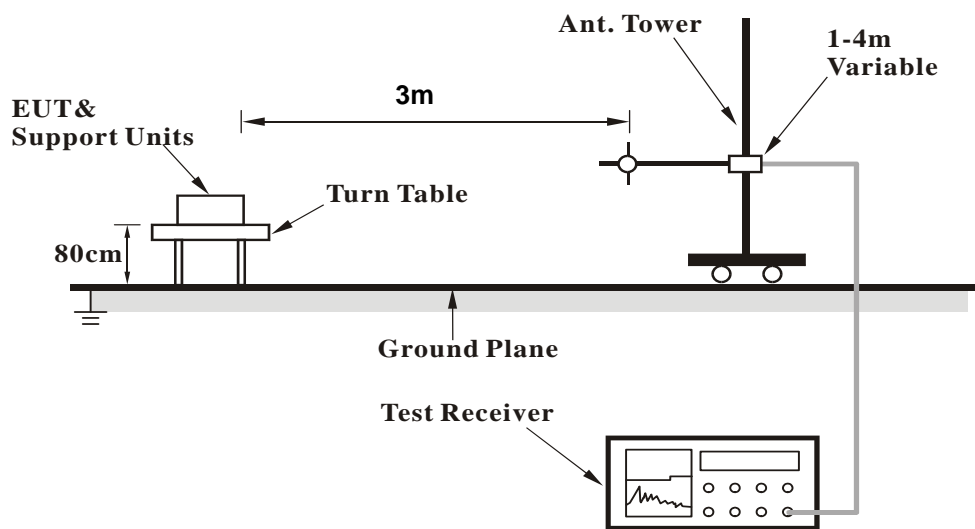

For Radiated Emission above 1GHz

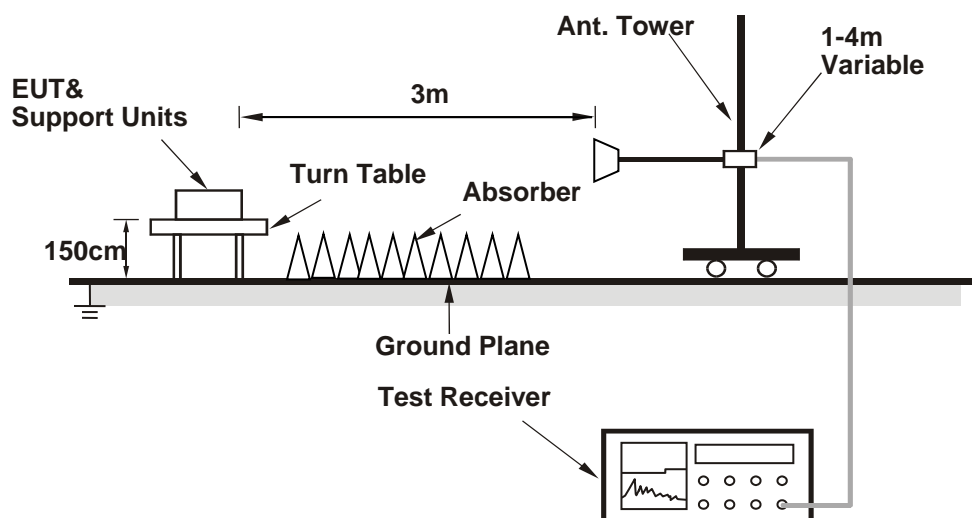

For the actual test configuration, please refer to the attached file (Test Setup Photo).

4.1.4 Test Results

Conducted Output Power (dBm)

For NB-IoT In-band:

Band / BW	RB Size	RB Offset	Chain	NB-IoT Carrier RB offset=0			NB-IoT Carrier RB offset=24		
				Low CH	Mid CH	High CH	Low CH	Mid CH	High CH
				66461	66786	67111	66461	66786	67111
				2112.5	2145	2177.5	2112.5	2145	2177.5
				MHz	MHz	MHz	MHz	MHz	MHz
66 / 5M	25	0	0	23.35	23.39	23.37	23.33	23.38	23.36
			1	23.36	23.40	23.37	23.38	23.36	23.34
			Total	26.37	26.41	26.38	26.37	26.38	26.36

Band / BW	RB Size	RB Offset	Chain	NB-IoT Carrier RB offset=0			NB-IoT Carrier RB offset=24		
				Low CH	Mid CH	High CH	Low CH	Mid CH	High CH
				66486	66786	67086	66486	66786	67086
				2115	2145	2175	2115	2145	2175
				MHz	MHz	MHz	MHz	MHz	MHz
66 / 10M	50	0	0	23.36	23.31	23.35	23.34	23.32	23.30
			1	23.39	23.39	23.40	23.40	23.35	23.36
			Total	26.39	26.36	26.39	26.38	26.35	26.34

Band / BW	RB Size	RB Offset	Chain	NB-IoT Carrier RB offset=0			NB-IoT Carrier RB offset=24		
				Low CH	Mid CH	High CH	Low CH	Mid CH	High CH
				66511	66786	67061	66511	66786	67061
				2117.5	2145	2172.5	2117.5	2145	2172.5
				MHz	MHz	MHz	MHz	MHz	MHz
66 / 15M	75	0	0	23.35	23.37	23.32	23.28	23.32	23.35
			1	23.38	23.36	23.36	23.35	23.39	23.36
			Total	26.38	26.35	26.37	26.36	26.37	26.34

Band / BW	RB Size	RB Offset	Chain	NB-IoT Carrier RB offset=0			NB-IoT Carrier RB offset=24		
				Low CH	Mid CH	High CH	Low CH	Mid CH	High CH
				66536	66786	67036	66536	66786	67036
				2120	2145	2170	2120	2145	2170
				MHz	MHz	MHz	MHz	MHz	MHz
66 / 20M	100	0	0	23.39	23.34	23.29	23.37	23.33	23.32
			1	23.40	23.36	23.26	23.39	23.37	23.24
			Total	26.41	26.36	26.27	26.39	26.36	26.24

**For NB-IoT Guard Band:
1TX**

Band / BW	Chain	QPSK_IoT Signal at Bottom			QPSK_IoT Signal at Top		
		Low CH	Mid CH	High CH	Low CH	Mid CH	High CH
		66486	66786	67086	66486	66786	67086
		2115	2145	2175	2115	2145	2175
		MHz	MHz	MHz	MHz	MHz	MHz
66 / 10M	0	23.39	23.38	23.41	23.38	23.36	23.40
	1	23.18	23.08	23.25	23.33	23.12	23.34

Band / BW	Chain	QPSK_IoT Signal at Bottom			QPSK_IoT Signal at Top		
		Low CH	Mid CH	High CH	Low CH	Mid CH	High CH
		66511	66786	67061	66511	66786	67061
		2117.5	2145	2172.5	2117.5	2145	2172.5
		MHz	MHz	MHz	MHz	MHz	MHz
66 / 15M	0	23.36	23.38	23.33	23.37	23.37	23.33
	1	23.19	23.13	23.22	23.27	23.09	23.22

Band / BW	Chain	QPSK_IoT Signal at Bottom			QPSK_IoT Signal at Top		
		Low CH	Mid CH	High CH	Low CH	Mid CH	High CH
		66536	66786	67036	66536	66786	67036
		2120	2145	2170	2120	2145	2170
		MHz	MHz	MHz	MHz	MHz	MHz
66 / 20M	0	23.41	23.36	23.25	23.40	23.37	23.26
	1	23.39	23.08	23.14	23.36	23.10	23.12

2TX

Band / BW	Chain	QPSK_IoT Signal at Bottom			QPSK_IoT Signal at Top		
		Low CH	Mid CH	High CH	Low CH	Mid CH	High CH
		66486	66786	67086	66486	66786	67086
		2115	2145	2175	2115	2145	2175
		MHz	MHz	MHz	MHz	MHz	MHz
66 / 10M	2TX	26.35	26.29	26.39	26.42	26.30	26.43

Band / BW	Chain	QPSK_IoT Signal at Bottom			QPSK_IoT Signal at Top		
		Low CH	Mid CH	High CH	Low CH	Mid CH	High CH
		66511	66786	67061	66511	66786	67061
		2117.5	2145	2172.5	2117.5	2145	2172.5
		MHz	MHz	MHz	MHz	MHz	MHz
66 / 15M	2TX	26.34	26.32	26.34	26.38	26.29	26.34

Band / BW	Chain	QPSK_IoT Signal at Bottom			QPSK_IoT Signal at Top		
		Low CH	Mid CH	High CH	Low CH	Mid CH	High CH
		66536	66786	67036	66536	66786	67036
		2120	2145	2170	2120	2145	2170
		MHz	MHz	MHz	MHz	MHz	MHz
66 / 20M	2TX	26.46	26.28	26.26	26.44	26.30	26.25

EIRP

LTE Band 66

For NB-IOT In-band:

Channel Bandwidth: 5MHz

MODE		TX channel 66461					
Antenna Polarity & Test Distance: Horizontal at 3 M							
No.	Freq. (MHz)	Reading (dBm)	S.G Power Value (dBm)	Correction Factor (dB)	EIRP (dBm)	Limit (dBm)	Margin (dB)
1	2112.50	-17.2	24.5	-0.3	24.2	62.14	-37.94
Antenna Polarity & Test Distance: Vertical at 3 M							
No.	Freq. (MHz)	Reading (dBm)	S.G Power Value (dBm)	Correction Factor (dB)	EIRP (dBm)	Limit (dBm)	Margin (dB)
1	2112.50	-13.6	28.9	-0.3	28.6	62.14	-33.54

MODE		TX channel 66786					
Antenna Polarity & Test Distance: Horizontal at 3 M							
No.	Freq. (MHz)	Reading (dBm)	S.G Power Value (dBm)	Correction Factor (dB)	EIRP (dBm)	Limit (dBm)	Margin (dB)
1	2145.00	-16.5	25.4	-0.3	25.1	62.14	-37.04
Antenna Polarity & Test Distance: Vertical at 3 M							
No.	Freq. (MHz)	Reading (dBm)	S.G Power Value (dBm)	Correction Factor (dB)	EIRP (dBm)	Limit (dBm)	Margin (dB)
1	2145.00	-13.1	29.4	-0.3	29.1	62.14	-33.04

MODE		TX channel 67111					
Antenna Polarity & Test Distance: Horizontal at 3 M							
No.	Freq. (MHz)	Reading (dBm)	S.G Power Value (dBm)	Correction Factor (dB)	EIRP (dBm)	Limit (dBm)	Margin (dB)
1	2177.50	-16.8	25.2	-0.2	25.0	62.14	-37.14
Antenna Polarity & Test Distance: Vertical at 3 M							
No.	Freq. (MHz)	Reading (dBm)	S.G Power Value (dBm)	Correction Factor (dB)	EIRP (dBm)	Limit (dBm)	Margin (dB)
1	2177.50	-13.2	29.1	-0.2	28.9	62.14	-33.24

Note: EIRP (dBm) = S.G Power Value (dBm) + Correction Factor (dB).

Channel Bandwidth: 10MHz

MODE		TX channel 66486					
Antenna Polarity & Test Distance: Horizontal at 3 M							
No.	Freq. (MHz)	Reading (dBm)	S.G Power Value (dBm)	Correction Factor (dB)	EIRP (dBm)	Limit (dBm)	Margin (dB)
1	2115.00	-17.4	24.3	-0.3	24.0	62.14	-38.14
Antenna Polarity & Test Distance: Vertical at 3 M							
No.	Freq. (MHz)	Reading (dBm)	S.G Power Value (dBm)	Correction Factor (dB)	EIRP (dBm)	Limit (dBm)	Margin (dB)
1	2115.00	-13.7	28.8	-0.3	28.5	62.14	-33.64

MODE		TX channel 66786					
Antenna Polarity & Test Distance: Horizontal at 3 M							
No.	Freq. (MHz)	Reading (dBm)	S.G Power Value (dBm)	Correction Factor (dB)	EIRP (dBm)	Limit (dBm)	Margin (dB)
1	2145.00	-16.3	25.6	-0.3	25.3	62.14	-36.84
Antenna Polarity & Test Distance: Vertical at 3 M							
No.	Freq. (MHz)	Reading (dBm)	S.G Power Value (dBm)	Correction Factor (dB)	EIRP (dBm)	Limit (dBm)	Margin (dB)
1	2145.00	-13.2	29.3	-0.3	29.0	62.14	-33.14

MODE		TX channel 67086					
Antenna Polarity & Test Distance: Horizontal at 3 M							
No.	Freq. (MHz)	Reading (dBm)	S.G Power Value (dBm)	Correction Factor (dB)	EIRP (dBm)	Limit (dBm)	Margin (dB)
1	2175.00	-16.8	25.2	-0.2	25.0	62.14	-37.14
Antenna Polarity & Test Distance: Vertical at 3 M							
No.	Freq. (MHz)	Reading (dBm)	S.G Power Value (dBm)	Correction Factor (dB)	EIRP (dBm)	Limit (dBm)	Margin (dB)
1	2175.00	-13.0	29.3	-0.2	29.1	62.14	-33.04

Note: EIRP (dBm) = S.G Power Value (dBm) + Correction Factor (dB).

Channel Bandwidth: 15MHz

MODE		TX channel 66511					
Antenna Polarity & Test Distance: Horizontal at 3 M							
No.	Freq. (MHz)	Reading (dBm)	S.G Power Value (dBm)	Correction Factor (dB)	EIRP (dBm)	Limit (dBm)	Margin (dB)
1	2117.50	-16.4	25.3	-0.3	25.0	62.14	-37.14
Antenna Polarity & Test Distance: Vertical at 3 M							
No.	Freq. (MHz)	Reading (dBm)	S.G Power Value (dBm)	Correction Factor (dB)	EIRP (dBm)	Limit (dBm)	Margin (dB)
1	2117.50	-13.6	28.9	-0.3	28.6	62.14	-33.54

MODE		TX channel 66786					
Antenna Polarity & Test Distance: Horizontal at 3 M							
No.	Freq. (MHz)	Reading (dBm)	S.G Power Value (dBm)	Correction Factor (dB)	EIRP (dBm)	Limit (dBm)	Margin (dB)
1	2145.00	-16.8	25.1	-0.3	24.8	62.14	-37.34
Antenna Polarity & Test Distance: Vertical at 3 M							
No.	Freq. (MHz)	Reading (dBm)	S.G Power Value (dBm)	Correction Factor (dB)	EIRP (dBm)	Limit (dBm)	Margin (dB)
1	2145.00	-13.0	29.5	-0.3	29.2	62.14	-32.94

MODE		TX channel 67061					
Antenna Polarity & Test Distance: Horizontal at 3 M							
No.	Freq. (MHz)	Reading (dBm)	S.G Power Value (dBm)	Correction Factor (dB)	EIRP (dBm)	Limit (dBm)	Margin (dB)
1	2172.50	-16.8	25.3	-0.3	25.0	62.14	-37.14
Antenna Polarity & Test Distance: Vertical at 3 M							
No.	Freq. (MHz)	Reading (dBm)	S.G Power Value (dBm)	Correction Factor (dB)	EIRP (dBm)	Limit (dBm)	Margin (dB)
1	2172.50	-13.6	28.8	-0.3	28.5	62.14	-33.64

Note: EIRP (dBm) = S.G Power Value (dBm) + Correction Factor (dB).

Channel Bandwidth: 20MHz

MODE		TX channel 66536					
Antenna Polarity & Test Distance: Horizontal at 3 M							
No.	Freq. (MHz)	Reading (dBm)	S.G Power Value (dBm)	Correction Factor (dB)	EIRP (dBm)	Limit (dBm)	Margin (dB)
1	2120.00	-17.0	24.8	-0.3	24.5	62.14	-37.64
Antenna Polarity & Test Distance: Vertical at 3 M							
No.	Freq. (MHz)	Reading (dBm)	S.G Power Value (dBm)	Correction Factor (dB)	EIRP (dBm)	Limit (dBm)	Margin (dB)
1	2120.00	-13.0	29.5	-0.3	29.2	62.14	-32.94

MODE		TX channel 66786					
Antenna Polarity & Test Distance: Horizontal at 3 M							
No.	Freq. (MHz)	Reading (dBm)	S.G Power Value (dBm)	Correction Factor (dB)	EIRP (dBm)	Limit (dBm)	Margin (dB)
1	2145.00	-17.2	24.7	-0.3	24.4	62.14	-37.74
Antenna Polarity & Test Distance: Vertical at 3 M							
No.	Freq. (MHz)	Reading (dBm)	S.G Power Value (dBm)	Correction Factor (dB)	EIRP (dBm)	Limit (dBm)	Margin (dB)
1	2145.00	-13.7	28.8	-0.3	28.5	62.14	-33.64

MODE		TX channel 67036					
Antenna Polarity & Test Distance: Horizontal at 3 M							
No.	Freq. (MHz)	Reading (dBm)	S.G Power Value (dBm)	Correction Factor (dB)	EIRP (dBm)	Limit (dBm)	Margin (dB)
1	2170.00	-17.3	24.8	-0.3	24.5	62.14	-37.64
Antenna Polarity & Test Distance: Vertical at 3 m							
No.	Freq. (MHz)	Reading (dBm)	S.G Power Value (dBm)	Correction Factor (dB)	EIRP (dBm)	Limit (dBm)	Margin (dB)
1	2170.00	-13.9	28.5	-0.3	28.2	62.14	-33.94

Note: EIRP (dBm) = S.G Power Value (dBm) + Correction Factor (dB).

**For NB-IOT Guard Band:
QPSK_IoT Signal at Bottom**

Channel Bandwidth: 10MHz

MODE		TX channel 66486					
Antenna Polarity & Test Distance: Horizontal at 3 M							
No.	Freq. (MHz)	Reading (dBm)	S.G Power Value (dBm)	Correction Factor (dB)	EIRP (dBm)	Limit (dBm)	Margin (dB)
1	2115.00	-16.3	25.4	-0.3	25.1	62.14	-37.04
Antenna Polarity & Test Distance: Vertical at 3 M							
No.	Freq. (MHz)	Reading (dBm)	S.G Power Value (dBm)	Correction Factor (dB)	EIRP (dBm)	Limit (dBm)	Margin (dB)
1	2115.00	-13.6	28.9	-0.3	28.6	62.14	-33.54

MODE		TX channel 66786					
Antenna Polarity & Test Distance: Horizontal at 3 M							
No.	Freq. (MHz)	Reading (dBm)	S.G Power Value (dBm)	Correction Factor (dB)	EIRP (dBm)	Limit (dBm)	Margin (dB)
1	2145.00	-16.1	25.8	-0.3	25.5	62.14	-36.64
Antenna Polarity & Test Distance: Vertical at 3 M							
No.	Freq. (MHz)	Reading (dBm)	S.G Power Value (dBm)	Correction Factor (dB)	EIRP (dBm)	Limit (dBm)	Margin (dB)
1	2145.00	-13.4	29.1	-0.3	28.8	62.14	-33.34

MODE		TX channel 67086					
Antenna Polarity & Test Distance: Horizontal at 3 M							
No.	Freq. (MHz)	Reading (dBm)	S.G Power Value (dBm)	Correction Factor (dB)	EIRP (dBm)	Limit (dBm)	Margin (dB)
1	2175.00	-16.2	25.8	-0.2	25.6	62.14	-36.54
Antenna Polarity & Test Distance: Vertical at 3 M							
No.	Freq. (MHz)	Reading (dBm)	S.G Power Value (dBm)	Correction Factor (dB)	EIRP (dBm)	Limit (dBm)	Margin (dB)
1	2175.00	-12.6	29.7	-0.2	29.5	62.14	-32.64

Note: EIRP (dBm) = S.G Power Value (dBm) + Correction Factor (dB).

Channel Bandwidth: 15MHz

MODE		TX channel 66511					
Antenna Polarity & Test Distance: Horizontal at 3 M							
No.	Freq. (MHz)	Reading (dBm)	S.G Power Value (dBm)	Correction Factor (dB)	EIRP (dBm)	Limit (dBm)	Margin (dB)
1	2117.50	-16.0	25.7	-0.3	25.4	62.14	-36.74
Antenna Polarity & Test Distance: Vertical at 3 M							
No.	Freq. (MHz)	Reading (dBm)	S.G Power Value (dBm)	Correction Factor (dB)	EIRP (dBm)	Limit (dBm)	Margin (dB)
1	2117.50	-13.5	29.0	-0.3	28.7	62.14	-33.44

MODE		TX channel 66786					
Antenna Polarity & Test Distance: Horizontal at 3 M							
No.	Freq. (MHz)	Reading (dBm)	S.G Power Value (dBm)	Correction Factor (dB)	EIRP (dBm)	Limit (dBm)	Margin (dB)
1	2145.00	-15.7	26.2	-0.3	25.9	62.14	-36.24
Antenna Polarity & Test Distance: Vertical at 3 M							
No.	Freq. (MHz)	Reading (dBm)	S.G Power Value (dBm)	Correction Factor (dB)	EIRP (dBm)	Limit (dBm)	Margin (dB)
1	2145.00	-12.9	29.6	-0.3	29.3	62.14	-32.84

MODE		TX channel 67061					
Antenna Polarity & Test Distance: Horizontal at 3 M							
No.	Freq. (MHz)	Reading (dBm)	S.G Power Value (dBm)	Correction Factor (dB)	EIRP (dBm)	Limit (dBm)	Margin (dB)
1	2172.50	-16.3	25.8	-0.3	25.5	62.14	-36.64
Antenna Polarity & Test Distance: Vertical at 3 M							
No.	Freq. (MHz)	Reading (dBm)	S.G Power Value (dBm)	Correction Factor (dB)	EIRP (dBm)	Limit (dBm)	Margin (dB)
1	2172.50	-13.5	28.9	-0.3	28.6	62.14	-33.54

Note: EIRP (dBm) = S.G Power Value (dBm) + Correction Factor (dB).

Channel Bandwidth: 20MHz

MODE		TX channel 66536					
Antenna Polarity & Test Distance: Horizontal at 3 M							
No.	Freq. (MHz)	Reading (dBm)	S.G Power Value (dBm)	Correction Factor (dB)	EIRP (dBm)	Limit (dBm)	Margin (dB)
1	2120.00	-16.2	25.6	-0.3	25.3	62.14	-36.84
Antenna Polarity & Test Distance: Vertical at 3 M							
No.	Freq. (MHz)	Reading (dBm)	S.G Power Value (dBm)	Correction Factor (dB)	EIRP (dBm)	Limit (dBm)	Margin (dB)
1	2120.00	-12.9	29.6	-0.3	29.3	62.14	-32.84

MODE		TX channel 66786					
Antenna Polarity & Test Distance: Horizontal at 3 M							
No.	Freq. (MHz)	Reading (dBm)	S.G Power Value (dBm)	Correction Factor (dB)	EIRP (dBm)	Limit (dBm)	Margin (dB)
1	2145.00	-15.8	26.1	-0.3	25.8	62.14	-36.34
Antenna Polarity & Test Distance: Vertical at 3 M							
No.	Freq. (MHz)	Reading (dBm)	S.G Power Value (dBm)	Correction Factor (dB)	EIRP (dBm)	Limit (dBm)	Margin (dB)
1	2145.00	-13.4	29.1	-0.3	28.8	62.14	-33.34

MODE		TX channel 67036					
Antenna Polarity & Test Distance: Horizontal at 3 M							
No.	Freq. (MHz)	Reading (dBm)	S.G Power Value (dBm)	Correction Factor (dB)	EIRP (dBm)	Limit (dBm)	Margin (dB)
1	2170.00	-16.1	26.0	-0.3	25.7	62.14	-36.44
Antenna Polarity & Test Distance: Vertical at 3 M							
No.	Freq. (MHz)	Reading (dBm)	S.G Power Value (dBm)	Correction Factor (dB)	EIRP (dBm)	Limit (dBm)	Margin (dB)
1	2170.00	-13.6	28.8	-0.3	28.5	62.14	-33.64

Note: EIRP (dBm) = S.G Power Value (dBm) + Correction Factor (dB).

QPSK_IoT Signal at Top

Channel Bandwidth: 10MHz

MODE		TX channel 66486					
Antenna Polarity & Test Distance: Horizontal at 3 M							
No.	Freq. (MHz)	Reading (dBm)	S.G Power Value (dBm)	Correction Factor (dB)	EIRP (dBm)	Limit (dBm)	Margin (dB)
1	2115.00	-16.3	25.4	-0.3	25.1	62.14	-37.04
Antenna Polarity & Test Distance: Vertical at 3 M							
No.	Freq. (MHz)	Reading (dBm)	S.G Power Value (dBm)	Correction Factor (dB)	EIRP (dBm)	Limit (dBm)	Margin (dB)
1	2115.00	-13.5	29.0	-0.3	28.7	62.14	-33.44

MODE		TX channel 66786					
Antenna Polarity & Test Distance: Horizontal at 3 M							
No.	Freq. (MHz)	Reading (dBm)	S.G Power Value (dBm)	Correction Factor (dB)	EIRP (dBm)	Limit (dBm)	Margin (dB)
1	2145.00	-15.7	26.2	-0.3	25.9	62.14	-36.24
Antenna Polarity & Test Distance: Vertical at 3 M							
No.	Freq. (MHz)	Reading (dBm)	S.G Power Value (dBm)	Correction Factor (dB)	EIRP (dBm)	Limit (dBm)	Margin (dB)
1	2145.00	-13.2	29.3	-0.3	29.0	62.14	-33.14

MODE		TX channel 67086					
Antenna Polarity & Test Distance: Horizontal at 3 M							
No.	Freq. (MHz)	Reading (dBm)	S.G Power Value (dBm)	Correction Factor (dB)	EIRP (dBm)	Limit (dBm)	Margin (dB)
1	2175.00	-16.1	25.9	-0.2	25.7	62.14	-36.44
Antenna Polarity & Test Distance: Vertical at 3 M							
No.	Freq. (MHz)	Reading (dBm)	S.G Power Value (dBm)	Correction Factor (dB)	EIRP (dBm)	Limit (dBm)	Margin (dB)
1	2175.00	-12.7	29.6	-0.2	29.4	62.14	-32.74

Note: EIRP (dBm) = S.G Power Value (dBm) + Correction Factor (dB).

Channel Bandwidth: 15MHz

MODE		TX channel 66511					
Antenna Polarity & Test Distance: Horizontal at 3 M							
No.	Freq. (MHz)	Reading (dBm)	S.G Power Value (dBm)	Correction Factor (dB)	EIRP (dBm)	Limit (dBm)	Margin (dB)
1	2117.50	-17.0	24.7	-0.3	24.4	62.14	-37.74
Antenna Polarity & Test Distance: Vertical at 3 M							
No.	Freq. (MHz)	Reading (dBm)	S.G Power Value (dBm)	Correction Factor (dB)	EIRP (dBm)	Limit (dBm)	Margin (dB)
1	2117.50	-13.6	28.9	-0.3	28.6	62.14	-33.54

MODE		TX channel 66786					
Antenna Polarity & Test Distance: Horizontal at 3 M							
No.	Freq. (MHz)	Reading (dBm)	S.G Power Value (dBm)	Correction Factor (dB)	EIRP (dBm)	Limit (dBm)	Margin (dB)
1	2145.00	-16.5	25.4	-0.3	25.1	62.14	-37.04
Antenna Polarity & Test Distance: Vertical at 3 M							
No.	Freq. (MHz)	Reading (dBm)	S.G Power Value (dBm)	Correction Factor (dB)	EIRP (dBm)	Limit (dBm)	Margin (dB)
1	2145.00	-13.1	29.4	-0.3	29.1	62.14	-33.04

MODE		TX channel 67061					
Antenna Polarity & Test Distance: Horizontal at 3 M							
No.	Freq. (MHz)	Reading (dBm)	S.G Power Value (dBm)	Correction Factor (dB)	EIRP (dBm)	Limit (dBm)	Margin (dB)
1	2172.50	-16.9	25.2	-0.3	24.9	62.14	-37.24
Antenna Polarity & Test Distance: Vertical at 3 M							
No.	Freq. (MHz)	Reading (dBm)	S.G Power Value (dBm)	Correction Factor (dB)	EIRP (dBm)	Limit (dBm)	Margin (dB)
1	2172.50	-13.9	28.5	-0.3	28.2	62.14	-33.94

Note: EIRP (dBm) = S.G Power Value (dBm) + Correction Factor (dB).

Channel Bandwidth: 20MHz

MODE		TX channel 66536					
Antenna Polarity & Test Distance: Horizontal at 3 M							
No.	Freq. (MHz)	Reading (dBm)	S.G Power Value (dBm)	Correction Factor (dB)	EIRP (dBm)	Limit (dBm)	Margin (dB)
1	2120.00	-16.9	24.9	-0.3	24.6	62.14	-37.54
Antenna Polarity & Test Distance: Vertical at 3 M							
No.	Freq. (MHz)	Reading (dBm)	S.G Power Value (dBm)	Correction Factor (dB)	EIRP (dBm)	Limit (dBm)	Margin (dB)
1	2120.00	-13.0	29.5	-0.3	29.2	62.14	-32.94

MODE		TX channel 66786					
Antenna Polarity & Test Distance: Horizontal at 3 M							
No.	Freq. (MHz)	Reading (dBm)	S.G Power Value (dBm)	Correction Factor (dB)	EIRP (dBm)	Limit (dBm)	Margin (dB)
1	2145.00	-16.1	25.8	-0.3	25.5	62.14	-36.64
Antenna Polarity & Test Distance: Vertical at 3 M							
No.	Freq. (MHz)	Reading (dBm)	S.G Power Value (dBm)	Correction Factor (dB)	EIRP (dBm)	Limit (dBm)	Margin (dB)
1	2145.00	-13.5	29.0	-0.3	28.7	62.14	-33.44

MODE		TX channel 67036					
Antenna Polarity & Test Distance: Horizontal at 3 M							
No.	Freq. (MHz)	Reading (dBm)	S.G Power Value (dBm)	Correction Factor (dB)	EIRP (dBm)	Limit (dBm)	Margin (dB)
1	2170.00	-16.0	26.1	-0.3	25.8	62.14	-36.34
Antenna Polarity & Test Distance: Vertical at 3 M							
No.	Freq. (MHz)	Reading (dBm)	S.G Power Value (dBm)	Correction Factor (dB)	EIRP (dBm)	Limit (dBm)	Margin (dB)
1	2170.00	-13.8	28.6	-0.3	28.3	62.14	-33.84

Note: EIRP (dBm) = S.G Power Value (dBm) + Correction Factor (dB).

4.2 Modulation Characteristics Measurement

4.2.1 Limits of Modulation Characteristics

N/A

4.2.2 Test Procedure

Connect the EUT to Communication Simulator via the antenna connector, the frequency band is set as EUT supported Modulation and Channels, the EUT output is matched with 50 ohm load, the waveform quality and constellation of the EUT was tested.

4.2.3 Test Setup



4.2.4 Test Results

For NB-IOT In-band:

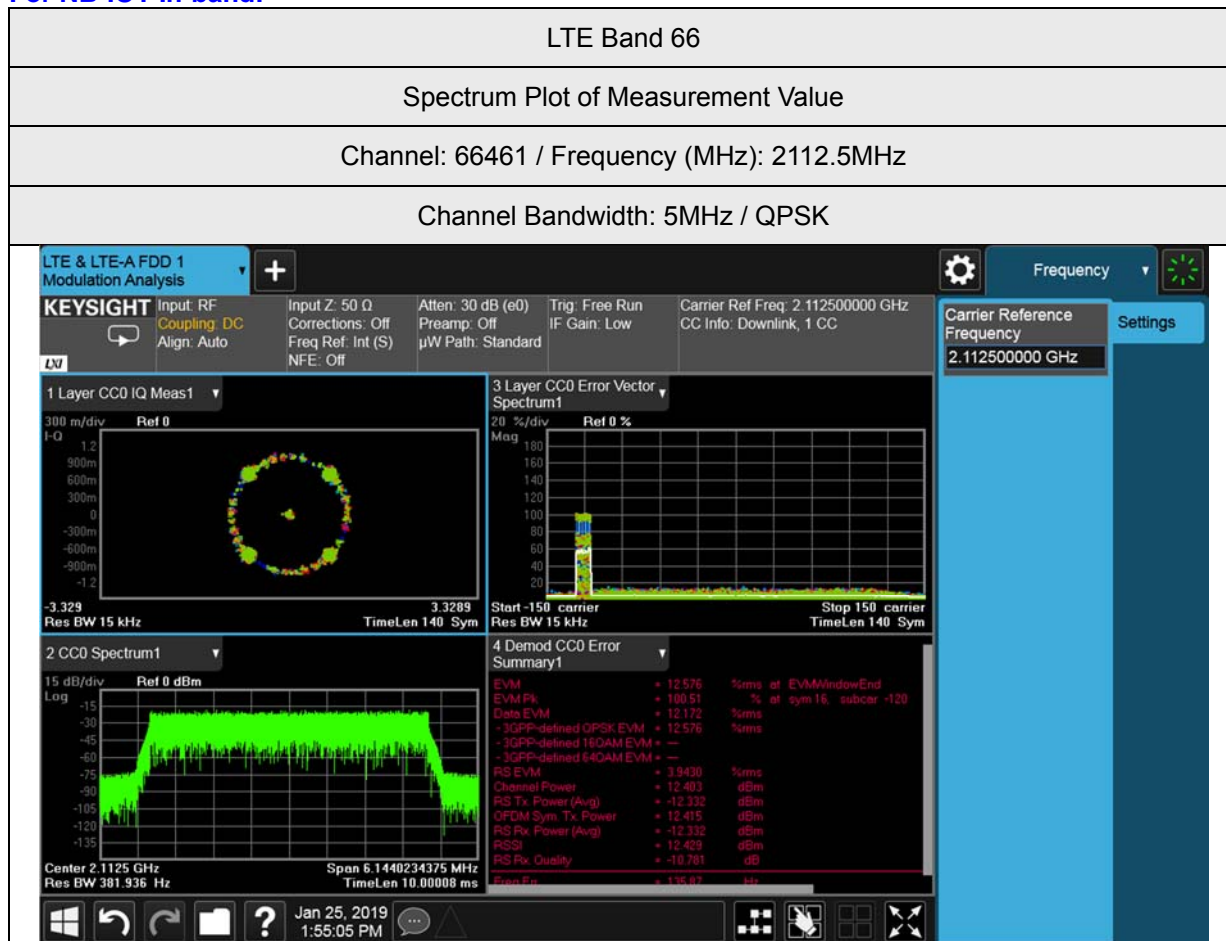

For NB-IOT Guard Band:

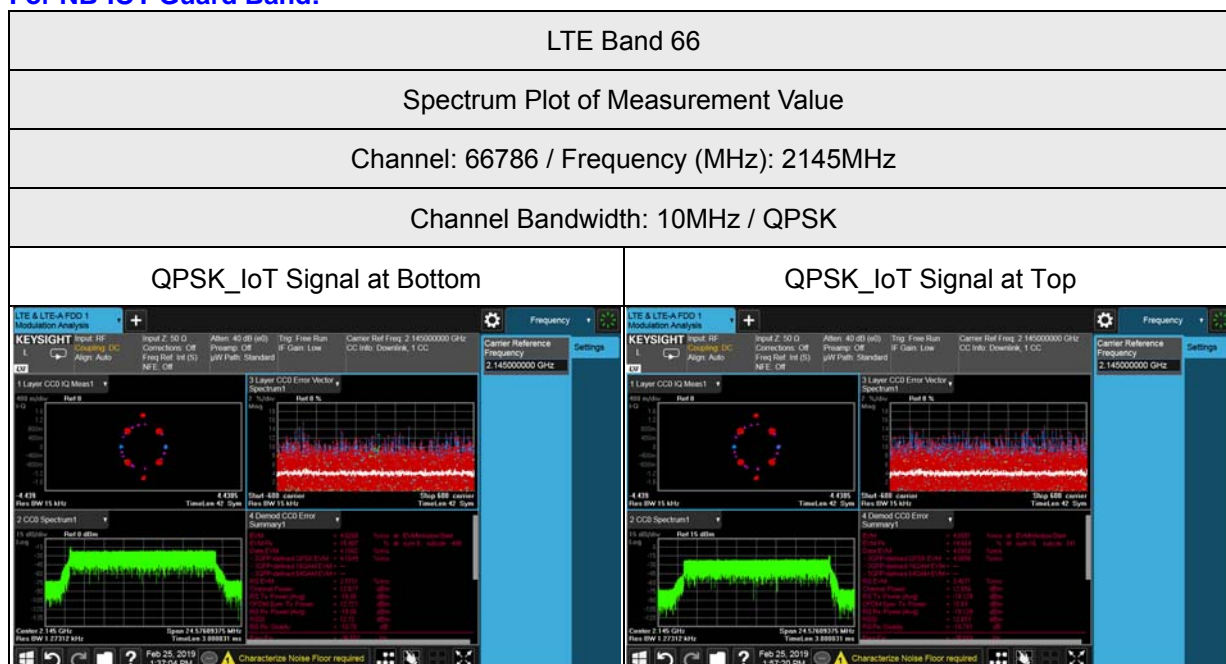

4.3 Frequency Stability Measurement

4.3.1 Limits of Frequency Stability Measurement

According to the FCC part 2.1055 shall be tested the frequency stability. The rule is defined that "The frequency stability shall be sufficient to ensure that the fundamental emission stays within the authorized frequency block." The test extreme voltage is according to the 2.1055(d)(1) Vary primary supply voltage from 85 to 115 percent of the nominal value for other than hand carried battery equipment and the extreme temperature rule is comply with specification of EUT $-30^{\circ}\text{C} \sim 50^{\circ}\text{C}$.

4.3.2 Test Procedure

- Device is placed at the oven room. The oven room could control the temperatures and humidity. Power warm up is at least 15 min and power applied should perform before recording frequency error.
- EUT is connected the external power supply to control the DC input power. The test voltage range is from minimum to maximum working voltage. Each step shall be record the frequency error rate.
- The temperature range step is 10 degrees in this test items. All temperature levels shall be hold the $\pm 0.5^{\circ}\text{C}$ during the measurement testing. The each temperature step shall be at least 0.5 hours, consider the EUT could be test under the stability condition.

Note: The frequency error was recorded frequency error from the communication simulator.

4.3.3 Test Setup

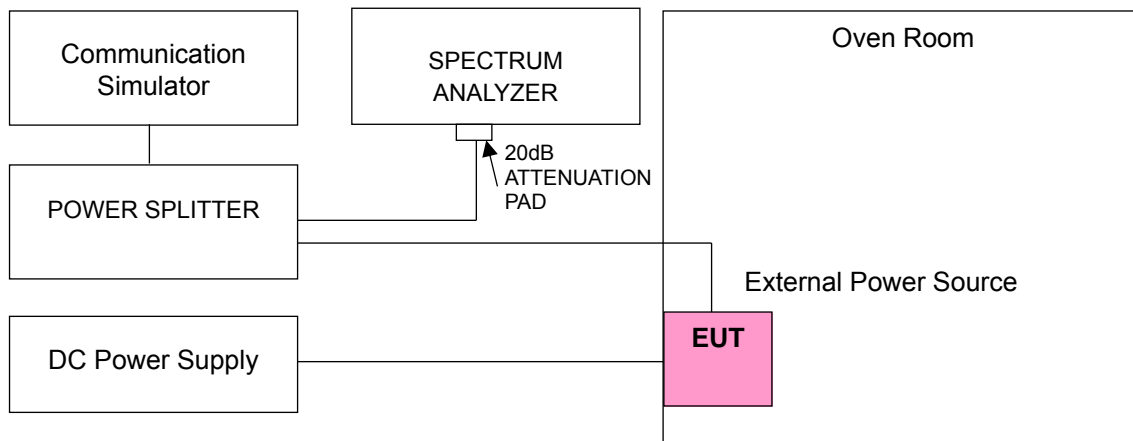

4.3.4 Test Results

For NB-IOT Guard Band:

Frequency Error vs. Voltage

Voltage (Volts)	LTE Band 66	Limit (ppm)
	Frequency error (ppm)	
13.2	0.07851	2.5
12	0.00307	2.5
10.8	0.08978	2.5

Note: The applicant defined the normal working voltage is from 10.8Vdc to 13.2Vdc.

TEMP. (°C)	LTE Band 66	Limit (ppm)
	Frequency error (ppm)	
50	0.03818	2.5
40	0.12732	2.5
30	0.00895	2.5
20	0.00307	2.5
10	0.11836	2.5
0	0.09032	2.5
-10	0.14847	2.5
-20	0.06566	2.5
-30	0.14562	2.5

4.4 Emission Bandwidth Measurement

4.4.1 Limits of Emission Bandwidth Measurement

According to FCC 27.53(m)(6) specified that emission bandwidth is defined as the width of the signal between two points, one below the carrier center frequency and one above the carrier center frequency, outside of which all emissions are attenuated at least 26dB below the transmitter power.

4.4.2 Test Procedure

The transmitter output was connected to the spectrum analyzer through an attenuator. The bandwidth of the fundamental frequency was measured by spectrum analyzer with RBW = 30kHz and VBW = 100kHz (Channel Bandwidth: 1.4MHz), RBW = 51kHz and VBW = 150kHz (Channel Bandwidth: 3MHz and 5MHz), RBW = 100kHz and VBW = 300kHz (Channel Bandwidth: 10MHz), RBW = 200kHz and VBW = 620kHz (Channel Bandwidth: 15MHz) and RBW = 430kHz and VBW = 1.2MHz (Channel Bandwidth: 20MHz). The 26dB bandwidth is defined as the total spectrum the power of which is higher than peak power minus 26dB.

4.4.3 Test Setup

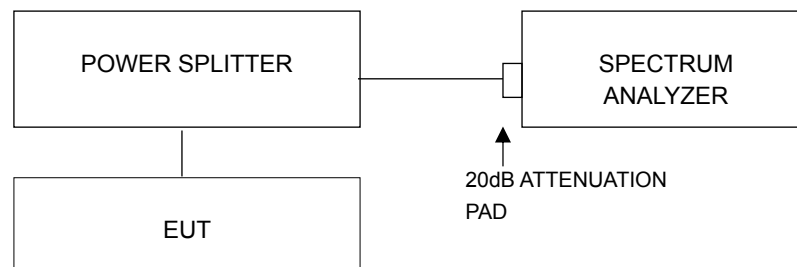

4.4.4 Test Result

LTE Band 66

For NB-IOT In-band:

Channel Bandwidth: 5MHz					
Channel	Frequency (MHz)	26dBc Bandwidth (MHz)		Occupied Bandwidth (MHz)	
		Chain 0	Chain 1	Chain 0	Chain 1
66461	2112.5	4.810	4.835	4.49	4.49
66786	2145.0	4.808	4.789	4.49	4.49
67111	2177.5	4.794	4.811	4.49	4.49

Channel Bandwidth: 20MHz					
Channel	Frequency (MHz)	26dBc Bandwidth (MHz)		Occupied Bandwidth (MHz)	
		Chain 0	Chain 1	Chain 0	Chain 1
66536	2120.0	19.487	19.579	18.08	18.08
66786	2145.0	19.513	19.559	18.08	18.08
67036	2170.0	19.600	19.481	18.08	18.02

26dBc Bandwidth

Spectrum Plot of Worst Value

5MHz / Chain 1

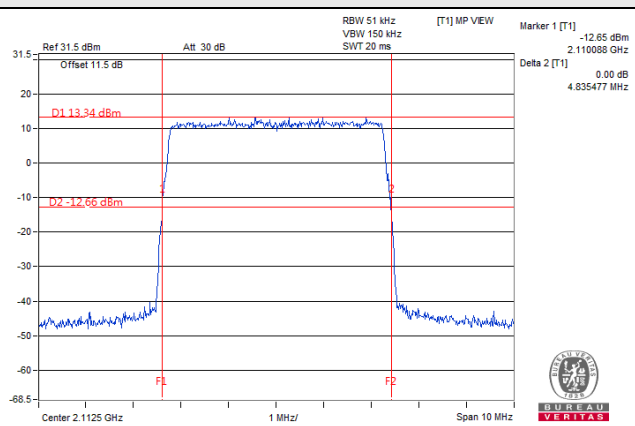

20MHz / Chain 0

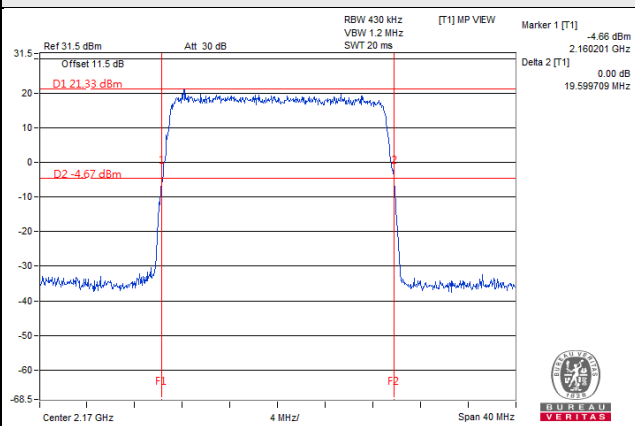

Occupied Bandwidth

Spectrum Plot of Worst Value

5MHz / Chain 0

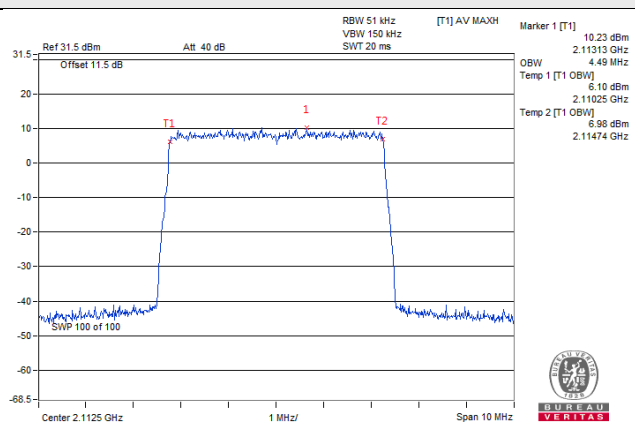

20MHz / Chain 0

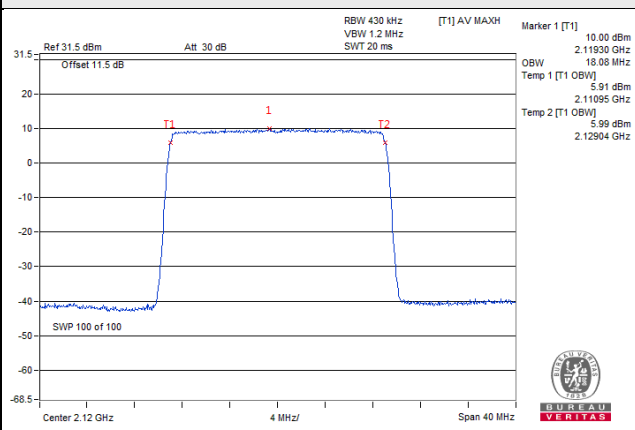

**For NB-IOT Guard Band:
QPSK_IoT Signal at Bottom**

Channel Bandwidth: 10MHz					
Channel	Frequency (MHz)	26dBc Bandwidth (MHz)		Occupied Bandwidth (MHz)	
		Chain 0	Chain 1	Chain 0	Chain 1
66486	2115.0	9.966	9.953	9.18	9.21
66786	2145.0	9.914	9.928	9.18	9.18
67086	2175.0	9.891	9.838	9.18	9.18

Channel Bandwidth: 15MHz					
Channel	Frequency (MHz)	26dBc Bandwidth (MHz)		Occupied Bandwidth (MHz)	
		Chain 0	Chain 1	Chain 0	Chain 1
66511	2117.5	15.047	15.046	13.76	13.76
66786	2145.0	15.050	15.030	13.76	13.76
67061	2172.5	14.890	14.903	13.76	13.76

Channel Bandwidth: 20MHz					
Channel	Frequency (MHz)	26dBc Bandwidth (MHz)		Occupied Bandwidth (MHz)	
		Chain 0	Chain 1	Chain 0	Chain 1
66536	2120.0	20.403	20.336	18.43	18.43
66786	2145.0	20.426	20.368	18.43	18.43
67036	2170.0	20.235	20.253	18.43	18.37

26dBc Bandwidth

Spectrum Plot of Worst Value

10MHz / Chain 0

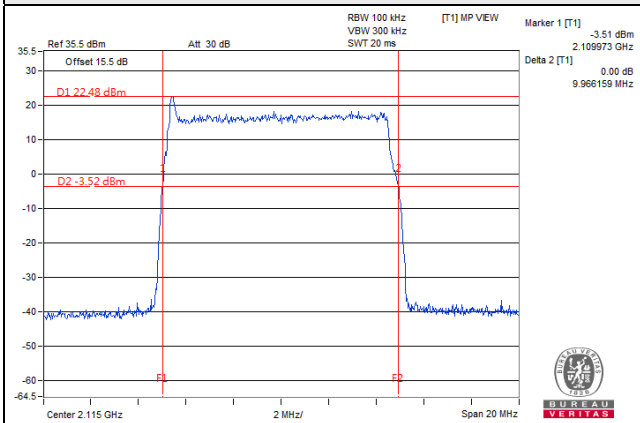

15MHz / Chain 0

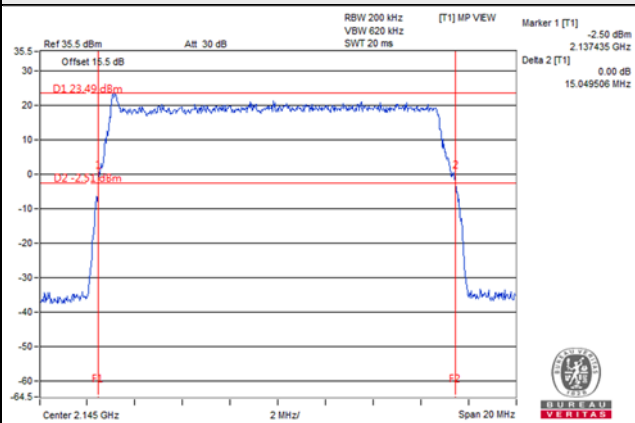

20MHz / Chain 0

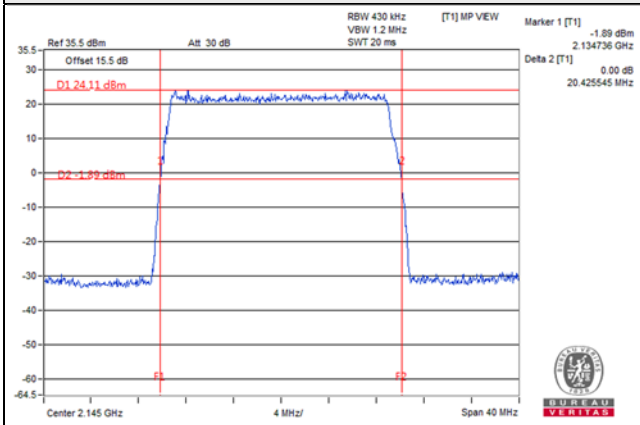

Occupied Bandwidth Spectrum Plot of Worst Value

10MHz / Chain 1

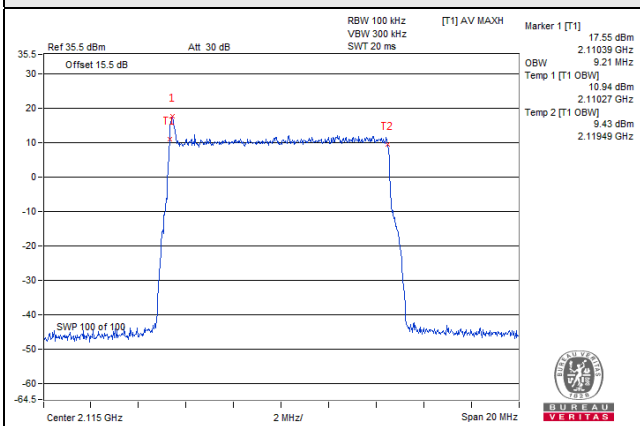

15MHz / Chain 0

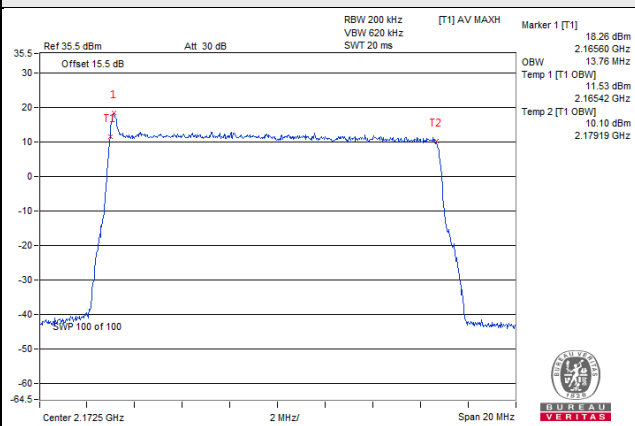

20MHz / Chain 0

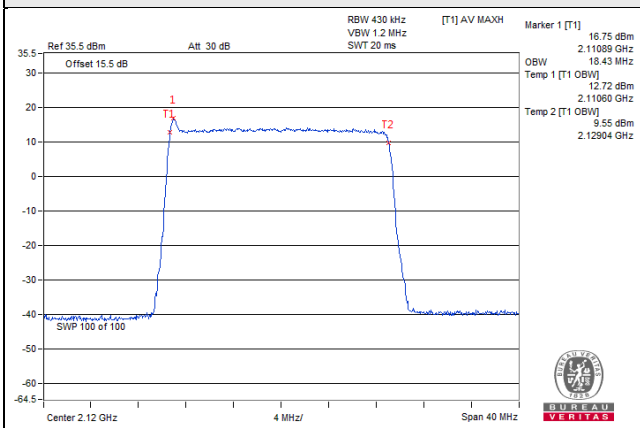

**For NB-IOT Guard Band:
QPSK_IoT Signal at Top**

Channel Bandwidth: 10MHz					
Channel	Frequency (MHz)	26dBc Bandwidth (MHz)		Occupied Bandwidth (MHz)	
		Chain 0	Chain 1	Chain 0	Chain 1
66486	2115.0	9.930	9.915	9.18	9.18
66786	2145.0	9.871	9.961	9.18	9.18
67086	2175.0	9.997	9.952	9.21	9.21

Channel Bandwidth: 15MHz					
Channel	Frequency (MHz)	26dBc Bandwidth (MHz)		Occupied Bandwidth (MHz)	
		Chain 0	Chain 1	Chain 0	Chain 1
66511	2117.5	15.038	14.861	13.73	13.76
66786	2145.0	14.968	14.953	13.79	13.79
67061	2172.5	14.994	15.002	13.76	13.76

Channel Bandwidth: 20MHz					
Channel	Frequency (MHz)	26dBc Bandwidth (MHz)		Occupied Bandwidth (MHz)	
		Chain 0	Chain 1	Chain 0	Chain 1
66536	2120.0	20.306	20.305	18.43	18.43
66786	2145.0	20.223	20.270	18.43	18.43
67036	2170.0	20.345	20.419	18.43	18.43

26dBc Bandwidth

Spectrum Plot of Worst Value

10MHz / Chain 0

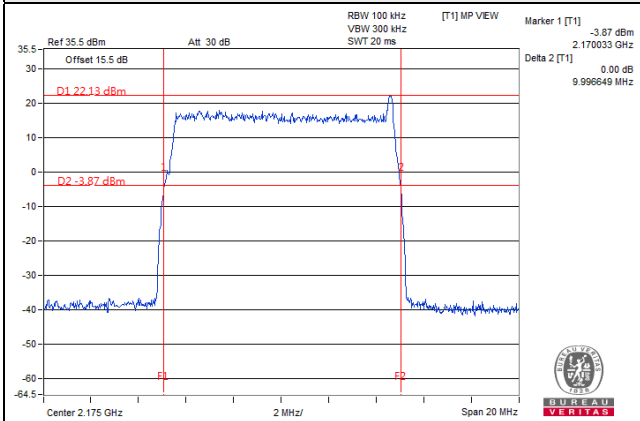

15MHz / Chain 0

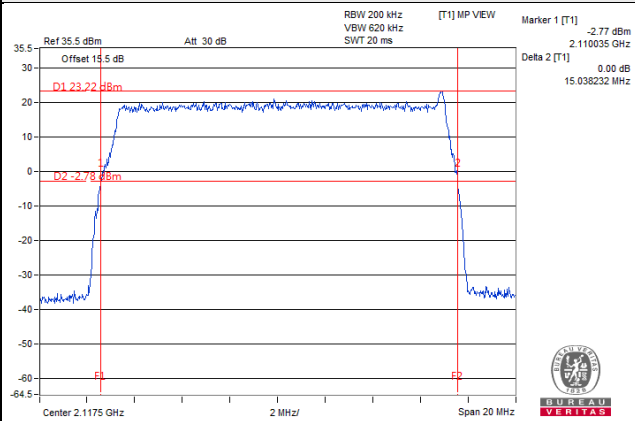

20MHz / Chain 1

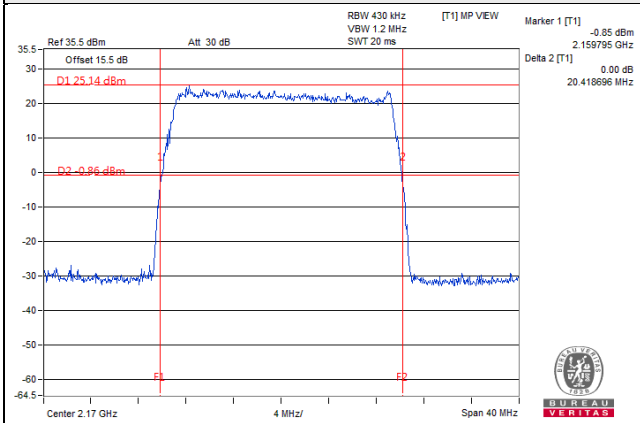

Occupied Bandwidth
Spectrum Plot of Worst Value

10MHz / Chain 0

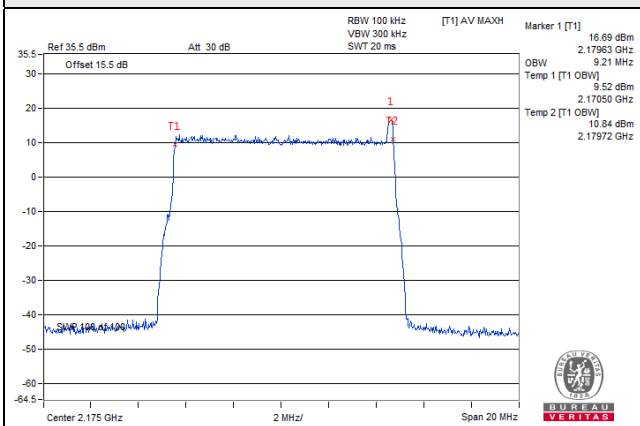

15MHz / Chain 0

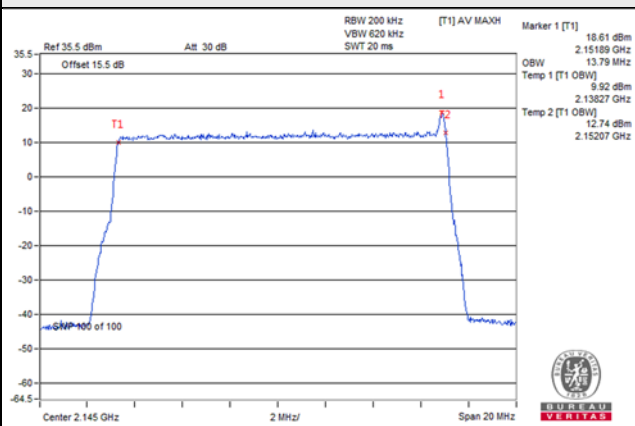

20MHz / Chain 0

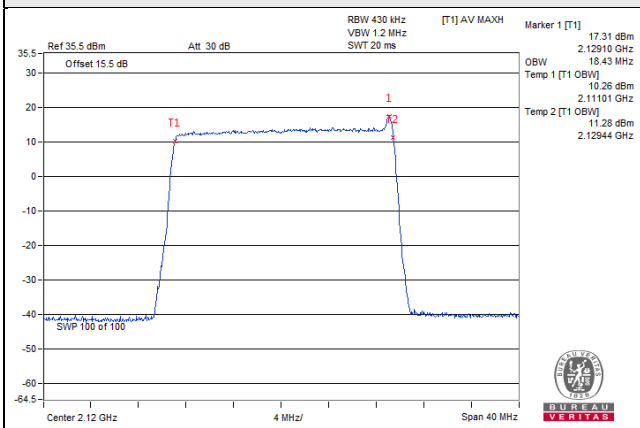

4.5 Band Edge Measurement

4.5.1 Limits of Band Edge Measurement

According to FCC 27.53(h) for operations in the 1695-1710 MHz, 1710-1755 MHz, 1755-1780 MHz, 1915-1920 MHz, 1995-2000 MHz, 2000-2020 MHz, 2110-2155 MHz, 2155-2180 MHz, and 2180-2200 bands, the power of any emission outside a licensee's frequency block shall be attenuated below the transmitter power (P) in watts by at least $43 + 10 \log (P)$ dB.

Note:

This device can be implement MIMO function, so the limit of spurious emissions needs to be reduced by $10\log(\text{Numbers}_{\text{Ant}})$ according to FCC KDB 662911 D01 guidance.

4.5.2 Test Setup

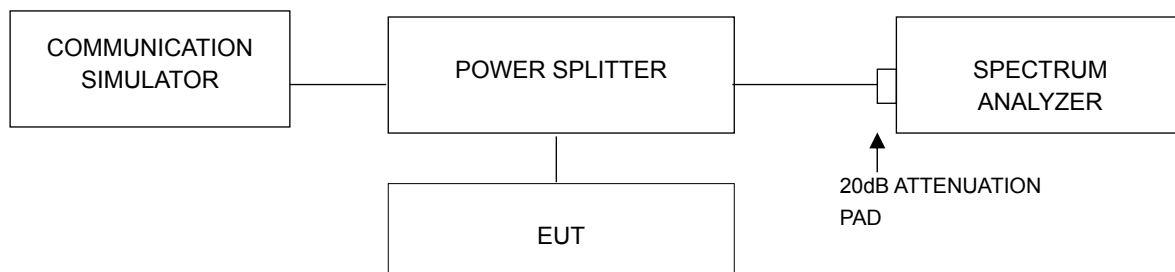

4.5.3 Test Procedures

- The EUT was set up for the rated peak power. The power was measured with Spectrum Analyzer. All measurements were done at 3 channels: low, middle and high operational frequency range.
- The center frequency of spectrum is the band edge frequency and span is 1.5MHz. RBW = 15kHz and VBW = 51kHz (Channel Bandwidth: 1.4MHz), RBW = 30kHz and VBW = 100kHz (Channel Bandwidth: 3MHz), RBW = 62kHz and VBW = 200kHz (Channel Bandwidth: 5MHz), RBW = 100kHz and VBW = 300kHz (Channel Bandwidth: 10MHz), RBW = 150kHz and VBW = 470kHz (Channel Bandwidth: 15MHz) and RBW = 200kHz and VBW = 1MHz (Channel Bandwidth: 20MHz).
- Record the max trace plot into the test report.

LTE Band 66
For NB-IOT Guard Band:
QPSK_IoT Signal at Bottom

Channel Bandwidth: 10MHz

Channel 66486 (2115.0MHz)	QPSK	Chain 0	Channel 67086 (2175.0MHz)	QPSK	Chain 0
------------------------------	------	---------	------------------------------	------	---------

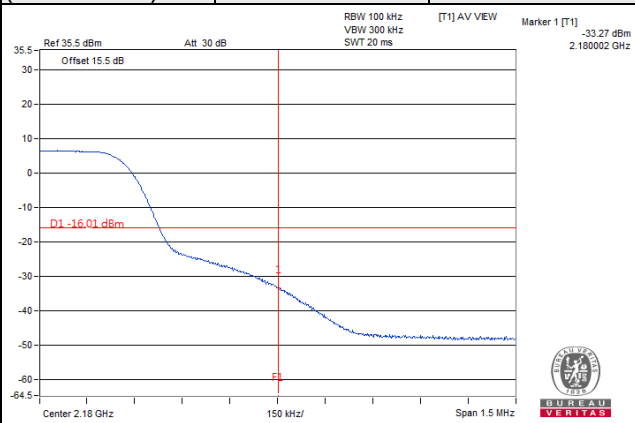
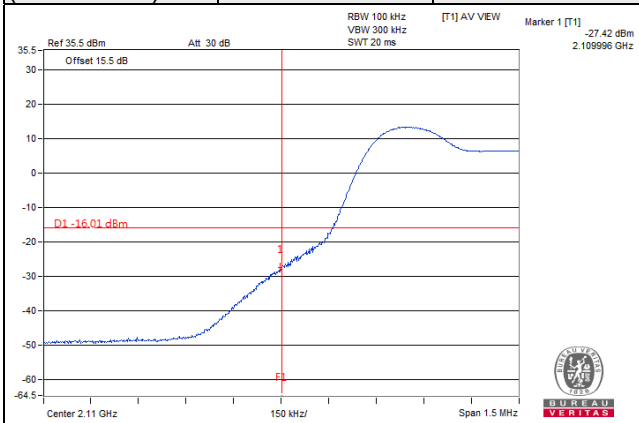

Channel 66486 (2115.0MHz)	QPSK	Chain 1	Channel 67086 (2175.0MHz)	QPSK	Chain 1
------------------------------	------	---------	------------------------------	------	---------

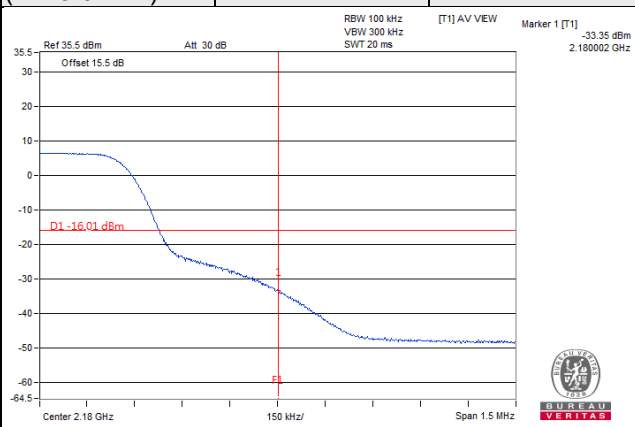
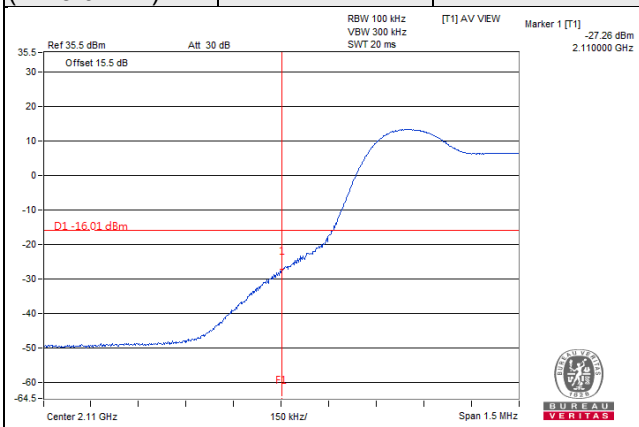

Channel Bandwidth: 15MHz

**Channel 66511
(2117.5MHz)**

QPSK

Chain 0

**Channel 67061
(2172.5MHz)**

QPSK

Chain 0

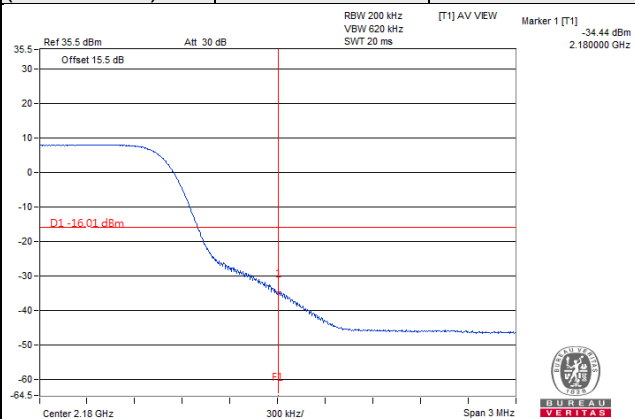
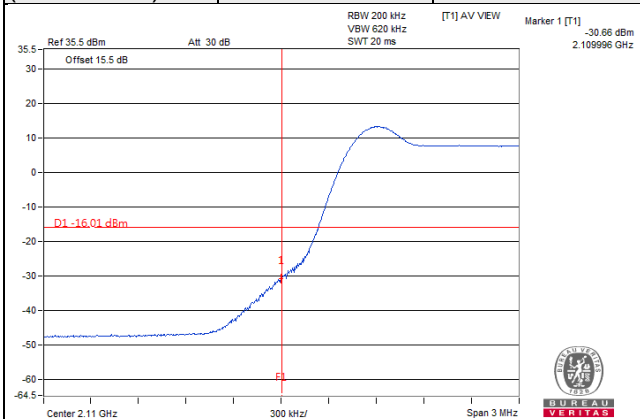

**Channel 66511
(2117.5MHz)**

QPSK

Chain 1

**Channel 67061
(2172.5MHz)**

QPSK

Chain 1

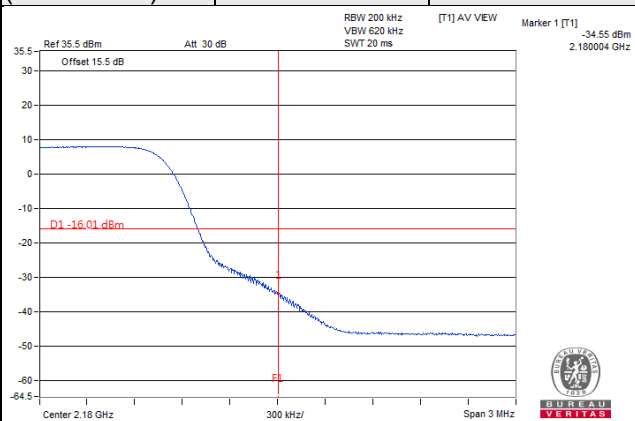
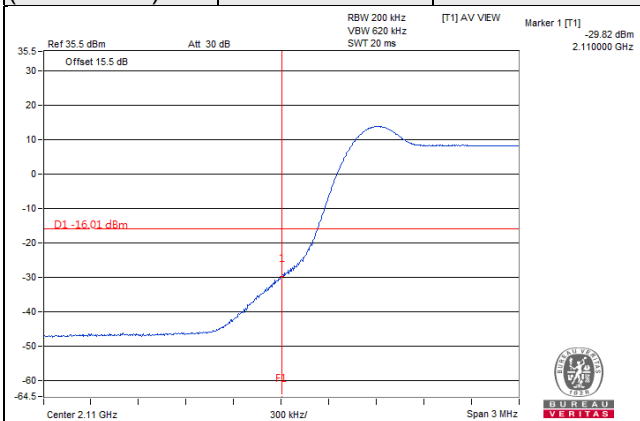

Channel Bandwidth: 20MHz

**Channel 66536
(2120.0MHz)**

QPSK

Chain 0

**Channel 67036
(2170.0MHz)**

QPSK

Chain 0

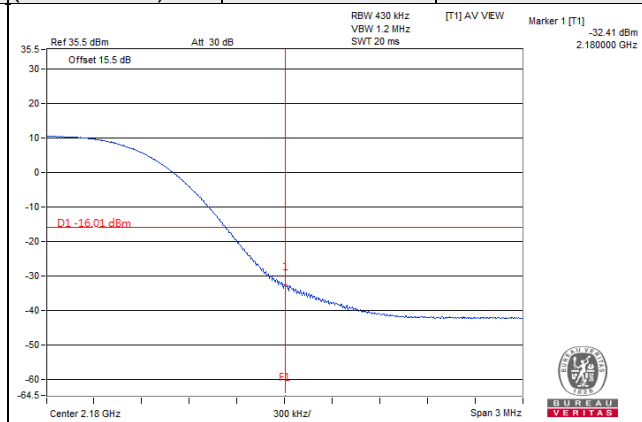
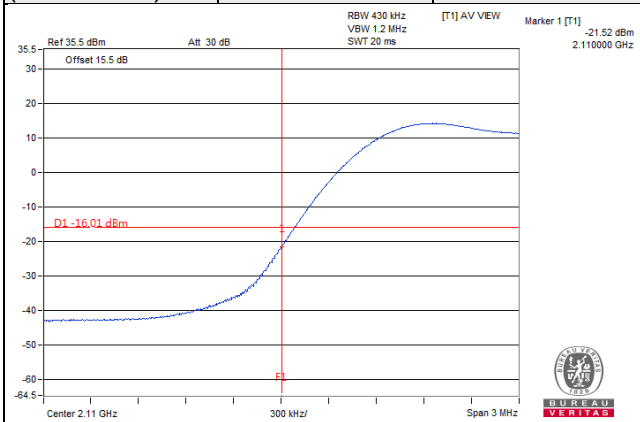

**Channel 66536
(2120.0MHz)**

QPSK

Chain 1

**Channel 67036
(2170.0MHz)**

QPSK

Chain 1

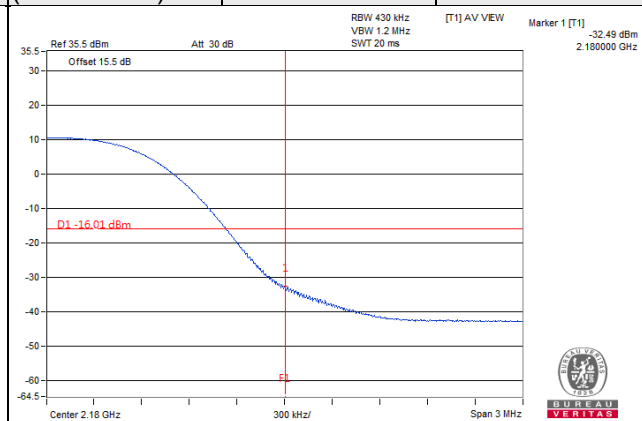
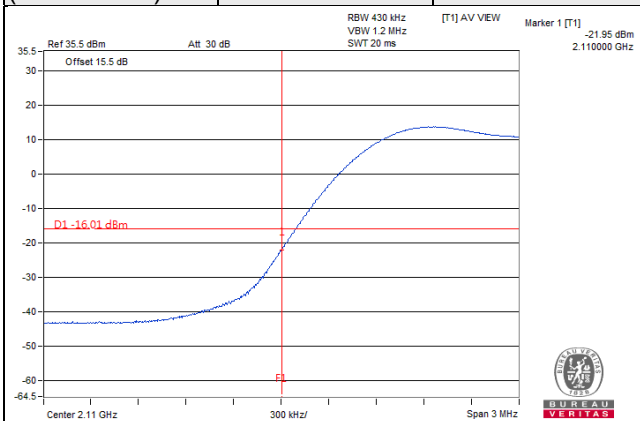

QPSK_IoT Signal at Top

Channel Bandwidth: 10MHz

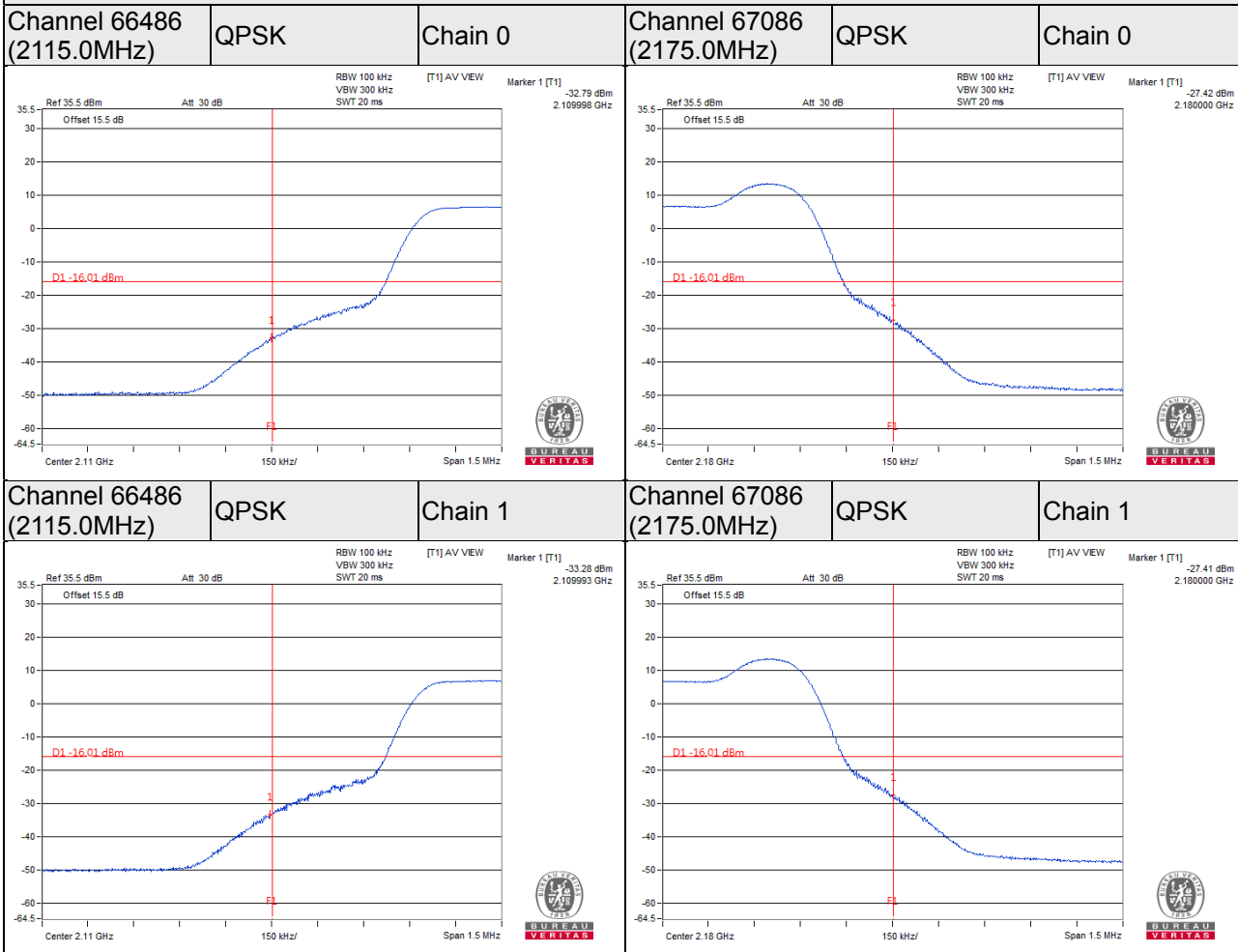

Channel Bandwidth: 15MHz

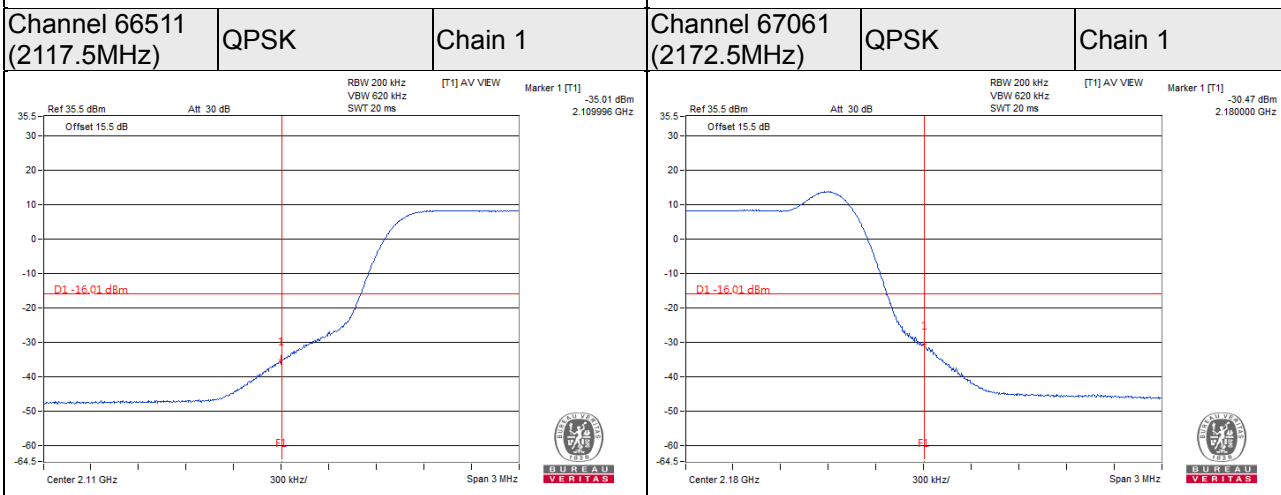
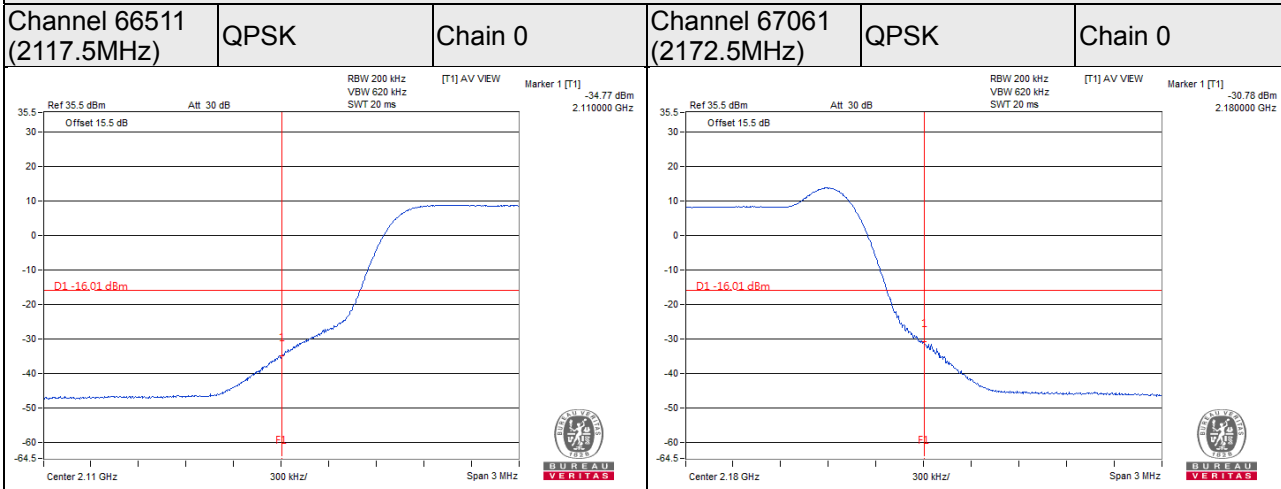

Channel Bandwidth: 20MHz

**Channel 66536
(2120.0MHz)**

QPSK

Chain 0

**Channel 67036
(2170.0MHz)**

QPSK

Chain 0

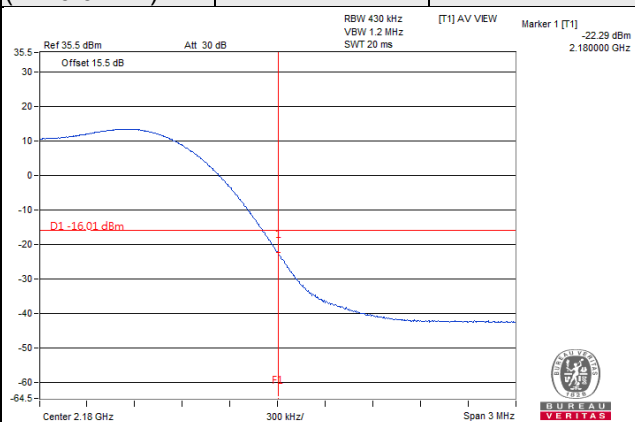
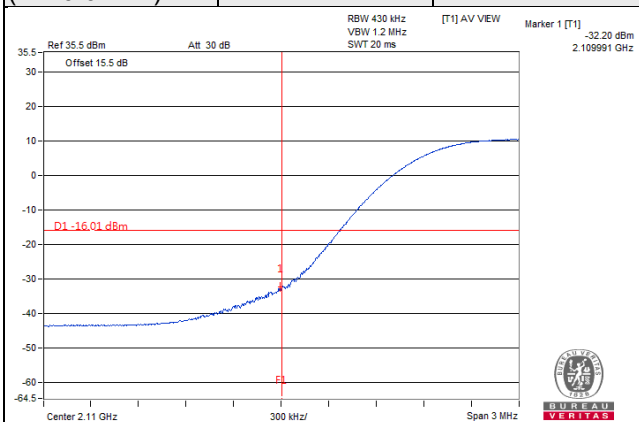

**Channel 66536
(2120.0MHz)**

QPSK

Chain 1

**Channel 67036
(2170.0MHz)**

QPSK

Chain 1

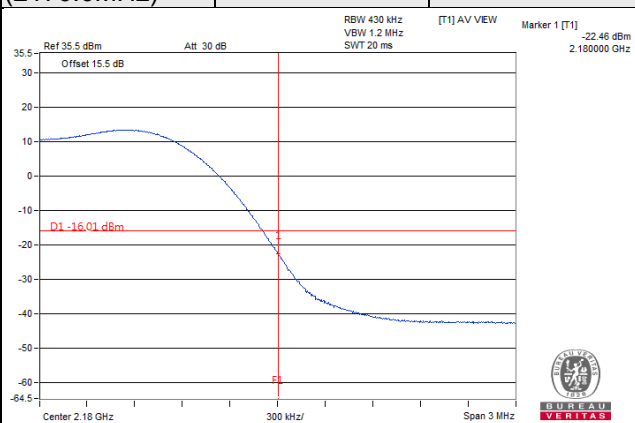
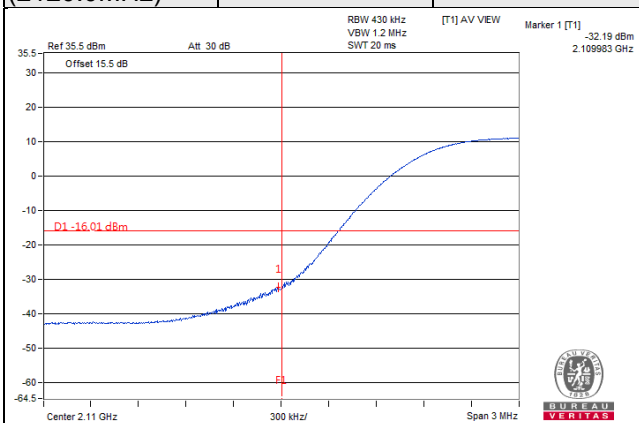

4.6 Peak to Average Ratio

4.6.1 Limits of Peak to Average Ratio Measurement

In measuring transmissions in this band using an average power technique, the peak to-average ratio (PAR) of the transmission may not exceed 13 dB

4.6.2 Test Setup

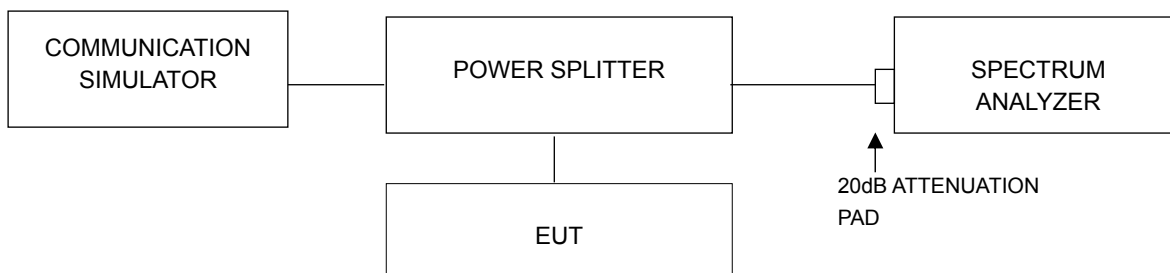

4.6.3 Test Procedures

- Set resolution/measurement bandwidth \geq signal's occupied bandwidth;
- Set the number of counts to a value that stabilizes the measured CCDF curve;
- Record the maximum PAPR level associated with a probability of 0.1%.

4.6.4 Test Results

For NB-IOT Guard Band: QPSK_IoT Signal at Bottom

LTE Band 66, Channel Bandwidth: 10MHz			
Channel	Frequency (MHz)	Peak To Average Ratio (dB)	
		Chain 0	Chain 1
66486	2115.0	7.05	7.05
66786	2145.0	7.04	7.03
67086	2175.0	7.05	7.04

LTE Band 66, Channel Bandwidth: 15MHz			
Channel	Frequency (MHz)	Peak To Average Ratio (dB)	
		Chain 0	Chain 1
66511	2117.5	7.10	7.10
66786	2145.0	7.09	7.09
67061	2172.5	7.08	7.08

LTE Band 66, Channel Bandwidth: 20MHz			
Channel	Frequency (MHz)	Peak To Average Ratio (dB)	
		Chain 0	Chain 1
66536	2120.0	7.11	7.11
66786	2145.0	7.12	7.11
67036	2170.0	7.10	7.11

Spectrum Plot of Worst Value

10MHz / Chain 0

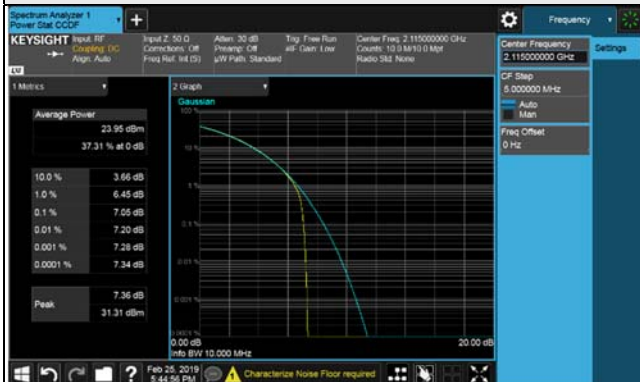

15MHz / Chain 0

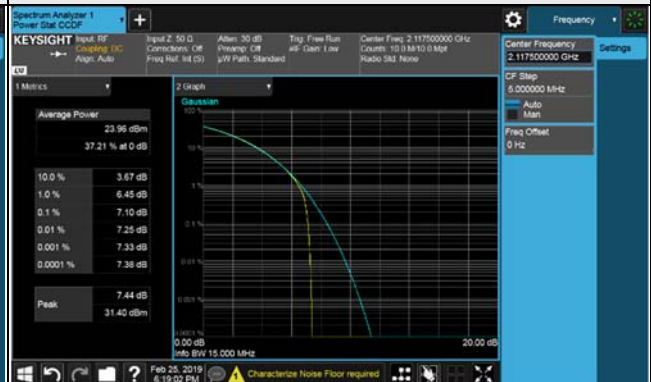

20MHz / Chain 0

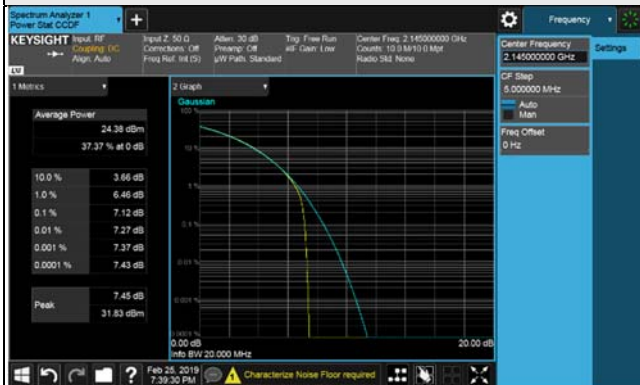

QPSK_IoT Signal at Top

LTE Band 66, Channel Bandwidth: 10MHz			
Channel	Frequency (MHz)	Peak To Average Ratio (dB)	
		Chain 0	Chain 1
66486	2115.0	7.06	7.05
66786	2145.0	7.03	7.04
67086	2175.0	7.06	7.05

LTE Band 66, Channel Bandwidth: 15MHz			
Channel	Frequency (MHz)	Peak To Average Ratio (dB)	
		Chain 0	Chain 1
66511	2117.5	7.10	7.10
66786	2145.0	7.08	7.08
67061	2172.5	7.08	7.08

LTE Band 66, Channel Bandwidth: 20MHz			
Channel	Frequency (MHz)	Peak To Average Ratio (dB)	
		Chain 0	Chain 1
66536	2120.0	7.11	7.11
66786	2145.0	7.11	7.11
67036	2170.0	7.10	7.10

Spectrum Plot of Worst Value

10MHz / Chain 0

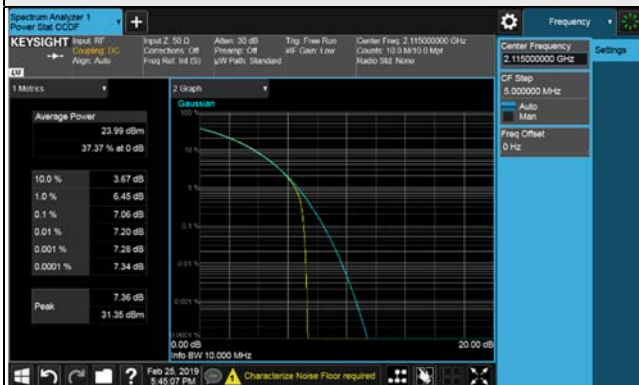

15MHz / Chain 0



20MHz / Chain 0

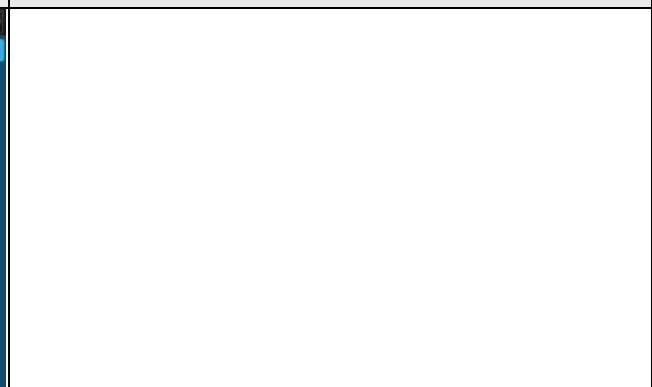
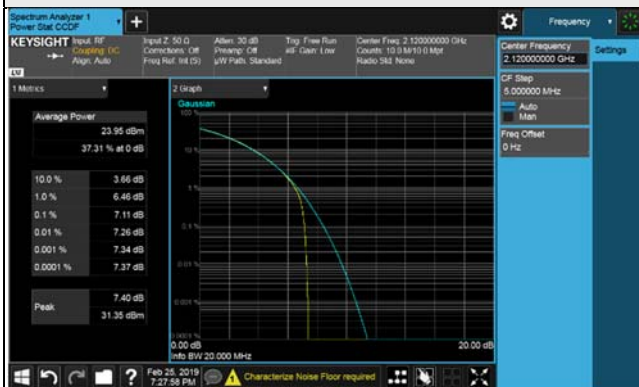

4.7 Conducted Spurious Emissions

4.7.1 Limits of Conducted Spurious Emissions Measurement

In the FCC 27.53(h)(1), On any frequency outside a licensee's frequency block, The power of any emission shall be attenuated below the transmitter power (P) by at least $43 + 10 \log (P)$ dB.

Note:

This device can be implement MIMO function, so the limit of spurious emissions needs to be reduced by $10 \log(\text{Numbers}_{\text{Ant}})$ according to FCC KDB 662911 D01 guidance.

4.7.2 Test Setup

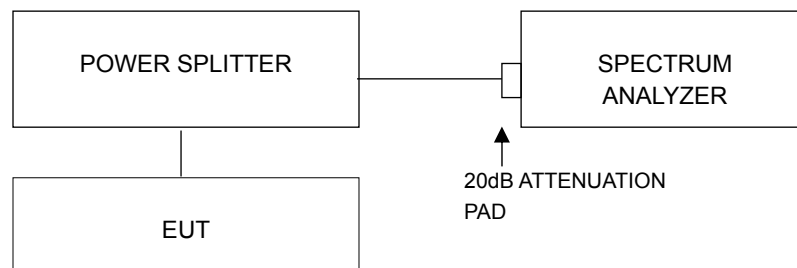

4.7.3 Test Procedure

- a. All measurements were done at 3 channels: low, middle and high operational frequency range.
- b. When the spectrum scanned from 9kHz to 26.5GHz, it shall be connected to the attenuator with the carried frequency.

4.7.4 Test Results

LTE Band 66

For NB-IOT In-band:

Channel Bandwidth: 5MHz (Chain 0)

Channel 66461 (2112.5MHz)

Frequency Range : 9kHz~1GHz

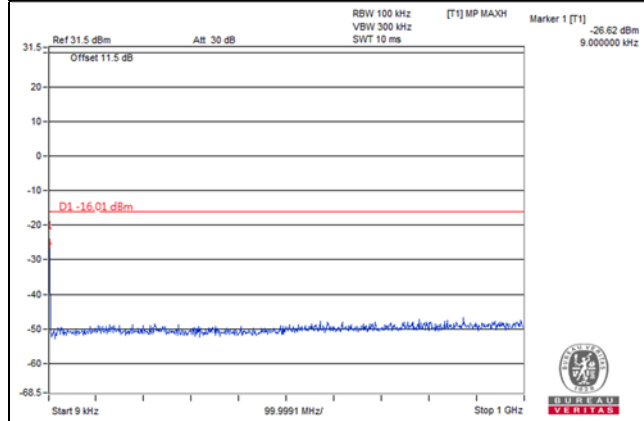

Frequency Range : 1GHz~10GHz

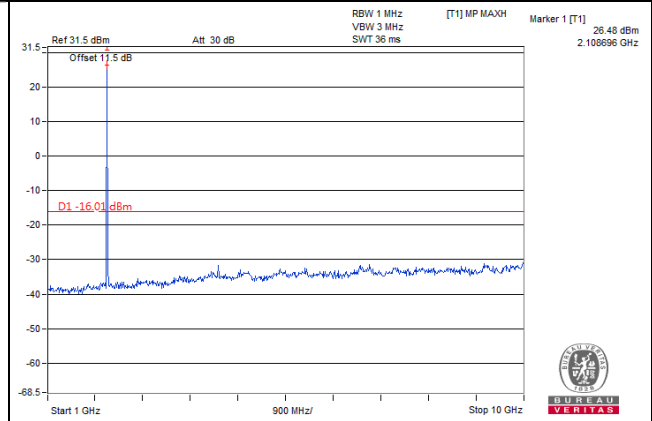

Frequency Range : 10GHz~26.5GHz

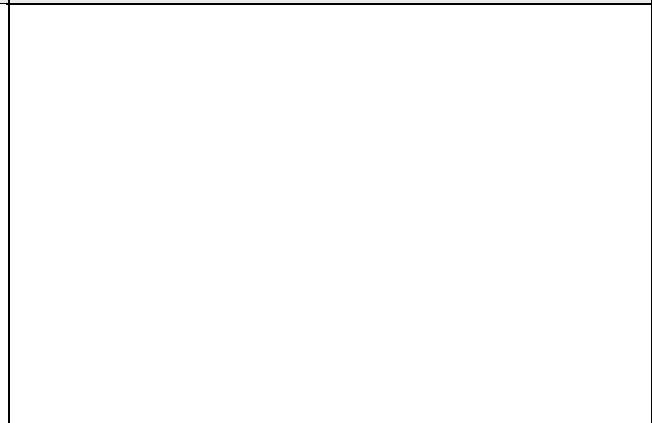
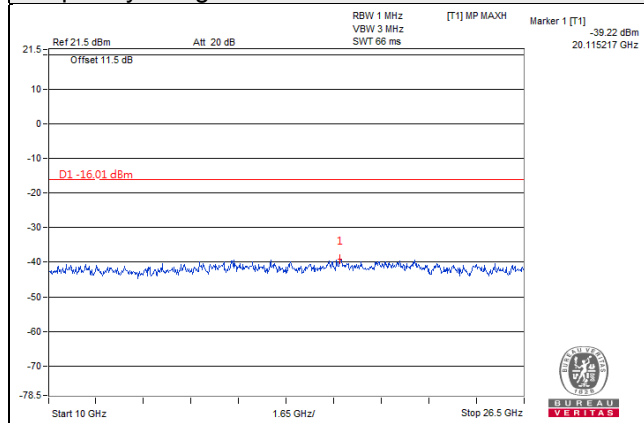

Note: For 9kHz, the signal is from spectrum analyzer.

Channel Bandwidth: 5MHz (Chain 0)

Channel 66786 (2145.0MHz)

Frequency Range : 9kHz~1GHz

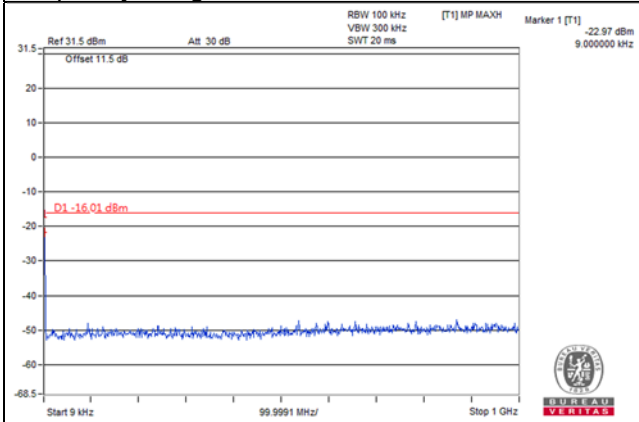

Frequency Range : 1GHz~10GHz

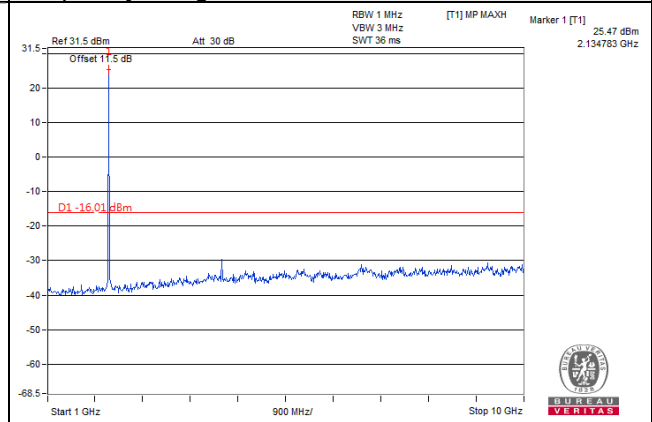

Frequency Range : 10GHz~26.5GHz

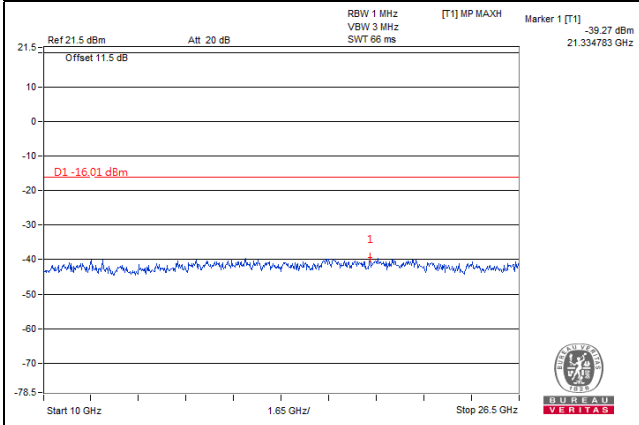

Note: For 9kHz, the signal is from spectrum analyzer.

Channel Bandwidth: 5MHz (Chain 0)

Channel 67111 (2177.5MHz)

Frequency Range : 9kHz~1GHz

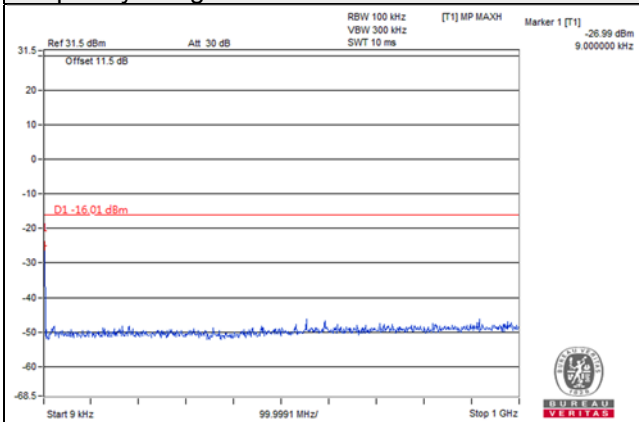

Frequency Range : 1GHz~10GHz

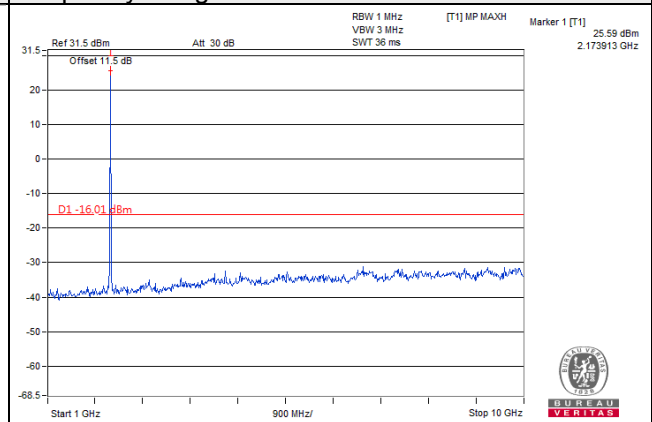

Frequency Range : 10GHz~26.5GHz

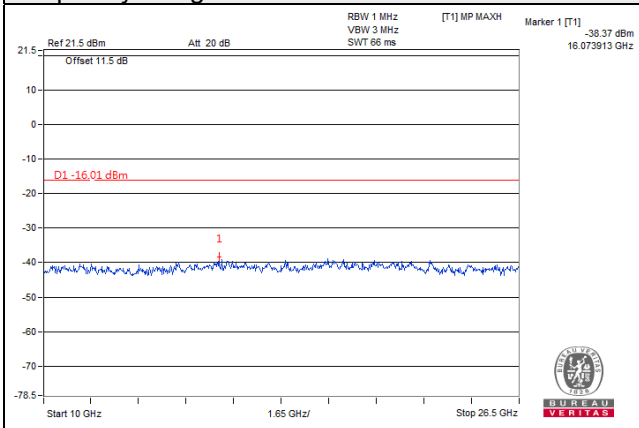

Note: For 9kHz, the signal is from spectrum analyzer.

Channel Bandwidth: 5MHz (Chain 1)

Channel 66461 (2112.5MHz)

Frequency Range : 9kHz~1GHz

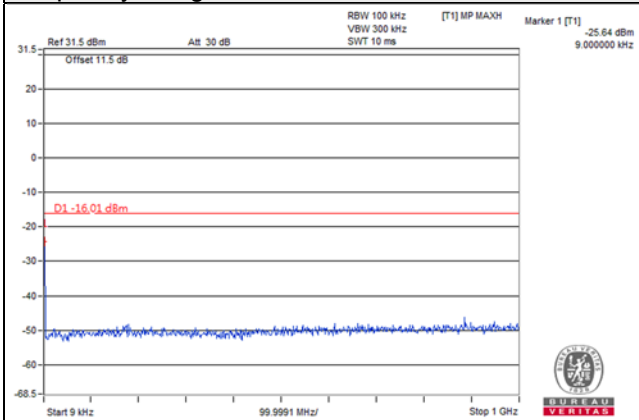

Frequency Range : 1GHz~10GHz

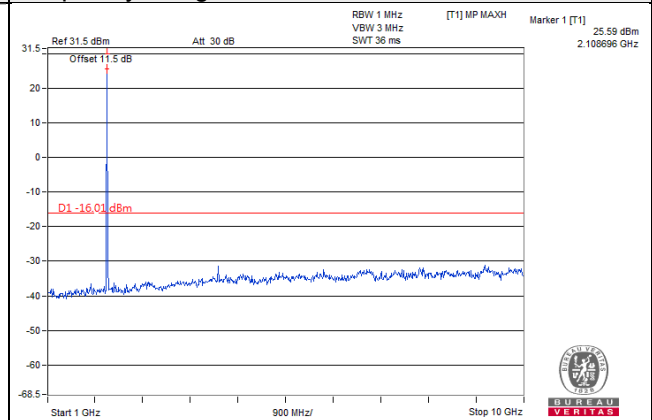

Frequency Range : 10GHz~26.5GHz

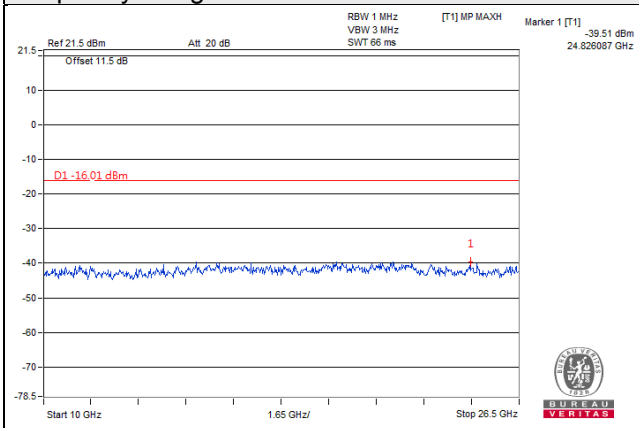

Note: For 9kHz, the signal is from spectrum analyzer.

Channel Bandwidth: 5MHz (Chain 1)

Channel 66786 (2145.0MHz)

Frequency Range : 9kHz~1GHz

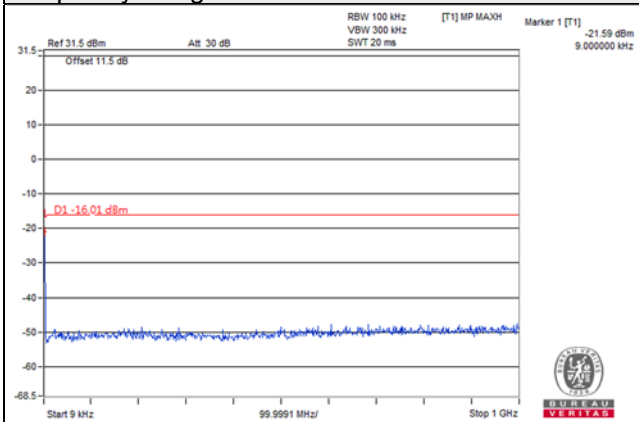

Frequency Range : 1GHz~10GHz

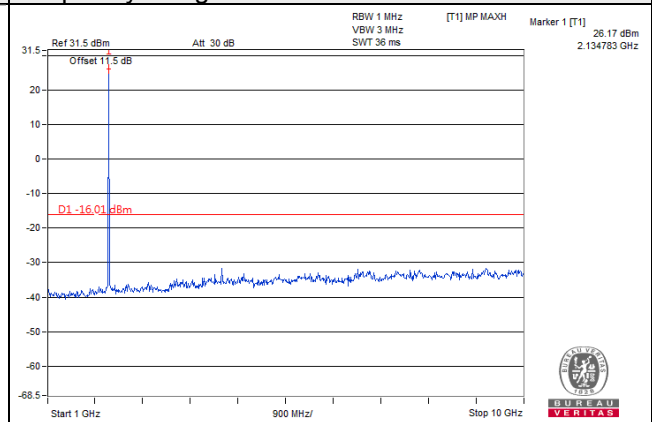

Frequency Range : 10GHz~26.5GHz

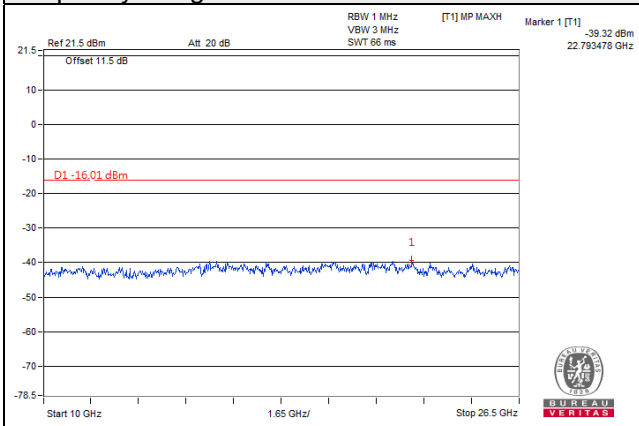

Note: For 9kHz, the signal is from spectrum analyzer.

Channel Bandwidth: 5MHz (Chain 1)

Channel 67111 (2177.5MHz)

Frequency Range : 9kHz~1GHz

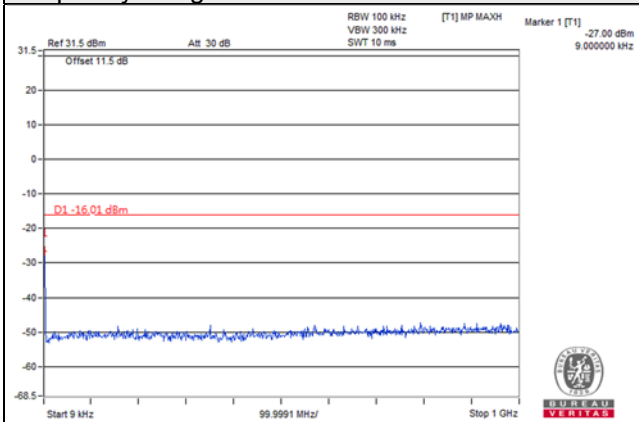

Frequency Range : 1GHz~10GHz

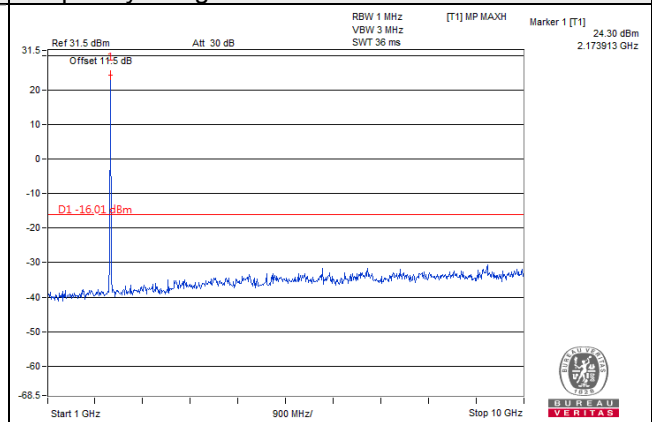

Frequency Range : 10GHz~26.5GHz

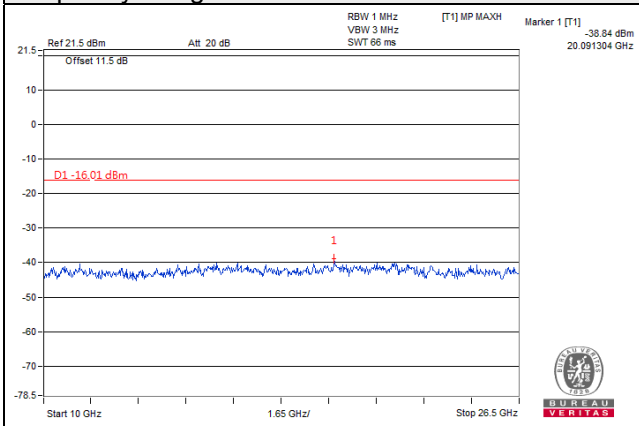

Note: For 9kHz, the signal is from spectrum analyzer.

Channel Bandwidth: 20MHz (Chain 0)

Channel 66536 (2120.0MHz)

Frequency Range : 9kHz~1GHz

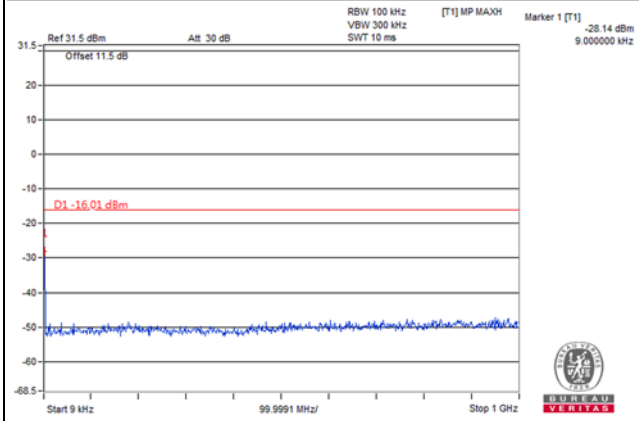

Frequency Range : 1GHz~10GHz

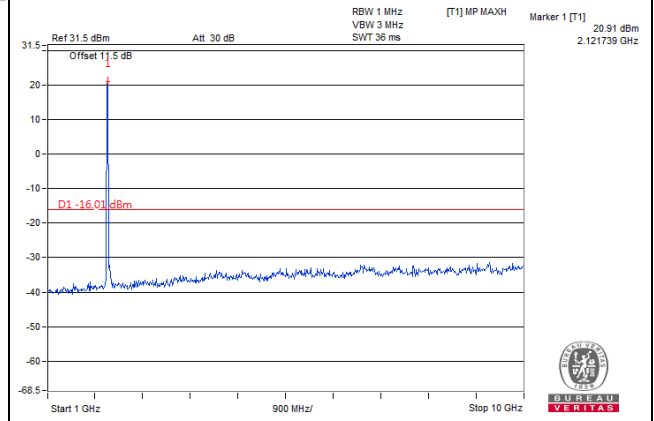

Frequency Range : 10GHz~26.5GHz

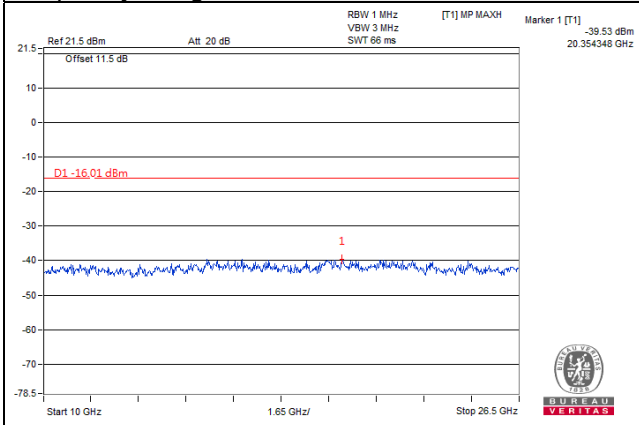

Note: For 9kHz, the signal is from spectrum analyzer.

Channel Bandwidth: 20MHz (Chain 0)

Channel 66786 (2145.0MHz)

Frequency Range : 9kHz~1GHz

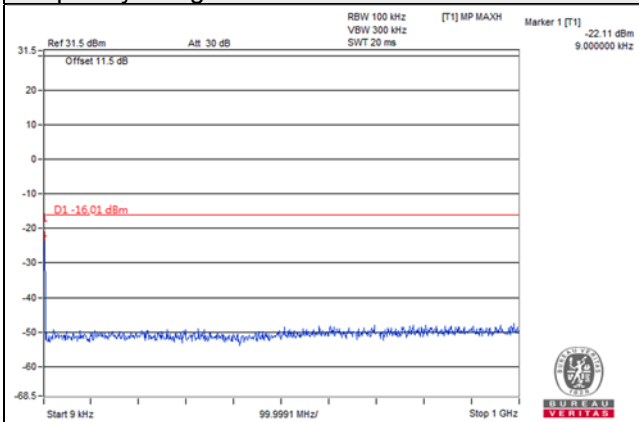

Frequency Range : 1GHz~10GHz

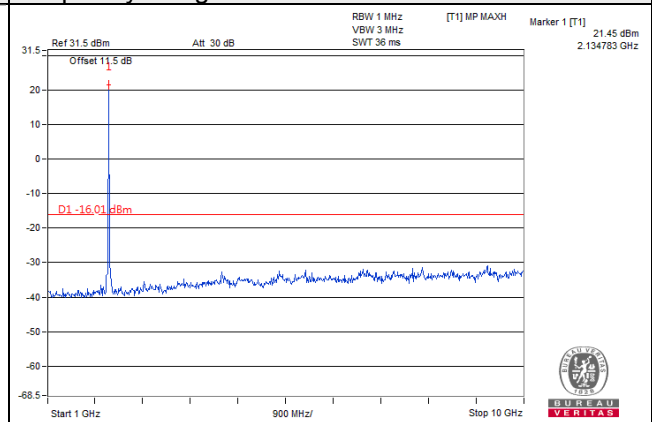

Frequency Range : 10GHz~26.5GHz

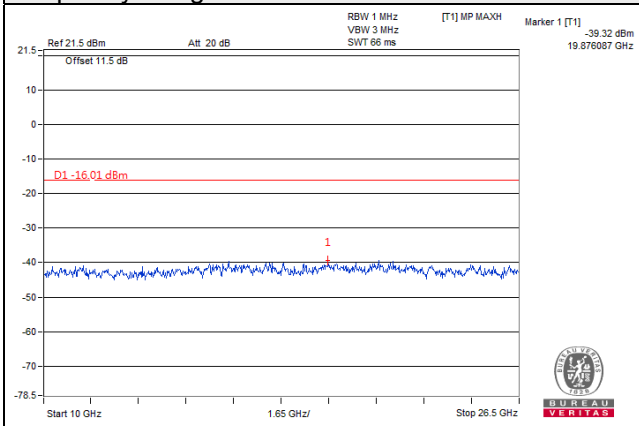

Note: For 9kHz, the signal is from spectrum analyzer.

Channel Bandwidth: 20MHz (Chain 0)

Channel 67036 (2170.0MHz)

Frequency Range : 9kHz~1GHz

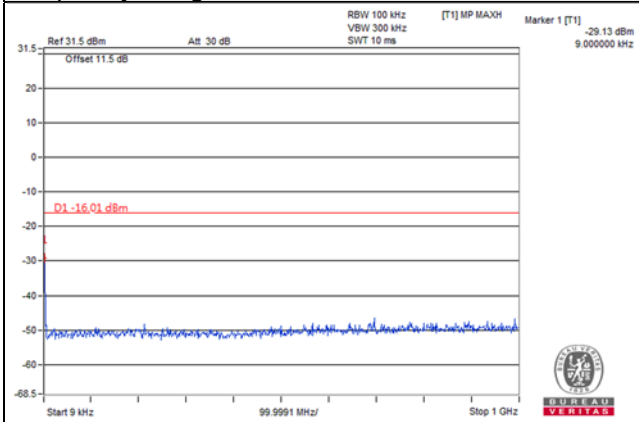

Frequency Range : 1GHz~10GHz

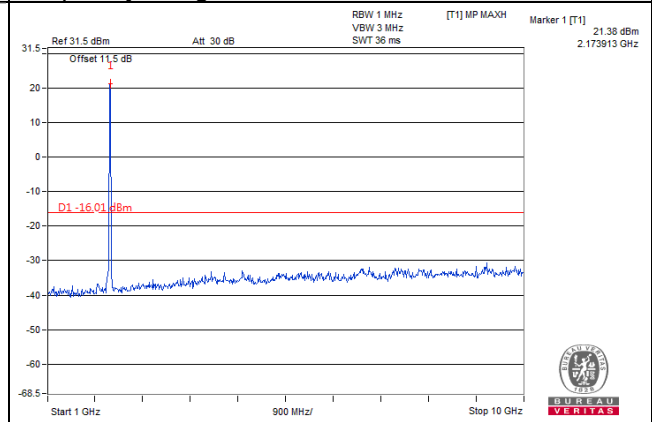

Frequency Range : 10GHz~26.5GHz

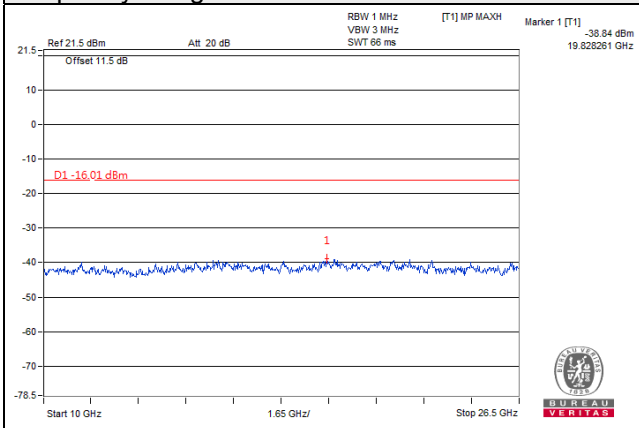

Note: For 9kHz, the signal is from spectrum analyzer.

Channel Bandwidth: 20MHz (Chain 1)

Channel 66536 (2120.0MHz)

Frequency Range : 9kHz~1GHz

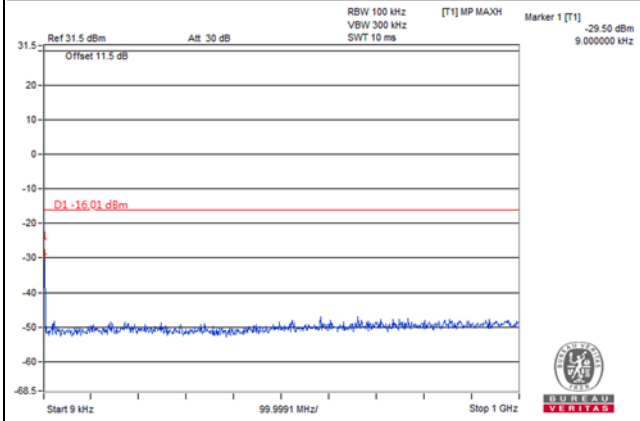

Frequency Range : 1GHz~10GHz

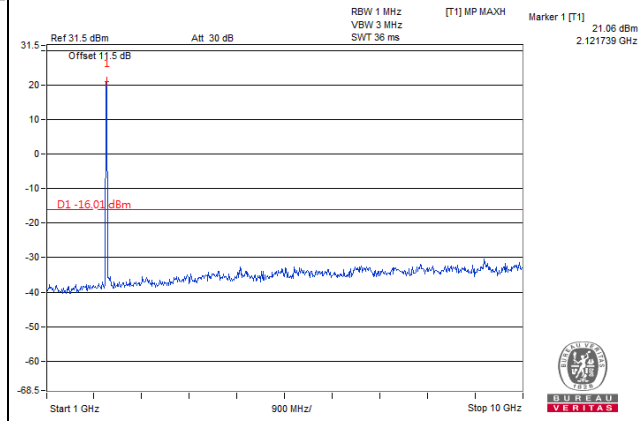

Frequency Range : 10GHz~26.5GHz

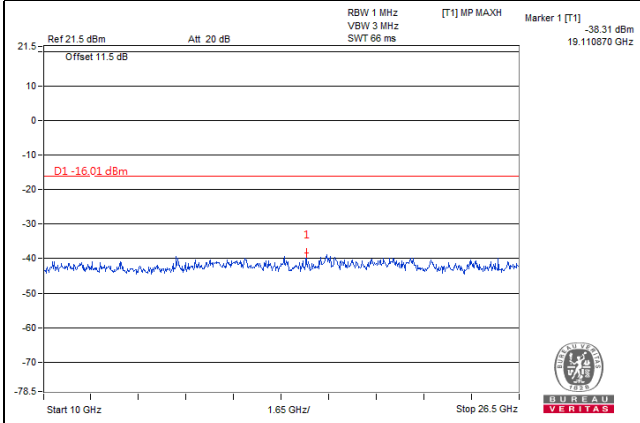

Note: For 9kHz, the signal is from spectrum analyzer.

Channel Bandwidth: 20MHz (Chain 1)

Channel 66786 (2145.0MHz)

Frequency Range : 9kHz~1GHz

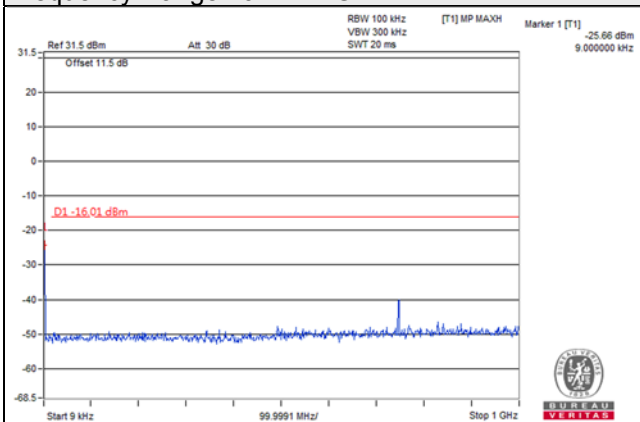

Frequency Range : 1GHz~10GHz

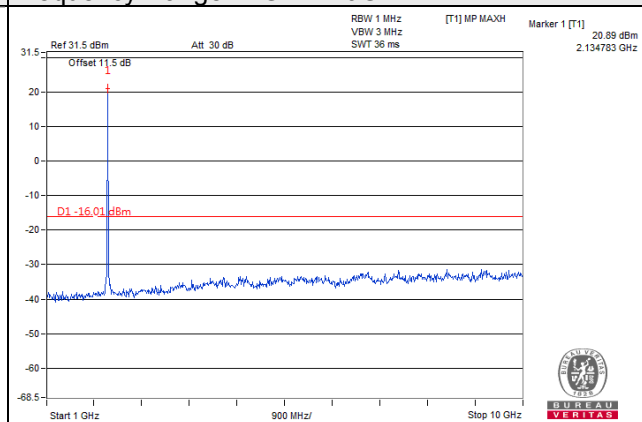

Frequency Range : 10GHz~26.5GHz

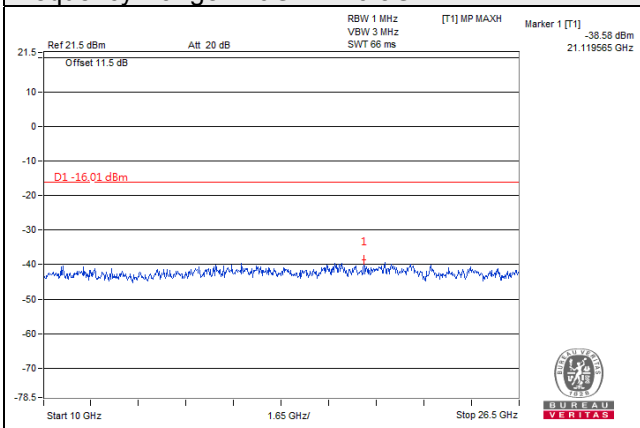

Note: For 9kHz, the signal is from spectrum analyzer.

Channel Bandwidth: 20MHz (Chain 1)

Channel 67036 (2170.0MHz)

Frequency Range : 9kHz~1GHz

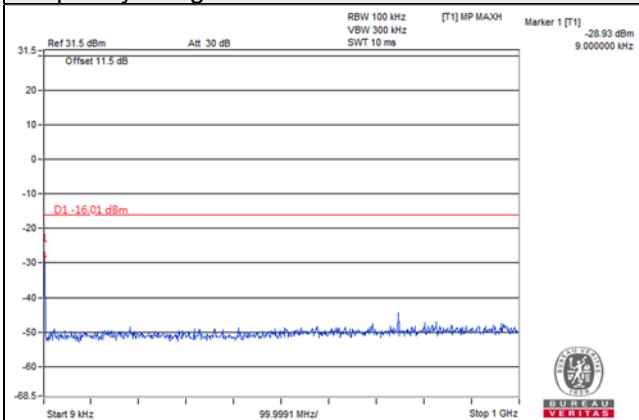

Frequency Range : 1GHz~10GHz

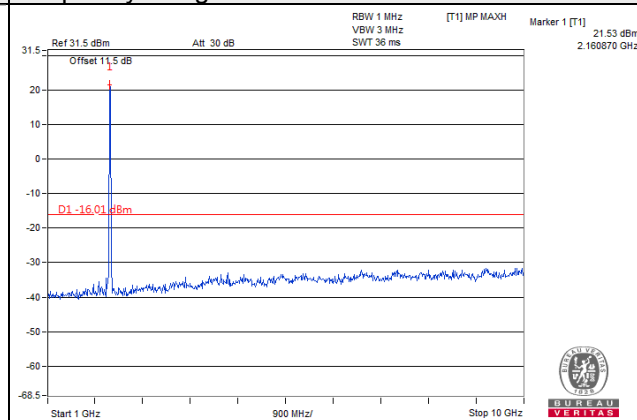

Frequency Range : 10GHz~26.5GHz

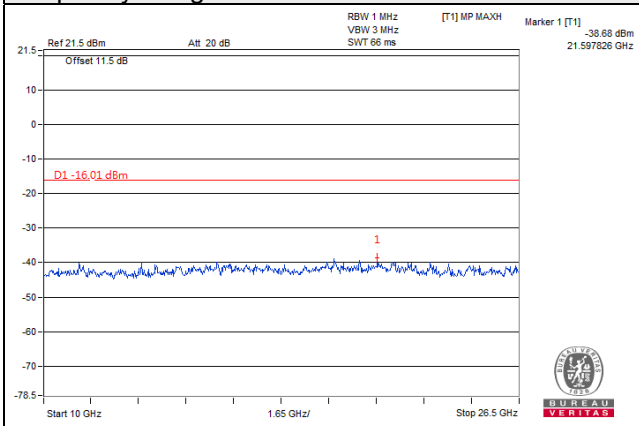

Note: For 9kHz, the signal is from spectrum analyzer.

**For NB-IoT Guard Band:
QPSK_IoT Signal at Bottom:**

Channel Bandwidth: 10MHz (Chain 0)

Channel 66486 (2115.0MHz)

Frequency Range : 9kHz~1GHz

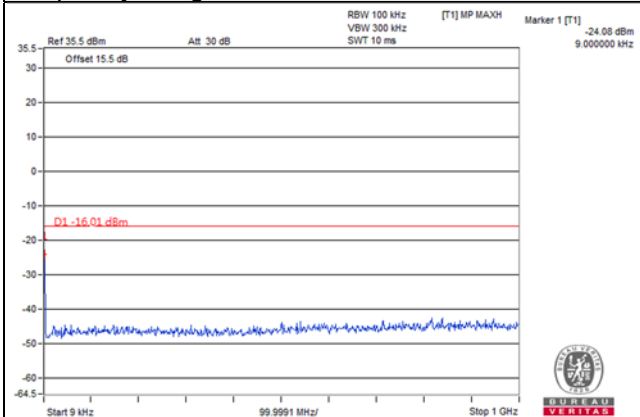

Frequency Range : 1GHz~10GHz

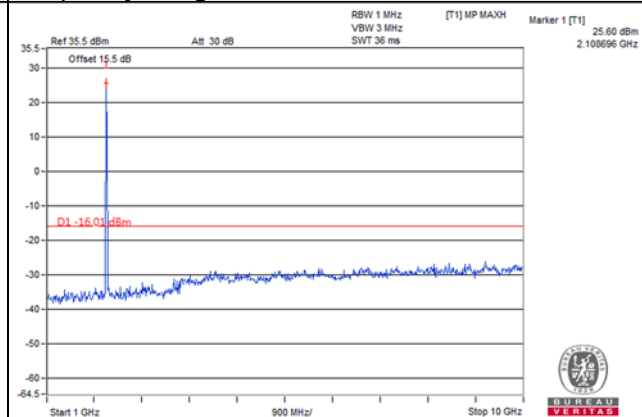

Frequency Range : 10GHz~26.5GHz

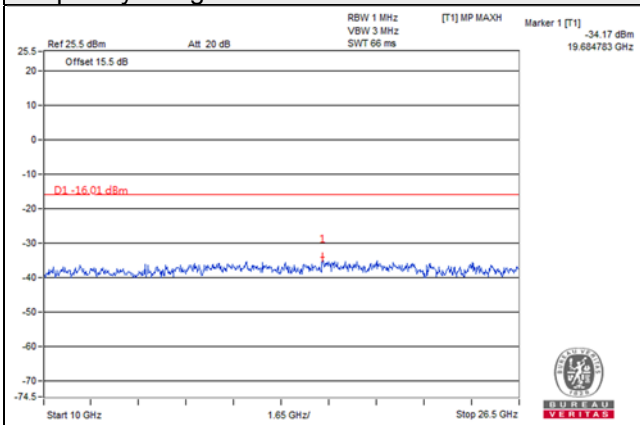

Note: For 9kHz, the signal is from spectrum analyzer.

Channel Bandwidth: 10MHz (Chain 0)

Channel 66786 (2145.0MHz)

Frequency Range : 9kHz~1GHz

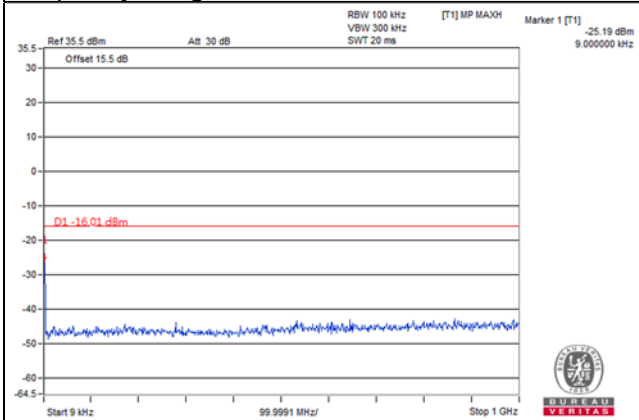

Frequency Range : 1GHz~10GHz

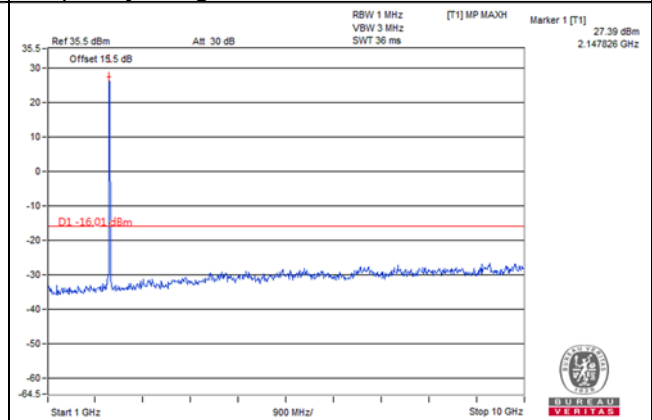

Frequency Range : 10GHz~26.5GHz

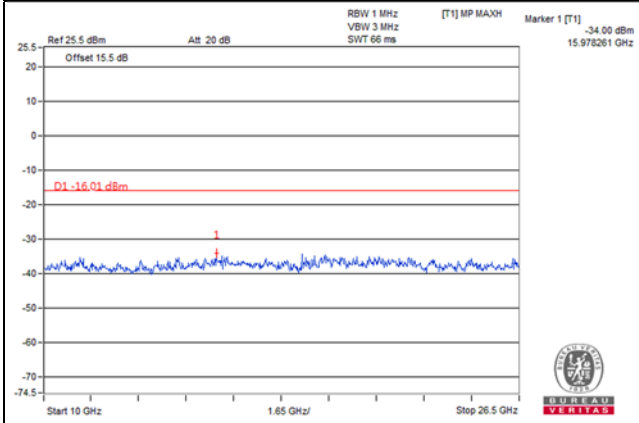

Note: For 9kHz, the signal is from spectrum analyzer.

Channel Bandwidth: 10MHz (Chain 0)

Channel 67086 (2175.0MHz)

Frequency Range : 9kHz~1GHz

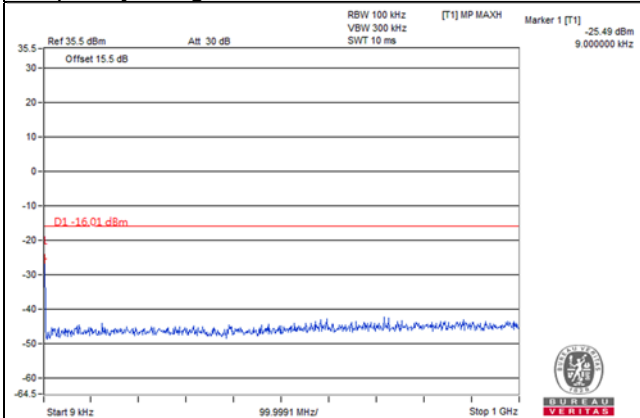

Frequency Range : 1GHz~10GHz

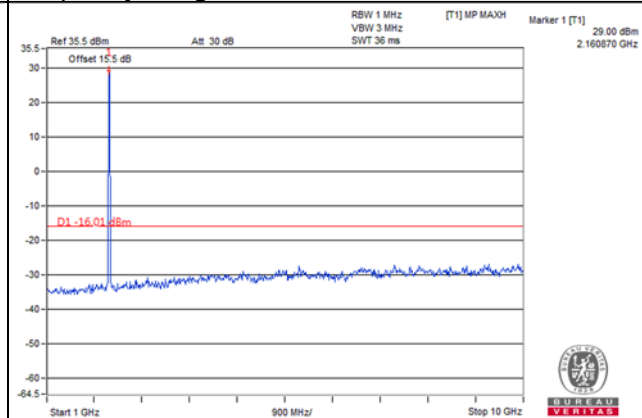

Frequency Range : 10GHz~26.5GHz

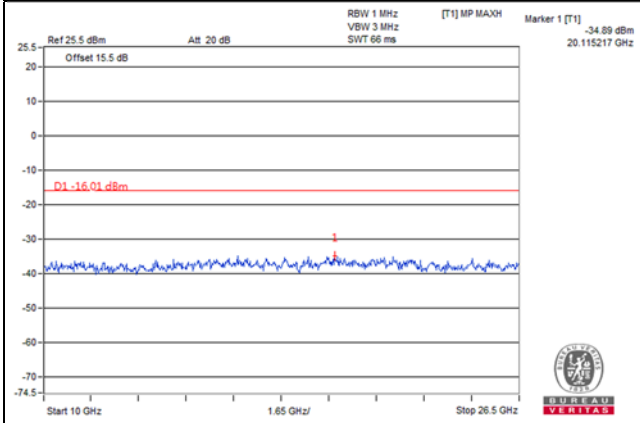

Note: For 9kHz, the signal is from spectrum analyzer.

Channel Bandwidth: 10MHz (Chain 1)

Channel 66486 (2115.0MHz)

Frequency Range : 9kHz~1GHz

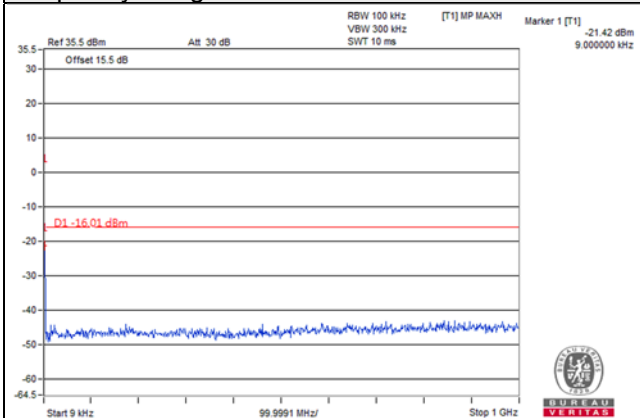

Frequency Range : 1GHz~10GHz

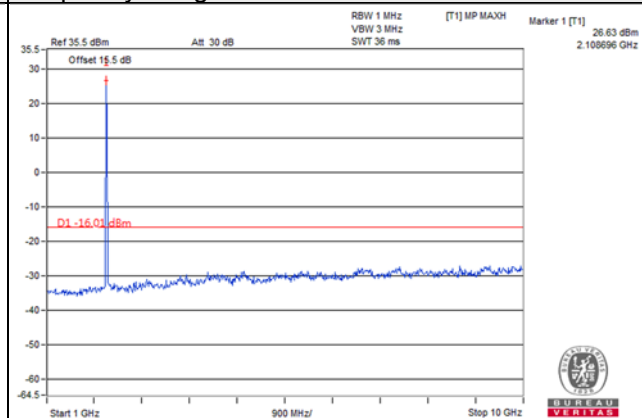

Frequency Range : 10GHz~26.5GHz

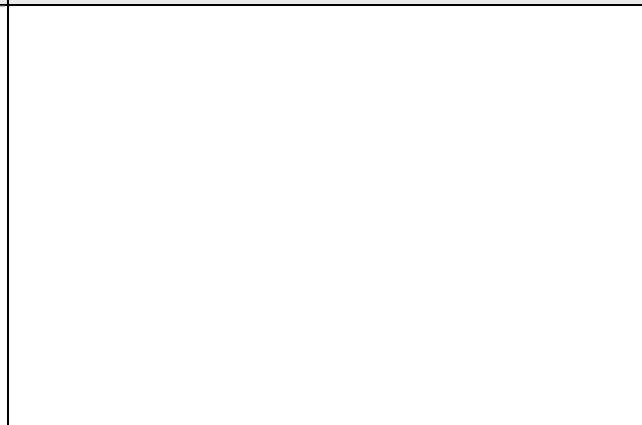
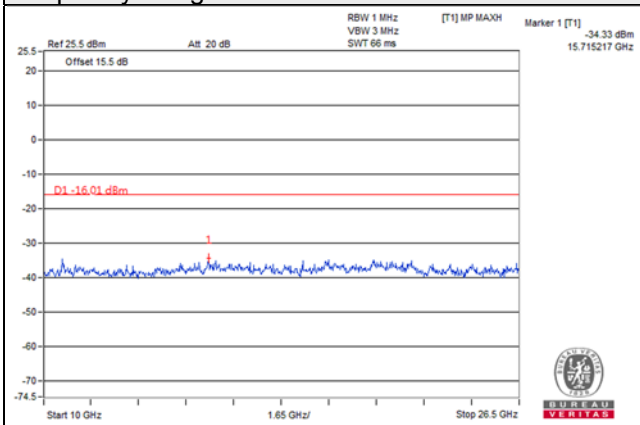

Note: For 9kHz, the signal is from spectrum analyzer.

Channel Bandwidth: 10MHz (Chain 1)

Channel 66786 (2145.0MHz)

Frequency Range : 9kHz~1GHz

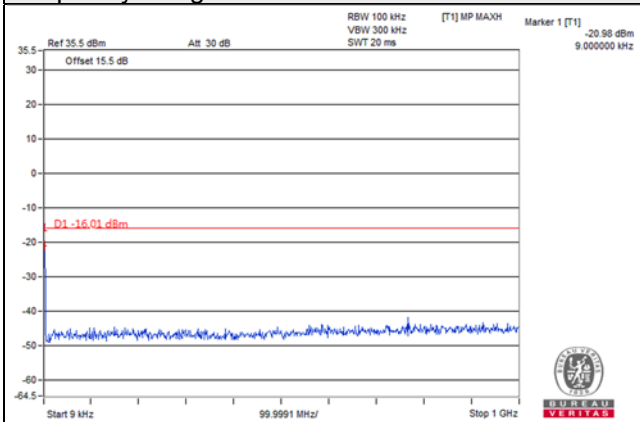

Frequency Range : 1GHz~10GHz

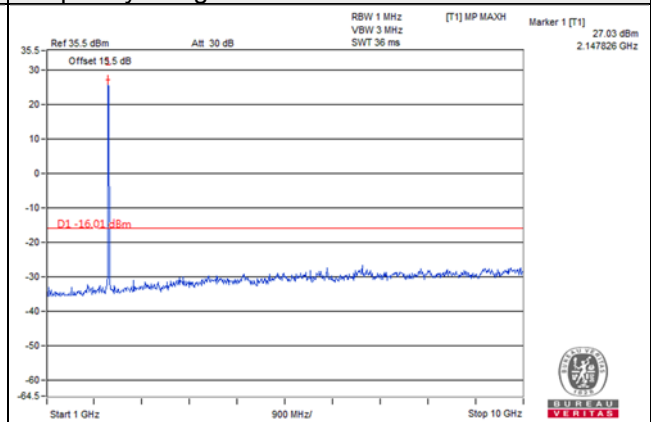

Frequency Range : 10GHz~26.5GHz

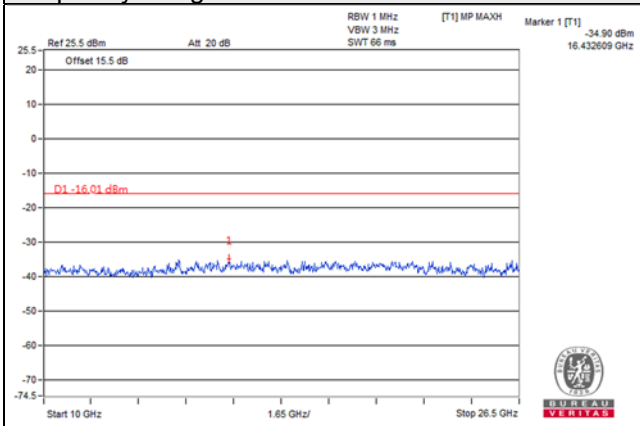

Note: For 9kHz, the signal is from spectrum analyzer.

Channel Bandwidth: 10MHz (Chain 1)

Channel 67086 (2175.0MHz)

Frequency Range : 9kHz~1GHz

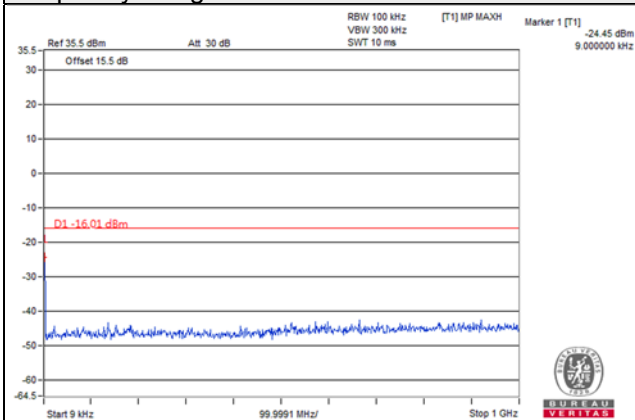

Frequency Range : 1GHz~10GHz

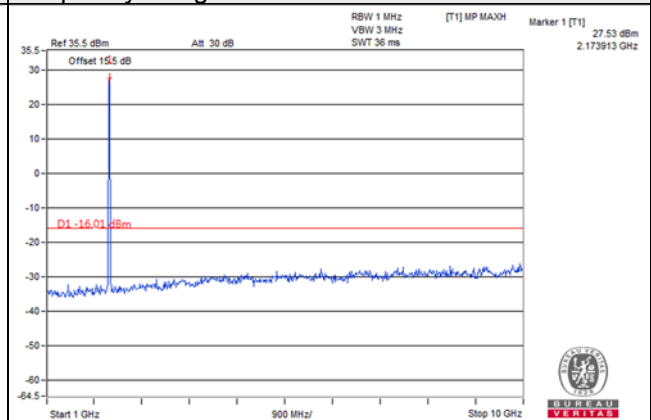

Frequency Range : 10GHz~26.5GHz

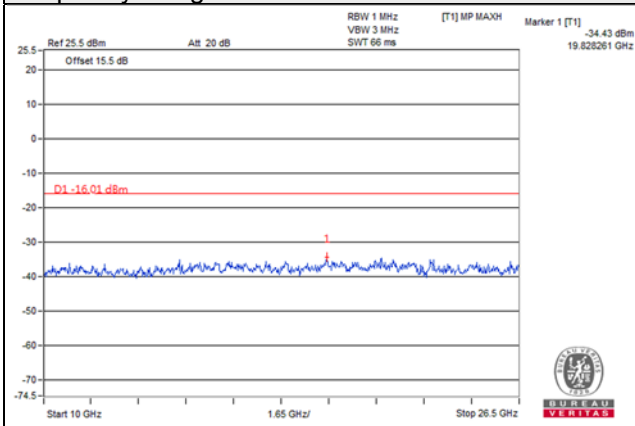

Note: For 9kHz, the signal is from spectrum analyzer.

Channel Bandwidth: 15MHz (Chain 0)

Channel 66511 (2117.5MHz)

Frequency Range : 9kHz~1GHz

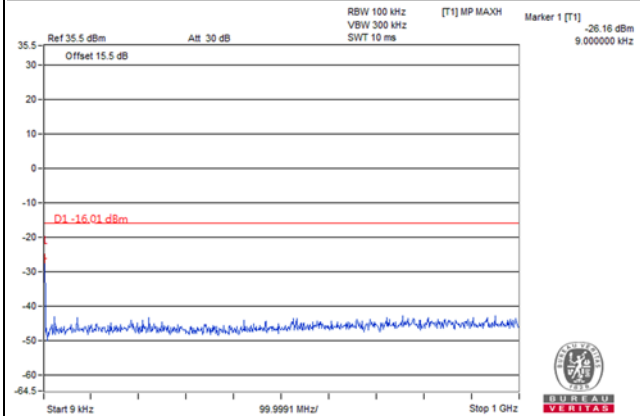

Frequency Range : 1GHz~10GHz

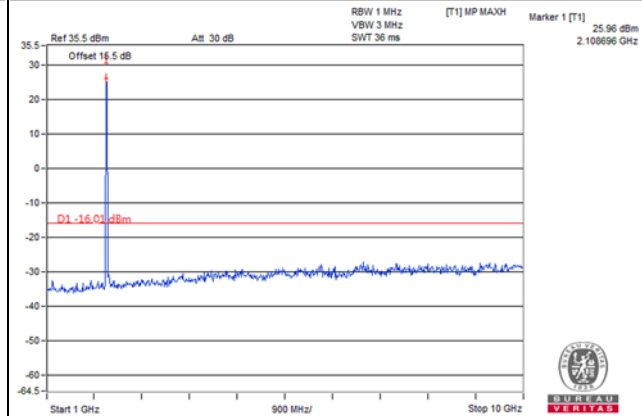

Frequency Range : 10GHz~26.5GHz

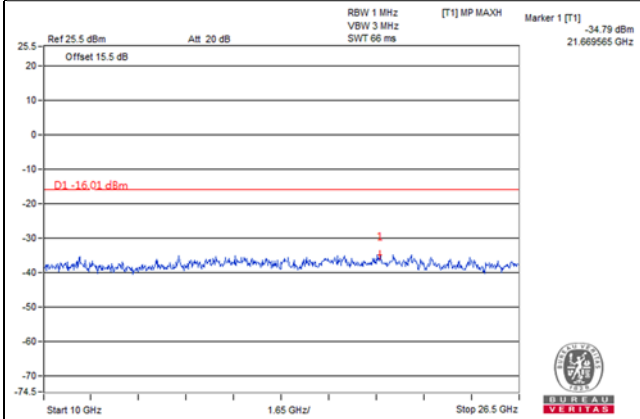

Note: For 9kHz, the signal is from spectrum analyzer.

Channel Bandwidth: 15MHz (Chain 0)

Channel 66786 (2145.0MHz)

Frequency Range : 9kHz~1GHz

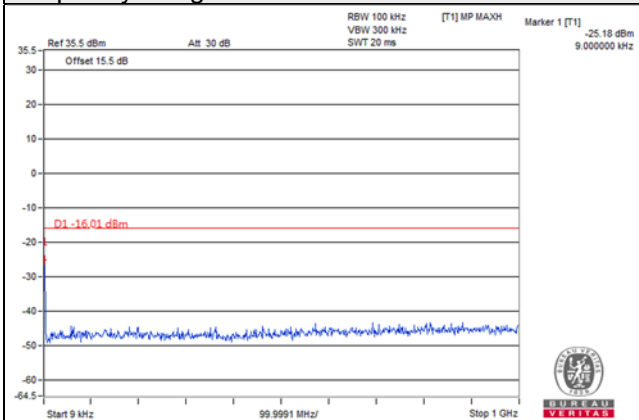

Frequency Range : 1GHz~10GHz

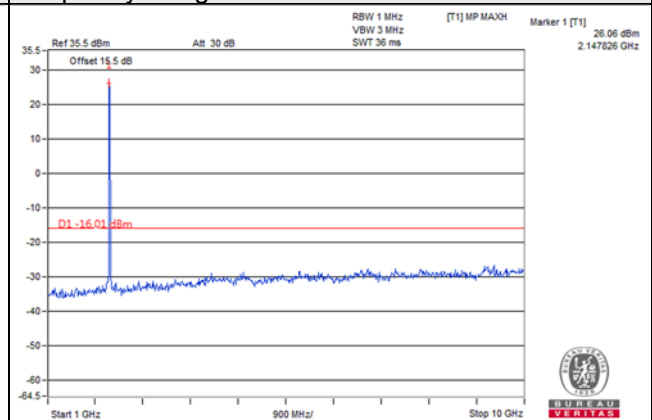

Frequency Range : 10GHz~26.5GHz

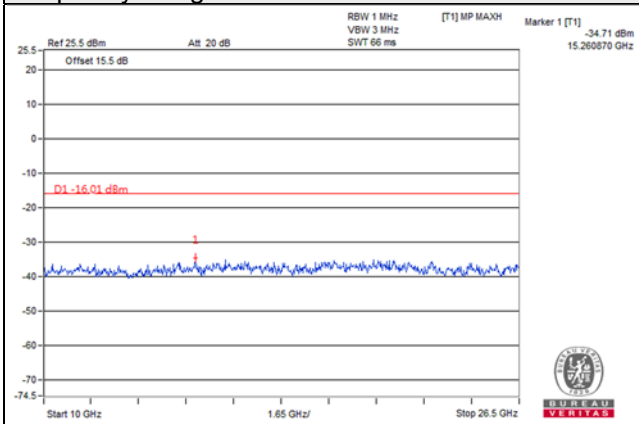

Note: For 9kHz, the signal is from spectrum analyzer.

Channel Bandwidth: 15MHz (Chain 0)

Channel 67061 (2172.5MHz)

Frequency Range : 9kHz~1GHz

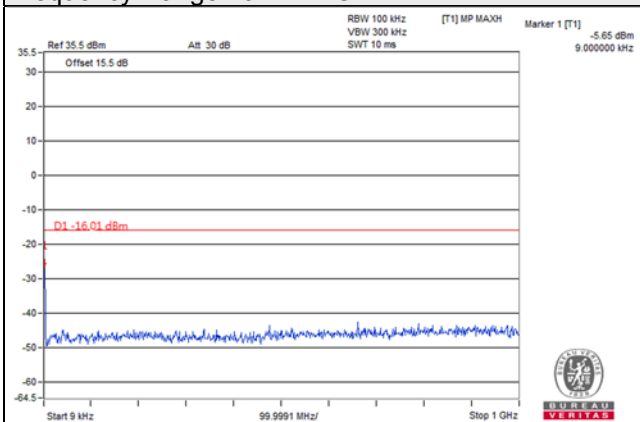

Frequency Range : 1GHz~10GHz

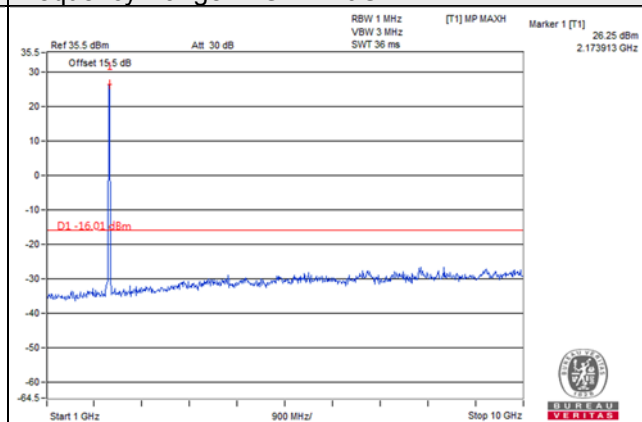

Frequency Range : 10GHz~26.5GHz

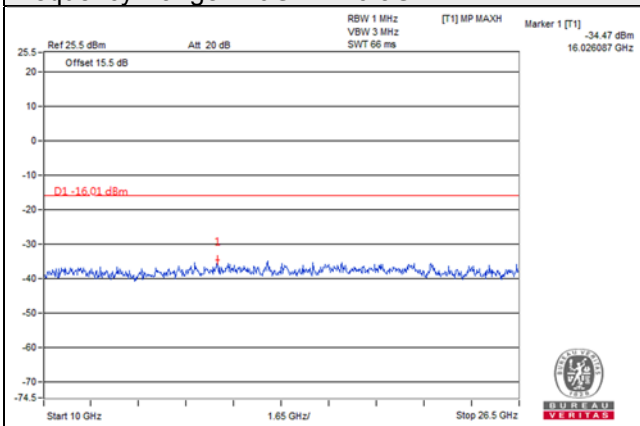

Note: For 9kHz, the signal is from spectrum analyzer.

Channel Bandwidth: 15MHz (Chain 1)

Channel 66511 (2117.5MHz)

Frequency Range : 9kHz~1GHz

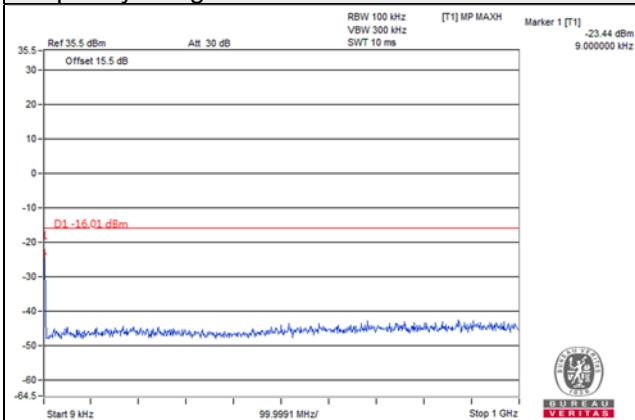

Frequency Range : 1GHz~10GHz

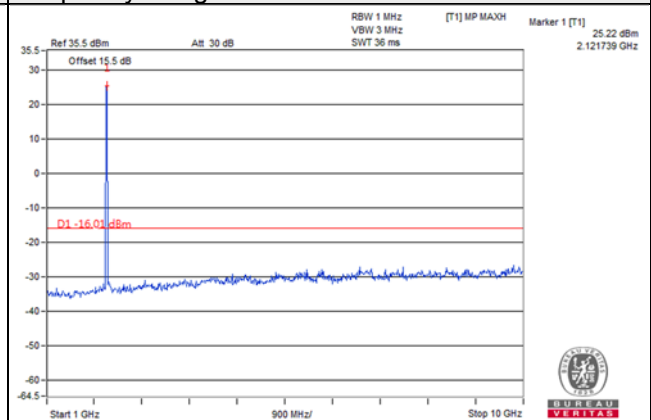

Frequency Range : 10GHz~26.5GHz

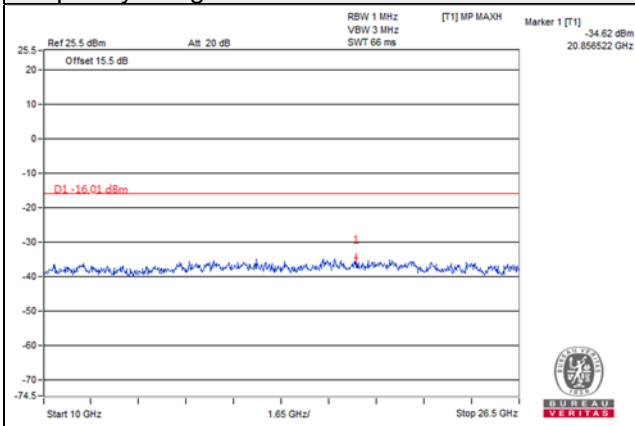

Note: For 9kHz, the signal is from spectrum analyzer.

Channel Bandwidth: 15MHz (Chain 1)

Channel 66786 (2145.0MHz)

Frequency Range : 9kHz~1GHz

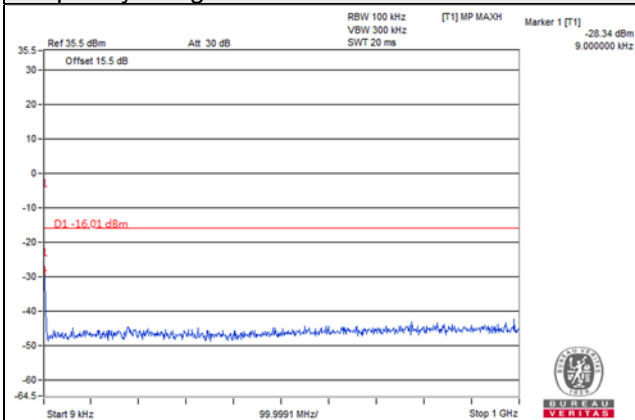

Frequency Range : 1GHz~10GHz

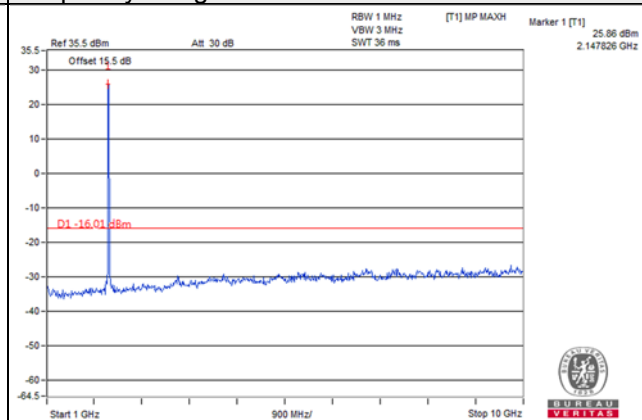

Frequency Range : 10GHz~26.5GHz

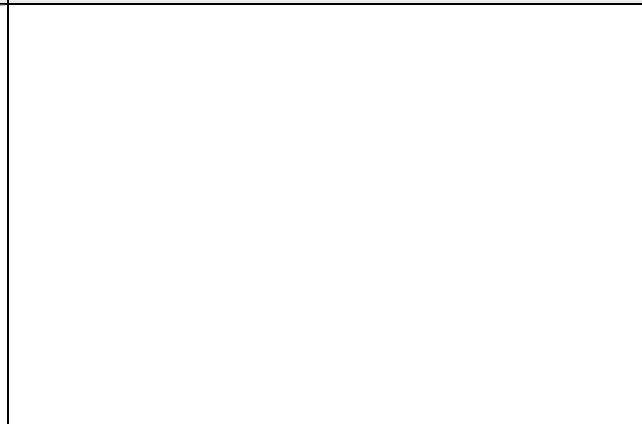
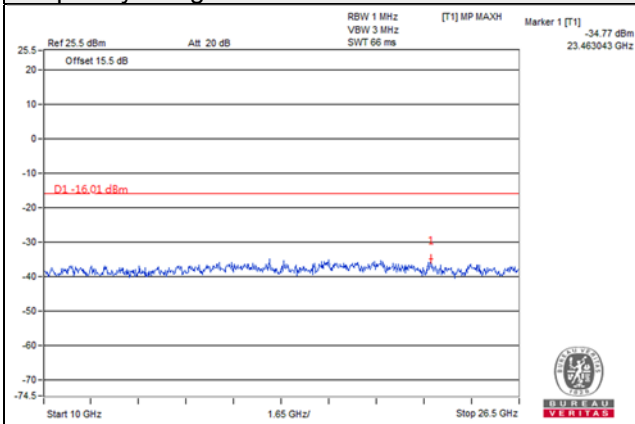

Note: For 9kHz, the signal is from spectrum analyzer.

Channel Bandwidth: 15MHz (Chain 1)

Channel 67061 (2172.5MHz)

Frequency Range : 9kHz~1GHz

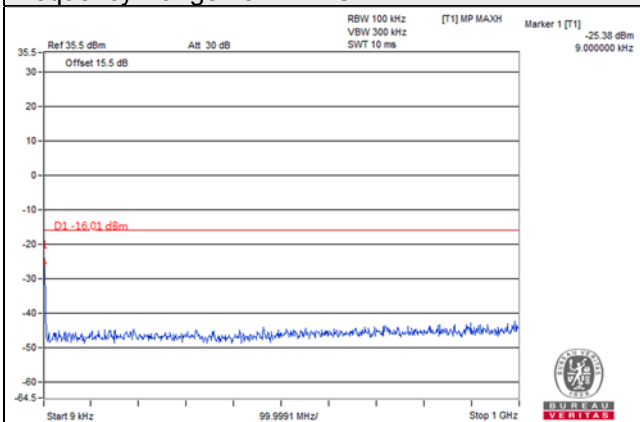

Frequency Range : 1GHz~10GHz

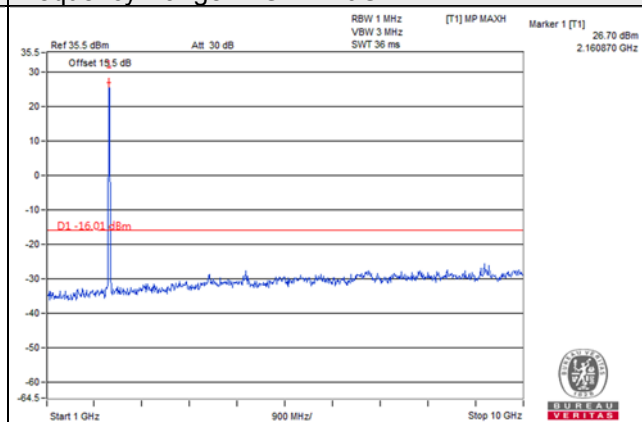

Frequency Range : 10GHz~26.5GHz

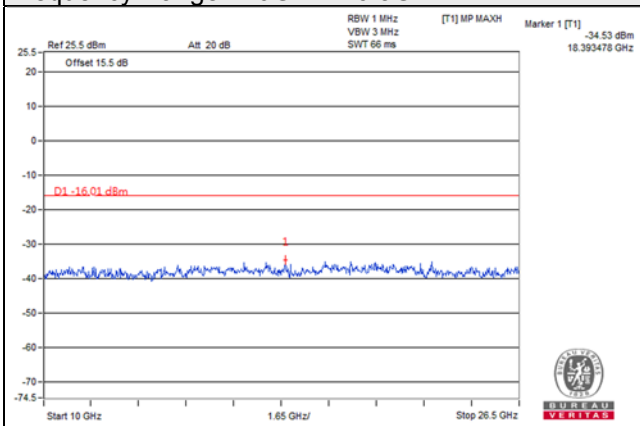

Note: For 9kHz, the signal is from spectrum analyzer.

Channel Bandwidth: 20MHz (Chain 0)

Channel 66536 (2120.0MHz)

Frequency Range : 9kHz~1GHz

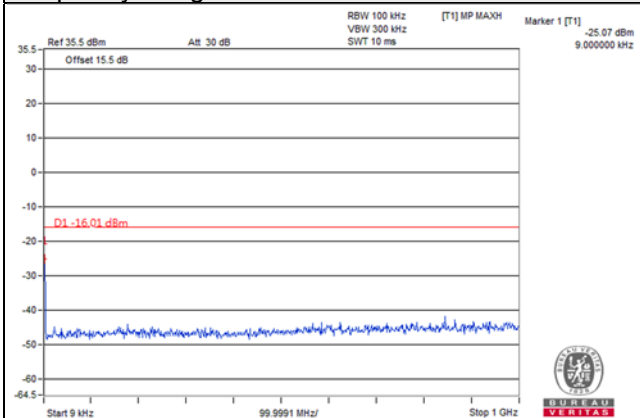

Frequency Range : 1GHz~10GHz

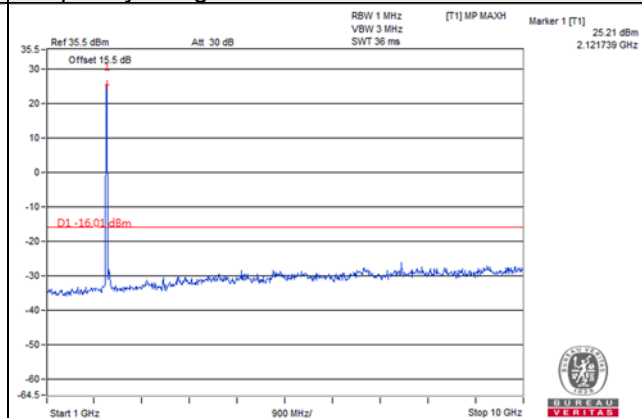

Frequency Range : 10GHz~26.5GHz

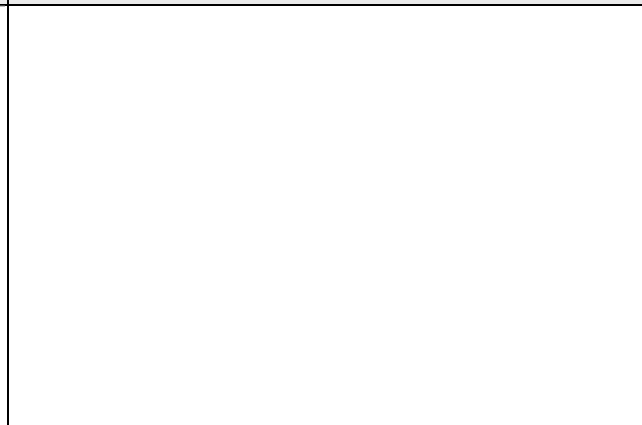
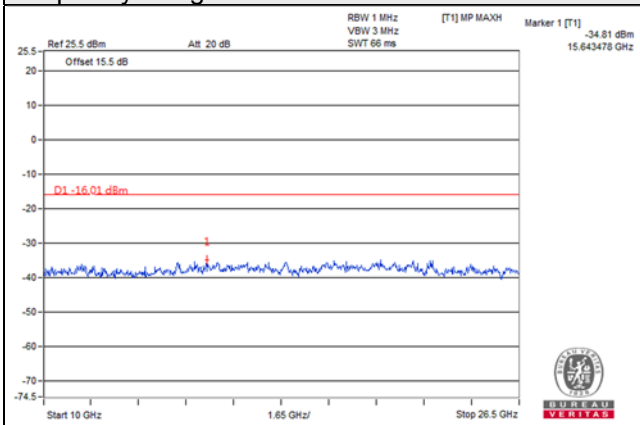

Note: For 9kHz, the signal is from spectrum analyzer.

Channel Bandwidth: 20MHz (Chain 0)

Channel 66786 (2145.0MHz)

Frequency Range : 9kHz~1GHz

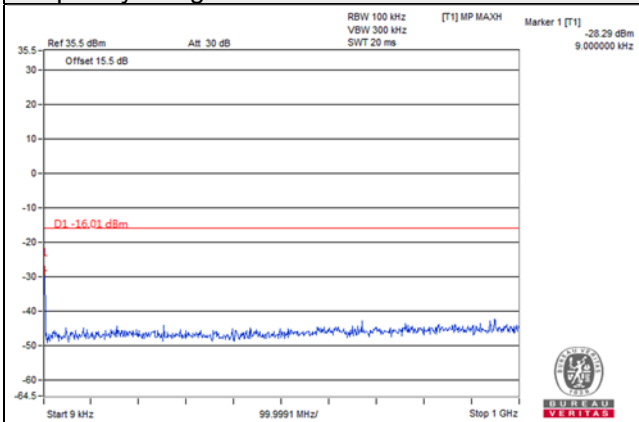

Frequency Range : 1GHz~10GHz

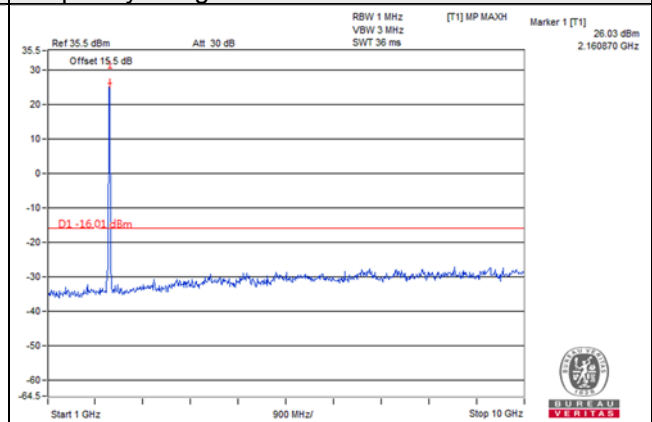

Frequency Range : 10GHz~26.5GHz

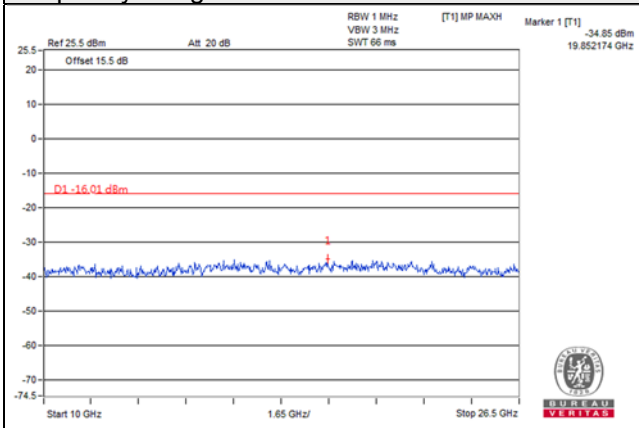

Note: For 9kHz, the signal is from spectrum analyzer.

Channel Bandwidth: 20MHz (Chain 0)

Channel 67036 (2170.0MHz)

Frequency Range : 9kHz~1GHz

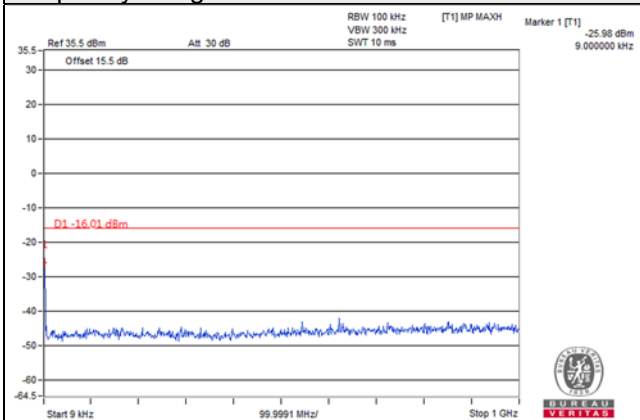

Frequency Range : 1GHz~10GHz

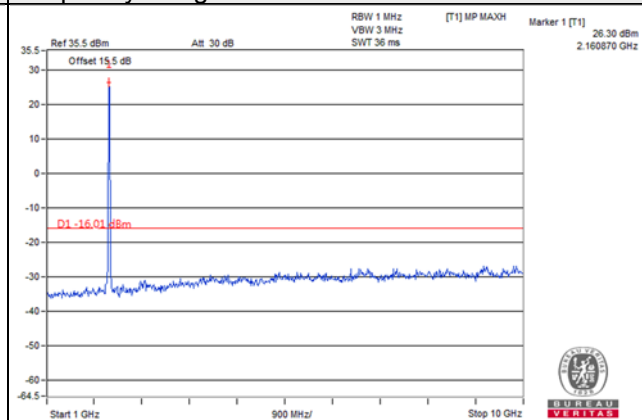

Frequency Range : 10GHz~26.5GHz

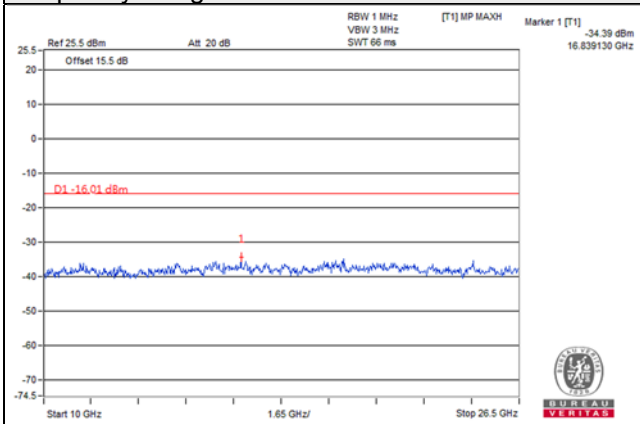

Note: For 9kHz, the signal is from spectrum analyzer.

Channel Bandwidth: 20MHz (Chain 1)

Channel 66536 (2120.0MHz)

Frequency Range : 9kHz~1GHz

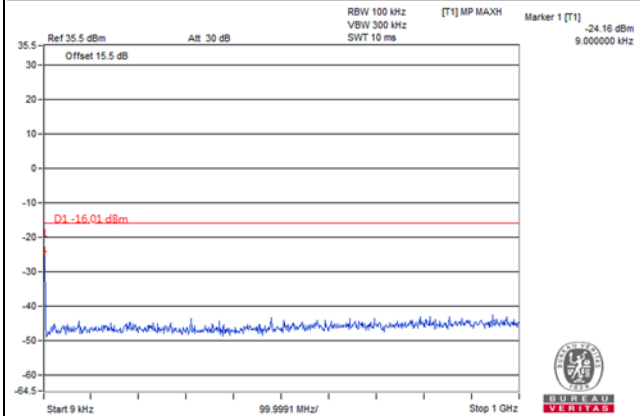

Frequency Range : 1GHz~10GHz

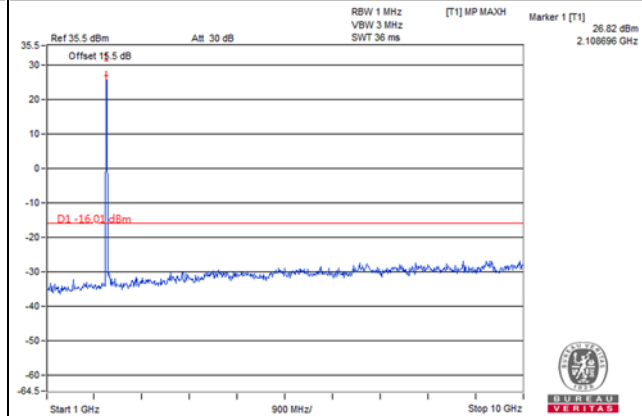

Frequency Range : 10GHz~26.5GHz

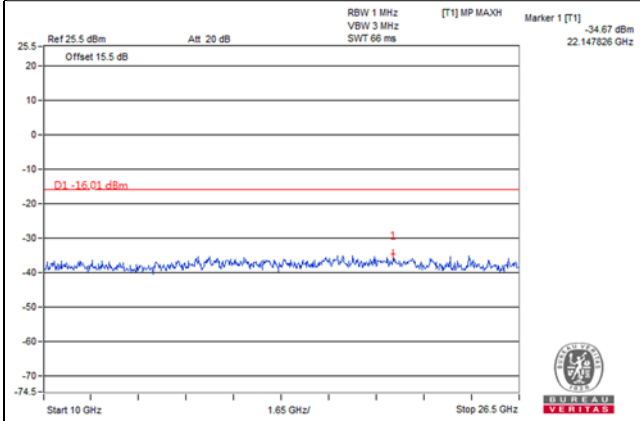

Note: For 9kHz, the signal is from spectrum analyzer.

Channel Bandwidth: 20MHz (Chain 1)

Channel 66786 (2145.0MHz)

Frequency Range : 9kHz~1GHz

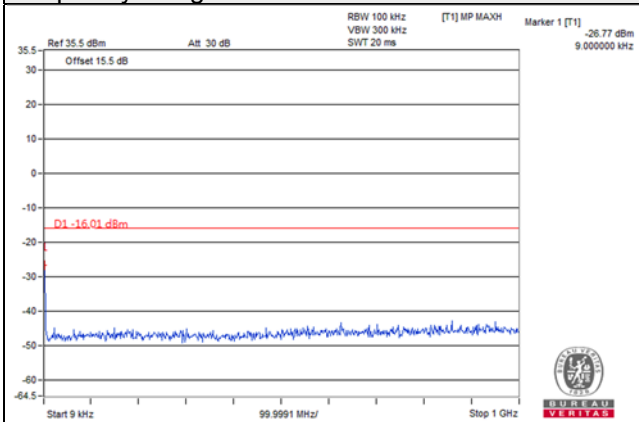

Frequency Range : 1GHz~10GHz

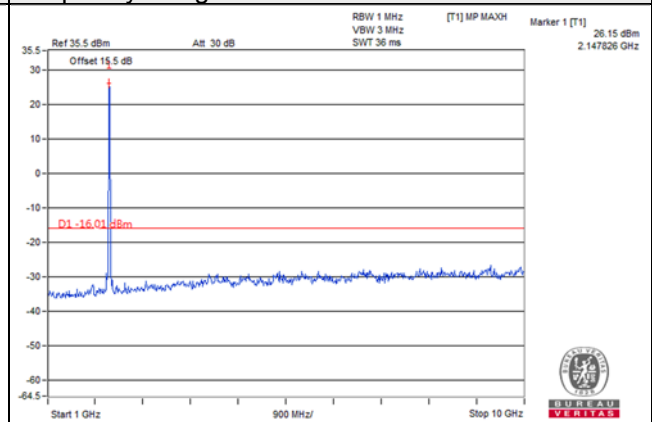

Frequency Range : 10GHz~26.5GHz

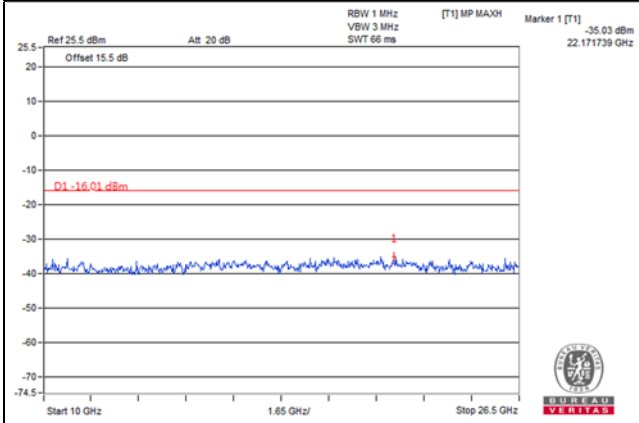

Note: For 9kHz, the signal is from spectrum analyzer.

Channel Bandwidth: 20MHz (Chain 1)

Channel 67036 (2170.0MHz)

Frequency Range : 9kHz~1GHz

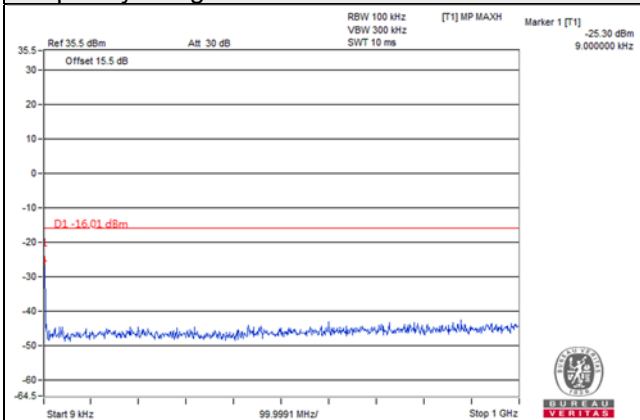

Frequency Range : 1GHz~10GHz

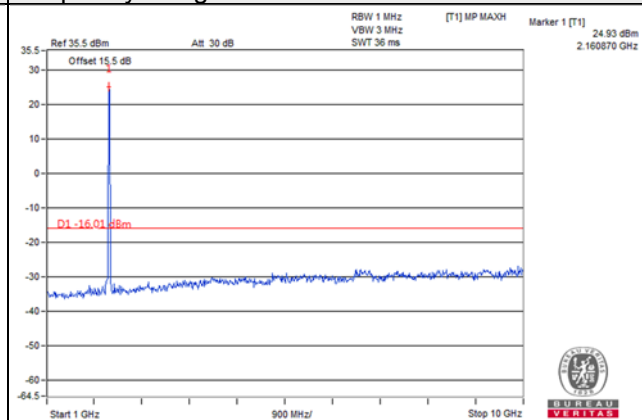

Frequency Range : 10GHz~26.5GHz

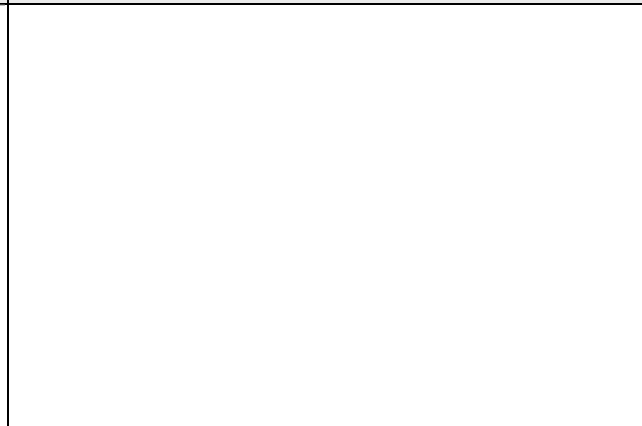
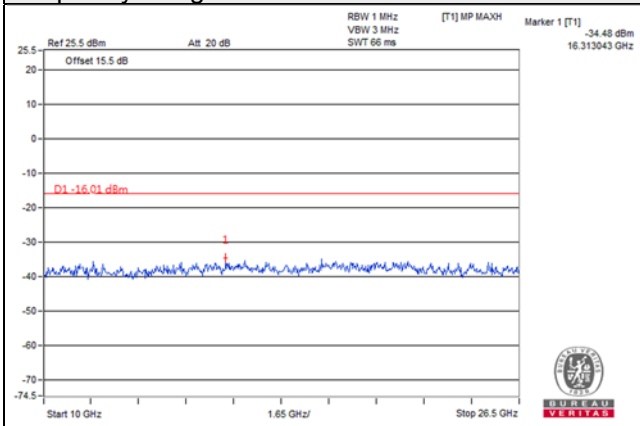

Note: For 9kHz, the signal is from spectrum analyzer.

QPSK_IoT Signal at Top:

Channel Bandwidth: 10MHz (Chain 0)

Channel 66486 (2115.0MHz)

Frequency Range : 9kHz~1GHz

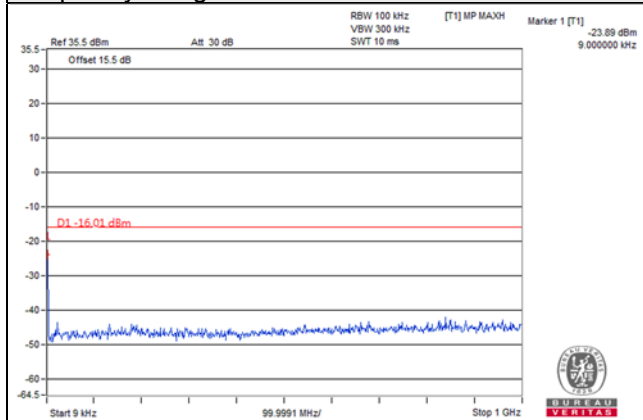

Frequency Range : 1GHz~10GHz

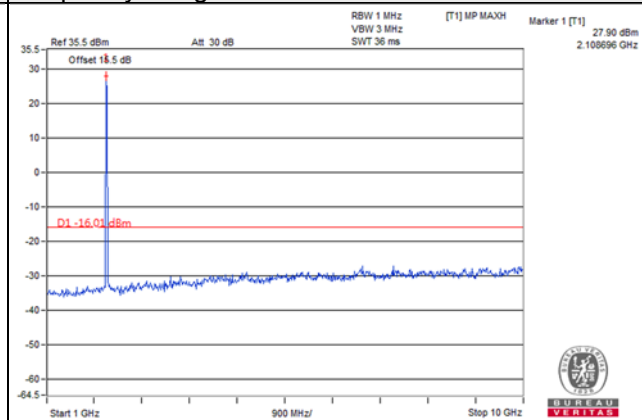

Frequency Range : 10GHz~26.5GHz

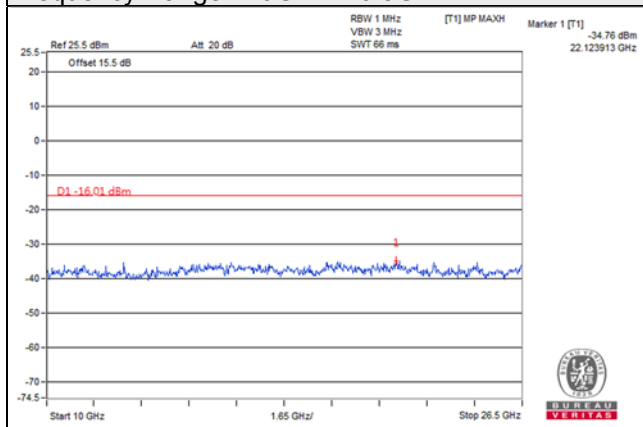

Note: For 9kHz, the signal is from spectrum analyzer.

Channel Bandwidth: 10MHz (Chain 0)

Channel 66786 (2145.0MHz)

Frequency Range : 9kHz~1GHz

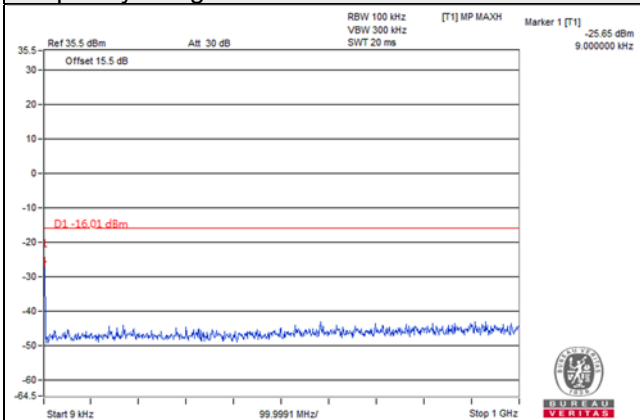

Frequency Range : 1GHz~10GHz

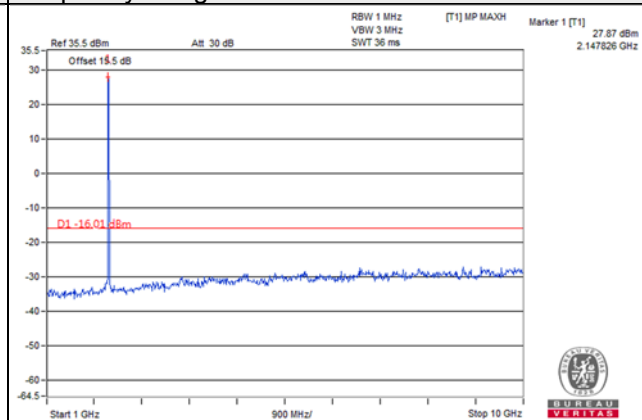

Frequency Range : 10GHz~26.5GHz

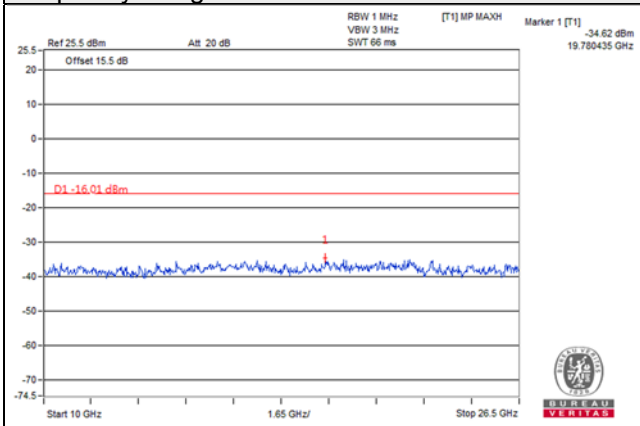

Note: For 9kHz, the signal is from spectrum analyzer.

Channel Bandwidth: 10MHz (Chain 0)

Channel 67086 (2175.0MHz)

Frequency Range : 9kHz~1GHz

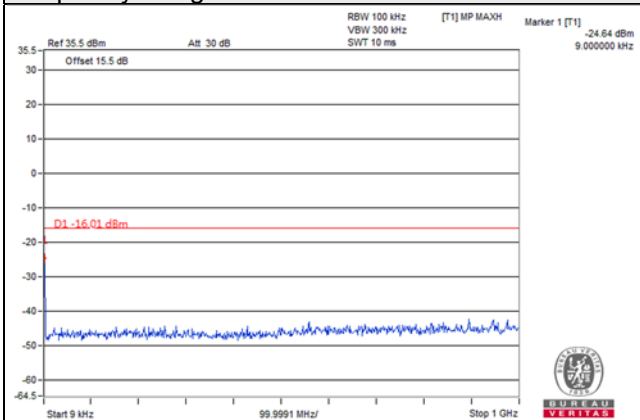

Frequency Range : 1GHz~10GHz

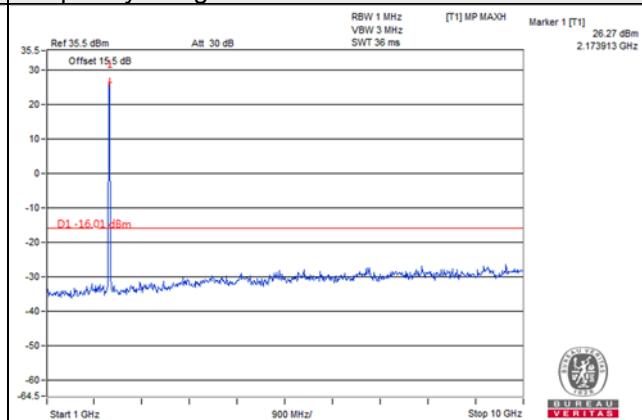

Frequency Range : 10GHz~26.5GHz

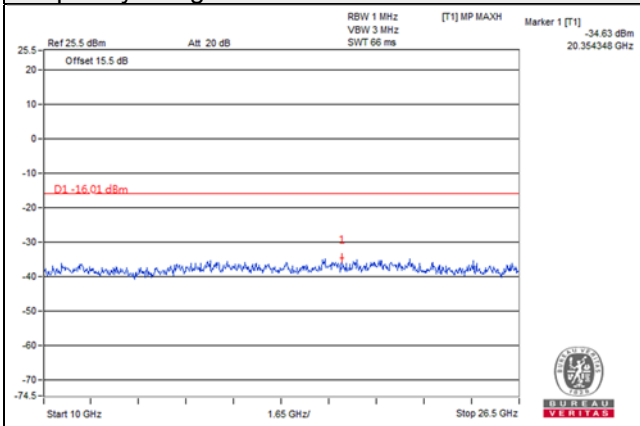

Note: For 9kHz, the signal is from spectrum analyzer.

Channel Bandwidth: 10MHz (Chain 1)

Channel 66486 (2115.0MHz)

Frequency Range : 9kHz~1GHz

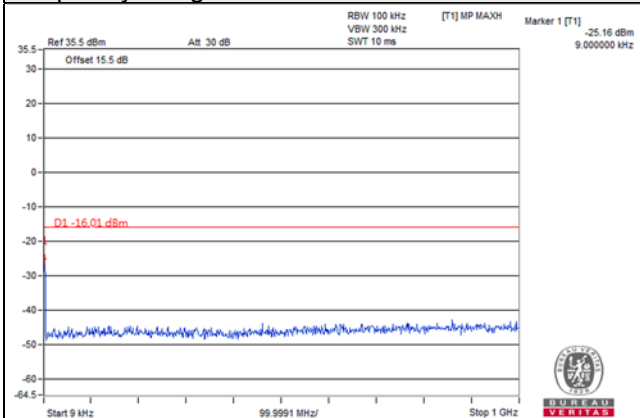

Frequency Range : 1GHz~10GHz

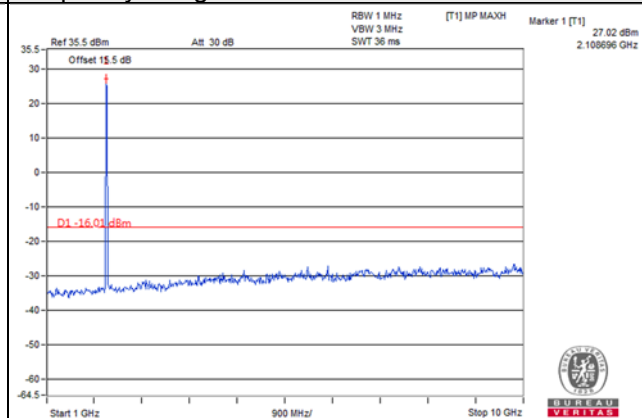

Frequency Range : 10GHz~26.5GHz

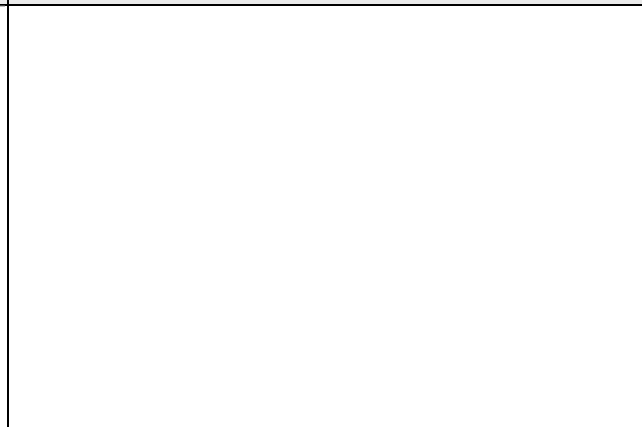
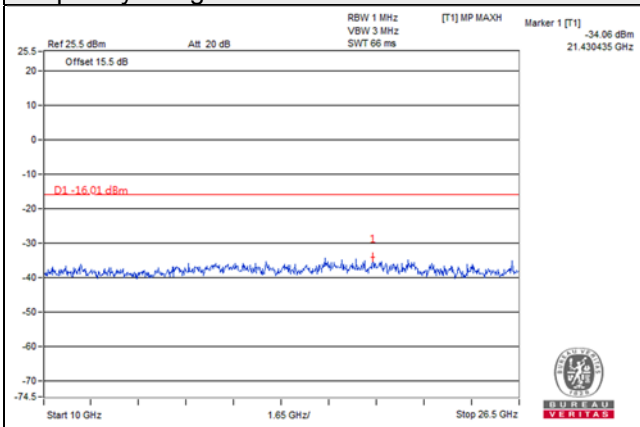

Note: For 9kHz, the signal is from spectrum analyzer.

Channel Bandwidth: 10MHz (Chain 1)

Channel 66786 (2145.0MHz)

Frequency Range : 9kHz~1GHz

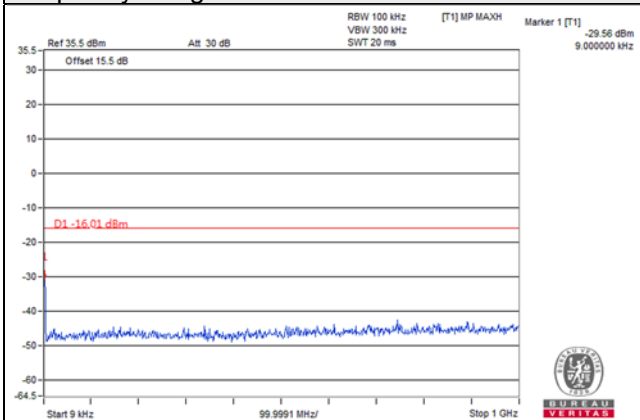

Frequency Range : 1GHz~10GHz

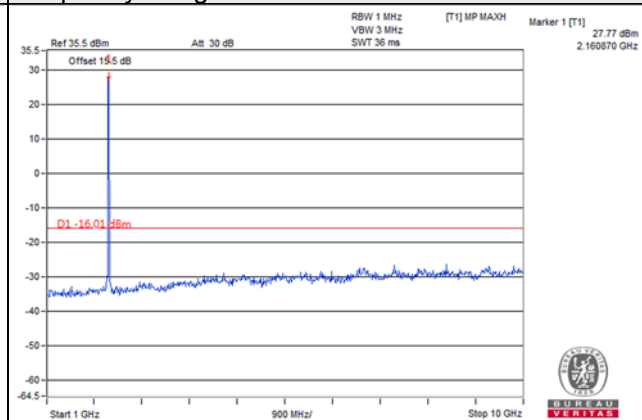

Frequency Range : 10GHz~26.5GHz

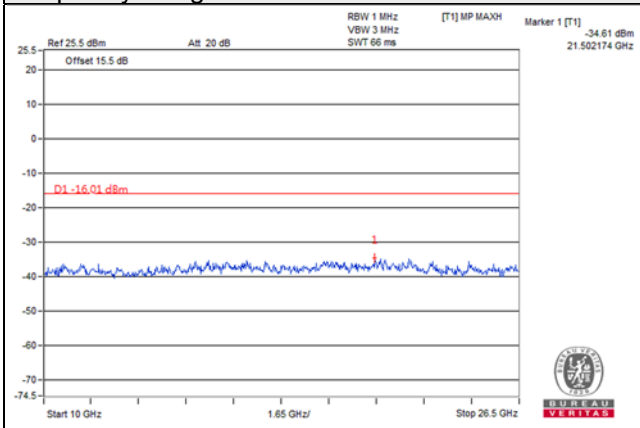

Note: For 9kHz, the signal is from spectrum analyzer.

Channel Bandwidth: 10MHz (Chain 1)

Channel 67086 (2175.0MHz)

Frequency Range : 9kHz~1GHz

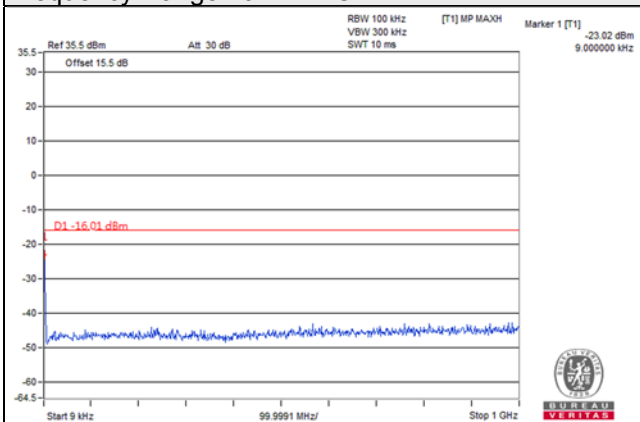

Frequency Range : 1GHz~10GHz

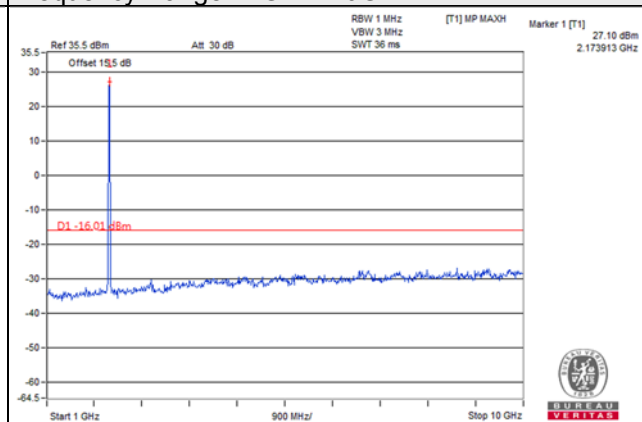

Frequency Range : 10GHz~26.5GHz

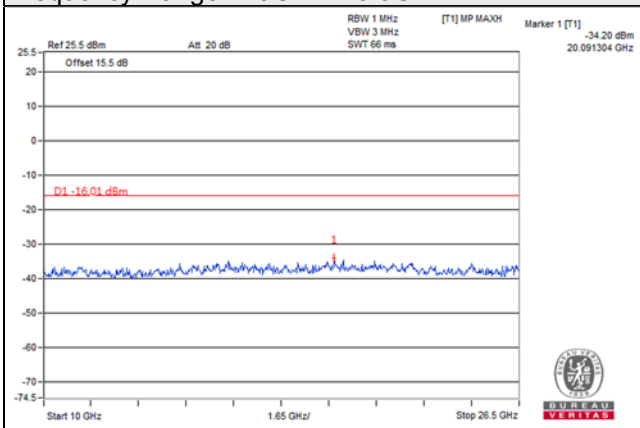

Note: For 9kHz, the signal is from spectrum analyzer.

Channel Bandwidth: 15MHz (Chain 0)

Channel 66511 (2117.5MHz)

Frequency Range : 9kHz~1GHz

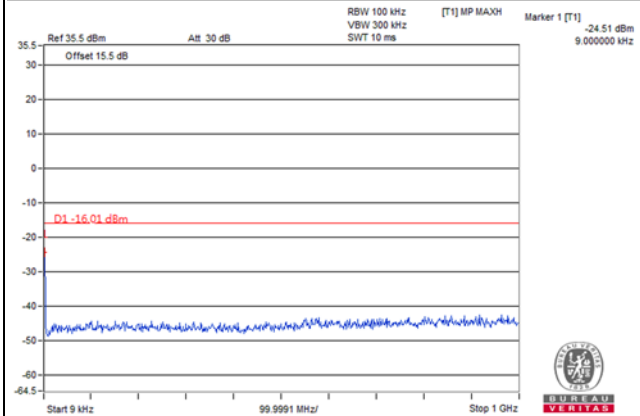

Frequency Range : 1GHz~10GHz

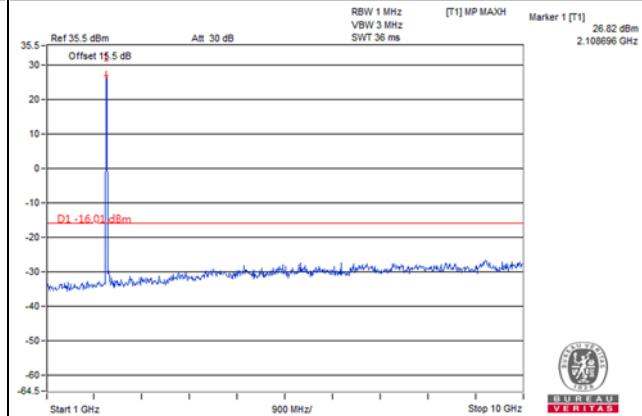

Frequency Range : 10GHz~26.5GHz

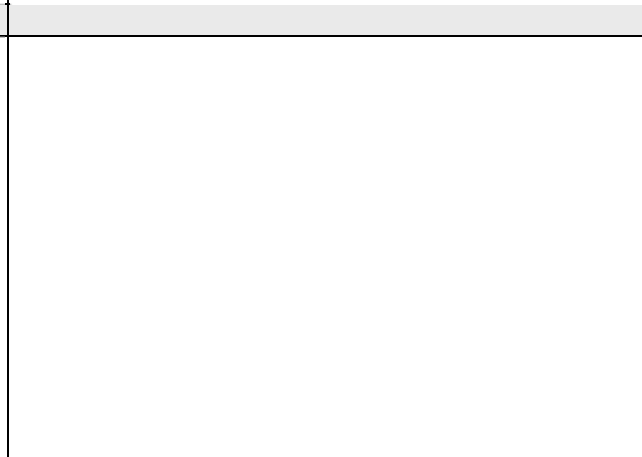
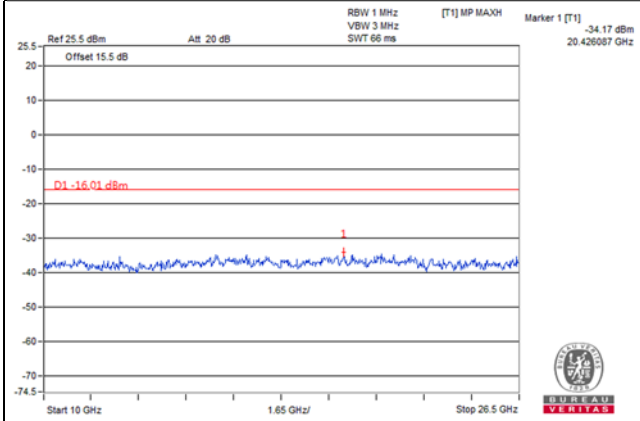

Note: For 9kHz, the signal is from spectrum analyzer.

Channel Bandwidth: 15MHz (Chain 0)

Channel 66786 (2145.0MHz)

Frequency Range : 9kHz~1GHz

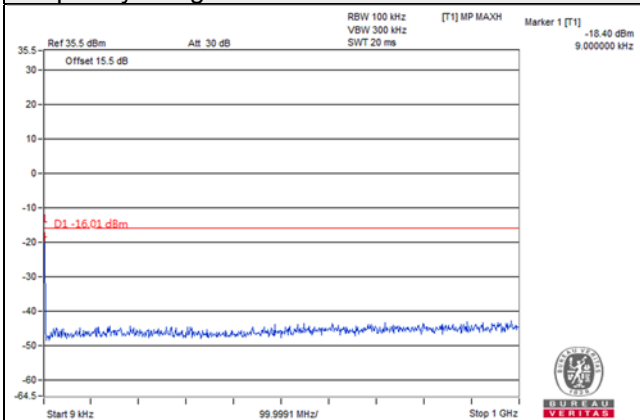

Frequency Range : 1GHz~10GHz

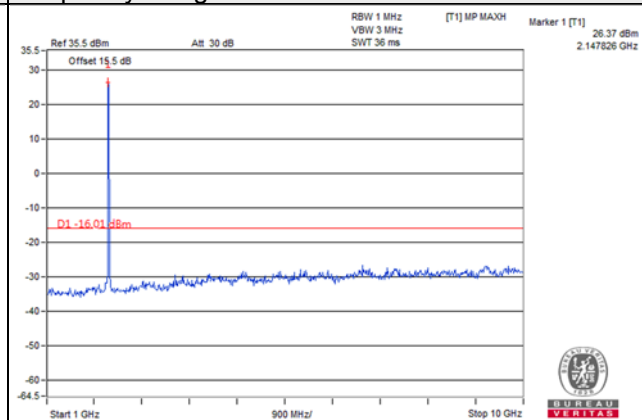

Frequency Range : 10GHz~26.5GHz

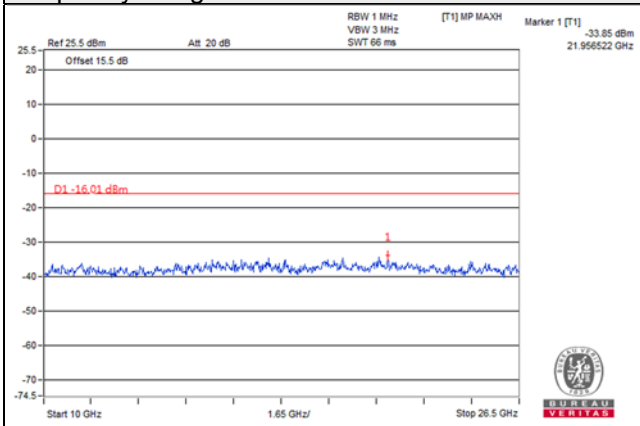

Note: For 9kHz, the signal is from spectrum analyzer.

Channel Bandwidth: 15MHz (Chain 0)

Channel 67061 (2172.5MHz)

Frequency Range : 9kHz~1GHz

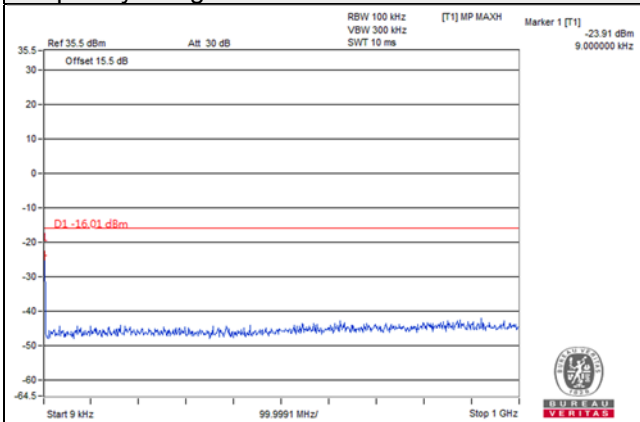

Frequency Range : 1GHz~10GHz

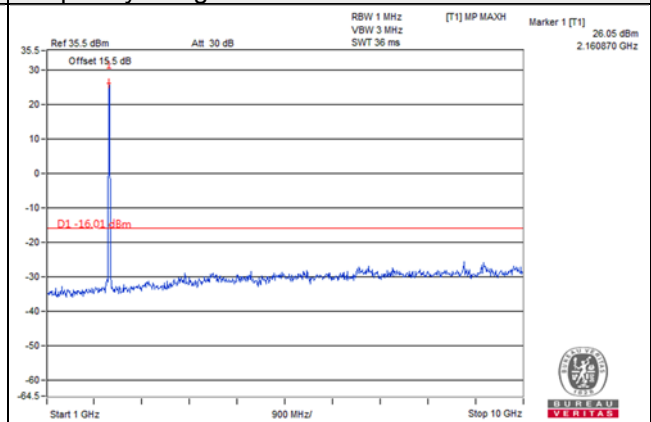

Frequency Range : 10GHz~26.5GHz

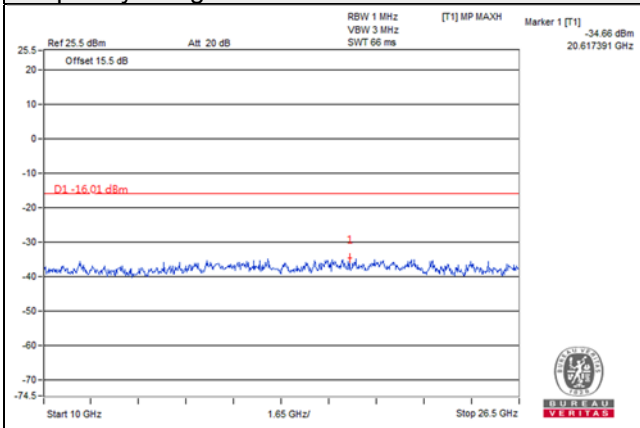

Note: For 9kHz, the signal is from spectrum analyzer.

Channel Bandwidth: 15MHz (Chain 1)

Channel 66511 (2117.5MHz)

Frequency Range : 9kHz~1GHz

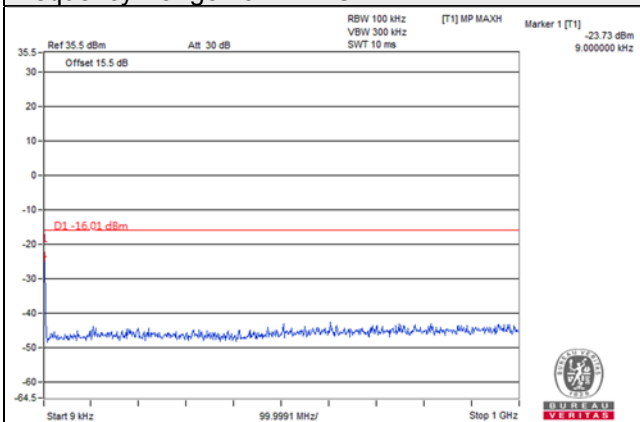

Frequency Range : 1GHz~10GHz

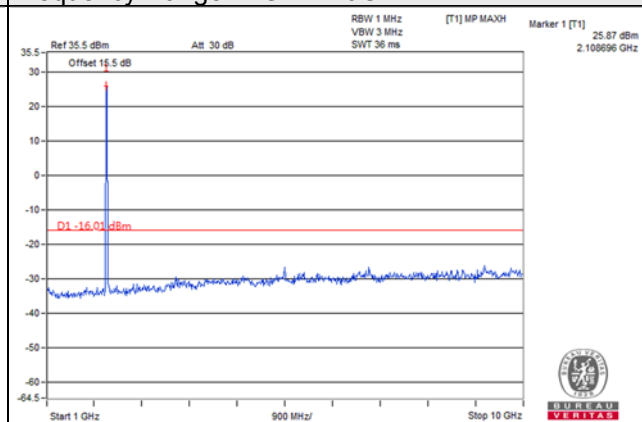

Frequency Range : 10GHz~26.5GHz

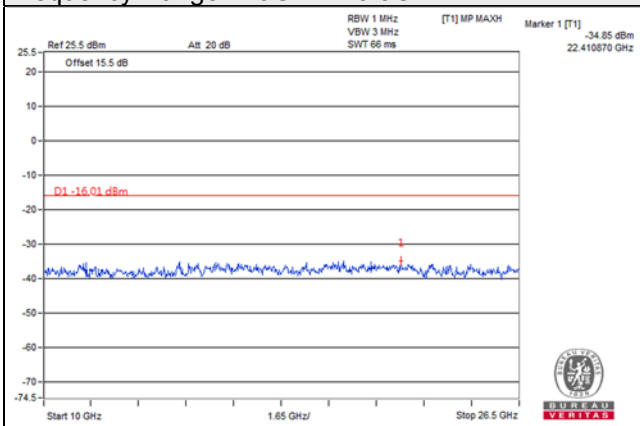

Note: For 9kHz, the signal is from spectrum analyzer.

Channel Bandwidth: 15MHz (Chain 1)

Channel 66786 (2145.0MHz)

Frequency Range : 9kHz~1GHz

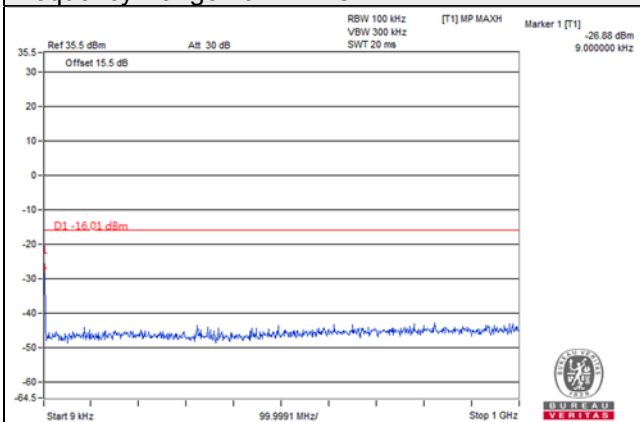

Frequency Range : 1GHz~10GHz

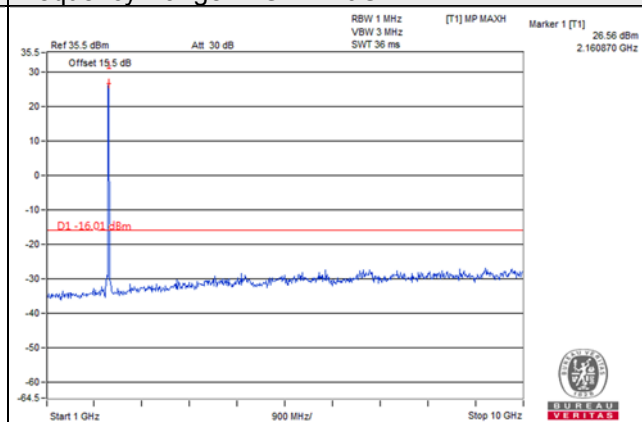

Frequency Range : 10GHz~26.5GHz

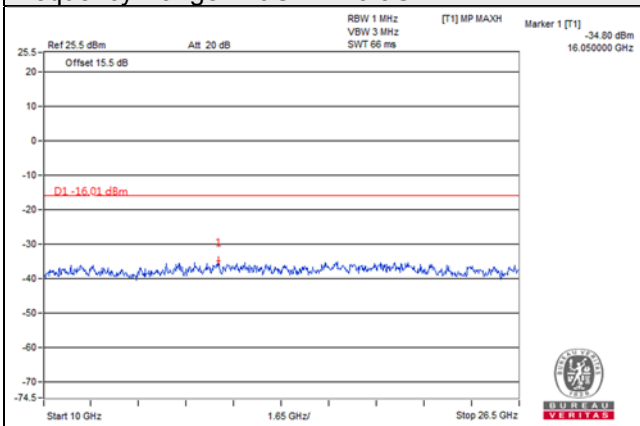

Note: For 9kHz, the signal is from spectrum analyzer.

Channel Bandwidth: 15MHz (Chain 1)

Channel 67061 (2172.5MHz)

Frequency Range : 9kHz~1GHz

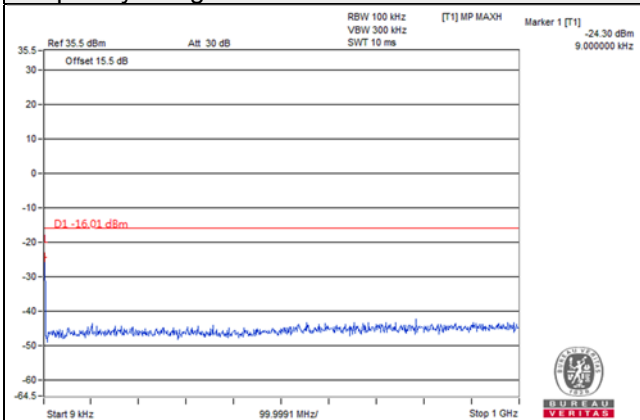

Frequency Range : 1GHz~10GHz

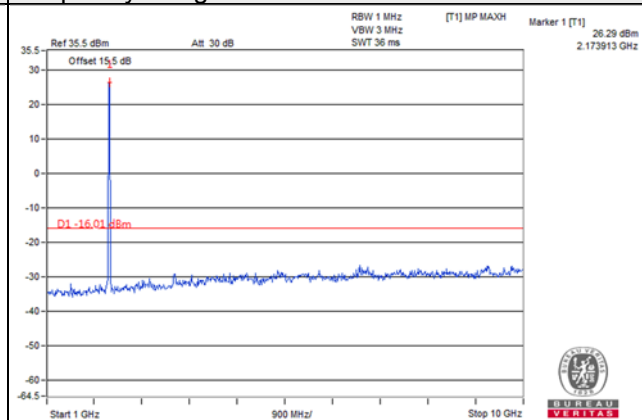

Frequency Range : 10GHz~26.5GHz

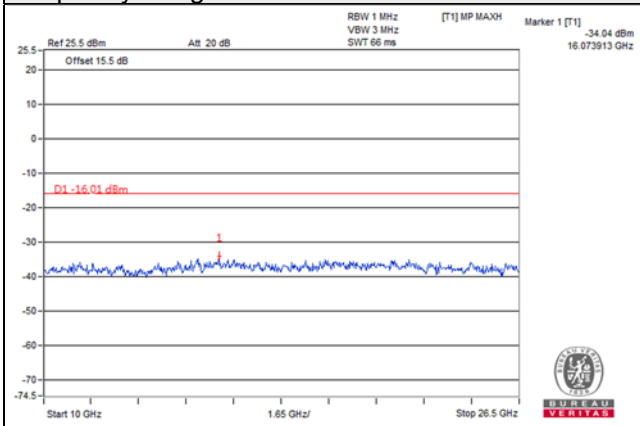

Note: For 9kHz, the signal is from spectrum analyzer.

Channel Bandwidth: 20MHz (Chain 0)

Channel 66536 (2120.0MHz)

Frequency Range : 9kHz~1GHz

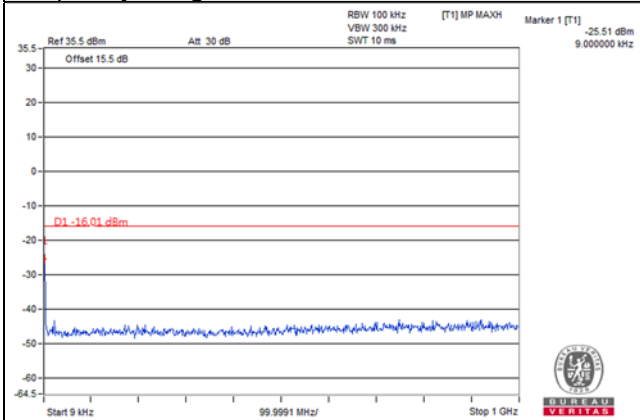

Frequency Range : 1GHz~10GHz

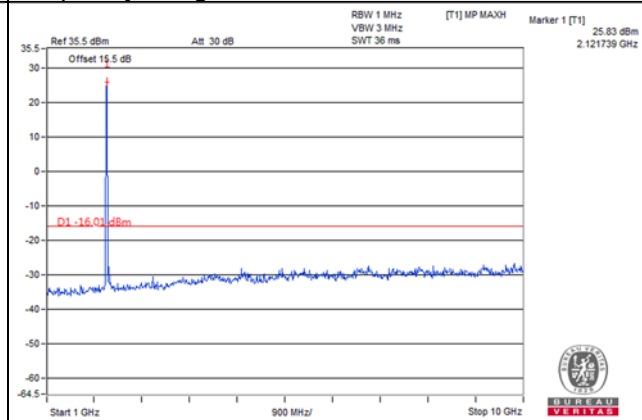

Frequency Range : 10GHz~26.5GHz

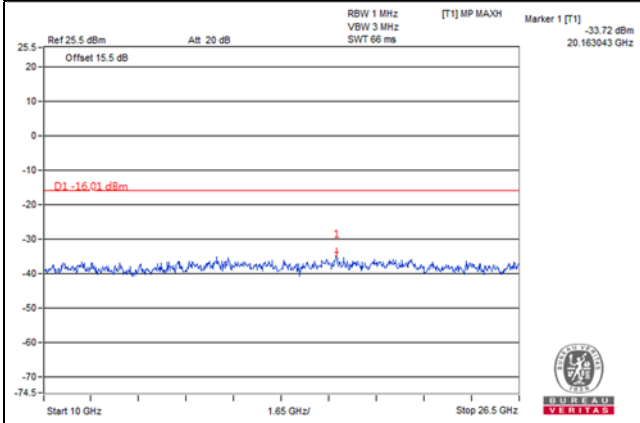

Note: For 9kHz, the signal is from spectrum analyzer.

Channel Bandwidth: 20MHz (Chain 0)

Channel 66786 (2145.0MHz)

Frequency Range : 9kHz~1GHz

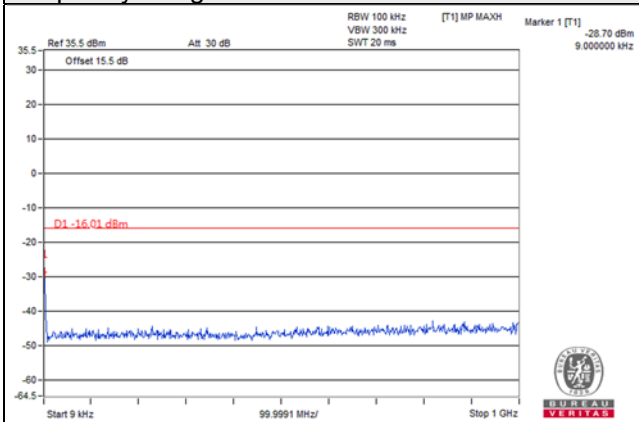

Frequency Range : 1GHz~10GHz

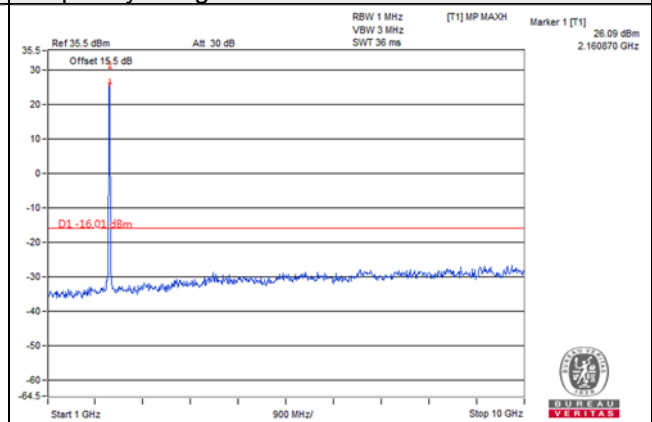

Frequency Range : 10GHz~26.5GHz

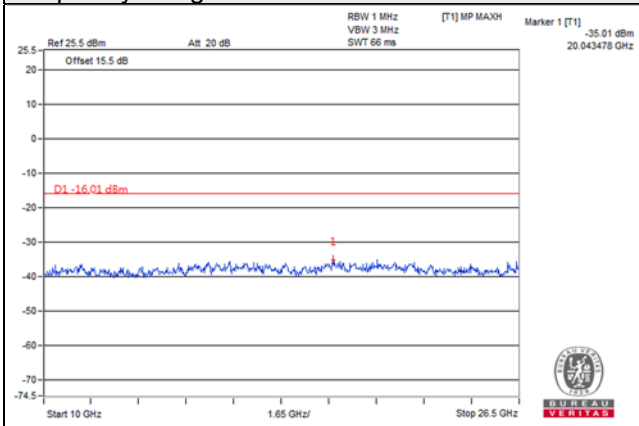

Note: For 9kHz, the signal is from spectrum analyzer.

Channel Bandwidth: 20MHz (Chain 0)

Channel 67036 (2170.0MHz)

Frequency Range : 9kHz~1GHz

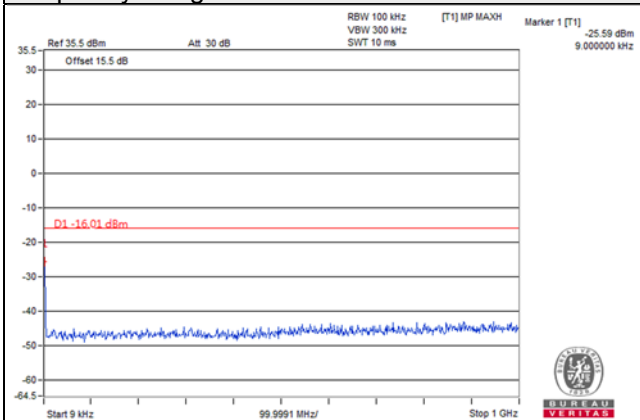

Frequency Range : 1GHz~10GHz

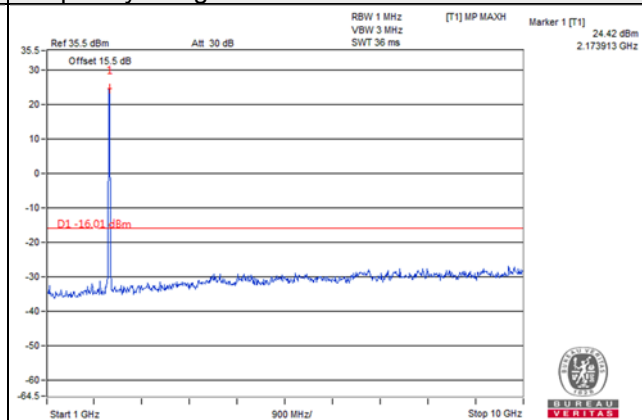

Frequency Range : 10GHz~26.5GHz

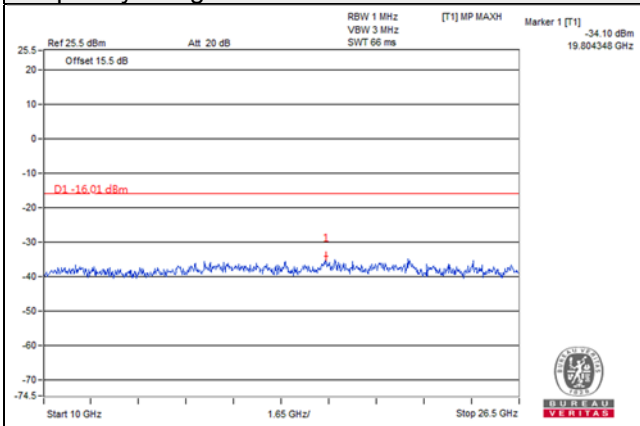

Note: For 9kHz, the signal is from spectrum analyzer.

Channel Bandwidth: 20MHz (Chain 1)

Channel 66536 (2120.0MHz)

Frequency Range : 9kHz~1GHz

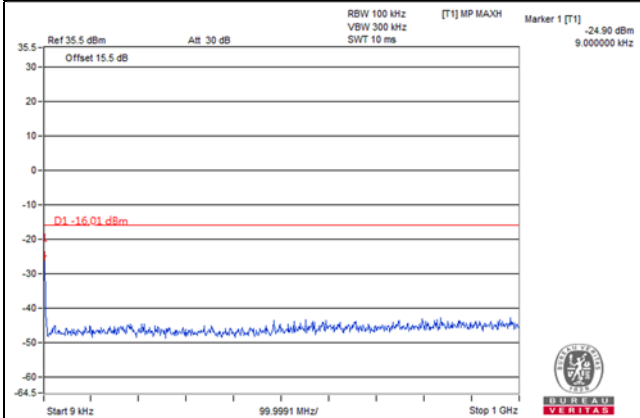

Frequency Range : 1GHz~10GHz

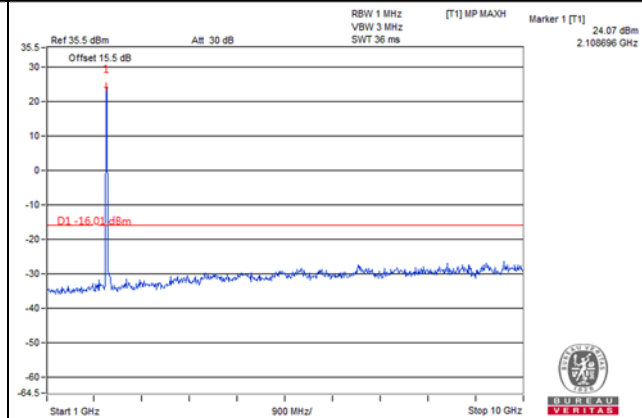

Frequency Range : 10GHz~26.5GHz

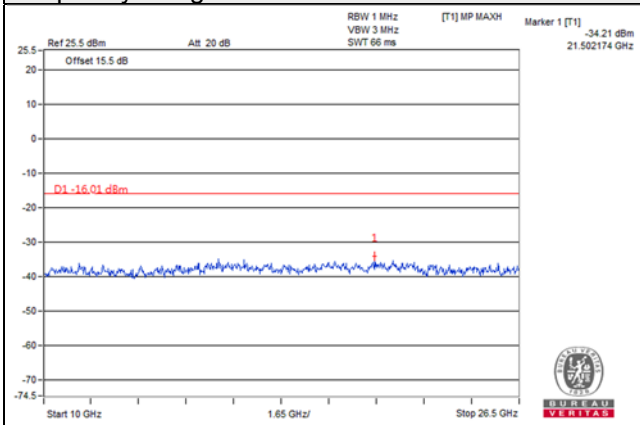

Note: For 9kHz, the signal is from spectrum analyzer.

Channel Bandwidth: 20MHz (Chain 1)

Channel 66786 (2145.0MHz)

Frequency Range : 9kHz~1GHz

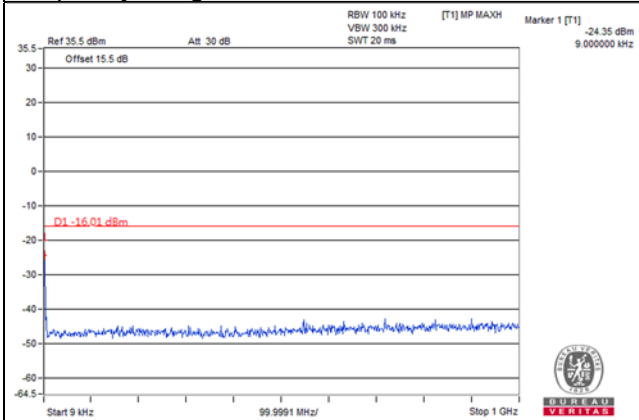

Frequency Range : 1GHz~10GHz

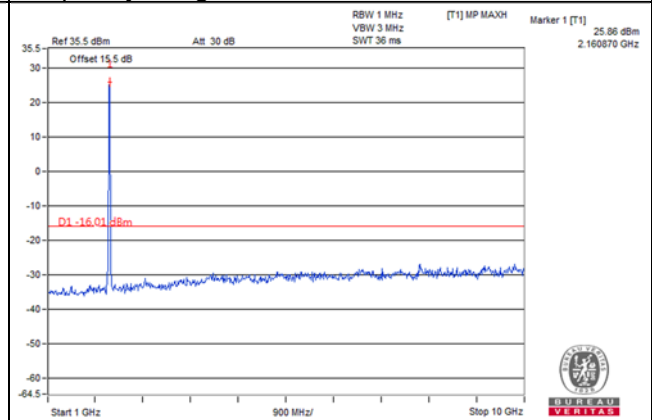

Frequency Range : 10GHz~26.5GHz

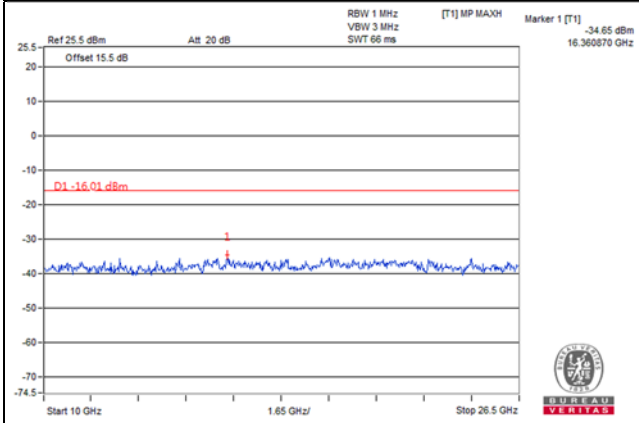

Note: For 9kHz, the signal is from spectrum analyzer.

Channel Bandwidth: 20MHz (Chain 1)

Channel 67036 (2170.0MHz)

Frequency Range : 9kHz~1GHz

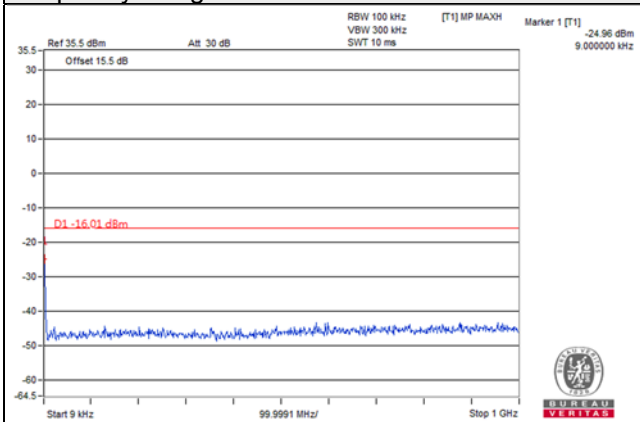

Frequency Range : 1GHz~10GHz

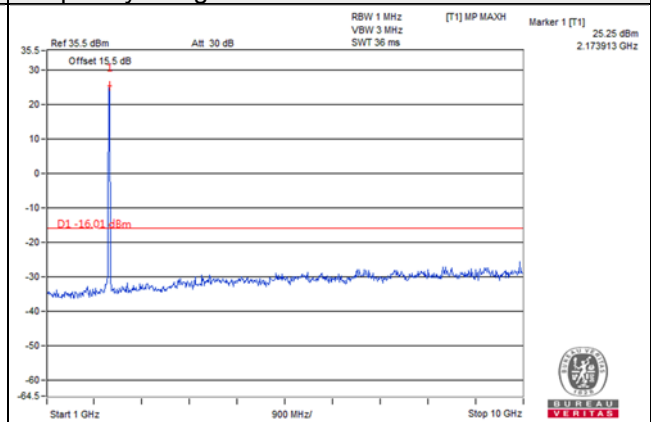

Frequency Range : 10GHz~26.5GHz

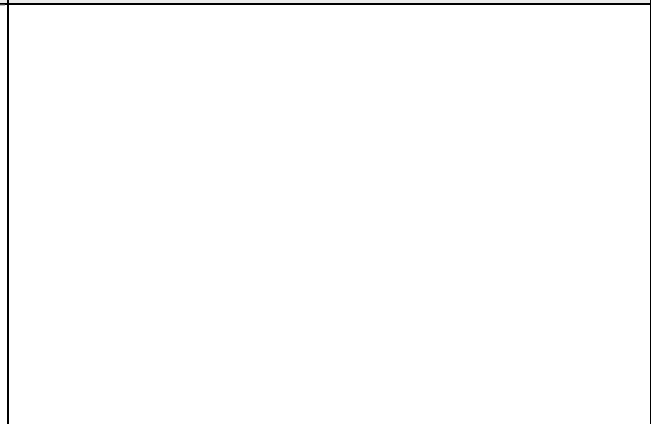
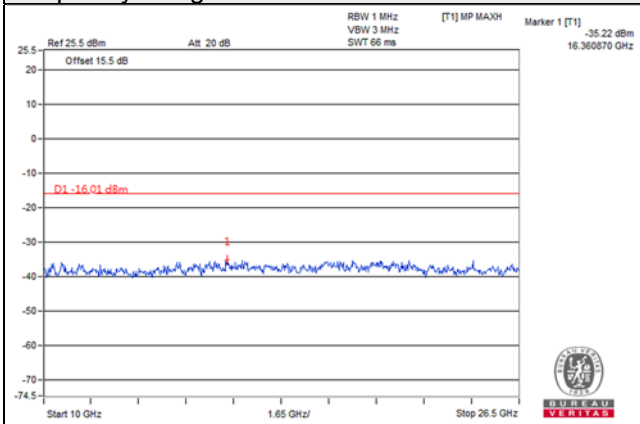

Note: For 9kHz, the signal is from spectrum analyzer.

4.8 Radiated Emission Measurement

4.8.1 Limits of Radiated Emission Measurement

According to FCC 27.53(h) for operations in the 1695-1710 MHz, 1710-1755 MHz, 1755-1780 MHz, 1915-1920 MHz, 1995-2000 MHz, 2000-2020 MHz, 2110-2155 MHz, 2155-2180 MHz, and 2180-2200 bands, the power of any emission outside a licensee's frequency block shall be attenuated below the transmitter power (P) in watts by at least $43 + 10 \log_{10}(P)$ dB.

4.8.2 Test Procedure

- a. The power was measured with R&S Spectrum Analyzer. All measurements were done at 3 channels (low, middle and high channel of operational frequency range.)
- b. Substitution method is used for E.I.R.P measurement. In the semi-anechoic chamber, EUT placed on the 0.8m height of Turn Table, rotated the table around 360 degrees to search the maximum radiation power and receiver antenna shall be rotated vertical and horizontal polarization and moved height from 1m to 4m to find the maximum polar radiated power. The "Read Value" is the spectrum reading the maximum power value.
- c. The substitution antenna is substituted for EUT at the same position and signals generator export the CW signal to the substitution antenna via a TX cable. Rotated the Turn Table and moved receiving antenna to find the maximum radiation power. Adjust output power level of S.G to get a Value of spectrum reading equal to "Read Value" of step b. Record the power level of S.G
- d. $EIRP = \text{Output power level of S.G} - \text{TX cable loss} + \text{Antenna gain of substitution antenna}$.

Note: The resolution bandwidth and video bandwidth of test receiver/spectrum analyzer is 1MHz/3MHz.

4.8.3 Deviation from Test Standard

No deviation.

4.8.4 Test Setup

For Radiated emission 30MHz to 1GHz

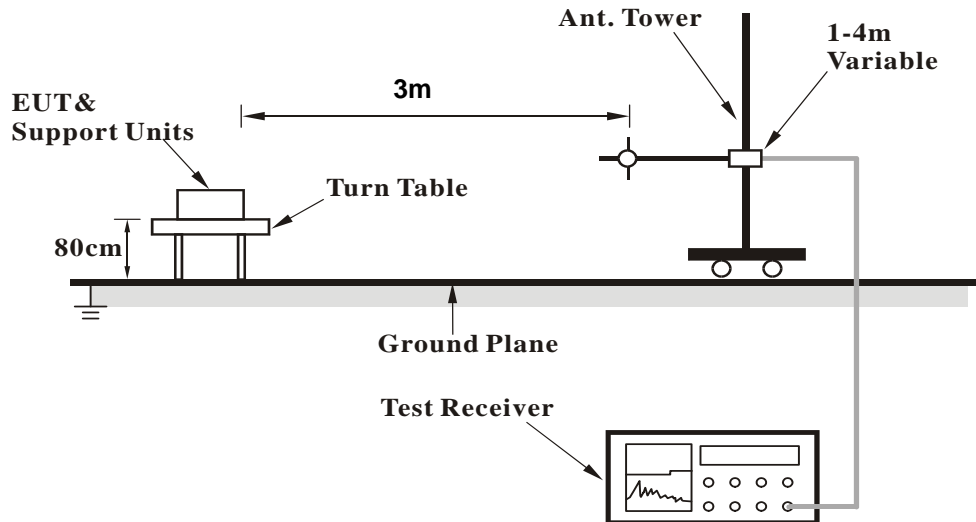

For Radiated emission above 1GHz

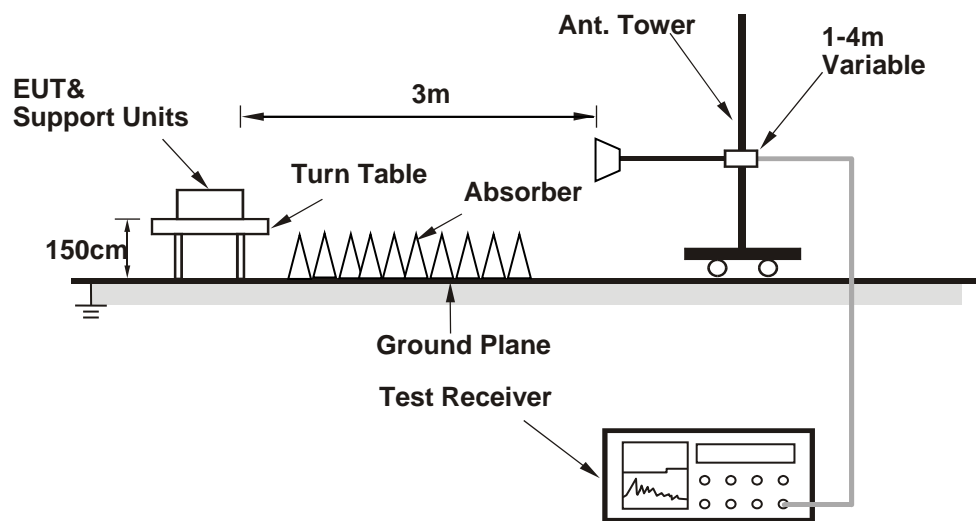

For the actual test configuration, please refer to the attached file (Test Setup Photo).

4.8.5 Test Results

Below 1GHz

LTE Band 66

For NB-IOT In-band:

Channel Bandwidth: 5MHz

Mode	TX channel 66461 (2112.5MHz)	Frequency Range	Below 1000 MHz
Environmental Conditions	25deg. C, 65%RH	Input Power	120Vac, 60Hz
Tested By	Greg Lin		

Antenna Polarity & Test Distance: Horizontal at 3 M							
No.	Freq. (MHz)	Reading (dBm)	S.G Power Value (dBm)	Correction Factor (dB)	EIRP (dBm)	Limit (dBm)	Margin (dB)
1	30.00	-47.2	-23.8	-19.4	-43.2	-13.0	-30.2
2	76.56	-52.4	-58.3	0.3	-58.0	-13.0	-45.0
3	111.48	-52.0	-57.2	-2.5	-59.7	-13.0	-46.7
4	282.20	-50.8	-53.3	-1.7	-55.0	-13.0	-42.0
5	360.77	-62.8	-69.5	4.0	-65.5	-13.0	-52.5
6	941.80	-70.3	-65.7	3.8	-61.9	-13.0	-48.9

Remarks:

1. EIRP (dBm) = S.G Value (dBm) + Correction Factor (dB).
2. Correction Factor (dB) = Substitution Antenna Gain (dB) + Cable Loss (dB).

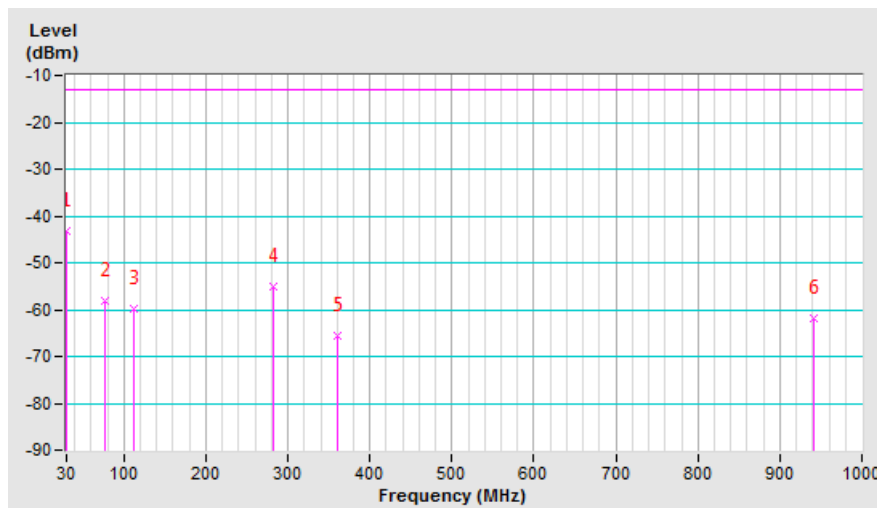

Mode	TX channel 66461 (2112.5MHz)	Frequency Range	Below 1000 MHz
Environmental Conditions	25deg. C, 65%RH	Input Power	120Vac, 60Hz
Tested By	Greg Lin		

Antenna Polarity & Test Distance: Vertical at 3 M							
No.	Freq. (MHz)	Reading (dBm)	S.G Power Value (dBm)	Correction Factor (dB)	EIRP (dBm)	Limit (dBm)	Margin (dB)
1	59.10	-45.8	-48.8	-3.8	-52.6	-13.0	-39.6
2	90.14	-49.7	-55.8	-0.2	-56.0	-13.0	-43.0
3	194.90	-56.4	-54.9	-2.6	-57.5	-13.0	-44.5
4	278.32	-52.4	-47.5	-1.6	-49.1	-13.0	-36.1
5	499.48	-62.1	-65.9	3.8	-62.1	-13.0	-49.1
6	917.55	-70.5	-65.6	3.6	-62.0	-13.0	-49.0

Remarks:

1. EIRP (dBm) = S.G Value (dBm) + Correction Factor (dB).
2. Correction Factor (dB) = Substitution Antenna Gain (dB) + Cable Loss (dB).

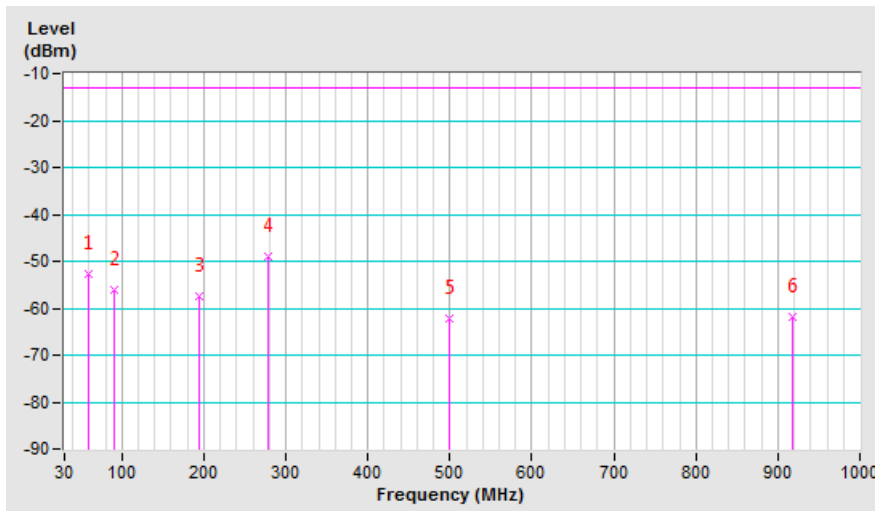

For NB-IOT Guard Band:

Channel Bandwidth: 10MHz

Mode	TX channel 66486 (2115.0MHz)	Frequency Range	Below 1000 MHz
Environmental Conditions	23deg. C, 68%RH	Input Power	120Vac, 60Hz
Tested By	Greg Lin		

Antenna Polarity & Test Distance: Horizontal at 3 M							
No.	Freq. (MHz)	Reading (dBm)	S.G Power Value (dBm)	Correction Factor (dB)	EIRP (dBm)	Limit (dBm)	Margin (dB)
1	30.00	-51.9	-28.5	-19.4	-47.9	-13.0	-34.9
2	157.07	-52.9	-54.9	-2.8	-57.7	-13.0	-44.7
3	251.16	-47.6	-52.4	-1.4	-53.8	-13.0	-40.8
4	396.66	-60.9	-64.9	3.3	-61.6	-13.0	-48.6
5	734.22	-59.2	-58.7	3.7	-55.0	-13.0	-42.0
6	935.98	-59.2	-54.7	3.7	-51.0	-13.0	-38.0

Remarks:

1. EIRP (dBm) = S.G Value (dBm) + Correction Factor (dB).
2. Correction Factor (dB) = Substitution Antenna Gain (dB) + Cable Loss (dB).

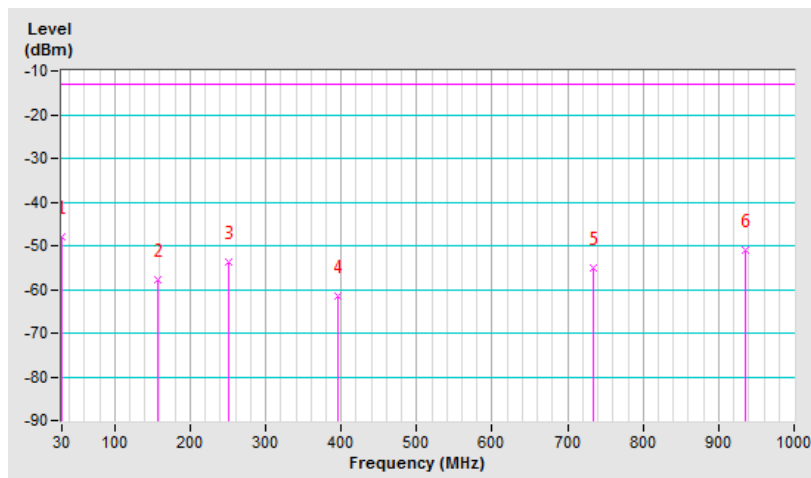

Mode	TX channel 66486 (2115.0MHz)	Frequency Range	Below 1000 MHz
Environmental Conditions	23deg. C, 68%RH	Input Power	120Vac, 60Hz
Tested By	Greg Lin		

Antenna Polarity & Test Distance: Vertical at 3 M							
No.	Freq. (MHz)	Reading (dBm)	S.G Power Value (dBm)	Correction Factor (dB)	EIRP (dBm)	Limit (dBm)	Margin (dB)
1	33.88	-35.5	-29.0	-17.1	-46.1	-13.0	-33.1
2	143.49	-51.1	-50.2	-3.1	-53.3	-13.0	-40.3
3	277.35	-53.4	-48.5	-1.6	-50.1	-13.0	-37.1
4	500.45	-56.3	-60.2	3.8	-56.4	-13.0	-43.4
5	750.71	-66.2	-62.9	3.7	-59.2	-13.0	-46.2
6	935.98	-61.1	-55.9	3.7	-52.2	-13.0	-39.2

Remarks:

1. EIRP (dBm) = S.G Value (dBm) + Correction Factor (dB).
2. Correction Factor (dB) = Substitution Antenna Gain (dB) + Cable Loss (dB).

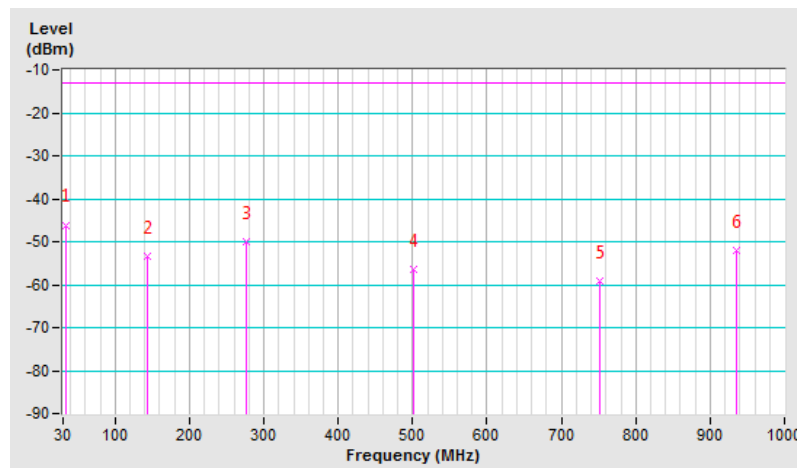

Channel Bandwidth: 15MHz

Mode	TX channel 66511 (2117.5MHz)	Frequency Range	Below 1000 MHz
Environmental Conditions	23deg. C, 68%RH	Input Power	120Vac, 60Hz
Tested By	Greg Lin		

Antenna Polarity & Test Distance: Horizontal at 3 M							
No.	Freq. (MHz)	Reading (dBm)	S.G Power Value (dBm)	Correction Factor (dB)	EIRP (dBm)	Limit (dBm)	Margin (dB)
1	35.82	-52.2	-32.8	-15.9	-48.7	-13.0	-35.7
2	143.49	-53.4	-55.5	-3.1	-58.6	-13.0	-45.6
3	293.84	-52.0	-53.4	-1.8	-55.2	-13.0	-42.2
4	404.42	-61.4	-65.3	3.3	-62.0	-13.0	-49.0
5	746.83	-58.5	-58.2	3.7	-54.5	-13.0	-41.5
6	939.86	-64.0	-59.4	3.7	-55.7	-13.0	-42.7

Remarks:

1. EIRP (dBm) = S.G Value (dBm) + Correction Factor (dB).
2. Correction Factor (dB) = Substitution Antenna Gain (dB) + Cable Loss (dB).

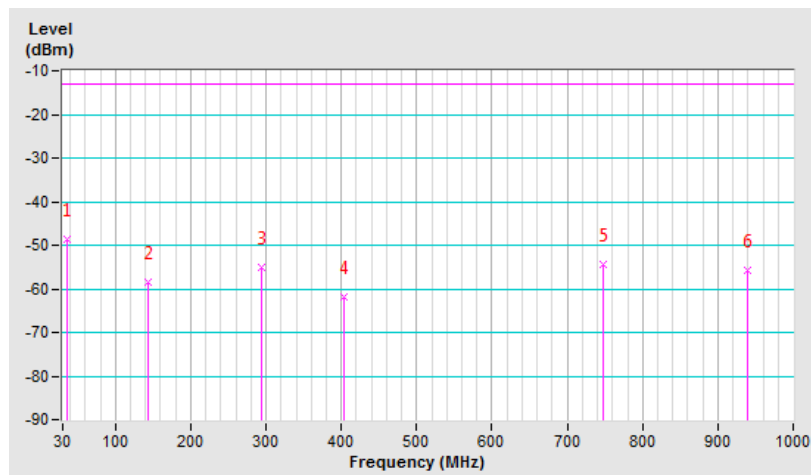

Mode	TX channel 66511 (2117.5MHz)	Frequency Range	Below 1000 MHz
Environmental Conditions	23deg. C, 68%RH	Input Power	120Vac, 60Hz
Tested By	Greg Lin		

Antenna Polarity & Test Distance: Vertical at 3 M							
No.	Freq. (MHz)	Reading (dBm)	S.G Power Value (dBm)	Correction Factor (dB)	EIRP (dBm)	Limit (dBm)	Margin (dB)
1	62.98	-41.4	-45.7	-2.4	-48.1	-13.0	-35.1
2	164.83	-50.5	-50.8	-2.9	-53.7	-13.0	-40.7
3	280.26	-54.8	-50.0	-1.6	-51.6	-13.0	-38.6
4	386.96	-60.7	-64.8	3.5	-61.3	-13.0	-48.3
5	786.60	-68.8	-65.9	4.0	-61.9	-13.0	-48.9
6	939.86	-66.6	-61.3	3.7	-57.6	-13.0	-44.6

Remarks:

1. EIRP (dBm) = S.G Value (dBm) + Correction Factor (dB).
2. Correction Factor (dB) = Substitution Antenna Gain (dB) + Cable Loss (dB).

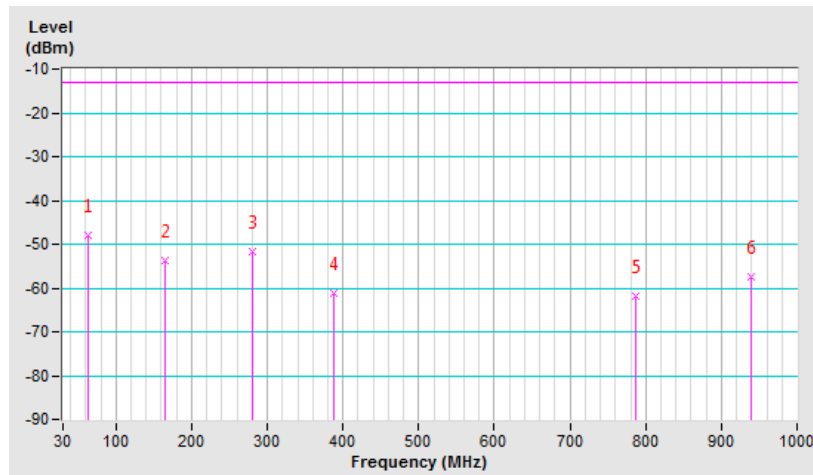

Channel Bandwidth: 20MHz

Mode	TX channel 66536 (2120.0MHz)	Frequency Range	Below 1000 MHz
Environmental Conditions	23deg. C, 68%RH	Input Power	120Vac, 60Hz
Tested By	Greg Lin		

Antenna Polarity & Test Distance: Horizontal at 3 M							
No.	Freq. (MHz)	Reading (dBm)	S.G Power Value (dBm)	Correction Factor (dB)	EIRP (dBm)	Limit (dBm)	Margin (dB)
1	35.82	-54.5	-35.1	-15.9	-51.0	-13.0	-38.0
2	99.84	-49.8	-56.7	-1.5	-58.2	-13.0	-45.2
3	258.92	-47.6	-51.1	-1.5	-52.6	-13.0	-39.6
4	398.60	-61.3	-65.3	3.3	-62.0	-13.0	-49.0
5	544.10	-66.6	-69.9	3.8	-66.1	-13.0	-53.1
6	933.07	-61.1	-56.8	3.7	-53.1	-13.0	-40.1

Remarks:

1. EIRP (dBm) = S.G Value (dBm) + Correction Factor (dB).
2. Correction Factor (dB) = Substitution Antenna Gain (dB) + Cable Loss (dB).

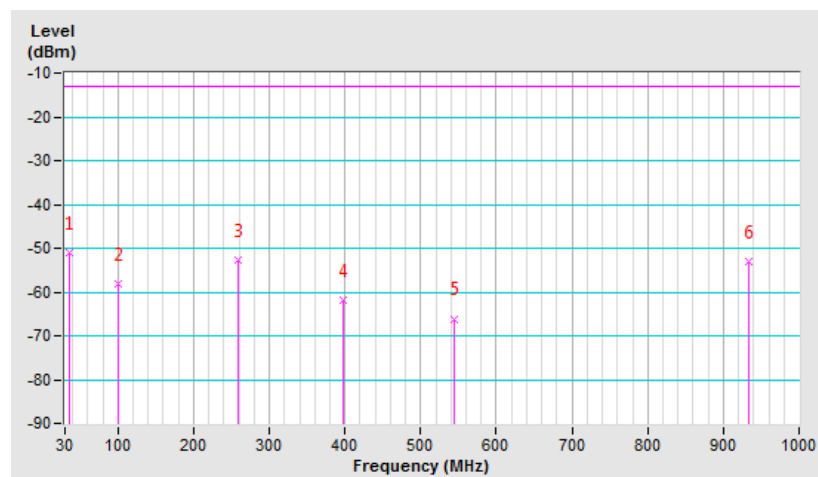

Mode	TX channel 66536 (2120.0MHz)	Frequency Range	Below 1000 MHz
Environmental Conditions	23deg. C, 68%RH	Input Power	120Vac, 60Hz
Tested By	Greg Lin		

Antenna Polarity & Test Distance: Vertical at 3 M							
No.	Freq. (MHz)	Reading (dBm)	S.G Power Value (dBm)	Correction Factor (dB)	EIRP (dBm)	Limit (dBm)	Margin (dB)
1	50.37	-39.8	-39.3	-7.9	-47.2	-13.0	-34.2
2	145.43	-52.4	-51.3	-3.1	-54.4	-13.0	-41.4
3	250.19	-52.3	-51.0	-1.3	-52.3	-13.0	-39.3
4	500.45	-55.6	-59.5	3.8	-55.7	-13.0	-42.7
5	750.71	-67.3	-64.0	3.7	-60.3	-13.0	-47.3
6	935.01	-60.3	-55.1	3.7	-51.4	-13.0	-38.4

Remarks:

1. EIRP (dBm) = S.G Value (dBm) + Correction Factor (dB).
2. Correction Factor (dB) = Substitution Antenna Gain (dB) + Cable Loss (dB).

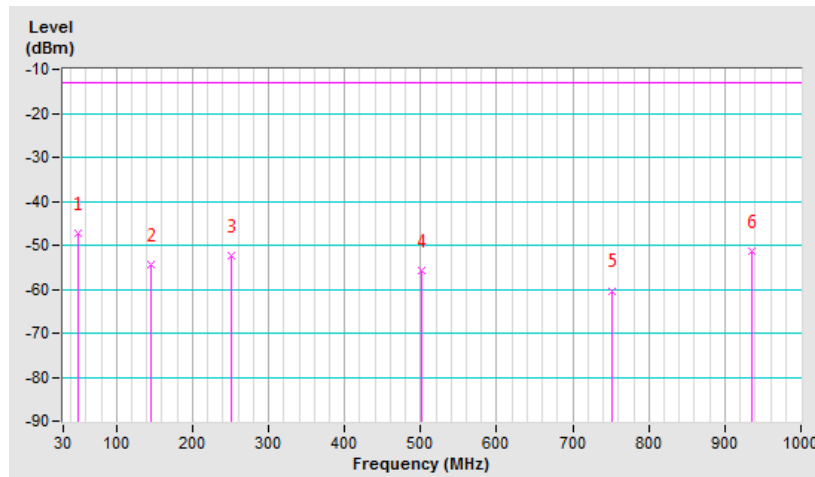

Above 1GHz
 LTE Band 66
For NB-IOT In-band:
 Channel Bandwidth: 5MHz

Mode	TX channel 66461 (2112.5MHz)	Frequency Range	1GHz~26GHz
Environmental Conditions	23deg. C, 68%RH	Input Power	120Vac, 60Hz
Tested By	Greg Lin		

Antenna Polarity & Test Distance: Horizontal at 3 M							
No.	Freq. (MHz)	Reading (dBm)	S.G Power Value (dBm)	Correction Factor (dB)	EIRP (dBm)	Limit (dBm)	Margin (dB)
1	4225.00	-46.6	-38.0	1.0	-37.0	-13.0	-24.0
2	6337.50	-53.2	-37.3	0.6	-36.7	-13.0	-23.7
Antenna Polarity & Test Distance: Vertical at 3 M							
No.	Freq. (MHz)	Reading (dBm)	S.G Power Value (dBm)	Correction Factor (dB)	EIRP (dBm)	Limit (dBm)	Margin (dB)
1	4225.00	-43.7	-34.0	1.0	-33.0	-13.0	-20.0
2	6337.50	-48.3	-33.1	0.6	-32.5	-13.0	-19.5

Remarks:

- EIRP (dBm) = S.G Value (dBm) + Correction Factor (dB).
- Correction Factor (dB) = Substitution Antenna Gain (dB) + Cable Loss (dB).

Mode	TX channel 66786 (2145.0MHz)	Frequency Range	1GHz~26GHz
Environmental Conditions	23deg. C, 68%RH	Input Power	120Vac, 60Hz
Tested By	Greg Lin		

Antenna Polarity & Test Distance: Horizontal at 3 M							
No.	Freq. (MHz)	Reading (dBm)	S.G Power Value (dBm)	Correction Factor (dB)	EIRP (dBm)	Limit (dBm)	Margin (dB)
1	4290.00	-48.3	-39.3	1.1	-38.2	-13.0	-25.2
2	6435.00	-52.6	-36.6	0.5	-36.1	-13.0	-23.1
Antenna Polarity & Test Distance: Vertical at 3 M							
No.	Freq. (MHz)	Reading (dBm)	S.G Power Value (dBm)	Correction Factor (dB)	EIRP (dBm)	Limit (dBm)	Margin (dB)
1	4290.00	-44.7	-35.3	1.1	-34.2	-13.0	-21.2
2	6435.00	-48.2	-32.6	0.5	-32.1	-13.0	-19.1

Remarks:

- EIRP (dBm) = S.G Value (dBm) + Correction Factor (dB).
- Correction Factor (dB) = Substitution Antenna Gain (dB) + Cable Loss (dB).

Mode	TX channel 67111 (2177.5MHz)	Frequency Range	1GHz~26GHz
Environmental Conditions	23deg. C, 68%RH	Input Power	120Vac, 60Hz
Tested By	Greg Lin		

Antenna Polarity & Test Distance: Horizontal at 3 M							
No.	Freq. (MHz)	Reading (dBm)	S.G Power Value (dBm)	Correction Factor (dB)	EIRP (dBm)	Limit (dBm)	Margin (dB)
1	4355.00	-48.7	-39.0	1.0	-38.0	-13.0	-25.0
2	6532.50	-52.9	-36.9	0.5	-36.4	-13.0	-23.4
Antenna Polarity & Test Distance: Vertical at 3 M							
No.	Freq. (MHz)	Reading (dBm)	S.G Power Value (dBm)	Correction Factor (dB)	EIRP (dBm)	Limit (dBm)	Margin (dB)
1	4355.00	-44.3	-35.0	1.0	-34.0	-13.0	-21.0
2	6532.50	-48.5	-32.9	0.5	-32.4	-13.0	-19.4

Remarks:

1. EIRP (dBm) = S.G Value (dBm) + Correction Factor (dB).
2. Correction Factor (dB) = Substitution Antenna Gain (dB) + Cable Loss (dB).

**For NB-IOT Guard Band:
QPSK_IoT Signal at Bottom**

Channel Bandwidth: 10MHz

Mode	TX channel 66486 (2115.0MHz)	Frequency Range	1GHz~26GHz
Environmental Conditions	23deg. C, 68%RH	Input Power	120Vac, 60Hz
Tested By	Greg Lin		

Antenna Polarity & Test Distance: Horizontal at 3 M							
No.	Freq. (MHz)	Reading (dBm)	S.G Power Value (dBm)	Correction Factor (dB)	EIRP (dBm)	Limit (dBm)	Margin (dB)
1	4230.00	-56.2	-47.5	1.0	-46.5	-13.0	-33.5
Antenna Polarity & Test Distance: Vertical at 3 M							
No.	Freq. (MHz)	Reading (dBm)	S.G Power Value (dBm)	Correction Factor (dB)	EIRP (dBm)	Limit (dBm)	Margin (dB)
1	4230.00	-54.2	-44.5	1.0	-43.5	-13.0	-30.5

Remarks:

1. EIRP (dBm) = S.G Value (dBm) + Correction Factor (dB).
2. Correction Factor (dB) = Substitution Antenna Gain (dB) + Cable Loss (dB).

Mode	TX channel 66786 (2145.0MHz)	Frequency Range	1GHz~26GHz
Environmental Conditions	23deg. C, 68%RH	Input Power	120Vac, 60Hz
Tested By	Greg Lin		

Antenna Polarity & Test Distance: Horizontal at 3 M							
No.	Freq. (MHz)	Reading (dBm)	S.G Power Value (dBm)	Correction Factor (dB)	EIRP (dBm)	Limit (dBm)	Margin (dB)
1	4290.00	-55.5	-46.5	1.1	-45.4	-13.0	-32.4
Antenna Polarity & Test Distance: Vertical at 3 M							
No.	Freq. (MHz)	Reading (dBm)	S.G Power Value (dBm)	Correction Factor (dB)	EIRP (dBm)	Limit (dBm)	Margin (dB)
1	4290.00	-53.8	-44.4	1.1	-43.3	-13.0	-30.3

Remarks:

1. EIRP (dBm) = S.G Value (dBm) + Correction Factor (dB).
2. Correction Factor (dB) = Substitution Antenna Gain (dB) + Cable Loss (dB).

Mode	TX channel 67086 (2175.0MHz)	Frequency Range	1GHz~26GHz
Environmental Conditions	23deg. C, 68%RH	Input Power	120Vac, 60Hz
Tested By	Greg Lin		

Antenna Polarity & Test Distance: Horizontal at 3 M							
No.	Freq. (MHz)	Reading (dBm)	S.G Power Value (dBm)	Correction Factor (dB)	EIRP (dBm)	Limit (dBm)	Margin (dB)
1	4350.00	-56.1	-46.4	1.0	-45.4	-13.0	-32.4
Antenna Polarity & Test Distance: Vertical at 3 M							
No.	Freq. (MHz)	Reading (dBm)	S.G Power Value (dBm)	Correction Factor (dB)	EIRP (dBm)	Limit (dBm)	Margin (dB)
1	4350.00	-54.1	-44.8	1.0	-43.8	-13.0	-30.8

Remarks:

1. EIRP (dBm) = S.G Value (dBm) + Correction Factor (dB).
2. Correction Factor (dB) = Substitution Antenna Gain (dB) + Cable Loss (dB).

Channel Bandwidth: 15MHz

Mode	TX channel 66511 (2117.5MHz)	Frequency Range	1GHz~26GHz
Environmental Conditions	23deg. C, 68%RH	Input Power	120Vac, 60Hz
Tested By	Greg Lin		

Antenna Polarity & Test Distance: Horizontal at 3 M							
No.	Freq. (MHz)	Reading (dBm)	S.G Power Value (dBm)	Correction Factor (dB)	EIRP (dBm)	Limit (dBm)	Margin (dB)
1	4235.00	-56.4	-47.7	1.0	-46.7	-13.0	-33.7
Antenna Polarity & Test Distance: Vertical at 3 M							
No.	Freq. (MHz)	Reading (dBm)	S.G Power Value (dBm)	Correction Factor (dB)	EIRP (dBm)	Limit (dBm)	Margin (dB)
1	4235.00	-54.8	-45.1	1.0	-44.1	-13.0	-31.1

Remarks:

1. EIRP (dBm) = S.G Value (dBm) + Correction Factor (dB).
2. Correction Factor (dB) = Substitution Antenna Gain (dB) + Cable Loss (dB).

Mode	TX channel 66786 (2145.0MHz)	Frequency Range	1GHz~26GHz
Environmental Conditions	23deg. C, 68%RH	Input Power	120Vac, 60Hz
Tested By	Greg Lin		

Antenna Polarity & Test Distance: Horizontal at 3 M							
No.	Freq. (MHz)	Reading (dBm)	S.G Power Value (dBm)	Correction Factor (dB)	EIRP (dBm)	Limit (dBm)	Margin (dB)
1	4290.00	-56.1	-47.1	1.1	-46.0	-13.0	-33.0
Antenna Polarity & Test Distance: Vertical at 3 M							
No.	Freq. (MHz)	Reading (dBm)	S.G Power Value (dBm)	Correction Factor (dB)	EIRP (dBm)	Limit (dBm)	Margin (dB)
1	4290.00	-54.5	-45.1	1.1	-44.0	-13.0	-31.0

Remarks:

1. EIRP (dBm) = S.G Value (dBm) + Correction Factor (dB).
2. Correction Factor (dB) = Substitution Antenna Gain (dB) + Cable Loss (dB).

Mode	TX channel 67061 (2172.5MHz)	Frequency Range	1GHz~26GHz
Environmental Conditions	23deg. C, 68%RH	Input Power	120Vac, 60Hz
Tested By	Greg Lin		

Antenna Polarity & Test Distance: Horizontal at 3 M							
No.	Freq. (MHz)	Reading (dBm)	S.G Power Value (dBm)	Correction Factor (dB)	EIRP (dBm)	Limit (dBm)	Margin (dB)
1	4345.00	-56.2	-46.6	1.0	-45.6	-13.0	-32.6
Antenna Polarity & Test Distance: Vertical at 3 M							
No.	Freq. (MHz)	Reading (dBm)	S.G Power Value (dBm)	Correction Factor (dB)	EIRP (dBm)	Limit (dBm)	Margin (dB)
1	4345.00	-54.5	-45.1	1.0	-44.1	-13.0	-31.1

Remarks:

1. EIRP (dBm) = S.G Value (dBm) + Correction Factor (dB).
2. Correction Factor (dB) = Substitution Antenna Gain (dB) + Cable Loss (dB).

Channel Bandwidth: 20MHz

Mode	TX channel 66536 (2120.0MHz)	Frequency Range	1GHz~26GHz
Environmental Conditions	23deg. C, 68%RH	Input Power	120Vac, 60Hz
Tested By	Greg Lin		

Antenna Polarity & Test Distance: Horizontal at 3 M							
No.	Freq. (MHz)	Reading (dBm)	S.G Power Value (dBm)	Correction Factor (dB)	EIRP (dBm)	Limit (dBm)	Margin (dB)
1	4240.00	-53.6	-44.9	1.0	-43.9	-13.0	-30.9
Antenna Polarity & Test Distance: Vertical at 3 M							
No.	Freq. (MHz)	Reading (dBm)	S.G Power Value (dBm)	Correction Factor (dB)	EIRP (dBm)	Limit (dBm)	Margin (dB)
1	4240.00	-51.8	-42.2	1.0	-41.2	-13.0	-28.2

Remarks:

1. EIRP (dBm) = S.G Value (dBm) + Correction Factor (dB).
2. Correction Factor (dB) = Substitution Antenna Gain (dB) + Cable Loss (dB).

Mode	TX channel 66786 (2145.0MHz)	Frequency Range	1GHz~26GHz
Environmental Conditions	23deg. C, 68%RH	Input Power	120Vac, 60Hz
Tested By	Greg Lin		

Antenna Polarity & Test Distance: Horizontal at 3 M							
No.	Freq. (MHz)	Reading (dBm)	S.G Power Value (dBm)	Correction Factor (dB)	EIRP (dBm)	Limit (dBm)	Margin (dB)
1	4290.00	-53.5	-44.5	1.1	-43.4	-13.0	-30.4
Antenna Polarity & Test Distance: Vertical at 3 M							
No.	Freq. (MHz)	Reading (dBm)	S.G Power Value (dBm)	Correction Factor (dB)	EIRP (dBm)	Limit (dBm)	Margin (dB)
1	4290.00	-52.1	-42.7	1.1	-41.6	-13.0	-28.6

Remarks:

1. EIRP (dBm) = S.G Value (dBm) + Correction Factor (dB).
2. Correction Factor (dB) = Substitution Antenna Gain (dB) + Cable Loss (dB).

Mode	TX channel 67036 (2170.0MHz)	Frequency Range	1GHz~26GHz
Environmental Conditions	23deg. C, 68%RH	Input Power	120Vac, 60Hz
Tested By	Greg Lin		

Antenna Polarity & Test Distance: Horizontal at 3 M							
No.	Freq. (MHz)	Reading (dBm)	S.G Power Value (dBm)	Correction Factor (dB)	EIRP (dBm)	Limit (dBm)	Margin (dB)
1	4340.00	-53.6	-44.0	1.0	-43.0	-13.0	-30.0
Antenna Polarity & Test Distance: Vertical at 3 M							
No.	Freq. (MHz)	Reading (dBm)	S.G Power Value (dBm)	Correction Factor (dB)	EIRP (dBm)	Limit (dBm)	Margin (dB)
1	4340.00	-51.7	-42.3	1.0	-41.3	-13.0	-28.3

Remarks:

1. EIRP (dBm) = S.G Value (dBm) + Correction Factor (dB).
2. Correction Factor (dB) = Substitution Antenna Gain (dB) + Cable Loss (dB).

QPSK_IoT Signal at Top

Channel Bandwidth: 10MHz

Mode	TX channel 66486 (2115.0MHz)	Frequency Range	1GHz~26GHz
Environmental Conditions	23deg. C, 68%RH	Input Power	120Vac, 60Hz
Tested By	Greg Lin		

Antenna Polarity & Test Distance: Horizontal at 3 M							
No.	Freq. (MHz)	Reading (dBm)	S.G Power Value (dBm)	Correction Factor (dB)	EIRP (dBm)	Limit (dBm)	Margin (dB)
1	4230.00	-56.3	-47.6	1.0	-46.6	-13.0	-33.6
Antenna Polarity & Test Distance: Vertical at 3 M							
No.	Freq. (MHz)	Reading (dBm)	S.G Power Value (dBm)	Correction Factor (dB)	EIRP (dBm)	Limit (dBm)	Margin (dB)
1	4230.00	-54.9	-45.2	1.0	-44.2	-13.0	-31.2

Remarks:

1. EIRP (dBm) = S.G Value (dBm) + Correction Factor (dB).
2. Correction Factor (dB) = Substitution Antenna Gain (dB) + Cable Loss (dB).

Mode	TX channel 66786 (2145.0MHz)	Frequency Range	1GHz~26GHz
Environmental Conditions	23deg. C, 68%RH	Input Power	120Vac, 60Hz
Tested By	Greg Lin		

Antenna Polarity & Test Distance: Horizontal at 3 M							
No.	Freq. (MHz)	Reading (dBm)	S.G Power Value (dBm)	Correction Factor (dB)	EIRP (dBm)	Limit (dBm)	Margin (dB)
1	4290.00	-55.9	-46.9	1.1	-45.8	-13.0	-32.8
Antenna Polarity & Test Distance: Vertical at 3 M							
No.	Freq. (MHz)	Reading (dBm)	S.G Power Value (dBm)	Correction Factor (dB)	EIRP (dBm)	Limit (dBm)	Margin (dB)
1	4290.00	-54.7	-45.3	1.1	-44.2	-13.0	-31.2

Remarks:

1. EIRP (dBm) = S.G Value (dBm) + Correction Factor (dB).
2. Correction Factor (dB) = Substitution Antenna Gain (dB) + Cable Loss (dB).

Mode	TX channel 67086 (2175.0MHz)	Frequency Range	1GHz~26GHz
Environmental Conditions	23deg. C, 68%RH	Input Power	120Vac, 60Hz
Tested By	Greg Lin		

Antenna Polarity & Test Distance: Horizontal at 3 M							
No.	Freq. (MHz)	Reading (dBm)	S.G Power Value (dBm)	Correction Factor (dB)	EIRP (dBm)	Limit (dBm)	Margin (dB)
1	4350.00	-56.5	-46.8	1.0	-45.8	-13.0	-32.8
Antenna Polarity & Test Distance: Vertical at 3 M							
No.	Freq. (MHz)	Reading (dBm)	S.G Power Value (dBm)	Correction Factor (dB)	EIRP (dBm)	Limit (dBm)	Margin (dB)
1	4350.00	-56.1	-46.8	1.0	-45.8	-13.0	-32.8

Remarks:

1. EIRP (dBm) = S.G Value (dBm) + Correction Factor (dB).
2. Correction Factor (dB) = Substitution Antenna Gain (dB) + Cable Loss (dB).

Channel Bandwidth: 15MHz

Mode	TX channel 66511 (2117.5MHz)	Frequency Range	1GHz~26GHz
Environmental Conditions	23deg. C, 68%RH	Input Power	120Vac, 60Hz
Tested By	Greg Lin		

Antenna Polarity & Test Distance: Horizontal at 3 M							
No.	Freq. (MHz)	Reading (dBm)	S.G Power Value (dBm)	Correction Factor (dB)	EIRP (dBm)	Limit (dBm)	Margin (dB)
1	4235.00	-56.1	-47.4	1.0	-46.4	-13.0	-33.4
Antenna Polarity & Test Distance: Vertical at 3 M							
No.	Freq. (MHz)	Reading (dBm)	S.G Power Value (dBm)	Correction Factor (dB)	EIRP (dBm)	Limit (dBm)	Margin (dB)
1	4235.00	-54.5	-44.8	1.0	-43.8	-13.0	-30.8

Remarks:

1. EIRP (dBm) = S.G Value (dBm) + Correction Factor (dB).
2. Correction Factor (dB) = Substitution Antenna Gain (dB) + Cable Loss (dB).

Mode	TX channel 66786 (2145.0MHz)	Frequency Range	1GHz~26GHz
Environmental Conditions	23deg. C, 68%RH	Input Power	120Vac, 60Hz
Tested By	Greg Lin		

Antenna Polarity & Test Distance: Horizontal at 3 M							
No.	Freq. (MHz)	Reading (dBm)	S.G Power Value (dBm)	Correction Factor (dB)	EIRP (dBm)	Limit (dBm)	Margin (dB)
1	4290.00	-55.8	-46.8	1.1	-45.7	-13.0	-32.7
Antenna Polarity & Test Distance: Vertical at 3 M							
No.	Freq. (MHz)	Reading (dBm)	S.G Power Value (dBm)	Correction Factor (dB)	EIRP (dBm)	Limit (dBm)	Margin (dB)
1	4290.00	-54.2	-44.8	1.1	-43.7	-13.0	-30.7

Remarks:

1. EIRP (dBm) = S.G Value (dBm) + Correction Factor (dB).
2. Correction Factor (dB) = Substitution Antenna Gain (dB) + Cable Loss (dB).

Mode	TX channel 67061 (2172.5MHz)	Frequency Range	1GHz~26GHz
Environmental Conditions	23deg. C, 68%RH	Input Power	120Vac, 60Hz
Tested By	Greg Lin		

Antenna Polarity & Test Distance: Horizontal at 3 M							
No.	Freq. (MHz)	Reading (dBm)	S.G Power Value (dBm)	Correction Factor (dB)	EIRP (dBm)	Limit (dBm)	Margin (dB)
1	4345.00	-55.8	-46.2	1.0	-45.2	-13.0	-32.2
Antenna Polarity & Test Distance: Vertical at 3 M							
No.	Freq. (MHz)	Reading (dBm)	S.G Power Value (dBm)	Correction Factor (dB)	EIRP (dBm)	Limit (dBm)	Margin (dB)
1	4345.00	-53.9	-44.5	1.0	-43.5	-13.0	-30.5

Remarks:

1. EIRP (dBm) = S.G Value (dBm) + Correction Factor (dB).
2. Correction Factor (dB) = Substitution Antenna Gain (dB) + Cable Loss (dB).

Channel Bandwidth: 20MHz

Mode	TX channel 66536 (2120.0MHz)	Frequency Range	1GHz~26GHz
Environmental Conditions	23deg. C, 68%RH	Input Power	120Vac, 60Hz
Tested By	Greg Lin		

Antenna Polarity & Test Distance: Horizontal at 3 M							
No.	Freq. (MHz)	Reading (dBm)	S.G Power Value (dBm)	Correction Factor (dB)	EIRP (dBm)	Limit (dBm)	Margin (dB)
1	4240.00	-53.3	-44.6	1.0	-43.6	-13.0	-30.6
Antenna Polarity & Test Distance: Vertical at 3 M							
No.	Freq. (MHz)	Reading (dBm)	S.G Power Value (dBm)	Correction Factor (dB)	EIRP (dBm)	Limit (dBm)	Margin (dB)
1	4240.00	-51.6	-42.0	1.0	-41.0	-13.0	-28.0

Remarks:

1. EIRP (dBm) = S.G Value (dBm) + Correction Factor (dB).
2. Correction Factor (dB) = Substitution Antenna Gain (dB) + Cable Loss (dB).

Mode	TX channel 66786 (2145.0MHz)	Frequency Range	1GHz~26GHz
Environmental Conditions	23deg. C, 68%RH	Input Power	120Vac, 60Hz
Tested By	Greg Lin		

Antenna Polarity & Test Distance: Horizontal at 3 M							
No.	Freq. (MHz)	Reading (dBm)	S.G Power Value (dBm)	Correction Factor (dB)	EIRP (dBm)	Limit (dBm)	Margin (dB)
1	4290.00	-53.3	-44.3	1.1	-43.2	-13.0	-30.2
Antenna Polarity & Test Distance: Vertical at 3 M							
No.	Freq. (MHz)	Reading (dBm)	S.G Power Value (dBm)	Correction Factor (dB)	EIRP (dBm)	Limit (dBm)	Margin (dB)
1	4290.00	-51.8	-42.4	1.1	-41.3	-13.0	-28.3

Remarks:

1. EIRP (dBm) = S.G Value (dBm) + Correction Factor (dB).
2. Correction Factor (dB) = Substitution Antenna Gain (dB) + Cable Loss (dB).

Mode	TX channel 67036 (2170.0MHz)	Frequency Range	1GHz~26GHz
Environmental Conditions	23deg. C, 68%RH	Input Power	120Vac, 60Hz
Tested By	Greg Lin		

Antenna Polarity & Test Distance: Horizontal at 3 M							
No.	Freq. (MHz)	Reading (dBm)	S.G Power Value (dBm)	Correction Factor (dB)	EIRP (dBm)	Limit (dBm)	Margin (dB)
1	4340.00	-53.4	-43.8	1.0	-42.8	-13.0	-29.8
Antenna Polarity & Test Distance: Vertical at 3 M							
No.	Freq. (MHz)	Reading (dBm)	S.G Power Value (dBm)	Correction Factor (dB)	EIRP (dBm)	Limit (dBm)	Margin (dB)
1	4340.00	-51.4	-42.0	1.0	-41.0	-13.0	-28.0

Remarks:

1. EIRP (dBm) = S.G Value (dBm) + Correction Factor (dB).
2. Correction Factor (dB) = Substitution Antenna Gain (dB) + Cable Loss (dB).

5 Pictures of Test Arrangements

Please refer to the attached file (Test Setup Photo).

Appendix – Information of the Testing Laboratories

We, Bureau Veritas Consumer Products Services (H.K.) Ltd., Taoyuan Branch, were founded in 1988 to provide our best service in EMC, Radio, Telecom and Safety consultation. Our laboratories are accredited and approved according to ISO/IEC 17025.

If you have any comments, please feel free to contact us at the following:

Lin Kou EMC/RF Lab

Tel: 886-2-26052180

Fax: 886-2-26051924

Hsin Chu EMC/RF Lab/Telecom Lab

Tel: 886-3-6668565

Fax: 886-3-6668323

Hwa Ya EMC/RF/Safety

Tel: 886-3-3183232

Fax: 886-3-3270892

Email: service.adt@tw.bureauveritas.com

Web Site: www.bureauveritas-adt.com

The address and road map of all our labs can be found in our web site also.

--- END ---