

Global Product Compliance Laboratory
600-700 Mountain Avenue
Room 5B-108
Murray Hill, New Jersey 07974-0636 USA

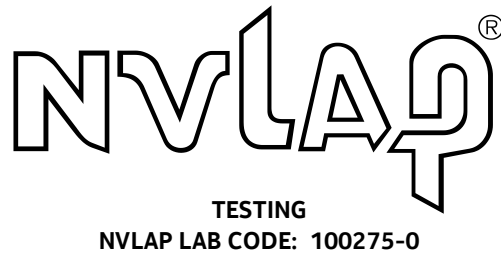

Title 47 Code of Federal Regulations Test Report

Regulation:

FCC Part 2 and 24

Client:

NOKIA SOLUTIONS AND NETWORKS OY

Product Evaluated:

MBO B2 NB-IoT Inband and Guardband

Report Number:

TR-2020-0055-FCC2-24

Date Issued:

May 29, 2020

This report shall not be reproduced, in whole or in part without the approval of Nokia Global Product Compliance Laboratory. This report must not be used by the recipient to claim product endorsement by NVLAP or any other agency of the U.S. Government.

Table of Contents

- 1. SYSTEM INFORMATION AND REQUIREMENTS 4**
 - 1.1 INTRODUCTION 5
 - 1.2 PURPOSE AND SCOPE 5
 - 1.3 EUT DETAILS 5
 - 1.4 TEST REQUIREMENTS..... 7
 - 1.5 STANDARDS & PROCEDURES 7
 - 1.6 EXECUTIVE SUMMARY 9
 - 1.7 TEST CONFIGURATION FOR ALL ANTENNA PORT MEASUREMENTS. 9
- 2. FCC SECTION 2.1046 - RF POWER OUTPUT 10**
 - 2.1 RF POWER OUTPUT..... 10
- 3. FCC SECTION 2.1047 - MODULATION CHARACTERISTICS 13**
 - 3.1 MODULATION CHARACTERISTICS..... 13
- 4. FCC SECTION 2.1049 – OCCUPIED BANDWIDTH/EDGE OF BAND EMISSIONS..... 14**
 - 4.1 OCCUPIED BANDWIDTH..... 14
 - 4.2 EDGE OF BAND EMISSIONS..... 16
- 5. FCC SECTION 2.1051 - SPURIOUS EMISSIONS AT TRANSMIT ANTENNA PORT..... 18**
 - 5.1 MEASUREMENT OF SPURIOUS EMISSIONS AT TRANSMIT ANTENNA PORT..... 18
- 6. FCC SECTION 2.1053 - FIELD STRENGTH OF SPURIOUS RADIATION. 22**
 - 6.1 SECTION 2.1053 FIELD STRENGTH OF SPURIOUS EMISSIONS 22
 - 6.2 FIELD STRENGTH OF SPURIOUS EMISSIONS - LIMITS 22
- 7. NVLAP CERTIFICATE OF ACCREDITATION 23**

Revisions

Date	Revision	Section	Change
05/29/2020	0		Initial Release

Nokia Global Product Compliance Laboratories is accredited by the National Voluntary Laboratory Accreditation Program (NVLAP®) for specific services, listed on the Scope of Accreditation, for: Electromagnetic Compatibility and Telecommunications. This laboratory is accredited in accordance with the recognized International Standard ISO/IEC 17025:2005. This accreditation demonstrates technical competence for a defined scope and the operation of a laboratory quality management system (refer to joint ISO-ILAC-IAF Communiqué dated January 2009). NVLAP LAB CODE: 100275-0.

Nokia Global Product Compliance Laboratory represents to the client that the laboratory’s accreditation or any of its calibration or test reports in no way constitutes or implies product certification, approval, or endorsement by NVLAP, NIST, or any agency of the federal government.

Prepared By:

Signed: Mark Nguyen 05/29/2020
Mark Nguyen
Compliance Engineer
NVLAP Signatory
mark.nguyen@nokia-bell-labs.com

Approved By:

Signed: Raymond Johnson 05/29/2020
Raymond Johnson
Technical Manager
NVLAP Signatory
ray.johnson@nokia-bell-labs.com

Reviewed By:

Signed: Steve Gordon 05/29/2020
Steve Gordon
EMC Engineer
NVLAP Signatory
steve.gordon@nokia-bell-labs.com

1. System Information and Requirements

Report copies and other information not contained in this report are held by either the product engineer or in an identified file at the Global Product Compliance Laboratory in Murray-Hill, NJ.

Equipment Under Test (EUT):	MBO B2 NB-IoT Inband and Guardband
FCC ID:	2AD8UFW2FMBOM1
Serial Number:	EB172311902
Hardware Version:	473866A.101
Software Version:	FLF19
Frequency Range:	1930 – 1995 MHz
GPCL Project Number:	2020-0055
Manufacturer:	NOKIA SOLUTIONS AND NETWORKS OY KARAKAARI 7, FI-02610 ESPOO FINLAND
Test Requirement(s):	Title 47 CFR Parts 2 and 24
Test Standards:	<ul style="list-style-type: none"> • Title 47 CFR Parts 2 and 24 • KDB 971168 D01 Power Measurement License Digital Systems v03r01 April 9, 2018. • KDB 662911 D01 Multiple Transmitter Output v02r01 Oct 2013 • ANSI C63.26 (2015) • ANSI C63.4 (2014)
Measurement Procedure(s):	<ul style="list-style-type: none"> • FCC-IC-OB - GPCL Occupied Bandwidth and Power Measurement Test Procedure 12-4-2017 • FCC-IC-SE - GPCL Spurious Emissions Test Procedure 12-4-2017
Test Date(s):	May 2020
Test Performed By:	Nokia Global Product Compliance Laboratory 600-700 Mountain Ave. P.O. Box 636 Murray Hill, NJ 07974-0636
Product Engineer(s):	Jeff Webb
Lead Engineer:	Steve Gordon
Test Engineer (s):	Nilesh Patel
Test Results: The EUT, <i>as tested</i> met the above listed requirements. Report copies and other information not contained in this report are held by either the product engineer or in an identified file at the Global Product Compliance Laboratory in New Providence, NJ.	

1.1 Introduction

This Conformity test report applies to the: MBO B2 NB-IoT Inband and Guardband, hereinafter referred to as the Equipment Under Test (EUT).

1.2 Purpose and Scope

The purpose of this document is to provide the testing data required for qualifying the EUT in compliance with FCC Parts 2 and 24 measured in accordance with the procedures set out in Section 2.1033 (c) (14) of the Rules.

The EUT was tested for Class II Permissive to add NB IoT In Band and Guard Band to the 2AD8UFW2FMBOM1 Limited Modular Approval Grant. This B2 project adds NB-IoT Inband for 5 MHz Bandwidth and NB-IoT Inband and Guard Band for 15 MHz bandwidth. The NB-IoT operation is for QPSK modulation only. This B2 module was previously tested and FCC approved for NB-IoT for 10 and 20 MHz carriers using QPSK modulation (Test Report: TR-2019-0015-FCC2-24).

There were no changes to the basic frequency determining and stabilizing circuitry therefore no Frequency Stability testing was considered necessary.

1.3 EUT Details

1.3.1 Specifications

Specification Items	Description		
Radio Access Technology	LTE-FDD		
Duplex Mode	FDD		
Modulation Type(s)	QPSK (TM1.1 Test Model)		
Operation Frequency Range	Tx: 1930 – 1995 MHz		
Channel Bandwidth	IB 5 & 15 MHz / GB 15 MHz		
Number of Tx Ports per Unit	2		
Number of Rx Ports Per Unit	2		
MIMO	Yes		
Max Conducted Power	5Wrms (37dBm) per port		
Deployment Environment	Outdoor		
Environment Temperature Range	-40 °C to 55 °C		
Power Source	Voltage Ranges (VAC)		
	Minimum	Nominal	Maximum
	90.0	110.0	264.0

1.3.2 Photographs

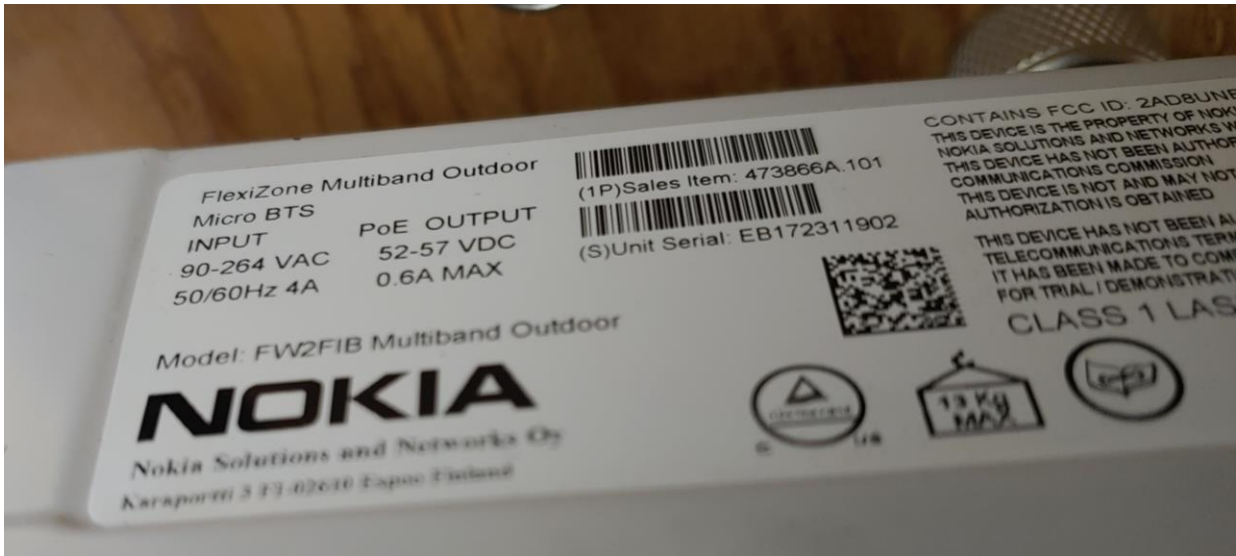

1.4 Test Requirements

Each required measurement is listed below:

47 CFR FCC Sections	Description of Tests	Test Required
2.1046, 24.238	RF Power Output	Yes
2.1047, 24.238	Modulation Characteristics	Yes
2.1049, 24.238	(a) Occupied Bandwidth (b) Out-of-Band Emissions	Yes
2.1051, 24.238	Spurious Emissions at Antenna Terminals	Yes
2.1053, 24.238	Field Strength of Spurious Radiation	Yes
2.1055, 24.238	Frequency Stability	No*

*Refer to section 1.2 for explanation

1.5 Standards & Procedures

1.5.1 Standards

- Title 47 Code of Federal Regulations, Federal Communications Commission Part 2.
- Title 47 Code of Federal Regulations, Federal Communications Commission Part 24.
- ANSI C63.26, American National Standard for Compliance Testing of Transmitters Used in Licensed Radio Services

1.5.2 Procedures

1. FCC-IC-0B and FCC-IC-SE
2. ANSI C63.4 (2014) entitled: “American National Standard for Methods of Measurement of Radio-Noise Emissions from Low Voltage Electrical and Electronic Equipment in the Range of 9kHz to 40 GHz”, American National Standards Institute, Institute of Electrical and Electronic Engineers, Inc., New York, NY 10017-2394, USA.
3. FCC KDB 971168 D01 Power Measurement License Digital Systems v03r01 April 9, 2018.
 FCC KDB 662911 D01 Multiple Transmitter Output v02r01 Oct 2013

1.5.3 MEASUREMENT UNCERTAINTY

The results of the calculations to estimate uncertainties for the several test methods and standards are shown in the Table below. These are the worst-case values.

Worst-Case Estimated Measurement Uncertainties

Standard, Method or Procedure	Condition	Frequency MHz	Expanded Uncertainty (k=2)
a. Classical Emissions, (<i>e.g.</i> , ANSI C63.4, CISPR 11, 14, 22, <i>etc.</i> , using ESHS 30,	Conducted Emissions	0.009 - 30	±3.5 dB
	Radiated Emissions (AR-6 Semi-Anechoic Chamber)	30 MHz – 200MHz H 30 MHz – 200 MHz V 200 MHz – 1000 MHz H 200 MHz – 1000 MHz V 1 GHz - 18 GHz	±5.1 dB ±5.1 dB ±4.7 dB ±4.7 dB ±3.3 dB

Antenna Port Test	Signal Bandwidth	Frequency Range	Expanded Uncertainty (k=2), Amplitude
Occupied Bandwidth, Edge of Band, Conducted Spurious Emissions	10 Hz	9 kHz to 20 MHz	1.78 dB
	100 Hz	20 MHz to 1 GHz	
	10 kHz to 1 MHz	1 GHz to 10 GHz	
	1MHz	10 GHz to 40 GHz:	
RF Power	10 Hz to 20 MHz	50 MHz to 18 GHz	0.5 dB

1.6 Executive Summary

Requirement	Description	Result
47 CFR FCC Parts 2 and 24		
2.1046, 24.238	RF Power Output Peak to Average Power Ratio	COMPLIES
2.1047, 24.238	Modulation Characteristics	COMPLIES
2.1049, 24.238	(a) Occupied Bandwidth (b) Edge of Band Emissions	COMPLIES
2.1051, 24.238	Spurious Emissions at Antenna Terminals	COMPLIES
2.1053, 24.238	Field Strength of Spurious Radiation	COMPLIES
2.1055, 24.238	Frequency Stability	NT*

*Refer to section 1.2 for explanation

1. **COMPLIES** - Passed all applicable tests.
2. **N/A** – Not Applicable.
3. **NT** – Not Tested.

1.7 Test Configuration for all Antenna Port Measurements.

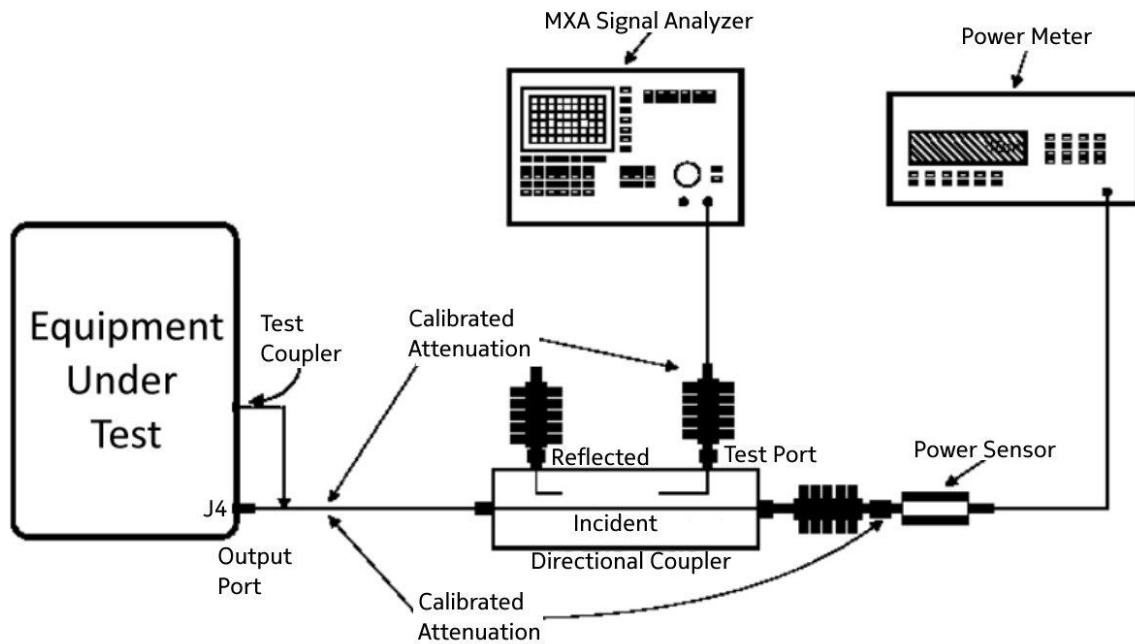

2. FCC Section 2.1046 - RF Power Output

2.1 RF Power Output

This test is a measurement of the total RF power level transmitted at the antenna-transmitting terminal. The product was configured for test as shown in section above and allowed to warm up and stabilize per KDB 971168 D01 and ANSI C63.26.

Power measurements were made with an MXA Signal Analyzer.

Tabular Data – Channel RF Power

Band Class – B2				
Channel Frequency MHz	Signal BW MHz	Inband / Guardband	Modulation	Channel Power dBm
1932.5	5	Inband	QPSK	36.65
1937.5	15	Inband	QPSK	37.13
1937.5	15	Guardband	QPSK	36.87
1982.5	15	Inband	QPSK	37.25
1982.5	15	Guardband	QPSK	37.31
1987.5	5	Inband	QPSK	36.95

NOTE: Only a sample of the plots are used in this report. The full suite of raw data resides at the MH, New Jersey location.

2.1.1 Channel RF Power - Plots

Ch_Power_TM1_1_1C_5MBW_1932_TX1 IB

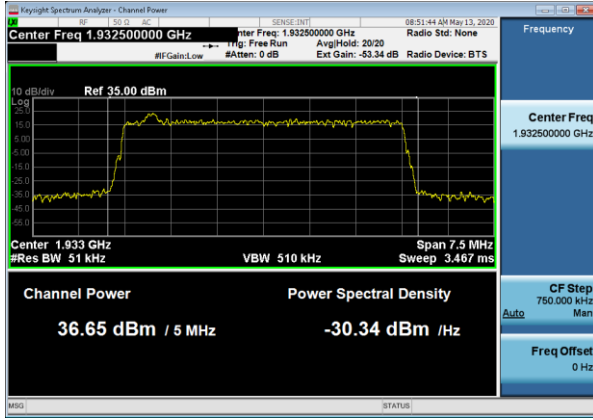

Ch_Power_TM1_1_1C_15MBW_1937_TX1 IB

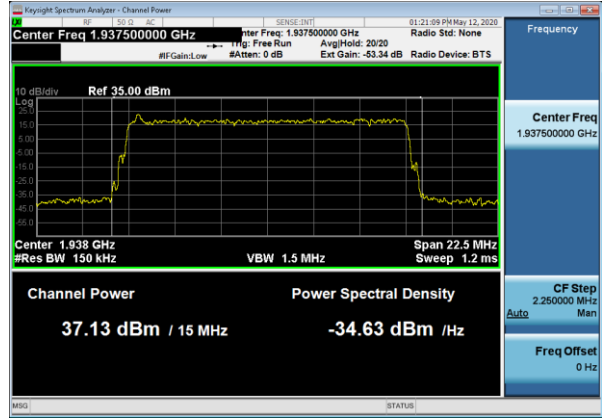

Ch_Power_TM1_1_1C_15MBW_1937_TX1 GB

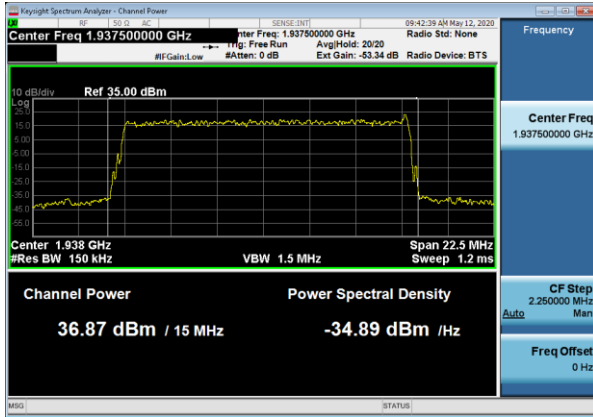

Ch_Power_TM1_1_1C_15MBW_1982_TX1 IB

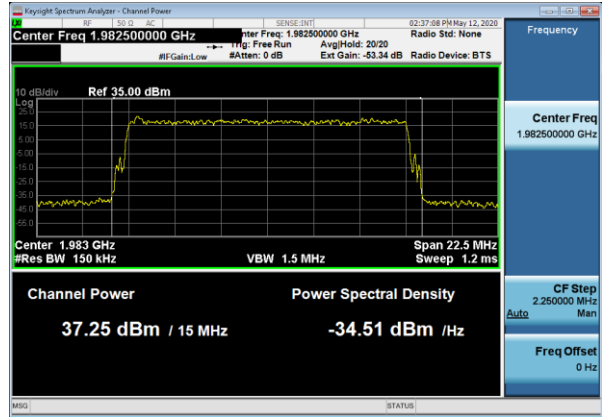

Ch_Power_TM1_1_1C_15MBW_1982_TX1 GB

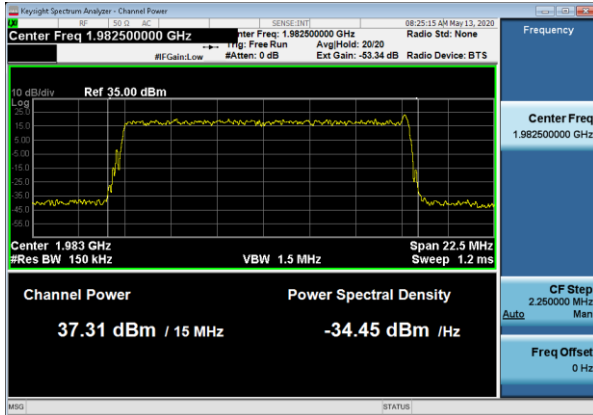

Ch_Power_TM1_1_1C_5MBW_1987_TX1 IB

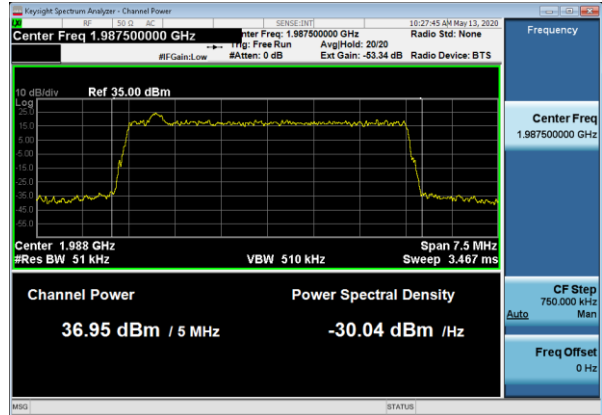

2.1.2 Peak-to-Average Power Ratio (PAPR) - Plots

The Peak-to-Average Power Ratio (PAPR) was evaluated per KDB 971168 for 5MHz and 15MHz bandwidths with QPSK modulation for In Band and Guard Band. The PAPR values of all carriers measured are below 13dB.

PAR_TM1_1_1C_5MBW_1932_TX1 IB_1932

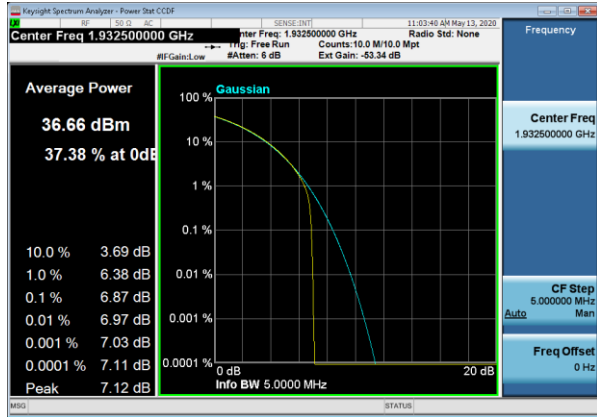

PAR_TM1_1_1C_15MBW_1937_TX1 IB_1937

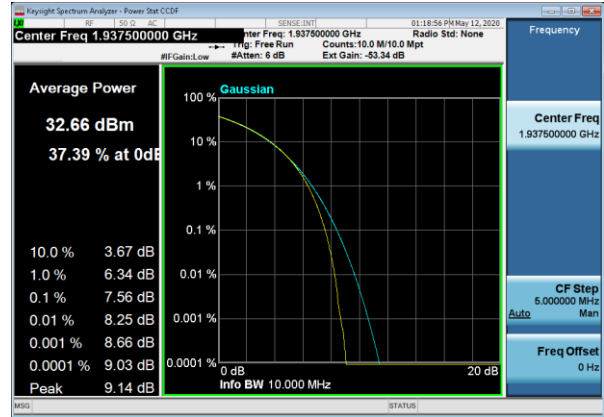

PAR_TM1_1_1C_15MBW_1937_TX1 GB_1937

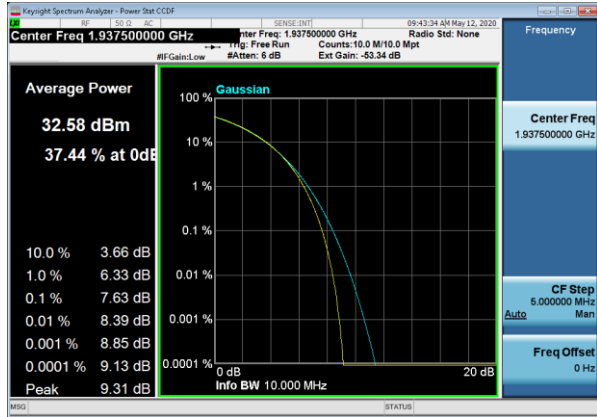

PAR_TM1_1_1C_15MBW_1982_TX1 IB_1982

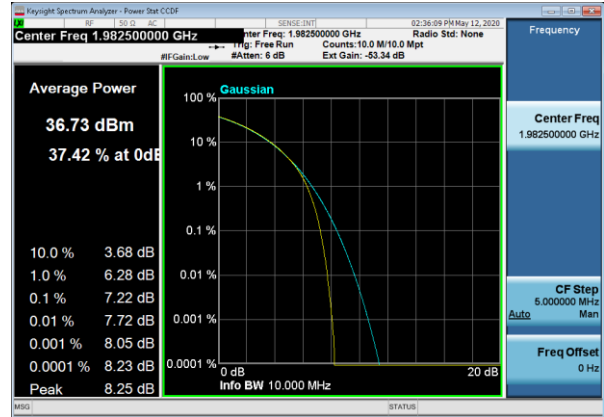

PAR_TM1_1_1C_15MBW_1982_TX1 GB_1982

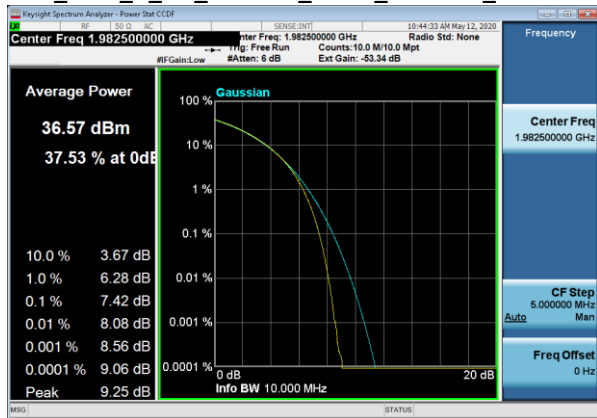

PAR_TM1_1_1C_5MBW_1987_TX1 IB_1987

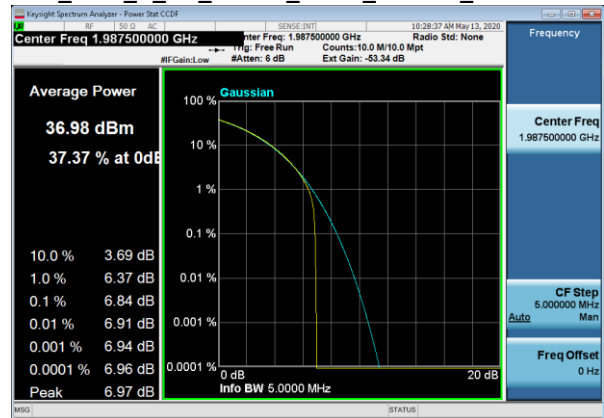

3. FCC Section 2.1047 - Modulation Characteristics

3.1 Modulation Characteristics

The RF signal at the antenna port was demodulated and verified for correctness of the modulation signal used before each test was performed. For these products the operation with QPSK modulation was evaluated and verified to demonstrate proper operation before testing.

3.1.1 Modulation Characteristics – Plots

ModAnalysis_TM1_1_1C_5MBW_1932_TX1 IB_1932

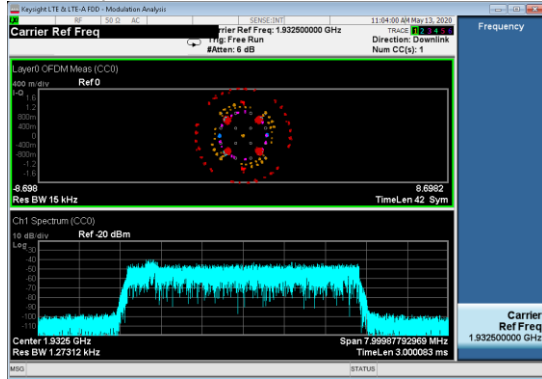

ModAnalysis_TM1_1_1C_15MBW_1937_TX1 IB_1937

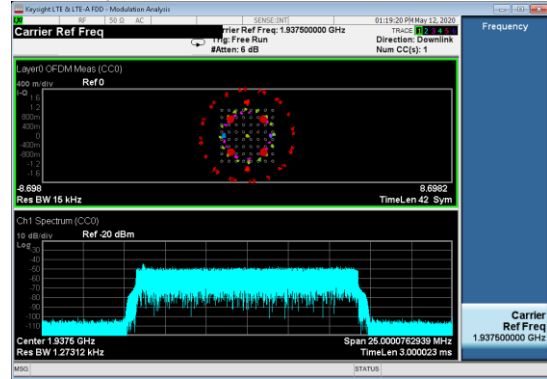

ModAnalysis_TM1_1_1C_15MBW_1937_TX1 GB_1937

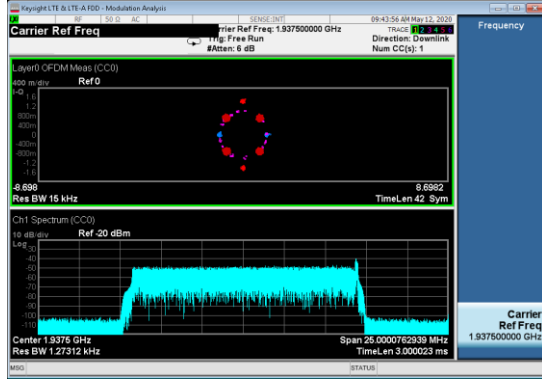

ModAnalysis_TM1_1_1C_15MBW_1982_TX1 IB_1982

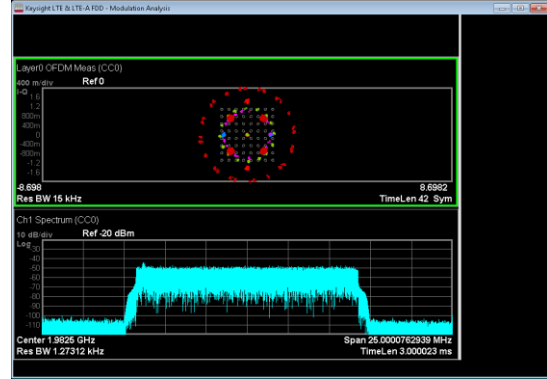

ModAnalysis_TM1_1_1C_5MBW_1987_TX1 IB_1987

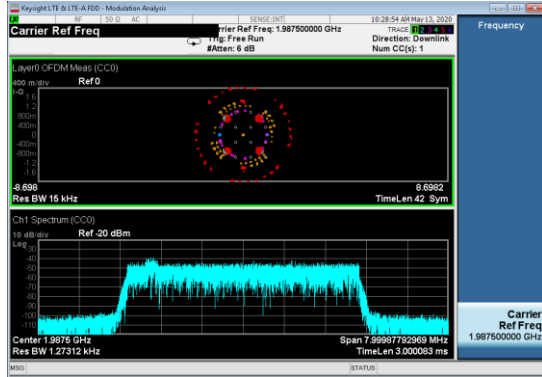

4. FCC Section 2.1049 – Occupied Bandwidth/Edge of Band Emissions

4.1 Occupied Bandwidth

In 47CFR 2.1049 the FCC requires:

“The occupied bandwidth, that is the frequency bandwidth such that, below its lower and above its upper frequency limits, the mean powers radiated are each equal to 0.5 percent of the total mean power radiated by a given emission shall be measured under the following conditions as applicable.”

This required measurement is the 99% Occupied Bandwidth, also called the designated signal bandwidth and needs to be within the parameters of the products specified emissions designator. During these measurements it is customary to evaluate the Edge of Band emissions at block/band edges.

The transmitted signal occupied bandwidth was measured using a Keysight MXA Signal Analyzer. All emissions were within the parameters as required.

Tabular Data – Occupied Bandwidth

Band Class – B2				
Channel Frequency MHz	Signal BW MHz	Inband / Guardband	Modulation	Occupied BW MHz
1932.5	5	Inband	QPSK	4.4730
1937.5	15	Inband	QPSK	13.367
1937.5	15	Guardband	QPSK	13.699
1982.5	15	Inband	QPSK	13.395
1982.5	15	Guardband	QPSK	13.711
1987.5	5	Inband	QPSK	4.4724

4.1.1 Occupied Bandwidth – Plots

OBW_TM1_1_1C_5MBW_1932_TX1 IB_1932

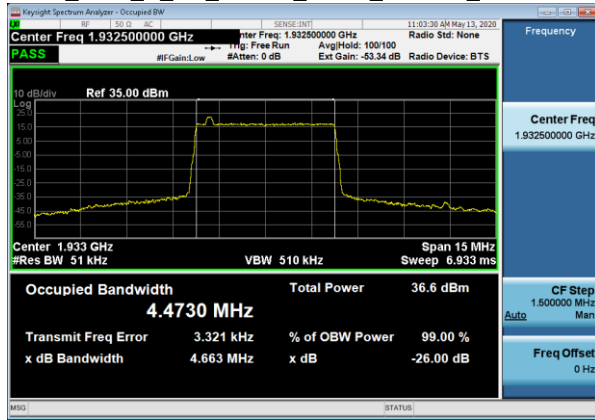

OBW_TM1_1_1C_15MBW_1937_TX1 IB_1937

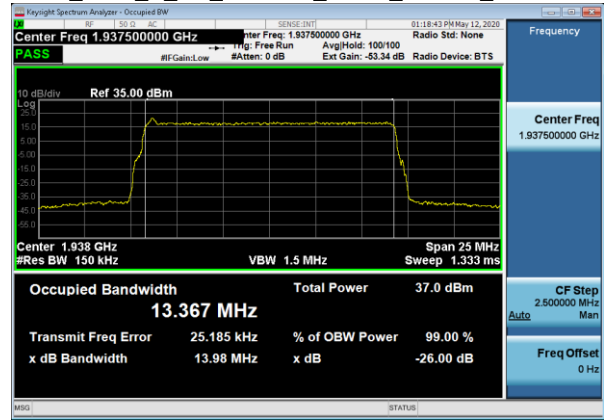

OBW_TM1_1_1C_15MBW_1937_TX1 GB_1937

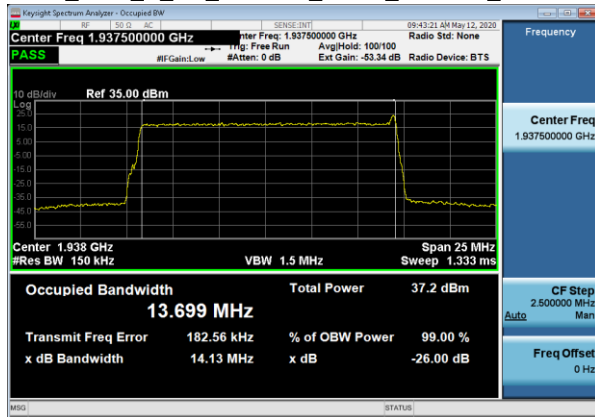

OBW_TM1_1_1C_15MBW_1982_TX1 IB_1982

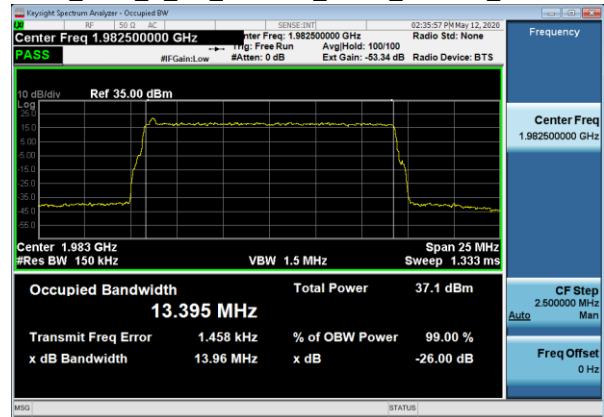

OBW_TM1_1_1C_15MBW_1982_TX1 GB_1982

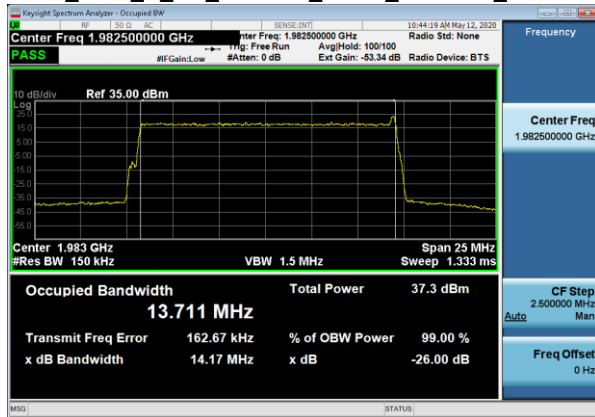

OBW_TM1_1_1C_5MBW_1987_TX1 IB_1987

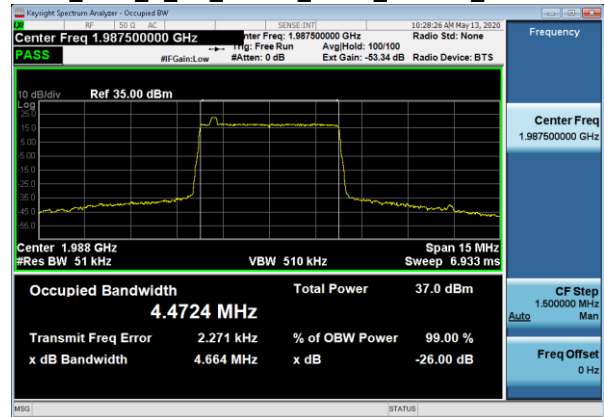

4.2 Edge of band Emissions

The Edge of Band emissions of the EUT at the external antenna connector (EAC) were measured using a Keysight MXA Signal Analyzer. The RF power level was continuously measured using a RF broadband power meter. The RF output from the EAC port to spectrum analyzer was reduced (to an amplitude usable by the spectrum analyzer) by using a calibrated attenuator and test coupler. The path attenuation was offset on the display and the signal for single carrier was adjusted to the corrected RF power level for the resolution bandwidth used for the transmit signal. All mask values were adjusted based upon the designated signal bandwidth and measurement bandwidths. The Top of Mask corresponds to the set rated power level as confirmed by the RF power meter.

4.2.1 Edge of Band Emissions - Plots

All of the measurements met the requirements of Part 24.238 when measured per Part 2.1049.

OOBE_TM1_1_1C_5MBW_1932_TX1 IB

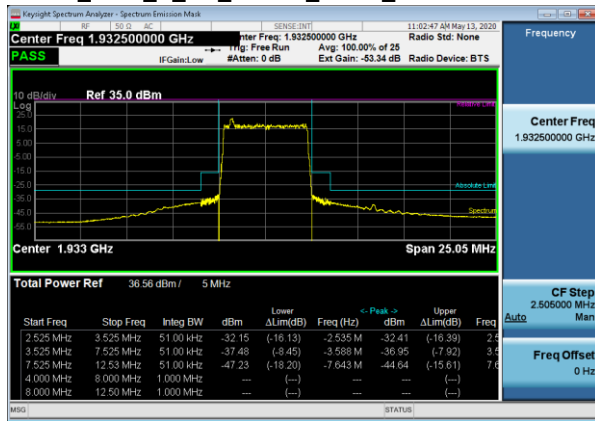

OOBE_TM1_1_1C_15MBW_1937_TX1 IB

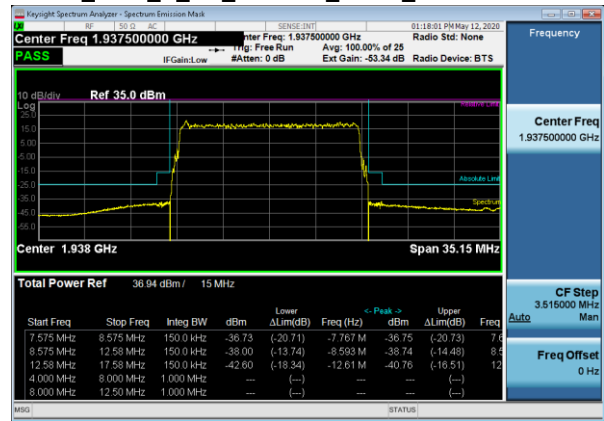

OOBE_TM1_1_1C_15MBW_1937_TX1 GB

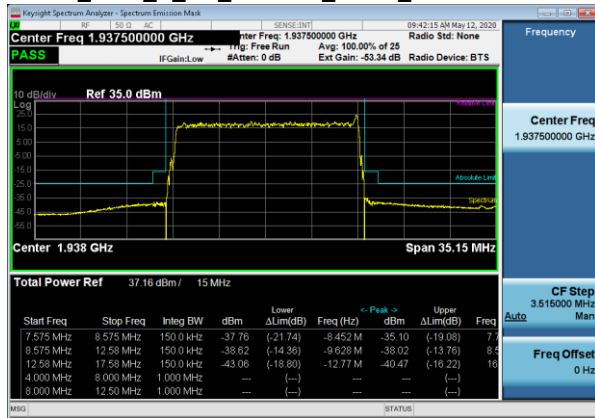

OOBE_TM1_1_1C_15MBW_1937_TX1 IB

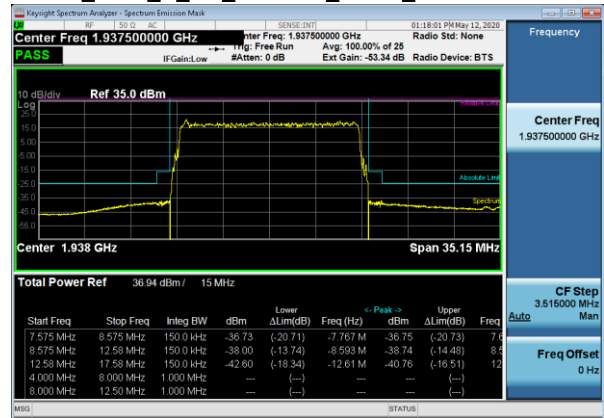

OOBE_TM1_1_1C_15MBW_1937_TX1 GB

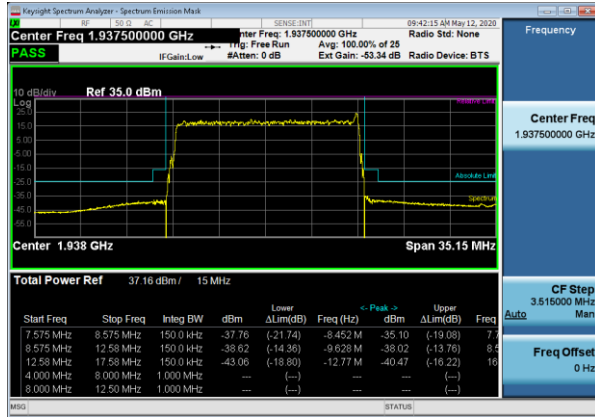

OOBE_TM1_1_1C_5MBW_1987_TX1 IB

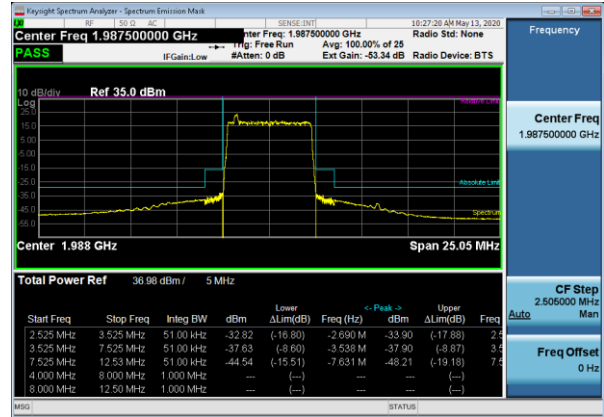

5. FCC Section 2.1051 - Spurious Emissions at Transmit Antenna Port

5.1 Measurement of Spurious Emissions at Transmit Antenna Port

Spurious Emissions at the transmit-antenna terminals were investigated over the frequency range of 10 MHz to beyond the 10th harmonic of the specific transmit band. For this band of operation, the measurements were performed up to 22GHz. Measurements were made using a Keysight MXA Signal Analyzer. The RF output from the transmitter was reduced (to an amplitude usable by the receivers) using calibrated attenuators. The RF power level was continuously monitored via a coupled RF Power Meter.

The required emission limitation is specified as appropriate in 24.238. The measured spurious emission levels were plotted for the frequency range as specified in 2.1057. There were no reportable emissions. Data below documents performance up to 22 GHz.

5.1.1 Spurious Emissions at Tx Port – Plots

NOTE: Only a sample of the plots are used in this report. The full suite of raw data resides at the MH, New Jersey location.

5.1.1.1 QPSK, 15MBW, 1937 MHz, NB-IoT Inband Plots

Spurious_TM1_1_1C_15MBW_1937_TX1 IB_10_to_1000

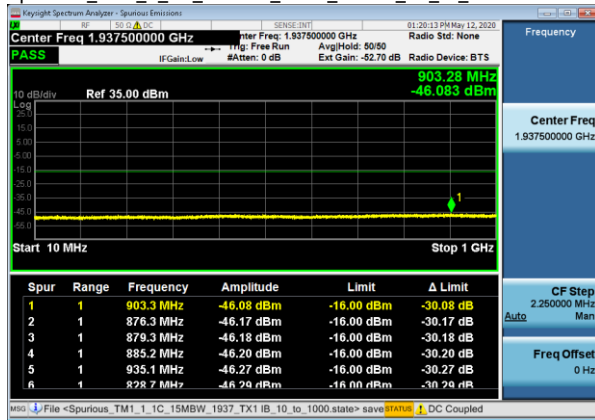

Spurious_TM1_1_1C_15MBW_1937_TX1 IB_1000_to_1930

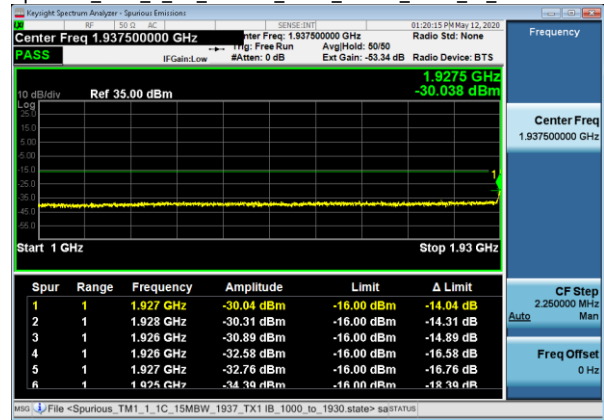

Spurious_TM1_1_1C_15MBW_1937_TX1 GB_1990_to_10000

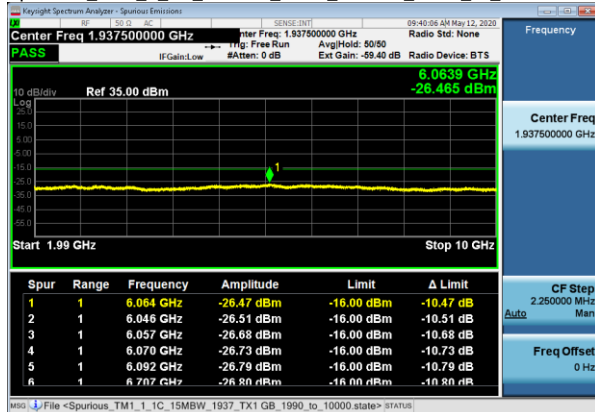

Spurious_TM1_1_1C_15MBW_1937_TX1 GB_10000_to_22000

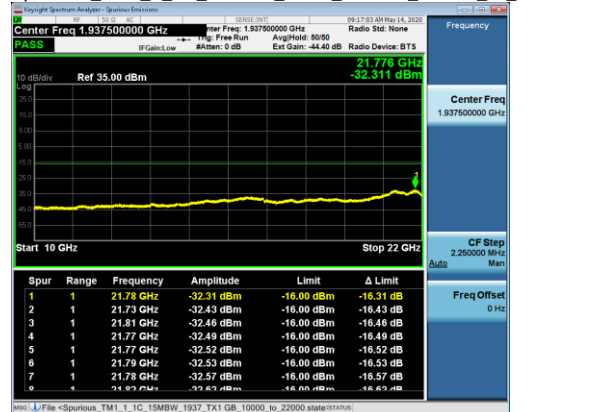

5.1.1.2 QPSK, 15MBW, 1937 MHz, NB-IoT Guardband Plots

Spurious_TM1_1_1C_15MBW_1937_TX1_GB_10_to_1000

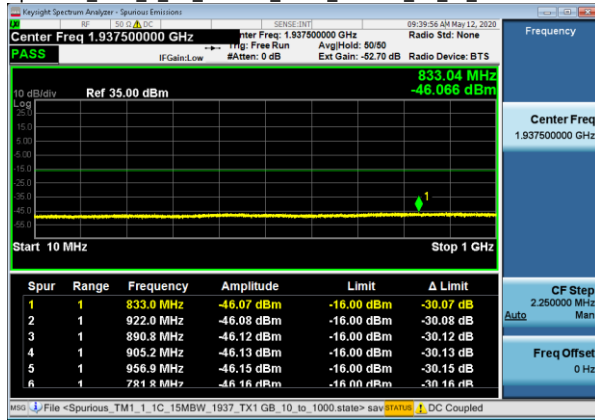

Spurious_TM1_1_1C_15MBW_1937_TX1_GB_1000_to_1930

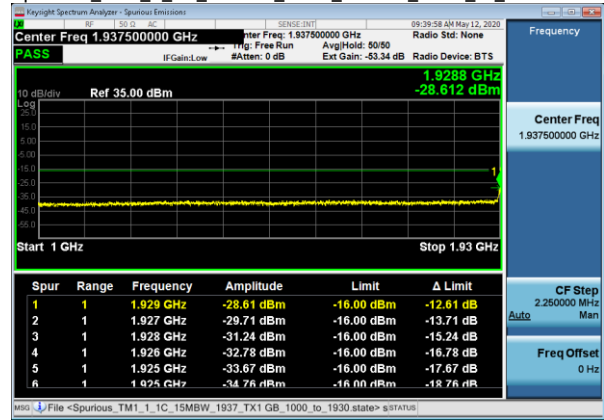

Spurious_TM1_1_1C_15MBW_1937_TX1_GB_1990_to_10000

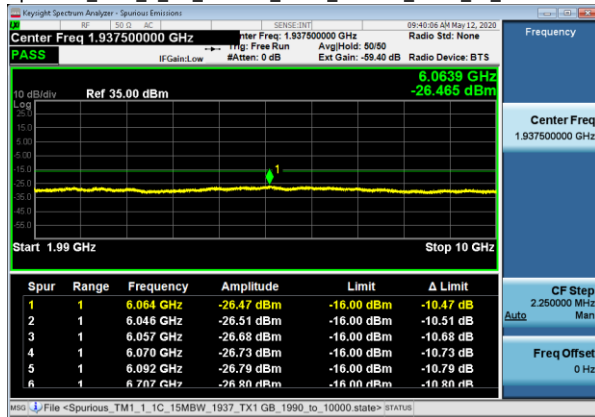

Spurious_TM1_1_1C_15MBW_1937_TX1_GB_10000_to_22000

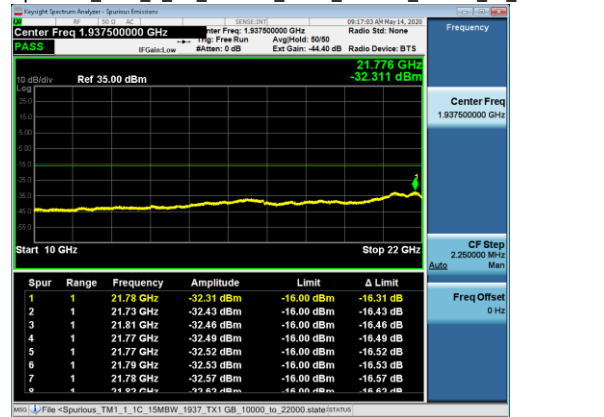

Photographs

Test Setup

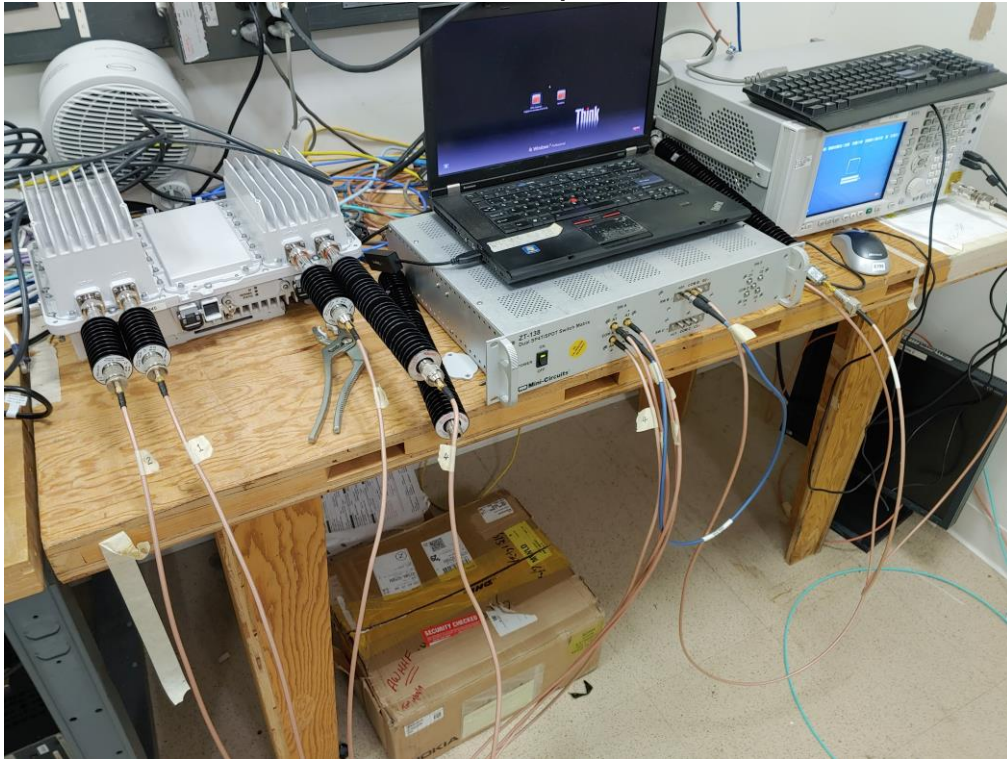

Test Equipment

Asset ID	Manufacturer	Type	Description	Model	Serial	Calibration Date	Calibration Due
E1152	Agilent Technologies	MXA Signal Analyzer	20Hz-26.5GHz Analyzer	N9020A	MY53420147	2019-04-24	2021-04-24
E896	Agilent Technologies	Network Analyzer	10 MHz - 40 GHz	N5230C	MY49000897	2019-01-31	2021-01-31
E1116	Trilithic	Filter, High Pass	2.85 - 18.05 GHz	5HC2850/18050-1.8-KK	200113078	CNR	CNR
E1450	Weinschel	Attenuator	DC - 8.5GHz, 30dB, 50W	24-30-43	BC3952	CNR-V	CNR-V

CNR: Calibration Not Required
 CNR-V: Calibration Not Required; Must be Verified

6. FCC Section 2.1053 - Field strength of spurious radiation.

6.1 Section 2.1053 Field Strength of Spurious Emissions

Field strength measurements of radiated spurious emissions were made in an FCC registered 3m Semi-Anechoic Chamber which is maintained by Nokia Bell Labs in Murray Hill, New Jersey. A complete description and full measurement data for the site is on file with the Commission (Site Registration Number: 515091).

The spectrum from 30 MHz to beyond the tenth harmonic of the carrier, 27 GHz, was searched for spurious radiation. Measurements were made using both horizontally and vertically polarized broadband antennas. Per FCC regulations, the comparison of out of band spurious emissions directly to the limit is appropriately made using the substitution method. However, when the emissions are more than 20 dB below the specification limit, the use of field strength measurements for compliance determination is acceptable and those emissions are considered not reportable (Section 2.1053 and the FCC Interpretive database for 2.1053). For this case the evaluation of acceptable radiated field strength is as follows.

6.2 Field Strength of Spurious Emissions - Limits

Sections 2.1053 and 24.238 contain the requirements for the levels of spurious radiation as a function of the level of the unmodulated carrier. The reference level for the unmodulated carrier is calculated as the field produced by an ideal dipole excited by the transmitter output power according to the following relation taken from Reference Data for Radio Engineers, page 676, 4th edition, IT&T Corp.

$$E = [(30 \cdot P)^{1/2}] / R$$

$$20 \log (E \cdot 10^6) - (43 + 10 \log P) = 82.23 \text{ dB}\mu\text{V/meter}$$

Where:

E = Field Intensity in Volts/meter

P = Transmitted Power in Watts

R = Measurement distance in meters = 3 m

The Part 24 Limit is 82.23 dB μ V/m at 3m and 91.77 dB μ V/m at 1m

The Part 24 non-report level is 62.23 dB μ V/m at 3m.

The calculated emission levels were found by:

$$\text{Measured level (dB}\mu\text{V)} + \text{Cable Loss(dB)} + \text{Antenna Factor(dB)} = \text{Field Strength (dB}\mu\text{V/m)}$$

RESULTS:

For compliance with 47CFR Parts 2 and 24, the field strength of any spurious radiation, measured at 3m, is required to be less than 82.23 dB μ V/meter (82.23 @ 3m). Emissions equal to or less than 62.23 dB μ V/meter at 3m are not reportable and may be verified using field strength measurements and broadband antennas. Over the out of band spectrum investigated from 30 MHz to beyond the tenth harmonic of the carrier (up to 27GHz), no reportable spurious emissions were detected.

7. NVLAP Certificate of Accreditation

United States Department of Commerce
National Institute of Standards and Technology

NVLAP[®]

Certificate of Accreditation to ISO/IEC 17025:2005

NVLAP LAB CODE: 100275-0

Nokia, Global Product Compliance Lab
Murray Hill, NJ

*is accredited by the National Voluntary Laboratory Accreditation Program for specific services,
listed on the Scope of Accreditation, for:*

Electromagnetic Compatibility & Telecommunications

*This laboratory is accredited in accordance with the recognized International Standard ISO/IEC 17025:2005.
This accreditation demonstrates technical competence for a defined scope and the operation of a laboratory quality
management system (refer to joint ISO-ILAC-IAF Communique dated January 2009).*

2019-09-20 through 2020-09-30
Effective Dates



For the National Voluntary Laboratory Accreditation Program