

Global Product Compliance Laboratory
600-700 Mountain Avenue
Room 5B-108
Murray Hill, New Jersey 07974-0636 USA



TESTING
NVLAP LAB CODE: 100275-0

C2PC FCC Test Report

Regulation:

FCC Part 2 and 24

Client:

Nokia Mobile Networks

Product Evaluated:

FW2FMBOM1 RF Module
Addition of In Band and Guard Band NB-IoT

Report Number:

TR-2019-0015-FCC2-24

Date Issued:

February 15, 2019

This report shall not be reproduced, in whole or in part without the approval of Nokia Global Product Compliance Laboratory. This report must not be used by the recipient to claim product endorsement by NVLAP or any other agency of the U.S. Government.

Table of Contents

- 1. SYSTEM INFORMATION AND REQUIREMENTS..... 4**
 - 1.1 INTRODUCTION..... 5
 - 1.2 PURPOSE AND SCOPE 5
 - 1.3 EUT DETAILS 5
 - 1.4 REFERENCE DOCUMENTS, TEST SPECIFICATIONS & PROCEDURES 6
 - 1.5 EXECUTIVE SUMMARY 8
 - 1.6 TEST CONFIGURATION FOR ALL ANTENNA PORT MEASUREMENTS..... 8
- 2. FCC SECTION 2.1046 - RF POWER OUTPUT 9**
 - 2.1 RF POWER OUTPUT..... 9
- 3. FCC SECTION 2.1047 - MODULATION CHARACTERISTICS 11**
 - 3.1 MODULATION CHARACTERISTICS..... 11
- 4. FCC SECTION 2.1049 – OCCUPIED BANDWIDTH 12**
 - 4.1 OCCUPIED BANDWIDTH..... 12
 - 4.2 OCCUPIED BANDWIDTH/ EDGE OF BAND EMISSIONS 15
- 5. FCC SECTION 2.1051 - SPURIOUS EMISSIONS AT TRANSMIT ANTENNA PORT 18**
 - 5.1 MEASUREMENT OF SPURIOUS EMISSIONS AT TRANSMIT ANTENNA PORT 18
- 6. FCC SECTION 2.1053..... 23**
 - 6.1 SECTION 2.1053 FIELD STRENGTH OF SPURIOUS EMISSIONS..... 23
 - 6.2 FIELD STRENGTH OF SPURIOUS EMISSIONS - LIMITS 23
- 7. NVLAP CERTIFICATE OF ACCREDITATION 24**

Revisions

Date	Revision	Section	Change
2/15/2019	0		Initial Release

Nokia Global Product Compliance Laboratory represents to the client that testing was done in accordance with standard procedures as applicable, and that reported test results are accurate within generally accepted commercial ranges of accuracy in accordance with the scope of our NVLAP Accreditation. Nokia Global Product Compliance reports only apply to the specific samples tested. This report is the property of the client. This report shall not be reproduced except in full without the written approval of the Nokia Global Product Compliance Laboratory.

Nokia Global Product Compliance Laboratory is accredited with the US Department of Commerce National Institute of Standards and Technology's National Voluntary Laboratory Accreditation Program (NVLAP) for satisfactory compliance with criteria established in Title 15, Part 7 Code of Federal Regulations for offering test services for selected test methods in Electromagnetic Compatibility; Voluntary Control Council for Interference (VCCI), Japan; Australian Communications and Media Authority (ACMA).

Nokia Global Product Compliance Laboratory represents to the client that the laboratory's accreditation or any of its calibration or test reports in no way constitutes or implies product certification, approval, or endorsement by NVLAP, NIST, or any agency of the federal government.

Prepared By: 
 Signed: _____ 2/15/2019
 Nilesch Patel
 Compliance Engineer

Approved By: 
 Signed: _____ 2/15/2019
 Raymond Johnson
 Technical Manager

Reviewed By: 
 Signed: _____ 2/15/2019
 Steve Gordon
 Compliance Engineer

1. System Information and Requirements

Equipment Under Test (EUT):	FW2FMBOM1 RF Module – Addition of In Band and Guard Band NB-IoT to existing FCC ID 2AD8UFW2FMBOM1.
Serial Number:	See Section 1.3
Cell Name / Number	GPCL Project Number: 2019-0015
Company:	NOKIA SOLUTIONS AND NETWORKS OY KARAPORTTI 3, FI-02610 ESPOO FINLAND
Manufacturer:	NOKIA SOLUTIONS AND NETWORKS OY
Test Requirement(s):	47 CFR FCC Part 2 and 24
Test Standards	<ul style="list-style-type: none"> • 47 CFR FCC Parts 2 and 24 • KDB 971168 D01 Power Measurement License Digital Systems v03r01 April 9, 2018. • KDB 662911 D01 Multiple Transmitter Output v02r01 Oct 2013
Measurement Procedure(s):	FCC-IC-OB - GPCL Occupied Bandwidth and Power Measurement Test Procedure 12-4-2017 FCC-IC-SE - GPCL Spurious Emissions Test Procedure 12-4-2017
Reference(s):	<ul style="list-style-type: none"> • ANSI C63.26 (2015) • ANSI C63.4 (2014)
Test Date(s):	Jan 2019
Test Performed By:	Nokia Global Product Compliance Laboratory 600-700 Mountain Ave. P.O. Box 636 Murray Hill, NJ 07974-0636
Nokia Global Product Compliance Laboratories is accredited by the National Voluntary Laboratory Accreditation Program (NVLAP®) for specific services, listed on the Scope of Accreditation, for: Electromagnetic Compatibility and Telecommunications. This laboratory is accredited in accordance with the recognized International Standard ISO/IEC 17025:2005. This accreditation demonstrates technical competence for a defined scope and the operation of a laboratory quality management system (refer to joint ISO-ILAC-IAF Communiqué dated January 2009). NVLAP LAB CODE: 100275-0.	
Product Engineer(s):	Ron Remy
Lead Engineer	Steve Gordon
Test Engineer (s):	Jaideep Yadav, Eugene Mitchell, Mike Soli
Test Results: The FW2FMBOM1 RF Module, <i>as tested</i> met the above listed requirements. Report copies and other information not contained in this report are held by either the product engineer or in an identified file at the Global Product Compliance Laboratory in New Providence, NJ.	

1.1 Introduction

This Conformity test report applies to the FW2FMBOM1 RF Module, hereinafter referred to as the Equipment Under Test (EUT).

1.2 Purpose and Scope

The purpose of this document is to provide the testing data required for qualifying the EUT in compliance with FCC Parts 2 and 24 measured in accordance with the procedures set out in Section 2.1033 (c) (14) of the Rules.

The EUT was tested for Class II Permissive to add NB IoT In Band and Guard Band to the existing 2AD8UFW2FMBOM1 Grant for 10 and 20 MHz only. The B2/B66 system was previously tested at the system level with a WiFi module, PRI04664 (Test Report: TR-2016-0155-FCC2-24).

1.3 EUT Details

The Flexi Zone Multiband Outdoor BTS is a single box base station that supports two LTE Band Class radios and one WiFi band radio. Each Radio Module supports 2 Tx/Rx branches. Each LTE TX branch has a 5W maximum rated RF output power.



1.3.1 Test Requirements

Each required measurement is listed below:

47 CFR FCC Sections	Description of Tests	Test Required
2.1046	RF Power Output	Yes
2.1047	Modulation Characteristics	Yes
2.1049	(a) Occupied Bandwidth (b) Out-of-Band Emissions	Yes
2.1051	Spurious Emissions at Antenna Terminals	Yes
2.1053	Field Strength of Spurious Radiation	Yes

1.4 Reference Documents, Test Specifications & Procedures

A list of the applicable documents is provided in Section 1.0.

1.4.1 Test Specifications

- Title 47 Code of Federal Regulations, Federal Communications Commission Part 2.
- Title 47 Code of Federal Regulations, Federal Communications Commission Part 24.

1.4.2 Procedures

1. FCC-IC-0B and FCC-IC-SE
2. ANSI C63.4 (2014) entitled: "American National Standard for Methods of Measurement of Radio-Noise Emissions from Low Voltage Electrical and Electronic Equipment in the Range of 9kHz to 40 GHz", American National Standards Institute, Institute of Electrical and Electronic Engineers, Inc., New York, NY 10017-2394, USA.
3. FCC KDB 971168 D01 Power Measurement License Digital Systems v03r01 April 9, 2018.
 FCC KDB 662911 D01 Multiple Transmitter Output v02r01 Oct 2013

1.4.3 MEASUREMENT UNCERTAINTY

The results of the calculations to estimate uncertainties for the several test methods and standards are shown in the Table below. These are the worst-case values.

Worst-Case Estimated Measurement Uncertainties

Standard, Method or Procedure	Condition	Frequency MHz	Expanded Uncertainty (k=2)
a. Classical Emissions, (e.g., ANSI C63.4, CISPR 11, 14, 22, etc., using ESHS 30,	Conducted Emissions	0.009 - 30	±3.5 dB
	Radiated Emissions (AR-6 Semi-Anechoic Chamber)	30 MHz – 200MHz H	±5.1 dB
		30 MHz – 200 MHz V	±5.1 dB
		200 MHz – 1000 MHz H	±4.7 dB
		200 MHz – 1000 MHz V	±4.7 dB
	1 GHz - 18 GHz	±3.3 dB	

Antenna Port Test	Signal Bandwidth	Frequency Range	Expanded Uncertainty (k=2), Amplitude
Occupied Bandwidth, Edge of Band, Conducted Spurious Emissions	10 Hz	9 kHz to 20 MHz	1.78 dB
	100 Hz	20 MHz to 1 GHz	
	10 kHz to 1 MHz	1 GHz to 10 GHz	
	1MHz	10 GHz to 40 GHz:	
RF Power	10 Hz to 20 MHz	50 MHz to 18 GHz	0.5 dB

1.5 Executive Summary

Requirement	Description	Result
47 CFR FCC Parts 2 and 24		
2.1046	RF Power Output Peak to Average Power Ratio	COMPLIES
2.1047	Modulation Characteristics	COMPLIES
2.1049	Occupied Bandwidth (a) Emissions Signal Bandwidth (b) Occupied Bandwidth/ Edge of Band Emissions	COMPLIES
2.1051	Spurious Emissions at Antenna Terminals	COMPLIES
2.1053	Field Strength of Spurious Radiation	COMPLIES

1. **COMPLIES** - Passed all applicable tests.
2. **N/A** – Not Applicable.
3. **NT** – Not Tested.

1.6 Test Configuration for all Antenna Port Measurements.

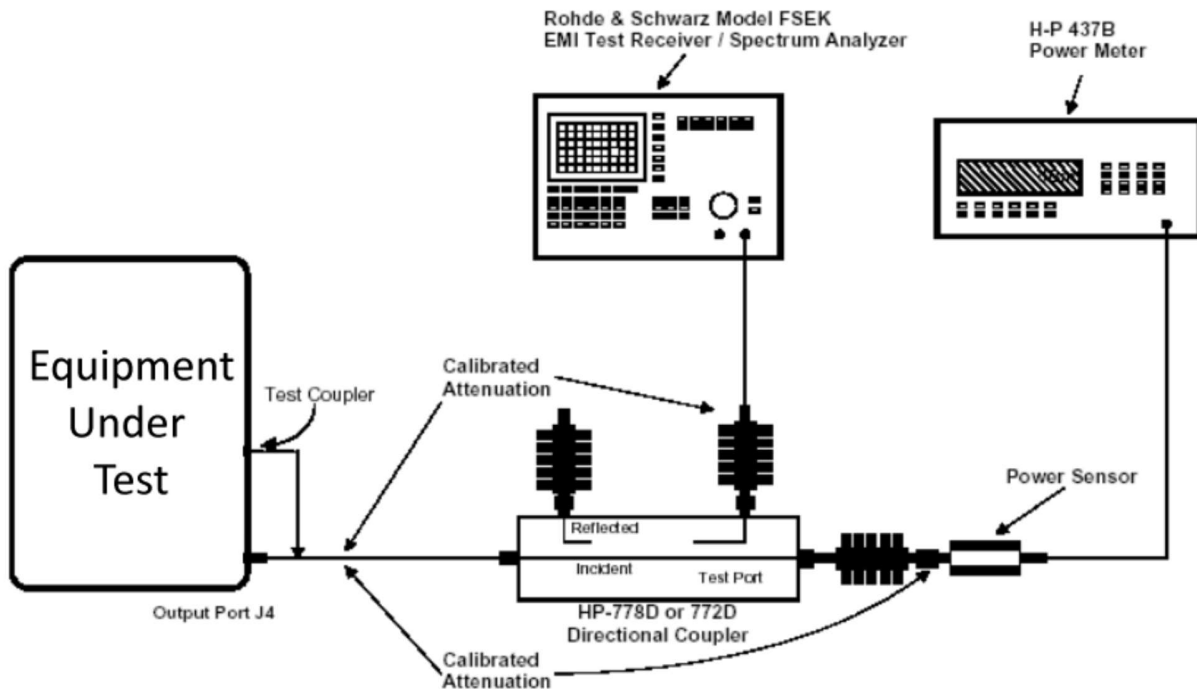

2. FCC Section 2.1046 - RF Power Output

2.1 RF Power Output

This test is a measurement of the total RF power level transmitted at the antenna-transmitting terminal. The product was configured for test as shown in section 1.6 above and allowed to warm up and stabilize per KDB 971168 D01 and ANSI C63.26.

Power measurements were made with an MXA signal analyzer in the average mode. Before the testing was started, the Base Station was given a sufficient “warm-up” period as required.

NOTE: Only a sample of all the plots taken have been used in this report. The full suite of raw data resides at the MH, New Jersey location.

2.1.1 Peak-to-Average Power Ratio (PAPR)

The Peak-to-Average Power Ratio (PAPR) was evaluated per KDB 971168 for 10MHz and 20MHz bandwidths with QPSK modulation for In Band and Guard Band. The PAPR values of all carriers measured are below 13dB.

The maximum rated mean RF power outputs of the EUT at its antenna transmitting terminals is 5W (+37 dBm) per 10MHz and 20MHz LTE carrier per port and 10 W (+40 dBm) per MBO, within ±1dB derivation, and are in full compliance with the Rules of the Commission.

2.1.2 PAPR, 10MHz, QPSK – In Band NB IoT

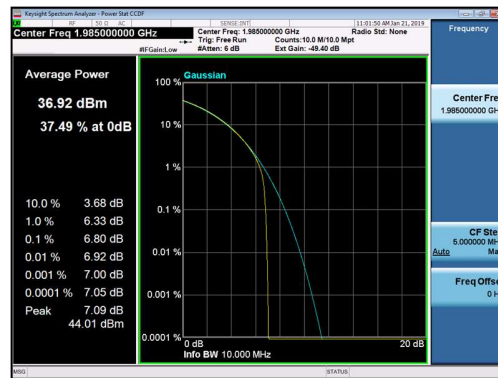
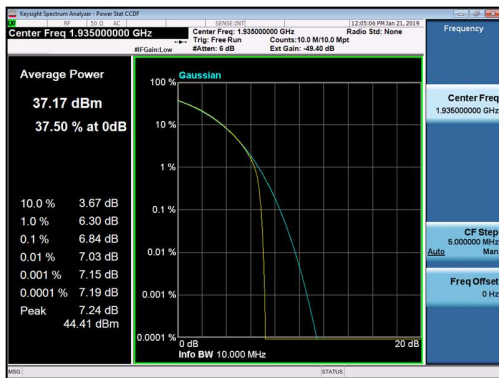

2.1.3 PAPR, 10MHz, QPSK – Guard Band NB IoT

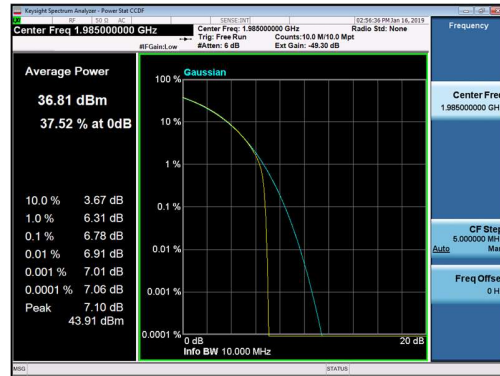
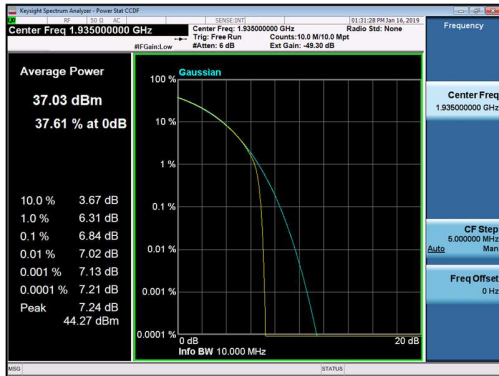

2.1.4 PAPR, 20MHz, QPSK – In Band NB IoT

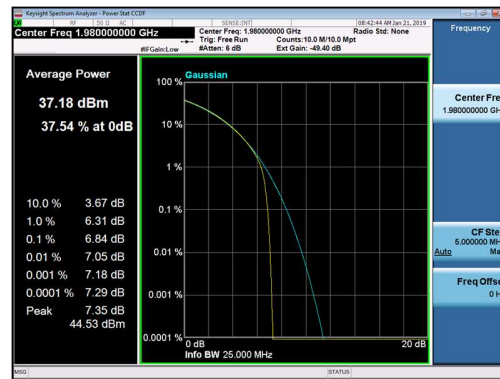
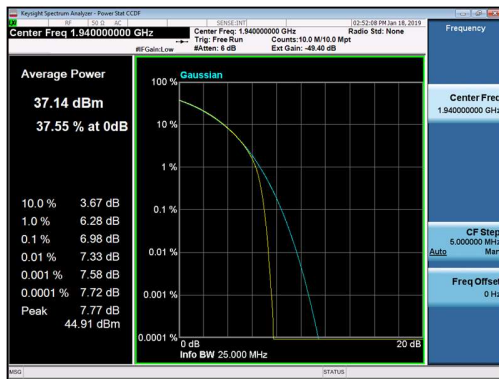

2.1.5 PAPR, 20MHz, QPSK – Guard Band NB IoT

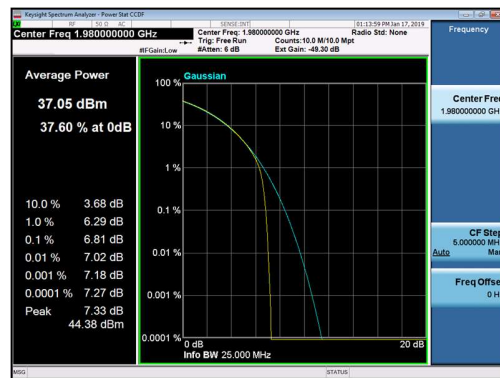
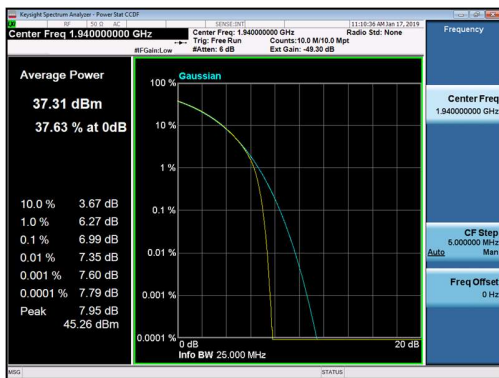

3. FCC Section 2.1047 - Modulation Characteristics

3.1 Modulation Characteristics

The RF signal at the antenna port was demodulated and verified for correctness of the modulation signal used before each test was performed. For these products the operation with QPSK modulation was evaluated and verified.

NOTE: Only a sample of all the data taken have been used in this report. The full suite of raw data resides at the MH, New Jersey location.

3.1.1 Modulation Characteristics – 10MHz QPSK

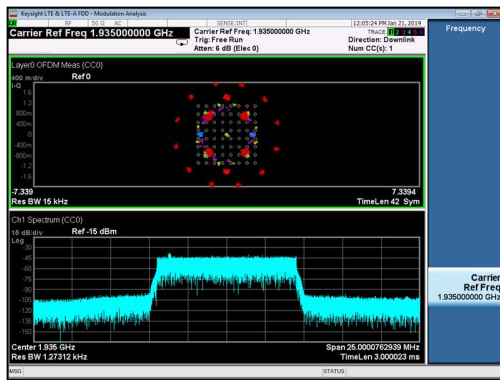

In Band NB IoT

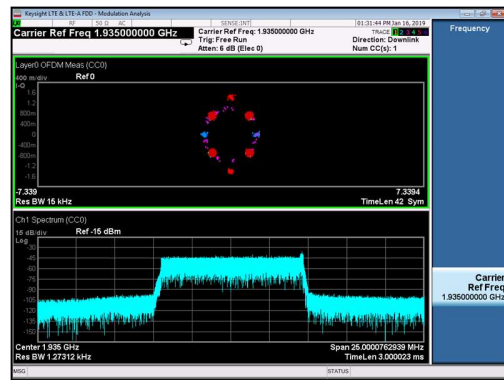

Guard Band NB IoT

3.1.2 Modulation Characteristics – 20MHz QPSK

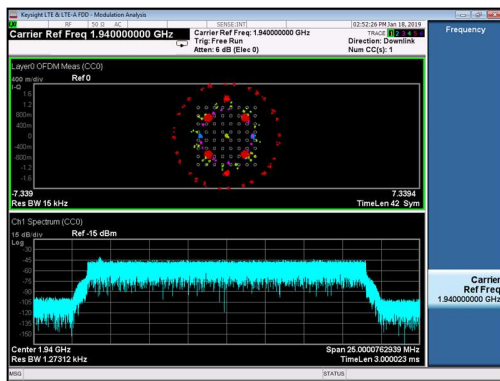

In Band NB IoT

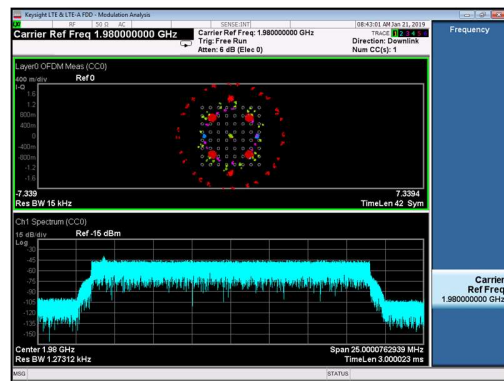

In Band NB IoT

4. FCC Section 2.1049 – Occupied Bandwidth

4.1 Occupied Bandwidth

In 47CFR 2.1049 the FCC requires:

“The occupied bandwidth, that is the frequency bandwidth such that, below its lower and above its upper frequency limits, the mean powers radiated are each equal to 0.5 percent of the total mean power radiated by a given emission shall be measured under the following conditions as applicable.”

This required measurement is the 99% Occupied Bandwidth, also called the designated signal bandwidth and needs to be within the parameters of the products specified emissions designator.

During these measurements it is customary to evaluate the Edge of Band emissions at block/band edges.

The transmitted signal occupied bandwidth was measured using a Keysight MXA Signal Analyzer. All emissions were within the parameters as previously filed. Sample Charts are below.

Tabular Data – In Band NB IoT

Channel Frequency MHz	Signal BW MHz	Modulation	OBW MHz
1935	10	QPSK	8.9294
1985	10	QPSK	8.9299
1940	20	QPSK	17.840
1980	20	QPSK	17.842

Tabular Data – Guard Band NB IoT

Channel Frequency MHz	Signal BW MHz	Modulation	OBW MHz
1935	10	QPSK	9.1563
1985	10	QPSK	9.1559
1940	20	QPSK	18.154
1980	20	QPSK	18.132

4.1.1 Occupied Bandwidth 10 MHz – In Band NB IoT

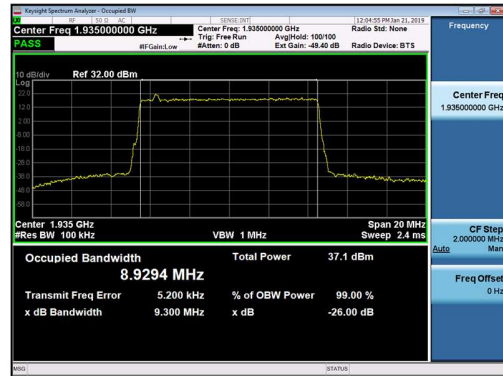
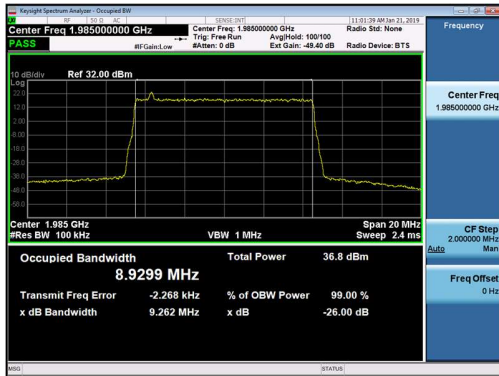

4.1.2 Occupied Bandwidth 10MHz – Guard Band NB IoT

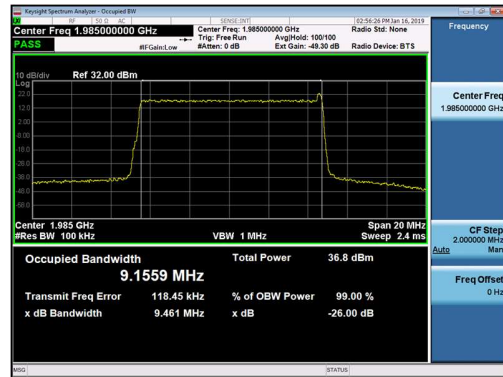

4.1.3 Occupied Bandwidth 20 MHz – In Band NB IoT

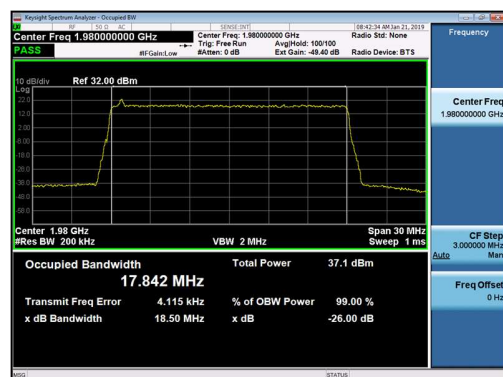
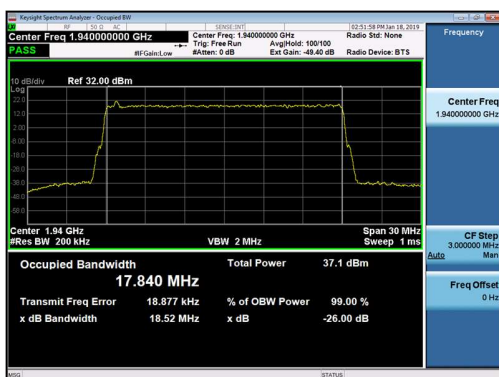

4.1.4 Occupied Bandwidth 20MHz – Guard Band NB IoT

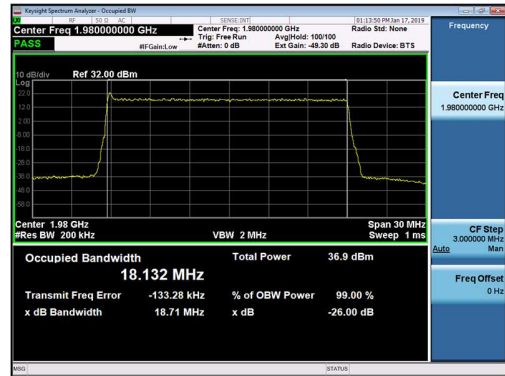
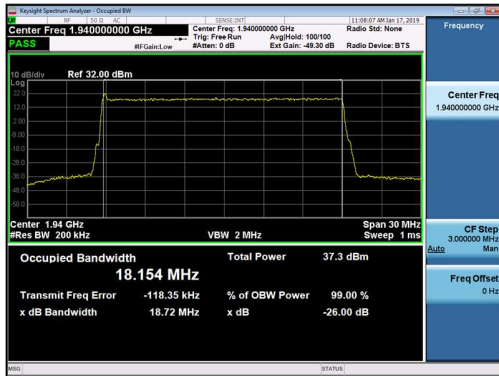

4.2 Occupied Bandwidth/ Edge of band Emissions

The Edge of Band emissions of the EUT at the external antenna connector (EAC) were measured using a Keysight MXA Signal Analyzer. The RF power level was continuously measured using a RF broadband power meter. The RF output from the EAC port to spectrum analyzer was reduced (to an amplitude usable by the spectrum analyzer) by using a calibrated attenuator and test coupler. The path attenuation was offset on the display and the signal for single carrier was adjusted to the corrected RF power level for the resolution bandwidth used for the transmit signal. All mask values were adjusted based upon the designated signal bandwidth and measurement bandwidths. The Top of Mask corresponds to the set rated power level as confirmed by the RF power meter.

4.2.1 Edge of band Emissions.

The Occupied Bandwidth was measured for QPSK modulation at each signal bandwidth. The mask on the plots meet the Block Edge requirements as specified in 47CFR 24.238.

All of the measurements met the requirements of Part 24.238 when measured per Part 2.1049.

NOTE: Only a sample of all the data taken have been used in this report. The full suite of data resides at the MH, New Jersey location.

4.2.2 Edge of band Emissions 10MHz – In Band NB IoT



4.2.3 Edge of band Emissions 10MHz – Guard Band NB IoT



4.2.4 Edge of band Emissions 20MHz – In Band NB IoT



4.2.5 Edge of band Emissions 20MHz – Guard Band NB IoT

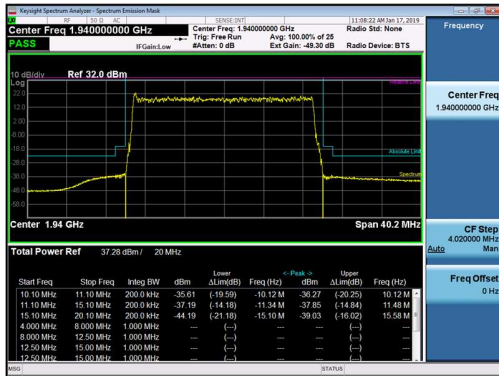

5. FCC Section 2.1051 - Spurious Emissions at Transmit Antenna Port

5.1 Measurement of Spurious Emissions at Transmit Antenna Port

Spurious Emissions at the transmit-antenna terminals were investigated over the frequency range of 10 MHz to beyond the 10th harmonic of the specific transmit band. For this band of operation, the measurements were performed up to 22GHz. Measurements were made using a Keysight MXA Signal Analyzer. The RF output from the transmitter was reduced (to an amplitude usable by the receivers) using calibrated attenuators. The RF power level was continuously monitored via a coupled RF Power Meter.

The required emission limitation is specified as appropriate in 24.238. The measured spurious emission levels were plotted for the frequency range as specified in 2.1057. There were no reportable emissions. Data below documents performance up to 22 GHz.

NOTE: Only a sample of all the data taken have been used in this report. The full suite of raw data resides at the MH, New Jersey location.

5.1.1 Spurious Emissions at Tx Port - 10MHz, 1935MHz, QPSK, In Band NB IoT

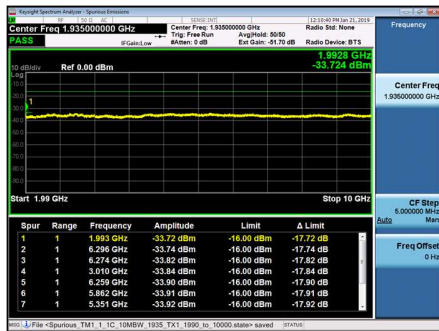
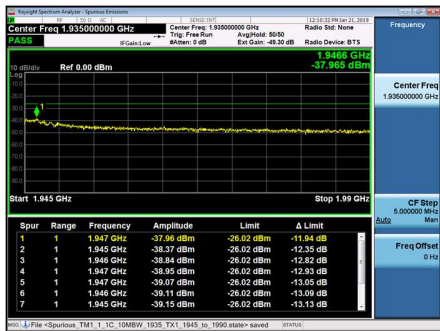
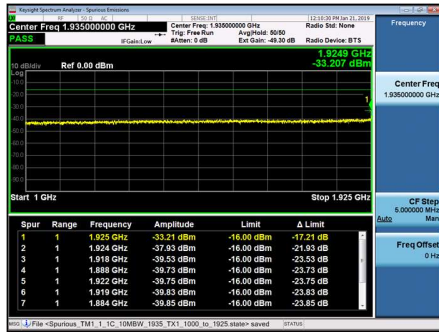
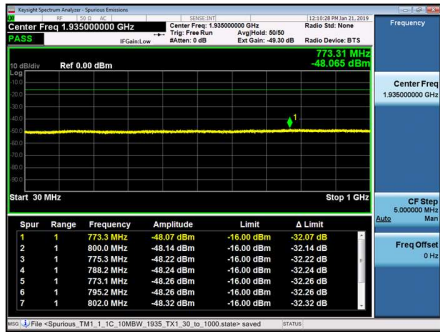
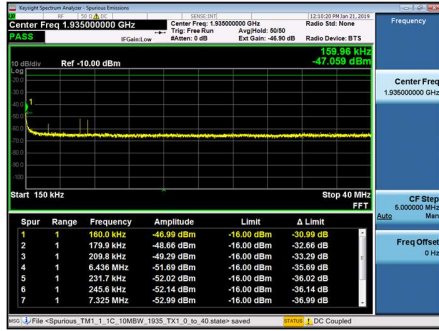

5.1.2 Spurious Emissions at Tx Port - 20MHz, 1980MHz, QPSK, Guard Band NB IoT

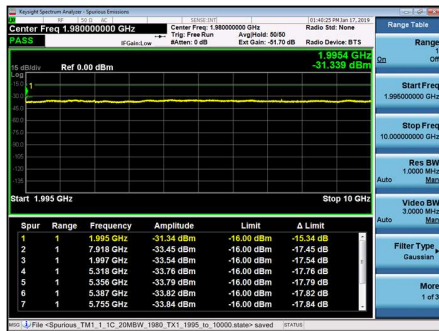
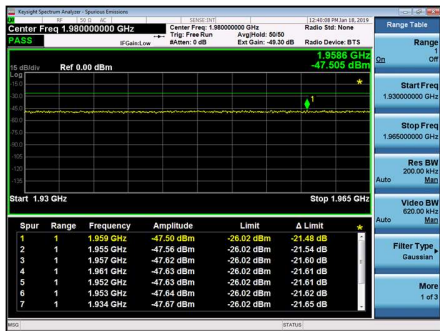
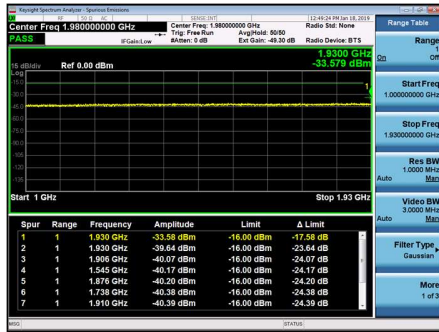
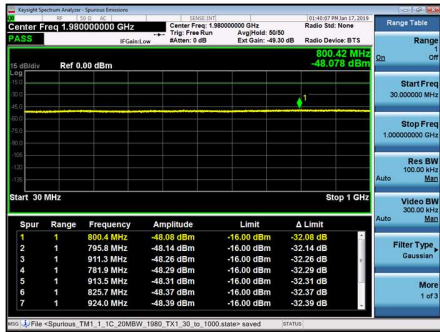
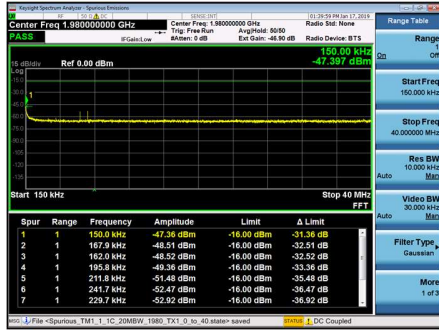
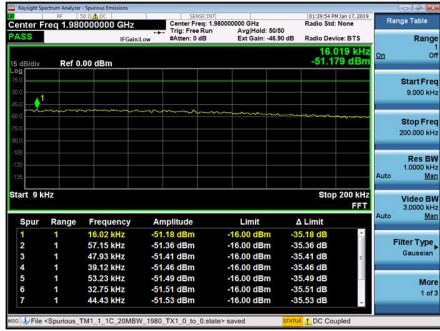

Photographs

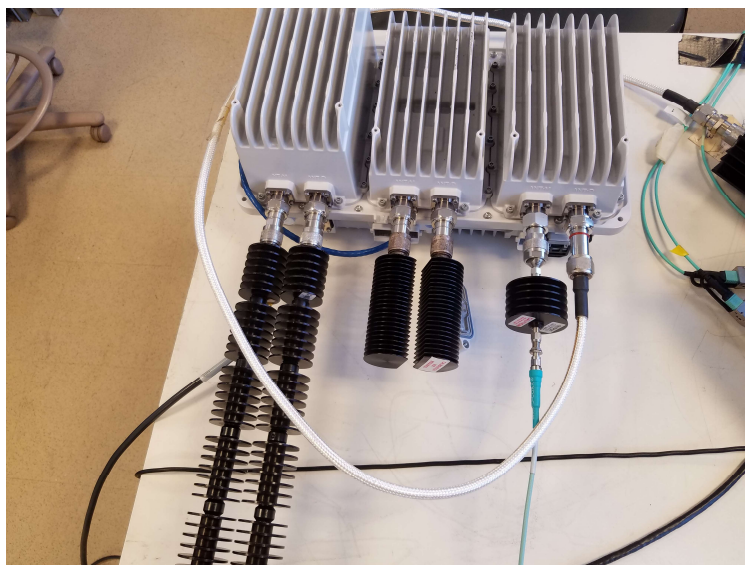

Test Equipment

Asset ID	Manufacturer	Type	Description	Model	Serial	Calibration Date	Calibration Due	Calibration Type	Status
E831	Agilent Technologies	MXA Signal Analyzer	20Hz-26.5GHz	N9020A	MY48011791	2018-02-15	2020-02-15	Requires Calibration	Active
E1116	Trilithic	High Pass Filter	PCS 2.85GHz - 18.05GHz	5HC2850/18050-1.8-KK	200113078			Calibration Not Required	Active
E1156	Weinschel	Attenuator	10dB 0.05GHz-26GHz 25W	74-10-12	1069			Calibration Not Required, Must Be Verified	Active
E1155	Weinschel	Attenuator	10dB 25Watt 0.05GHz - 26GHz	74-10-12	1068			Calibration Not Required, Must Be Verified	Active
E1154	Weinschel	Attenuator	30dB 25W 0.05GHz-26GHz	74-30-12	1065			Calibration Not Required, Must Be Verified	Active
	UTIFLEX MICRO-COAX	Cable	UFB142A-0-0720-2G0200/A. MFR65639 227883-001	142A Series 503609-G				Pathloss verified with attenuators	

6. FCC Section 2.1053

6.1 Section 2.1053 Field Strength of Spurious Emissions

Field strength measurements of radiated spurious emissions were made in 3m Semi-Anechoic Chambers the of Global Product Compliance Laboratories of Nokia Bell Labs in Murray Hill NJ. A complete description and full measurement data for the site is on file with the Commission (FCC File 515091).

The spectrum from 30 MHz to beyond the tenth harmonic of the carrier, 27 GHz, was searched for spurious radiation. Measurements were made using both horizontally and vertically polarized broadband antennas. Per FCC regulations, the comparison of out of band spurious emissions directly to the limit is appropriately made using the substitution method. However, when the emissions are more than 20 dB below the specification limit, the use of field strength measurements for compliance determination is acceptable and those emissions are considered not reportable (Section 2.1053 and the FCC Interpretive database for 2.1053). For this case the evaluation of acceptable radiated field strength is as follows.

6.2 Field Strength of Spurious Emissions - Limits

Sections 2.1053 and 24.238 contain the requirements for the levels of spurious radiation as a function of the level of the unmodulated carrier. The reference level for the unmodulated carrier is calculated as the field produced by an ideal dipole excited by the transmitter output power according to the following relation taken from Reference Data for Radio Engineers, page 676, 4th edition, IT&T Corp.

$$E = [(30 \cdot P)^{1/2}] / R$$

$$20 \log (E \cdot 10^6) - (43 + 10 \log P) = 82.23 \text{ dB}\mu\text{V/meter}$$

Where:

E = Field Intensity in Volts/meter

P = Transmitted Power in Watts

R = Measurement distance in meters = 3 m

The Part 24 Limit is 82.23 dBuV/m at 3m and 91.77 dBuV/m at 1m

The Part 24 non-report level is 62.23 dBuV/m at 3m.

The calculated emission levels were found by:

$$\text{Measured level (dB}\mu\text{V)} + \text{Cable Loss(dB)} + \text{Antenna Factor(dB)} = \text{Field Strength (dB}\mu\text{V/m)}$$

RESULTS:

For compliance with 47CFR Parts 2 and 24, the field strength of any spurious radiation, measured at 3m, is required to be less than 82.23 dBuV/meter (82.23 @ 3m). Emissions equal to or less than 62.23 dBuV/meter at 3m are not reportable and may be verified using field strength measurements and broadband antennas. Over the out of band spectrum investigated from 30 MHz to beyond the tenth harmonic of the carrier (up to 27GHz), no reportable spurious emissions were detected.

7. NVLAP Certificate of Accreditation

United States Department of Commerce
National Institute of Standards and Technology



Certificate of Accreditation to ISO/IEC 17025:2005

NVLAP LAB CODE: 100275-0

Nokia, Global Product Compliance Lab
Murray Hill, NJ

*is accredited by the National Voluntary Laboratory Accreditation Program for specific services,
listed on the Scope of Accreditation, for:*

Electromagnetic Compatibility & Telecommunications

*This laboratory is accredited in accordance with the recognized International Standard ISO/IEC 17025:2005.
This accreditation demonstrates technical competence for a defined scope and the operation of a laboratory quality
management system (refer to joint ISO-ILAC-IAF Communique dated January 2009).*

<hr/> <p style="text-align: center;">2018-09-05 through 2019-09-30 <i>Effective Dates</i></p>		 <hr/> <p style="text-align: center;"><i>For the National Voluntary Laboratory Accreditation Program</i></p>
---	---	---