

5. APPENDIX A - CALIBRATION CERTIFICATES.

The attached Calibration certificates represent the Harmonic Downconverters used in this testing.



CALIBRATION CERTIFICATE



Kalibrierschein

Certificate Number
Zertifikatsnummer

0001A300618455

General Data			
Item Gegenstand	FS-Z60 HARMONIC MIXER 40-60GHZ		
Manufacturer Hersteller	ROHDE & SCHWARZ		
Type Typ	FS-Z60		
Material Number Materialnummer	1048.0171.02	Serial Number Seriennummer	100977
Order Number Bestellnummer	8800010960 10, 5011119893	Asset Number Inventarnummer	E1311
Customer Auftraggeber	Nokia of America Corp Mountain Ave 600 07974-0636 Murray Hill US		
Performance			
Place and Date of Calibration Ort und Datum der Kalibrierung	87700 Memmingen, Rohde-und-Schwarz-Str. 1 2021-10-06		
Statement of Compliance (Incoming) Konformitätsaussage (Anlieferung)	All measured values are within the data sheet specifications.		
Statement of Compliance (Outgoing) Konformitätsaussage (Auslieferung)	All measured values are within the data sheet specifications.		
Customers due Interval Kalibrierintervall des Kunden			
Extent of Calibration Document Umfang des Kalibrierdokuments	3 Certificate 6 Outgoing Results 6 Incoming Results		
Date of Issue Ausstellungsdatum	Approval of the certificate by Freigabe des Kalibrierscheins durch		
2021-10-08	Dr. Gerhard Rösel	Johannes Negele	
	Laboratory management Labormanagement	Person responsible Bearbeiter	

Calibration Mark Kalibrierzeichen

300618455
D-K- 15195-01-00
2021-10

Member of Deutscher Kalibrierdienst
Mitglied im Deutschen Kalibrierdienst



This calibration certificate documents the metrological traceability to national standards, which realize the units of measurement according to the International System of Units (SI). The DAkkS is signatory to the multilateral agreements of the European co-operation for Accreditation (EA) and of the International Laboratory Accreditation Cooperation (ILAC) for the mutual recognition of calibration certificates. The user is obliged to have the object recalibrated at appropriate intervals. This calibration certificate may not be reproduced other than in full except with the permission of the issuing laboratory. Calibration certificates with the full name of the approval responsible person are valid without signature.

Dieser Kalibrierschein dokumentiert die metrologische Rückführbarkeit auf nationale Normale zur Darstellung der Einheiten in Übereinstimmung mit dem Internationalen Einheitensystem (SI). Die DAkkS ist Unterzeichner der multilateralen Übereinkommen der European cooperation for Accreditation (EA) und der International Laboratory Accreditation Cooperation (ILAC) zur gegenseitigen Anerkennung der Kalibrierscheine. Für die Einhaltung einer angemessenen Frist zur Wiederholung der Kalibrierung ist der Benutzer verantwortlich. Dieser Kalibrierschein darf nur vollständig weiterverbreitet werden. Auszüge oder Änderungen bedürfen der Genehmigung des ausstellenden Kalibrierlaboratoriums. Kalibrierscheine sind bei Nennung des für die Freigabe Verantwortlichen in Klarschrift auch ohne Unterschrift gültig.



Material No 1048.0171.02
Page 2/3

Serial No 100977

Certificate Number 0001A300618455

Calibration Procedure

The measuring object is an RF harmonic mixer, which converts an RF signal at one frequency into a signal at another frequency (here: IF). The conversion loss was measured using a vector network analyzer. The RF output power as well as the IF input power of the corresponding ports of the VNA were traced back to a power sensor. The conversion loss is defined as the ratio of the power at the IF frequency to the power at the RF frequency with a given LO power. (IF: Intermediate frequency; LO: Local Oscillator)
 The traceability is represented in the table Working Standards used.

Working Standards used

Item	Type	Serial Number	Calibration Certificate Number	Cal. Due
Therm.Power Sensor DC-40GHz	NRP-Z55	130179	585760 D-K-15195-01-00 2021-01	2023-01-31
Thermal Power Sensor	NRP67T	100977	515392 D-K-15195-01-01 2019-07	2022-07-31
Vector Network Analyzer 4 Port	ZVA67	101175	0023 D-K-15195-01-00 2021-03	2022-03-31

Remarks



Material No 1048.0171.02 **Serial No** 100977 **Certificate** 0001A300618455
Page 3/3 **Number**

Environmental Conditions			
Ambient Temperature	(23 ± 1) °C	Relative Humidity	20%-60%

Comments on Measurement Results

The measurement results in the test report stated below have been tested for compliance with the given specifications and marked if necessary. The associated uncertainty of measurement has been taken into account, if not otherwise stated. Measurement results that are not covered by the DAkkS accreditation are marked with ¹.
 Ref.: ILAC G8:09/2019 'Guidelines on Decision Rules and Statements of Conformity'.

The expanded measurement uncertainty corresponds to the measurement results from the standard measurement uncertainty multiplied by the coverage factor $k = 2$.
 It was determined in accordance with EA-4/02 M:2013. The true value is located in the corresponding interval with a probability of 95 %.

In addition to the calibration results, the calibration certificate includes functional measurements that might have an influence on the measurement uncertainty of the calibration results. The functional measurement results are marked and are not intended to be used to support the further dissemination of metrological traceability. They are intended to verify the requirements on the measurement object according to manufacturer specifications and technical standards.

Outgoing Results

Designation:	HARMONIC MIXER
Type:	FS-Z60
Material No.:	1048.0171.02
Serial No.:	100977
Certificate No.:	0001A300618455
Referring to Test Documentation:	5038.8581.01-PB-02.00

Test Department:	3MME3
Name:	Johannes Negele
Date:	2021-10-06



Table of contents

- Software used for measurement 3
- 1. Conversion Loss (4. Harmonic) 4
 - 1.1 Conversion Loss (IF = 404.4 MHz) 4
 - 1.2 Conversion Loss (IF = 729 MHz) 4
 - 1.3 Conversion Loss (IF = 1330 MHz) 5
 - 1.4 Continuity response within 1 GHz 5

Software used for measurement			
Item	Type	Version	Remark
Suite	Setup	V12.10.02	Test Management Software G5
Test Program (7012.8706.00_)	Component	V01.05	

1. Conversion Loss (4. Harmonic)

1.1 Conversion Loss (IF = 404.4 MHz)

IF = 404.4 MHz, 4. Harmonic

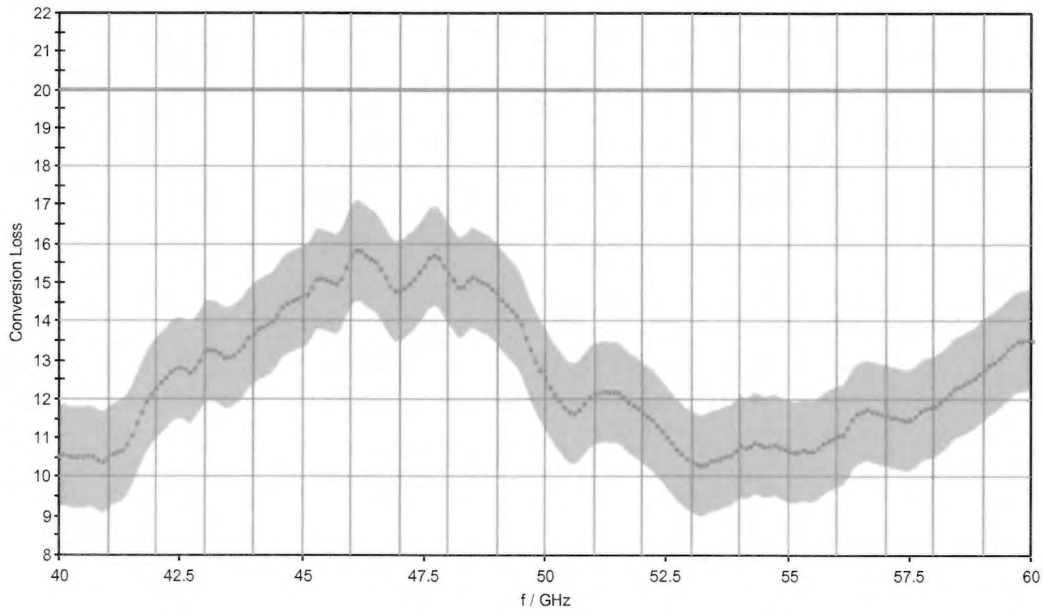

1.2 Conversion Loss (IF = 729 MHz)

IF = 729 MHz, 4. Harmonic

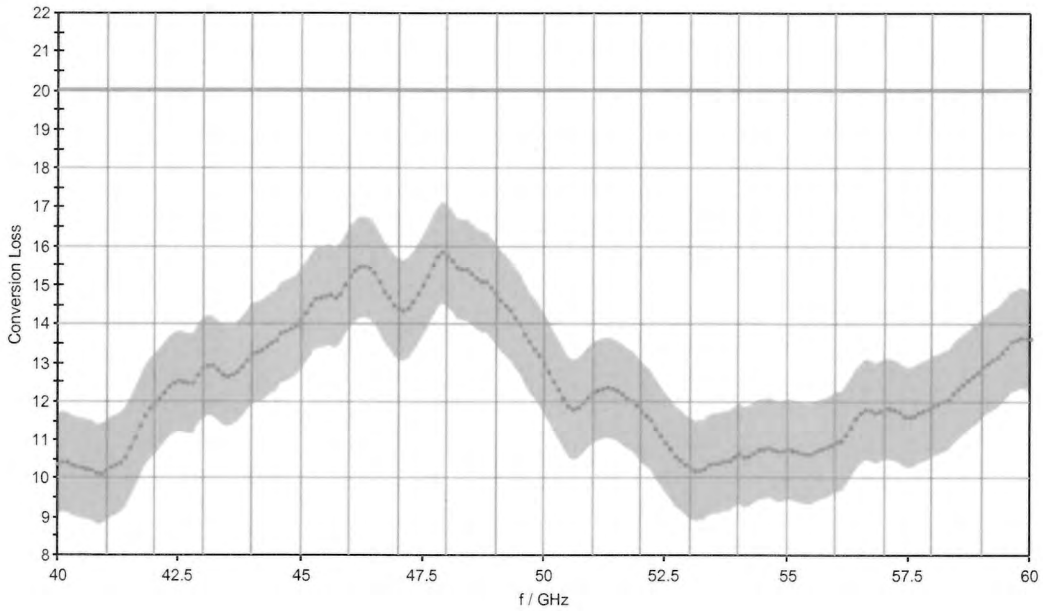

1.3 Conversion Loss (IF = 1330 MHz)

IF = 1330 MHz, 4. Harmonic

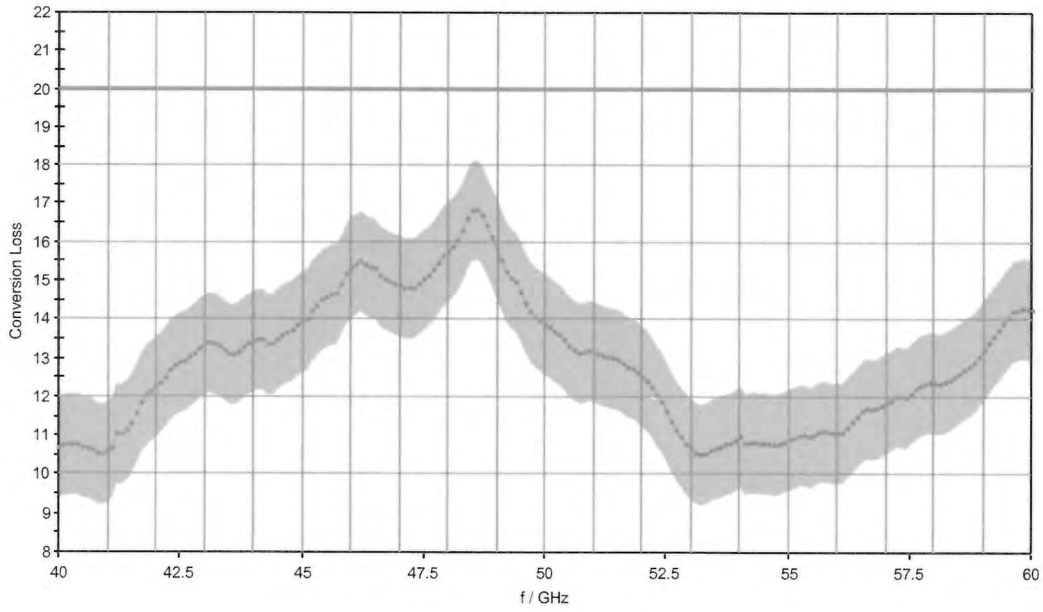

1.4 Continuity response within 1 GHz

Continuity response within any 1 GHz Band, 4. Harmonic

	DUL /dB	Continuity /dB
max. at IF = 404.4 MHz:	6.0	2.35
max. at IF = 729 MHz:	6.0	2.12
max. at IF = 1330 MHz:	6.0	2.48

Incoming Results

Designation:	HARMONIC MIXER
Type:	FS-Z60
Material No.:	1048.0171.02
Serial No.:	100977
Certificate No.:	0001A300618455
Referring to Test Documentation:	5038.8581.01-PB-02.00

Test Department:	3MME3
Name:	Johannes Negele
Date:	2021-10-06

Incoming Results



Table of contents

Software used for measurement	3
1. Conversion Loss (4. Harmonic)	4
1.1 Conversion Loss (IF = 404.4 MHz)	4
1.2 Conversion Loss (IF = 729 MHz)	4
1.3 Conversion Loss (IF = 1330 MHz)	5
1.4 Continuity response within 1 GHz	5

Incoming Results

Software used for measurement			
Item	Type	Version	Remark
Suite	Setup	V12.10.02	Test Management Software G5
Test Program (7012.8706.00_)	Component	V01.05	

1. Conversion Loss (4. Harmonic)

1.1 Conversion Loss (IF = 404.4 MHz)

IF = 404.4 MHz, 4. Harmonic

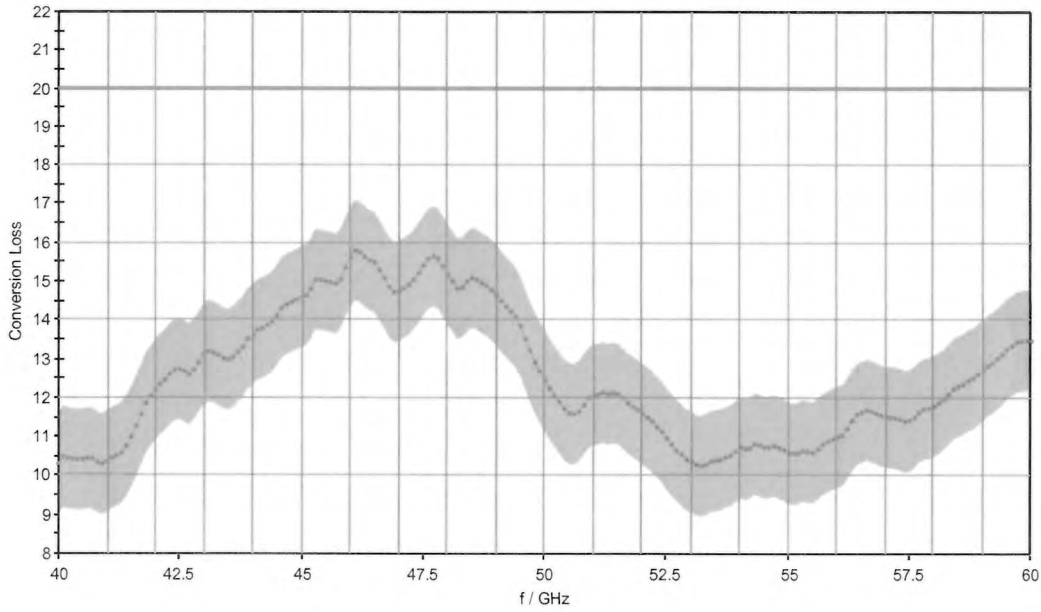

1.2 Conversion Loss (IF = 729 MHz)

IF = 729 MHz, 4. Harmonic

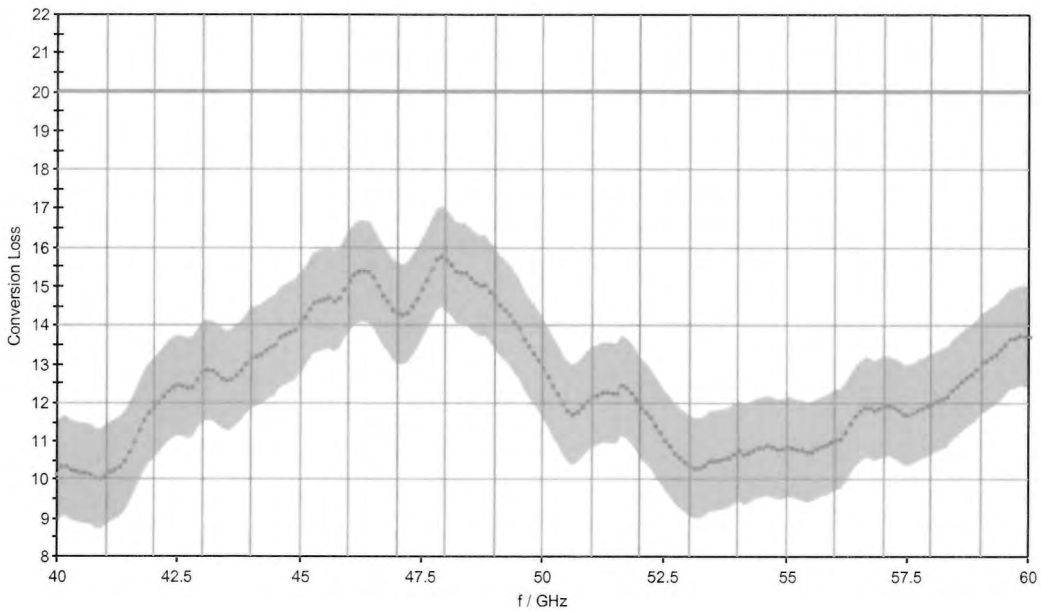

1.3 Conversion Loss (IF = 1330 MHz)

IF = 1330 MHz, 4. Harmonic

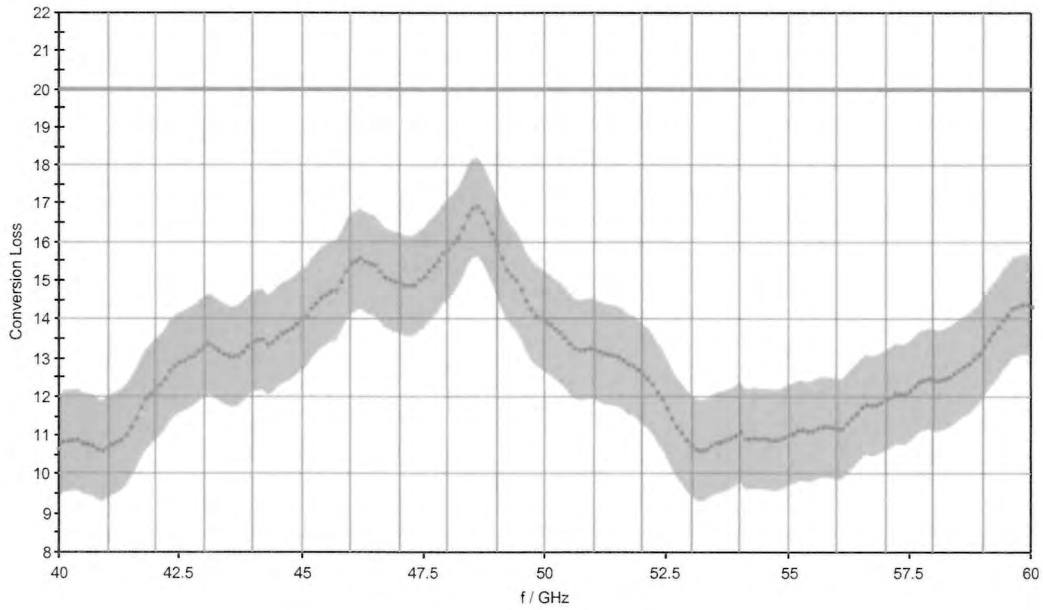

1.4 Continuity response within 1 GHz

Continuity response within any 1 GHz Band, 4. Harmonic

	DUL /dB	Continuity /dB
max. at IF = 404.4 MHz:	6.0	2.36
max. at IF = 729 MHz:	6.0	2.14
max. at IF = 1330 MHz:	6.0	2.49



Calibration Certificate

Certificate Number 0001-300618370

Kalibrierschein

Zertifikatsnummer

Unit Data

Item **FS-Z90 HARMONIC MIXER 60-90GHZ**
Gegenstand

Manufacturer **ROHDE & SCHWARZ**
Hersteller

Type **FS-Z90**
Typ

Material Number **1048.0371.02** Serial Number **101719**
Materialnummer Seriennummer

Asset Number **E1312**
Inventarnummer

Order Data

Customer **Nokia of America Corp**
Auftraggeber **Mountain Ave 600
07974-0636 Murray Hill
US**

Order Number **8800010956 10, 5011119875**
Bestellnummer

Date of Receipt **2021-09-27**
Eingangsdatum

Performance

Place and Date of Calibration **Werk Memmingen, 2021-09-28**
Ort und Datum der Kalibrierung

Scope of Calibration **Standard Calibration**
Umfang der Kalibrierung

Statement of Compliance **All measured values are within**
(Incoming) **the data sheet specifications.**
Konformitätsaussage (Anlieferung)

Statement of Compliance **All measured values are within**
(Outgoing) **the data sheet specifications.**
Konformitätsaussage (Auslieferung)

Extent of Calibration Documents **3 Pages Calibration Certificate**
Umfang des Kalibrierdokuments **6 Pages Outgoing Results**
6 Pages Incoming Results

This calibration certificate documents, that the named item is tested and measured against defined specifications. Measurement results are located usually in the corresponding interval with a probability of approx. 95% (coverage factor $k = 2$). Calibration is performed with test equipment and standards directly or indirectly traceable by means of approved calibration techniques to the PTB/DKD or other national / international standards, which realize the physical units of measurement according to the International System of Units (SI). In all cases where no standards are available, measurements are referenced to standards of the R&S laboratories. Principles and methods of calibration correspond and are conformant with EN ISO/IEC 17025, ANSI/NCSL Z540.1-1994 and ANSI/NCSL Z540.3-2006. The applied quality system is certified to EN ISO 9001. This calibration certificate may not be reproduced other than in full. Calibration certificates without signatures are not valid. The user is obliged to have the object recalibrated at appropriate intervals.

Dieser Kalibrierschein dokumentiert, dass der genannte Gegenstand nach festgelegten Vorgaben geprüft und gemessen wurde. Die Messwerte lagen im Regelfall mit einer Wahrscheinlichkeit von annähernd 95% im zugeordneten Werteintervall (Erweiterte Messunsicherheit mit $k = 2$). Die Kalibrierung erfolgte mit Messmitteln und Normalen, die direkt oder indirekt durch Ableitung mittels anerkannter Kalibriertechniken rückgeführt sind auf Normale der PTB/DKD oder anderer nationaler/internationaler Standards zur Darstellung der physikalischen Einheiten in Übereinstimmung mit dem Internationalen Einheitensystem (SI). Wenn keine Normale existieren, erfolgt die Rückführung auf Bezugsnormale der R&S-Laboratorien. Grundsätze und Verfahren der Kalibrierung beziehen sich auf und entsprechen EN ISO/IEC 17025, ANSI/NCSL Z540.1-1994 und ANSI/NCSL Z540.3-2006. Das angewandte Qualitätsmanagement-System ist zertifiziert nach EN ISO 9001. Dieser Kalibrierschein darf nur vollständig und unverändert weiterverbreitet werden. Kalibrierscheine ohne Signifizierungen sind ungültig. Für die Einhaltung einer angemessenen Frist zur Wiederholung der Kalibrierung ist der Benutzer verantwortlich.

Rohde & Schwarz Messgerätebau GmbH

Date of Issue **2021-09-30**
Ausstellungsdatum

Head of Laboratory
Laborleitung

Person Responsible
Bearbeiter

Steigmüller

Johannes Negele

Calibration Method
Kalibrieranweisung

See first page of Outgoing Results

Relative Humidity 20%-60%
Relative Luftfeuchte

Ambient Temperature (23 ⁺¹) °C
Umgebungstemperatur -1

Working standards used (having a significant effect on the accuracy)
Verwendete Gebrauchsnormale (mit signifikantem Einfluss auf die Genauigkeit)

Item Gegenstand	Type Typ	Serial Number Seriennummer	Calibration Certificate Number Kalibrierscheinnummer	Cal. Due Kalibr. bis
Therm.Power Sensor DC-44GHz	NRP-Z55	140170	0023 D-K-15195-01-00 2020-12	2022-02-28
Thermal Waveguide Power Sensor	NRP90TWG	910001	100022 D-K-15195-01-00 2020-10	2021-10-31
Vector Network Analyzer 4 Port	ZVA67	101175	0023 D-K-15195-01-00 2021-03	2022-03-31

Conformity statements take the measurement uncertainties into account.
Die Konformitätsaussagen berücksichtigen die Messunsicherheiten.

Notes

Anmerkungen

Installed options are included in calibration. Depending on installed options, numbers of pages of the record are not consecutive.

Hints

Hinweise

factory used limit = data specification - uncertainty of actual value

DL or DT: Data Limit for symmetrical tolerance limits

FL or FT: Factory Limit for symmetrical tolerance limits

1. In case uncertainties are part of the appendix

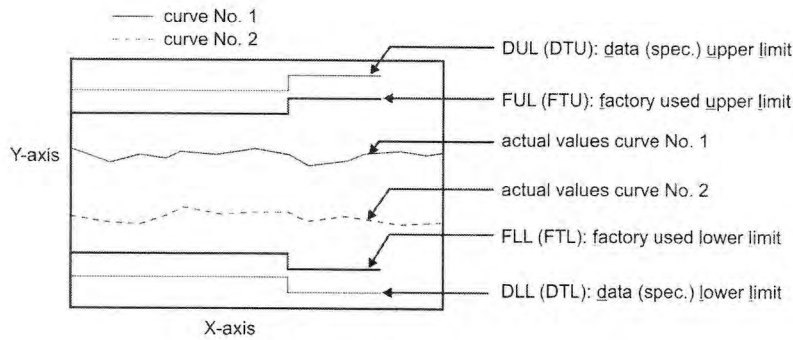

2. In case uncertainties are part of the respective graphic

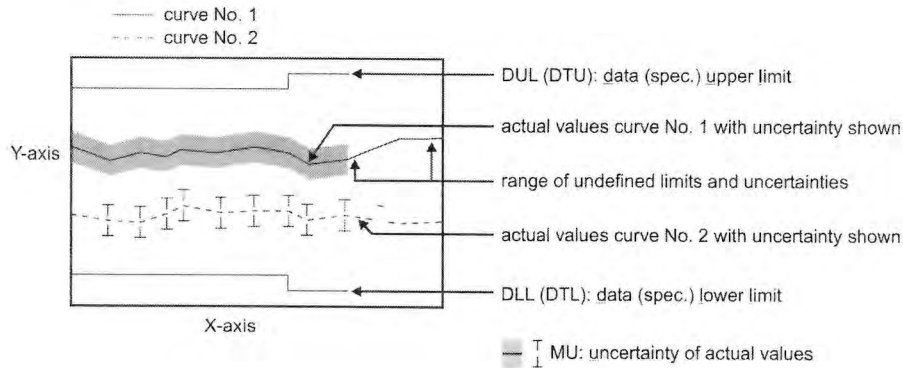

Outgoing Results

Designation:	HARMONIC MIXER
Type:	FS-Z90
Material No.:	1048.0371.02
Serial No.:	101719
Certificate No.:	0001-300618370
Referring to Test Documentation:	5038.8323.01-PB-01.04

Test Department:	3MME3
Name:	Johannes Negele
Date:	2021-09-28



The following abbreviations may be used in this document

- {a} No measurement uncertainty stated because the errors always add together. So it is sure that a measurement result evaluated as "PASS" is pass.
- {b} The measurement uncertainty depends on the measurement result. The stated measurement uncertainty is valid for the close area around the specification. Measurement results outside the close area have a higher measurement uncertainty but are within the specification.
- {c} Functional test, therefore no measurement uncertainty is stated.
- {d} Typical value, refer to performance test.
- {e} The measurement uncertainty is taken into account when setting the measuring system.
- {f} Verification of specified requirements. Technical operation that consist of the determination of one or more characteristics to a specified procedure.

- DL or DT Data Limit for symmetrical tolerance limits
- DLL Datasheet Lower Limit
- DUL Datasheet Upper Limit
- MU Symmetrical Measurement Uncertainty
- MLL or MLV Measurement Uncertainty Lower Value
- MUL or MUV Measurement Uncertainty Upper Value
- Nom. Nominal Value
- Dev. Deviation
- Act. Actual Value
- UGB Uncertainty Guard Band: Measuring uncertainty violates the data (spec.) limit.
- UGB1 A compliance statement may be possible where a confidence level of less than 95 % is acceptable.
- UGB2 A non-compliance statement may be possible where a confidence level of less than 95 % is acceptable.
- DU Datasheet Uncertainty

Explanation of charts

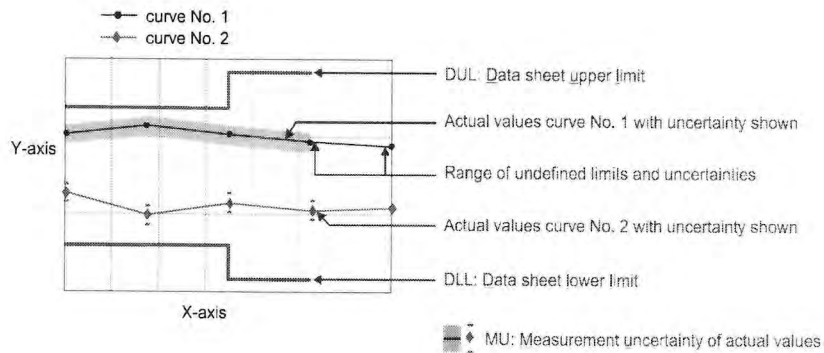

Table of contents

Software used for measurement	4
1. Conversion Loss (6. Harmonic)	5
1.1 Conversion Loss (IF = 404.4 MHz)	5
1.2 Conversion Loss (IF = 729 MHz)	5
1.3 Conversion Loss (IF = 1330 MHz)	6
1.4 Continuity response within 1 GHz	6

Software used for measurement			
Item	Type	Version	Remark
Suite	Setup	V12.10.02	Test Management Software G5
Test Program (7012.8706.00_)	Component	V01.05	

1. Conversion Loss (6. Harmonic)

1.1 Conversion Loss (IF = 404.4 MHz)

IF = 404.4 MHz, 6. Harmonic

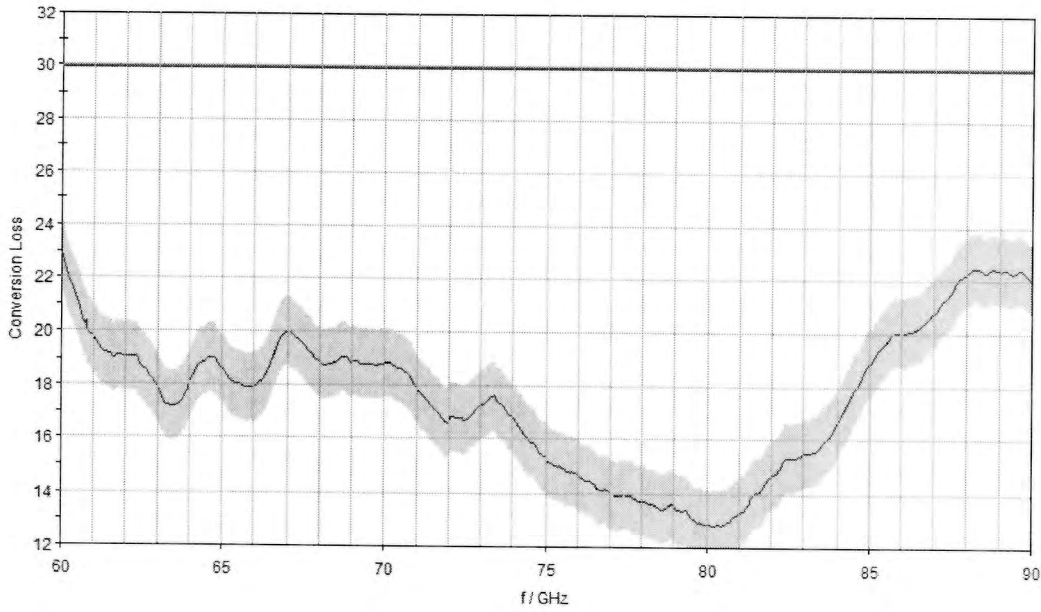

1.2 Conversion Loss (IF = 729 MHz)

IF = 729 MHz, 6. Harmonic

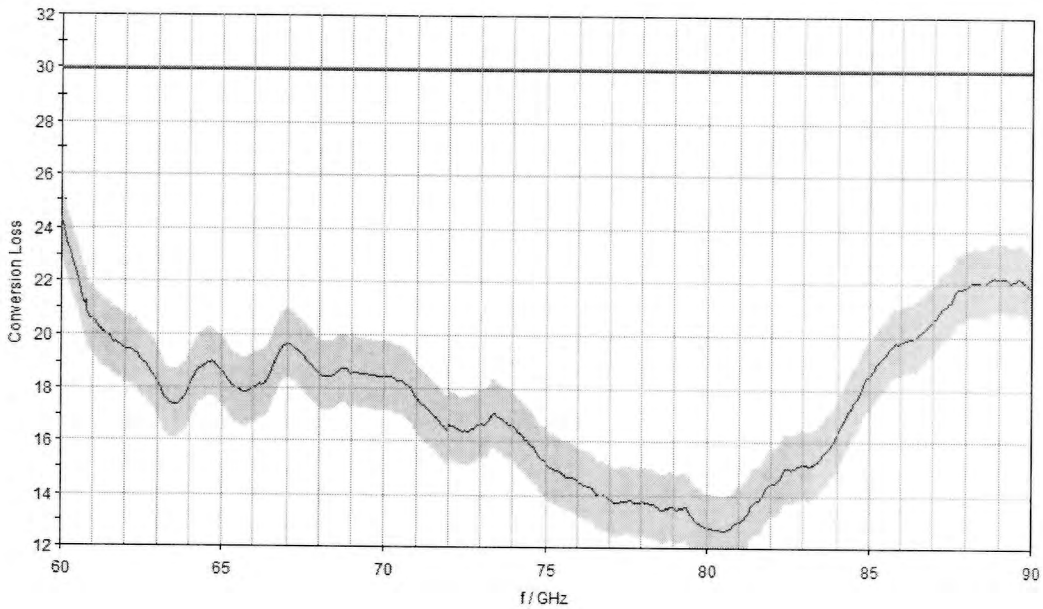

1.3 Conversion Loss (IF = 1330 MHz)

IF = 1330 MHz, 6. Harmonic

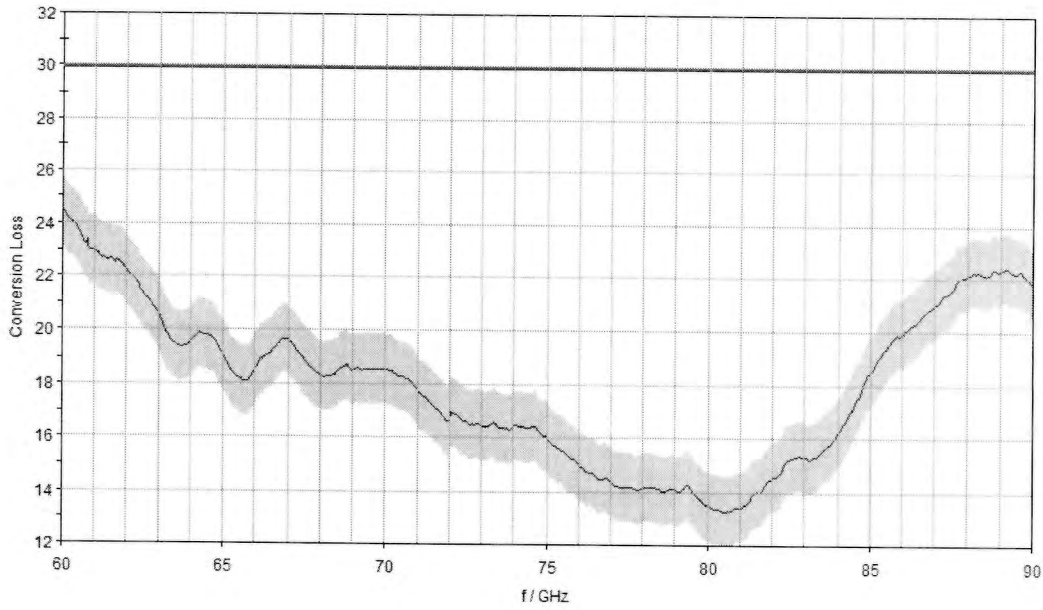

1.4 Continuity response within 1 GHz

Continuity response within any 1 GHz Band, 6. Harmonic

	DUL /dB	Continuity /dB
max. at IF = 404.4 MHz:	6.0	3.15
max. at IF = 729 MHz:	6.0	3.76
max. at IF = 1330 MHz:	6.0	2.32

Incoming Results

Designation:	HARMONIC MIXER
Type:	FS-Z90
Material No.:	1048.0371.02
Serial No.:	101719
Certificate No.:	0001-300618370
Referring to Test Documentation:	5038.8323.01-PB-01.04

Test Department:	3MME3
Name:	Johannes Negele
Date:	2021-09-28



The following abbreviations may be used in this document

- {a} No measurement uncertainty stated because the errors always add together. So it is sure that a measurement result evaluated as "PASS" is pass.
 - {b} The measurement uncertainty depends on the measurement result. The stated measurement uncertainty is valid for the close area around the specification. Measurement results outside the close area have a higher measurement uncertainty but are within the specification.
 - {c} Functional test, therefore no measurement uncertainty is stated.
 - {d} Typical value, refer to performance test.
 - {e} The measurement uncertainty is taken into account when setting the measuring system.
 - {f} Verification of specified requirements. Technical operation that consist of the determination of one or more characteristics to a specified procedure.
- DL or DT Data Limit for symmetrical tolerance limits
 DLL Datasheet Lower Limit
 DUL Datasheet Upper Limit
 MU Symmetrical Measurement Uncertainty
 MLL or MLV Measurement Uncertainty Lower Value
 MUL or MUV Measurement Uncertainty Upper Value
 Nom. Nominal Value
 Dev. Deviation
 Act. Actual Value
 UGB Uncertainty Guard Band: Measuring uncertainty violates the data (spec.) limit.
 UGB1 A compliance statement may be possible where a confidence level of less than 95 % is acceptable.
 UGB2 A non-compliance statement may be possible where a confidence level of less than 95 % is acceptable.
 DU Datasheet Uncertainty

Explanation of charts

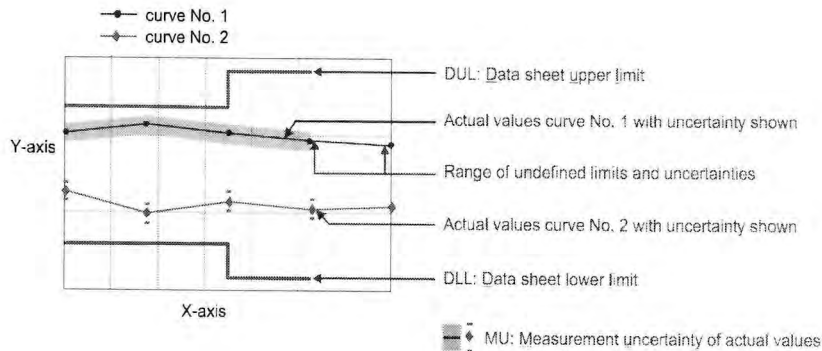

Table of contents

Software used for measurement	4
1. Conversion Loss (6. Harmonic)	5
1.1 Conversion Loss (IF = 404.4 MHz)	5
1.2 Conversion Loss (IF = 729 MHz)	5
1.3 Conversion Loss (IF = 1330 MHz)	6
1.4 Continuity response within 1 GHz	6

Incoming Results

Software used for measurement			
Item	Type	Version	Remark
Suite	Setup	V12.10.02	Test Management Software G5
Test Program (7012.8706.00_)	Component	V01.05	

1. Conversion Loss (6. Harmonic)

1.1 Conversion Loss (IF = 404.4 MHz)

IF = 404.4 MHz, 6. Harmonic

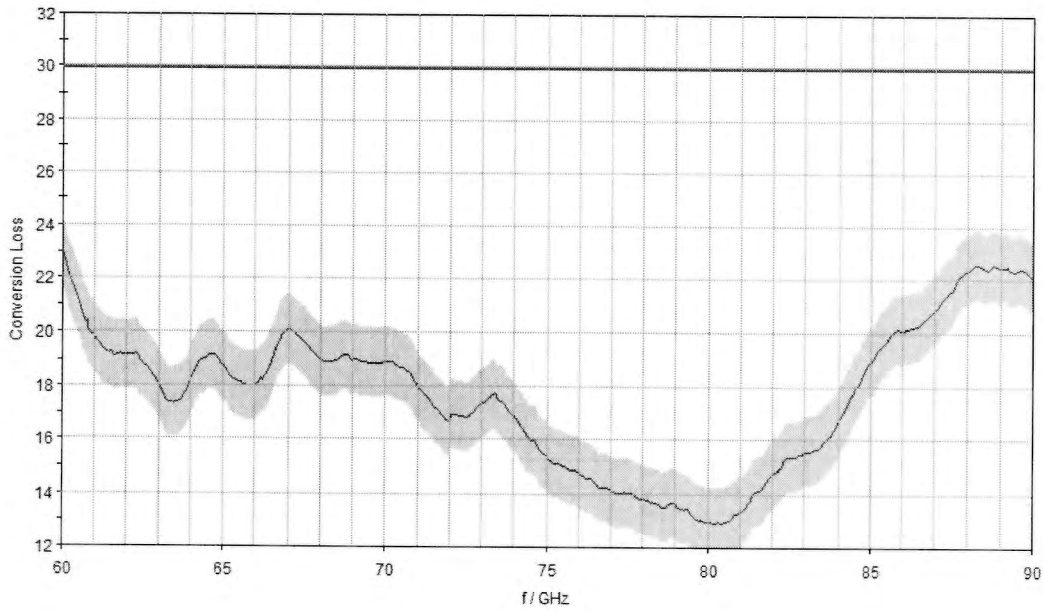

1.2 Conversion Loss (IF = 729 MHz)

IF = 729 MHz, 6. Harmonic

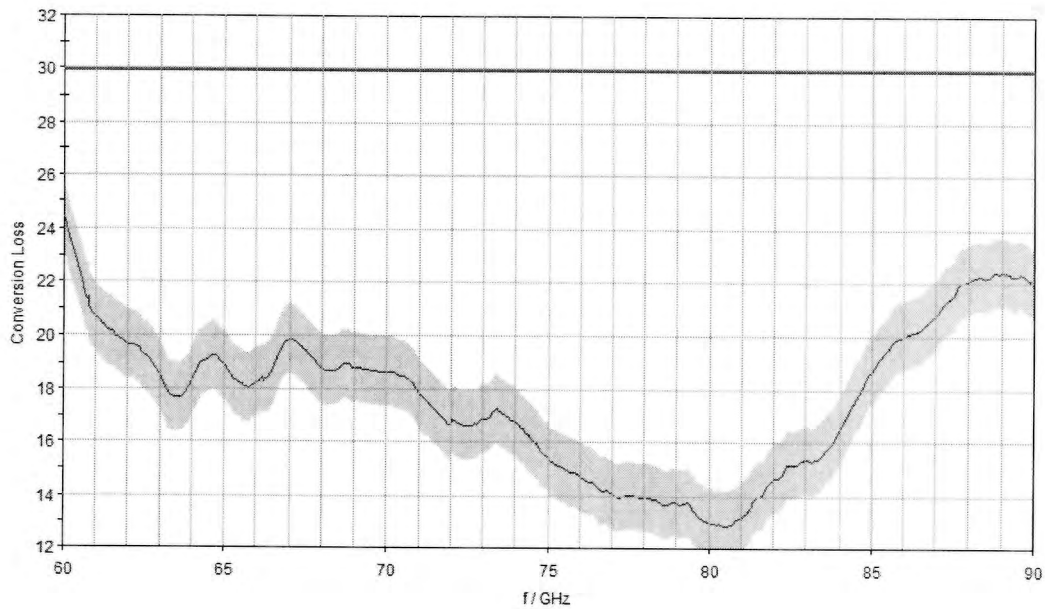

Incoming Results

1.3 Conversion Loss (IF = 1330 MHz)

IF = 1330 MHz, 6. Harmonic

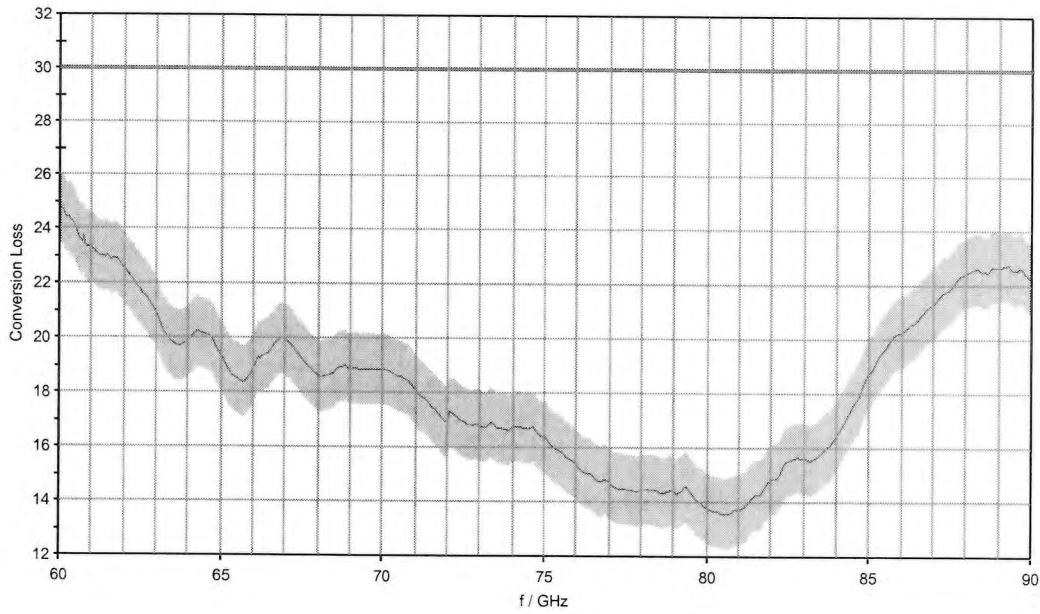

1.4 Continuity response within 1 GHz

Continuity response within any 1 GHz Band, 6. Harmonic

	DUL /dB	Continuity /dB
max. at IF = 404.4 MHz:	6.0	3.20
max. at IF = 729 MHz:	6.0	3.75
max. at IF = 1330 MHz:	6.0	2.33

Incoming Results



Calibration Certificate

Certificate Number 24-0140-101008-02

Kalibrierschein

Zertifikatsnummer

Unit Data

Item Harmonic Mixer, 90 GHz to 140 GHz
Gegenstand

Manufacturer RPG Radiometer-Physics GmbH
Hersteller

Type RPG FS-Z140
Typ

Material Number 3622.0708.02 **Serial Number** 101008
Materialnummer Seriennummer

Asset Number
Inventarnummer

This calibration certificate documents, that the named item is tested and measured against defined specifications. Measurement results are located usually in the corresponding interval with a probability of approx. 95% (coverage factor $k = 2$). Calibration is performed with test equipment and standards directly or indirectly traceable by means of approved calibration techniques to the PTB/DKD or other national/international standards, which realize the physical units of measurement according to the International System of Units (SI). In all cases where no standards are available, measurements are referenced to standards of the R&S laboratories. Principles and methods of calibration correspond with EN ISO/IEC 17025. This calibration certificate may not be reproduced other than in full. Calibration certificates without signatures are not valid. The user is obliged to have the object recalibrated at appropriate intervals.

Order Data

Customer Nokia of America Corp
Auftraggeber
Mountain Ave 600
UNION
07974-0636 Murray Hill
US

Order Number 8800011537
Bestellnummer

Date of Receipt 2021-10-06
Eingangsdatum

Dieser Kalibrierschein dokumentiert, dass der genannte Gegenstand nach festgelegten Vorgaben geprüft und gemessen wurde. Die Messwerte lagen im Regelfall mit einer Wahrscheinlichkeit von annähernd 95% im zugeordneten Werteintervall (Erweiterte Messunsicherheit mit $k = 2$). Die Kalibrierung erfolgte mit Messmitteln und Normalen, die direkt oder indirekt durch Ableitung mittels anerkannter Kalibriertechniken rückgeführt sind auf Normale der PTB/DKD oder anderer nationaler/internationaler Standards zur Darstellung der physikalischen Einheiten in Übereinstimmung mit dem Internationalen Einheitensystem (SI). Wenn keine Normale existieren, erfolgt die Rückführung auf Bezugsnormale der R&S-Laboratorien. Grundsätze und Verfahren der Kalibrierung beziehen sich auf EN ISO/IEC 17025. Dieser Kalibrierschein darf nur vollständig und unverändert weiterverbreitet werden. Kalibrierscheine ohne Unterschriften sind ungültig. Für die Einhaltung einer angemessenen Frist zur Wiederholung der Kalibrierung ist der Benutzer verantwortlich.

Performance

Place and Date of Calibration Meckenheim, 2021-10-07
Ort und Datum der Kalibrierung

Scope of Calibration Standard Calibration
Umfang der Kalibrierung

Statement of Compliance Defective
(Incoming)
Konformitätsaussage
(Anlieferung)

Statement of Compliance All measured values are within the data sheet
(Outgoing) specifications.
Konformitätsaussage
(Auslieferung)

Extend of Calibration Documents 2 pages Calibration Certificate
Umfang des Kalibrierdokuments 4 pages Outgoing Results

RPG Radiometer-Physics GmbH; Meckenheim

Date of Issue
Ausstellungsdatum

2021-10-29

Head of Laboratory
Laborleitung

Schulze

Person Responsible
Bearbeiter

Gottbehuet

Page (Seite) 1/2
Vers2010-05-05/
RPG2014-02-28

Calibration Method
Kalibrieranweisung

RPG-PAQA-TN-2014-002

Relative Humidity 20 % - 80 %
Relative Luftfeuchte

Ambient Temperature
Umgebungstemperatur

(23 ⁺⁷/₋₃) °C

Working standards used (having a significant effect on the accuracy) Verwendete Gebrauchsnormale (mit signifikantem Einfluss auf die Genauigkeit)				
Item Gegenstand	Type Typ	Serial Number Seriennummer	Calibration Certificate Number Kalibrierscheinnummer	Cal. Due Kalibr. bis
Vector Network Analyzer	R&S® ZVA40	100103	582870_D-K-15195-01-00_2021-01	2024-01-04
Powersensor	R&S® NRP-Z55	140093	601310_D-K-15195-01-00_2021-05	2023-05-28

UGB1	A compliance statement may be possible where a confidence level of less than 95 % is acceptable. Die Bestätigung der Konformität ist möglich, sofern ein Grad des Vertrauens von weniger als 95 % akzeptabel ist.
UGB2	A non-compliance statement may be possible where a confidence level of less than 95 % is acceptable. Die Bestätigung der Nicht-Konformität ist möglich, sofern ein Grad des Vertrauens von weniger als 95 % akzeptabel ist.
Ref.: ILAC-G8:03/2009 'Guidelines on the Reporting of Compliance with Specification'.	

Notes

Anmerkungen

If the new product is stored under the climate conditions as specified in the data sheet upon delivery, the product's accuracy is not significantly affected within 12 month after its calibration in our factory. In this case, the recommended calibration interval starts on the date when the product is actually put into operation.

Outgoing Results

The following abbreviations may be used in this document

- {a} No measurement uncertainty stated because the errors always add together.
So it is sure that a measurement result evaluated as "PASS" is pass.
- {b} The measurement uncertainty depends on the measurement result. The stated measurement uncertainty is valid for the close area around the specification. Measurement results outside the close area have a higher measurement uncertainty but are within the specification.
- {c} Functional test, therefore no measurement uncertainty is stated.
- {d} Typical value, refer to performance test.
- {e} The measurement uncertainty is taken into account when setting the measuring system.
- DL or DT Data Limit for symmetrical tolerance limits
- DLL Datasheet Lower Limit
- DUL Datasheet Upper Limit
- MU Measurement Uncertainty
- MLL or MLV Measurement Uncertainty Lower Value
- MUL or MUV Measurement Uncertainty Upper Value
- Nom. Nominal Value
- Dev. Deviation
- MErr. Measurement Error
- Act. Actual Value
- UGB Uncertainty Guard Band: Measuring uncertainty violates the data (spec.) limit.
- UGB1 Measurement results marked as UGB1 show conformity with a probability of >50 % and <95 %.
- UGB2 Measurement results marked as UGB2 show non-conformity with a probability of >50 % and <95 %.
- DU Datasheet Uncertainty

Explanation of charts

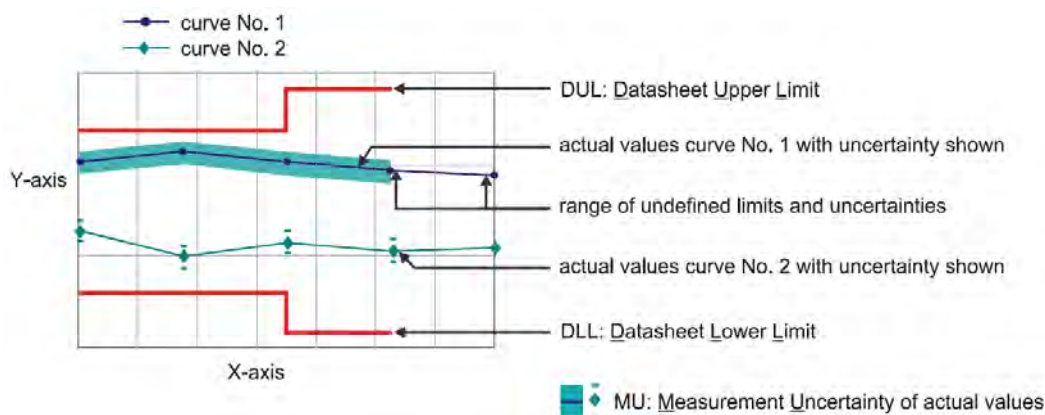

Software used for measurement**Item Type**Measurement Studio Professional Edition
MixerCertification**Version**2013
7_15**Remark**

1.1 Conversion loss

LO level +14 dBm nominal
 Bias 0 A

Measurement uncertainty: 3.5 dB

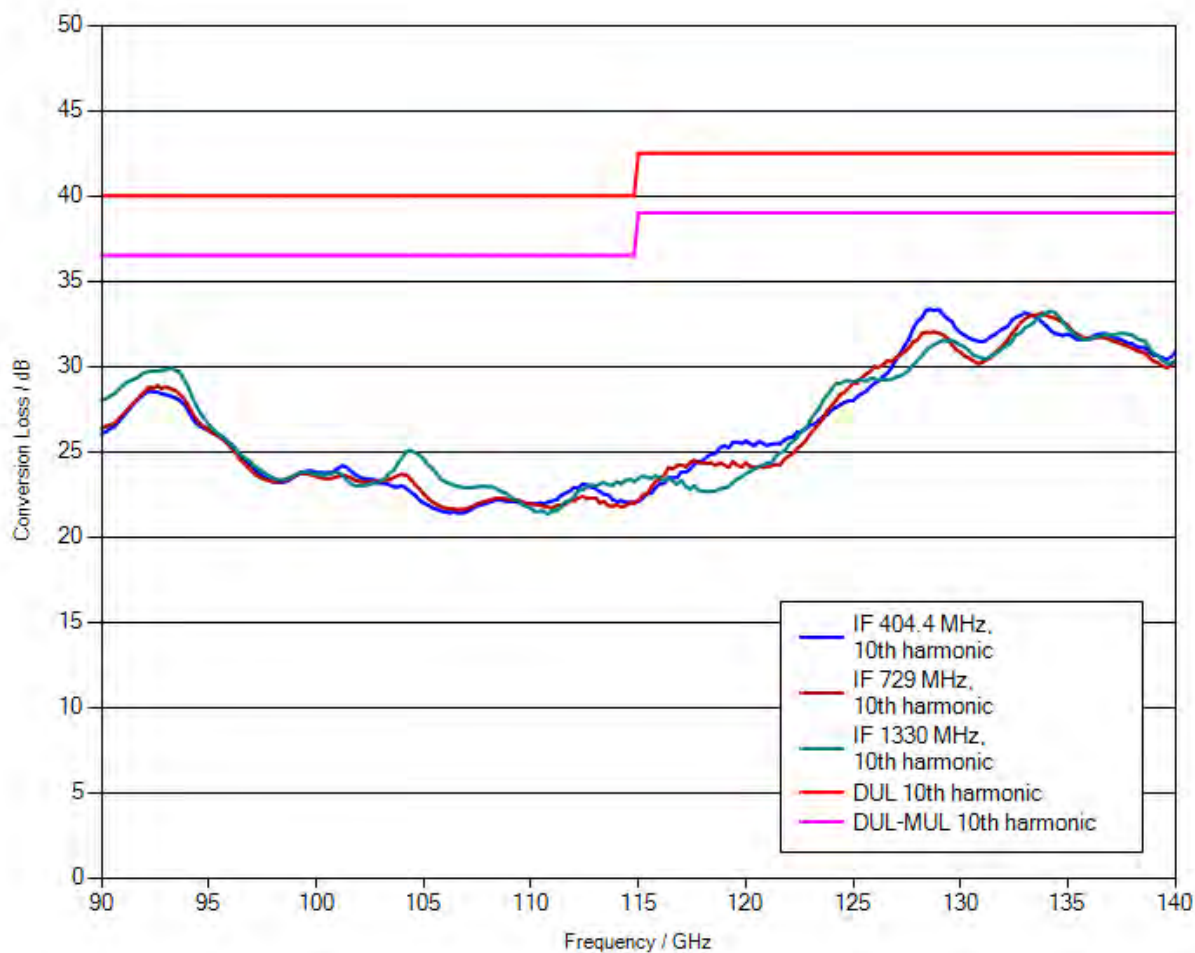

Note: Numeric calibration data can be found attached to the PDF file of the calibration certificate. Click the “paper clip” symbol to display the file.

The file has been renamed for safety reasons. When downloading the file onto your PC, please delete the “.file” extension and unzip the data.

1.2 Frequency response within 1 GHz

	DUL	Actual (worst case)	Evaluation
IF = 404.4 MHz, 10th harmonic	6 dB	1.87 dB	PASS
IF = 729 MHz, 10th harmonic	6 dB	1.56 dB	PASS
IF = 1330 MHz, 10th harmonic	6 dB	2.06 dB	PASS