

EXHIBIT 3

Section 2.1033 (b)(14) SETUP DRAWINGS OR PHOTOGRAPHS

Contain at least one drawing or photograph showing the test set-up for each of the required types of tests applicable to the device for which certification is requested. These drawings or photographs must show enough detail to confirm other information contained in the test report. Any photographs used must be focused originals without glare or dark spots and must clearly show the test configuration used.

ANSI C63.4 Section 10.2.3 Equipment and cable arrangement

The setup of the equipment and cable or wire placement on the test site that produces the highest radiated and the highest ac power-line conducted emissions shall be clearly shown and described. Drawings or photographs may be used for this purpose (see 10.2.12). A block diagram or photo showing the interconnection of the major functional units is also useful.

ANSI C63.4 Section 10.2.12 Test report appendixes

The test report shall contain photographs or detailed sketches of the EUT configuration and arrangement, showing sufficient information to allow the EUT to be reconfigured and arranged in a manner that would allow the original test to be replicated, with a high likelihood that the test results would be in agreement with the results of the original test within acceptable tolerances.

Response

The setup drawings and photos for measurement are provided below.

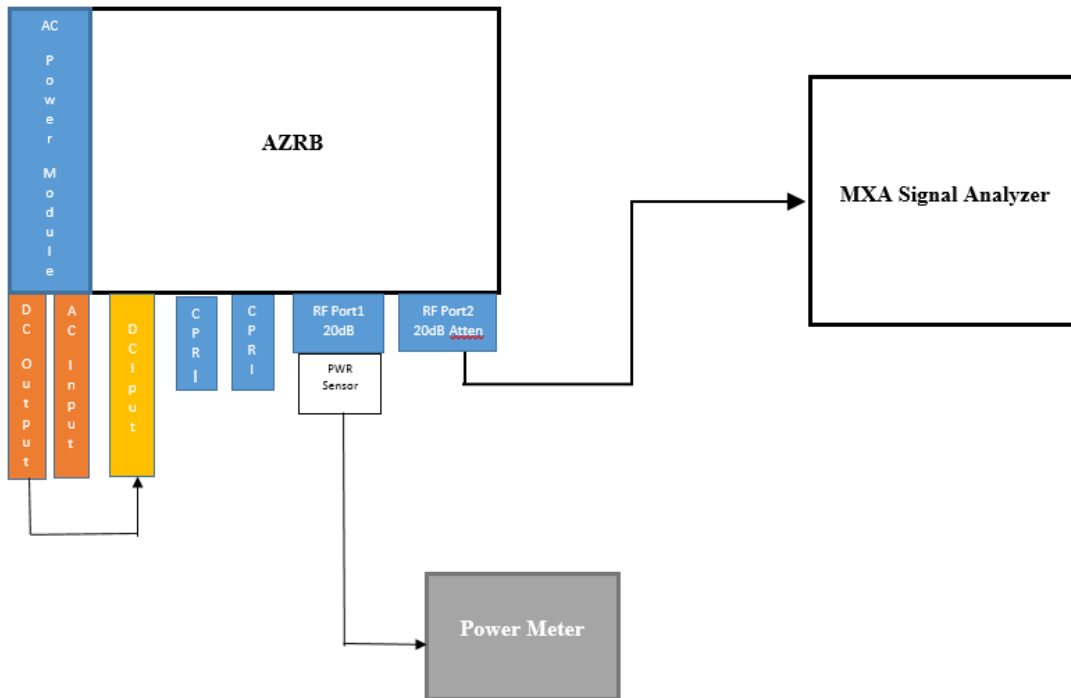

Figure 1. Setup Diagram of Conducted Test

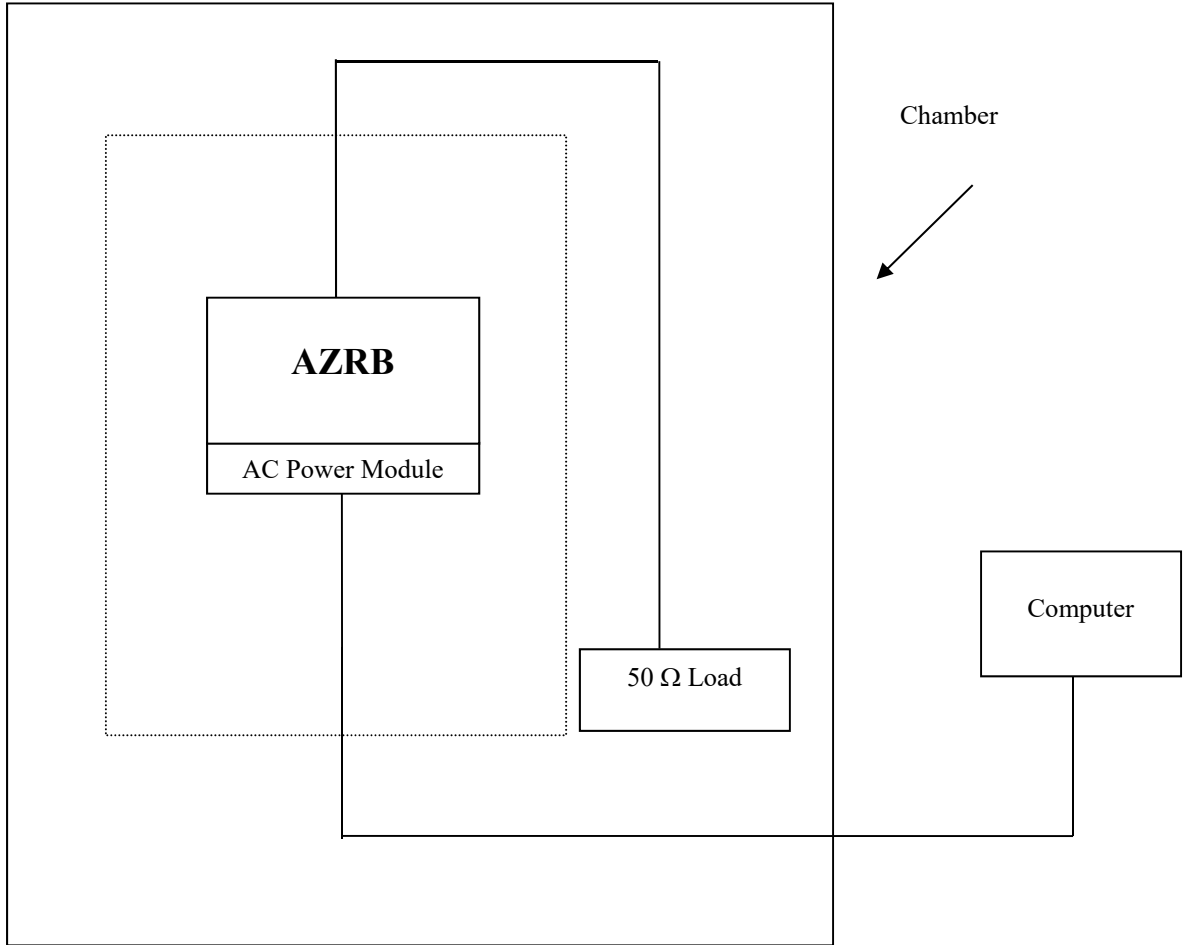

Figure 2. Setup Diagram of Radiated Test

Master with injection at the Master

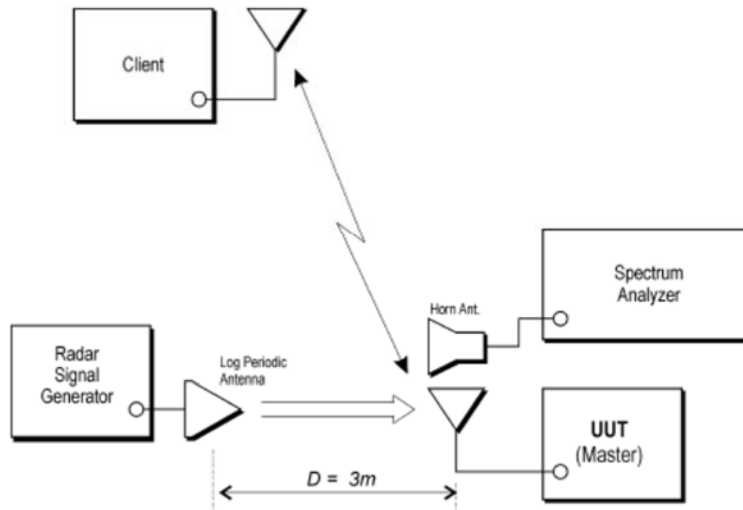

Figure 3. Setup Diagram of DFS Test

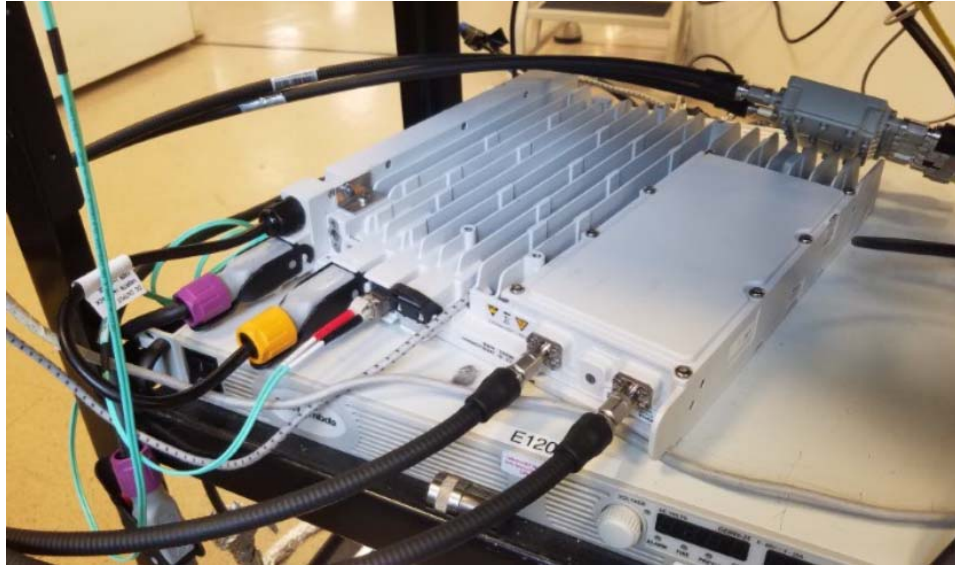

Figure 4. Setup Diagram of Conducted Test



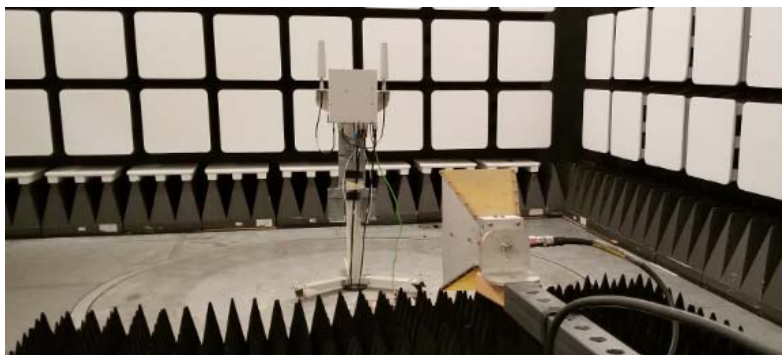
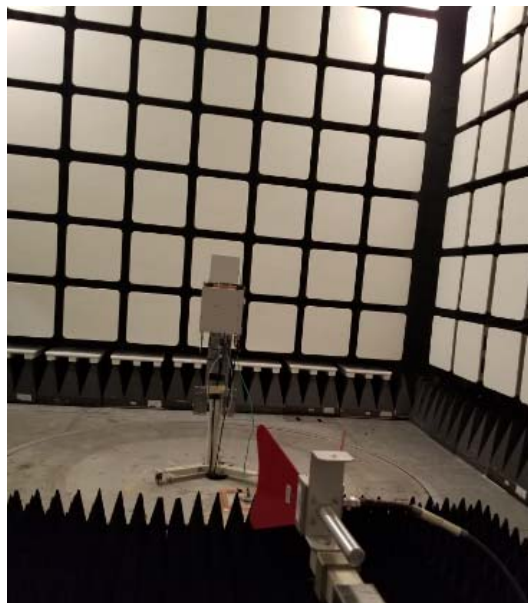

Figure 5. Setup Photos of Radiated Test for AZRB with Various Antennas (BA-AIO3O3T3T3VJX65F-06, PAS2457-CC1, GO4806-06664, 2205 & FA2RA)

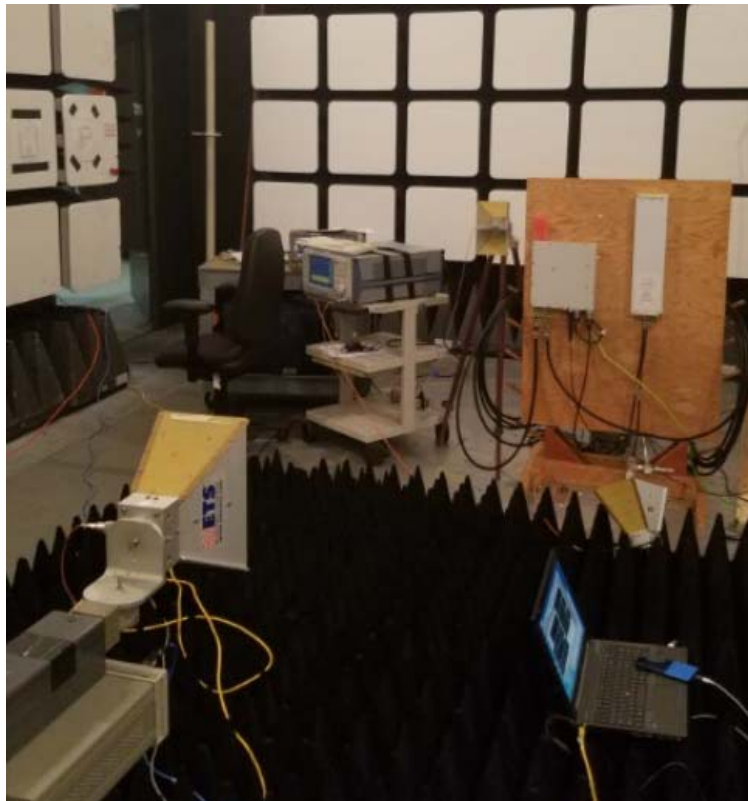
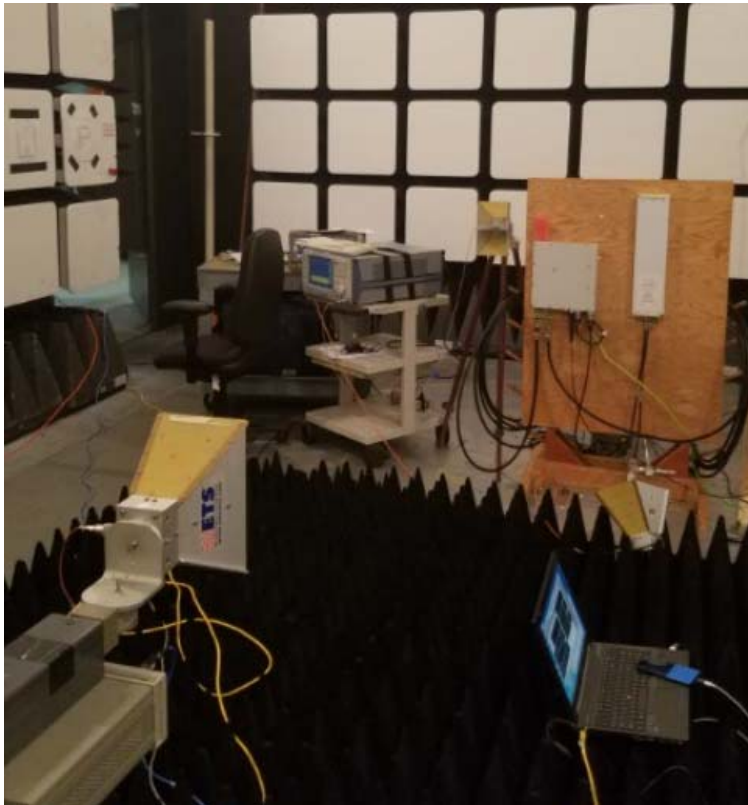

Figure 6. Setup Photos of DFS Test of AZRB with PAS2457-CC1 Antenna