



RF MEASUREMENT REPORT

FCC ID: 2AD8UAWHHC01
Applicant: Nokia Solutions and Networks, OY
Product: AirScale Indoor Radio ASiR 5G-pRRH
Model No.: AWHHC
Brand Name: Nokia
FCC Rule(s): Part 2, 27 (M)
Result: Complies
Received Date: 2024-04-09
Test Date: 2024-04-09 ~ 2024-04-14

Reviewed By:

Sunny Sun

Approved By:

Robin Wu



The test results relate only to the samples tested.

This equipment has been shown to be capable of compliance with the applicable technical standards as indicated in the measurement report and was tested in accordance with the measurement procedures specified in ANSI C63.26-2015. Test results reported herein relate only to the item(s) tested.

The test report shall not be reproduced except in full without the written approval of MRT Technology (Suzhou) Co., Ltd.

Revision History

Report No.	Version	Description	Issue Date	Note
2404RSU017-U1	V01	Initial Report	2024-04-23	Valid

Note: This report is prepared for FCC Class II permissive supplement to FCC ID: 2AD8UAWHHC01, adding 5G NR 49.5MHz and related data.

CONTENTS

Description	Page
1. General Information	5
1.1. Applicant	5
1.2. Manufacturer.....	5
1.3. Testing Facility	5
1.4. Product Information	6
1.5. Radio Specification under Testing	6
1.6. Description of Available Antennas	6
1.7. Test Methodology	7
2. Test Configuration	8
2.1. Test Mode	8
2.2. Test System Connection Diagram	8
2.3. Test Environment Condition.....	8
3. Measuring Instrument	9
4. Decision Rules and Measurement Uncertainty	10
4.1. Decision Rules.....	10
4.2. Measurement Uncertainty	10
5. Test Result.....	11
5.1. Summary	11
5.2. Occupied Bandwidth Measurement	12
5.2.1. Test Limit.....	12
5.2.2. Test Procedure	12
5.2.3. Test Setting	12
5.2.4. Test Setup.....	12
5.2.5. Test Result	12
5.3. Equivalent Isotropically Radiated Power Measurement	13
5.3.1. Test Limit.....	13
5.3.2. Test Procedure	13
5.3.3. Test Setting	13
5.3.4. Test Setup.....	14
5.3.5. Test Result	14
5.4. Peak to Average Ratio Measurement.....	15
5.4.1. Test Limit.....	15
5.4.2. Test Procedure	15
5.4.3. Test Setting	15

5.4.4.	Test Setup.....	15
5.4.5.	Test Result.....	15
5.5.	Conducted Band Edge Unwanted Emissions Measurement	16
5.5.1.	Test Limit.....	16
5.5.2.	Test Procedure	16
5.5.3.	Test Setting.....	16
5.5.4.	Test Setup.....	17
5.5.5.	Test Result.....	17
5.6.	Conducted Spurious Unwanted Emissions Measurement	18
5.6.1.	Test Limit.....	18
5.6.2.	Test Procedure	18
5.6.3.	Test Setting.....	18
5.6.4.	Test Setup.....	19
5.6.5.	Test Result.....	19
Appendix A - Test Result.....		20
A.1	Occupied Bandwidth Test Result.....	20
A.2	Equivalent Isotropically Radiated Power Test Result	21
A.3	Peak to Average Ratio Test Result.....	23
A.4	Conducted Band Edge Unwanted Emissions Test Result.....	24
A.5	Conducted Spurious Unwanted Emissions Test Result	26
Appendix B - Test Setup Photograph		27
Appendix C - EUT Photograph		28

1. General Information

1.1. Applicant

Nokia Solutions and Networks, OY
2000 W. Lucent Lane, Naperville, Illinois, United States, 60563

1.2. Manufacturer

Nokia Solutions and Networks, OY
2000 W. Lucent Lane, Naperville, Illinois, United States, 60563

1.3. Testing Facility

<input checked="" type="checkbox"/>	<p>Test Site - MRT Suzhou Laboratory</p> <hr/> <p>Laboratory Location (Suzhou - Wuzhong) D8 Building, No.2 Tian'edang Rd., Wuzhong Economic Development Zone, Suzhou, China</p> <p>Laboratory Location (Suzhou - SIP) 4b Building, Liando U Valley, No.200 Xingpu Rd., Shengpu Town, Suzhou Industrial Park, China</p> <hr/> <p>Laboratory Accreditations</p> <p>A2LA: 3628.01 CNAS: L10551 FCC: CN1166 ISED: CN0001</p> <p>VCCI: <input type="checkbox"/>R-20025 <input type="checkbox"/>G-20034 <input type="checkbox"/>C-20020 <input type="checkbox"/>T-20020 <input type="checkbox"/>R-20141 <input type="checkbox"/>G-20134 <input type="checkbox"/>C-20103 <input type="checkbox"/>T-20104</p>
<input type="checkbox"/>	<p>Test Site - MRT Shenzhen Laboratory</p> <hr/> <p>Laboratory Location (Shenzhen) 1G, Building A, Junxiangda Building, Zhongshanyuan Road West, Nanshan District, Shenzhen, China</p> <hr/> <p>Laboratory Accreditations</p> <p>A2LA: 3628.02 CNAS: L10551 FCC: CN1284 ISED: CN0105</p>
<input type="checkbox"/>	<p>Test Site - MRT Taiwan Laboratory</p> <hr/> <p>Laboratory Location (Taiwan) No. 38, Fuxing 2nd Rd., Guishan Dist., Taoyuan City 333, Taiwan (R.O.C.)</p> <hr/> <p>Laboratory Accreditations</p> <p>TAF: 3261 FCC: 291082, TW3261 ISED: TW3261</p>

1.4. Product Information

Product Name	AirScale Indoor Radio ASiR 5G-pRRH
Model No.	AWHHC
Brand Name	Nokia
Serial No.	NH191503038
Operating Band (s)	5G NR Band n41, LTE Band 41 250mW, per Tx path (4T4R & 2T2R)
Power Supply Rating	PoE (52.0 ~ 57.0Vdc)
Antenna Specification	Refer to Section 1.6
Remark: The information of EUT was provided by the manufacturer, and the accuracy of the information shall be the responsibility of the manufacturer.	

1.5. Radio Specification under Testing

NR Band Specification	
Single Band	5G NR n41
Tx Frequency Range	2496 ~ 2690 MHz
Rx Frequency Range	2496 ~ 2690 MHz
Modulation	QPSK, 16QAM, 64QAM, 256QAM
Max EIRP Power	49.5 MHz: 42.62 dBm

1.6. Description of Available Antennas

Band Support	Antenna Type	Model	Antenna Gain (dBi)	Directional Gain (dBi)	
				2*2 MIMO	4*4 MIMO
NR n41 & LTE Band 41	Directional Antenna	G10804-06846	6.4	9.41	12.42
Remark: 1. The transmit signals are correlated, the directional gain = $G_{ANT} + 10 \log (N_{ANT}/N_{SS})$ dBi, where N_{SS} = the number of independent spatial streams of data and G_{ANT} is the antenna gain in dBi. 2. This device supports both 2*2 Tx & 4*4 Tx modes of operation, configured by SW. When operating in 2*2 TX mode, only Ant 0 & 1 transmit ports are actively transmitting.					

1.7. Test Methodology

According to the specifications of the manufacturer, the EUT must comply with the requirements of the following standards:

- ANSI C63.26:2015
- FCC CFR 47 Part 2, Part 27
- FCC KDB 971168 D01 v03r01: Power Meas License Digital Systems
- FCC KDB 971168 D02 v02r01: Misc Rev Approv License Devices
- FCC KDB 412172 D01 v01r01: Determining ERP and EIRP
- FCC KDB 662911 D01 v02r01: Multiple Transmitter Output

2. Test Configuration

2.1. Test Mode

Test Item	Channel Bandwidth	Modulation
Occupied bandwidth	49.5 MHz	QPSK, 16QAM, 64QAM, 256QAM
Equivalent Isotropically Radiated Power		QPSK, 16QAM, 64QAM, 256QAM
Peak to Average Ratio		QPSK, 16QAM, 64QAM, 256QAM
Conducted Band Edge Unwanted Emissions		16QAM
Conducted Spurious Unwanted Emissions		16QAM

2.2. Test System Connection Diagram

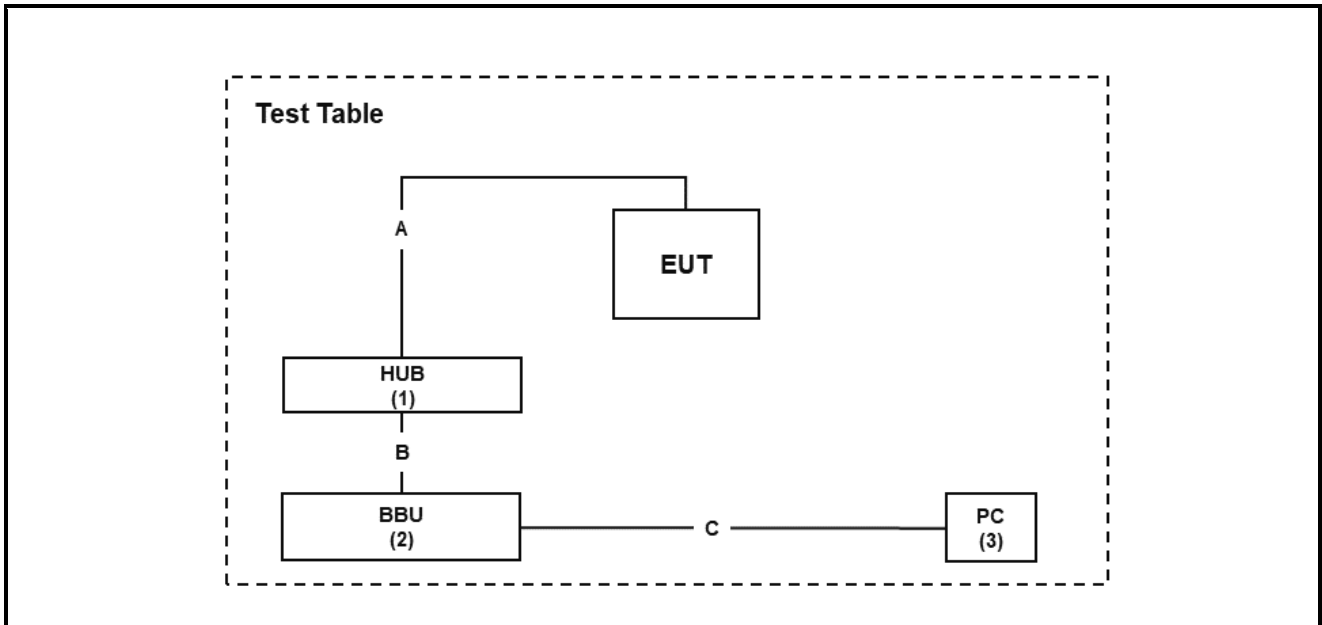

No.	Cable Type	Cable Spec.	Length
A	LAN cable	Non-Shielding	>10.0m
B	Optical fiber cable	Non-Shielding	>10.0m
C	LAN cable	Non-Shielding	2.0m
No.	Product	Manufacturer	Model No.
1	HUB	Nokia	APHA
2	BBU	Nokia	ASIL+ABIO
3	Personal Computer	HP	TPN-C143

2.3. Test Environment Condition

Ambient Temperature	15 ~ 35°C
Relative Humidity	20 ~ 75%RH

3. Measuring Instrument

Instrument Name	Manufacturer	Model No.	Asset No.	Cali. Interval	Cal. Due Date	Test Site
Thermohygrometer	testo	608-H1	MRTSUE06362	1 year	2025-02-04	WZ-SR6
Shielding Room	HUAMING	WZ-SR6	MRTSUE06443	N/A	N/A	WZ-SR6
Signal Analyzer	Keysight	N9020B	MRTSUE06583	1 year	2024-09-27	WZ-SR6
Attenuator	MVE	MVE2365	MRTSUE07070	1 year	2024-11-27	WZ
Attenuator	MVE	MVE2365	MRTSUE07071	1 year	2024-11-27	WZ

4. Decision Rules and Measurement Uncertainty

4.1. Decision Rules

The Decision Rule is based on Simple Acceptance in accordance with ISO Guide 98-4: 2012 Clause 8.2. (Measurement uncertainty is not taken into account when stating conformity with a specified requirement.)

4.2. Measurement Uncertainty

Where relevant, the following test uncertainty levels have been estimated for tests performed on the EUT as specified in CISPR 16-4-2. This uncertainty represents an expanded uncertainty expressed at approximately the 95% confidence level using a coverage factor of $k = 2$.

Conducted Spurious Emissions
Measuring Uncertainty for a Level of Confidence of 95% ($U=2Uc(y)$): 1.47dB
Output Power
Measuring Uncertainty for a Level of Confidence of 95% ($U=2Uc(y)$): 0.66dB
Occupied Bandwidth
Measuring Uncertainty for a Level of Confidence of 95% ($U=2Uc(y)$): 69.28kHz

5. Test Result

5.1. Summary

FCC Section(s)	Test Description	Test Condition	Verdict
2.1049.	Occupied bandwidth	Conducted	Pass
2.1046	Peak to Average Ratio		Pass
2.1046; 27.50(h)(1)(i)	Equivalent Isotropically Radiated Power		Pass
2.1051; 27.53(m)(2)(v)	Conducted Band Edge Unwanted Emissions		Pass
2.1051; 27.53(m)(2)(v)	Conducted Spurious unwanted Emissions		Pass

Notes:

- 1) The analyzer plots shown in this section were all taken with a correction table loaded into the analyzer. The correction table was used to account for the losses of the cables and attenuators used as part of the system to connect the EUT to the analyzer at all frequencies of interest.
- 2) The Occupied Bandwidth, Peak to Average Ratio and Conducted Unwanted Emissions were presented the worst test data of modulation & antenna port in the test report.

5.2. Occupied Bandwidth Measurement

5.2.1. Test Limit

The occupied bandwidth, that is the frequency bandwidth such that, below its lower and above its upper frequency limits, the mean powers radiated are each equal to 0.5 percent of the total mean power radiated by a given emission shall be measured.

5.2.2. Test Procedure

ANSI C63.26-2015 - Section 5.4.4

5.2.3. Test Setting

1. Set center frequency to the nominal EUT channel center frequency
2. RBW = The nominal RBW shall be in the range of 1% to 5% of the anticipated OBW
3. VBW $\geq 3 \times$ RBW
4. Detector = Peak
5. Trace mode = max hold
6. Sweep = auto couple
7. Allow the trace to stabilize
8. Use the 99% power bandwidth function of the instrument and report the measured bandwidth.

5.2.4. Test Setup

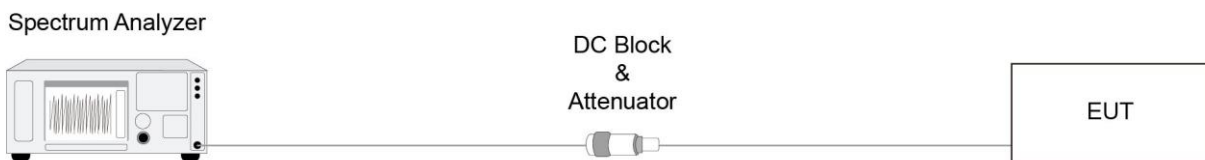

5.2.5. Test Result

Refer to Appendix A.1.

5.3. Equivalent Isotropically Radiated Power Measurement

5.3.1. Test Limit

According to the specific rule 27.50(h)(1), the following power limits shall apply in the BRS and EBS: Main, booster and base stations.(i) The maximum EIRP of a main, booster or base station shall not exceed 33 dBW +10log(X/Y) dBW, where X is the actual channel width in MHz and Y is either 6 MHz if prior to transition or the station is in the MBS following transition or 5.5 MHz if the station is in the LBS and UBS following transition, except as provided in paragraph (h)(1)(ii) of this section.

For 49.5MHz Bandwidth: The EIRP limit = 33 + 30 + 10*log (49.5/6) = 72.16dBm

5.3.2. Test Procedure

ANSI C63.26-2015 - Section 5.2.4.4

5.3.3. Test Setting

Average Power Density Measurement

1. Set span to 2 x to 3 x the OBW;
2. Set RBW = 1% to 5% of the OBW;
3. Set VBW \geq 3 x RBW;
4. Set number of measurement points in sweep \geq 2 x span / RBW;
5. Sweep time set to auto;
6. Detector = power averaging (rms);
7. If the EUT can be configured to transmit continuously, then set the trigger to free run;
8. If the EUT cannot be configured to transmit continuously, then use a sweep trigger with the level set to enable triggering only on full power bursts and configure the EUT to transmit at full power for the entire duration of each sweep.
9. Trace average at least 100 traces in power averaging (rms) mode if sweep is set to auto-couple. To accurately determine the average power over multiple symbols, it can be necessary to increase the number of traces to be averaged above 100 or, if using a manually configured sweep time, increase the sweep time.
10. Compute power by integrating the spectrum across the specified bandwidth of the signal using the instrument's band or channel power measurement function with band/channel limits set equal to the specified bandwidth band edges. If the instrument does not have a band or channel power function, sum the spectrum levels (in linear power units) at intervals equal to the RBW extending across the entire

specified bandwidth of the spectrum.

ERP & EIRP Measurement

The relevant equation for determining the maximum ERP or EIRP from the measured RF output power is given in Equation (1) as follows:

$$\text{ERP or EIRP} = P_{\text{Meas}} + G_T$$

where

ERP or EIRP effective radiated power or equivalent isotropically radiated power, respectively (expressed in the same units as P_{Meas} , e.g., dBm or dBW)

P_{Meas} measured transmitter output power or PSD, in dBm or dBW

G_T gain of the transmitting antenna, in dBd (ERP) or dBi (EIRP)

5.3.4. Test Setup

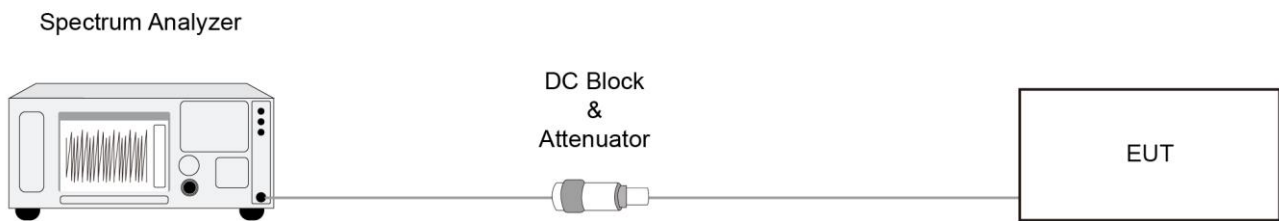

5.3.5. Test Result

Refer to Appendix A.2.

5.4. Peak to Average Ratio Measurement

5.4.1. Test Limit

The peak-to-average power ratio (PAPR) of the transmitter shall not exceed 13 dB for more than 0.1% of the time and shall use a signal corresponding to the highest PAPR during periods of continuous transmission.

5.4.2. Test Procedure

ANSI C63.26-2015 - Section 5.2.3.4 (CCDF).

5.4.3. Test Setting

1. Set the resolution / measurement bandwidth \geq signal's occupied bandwidth
2. Set the number of counts to a value that stabilizes the measured CCDF curve
3. Record the maximum PARR level associated with a probability of 0.1%

5.4.4. Test Setup

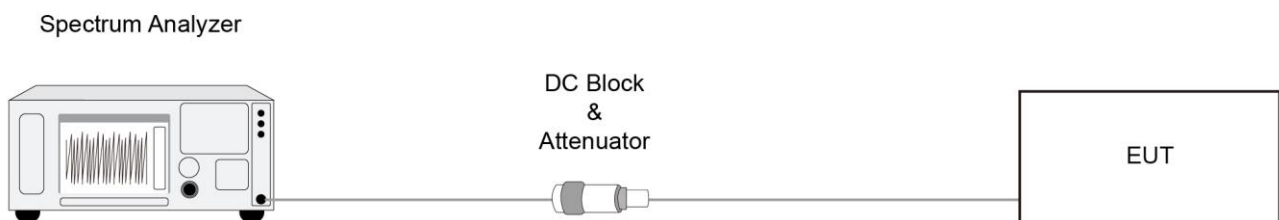

5.4.5. Test Result

Refer to Appendix A.3.

5.5. Conducted Band Edge Unwanted Emissions Measurement

5.5.1. Test Limit

For all fixed digital user stations, the attenuation factor shall be not less than $43 + 10 \log (P)$ dB at the channel edge.

Compliance with these rules is based on the use of measurement instrumentation employing a resolution bandwidth of 1 megahertz or greater. However, in the 1 MHz bands immediately outside and adjacent to the frequency block a resolution bandwidth of at least one percent of the emission bandwidth of the fundamental emission of the transmitter may be employed.

Note: This device can be implement MIMO function, so the limit os spurious emissions needs to be reduced $10 \cdot \log(\text{Numbers}_{\text{Ant}})$ according to FCC KDB 662911 D01 guidance.

The limit is adjusted to $-13\text{dBm} - 10 \cdot \log(4) = -19.02\text{dBm}$

5.5.2. Test Procedure

ANSI C63.26-2015 - Section 5.7

5.5.3. Test Setting

1. Set the analyzer frequency to Low or High channel
2. RBW = specified resolution bandwidth, for improvement of the accuracy in the measurement of the average power of a noise-like emission, a RBW narrower than the specified reference bandwidth can be used (generally limited to no less than 1% of the frequency block group, provided that a subsequent integration is performed over the full required measurement bandwidth. This integration should be performed using the spectrum analyzer's band power functions.
3. VBW $\geq 3 \cdot \text{RBW}$
4. Sweep time = auto
5. Detector = power averaging (rms)
6. If the EUT can be configured to transmit continuously, then set the trigger to free run
7. If the EUT cannot be configured to transmit continuously, then use a sweep trigger with the level set to enable triggering only on full power bursts and configure the EUT to transmit at full power for the entire duration of each sweep. Verify that the sweep time is less than or equal to the transmission burst duration. Time gating can also be used under similar constraints
8. Trace average at least 100 traces in power averaging (rms) mode if sweep is set to auto-couple. To accurately determine the average power over the on and off time of the transmitter, it can be necessary to

increase the number of traces to be averaged above 100, or if using a manually configured sweep time, increase the sweep time.

9. Compute the power by integrating the spectrum across the specified resolution bandwidth using the instrument's band or channel power measurement function, with the band/channel limits set equal to the specified resolution bandwidth, when using a measurement bandwidth smaller than the specified bandwidth. Otherwise, Use the peak marker function to determine the maximum amplitude level.

5.5.4. Test Setup

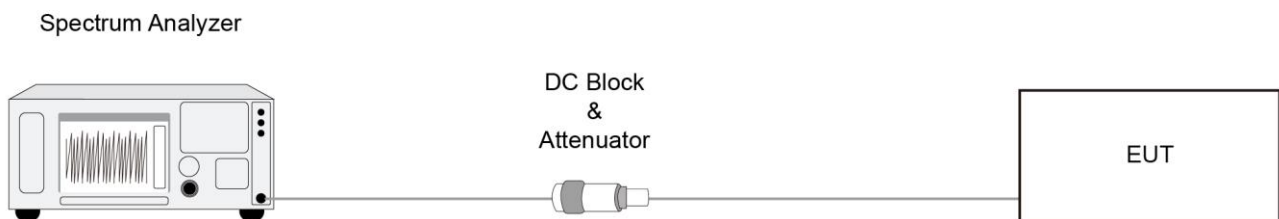

5.5.5. Test Result

Refer to Appendix A.4.

5.6. Conducted Spurious Unwanted Emissions Measurement

5.6.1. Test Limit

For all fixed digital user stations, the attenuation factor shall be not less than $43 + 10 \log (P)$ dB at the channel edge.

Compliance with these rules is based on the use of measurement instrumentation employing a resolution bandwidth of 1 megahertz or greater. However, in the 1 MHz bands immediately outside and adjacent to the frequency block a resolution bandwidth of at least one percent of the emission bandwidth of the fundamental emission of the transmitter may be employed.

Note: This device can be implement MIMO function, so the limit os spurious emissions needs to be reduced $10 \cdot \log(\text{Numbers}_{\text{Ant}})$ according to FCC KDB 662911 D01 guidance.

The limit is adjusted to $-13\text{dBm} - 10 \cdot \log(4) = -19.02\text{dBm}$

5.6.2. Test Procedure

ANSI C63.26-2015 - Section 5.7

5.6.3. Test Setting

1. Set the analyzer frequency to low, mid or high channel.
2. RBW = specified resolution bandwidth
3. VBW $\geq 3 \cdot \text{RBW}$
4. Sweep time = auto
5. Detector = power averaging (rms)
6. If the EUT can be configured to transmit continuously, then set the trigger to free run
7. If the EUT cannot be configured to transmit continuously, then use a sweep trigger with the level set to enable triggering only on full power bursts and configure the EUT to transmit at full power for the entire duration of each sweep. Verify that the sweep time is less than or equal to the transmission burst duration.
Time gating can also be used under similar constraints
8. Trace average at least 100 traces in power averaging (rms) mode if sweep is set to auto-couple. To accurately determine the average power over the on and off time of the transmitter, it can be necessary to increase the number of traces to be averaged above 100, or if using a manually configured sweep time, increase the sweep time.
9. Use the peak marker function to determine the maximum amplitude level.

5.6.4. Test Setup

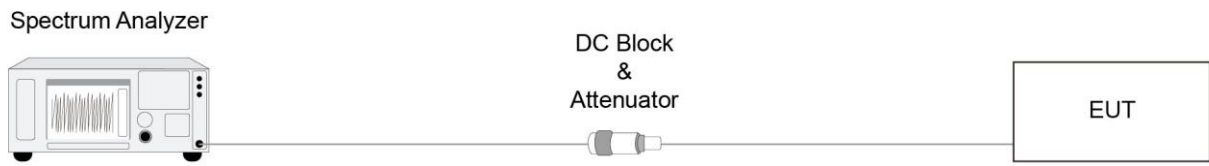

5.6.5. Test Result

Refer to Appendix A.5.

Appendix A - Test Result

A.1 Occupied Bandwidth Test Result

Test Site	WZ-SR6	Test Engineer	Larry Yan
Test Date	2024-04-13	Test Configuration	NR n41_Middle Channel

Frequency (MHz)	Bandwidth (MHz)	99% Bandwidth (MHz)
QPSK		
2592.99	49.5	46.763
16QAM		
2592.99	49.5	46.833
64QAM		
2592.99	49.5	46.751
256QAM		
2592.99	49.5	46.734

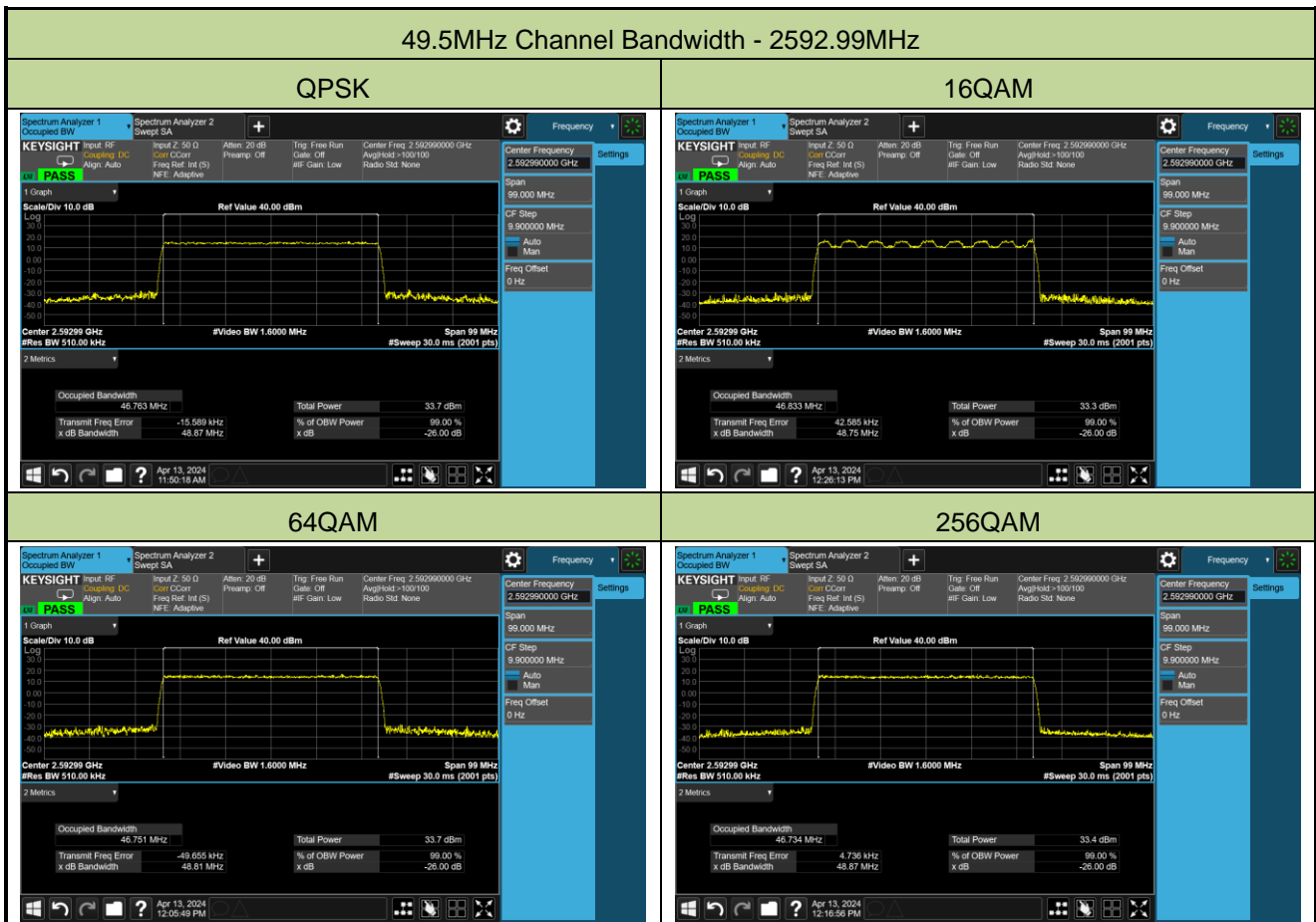

A.2 Equivalent Isotropically Radiated Power Test Result

Test Site	WZ-SR6	Test Engineer	Larry Yan
Test Date	2024-04-09 ~ 2024-04-14	Test Configuration	NR n41_2T2R_49.5MHz

Frequency (MHz)	Output Power (dBm)		Total Power (dBm)	EIRP (dBm)	Limit (dBm)
	Ant 0	Ant 1			
QPSK					
2520.75	24.15	23.71	26.95	36.36	< 72.16
2592.99	24.14	24.00	27.08	36.49	< 72.16
2665.23	23.87	23.65	26.77	36.18	< 72.16
16QAM					
2520.75	23.86	23.85	26.87	36.28	< 72.16
2592.99	23.90	23.68	26.80	36.21	< 72.16
2665.23	23.61	23.55	26.59	36.00	< 72.16
64QAM					
2520.75	24.01	23.80	26.92	36.33	< 72.16
2592.99	24.16	24.07	27.13	36.54	< 72.16
2665.23	23.78	23.44	26.62	36.03	< 72.16
256QAM					
2520.75	24.06	23.75	26.92	36.33	< 72.16
2592.99	24.18	23.91	27.06	36.47	< 72.16
2665.23	23.79	23.90	26.86	36.27	< 72.16

Note 1: Total Power (dBm) = $10 \cdot \log_{10} \{ 10^{\text{ANT 0 Power (dBm)} / 10} + 10^{\text{ANT 1 Power (dBm)} / 10} \}$ (dBm).

Note 2: EIRP (dBm) = Total Power (dBm) + Direction Gain (dBi)

Test Site	WZ-SR6	Test Engineer	Larry Yan
Test Date	2024-04-09 ~ 2024-04-14	Test Configuration	NR n41_4T4R_49.5MHz

Frequency (MHz)	Output Power (dBm)				Total Power (dBm)	EIRP (dBm)	Limit (dBm)
	Ant 0	Ant 1	Ant 2	Ant 3			
QPSK							
2520.75	24.15	23.71	24.17	24.10	30.06	42.48	< 72.16
2592.99	24.14	24.00	24.19	24.32	30.18	42.60	< 72.16
2665.23	23.87	23.65	24.12	24.27	30.00	42.42	< 72.16
16QAM							
2520.75	23.86	23.85	24.21	23.87	29.97	42.39	< 72.16
2592.99	23.90	23.68	24.05	24.16	29.97	42.39	< 72.16
2665.23	23.61	23.55	23.91	23.99	29.79	42.21	< 72.16
64QAM							
2520.75	24.01	23.80	24.26	24.11	30.07	42.49	< 72.16
2592.99	24.16	24.07	24.20	24.30	30.20	42.62	< 72.16
2665.23	23.78	23.44	24.08	23.98	29.85	42.27	< 72.16
256QAM							
2520.75	24.06	23.75	24.15	24.02	30.02	42.44	< 72.16
2592.99	24.18	23.91	24.15	24.12	30.11	42.53	< 72.16
2665.23	23.79	23.90	24.31	24.04	30.03	42.45	< 72.16

Note 1: Total Power (dBm) = $10 \cdot \log \{ 10^{\text{ANT 0 Power (dBm) / 10}} + 10^{\text{ANT 1 Power (dBm) / 10}} + 10^{\text{ANT 2 Power (dBm) / 10}} + 10^{\text{ANT 3 Power (dBm) / 10}} \}$ (dBm).

Note 2: EIRP (dBm) = Total Power (dBm) + Direction Gain (dBi)

A.3 Peak to Average Ratio Test Result

Test Site	WZ-SR6	Test Engineer	Larry Yan
Test Date	2024-04-11	Test Configuration	NR n41_Middle Channel

Frequency (MHz)	Channel Bandwidth (MHz)	Peak to Average Ratio (dB)	Limit (dB)	Result
QPSK				
2592.99	49.5	7.69	≤ 13.00	Pass
16QAM				
2592.99	49.5	7.80	≤ 13.00	Pass
64QAM				
2592.99	49.5	7.67	≤ 13.00	Pass
256QAM				
2592.99	49.5	7.71	≤ 13.00	Pass

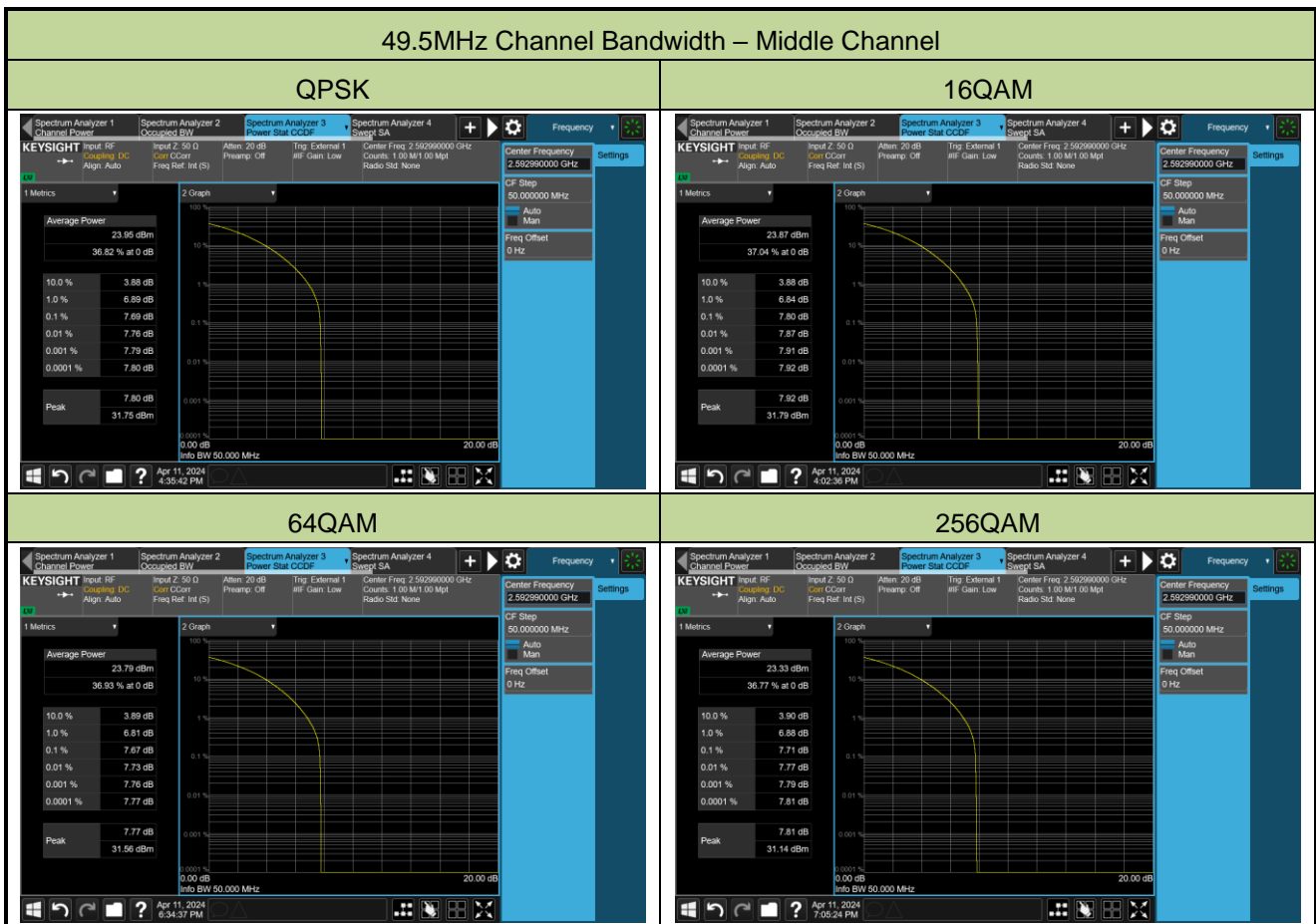

A.4 Conducted Band Edge Unwanted Emissions Test Result

Test Site	WZ-SR6	Test Engineer	Larry Yan
Test Date	2024-04-11~2024-04-12	Test Configuration	NR n41_16QAM

Channel Bandwidth (MHz)	Carrier Frequency (MHz)	Max Band Edge (dBm)				Limit (dBm)	Result
		Ant 0	Ant 1	Ant 2	Ant 3		
49.5	2520.75	-45.140	-45.110	-44.780	-44.900	≤ -19.02	Pass
	2665.23	-45.055	-46.617	-44.678	-45.307	≤ -19.02	Pass

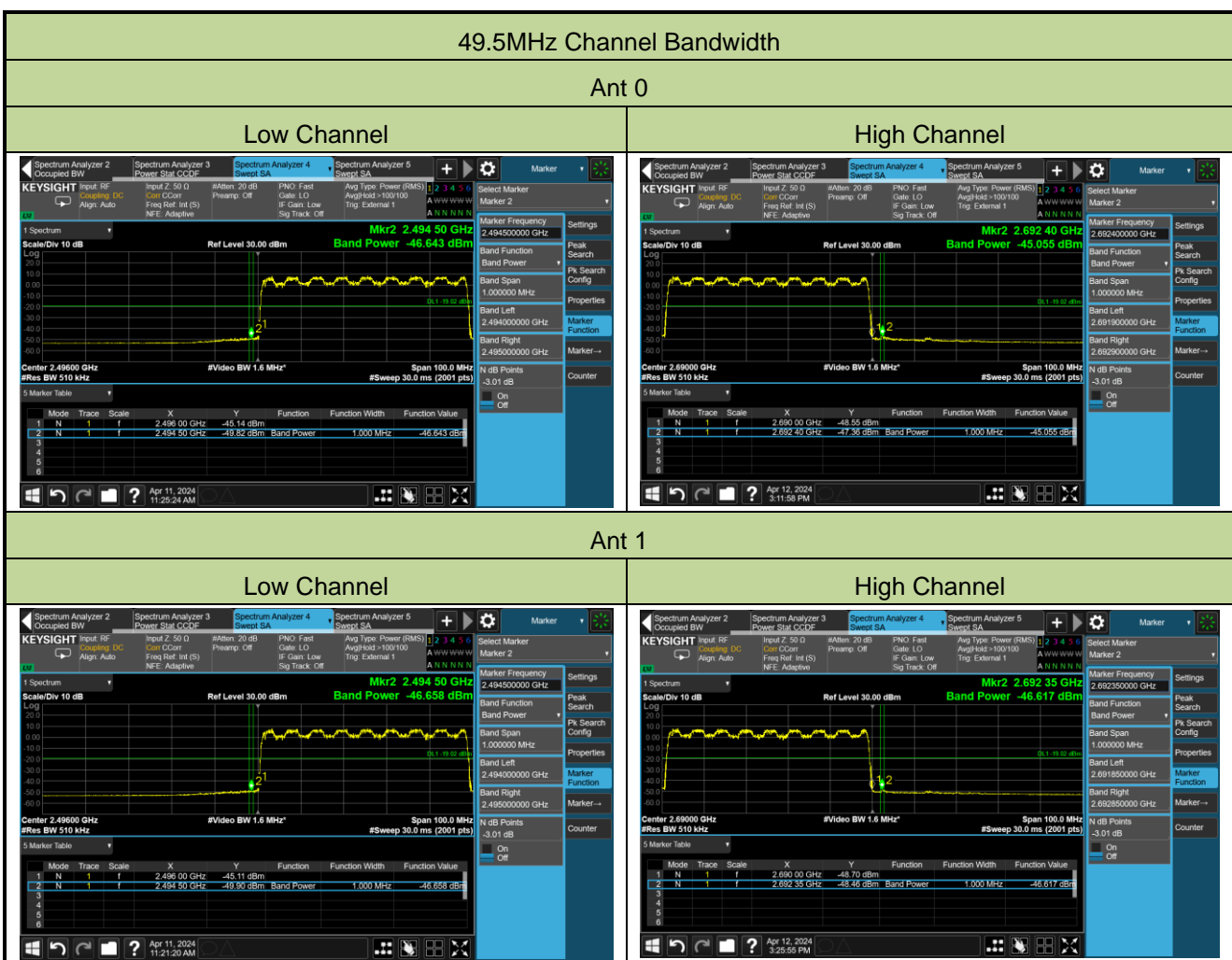

Ant 2

Low Channel

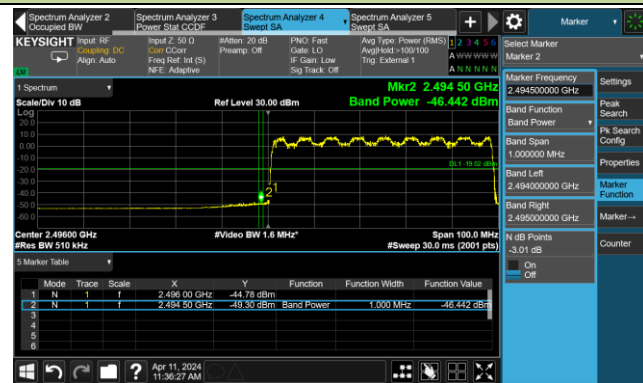

High Channel

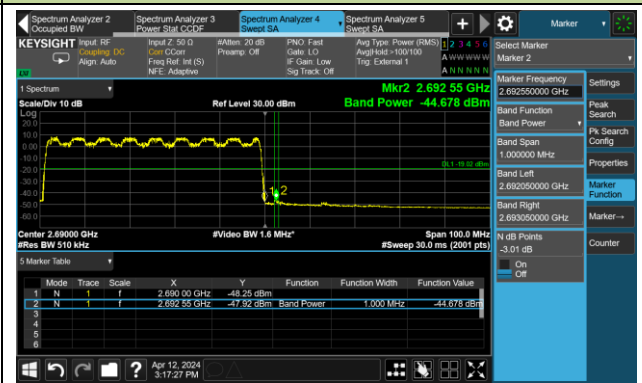

Ant 3

Low Channel

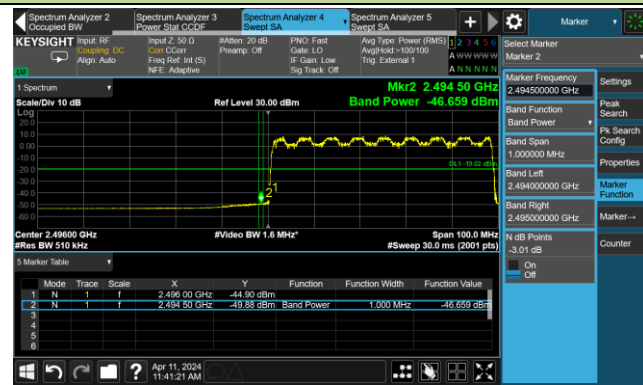

High Channel

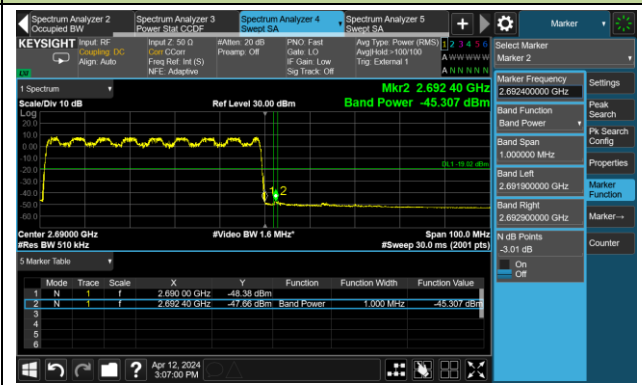

A.5 Conducted Spurious Unwanted Emissions Test Result

Test Site	WZ-SR6	Test Engineer	Larry Yan
Test Date	2024-04-13	Test Configuration	NR n41_16QAM

Channel	Frequency	Frequency	Max Spurious	Limit	Result
BW(MHz)	(MHz)	Range (MHz)	Emissions (dBm)	(dBm)	
49.5	2520.75	30 ~ 27000	-38.41	≤ -19.02	Pass
	2592.99	30 ~ 27000	-38.75	≤ -19.02	Pass
	2665.23	30 ~ 27000	-39.27	≤ -19.02	Pass

Note: The amplitude of Conducted Spurious emissions (frequency range from 9kHz to 30MHz) is that proximity to ambient noise, which also are attenuated more than 20 dB below the permissible value. Therefore, the data is not presented in the report.

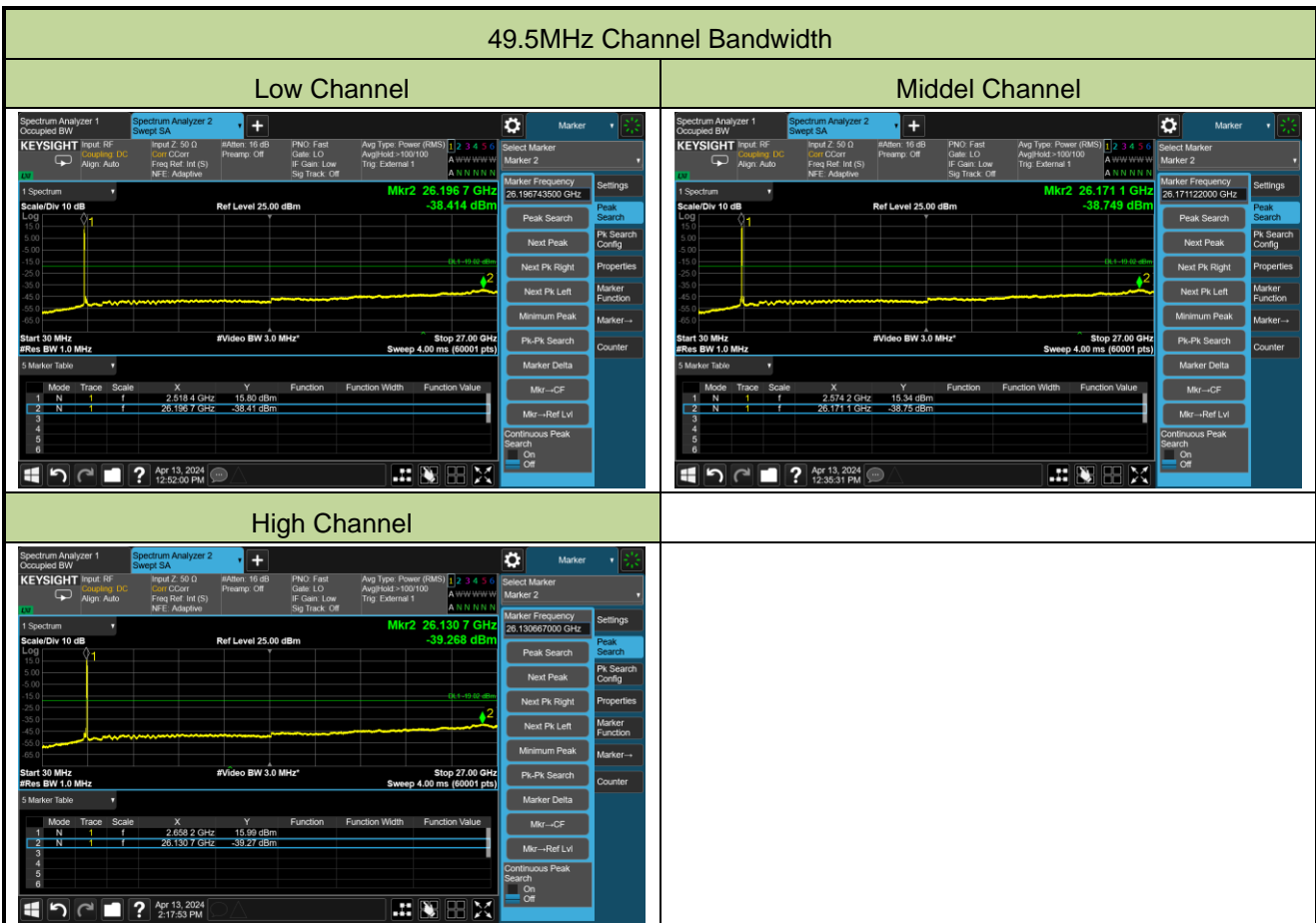

Appendix B - Test Setup Photograph

Refer to "2404RSU017-UT" file.

Appendix C - EUT Photograph

Refer to "2404RSU017-UE" file.