

MEASUREMENT REPORT

FCC PART 27 Subpart M

FCC ID: 2AD8UAWHHC01

Application: Nokia Solutions and Networks, OY

Application Type: Class II Permissive Change

Product: AirScale Indoor Radio ASiR 5G-pRRH

Model No.: AWHHC

Brand Name: Nokia

FCC Rule Part(s): Part 27 Subpart M

Test Procedure(s): ANSI C63.26-2015

Test Date: December 16 ~ 31, 2020

Reviewed:

Paddy Chen

(Paddy Chen)

Approved By:

Chenz Ker

(Chenz Ker)



Testing Laboratory
3261

The test results relate only to the samples tested.

This equipment has been shown to be capable of compliance with the applicable technical standards as indicated in the measurement report and was tested in accordance with the measurement procedures specified in ANSI C63.26-2015. Test results reported herein relate only to the item(s) tested.

The test report shall not be reproduced except in full without the written approval of MRT Technology (Taiwan) Co., Ltd.

Revision History

Report No.	Version	Description	Issue Date	Note
2005TW0005-U3	Rev. 01	Initial Report	01-09-2021	Valid

Note: This report is supplement to MRT original "1909TW0102-U1" report, added the related data and detail shown as below.

The applicant request Class II permissive change since an authorized product (FCC ID: 2AD8UAWHHC01) is added to operation modes by software changes below without any hardware changes.

➤ 5G NR 20MHz, 50MHz & 80MHz

CONTENTS

Description	Page
General Information.....	5
1. INTRODUCTION.....	6
1.1. Scope.....	6
1.2. MRT Test Location	6
2. PRODUCT INFORMATION.....	7
2.1. Equipment Description	7
2.2. Emission Designator	8
2.3. Description of Available Antennas	8
2.4. Test Mode	8
2.5. EMI Suppression Device(s)/Modifications.....	8
3. TEST EQUIPMENT CALIBRATION DATE.....	9
4. MEASUREMENT UNCERTAINTY	11
5. TEST RESULT	12
5.1. Summary.....	12
5.2. Equivalent Isotropically Radiated Power Measurement	13
5.2.1. Test Limit	13
5.2.2. Test Procedures Used	13
5.2.3. Test Setting.....	13
5.2.4. Test Setup	14
5.2.5. Test Result.....	15
5.3. Emission Bandwidth	21
5.3.1. Test Limit	21
5.3.2. Test Procedure Used	21
5.3.3. Test Setting.....	21
5.3.4. Test Setup	21
5.3.5. Test Result.....	22
5.4. Frequency Stability Measurement	31
5.4.1. Test Limit	31
5.4.2. Test Procedures Used	31
5.4.3. Test Setting.....	31
5.4.4. Test Setup	32
5.4.5. Test Result.....	33
5.5. Band Edge Measurement.....	34
5.5.1. Test Limit	34

5.5.2.	Test Procedure Used	34
5.5.3.	Test Setting.....	34
5.5.4.	Test Setup	35
5.5.5.	Test Result.....	36
5.6.	Peak to Average Ratio	42
5.6.1.	Test Limit	42
5.6.2.	Test Procedure Used	42
5.6.3.	Test Setting.....	42
5.6.4.	Test Setup	42
5.6.5.	Test Result.....	43
5.7.	Conducted Spurious Emissions.....	46
5.7.1.	Test Limit	46
5.7.2.	Test Procedure Used	46
5.7.3.	Test Setting.....	46
5.7.4.	Test Setup	47
5.7.5.	Test Result.....	48
5.8.	Radiated Spurious Emissions Measurements	54
5.8.1.	Test Limit	54
5.8.2.	Test Procedure Used	54
5.8.3.	Test Setting.....	54
5.8.4.	Test Setup	55
5.8.5.	Test Result.....	56
6.	CONCLUSION	59

General Information

Applicant:	Nokia Solutions and Networks, OY
Applicant Address:	2000 W. Lucent Lane, Naperville, Illinois, United States, 60563
Manufacturer:	Nokia Solutions and Networks, OY
Manufacturer Address:	2000 W. Lucent Lane, Naperville, Illinois, United States, 60563
Test Site:	MRT Technology (Taiwan) Co., Ltd
Test Site Address:	No. 38, Fuxing Second Rd., Guishan Dist., Taoyuan City 333, Taiwan (R.O.C)

Test Facility / Accreditations

Measurements were performed at MRT Laboratory located in Fuxing Rd., Taoyuan, Taiwan (R.O.C)

- MRT facility is a FCC registered (Reg. No. 153292) test facility with the site description report on file and is designated by the FCC as an Accredited Test Film.
- MRT facility is an IC registered (Reg. No. 21723-1) test laboratory with the site description on file at Industry Canada.
- MRT Lab is accredited to ISO 17025 by the American Association for Laboratory Accreditation (TAF) under the American Association for Laboratory Accreditation Program (TAF Cert. No. 3261) in EMC, Telecommunications and Radio testing for FCC, Industry Taiwan, EU and TELEC Rules.

1. INTRODUCTION

1.1. Scope

Measurement and determination of electromagnetic emissions (EMC) of radio frequency devices including intentional and/or unintentional radiators for compliance with the technical rules and regulations of the Federal Communications Commission and the Innovation, Science and Economic Development and Engineering Bureau.

1.2. MRT Test Location

The map below shows the location of the MRT LABORATORY, its proximity to the Taoyuan City. These measurement tests were conducted at the MRT Technology (Taiwan) Co., Ltd. Facility located at No.38, Fuxing 2nd Rd., Guishan Dist., Taoyuan City 33377, Taiwan (R.O.C).

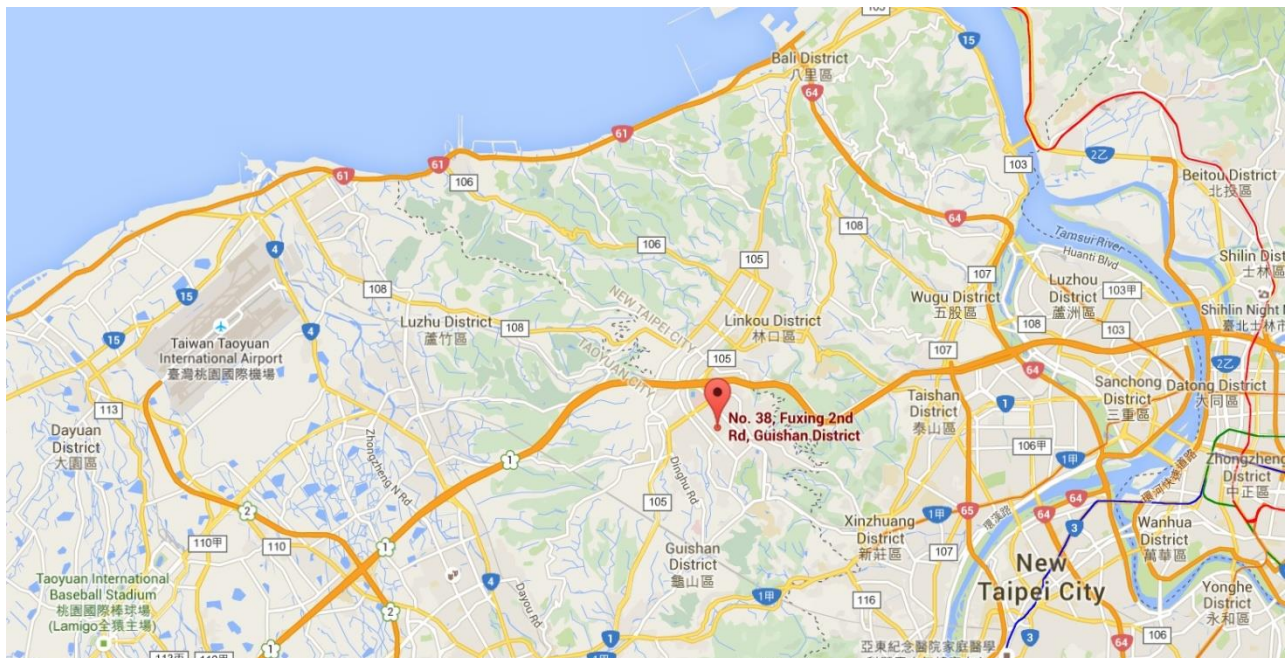

2. PRODUCT INFORMATION

2.1. Equipment Description

Product Name:	AirScale Indoor Radio ASiR 5G-pRRH
Model No.:	AWHHC
Brand Name:	Nokia
Test Device Serial No.:	NH192400336
Hardware Version:	X22
Software Version:	474924A
Power Supply Rating	PoE (52 ~ 57Vdc)
Operating Band (s):	5G NR Band n41
Modulation Type:	QPSK, 16QAM, 64QAM, 256QAM
T _x Frequency Range:	2496 ~ 2690 MHz
R _x Frequency Range:	2496 ~ 2690 MHz
Max EIRP Power:	5G NR 20MHz: 2*2 MIMO: 36.47dBm; 4*4MIMO: 42.51dBm 5G NR 50MHz: 2*2 MIMO: 36.50dBm; 4*4MIMO: 42.52dBm 5G NR 80MHz: 2*2 MIMO: 36.38dBm; 4*4MIMO: 42.40dBm
Emission Designator:	Refer to Section 2.2
Antenna Specification:	Refer to Section 2.3

2.2. Emission Designator

Bandwidth (MHz)	Modulation	Emission Designator	Bandwidth (MHz)	Modulation	Emission Designator
20	QPSK	18M3G7D	50	QPSK	47M6G7D
	16QAM	18M3W7D		16QAM	47M5W7D
	64QAM	18M2W7D		64QAM	47M4W7D
	256QAM	18M2W7D		256QAM	47M4W7D
80	QPSK	77M6G7D	--		
	16QAM	77M5W7D			
	64QAM	77M3W7D			
	256QAM	77M3W7D			

2.3. Description of Available Antennas

Band Support	Antenna Type	Model	Antenna Gain (dBi)	Directional Gain (dBi)	
				2*2 MIMO	4*4 MIMO
n41 Band	Directional Antenna	GI0804-06846	6.4	9.41	12.42

Note 1: This device supports both 2*2 T_x & 4*4 T_x modes of operation, configured by SW. When operating in 2*2 T_x mode, only Ant 0 & 1 transmit ports are actively transmitting.

Note 2: The transmit signals are correlated, the directional gain = G_{ANT} + 10 log (N_{ANT}/N_{SS}) dBi, where N_{SS} = the number of independent spatial streams of data and G_{ANT} is the antenna gain in dBi.

2.4. Test Mode

Test Item	Channel Bandwidth	Modulation
Equivalent Isotropically Radiated Power	20MHz, 50MHz, 80MHz	QPSK, 16QAM, 64QAM, 256QAM
Emission Bandwidth		QPSK, 16QAM, 64QAM, 256QAM
Band Edge Measurements		QPSK
Conducted Spurious Emissions		QPSK
Radiated Spurious Emissions		QPSK
Peak to Average Ratio		QPSK
Frequency Stability		QPSK

2.5. EMI Suppression Device(s)/Modifications

No EMI suppression device(s) were added and/or no modifications were made during testing.

3. TEST EQUIPMENT CALIBRATION DATE

Radiated Emissions

Instrument	Manufacturer	Type No.	Asset No.	Cali. Interval	Cali. Due Date
Active Loop Antenna	SCHWARZBECK	FMZB 1519B	MRTTWA00002	1 year	2021/04/27
Broadband TRILOG Antenna	SCHWARZBECK	VULB 9162	MRTTWA00001	1 year	2021/06/03
Broadband Hornantenna	SCHWARZBECK	BBHA 9120D	MRTTWA00003	1 year	2021/04/24
Breitband Hornantenna	SCHWARZBECK	BBHA 9170	MRTTWA00004	1 year	2021/04/24
Broadband Preamplifier	SCHWARZBECK	BBV 9718	MRTTWA00005	1 year	2021/04/24
Broadband Amplifier	SCHWARZBECK	BBV 9721	MRTTWA00006	1 year	2021/04/24
Signal Analyzer	R&S	FSV40	MRTTWA00007	1 year	2021/03/24
EMI Test Receiver	R&S	ESR3	MRTTWA00009	1 year	2021/03/25
EXA Signal Analyzer	KEYSIGHT	N9010A	MRTTWA00012	1 year	2021/10/02
EXA Signal Analyzer	KEYSIGHT	N9010B	MRTTWA00074	1 year	2021/07/11
Antenna Cable	HUBERSUHNER	SF106	MRTTWE00010	1 year	2021/06/16
Temperature/Humidity Meter	TFA	35.1078.10.IT	MRTTWA00032	1 year	2021/05/29
Cable	Rosnol	K1K50-UP026 4-K1K50-4M	MRTTWE00012	1 year	2021/06/21

Conducted Test Equipment

Instrument	Manufacturer	Type No.	Asset No.	Cali. Interval	Cali. Due Date
X-Series USB Peak and Average Power Sensor	KEYSIGHT	U2021XA	MRTTWA00014	1 year	2021/04/24
X-Series USB Peak and Average Power Sensor	KEYSIGHT	U2021XA	MRTTWA00015	1 year	2021/03/26
Wideband Radio Communication Taster	R&S	CMW 500	MRTTWA00041	1 year	2021/01/07
EXA Signal Analyzer	KEYSIGHT	N9010A	MRTTWA00012	1 year	2021/10/02
EXA Signal Analyzer	KEYSIGHT	N9010B	MRTTWA00074	1 year	2021/07/11
Signal Analyzer	R&S	FSV40	MRTTWA00007	1 year	2021/03/24
DC Power Supply	GWINSTEK	SPS-606	MRTTWA00034	Check by TRUE RMS MULTIMETER	
TRUE RMS MULTIMETER	FLUKE	117	MRTTWA00022	1 year	2021/05/28
Temperature & Humidity Chamber	TEN BILLION	TTH-B3UP	MRTTWA00036	1 year	2021/06/09
Temperature/Humidity Meter	TFA	35.1078.10.IT	MRTTWA00033	1 year	2021/05/29

Software	Version	Function
EMI Software	V3	EMI Test Software

4. MEASUREMENT UNCERTAINTY

Where relevant, the following test uncertainty levels have been estimated for tests performed on the EUT as specified in CISPR 16-4-2. This uncertainty represents an expanded uncertainty expressed at approximately the 95% confidence level using a coverage factor of $k = 2$.

Radiated Emission Measurement
Measuring Uncertainty for a Level of Confidence of 95% ($U=2Uc(y)$): 9kHz~30MHz: $\pm 3.92\text{dB}$ 30MHz~1GHz: $\pm 4.25\text{dB}$ 1GHz~18GHz: $\pm 4.40\text{dB}$ 18GHz~40GHz: $\pm 4.45\text{dB}$
Spurious Emissions, Conducted
Measuring Uncertainty for a Level of Confidence of 95% ($U=2Uc(y)$): $\pm 2.65\text{ dB}$
Output Power
Measuring Uncertainty for a Level of Confidence of 95% ($U=2Uc(y)$): $\pm 0.84\text{dB}$
Frequency Error
Measuring Uncertainty for a Level of Confidence of 95% ($U=2Uc(y)$): $\pm 78.4\text{Hz}$
Occupied Bandwidth
Measuring Uncertainty for a Level of Confidence of 95% ($U=2Uc(y)$): 3.3%

5. TEST RESULT

5.1. Summary

FCC Section(s)	Test Description	Test Limit	Test Condition	Test Result	Reference
2.1046; 27.50(h)	Equivalent Isotropically Radiated Power	Refer to Section 5.2	Conducted	Pass	Section 5.2
2.1049	Emission Bandwidth	Refer to Section 5.3		Pass	Section 5.3
2.1055; 27.54	Frequency Stability	Refer to Section 5.4		Pass	Section 5.4
2.1051; 27.53(m)	Band Edge Measurements	Refer to Section 5.5		Pass	Section 5.5
2.1046	Peak to Average Ratio	Refer to Section 5.6		Pass	Section 5.6
2.1051; 27.53(m)	Conducted Spurious Emissions	Refer to Section 5.7		Pass	Section 5.7
2.1053; 27.53(m)	Radiated Spurious Emissions	Refer to Section 5.8	Radiated	Pass	Section 5.8

Notes:

- 1) The analyzer plots shown in this section were all taken with a correction table loaded into the analyzer. The correction table was used to account for the losses of the cables and attenuators used as part of the system to connect the EUT to the analyzer at all frequencies of interest.
- 2) Pre-Scan has been conducted to determine the worst-case mode from all possible combinations between available modulations and antenna ports the worst case was found. Following model(s) was (were) selected for the final test as listed at section 2.4.

5.2. Equivalent Isotropically Radiated Power Measurement

5.2.1. Test Limit

According to the specific rule 27.50(h)(1), the following power limits shall apply in the BRS and EBS: Main, booster and base stations. (i) The maximum EIRP of a main, booster or base station shall not exceed $33 \text{ dBW} + 10\log(X/Y) \text{ dBW}$, where X is the actual channel width in MHz and Y is either 6 MHz if prior to transition or the station is in the MBS following transition or 5.5 MHz if the station is in the LBS and UBS following transition, except as provided in paragraph (h)(1)(ii) of this section.

20MHz Bandwidth: The EIRP limit = $33 + 30 + 10 \cdot \log(20/5.5) = 68.61 \text{ dBm}$

50MHz Bandwidth: The EIRP limit = $33 + 30 + 10 \cdot \log(50/5.5) = 72.59 \text{ dBm}$

80MHz Bandwidth: The EIRP limit = $33 + 30 + 10 \cdot \log(80/5.5) = 74.63 \text{ dBm}$

5.2.2. Test Procedures Used

KDB 971168 D01v03r01 - Section 5.2.4 & 5.6

5.2.3. Test Setting

Average power measurements were performed only when the EUT was transmitting at its maximum power control level using a broadband power meter with a pulse sensor. The power meter implemented triggering and gating capabilities which were set up such that power measurements were recorded only during the ON time of the transmitter.

The relevant equation for determining the maximum ERP or EIRP from the measured RF output power is given in Equation (1) as follows:

$$\text{ERP or EIRP} = P_{\text{Meas}} + G_{\text{T}}$$

where

ERP or EIRP effective radiated power or equivalent isotropically radiated power, respectively (expressed in the same units as P_{Meas} , e.g., dBm or dBW)

P_{Meas} measured transmitter output power or PSD, in dBm or dBW

G_{T} gain of the transmitting antenna, in dBd (ERP) or dBi (EIRP)

5.2.4. Test Setup

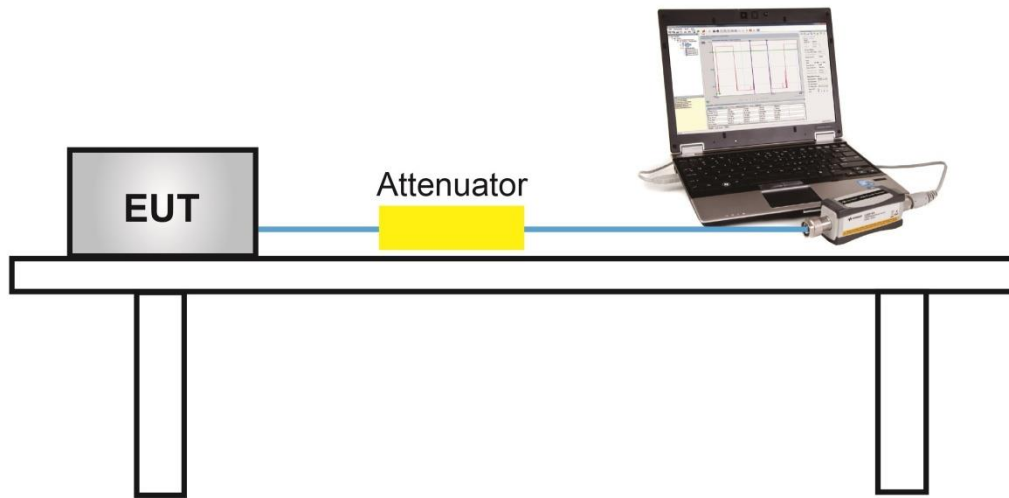

5.2.5. Test Result

Product	AirScale Indoor Radio ASiR 5G-pRRH	Test Engineer	Eric Lin
Test Site	SR2	Test Date	2020/12/09
Test Item	EIRP (2*2 T _x mode, 20MHz Bandwidth)		

Frequency (MHz)	Channel Bandwidth (MHz)	Ant 0 Power (dBm)	Ant 1 Power (dBm)	Total Power (dBm)	EIRP (dBm)	Limit (dBm)	Result
QPSK							
2506.02	20	23.61	23.67	26.65	36.06	≤ 68.61	Pass
2592.99	20	23.85	23.91	26.89	36.30	≤ 68.61	Pass
2679.99	20	24.07	23.86	26.98	36.39	≤ 68.61	Pass
16QAM							
2506.02	20	23.68	23.75	26.73	36.14	≤ 68.61	Pass
2592.99	20	23.92	24.01	26.98	36.39	≤ 68.61	Pass
2679.99	20	24.15	23.95	27.06	36.47	≤ 68.61	Pass
64QAM							
2506.02	20	23.78	23.77	26.79	36.20	≤ 68.61	Pass
2592.99	20	23.91	24.09	27.01	36.42	≤ 68.61	Pass
2679.99	20	24.14	23.93	27.05	36.46	≤ 68.61	Pass
256QAM							
2506.02	20	23.63	23.73	26.69	36.10	≤ 68.61	Pass
2592.99	20	23.88	23.95	26.93	36.34	≤ 68.61	Pass
2679.99	20	24.07	23.88	26.99	36.40	≤ 68.61	Pass

Note 1: Total Power (dBm) = $10 \cdot \log \{ 10^{\lfloor \text{ANT 0 Power (dBm)} / 10 \rfloor} + 10^{\lfloor \text{ANT 1 Power (dBm)} / 10 \rfloor} \}$ (dBm).

Note 2: EIRP (dBm) = Total Power (dBm) + Directional Gain (dBi).

Product	AirScale Indoor Radio ASiR 5G-pRRH	Test Engineer	Eric Lin
Test Site	SR2	Test Date	2020/12/09
Test Item	EIRP (4*4 T _x mode, 20MHz Bandwidth)		

Frequency (MHz)	Channel Bandwidth (MHz)	Ant 0 Power (dBm)	Ant 1 Power (dBm)	Ant 2 Power (dBm)	Ant 3 Power (dBm)	Total Power (dBm)	EIRP (dBm)	Limit (dBm)	Result
QPSK									
2506.02	20	23.61	23.67	23.81	24.00	29.80	42.22	≤ 68.61	Pass
2592.99	20	23.85	23.91	23.93	23.86	29.91	42.33	≤ 68.61	Pass
2679.99	20	24.07	23.86	23.96	24.00	29.99	42.41	≤ 68.61	Pass
16QAM									
2506.02	20	23.68	23.75	23.94	24.06	29.88	42.30	≤ 68.61	Pass
2592.99	20	23.92	24.01	23.96	23.99	29.99	42.41	≤ 68.61	Pass
2679.99	20	24.15	23.95	24.08	24.11	30.09	42.51	≤ 68.61	Pass
64QAM									
2506.02	20	23.78	23.77	23.95	24.00	29.90	42.32	≤ 68.61	Pass
2592.99	20	23.91	24.09	24.02	24.07	30.04	42.46	≤ 68.61	Pass
2679.99	20	24.14	23.93	24.08	24.14	30.09	42.51	≤ 68.61	Pass
256QAM									
2506.02	20	23.63	23.73	23.91	24.01	29.84	42.26	≤ 68.61	Pass
2592.99	20	23.88	23.95	23.98	23.97	29.97	42.39	≤ 68.61	Pass
2679.99	20	24.07	23.88	24.05	24.08	30.04	42.46	≤ 68.61	Pass

Note 1: Total Power (dBm) = $10 \cdot \log \{ 10^{\text{ANT 0 Power (dBm)} / 10} + 10^{\text{ANT 1 Power (dBm)} / 10} + 10^{\text{ANT 2 Power (dBm)} / 10} + 10^{\text{ANT 3 Power (dBm)} / 10} \}$ (dBm).

Note 2: EIRP (dBm) = Total Power (dBm) + Directional Gain (dBi).

Product	AirScale Indoor Radio ASiR 5G-pRRH	Test Engineer	Eric Lin
Test Site	SR2	Test Date	2020/12/09
Test Item	EIRP (2*2 T _x mode, 50MHz Bandwidth)		

Frequency (MHz)	Channel Bandwidth (MHz)	Ant 0 Power (dBm)	Ant 1 Power (dBm)	Total Power (dBm)	EIRP (dBm)	Limit (dBm)	Result
QPSK							
2521.02	50	23.76	23.95	26.87	36.28	≤ 72.59	Pass
2592.99	50	23.79	23.74	26.78	36.19	≤ 72.59	Pass
2664.99	50	24.15	23.93	27.05	36.46	≤ 72.59	Pass
16QAM							
2521.02	50	23.78	23.91	26.86	36.27	≤ 72.59	Pass
2592.99	50	23.73	23.54	26.65	36.06	≤ 72.59	Pass
2664.99	50	24.12	23.93	27.04	36.45	≤ 72.59	Pass
64QAM							
2521.02	50	23.84	23.94	26.90	36.31	≤ 72.59	Pass
2592.99	50	23.78	23.87	26.84	36.25	≤ 72.59	Pass
2664.99	50	24.16	23.92	27.05	36.46	≤ 72.59	Pass
256QAM							
2521.02	50	23.84	23.98	26.92	36.33	≤ 72.59	Pass
2592.99	50	23.77	23.92	26.86	36.27	≤ 72.59	Pass
2664.99	50	24.18	23.98	27.09	36.50	≤ 72.59	Pass

Note 1: Total Power (dBm) = $10 \cdot \log\{10^{\lfloor \text{ANT 0 Power (dBm)} / 10 \rfloor} + 10^{\lfloor \text{ANT 1 Power (dBm)} / 10 \rfloor}\}$ (dBm).

Note 2: EIRP (dBm) = Total Power (dBm) + Directional Gain (dBi).

Product	AirScale Indoor Radio ASiR 5G-pRRH	Test Engineer	Eric Lin
Test Site	SR2	Test Date	2020/12/09
Test Item	EIRP (4*4 T _x mode, 50MHz Bandwidth)		

Frequency (MHz)	Channel Bandwidth (MHz)	Ant 0 Power (dBm)	Ant 1 Power (dBm)	Ant 2 Power (dBm)	Ant 3 Power (dBm)	Total Power (dBm)	EIRP (dBm)	Limit (dBm)	Result
QPSK									
2521.02	50	23.76	23.95	24.01	24.05	29.96	42.38	≤ 72.59	Pass
2592.99	50	23.79	23.74	23.60	23.62	29.71	42.13	≤ 72.59	Pass
2664.99	50	24.15	23.93	24.06	24.14	30.09	42.51	≤ 72.59	Pass
16QAM									
2521.02	50	23.78	23.91	23.96	24.06	29.95	42.37	≤ 72.59	Pass
2592.99	50	23.73	23.54	23.58	23.65	29.65	42.07	≤ 72.59	Pass
2664.99	50	24.12	23.93	24.03	24.07	30.06	42.48	≤ 72.59	Pass
64QAM									
2521.02	50	23.84	23.94	24.03	24.09	30.00	42.42	≤ 72.59	Pass
2592.99	50	23.78	23.87	23.79	23.91	29.86	42.28	≤ 72.59	Pass
2664.99	50	24.16	23.92	24.09	24.12	30.09	42.51	≤ 72.59	Pass
256QAM									
2521.02	50	23.84	23.98	24.01	24.06	29.99	42.41	≤ 72.59	Pass
2592.99	50	23.77	23.92	23.78	23.93	29.87	42.29	≤ 72.59	Pass
2664.99	50	24.18	23.98	24.08	24.09	30.10	42.52	≤ 72.59	Pass

Note 1: Total Power (dBm) = $10 \cdot \log \{ 10^{\text{ANT 0 Power (dBm) / 10}} + 10^{\text{ANT 1 Power (dBm) / 10}} + 10^{\text{ANT 2 Power (dBm) / 10}} + 10^{\text{ANT 3 Power (dBm) / 10}} \}$ (dBm).

Note 2: EIRP (dBm) = Total Power (dBm) + Directional Gain (dBi).

Product	AirScale Indoor Radio ASiR 5G-pRRH	Test Engineer	Eric Lin
Test Site	SR2	Test Date	2020/12/12
Test Item	EIRP (2*2 T _x mode, 80MHz Bandwidth)		

Frequency (MHz)	Channel Bandwidth (MHz)	Ant 0 Power (dBm)	Ant 1 Power (dBm)	Total Power (dBm)	EIRP (dBm)	Limit (dBm)	Result
QPSK							
2536.02	80	23.69	23.93	26.82	36.23	≤ 74.63	Pass
2592.99	80	23.68	23.80	26.75	36.16	≤ 74.63	Pass
2649.99	80	24.10	23.81	26.97	36.38	≤ 74.63	Pass
16QAM							
2536.02	80	23.61	23.79	26.71	36.12	≤ 74.63	Pass
2592.99	80	23.70	23.83	26.78	36.19	≤ 74.63	Pass
2649.99	80	23.96	23.70	26.84	36.25	≤ 74.63	Pass
64QAM							
2536.02	80	23.63	23.85	26.75	36.16	≤ 74.63	Pass
2592.99	80	23.59	23.74	26.68	36.09	≤ 74.63	Pass
2649.99	80	23.92	23.67	26.81	36.22	≤ 74.63	Pass
256QAM							
2536.02	80	23.62	23.86	26.75	36.16	≤ 74.63	Pass
2592.99	80	23.65	23.71	26.69	36.10	≤ 74.63	Pass
2649.99	80	23.71	23.63	26.68	36.09	≤ 74.63	Pass

Note 1: Total Power (dBm) = $10 \cdot \log\{10^{\lfloor \text{ANT 0 Power (dBm)} / 10 \rfloor} + 10^{\lfloor \text{ANT 1 Power (dBm)} / 10 \rfloor}\}$ (dBm).

Note 2: EIRP (dBm) = Total Power (dBm) + Directional Gain (dBi).

Product	AirScale Indoor Radio ASiR 5G-pRRH	Test Engineer	Eric Lin
Test Site	SR2	Test Date	2020/12/09
Test Item	EIRP (4*4 T _x mode, 80MHz Bandwidth)		

Frequency (MHz)	Channel Bandwidth (MHz)	Ant 0 Power (dBm)	Ant 1 Power (dBm)	Ant 2 Power (dBm)	Ant 3 Power (dBm)	Total Power (dBm)	EIRP (dBm)	Limit (dBm)	Result
QPSK									
2536.02	80	23.69	23.93	23.87	24.01	29.90	42.32	≤ 74.63	Pass
2592.99	80	23.68	23.80	23.79	23.88	29.81	42.23	≤ 74.63	Pass
2649.99	80	24.10	23.81	23.90	24.01	29.98	42.40	≤ 74.63	Pass
16QAM									
2536.02	80	23.61	23.79	23.80	23.92	29.80	42.22	≤ 74.63	Pass
2592.99	80	23.70	23.83	23.82	23.90	29.83	42.25	≤ 74.63	Pass
2649.99	80	23.96	23.70	23.85	23.91	29.88	42.30	≤ 74.63	Pass
64QAM									
2516.0	80	23.63	23.85	23.75	23.91	29.81	42.23	≤ 74.63	Pass
2593.0	80	23.59	23.74	23.73	23.81	29.74	42.16	≤ 74.63	Pass
2536.02	80	23.92	23.67	23.77	23.86	29.83	42.25	≤ 74.63	Pass
256QAM									
2536.02	80	23.62	23.86	23.81	23.91	29.82	42.24	≤ 74.63	Pass
2592.99	80	23.65	23.71	23.74	23.87	29.76	42.18	≤ 74.63	Pass
2649.99	80	23.71	23.63	23.48	23.89	29.70	42.12	≤ 74.63	Pass

Note 1: Total Power (dBm) = $10 \cdot \log \{ 10^{\text{ANT 0 Power (dBm) / 10}} + 10^{\text{ANT 1 Power (dBm) / 10}} + 10^{\text{ANT 2 Power (dBm) / 10}} + 10^{\text{ANT 3 Power (dBm) / 10}} \}$ (dBm).

Note 2: EIRP (dBm) = Total Power (dBm) + Directional Gain (dBi).

5.3. Emission Bandwidth

5.3.1. Test Limit

The emission bandwidth is defined as the width of the signal between two points, one below the carrier center frequency and one above the carrier center frequency, outside of which all emissions are attenuated at least 26 dB below the transmitter power.

5.3.2. Test Procedure Used

KDB 971168 D01v03r01 - Section 4.1 & 4.2

ANSI C63.26-2015 - Section 5.4.3 & 5.4.4

5.3.3. Test Setting

1. Set center frequency to the nominal EUT channel center frequency;
2. RBW = The nominal RBW shall be in the range of 1% to 5% of the anticipated OBW;
3. VBW $\geq 3 \times$ RBW;
4. Detector = Peak;
5. Trace mode = max hold;
6. Sweep = auto couple;
7. Allow the trace to stabilize;
8. The dynamic range of the spectrum analyzer at the selected RBW shall be more than 10 dB below the target “-X dB” requirement, i.e., if the requirement calls for measuring the -26 dB OBW, the spectrum analyzer noise floor at the selected RBW shall be at least 26 dB below the reference level

5.3.4. Test Setup

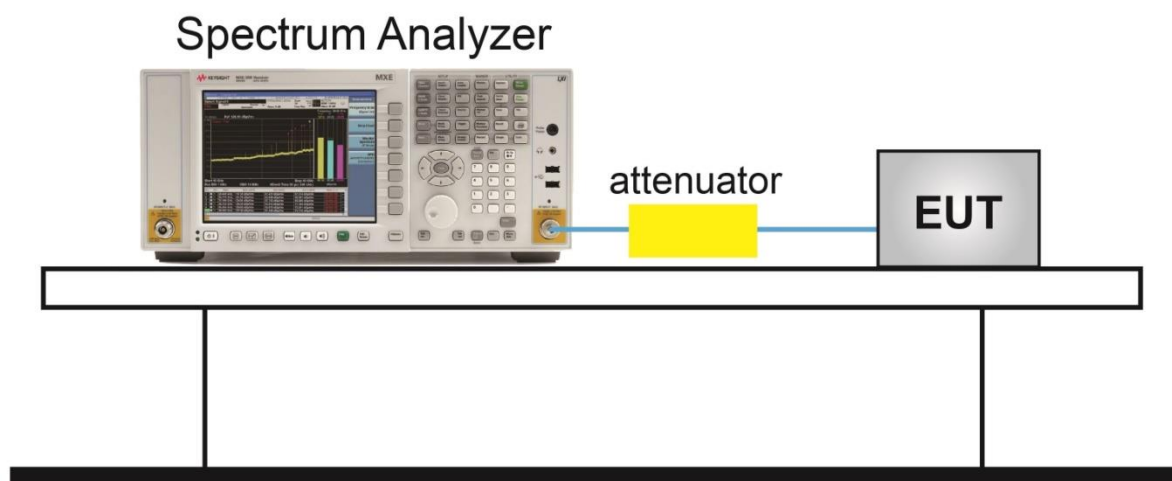

5.3.5. Test Result

Product	AirScale Indoor Radio ASiR 5G-pRRH	Test Engineer	Eric Lin
Test Site	SR2	Test Date	2020/12/09
Test Configuration	5G NR 20MHz		

Modulation	Frequency (MHz)	Bandwidth (MHz)	26dB Bandwidth (MHz)	99% Bandwidth (MHz)
Ant 0 / Ant 0+1+2+3				
QPSK	Bottom	20	19.31	18.27
	Middle	20	19.29	18.28
	Top	20	19.24	18.28
16QAM	Bottom	20	19.32	18.26
	Middle	20	19.30	18.27
	Top	20	19.35	18.26
64QAM	Bottom	20	19.16	18.16
	Middle	20	19.20	18.17
	Top	20	19.20	18.17
256QAM	Bottom	20	19.29	18.18
	Middle	20	19.27	18.18
	Top	20	19.26	18.18

Emission Bandwidth - QPSK

Bottom Channel

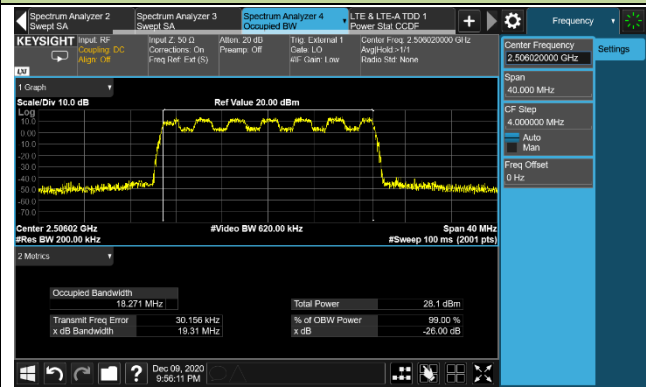

Middle Channel

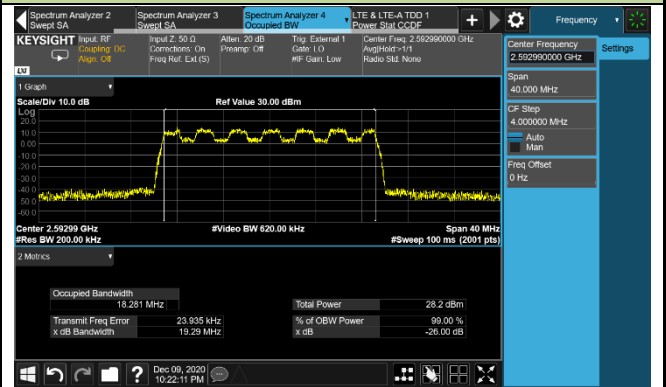

Top Channel

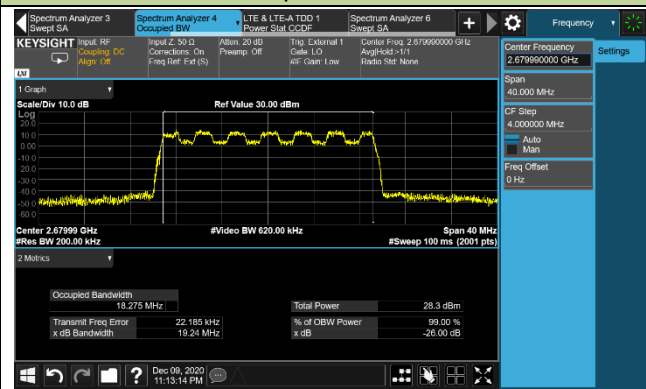

Emission Bandwidth - 16QAM

Bottom Channel

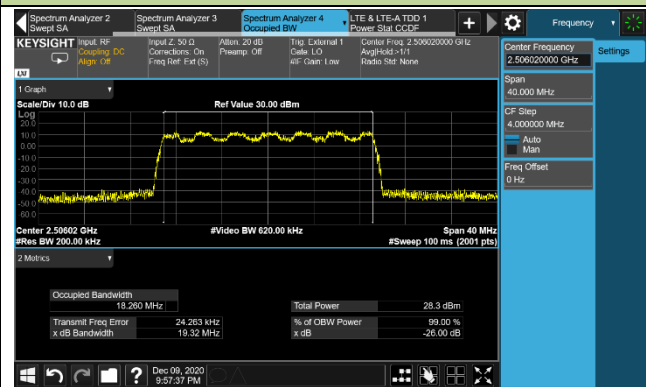

Middle Channel

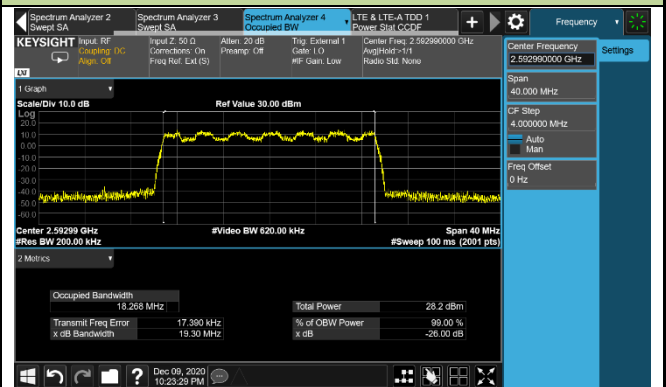

Top Channel

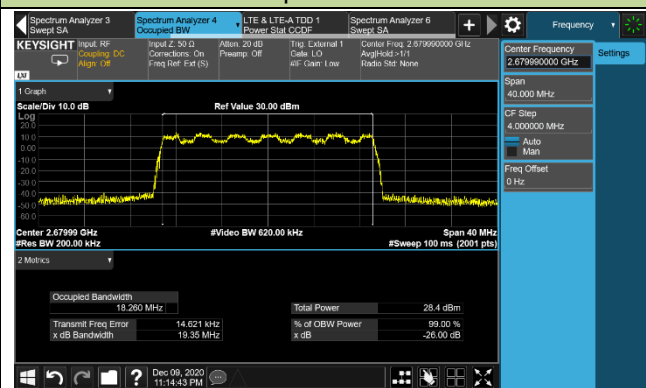

Emission Bandwidth - 64QAM

Bottom Channel

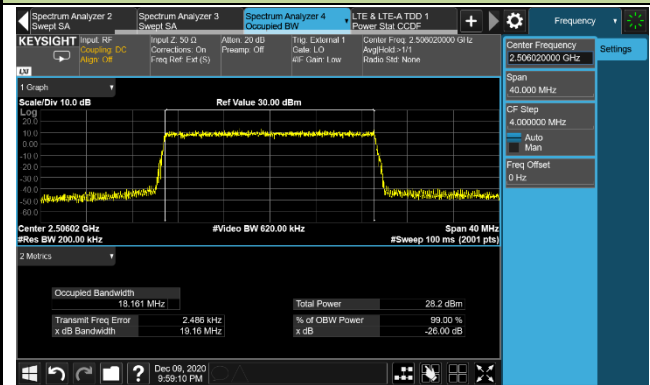

Middle Channel

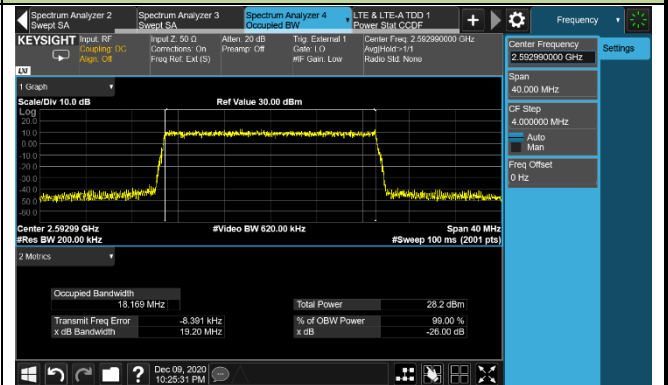

Top Channel

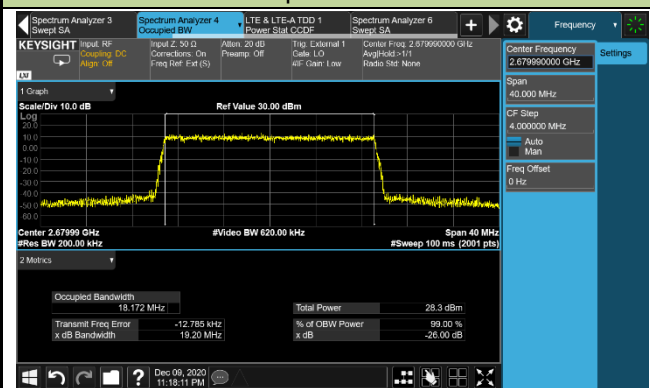

Emission Bandwidth - 256QAM

Bottom Channel

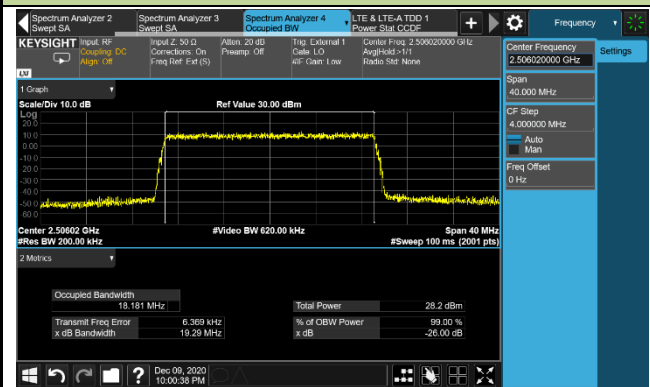

Middle Channel

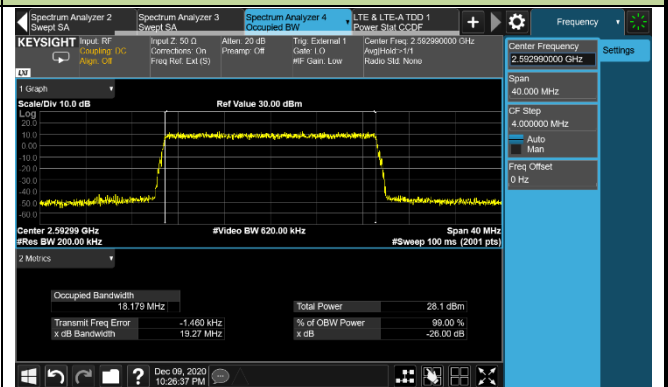

Top Channel

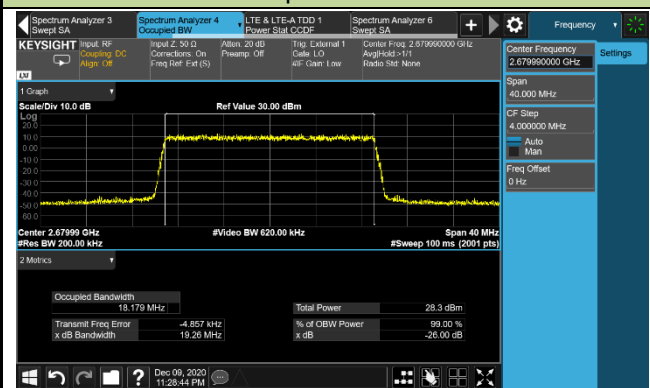

Product	AirScale Indoor Radio ASiR 5G-pRRH	Test Engineer	Eric Lin
Test Site	SR2	Test Date	2020/12/10
Test Configuration	5G NR 50MHz		

Modulation	Frequency (MHz)	Bandwidth (MHz)	26dB Bandwidth (MHz)	99% Bandwidth (MHz)
Ant 0 / Ant 0+1+2+3				
QPSK	Bottom	50	49.41	47.51
	Middle	50	49.40	47.60
	Top	50	49.50	47.57
16QAM	Bottom	50	19.41	47.51
	Middle	50	49.25	47.54
	Top	50	49.49	47.53
64QAM	Bottom	50	49.47	47.36
	Middle	50	49.34	47.39
	Top	50	49.31	47.36
256QAM	Bottom	50	49.22	47.33
	Middle	50	49.31	47.36
	Top	50	49.25	47.35

Emission Bandwidth - QPSK

Bottom Channel

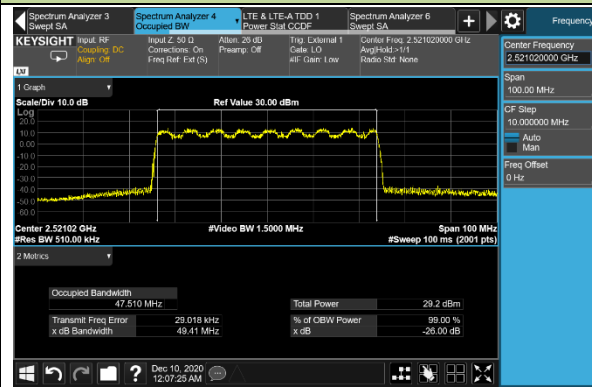

Middle Channel

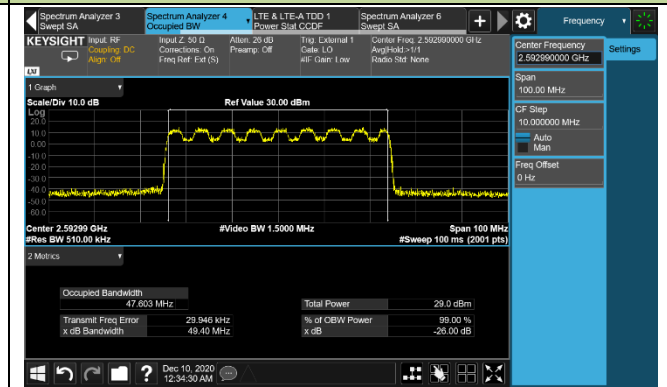

Top Channel

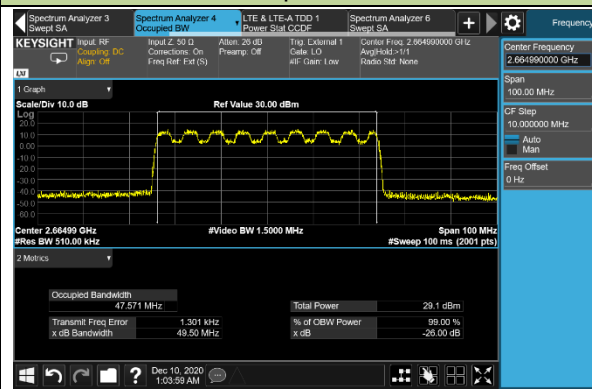

Emission Bandwidth - 16QAM

Bottom Channel

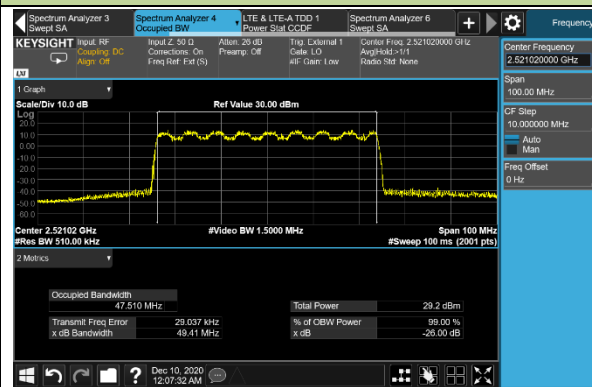

Middle Channel

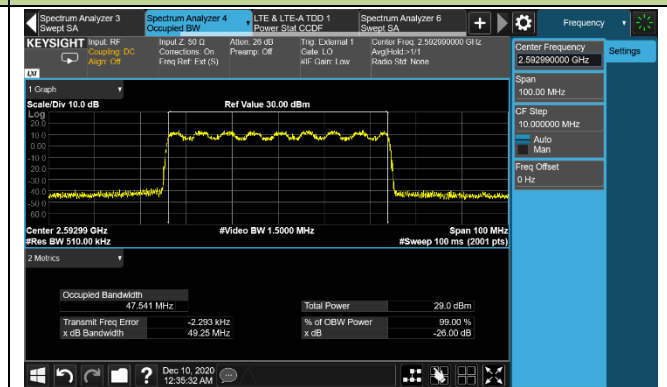

Top Channel

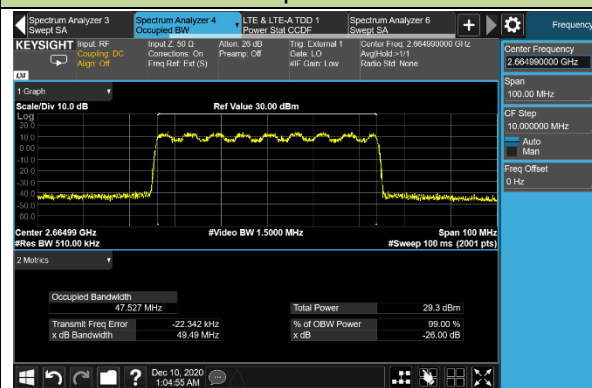

Emission Bandwidth - 64QAM

Bottom Channel

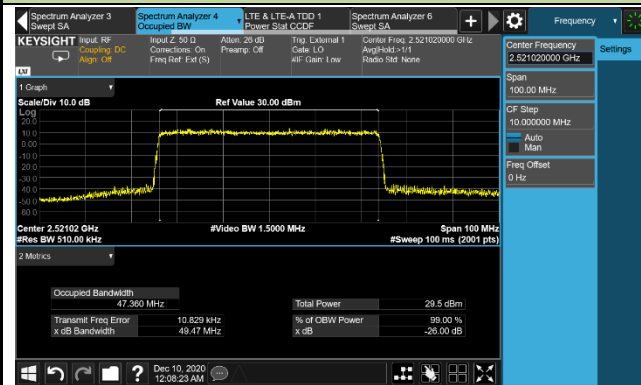

Middle Channel

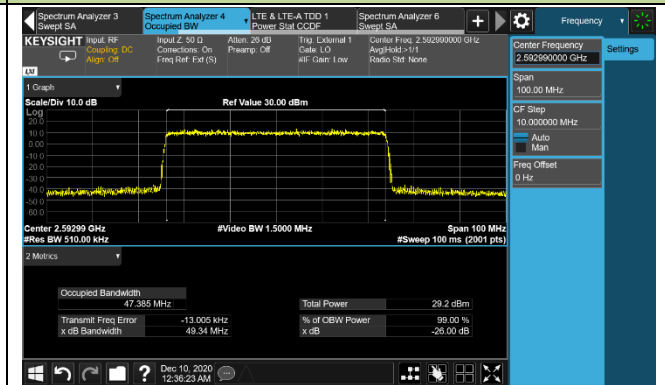

Top Channel

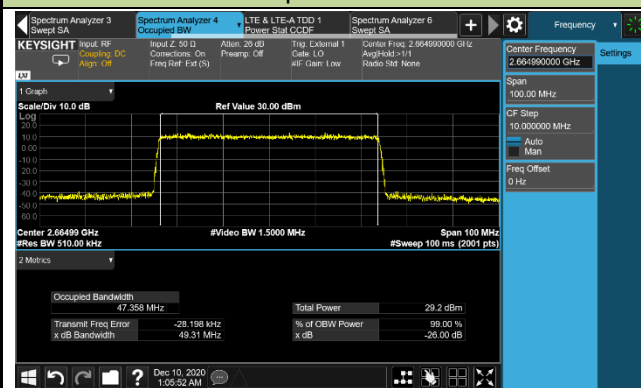

Emission Bandwidth - 256QAM

Bottom Channel

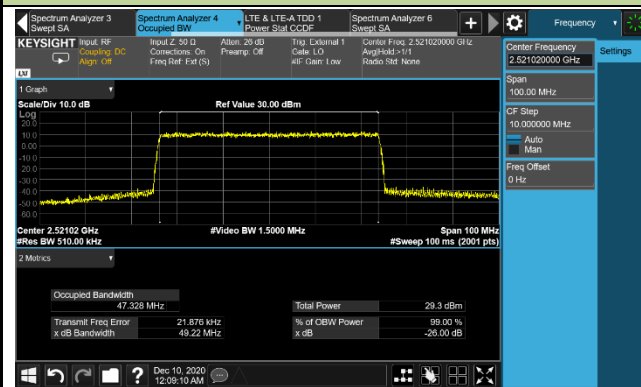

Middle Channel

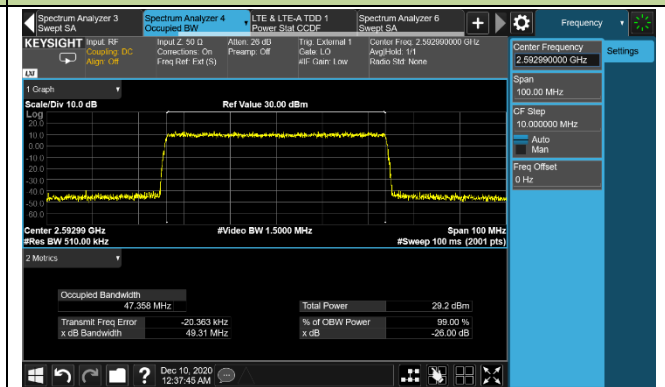

Top Channel

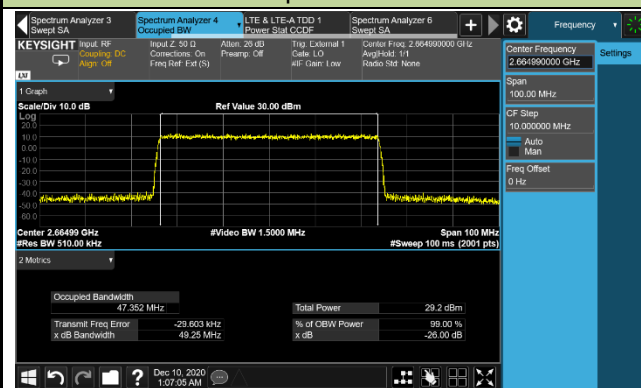

Product	AirScale Indoor Radio ASiR 5G-pRRH	Test Engineer	Eric Lin
Test Site	SR2	Test Date	2020/12/10
Test Configuration	5G NR 80MHz		

Modulation	Frequency (MHz)	Bandwidth (MHz)	26dB Bandwidth (MHz)	99% Bandwidth (MHz)
Ant 0 / Ant 0+1+2+3				
QPSK	Bottom	80	79.75	77.53
	Middle	80	79.89	77.62
	Top	80	79.93	77.62
16QAM	Bottom	80	79.71	77.47
	Middle	80	79.76	77.54
	Top	80	79.71	77.53
64QAM	Bottom	80	79.75	77.14
	Middle	80	79.79	77.25
	Top	80	79.79	77.23
256QAM	Bottom	80	79.87	77.27
	Middle	80	79.84	77.32
	Top	80	79.87	77.31

Emission Bandwidth - QPSK

Bottom Channel

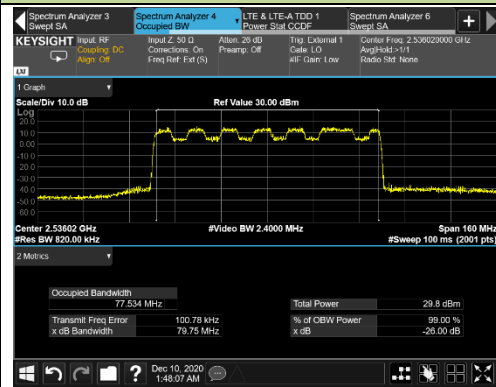

Middle Channel

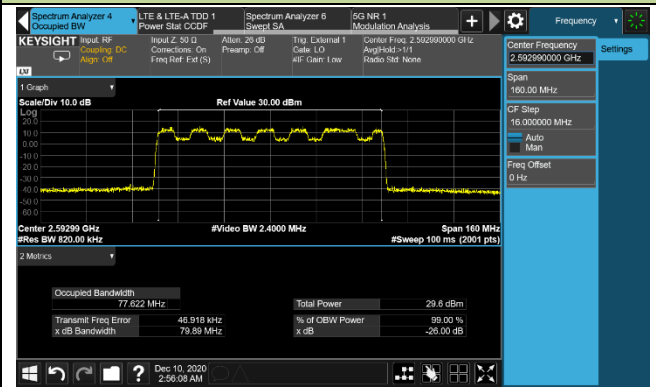

Top Channel

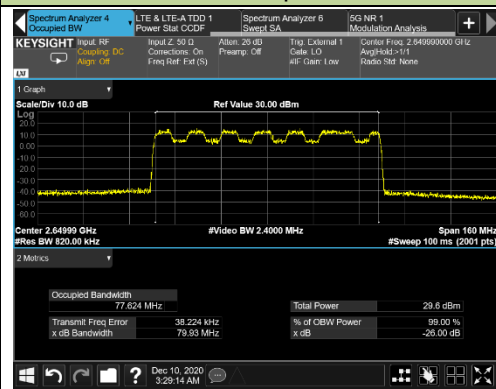

Emission Bandwidth - 16QAM

Bottom Channel

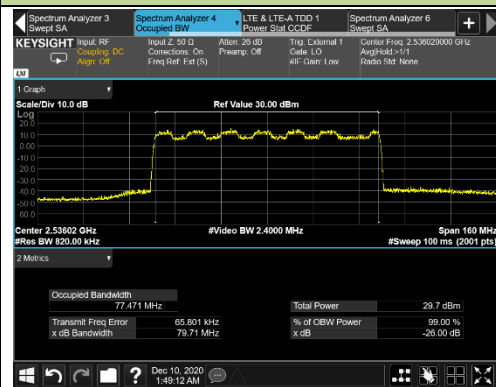

Middle Channel

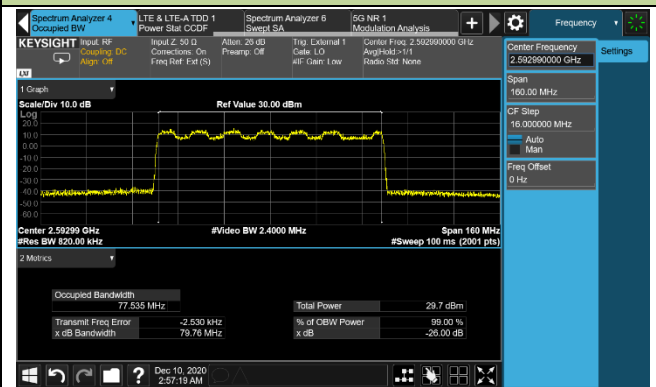

Top Channel

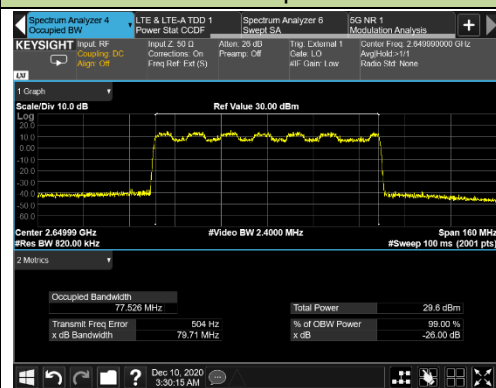

Emission Bandwidth - 64QAM

Bottom Channel

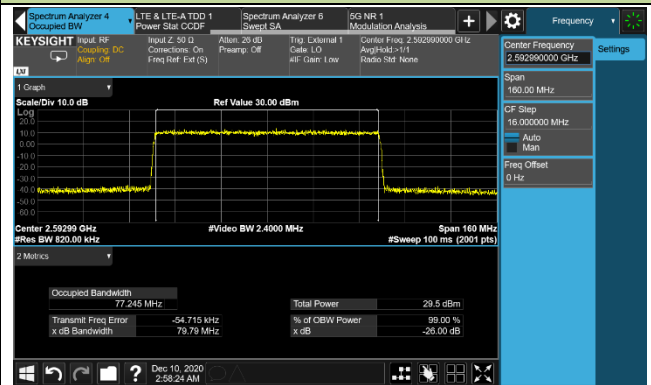

Middle Channel

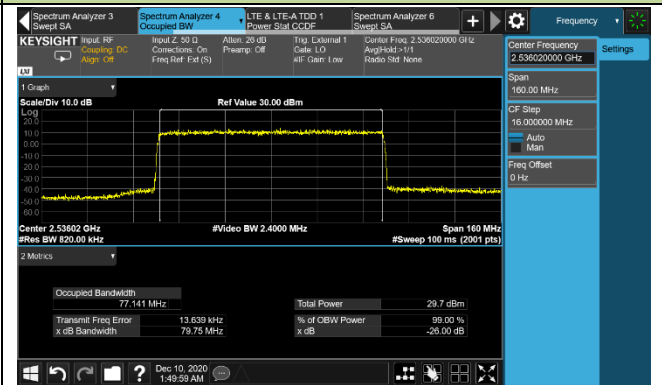

Top Channel

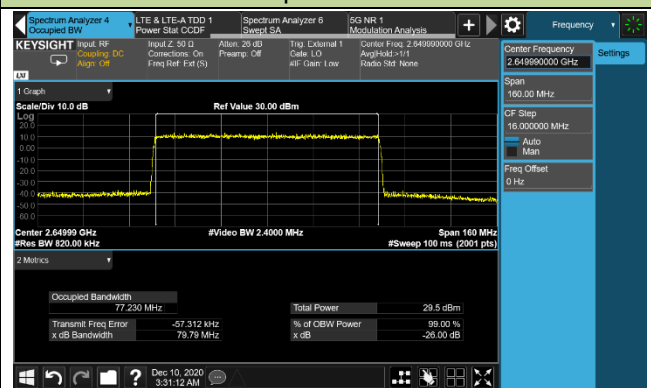

Emission Bandwidth - 256QAM

Bottom Channel

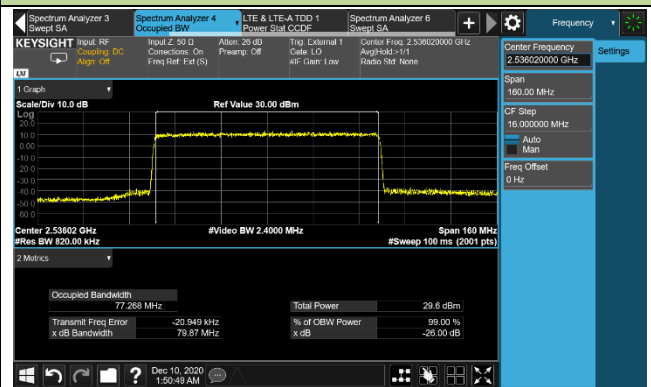

Middle Channel

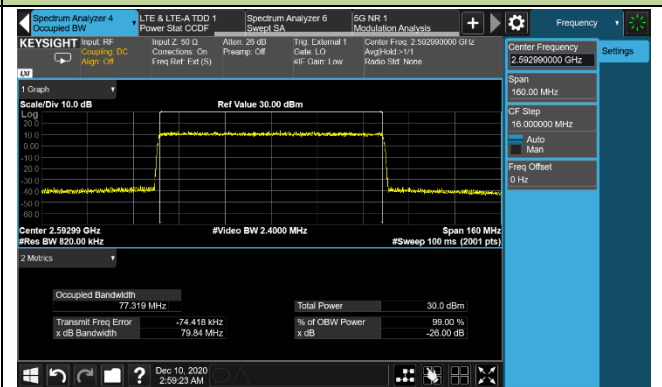

Top Channel

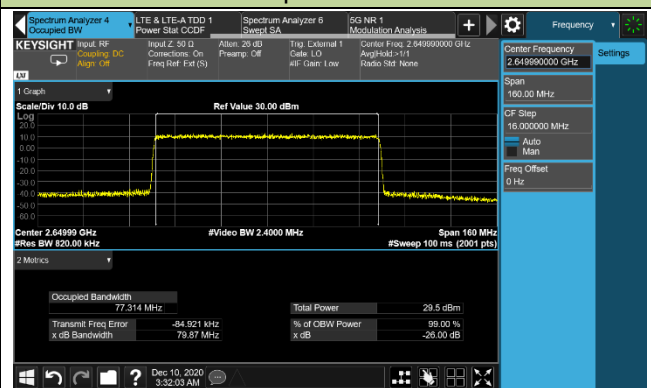

5.4. Frequency Stability Measurement

5.4.1. Test Limit

N/A

5.4.2. Test Procedures Used

KDB 971168 D01v03r01 - Section 9

ANSI C63.26-2015 - Section 5.6

5.4.3. Test Setting

Frequency Stability Under Temperature Variations:

The equipment under test was connected to an external AC or DC power supply and input rated voltage. RF output was connected to a frequency counter or spectrum analyzer via feed through attenuators. The EUT was placed inside the temperature chamber. Set the spectrum analyzer RBW low enough to obtain the desired frequency resolution and measure EUT 20°C operating frequency as reference frequency. Turn EUT off and set the chamber temperature to highest. After the temperature stabilized for approximately 30 minutes recorded the frequency. Repeat step measure with 10°C decreased per stage until the lowest temperature reached.

Frequency Stability Under Voltage Variations:

Set chamber temperature to 20°C. Use a variable AC power supply / DC power source to power the EUT and set the voltage to rated voltage. Set the spectrum analyzer RBW low enough to obtain the desired frequency resolution and recorded the frequency.

Reduce the input voltage to specify extreme voltage variation ($\pm 15\%$) and endpoint (If a product is specified to operate over a range of input voltage then the -15% variation is applied to the lowermost voltage and the $+15\%$ is applied to the uppermost voltage), record the maximum frequency change.

5.4.4. Test Setup

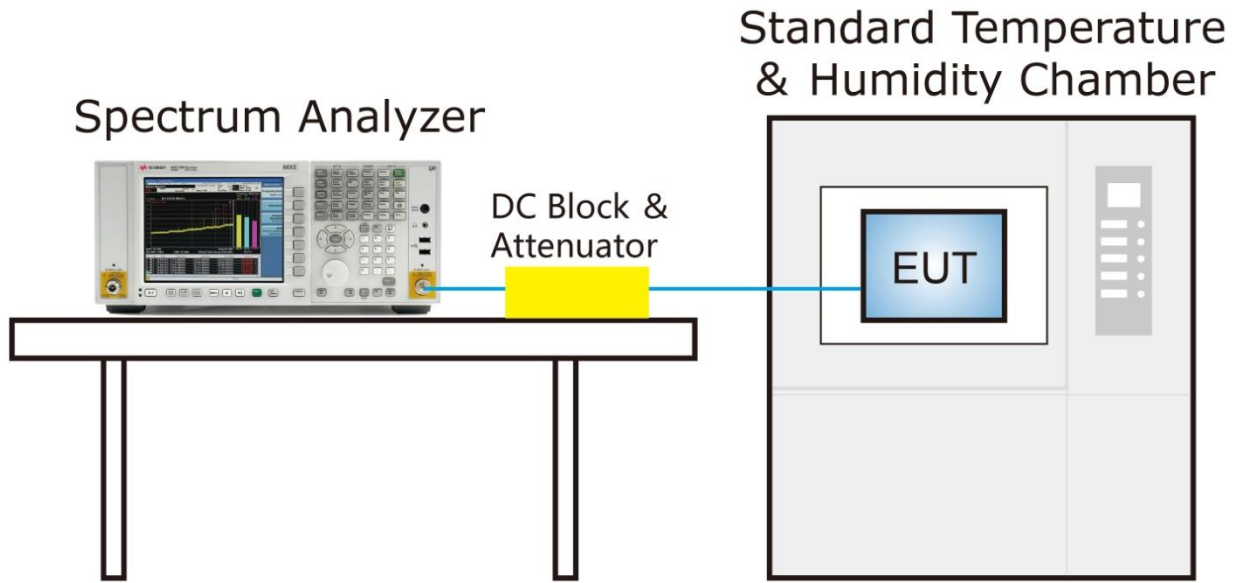

5.4.5. Test Result

Product	AirScale Indoor Radio ASiR 5G-pRRH	Test Engineer	Eric Lin
Test Site	SR2	Test Date	2020/12/10
Test Configuration	5G NR 80MHz, 2592.99MHz		

Power (VDC)	Temp (°C)	Frequency Tolerance (ppm)
54	0	-0.0013
	+ 10	-0.0012
	+ 20 (Ref)	-0.0014
	+ 30	-0.0023
	+ 40	-0.0015
	+ 50	-0.0021
57	+ 20	-0.0023
52	+ 20	-0.0017

5.5. Band Edge Measurement

5.5.1. Test Limit

For all fixed digital user stations, the attenuation factor shall be not less than $43 + 10 \log (P)$ dB at the channel edge.

This device can be implement MIMO function, so the limit of spurious emissions needs to be reduced by $10 \cdot \log(\text{Numbers}_{\text{Ant}})$ according to FCC KDB 662911 D01 guidance.

The UUT can operate in either 4*4 MIMO mode. The 4*4 MIMO limit is applied in this test report and is adjusted to $-13 \text{ dBm} - 10 \cdot \log (4) = -19.02 \text{ dBm}$.

5.5.2. Test Procedure Used

KDB 971168 D01v03r01 - Section 6.1

ANSI C63.26-2015 - Section 5.7.1

5.5.3. Test Setting

1. Set the analyzer frequency to low or high channel.
1. RBW = The nominal RBW shall be in the range of 1% of the anticipated OBW;
2. VBW $\geq 3 \cdot$ RBW
3. Sweep time = auto
4. Detector = power averaging (rms)
5. Set sweep trigger to "free run."
6. Trace average at least 100 traces in power averaging (rms) mode if sweep is set to auto-couple. To accurately determine the average power over the on and off time of the transmitter, it can be necessary to increase the number of traces to be averaged above 100, or if using a manually configured sweep time, increase the sweep time.

5.5.4. Test Setup

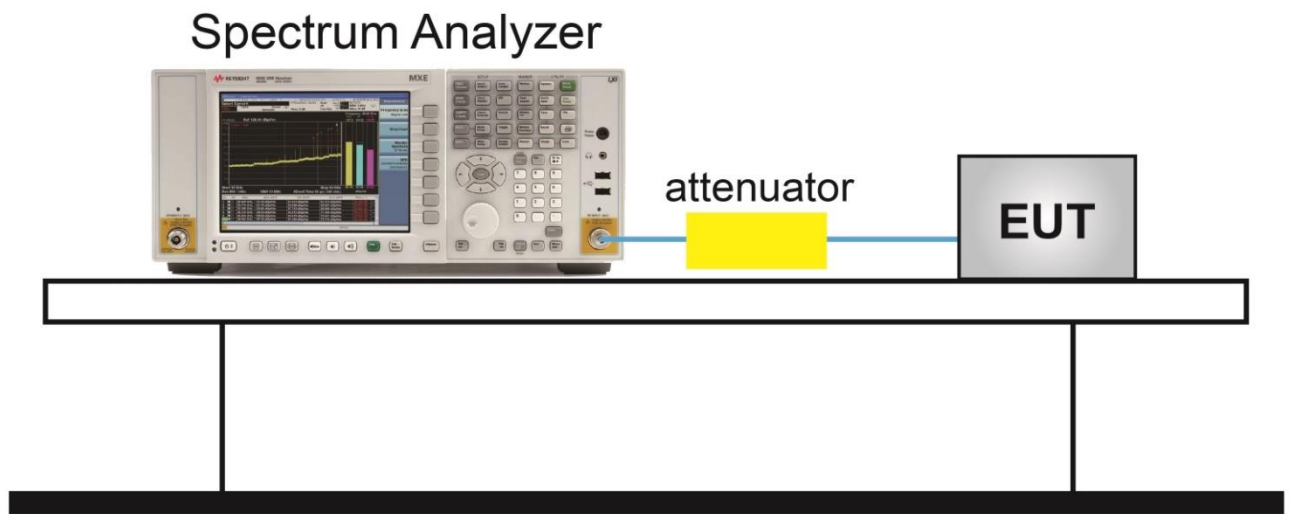

5.5.5. Test Result

Product	AirScale Indoor Radio ASiR 5G-pRRH	Test Engineer	Eric Lin
Test Site	SR2	Test Date	2020/12/09
Test Configuration	5G NR 20MHz		

Frequency (MHz)	Channel Bandwidth (MHz)	Max Band Edge (dBm)				Limit (dBm)	Result
		Ant 0	Ant 1	Ant 2	Ant 3		
QPSK							
Bottom	20	-46.24	-46.25	-46.11	-46.11	≤ -19.02	Pass
Top	20	-42.99	-43.28	-43.36	-44.63	≤ -19.02	Pass

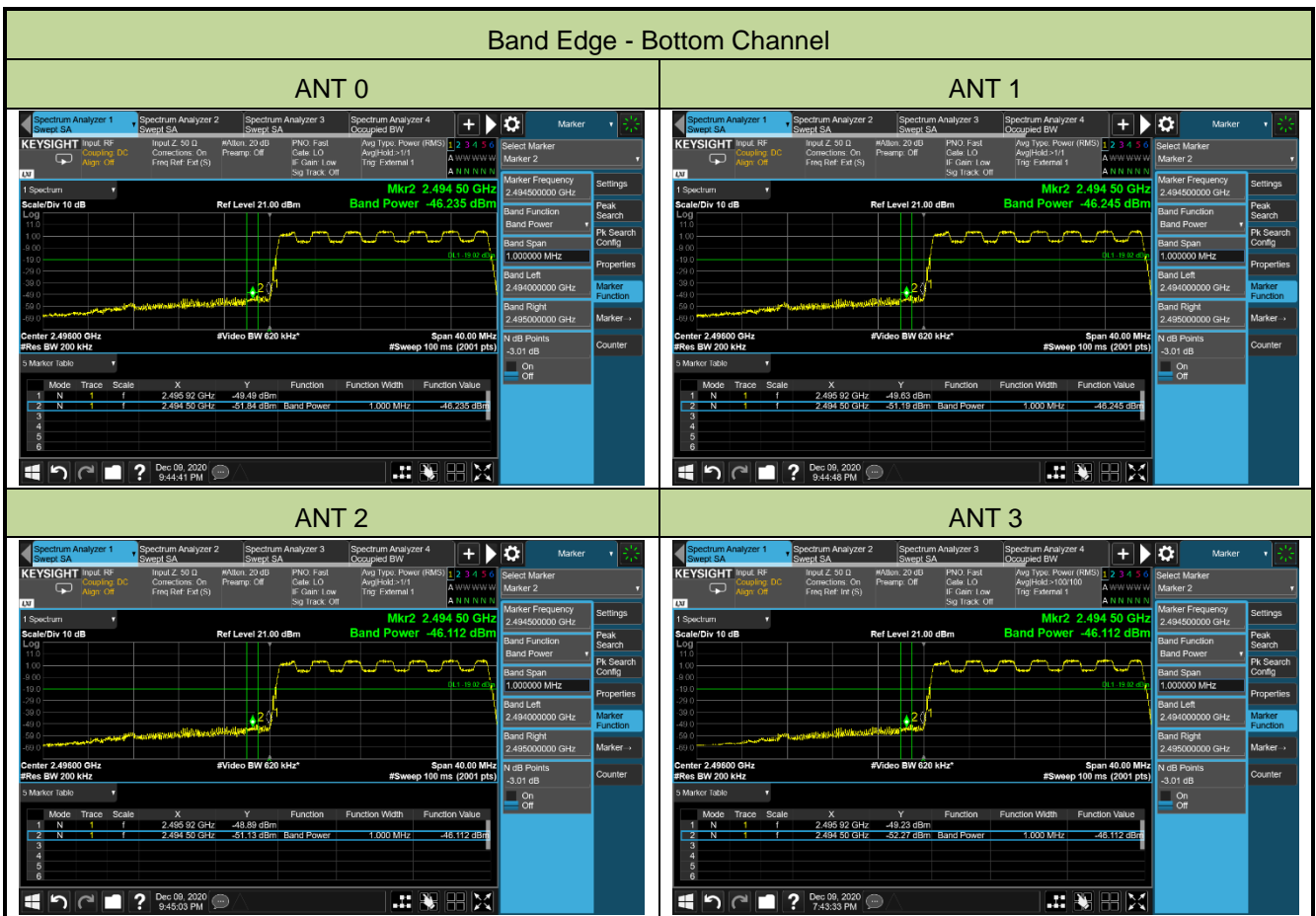

Band Edge - Top Channel

ANT 0

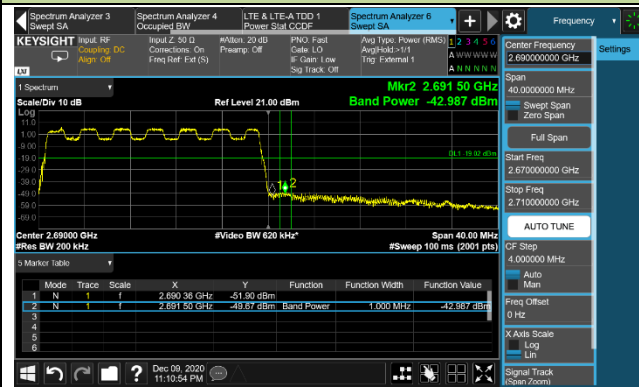

ANT 1

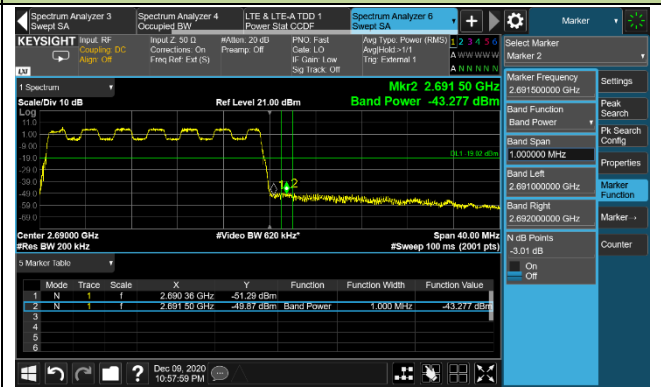

ANT 2

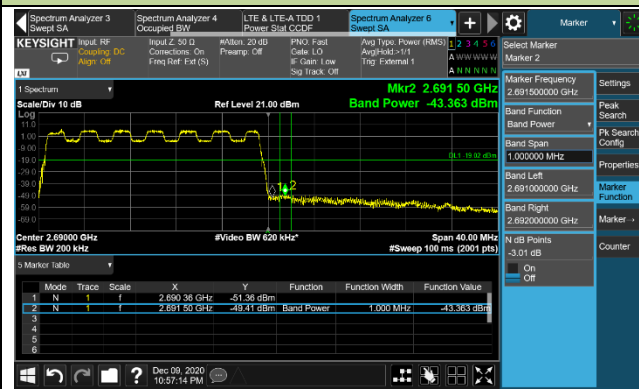

ANT 3

